

OPTICLIMATE PRO3-B

User Manual

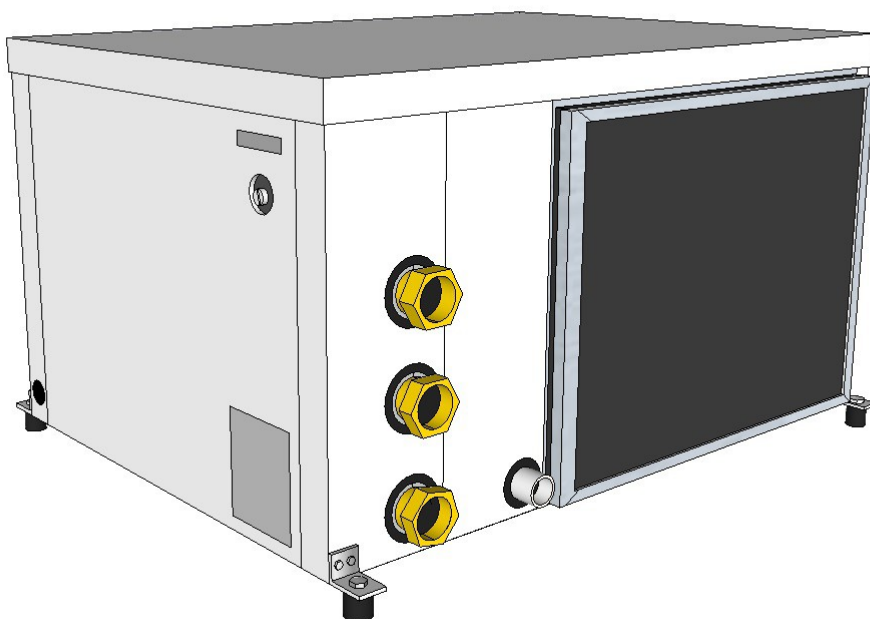

Please read the following information carefully before using the unit:

- High temperature safeguard on page 9
- Delete alarm history on page 15

Contents

- Technical specifications page 3
- Installation page 4
- Electrical connections page 6
- Water-side connections page 10
- Operation page 13
- Setting the cooling capacity page 18
- Settings page 19
- Inspection/ maintenance page 23
- Fault analysis and error messages page 24
- Fault code list page 24
- Optionally available page 26
- Appendix: Fault code overview page 27

Technical specifications

OPTICLIMATE 3500 PRO3

Voltage	Fase	Opgenomen	Koel	Aantal lampen		Water verbruik*	Verwarming	Afmeting (mm)	Gewicht
		vermogen	vermogen	600W	400W				
230V	1 of 3	740 W	3,5 kW	6	9	1-2 L/min	2x1500W	870x580x405	57 kg

OPTICLIMATE 6000 PRO3

Voltage	Fase	Opgenomen	Koel	Aantal lampen		Water verbruik*	Verwarming	Afmeting	Gewicht
		vermogen	vermogen	600W	400W				
230V	1 of 3	1450 W	6 kW	10	15	2-4 L/min	3x1500W	990x630x505	73 kg

OPTICLIMATE 10000 PRO3

Voltage	Fase	Opgenomen	Koel	Aantal lampen		Water verbruik*	Verwarming	Afmeting	Gewicht
		vermogen	vermogen	600W	400W				
230V	1 of 3	2150 W	10 kW	16	24	3-6 L/min	3x2000W	1050x660x505	92 kg

OPTICLIMATE 15000 PRO3

Voltage	Fase	Opgenomen	Koel	Aantal lampen		Water verbruik*	Verwarming	Afmeting	Gewicht
		vermogen	vermogen	600W	400W				
400V	3	3100 W	15 kW	24	35	5-9 L/min	3x2500W	1230x810x545	123 kg

OPTICLIMATE 15000 PRO3 S

Voltage	Fase	Opgenomen	Koel	Aantal lampen		Water verbruik*	Verwarming	Afmeting	Gewicht
		vermogen	vermogen	600W	400W				
230V	1 of 3	3100 W	15 kW	24	35	5-9 L/min	3x2500W	1230x810x545	123 kg

De OptiClimate 15000 pro3 S is een 1 fase machine

*Waterverbruik alleen tijdens het koelen. Verbruik is afhankelijk van de tapwatertemperatuur en is gebaseerd op Nederlands klimaat.

Installation

Fan installation (front / side)

If the unit is placed in a narrow room or in the ridge of a gable roof, the fan blow-out side can be installed at the short side of the unit.

This can be done simply by reversing the purple panels so that the fan panel is moved around to the short side of the unit. Loosening the red corner bracket will eliminate the need for using separate cable connections.

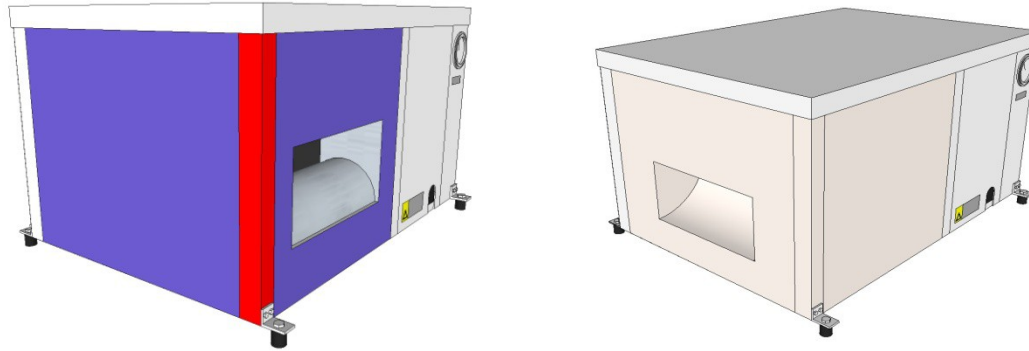

Installation

To guarantee proper air suction, leave at least 15cm of space between the wall and the backside of the unit, where the carbon & dust filters and air inlet are located. At least 15cm of space should also be left between the topside of the unit and the ceiling. Larger spaces are preferred. The unit must stand free from the wall to avoid contact noises.

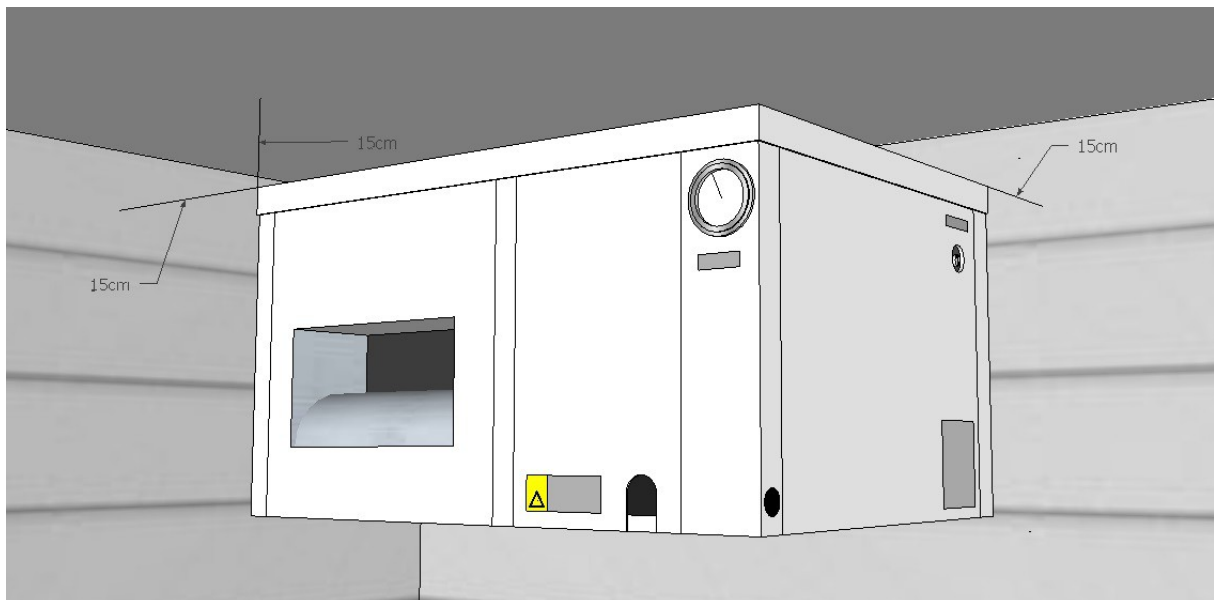

The unit should be mounted in such a way that the side of the condensation drain is at least 1 cm lower than the other side (fall) to ensure that the condensate flows properly. In practice, the 1 cm elevations at all corners – except the corner of the electrical compartment – are exactly right for a correct fall. Using a spirit level is recommended.

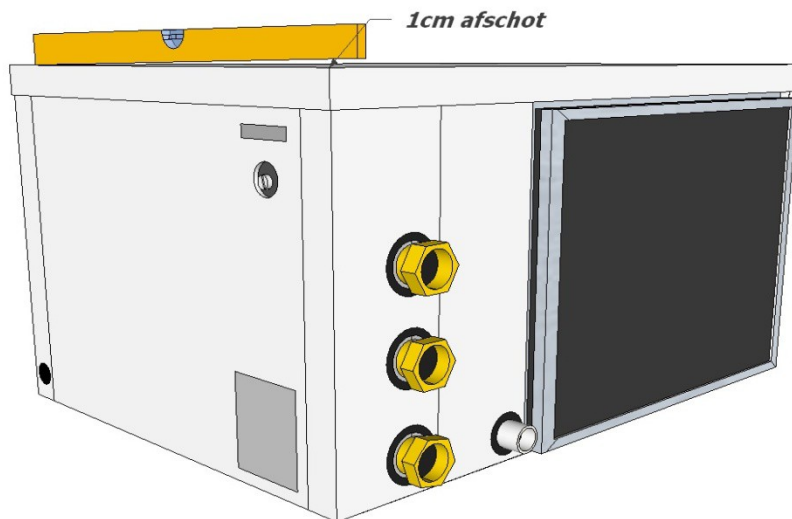

To avoid contact noises, the OptiClimate comes standard with rubber shock absorbers that are suitable for suspended installation. If the OptiClimate is going to be placed on a solid base, the rubber shock absorbers supplied with the connection set need to be used.

Special insulating springs can be supplied for areas that have to be extra quiet. Placing the insulating springs on the supports will ensure that the unit has automatic fall to the condensation drain.

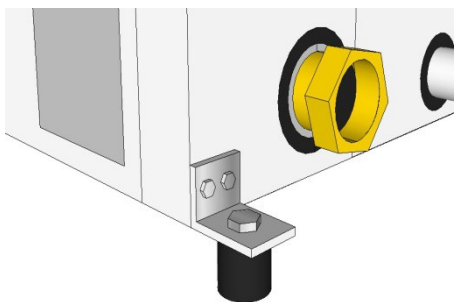

Installation of rubber shock absorbers

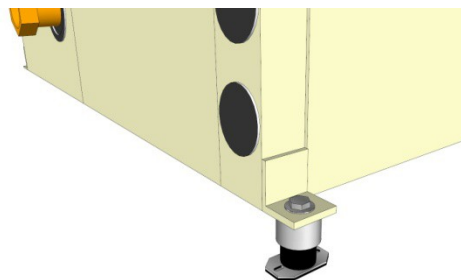

Installation of insulating springs

Electrical connections

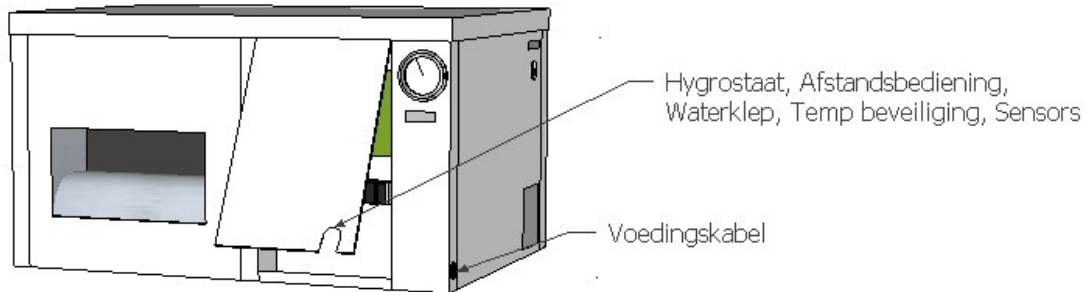

First, the panel at the left side near the manometer should be removed to make the various electrical connections.

A magnetic valve, water leakage sensor, automatic moisture meter, remote control and room temperature sensor are supplied with the unit. Their cables can be led to the outside through the opening at the bottom of the panel. The power supply can be led through the black feed-through rubber at the side of the unit.

Electrical water valve

The plug of the water valve should be connected using the black cable supplied with the unit, as shown in the illustration below.

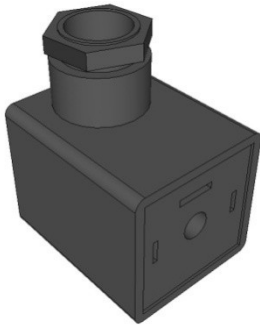

The other end of the cable should then be connected to the appropriate terminals - terminal N and terminal 7 - on the terminal strip (see page 8). The third connection of the water valve can be used as earthing.

Water leakage sensor

The connection set contains a loose, 5m long white wire: the water leakage sensor. This sensor is connected to the eighth terminal on the printed circuit-board. The sensor cable should be led to the outside through the opening in the panel and should be placed on the ground at the lowest point. The end of the sensor cable can be split into several cores using a connector, so that more than one point is secured against leakage.

If the sensor has a black cap, this should be cut off and the cores should be stripped

5 mm. Connect the other side to the little white plug on the printed circuit-board as shown in the illustration. In case of water leakage, the water supply will be stopped immediately by means of the electrical valve in the water pipe.



Alarm port

The printed circuit-board has an alarm port that is activated (makes contact) when a malfunction (error) occurs. This contact can be connected to an SMS (GSM) detector or alarm system and it can be set to NO (contact open) or NC (contact closed) by means of the Settings menu. This means that the contact will be opened or closed in case of detection. See the manual of the GSM detector or alarm for this.

Automatic moisture meter with light cell

The automatic moisture meter with built-in light cell supplied with the unit is already connected. The cable should be led through the opening in the panel. The automatic moisture meter should be hung in the room and may NOT be covered. The light cell in the automatic moisture meter automatically switches the OptiClimate from day to night mode.

Room temperature sensor

The compartment also has a room temperature sensor, which is already connected to the printed circuit-board. This sensor should be led to the outside through the opening in the panel and should be hung at the level of the upper side of the vegetation. The sensor should be protected against heat radiation but may not be put in the shade. A protective cover over the sensor is sufficient.

The remote control

The remote control contained in the compartment can be hung in the room but can also be hung elsewhere. This way the OptiClimate can also be controlled from outside the room. The four-core cable is already connected and should be led to the outside through the opening in the panel.



Power cables

Five different OptiClimate models are available. For your safety and the safety of the OptiClimate, the following specifications should be observed when connecting the power supply: use the fuse automats and cable thicknesses specified.

Model	Fuse automat	Cable thicknesses
3500pro3	1 phase D16 automat	2.5mm ² cable
3500pro3	3 phase D10 automat	2.5mm ² cable
6000pro3	1 phase D25 automat	4.0mm ² cable
6000pro3	3 phase D16 automat	2.5mm ² cable
10000pro3	1 phase D35 automat	4.0mm ² cable
10000pro3	3 phase D20 automat	2.5mm ² cable
15000pro3(S)	1 phase D50 automat	6.0mm ² cable
15000pro3(S)	3 phase D35 automat	4.0mm ² cable
15000pro3	3 phase D25 automat	4.0mm ² cable *

* The compressor of this unit is divided over 3 phases

The cables for the supply voltage should be led through the feed-through rubber at the side and connected to the left-hand side of the terminal strip as described in the illustration. The earthing can be connected to the PE terminal or to the screw on the metal housing at the bottom right of the terminal strip.

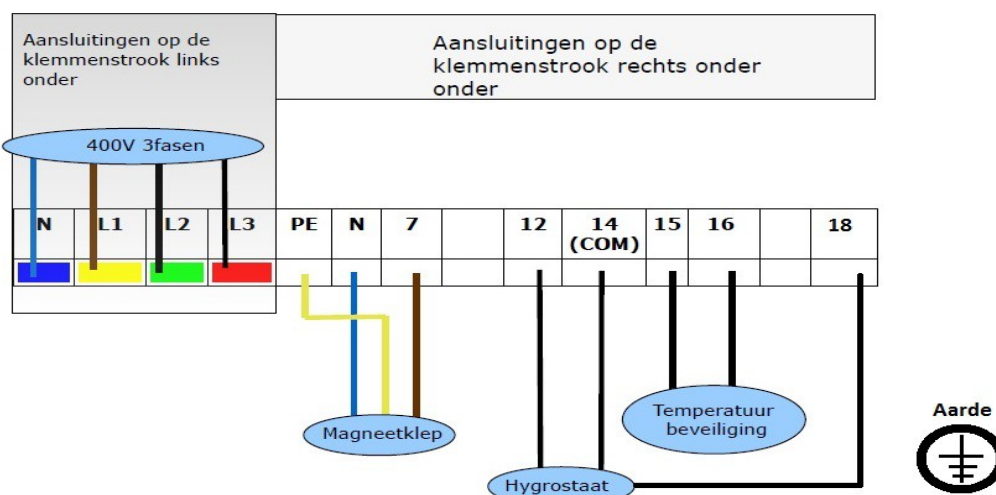
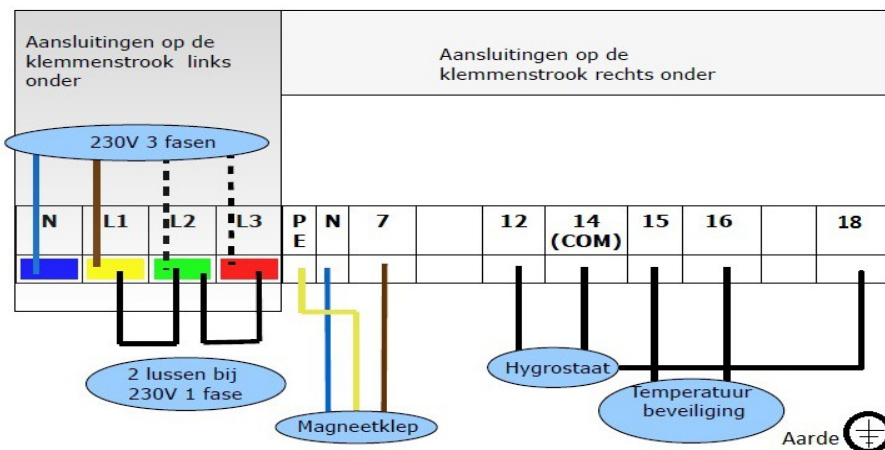

High temperature safeguard

Using this safeguard, the OptiClimate can switch off the heat sources (e.g. lamps) when the temperature in a room becomes too high. The unit has a terminal that can be connected to the timer of a control panel, for example.

The feed wire running to the switch in the timer should be interrupted for this purpose. Terminal 1, for example, is for a Grasslin clock and terminal 4 for a LeGrand timer.



The two ends should be connected to terminals 15 & 16 on the terminal strip in the electrical compartment of the OptiClimate.

The OptiClimate supplies the power for the timer. If the room temperature exceeds 35°C, the OptiClimate will interrupt the circuit, switching off the heat sources. **ERROR 15** is then displayed on the remote control.

Always refer to the timer manufacturer's manual if a model other than the one shown is used.

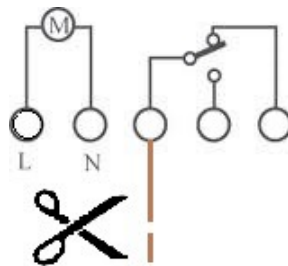

Water-side connections

Supply and drain connections of the cooling water

The unit has a water inlet and outlet. The inlet should be installed at a draw-off point with a magnetic valve installed between the draw-off point and the inlet (always check the flow direction arrow on the valve!). The magnetic valve should be installed as close as possible to the draw-off point, as this is the water seal. When a leak occurs, the magnetic valve closes automatically. Make sure that the black magnetic coil of the water valve is directed upwards (preferred) or to the side. If it is directed downwards, condensate from the valve might enter the coil. Make sure that the magnetic valve is installed at a fixed point that is always easily accessible to the user.

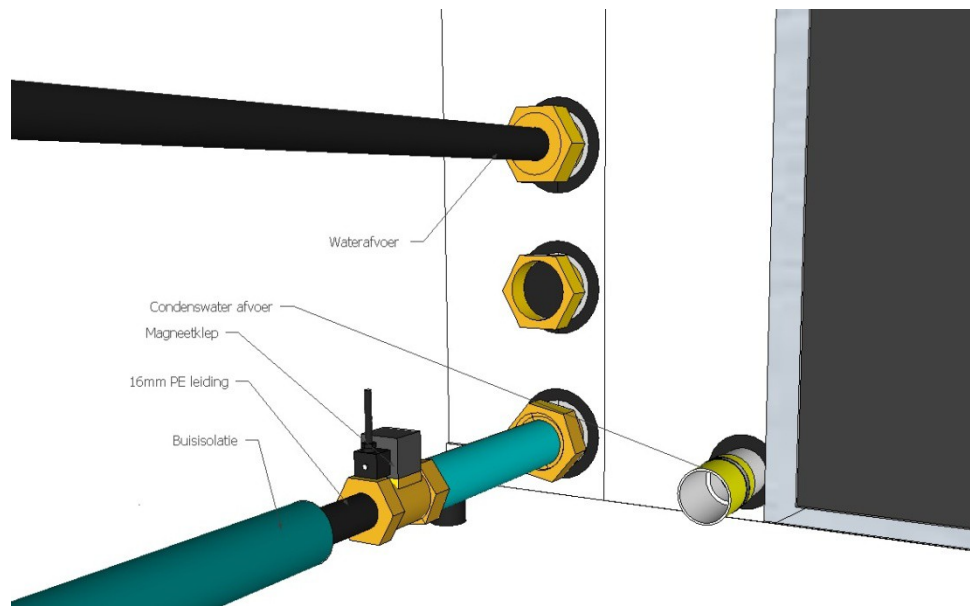

Magnetic valve in the supply pipe of the water

A filter should be placed in the water inlet. This filter prevents blockage in the unit. Disassembly of the filter often releases dirt into the unit. As such, it may only be removed after contacting the Technical Service department.

It is recommended to insulate the water supply line in order to prevent condensation build-up. The upper water connection is the water outlet. The water outlet can be connected directly to the drain (sewer). Alternatively, the warm water can be used for heating purposes.

Note: Only use solid copper or LDPE pipes and affix these properly to the wall using clamps. Always avoid putting the LDPE under tension. Make sure that the magnetic valve is affixed properly to the wall or another fixed point. Never use a garden hose!

When all the LDPE connections are checked for leaks and the unit operates properly, all flare fittings should be glued. You do this by unscrewing the coupling, applying some glue to the thread and re-tightening the blue flare nut. If done properly, the flare fittings will never come loose as a result of vibration. If it is necessary to loosen the flare fittings, then two water pump pliers will do the trick.

Copper pipes of 15 mm or LDPE pipes of 16 mm are sufficient for all units. If several units have to cool at more than 15 kW, the main pipe should be 20 mm copper or 20 or

25 mm LDPE. If the supply pipe has high pressure, a copper pipe of 15 mm will cool up to 30 kW.

All types of cooling water (tap, well, pond or swimming pool water) can be used for cooling. However, tap water is preferred because you won't need to rely on additional electric pumps. Well water contains clay and iron particles that accumulate on the inner wall of the heat exchanger. The result is that sooner or later the unit will cool less effectively or not at all. If you use well water, you can install a filter, but such a solution requires maintenance. A normal 22mm tap water connection has sufficient capacity to continuously cool three or four 15000pro2 units at 45-60 kW.

We also have suitable solutions for larger installations when there are problems with the water supply and discharge. In such cases, please contact the Technical Service department.

Discharge of the condensation water

The unit will also dehumidify the air during cooling. The moisture extracted from the air comes into the condensation drain. The condensation drain is connected to a sturdy garden hose or a pipeline that does not bend easily. The condensation water drips from the hose, which can be connected to the drain pipe. The condensate can also be used as feed water. The cooling block has been adjusted to prevent metals or oxides from entering the condensate. This is ideal when the only feed water available is hard water.

The drain pipe of the condensation water may not have loops and may not be put under the water level in a drum.

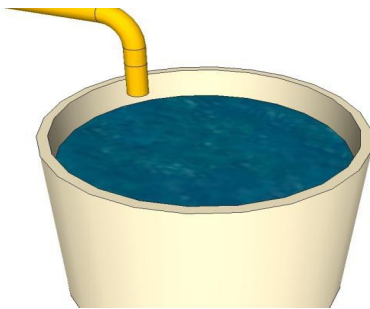

If the unit is installed at the same level or lower than the drain or sewer, a condensation lift pump can collect the water. This small lift pump pumps the water through a hose of 9mm to a height of 4 metres into the drain. Stronger pumps are also available.

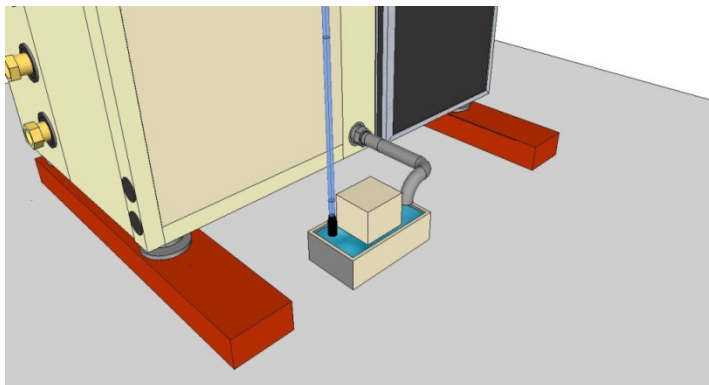

Drain pump of the condensation water

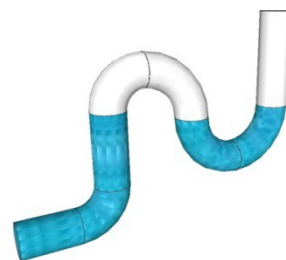

Incorrect drain installation

The drain to the pump must not be under the water level and the pipe may **not** have loops as shown above.

The unit is now installed and ready to use

Putting into operation

Operation

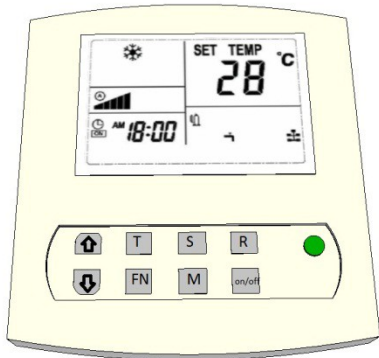

- ↑ = Temp up / scroll
 - ↓ = Temp down / scroll
 - T** = Press and release to set the time / press and hold to set the timer
 - FN** = Fan speed
 - S** = Press and release to read Sensors / press and hold to bring up the Menu
 - R** = Press and release to confirm / press and hold to delete error codes
 - M** = Press and release to switch between day and night mode. Press and hold to turn automatic light cell mode on/off.
- On/Off = Turn unit on/off or confirm menu option.

1) On/Off key

The unit is switched ON or OFF using the On/Off key. The LED will be green when the unit is On. The LED will be red when the unit is Off. In case of malfunctioning, the LED will flash red and green. The On/Off key is also used to confirm a menu selection.

2) Mode key [M]

Pressing the mode key will switch the mode from **day** mode (cooling) to **night** mode (heating / dehumidifying) and v.v. The display will show a lit snowflake in day mode and a sun with drops of water in night mode.



Night mode

Temperatures for the day and night can be set using the mode function. These can be changed later, if required.

3) Fan speed key [Fn]

This key is used for selecting the air speed of the fan. The sequence is as follows:

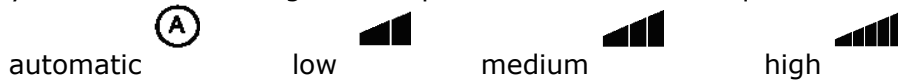

The speed changes whenever the Fn key is pressed.

If you select the automatic fan mode in the **Cool** mode, the unit will ventilate more or less depending on the need for cooling.

4) Temperature setting

The temperature can be set from 16°C to 34°C. Pressing the ▲ or ▼ key will show the set temperature **SET TEMP** on the display. By pressing it once more, you can set the required temperature. The set temperature will be saved and stored after 3 seconds. Switching between day and night temperatures is done using the **[M]** mode key.

5) Time Setting [T] key

Press the **[T]** key once to select the hours and then press the ▲ or ▼ key to change the hours. Press the **[T]** key again, and the minutes will flash and then press the ▲ or ▼ key to change the minutes. Now press the **[R]** key to confirm the hours and minutes that you entered.

6) Automatic Light Cell setting (Day /Night programme)

The automatic moisture meter in the pro3 series has a light cell, which switches to the day mode when it sees the light is on and to the night mode when the light is off. Only the Day/Night temperatures have to be set, the rest is done automatically.

If you want to set the unit manually, the automatic light cell can be switched off and the unit will operate manually. By pressing the **[M]** key for 3 seconds, the mode switches from light cell to manual. By pressing the **[M]** key again for 3 seconds, the mode switches from manual to light cell. If the automatic light cell is activated, the display shows an **A**.

It is important to note that when the Timer setting is programmed the automatic light cell mode is deactivated. Therefore, install a Timer only if you want to use advanced

options. The Timer mode is active when a clock icon appears in the display

The external automatic moisture meter for the light cell should be connected to the terminal strip in the electrical compartment (terminals 12, 14 and 18). Otherwise the unit will remain in the night mode because light is not detected. This is connected by default.

7) Timer Setting (DAY/NIGHT programme)

As a general rule, we recommend using the automatic light cell mode. Only set the timer if you do not want to work with the light cell!

This function can be used to set the DAY/NIGHT programme. The programme restarts every day regardless of which day it is. If the timer is set, the display will show the clock



icon next to the time.

Press the **[T]** key for 2 seconds. When "---", ON becomes visible, you can change the timer setting. Pressing the ▲ or ▼ key will allow you to set the hours of the ON time.

Pressing the **[T]** key again will allow you to set the minutes of the ON time. The ON time is the time that the unit will start to cool.

Pressing the **[T]** key again will allow you to set the OFF time. The OFF time is the time that the unit will start to heat/dehumidify.

If the timer is not set yet, the display will show "--:--" or the time that was already set.

Example:

The unit must cool between 8:00 AM and 8:00 PM.

The ON time should then be set to 8:00 AM and the OFF time to 8:00 PM

AM = after midnight (from 0:00 to 12:00 hours)

PM = after noon (from 12:00 to 24:00 hours)

1:00 AM equals 01:00	1:00 PM equals 13:00
2:00 AM equals 02:00	2:00 PM equals 14:00
3:00 AM equals 03:00	3:00 PM equals 15:00
4:00 AM equals 04:00	4:00 PM equals 16:00
5:00 AM equals 05:00	5:00 PM equals 17:00
6:00 AM equals 06:00	6:00 PM equals 18:00
7:00 AM equals 07:00	7:00 PM equals 19:00
8:00 AM equals 08:00	8:00 PM equals 20:00
9:00 AM equals 09:00	9:00 PM equals 21:00
10:00 AM equals 10:00	10:00 PM equals 22:00
11:00 AM equals 11:00	11:00 PM equals 23:00
12:00 PM equals 12:00	12:00 AM equals 00:00

Deleting the time when setting the timer (switching off the timer)

Press the **[R]** key, and the time is deleted. The display will show "--:--".

CLOSING: Press the **[T]** key three times to close immediately or wait 10 seconds to close automatically.

The settings of the current time and the timer settings should run synchronous with the times of the control panel. All clocks must run synchronously when the timer function is used.



8) Using the automatic moisture meter for dehumidifying during the night

The automatic moisture meter can be set to the required maximum air humidity during the night. If the Night mode is active and the automatic moisture meter indicates that

the unit should dehumidify, the Drop icon starts to flash. Water will also be consumed during dehumidifying.



The automatic moisture meter

9) Reading function for the temperature sensors

Press the **[S]** key and the sensor will show the temperatures. The number and temperature of the sensors will show in the spot of the clock.

Pressing the **▲** and **▼** keys will allow users to select the reading of the various sensors.

CLOSING: Press the **[S]** key to close immediately or wait 60 seconds to close automatically.

C:01 = Temperature cooling block

C:02 = Temperature drain water

C:03 = Temperature room 2 (only in case of a dual room configuration, now -40 degrees)

C:04 = Blow-out air temperature

C:05 = Intake air temperature

C:06 = Temperature of low-pressure cooling medium for compressor

C:07 = Water leakage sensor

10) Reading function for the error codes

The unit malfunctions if the ON/OFF LED flashes red and green. E:XX will show the actual error code. If the problem is solved automatically, the error code will disappear.

The error log (alarm history) is located at the bottom in the display of the remote control.

If an error occurs, the error will be continuously visible at the bottom of the display, even if the error has been solved. This way a malfunction or incorrect setting that is about to come up can be noticed and/or resolved at an early stage.

Deleting the error log (alarm history)

When resolved, errors in the log can be deleted by pressing and holding the **(R)** key.

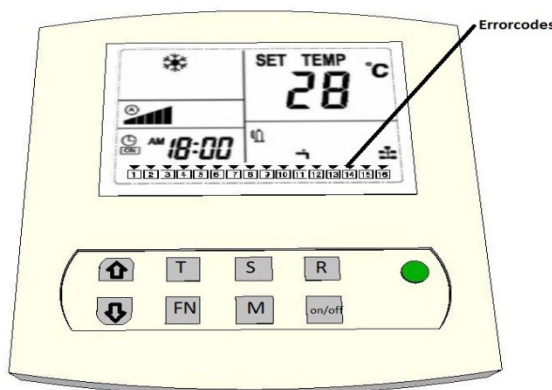

Keep the alarm history clear so that problems can be easily resolved / resolved at an early stage!

11) Water Leakage safeguard

If there is water on the ground - due for example to an incorrectly mounted coupling or a blocked sewer - and the water makes contact with the water leakage sensor (the flat white wire with two blank cores at the end), the unit will stop cooling and the magnetic valve will close immediately. The unit will only start operating normally after the leak is repaired and the fault is reset by pressing the **[On/Off]** key.

12) Alarm port

The printed circuit-board has an alarm port, which makes contact when an alarm or error occurs. This contact can be connected to an alarm system or SMS (GSM) detector.

13) Compressor Active mode

If the compressor operates, the display will show the Compressor icon at the bottom right-hand side. It will disappear when the compressor is turned off.



The compressor only operates during the DAY period, if the set temperature is exceeded, and during the NIGHT period, if the set air humidity is exceeded.

14) Heating Elements Active mode

If the heating elements are turned on, the display will show the Hot Air icon at the bottom right-hand side. It will disappear when the heating elements are turned off.



The heating elements only operate during the NIGHT period, if the temperature reaches a value below the set value.

Setting the cooling capacity

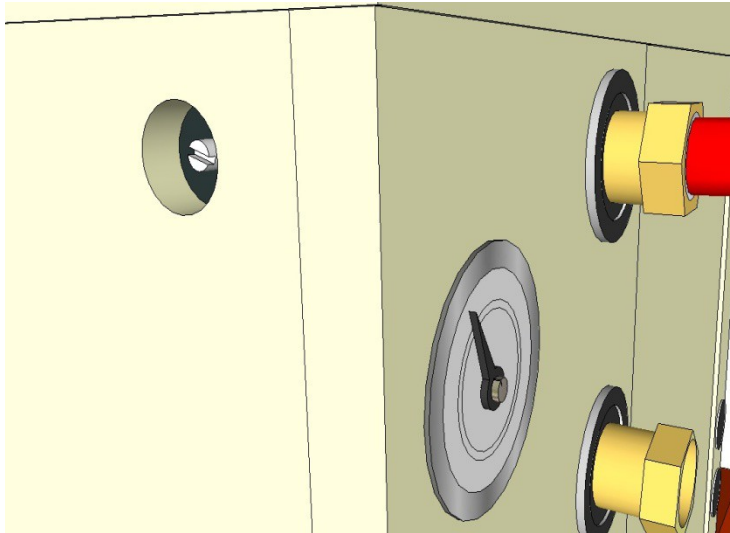

Capacity control

The capacity is factory set at 1.6 MPa

1.5-1.7MPa is an average setting. Your specific application might require higher or lower cooling capacity. The maximum cooling capacity is at 1.3MPa and the minimum cooling capacity is at 2.0MPa. The unit will consume more water at a higher cooling capacity than at a lower cooling capacity.

To adjust the cooling capacity, turn the set screw of the capacity control. This set screw is located at the side of the unit under the Cooling Capacity Control sticker. By turning the set screw to the left, the pressure will increase and the cooling capacity will decrease, and by turning the set screw to the right, the pressure will decrease and the cooling capacity will rise. It is recommended to do this if there are sources of heat in the room, so that the unit will not turn off constantly because the temperature in the room drops below 16°C (the pressure on the manometer is not the water pressure, but the pressure of the cooling medium).

Settings (Setup)

This menu allows you to change certain settings and to set the heating, temperature safeguard, auto restart and hysteresis.

Pressing the **【S】** key for more than 6 seconds will open the Settings menu. The display will show a capital **D:** followed by a number from 01 to 29. Briefly pressing the **【S】** key allows you to scroll through the settings. The first setting is **D:01**, the second setting is **D:02**, etc.

Use the **▲** or **▼** key to change a setting. Press the **【On/Off】** key to confirm the setting. If you do not want to change anything and exit the menu, press the **【R】** key. The settings are from **D:01** to **D:29**. Do not adjust settings D:16 to D:22. These are factory settings.

To restore the factory settings, press and hold the **【M】** key until the Settings menu opens. All settings will now be restored to factory settings. Confirm this with the on/off key.

D:01 Switching the heating elements on/off

The OptiClimate has three heating elements. The heating elements of 1-phase systems are connected to 1 phase and the heating elements of 3-phase systems are divided over 3 phases.

Each of these elements can be switched on and off individually in the **Settings** menu. If a central heating system is used for heating, for example, all of these heating elements can also be switched off at the same time.

Setting:

D:1 = 3 means all three elements will heat.

D:1 = 2 means two elements will heat.

D:1 = 1 means one element will heat.

D:1 = 0 means all elements are off.

D:02 Temperature safeguard

If the room temperature exceeds 35°C, terminals 15 and 16 on the terminal strip of the unit will switch the heating elements off. The switch-off temperature can be changed using the **D:02** setting. The minimum temperature for switching off is 30°C and the maximum temperature is 40°C. If the temperature drops below the set temperature for cooling mode again, the safeguard will switch off.

The safeguard does not impact the operation of the OptiClimate, however, the display will show the error message **E:15** (see also the fault code list).

D:03 Auto Restart after power interruption

If the power is interrupted when the unit is on and the power is restored, the unit will switch on by default.

If you want the unit to remain off after a power interruption caused by an external fault, you should change the **D:03** setting. Setting:

D:03 = 0 means Auto Restart is off.

D:03 = 1 means Auto Restart is on. This is the default setting. The display will show error code 14 in case of power interruption. See also the fault code list.

D:04 Cool at Night (night cooling) on/off

Using this setting, the night cooling can be switched on.

D:04 = 0 means Cool at Night is off. This is the default setting.

D:04 = 1 means Cool at Night is on.

If in the timer off mode the minimum temperature is, for example, set to 22°C, the unit will cool the room to 22°C in the night mode. If the room temperature drops below 22°C, the unit will begin to heat the room. This function is useful in warm climates, in a very well-insulated room or with other sources of heat that cannot be switched off. When the Cool at Night function is active a moon icon will be shown on the display.

D:05 Pre-Heating on/off.

Pre-heating can be switched on using this setting.

D:05 = 0 means Pre-Heating is off. This is the default setting.

D:05 = 1 means Pre-Heating is on.

If Pre-Heating is switched on, the unit will heat the room up to the set cooling mode (day) temperature one hour before daybreak (timer is on). At the beginning of the day, the room will be at the right temperature. Besides the advantage of giving the day temperature a jump-start, this also prevents the cold parts of the unit from becoming wet, which reduces or prevents mould build-up.

Note: Only works in conjunction with the timer and not in the light cell mode!

D:06 Slow cool-down (post-heating) on/off.

Slow cool-down (post-heating) can be switched on using this setting.

D:06 = 0 means Slow Cool-Down is off. This is the default setting.

D:06 = 1 means Slow Cool-Down is on.

If Slow Cool-Down is switched on, the unit will slowly cool the room until one hour after the end of the day.

Note: Only works in conjunction with the timer and not in the light cell mode!

D:07 Dual Room (cooling two rooms 12h by 12h) on/off.

Using this setting, you can switch on/off the cooling of two rooms alternately.

D:07 = 0 means Dual Room operation is off. This is the default setting.

D:07 = 1 means Dual Room operation is on. If the Dual Room function is active, the display will show the house icon at the bottom right-hand side.

To use this function, you will have to order a three-way valve and a connection set consisting of a three-way valve, plenum box, second temperature sensor, external water seal and an extensive installation/user manual.

D:08 Alarm port N.O. (Normally Open) or N.C. (Normally Closed)

Using this setting, the alarm port can be adjusted.

D:08 = 0 means N.C. Normally closed. This is the default setting.

D:08 = 1 means N.O. Normally open.

Refer to the user manual for the correct settings of the SMS (GSM) detector or the alarm system that should be connected.

D:09 Water Valve options

You can opt to open the water valve only if there is a demand for water or only use the water valve if the water leakage sensor detects a leak. Setting D:09 to 0 will only open the valve during cooling. Setting D:09 to 1 will only open the valve when a leak occurs.

D:10 Timer port

If D:10 is set to 0, ports 15 and 16 will interrupt the High Temperature alarm. If D:10 is set to 1, the high temp alarm will not occur through these contacts. If D:10 is set to 1, port 16 is common and ports 16 & 17 will be each other's alternate contacts. The clock of the OptiClimate (OC) will operate these make-and-break contacts and the clock/timer of the OC can replace the clock on the control panel. The lamps will operate synchronous with the cooling mode of the OC. To install a High Temperature safeguard, contact 16 should be aligned with the alarm port on the printed circuit-board. If there is a High Temperature alarm, this alarm will interrupt the timer's signal and the temperature safeguard will still operate. The setting of the alarm port should then be the standard setting (0 = N.C.).

D:11 Hysteresis of the temperature

Using this setting, you can adjust the hysteresis (bandwidth) of the temperature control. This is the temperature difference required to switch the compressor on and off. Setting: **D:11** = 2 means the hysteresis is 2. This is the default setting.

The hysteresis can be set from 1°C to 4°C in 0.5°C increments. If, for example, the day temperature is set to 28°C and the hysteresis to 2°C, the unit will start to cool at 29°C and stop cooling at 27°C. To shorten the hysteresis effectively, the resting time of the compressor should also be decreased. (D:27)

D:12 Minimum adjustable heating temperature (factory setting)

Using this setting, you can change the minimum adjustable heating temperature. The adjustable values in **D:12** are: default = 16°C, max. = 20°C, min. = 10°C.

D:13 Maximum adjustable heating temperature (factory setting)

Using this setting, you can change the maximum adjustable heating temperature. The adjustable values in **D:13** are: default = 35°C, max. = 50°C, min. = 25°C.

D:14 Minimum adjustable cooling temperature (factory setting)

Using this setting, you can change the minimum adjustable cooling temperature. The adjustable values in **D:14** are: default = 16°C, max. = 20°C, min. = 10°C.

D:15 Maximum adjustable cooling temperature (factory setting)

Using this setting, you can change the maximum adjustable cooling temperature. The adjustable values in **D:15** are: default = 35°C, max. = 35°C, min. = 25°C.

D:16 Anti-freeze protection of the cooling water (factory setting)

Using this setting, you can determine at which temperature the Anti-Freeze Alarm is activated. The adjustable values in **D:16** are: default = 3°C, max. = 0°C, min. = 10°C.

D:17 Anti-freeze protection of the cooling block (factory setting)

Using this setting, you can determine at which temperature the Anti-Freeze alarm of the cooling block is activated. The settings in **D:17** are: default = 0°C, max. = 5°C, min. = -2°C.

D:18 Cooling water temperature too high (factory setting)

Using this setting, you can determine at which temperature the Cooling water temperature too high alarm is activated. The settings in **D:18** are: default = 57°C, max. = 60°C, min. = 40°C.

D:19 Cooling water temperature too low (factory setting)

Using this setting, you can determine at which temperature the Cooling water temperature too low alarm is activated. The settings in **D:19** are: default = 4°C, max. = 0°C, min. = 10°C and 1°C.

D:20 Not applicable

D:21 Cooling block too hot (factory setting)

Using this setting, you can determine at which temperature the Cooling block too hot alarm is activated. The settings in **D:21** are: default = 24°C, max. = 30°C, min. = 15°C. To activate the alarm, the temperature has to be too high for a certain period of time. The time is determined by D:22. D:21 and D:22 jointly determine when Error 11 is activated.

D:22 Duration of cooling block too hot (factory setting)

Using this setting, you can determine how long it takes before a Cooling block too hot alarm is given. The settings in **D:22** are: default = 30min, max. = 40min, min. = 20min. The temperature level is determined by D: 21. D:21 and D:22 jointly determine when E:11 is activated.

D:23 Temperature compensation of the room temperature sensor (factory setting)

Using this setting, you can calibrate the room temperature sensor. The setting can be changed if the indication on the display does not correspond with reality. The settings in **D:23** are: default = 0°C, max. = 5°C, min. = -5°C and can be set in 0.5°C increments.

D:24 Temperature compensation of the cooling block temperature sensor (factory setting)

Using this setting, you can calibrate the cooling block temperature sensor. The settings in **D:24** are: default = 0°C, max. = 5°C, min. = -5°C and can be set in 0.5°C increments.

D:25 Temperature compensation of the cooling water temperature sensor (factory setting)

Using this setting, you can calibrate the cooling water temperature sensor. The settings in **D:25** are: default = 0°C, max. = 5°C, min. = -5°C and can be set in 0.5°C increments.

D:26 Temperature compensation of the Dual Room temperature sensor (factory setting)

Using this setting, you can calibrate the second room temperature sensor in the Dual Room configuration. The settings in **D:26** are: default = 0°C, max. = 5°C, min. = -5°C and can be set in 0.5°C increments.

D:27 Resting time of the compressor

Using this setting, you can adjust the resting time between Compressor Off and Compressor On.

Setting: **D:27** = 15 means the resting time is 15 seconds. This is the default setting. This setting may be used if the temperature values in the room increase too much because of the time that the compressor is in resting mode.

D:28 Water Leakage Alarm on/off

Using this setting, the water leakage alarm can be switched on or off. If **D:28** is set to 1, the alarm is on. If **D:28** is set to 0, the alarm is off.

D:29 Display lighting

Using this option, you can switch the lighting in the display of the remote control on and off.

0 = Automatic (default)

1 = Always on

D:31 Beep on/off

The tone that is generated when the remote control is used can be turned on and off.

0 = off

1 = on

D:32 Fahrenheit/Celsius

The temperature shown on the display can be displayed in Fahrenheit and Celsius

0 = Celsius

1 = Fahrenheit

Inspection/Maintenance

Frequently check whether all couplings of the water connections are properly tightened. Also check that there are no leaks.

Frequently check whether there is no thickening of the black coil (black block on the brass valve) of the brass magnetic valve (water seal). In case of poor contact (moist contact), the coil can become too hot and expand. If this is not fixed, the coil can burn out and the magnetic valve will no longer open.

The dust filter at the backside of the unit should be checked every 10-12 weeks for dust accumulation. If the filter has a layer of dust, the dust should be removed using a vacuum cleaner.

The carbon filter should be replaced every 10-12 weeks in order to guarantee proper operation of the unit. This is essential and should not be forgotten! If this is not carried out, the filter will break down sooner than normal. To replace the carbon filter, you first have to remove the dust filter.

If you want to work with a humidifier, make sure that it is connected to a reverse osmosis filter or scale filter. **Fan faults caused by limescale are not covered under the warranty.**

If the dust filter is still clogged with white particles when using a humidifier in conjunction with a scale filter, then an osmosis filter is required. The water is too hard to use with a scale filter. There is no need to use a humidifier if the space is not too large.

Fault analysis and error messages

If the unit does not switch on (and the remote control display and the LEDs on the printed circuit-board are off), most likely there is no power supply. It is also possible that the internal fuse has blown. This fuse is located near the printed circuit-board in a synthetic housing.

If there is power supply (the LED on the printed circuit-board flashes and the remote control display shows E:01), but the unit does not switch on, two of the three phases - it does not matter which - should probably be switched.

If the fuse automat bursts when the unit starts to cool, most likely a fuse of an incorrect value or incorrect type was installed. Check the technical specifications (page 8) for the correct details.

If the unit makes strange noises or is cooling poorly, check the manometer to ensure that the pointer is not pointing too far to the right/centre of the screen and check that the water temperature does not exceed 55°C. If that is the case, make sure that the unit receives more water and check whether the pointer of the manometer drops. Subsequently, set the manometer as described in the **Settings section on page 18**.

If water continues to flow through the unit while the unit is off, it might be possible that the magnetic valve is mounted incorrectly. Check the arrow on the brass housing. If water drips from the sides of the unit, you have a problem with the condensation water drainage. Check whether the unit has sufficient fall (see the **Installation** section) using a spirit level. It is also possible that the condensation hose has too many loops/bends or is blocked.

Fault code list

Error 01 = Usually means that the phases are crossed (reversal). **Only active in the 15000 series.**

Two of the three phases - it does not matter which - should probably be switched. If the unit has operated before, the phases are connected properly. You may have a problem with the power supply (voltage). You can check this by observing which LED is burning on the little white cupboard in the top of the electrical compartment.

Over voltage	=	Voltage is too high
Low voltage	=	Voltage is too low
Phase loss	=	Phase is interrupted
Reversal	=	Phase sequence is incorrect (crossed)
Normal	=	Phases are connected properly and the voltage is correct

Error 02 = Condensate does not drain. Check the condensation drain for blockage and make sure the unit has sufficient fall towards the condensation drain.

Error 03 = Drain water temperature is higher than 57°C.

If the error message appears when the unit is already operating for a while, then too little or no water flows through the unit. The pressure may be set too high. The maximum permitted pressure is 2.2MPa. See the **Setting the cooling capacity** section (page 18) for the correct flow.

Error 04 = Ambient temperature is too low

The unit is placed in a cold environment, causing the risk of freezing. The room in which the OptiClimate is installed should be warmer than 4°C.

Error 05 = Ambient temperature sensor is not connected or is defective

Error 06 = Cooling block temperature sensor is not connected or is defective

Error 07 = Return cooling temperature sensor is not connected or is defective

Error 08 = Water leakage safeguard is active.

There is a water leak. Repair the leak and dry the end of the sensor. In Dual Room systems, error 08 indicates a problem with the second temperature sensor.

Error 09 = Thermal safeguard of the compressor is activated. The compressor consumes too much current. Contact the Technical Service department, if the thermal safeguard jumps again after resetting. The thermal safeguard is located at the left-hand side near the printed circuit board in the electrical compartment.

Error 10 = Anti-freeze safeguard, the temperature of the cooling block is too low. If the cooling block is colder than 0°C, it can freeze up. The unit stops cooling and starts to defrost. Most likely too much water flows through the unit. This causes the unit to have too much cooling capacity. The minimum pressure is 1.3MPa. You might have to increase the pressure slightly to reduce the cooling capacity. See the Settings section to remedy this. The dust/carbon filters may also be blocked or the blow-out is too scanty/tight (too few holes or the hose is too thin). The result is that the unit cannot get rid of its cold air.

Error 11 = Poor cooling.

There is no proper cooling. There may be a leak in the cooling system and it needs to be repaired. The condenser of the compressor may also be faulty.

Error 12 = High pressure protection.

If this error message appears, most likely water does not flow through the unit. This should be resolved immediately, because the unit cannot get rid of its hot air and the pressure of the cooling system will repeatedly increase too much. It is also possible that the unit gets too little water. See the **Setting the cooling capacity** section (page 18) for the correct flow.

If water does not flow through the unit and the taps and magnetic valve are open, the heat exchanger might also be clogged due to the use of well or polluted water. Check the filter in the inlet.

Error 13 = Low pressure protection.

Check the manometer when the unit is off. Is the pressure lower than 4bar/0.4Mpa? If yes, there is a leak in the cooling system and it must be repaired.

Error 14 = Current interruption alarm.

The unit is deprived of current. This alarm, which is only visible in the alarm history at the bottom of the display, indicates that there is a problem with the current.

Error 15 = High ambient temperature safeguard is active.

As soon as the ambient temperature drops below the set day temperature, the unit will switch on the sources of heat again and the error code will disappear. The number 15 will, however, continue to be shown in the log at the bottom of the display. You can delete this by pressing and holding the **(R)** key.

Error 16 = Water leakage safeguard is active. There is a leak. The external water sensor (the 5m long wire with two blank cores at the end) makes contact with water and the

water supply is closed. Once the leak is repaired, you have to press the **【ON/OFF】** key and the unit will operate normally. Please contact your supplier in case of any other error message.

Optionally available

Vibration isolation springs

Vibration absorbers for extra quiet rooms. These absorbers are meticulously calculated to bear the unit's weight and ensure nearly 100% contact insulation.

No other solutions on the market offer a similar level of contact insulation.

Noise damping plate with adhesive layer (2 pieces)

Anti-vibration plates; absorbing plates for extra quiet rooms. These plates can be glued to the flat panels of the unit to limit noises radiated by the unit to a minimum.

Connection set for open water (ditch, canal, etc.)

Consists of a closed heat-exchanger with glycol filling (anti-freeze) and a pump.

Condensation water lift pump

Lift height up to 4 metres. This pump is often used if there is no drain for the condensation water in the vicinity or if the unit is placed lower than the drain. 6mm PVC hose connection. Comes with a 5m hose.

Three-way valve

Comes with servomotor and additional temperature sensor of 10 metres. This valve enables cooling two rooms 12h by 12h if the Dual Room function is switched on. Each room has its own sensor and it scans the room where the cooling is activated. The High Temperature Safeguard will be active for both rooms simultaneously.

Plenum box

This box can be installed at the backside of the OptiClimate, so that the unit can be placed outside the room. One to three hoses can be connected to the plenum box to suck out the warm air from the room. Always measure the dimensions of the suction hoses as large as possible.

Carbon filters (3 pieces)

See also Inspection and Maintenance

Fault code overview

Keep this error list in the vicinity of the OptiClimate.

E:01 Phase monitor (only for 15000 pro3)

E:02 Condensation drain

E:03 Drain water temperature too high. ($>57^{\circ}$)

E:04 Ambient temperature too low ($<4^{\circ}$)

E:05 Room temperature sensor not connected

E:06 Cooling block temperature sensor not connected

E:07 Return water temperature sensor not connected

E:08 Room temperature sensor not connected (Dual Room)

E:09 Compressor motor thermal safeguard

E:10 Cooling block anti-freeze safeguard

E:11 Faulty or no cooling alarm

E:12 High pressure safeguard (cooling system)

E:13 Low pressure safeguard (cooling system)

E:14 Power interruption

E:15 High temperature safeguard

E:16 Water leakage safeguard