



Lasers



Marking | Cutting | Welding | Micro Machining | Additive Manufacturing

CEO Message



Fiber Lasers are fuelling a manufacturing revolution offering faster, cheaper and more reliable processing, and are widely accepted as the tool of choice for many businesses. At SPI Lasers we supply innovative and reliable Fiber Lasers, backed by market leading customer support.

Our customers are at the heart of everything we do. We are committed to working in partnership with our customers to continually innovate and develop our Laser technology. We progressively push the technological and application boundaries culminating in our suite of premium products, designed by experts, for experts.

***“...premium products,
designed by experts, for
experts.”***

Product quality, reliability and performance have always been our first priorities, yet we have worked hard to maintain a competitive product offering. This relentless pursuit of manufacturing excellence has seen us continually innovate along the value chain, from the manufacture of our own fiber components through to bespoke control solutions. We aim to manufacture the very best quality Fiber Lasers on the market.

I am exceptionally proud of our contribution to the Fiber Laser market, from our pivotal role in the development of the early stages of this technology to our continued investment in Research & Development, Applications, Customer Service and the efforts our staff make every day

***“...the success of our
customers remains our
primary focus.”***

to do more for our customers. Our customer focus and expertise makes the difference.

We work in an innovative and fast paced industry. Both myself and everyone at SPI Lasers are committed to remain at the forefront of these changes; whilst ensuring the success of our customers remains our primary focus.

A stylized, handwritten signature in black ink, consisting of a large loop at the top and a smaller loop at the bottom, with a vertical line extending downwards.

Dr. Thomas Fehn
Chief Executive Officer

About us

A leader in Fiber Laser technology and manufacture since 1999, we offer a wide range of Pulsed and CW Lasers, supported by our comprehensive after sales services. Headquartered in the United Kingdom, with manufacturing facilities in Southampton, Rugby and offices in North America, Europe, and Asia-Pacific, we position ourselves globally to offer the best solutions to our customers.

A leading innovator since the early days of active fiber development we are well respected by our customers for our materials and fabrication knowledge, as well as our ability to innovate at the glass level. Through this we bring truly unique Fiber Lasers to market, that simultaneously address the needs of both applications and end product manufacturing.

The acquisition of JK Lasers in 2015; one of the world's leading manufacturers of high-power Fiber Lasers for industrial use; helped strengthen our position as a leader in the Fiber Laser market. With more than 40 years of experience in Laser development, we are benefiting from their core competence in the development of Fiber Lasers with outputs up to 4 kW, as well as combiners for joining Laser sources and other beam guidance components.

JK Lasers, products and operations have been incorporated under the single brand of 'SPI Lasers', with its UK site in Rugby continuing to operate as an additional manufacturing, development and customer service center for Fiber Lasers and optical components.

Focusing on customer solutions:

We know customers don't buy products, services or even people – they buy results. We focus on using our expertise gained across a diverse array of global industries, from Aerospace, Electronics, Medical, Additive Manufacture and Automotive to create and provide solutions that address our customers' specific priorities and provide excellent results.

Our customer centric approach enables us to work in partnership with our customers, creating tailored solutions specific to their challenges. If you are looking for more than just an 'off the shelf' Laser our expertise and customer focus may be the difference you are looking for.



T

he amalgamation of the two companies brought significant customer benefits, with improvements in both experience and expertise, creating a more versatile organisation, with enhanced vertical integration. Our expanded base of highly qualified Laser experts, translates into a broader product offering, greater integration, product innovation and enhanced customer service.

Our engineers ensure all the Fiber Lasers we manufacture are built to our exceptional standards, are focused on customer requirements and are designed to easily integrate into our customers systems and applications. With tens of thousands of units in operation with millions of service hours behind them, we are naturally proud of the products we manufacture and remain committed to ongoing development.

We are focused on delivering innovative, quality and reliable products with first class levels of customer support, through the development of highly effective Fiber Laser solutions for macro, micro-machining, welding, cutting, marking and additive manufacturing applications.

Our commitment to continuous innovation brings significant benefits for our customers from enhancing precision of control and ease of use, through to improving the ruggedness and reliability of all our Lasers.

Whatever your industry or needs, we are equipped to assess your challenges and help you find a practical Laser based solution.



Vertical Integration

To ensure customer service levels are high and costs are competitive, we are focused on maintaining as much in-house manufacturing as possible, from the production of our own fiber, Beam Delivery Optics, mode strippers and beam combiners; all produced to our exceptional quality standards.

Research & Development

We have distinguished ourselves through continued investment in Fiber Laser and fiber innovations, technical advances and developments. This remains an area of continuous improvement for us and is a core aim of our active Research & Development unit.

A key source of our innovation is our Advanced Laser Laboratory, embedded within the Optoelectronics Research Centre (ORC), part of Southampton University; widely regarded as one of the world's leading institutes for photonics research.

Quality Control

To guarantee our products comply with the highest technical and manufacturing standards, we only work with the finest suppliers and entrust production to expert engineers and technicians.

To ensure standards are maintained we implement rigorous test procedures for every part of our Lasers at each stage of production. Only such high demands can guarantee the consistent quality of Lasers **"Made by SPI"**.

Our Products

Our Lasers use our own proprietary fibers and patented GTWave technology making our products unique and exclusive to us.

Our product portfolio is the result of our extensive experience of the industrial Laser materials processing sector, including long-term relationships with customers. It is based on a strong commitment to Research & Development and rigorous product development, addressing customers' business and technology demands.

Regardless of whether you choose one of our range of **redENERGY®** or **redPOWER®** Fiber Lasers you will have the flexibility to control power, modulation rate, pulse width and shape. When combined with tailored beam delivery and control features, our Fiber Lasers become the tool of choice for your industrial Laser applications.

Benefits

All our Fiber Lasers benefit from a number of key product qualities that in turn have a direct impact on the performance of our customers products and organisations.

 **Greater flexibility;** our Fiber Lasers offer users greater flexibility based on an extended range of performance features. CW Laser model benefits include high modulation rates linked to totally flexible integral pulse shaping capability and closed loop operations, while Pulsed EP Series Laser sources offer the greatest range of pulse width variability from 3-500ns with up to 1MHz operation CW capability.

 **Superior quality;** all our products are designed, engineered and manufactured to be of the highest quality, resulting in Lasers with excellent levels of reliability. In addition our diverse feature suite allows greater control for enhanced processing results.

 **Increased processing;** our broad product range enables sources to be tailored to specific applications through optimised beam quality by choice of delivery fiber in CW Laser and choice of M² in pulsed. In addition, in our redPOWER Lasers the optimisation of pulse duration and frequency can often enhance productivity.



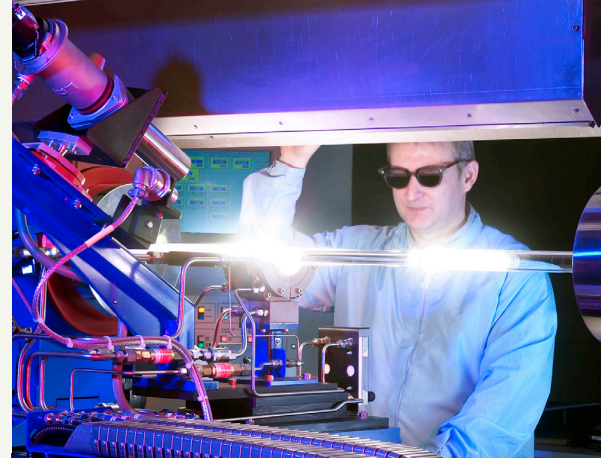











 **Improved profitability;** Whether you are an integrator or end user, our objective is to help our customers be more successful. Our Lasers are compact, easy to integrate and available at levels of integration to suit customer requirements. Compared with other solid state Lasers, Fiber Lasers offer greater efficiency and reliability; low running costs and virtually no on-going maintenance. Coupled with enhanced process performance our Lasers can help deliver enhanced profit.



Our Markets

Whatever your industry, if you have a requirement for a Fiber Laser we will be happy to discuss your needs and find you the right solution.

Our diverse customer base has allowed us to build our experience across multiple manufacturing and engineering industries including:

-  **Aerospace**
-  **Automotive**
-  **Batteries**
-  **Consumer**
-  **Electronics**
-  **Dental**
-  **Jewellery**
-  **Medical**
-  **Printing**
-  **Scientific**
-  **Sensors**
-  **Semiconductors**
-  **Solar**
-  **Telecoms**
-  **Watch Making**

Applications

We are committed to advancing the flexibility of our Fiber Lasers, to ensure they excel in every application, both known and those yet to be discovered. Our Fiber Lasers are used for a wide variety of applications, including:

-  **Ablation**
-  **Additive Manufacturing**
-  **Cutting**
-  **Drilling**
-  **Engraving**
-  **Layer Removal**
-  **Marking**
-  **Material Processing**
-  **Micro Machining**
-  **Precision Cutting**
-  **Scribing**
-  **Solar Cell Processing**
- **Soldering**
- **Thin Film Patterning**
- **Thin Foil Cutting**
- **Welding**

redENERGY® G4

Flexibility and speed for marking and pulsed micro-machining.

20W - 100W

Pulsed Fiber Laser
Wavelength 1060nm



redENERGY® G4 represents our range of pulsed Fiber Laser modules that use GTWave and PulseTune technologies. Operating in the nanosecond pulse duration regime these Lasers are widely used in a diverse array of applications, offering users unrivalled versatility and flexibility.

redENERGY® G4 Lasers are all maintenance free, utilising 'Fit & Forget' technology, allowing you to focus on output, rather than time consuming maintenance schedules.

Our 4th generation **redENERGY® G4** pulsed product platform is the pinnacle of pulsed nanosecond technology, benefiting from an array of enhanced features for multiple applications as well as making ground breaking movements into micro-machining, taking our PulseTune enabled Lasers to a new level.

redENERGY® G4 is designed to benefit high volume manufacturing, where it yields unprecedented reliability and consistency. Specific attention has been paid to enhancing the ease of OEM integration, enabling easy adoption of the full product features and range.

Designed for manufacturability and reliability **redENERGY® G4** sets new standards of product quality, backed by an industry leading 3 year warranty as standard.

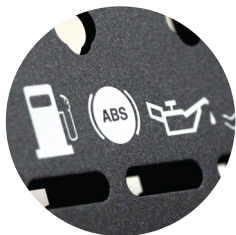

Marking
Night & Day Plastics



Marking, Cutting, Engraving, Etching
Sterling Silver

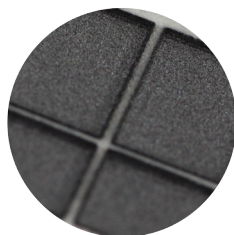

Deep Engraving
Metals & Ceramic

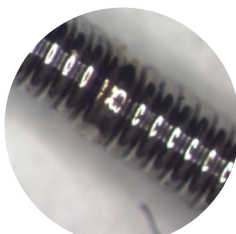

Micro Welding



Marking
Thin Film Patterning



Marking
Metallic Materials

Key Benefits

- Easily integrated compact and robust
- 'Fit & Forget' technology
- 'Plug and play' beam delivery solution
- Flexible connectivity
- Unrivalled controllability
- 3 year standard warranty
- CW mode available

Key Features

- Up to 1.3 mJ Pulse Energy
- Tuneable Pulsed Durations from 3-500ns
- >20 kW Peak Power available
- Common interface for all models
- Air cooled or Water cooled option on selected products

Applications

- Ablation
- Cleaning
- Drilling
- Engraving
- Layer removal
- Marking
- Micro-machining
- Micro-welding
- Precision cutting
- Scribing
- Silicon cutting
- Solar cell processing
- Thin film patterning
- Thin foil cutting

Materials

- Anodised / painted surfaces
- Ceramics
- Composites
- Gemstones
- Metals
- Precious metals
- Plastics
- Thin films



Beam Quality Options

Selecting the optimum beam quality for your specific application is essential in gaining the desired speed and quality.

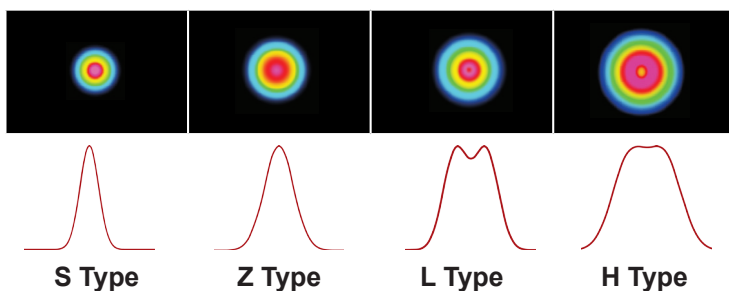

PulseTune Technology

Our PulseTune technology provides the ability to select waveforms, offering pulse widths from 3 ns - 500 ns. Each pulse waveform is designed for maximum peak power and pulse energy at an optimised pulse repetition frequencies.

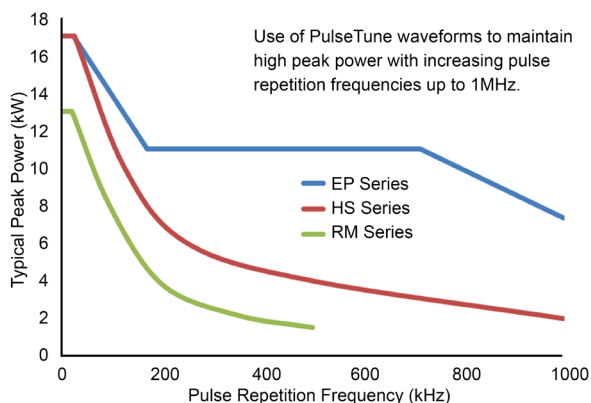
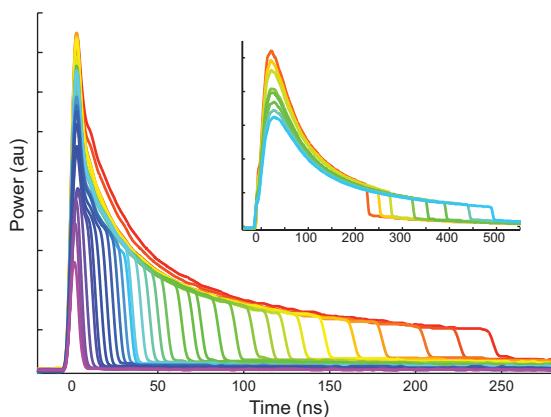

S Type - Single mode ($M^2 < 1.3$)

Generating very fine spot size (<20 μm possible) with high stability and large depth of focus.

Z Type - General purpose ($M^2 < 1.6$)

Higher peak power and pulse energy with only minor increase in spot size over S Type.

L Type - Low mode ($M^2 1.6 - 2.0$)

For slightly larger feature sizes that are more visible to the naked eye.

H Type - High mode ($M^2 2.5 - 3.5$)

Higher pulse energies, peak powers and bigger spots ideal for large area coverage.

PulseTune Functionality

Gives users greater control of pulse conditions and provides increased pulse energy and peak power at high pulse repetition frequency.

RM Series (Reduced Mode)

- Models benefit from 2 PulseTune waveforms
- Up to 0.5 MHz pulse repetition frequencies



HS Series (High Specification)

- 25 PulseTune waveforms
- Up to 1 MHz pulse repetition frequencies



EP Series (Extended Performance)

- Up to 40 optimised PulseTune waveforms
- Up to 2 MHz pulse repetition frequencies



redPOWER®

300W - 6kW

CW / Modulated Fiber Lasers
in OEM or integrated configurations.

Wavelength 1080nm



Our suite of redPOWER® CW Lasers comprises the PRISM range of OEM format single modules or combined multi-kW Lasers (using our proprietary High Power Combiners), and the QUBE range which integrates these units into industrial Fiber Laser solutions. Together they provide exceptional levels of choice for the power and control for your industrial applications.

redPOWER Fiber Lasers deliver substantial commercial benefits over alternative technologies, offering improved line speeds, finer machining capabilities and reduced downtime.

Specialising in cutting, welding and 3D printing applications redPOWER Lasers can be integrated directly into production lines or your machines. A range of output fibers are available up to 20m in length with single and multi mode options to ensure even the largest machines can benefit from redPOWER.



Scan for more detail on how the SPI Tower Bridge was made.



Pierce Detection

redPOWER PRISM and QUBE Lasers using multiple modules are uniquely able to provide an integrated Pierce Detection feature, using sensors located in the High Power Combiner (HPC) Module.

Pierce Detection is an essential feature in any high productivity cutting system. During cutting an initial pilot hole is pierced through the material, only after this is complete does the cutting commence. Our redPOWER units sense the back reflected light from the work piece using internal sensors and interpret this to determine when the work piece has been fully pierced.

Completion of the pierce is communicated via our bespoke FiberView control software, allowing easy interfacing to the PLC system controller. As different materials and processes have different signatures for the pierce detection signals, a set of configuration parameters are supplied with each Laser.

Without the benefit of Pierce Detection, a long dwell time to ensure pierce through in all locations, can seriously increase the overall sheet processing time, especially if there are numerous individual cuts to be made.

Key Benefits

- Automated integrated pierce detection
- Patented back reflection protection
- CW or Modulated
- Dynamic pulse shape control
- 'Fit & Forget' technology
- Full comms / analog I-O control options
- High power stability
- Highly engineered beam quality
- 2 year standard warranty
- FiberView™ software
- High frequency modulation
- High reliability
- Integral pulse shaping capability

SPI Lasers Tower Bridge

Method: Cutting Bright Metal

Metals: Aluminium, Brass, Copper, Mild Steel and Stainless Steel

Process: Cutting

Laser & Power: redPOWER® PRISM OEM 1.5kW

- Low order mode fiber beam delivery
- Multiple fiber delivery options
- Pulse waveform control
- Range of cutting & welding heads
- Small footprint
- Compact design for OEM integration
- High power connector options
- Integrated pump diodes and drive electronics
- Integrated power and temperature monitoring
- Single and multi mode delivery fiber options available
- Wide range of control options available
- High efficiency

redPOWER® QUBE / PRISM

Product Range

CW / Modulated Fiber Lasers
in OEM or integrated configurations.
Wavelength 1080nm

redPOWER® QUBE

Power and control for cutting, welding, micro-machining and additive manufacturing.

300W - 1.5kW
CW Fiber Laser



redPOWER® QUBE Multi kW Laser

Providing exceptional levels of power and control for industrial applications.

3kW - 6kW
CW Fiber Laser



redPOWER® PRISM

Integrated solution with comprehensive control options for high performance industrial applications.

300W - 1.5kW
CW OEM Fiber Laser



redPOWER® PRISM Multi kW OEM

Building blocks for high power Fiber Lasers.

3kW - 6kW
CW OEM Fiber Laser

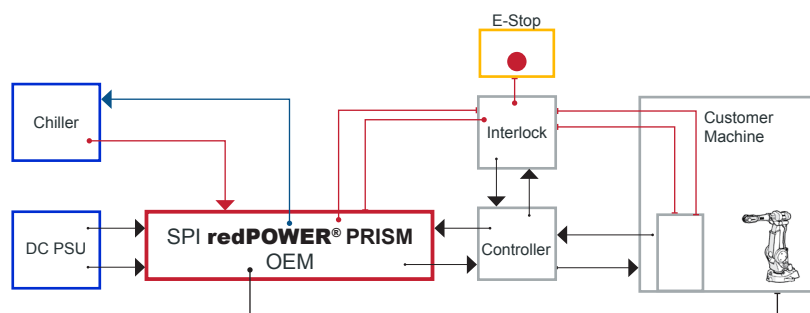

redPOWER® PRISM OEM schematic drawing

Applications

- 3D Printing
- Cutting
- Drilling
- Heating
- Semiconductor marking and cutting
- Soldering
- Welding
- Scribing
- Additive manufacturing
- Material processing
- Cladding
- Flat sheet cutting
- High speed welding
- Remote welding
- High speed cutting
- Thick section welding

Materials

- Aluminium
- Brass
- Copper
- Mild steel
- Multi layer metal composites
- Reflective metals
- Stainless steel
- Ceramics

Process Tools

A modular range of welding and cutting focus heads.

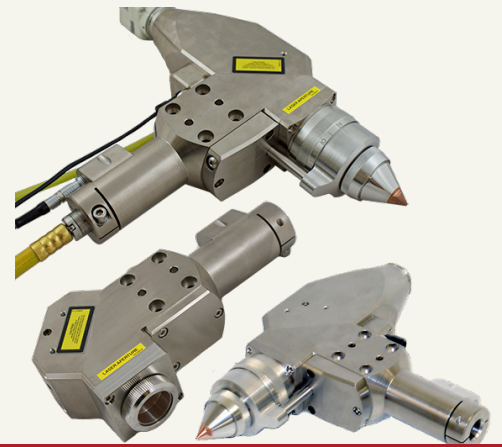

redPOWER® Process Tools have the flexibility to meet your needs for reliability, performance and power. Specifically developed to work alongside the rugged and reliable fiber optic beam delivery system.

redPOWER® Process Tools enable manufacturers to carry out complex, high performance industrial welding, cutting and drilling applications, even when the laser is located remotely from the workstation.

The construction of our range of cutting and welding heads allows us to configure the optimum spot size and focus arrangement to meet production needs. Our **redPOWER®** range of laser Processing Tools offers customers the combination of high power and flexible delivery system. Each Process Tool consists of a base focus head with recollimating lens, a focus lens module, assist gas delivery, CCTV viewing and many other ancillaries.

The Process Tools are specifically designed for Fiber Lasers and feature diffraction limited optical performance, enabling the ultimate beam quality of the single mode Fiber Lasers to be realised for industrial processing applications. Their compact size and ease of use allows them to be configured for the optimum spot size required to meet many complex manufacturing operations.

Despite their compact size, their careful optical design allows them to be used for all powers of single mode laser within our Fiber Laser range, with the addition of water cooling option at the highest powers. In the case of the cutting heads (both standard and height sensing configurations) special care has been taken to keep the working volume streamlined to allow best possible access into the work piece.

Process Tools Formats

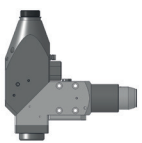

DESIGNATOR: R

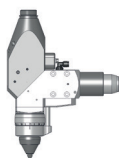

DESIGNATOR: V



DESIGNATOR: S



DESIGNATOR: Z

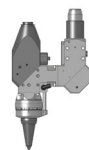

Key Benefits

- Modular range of process tools for use with some of our redPOWER Fiber Lasers
- Cutting heads, welding heads and recollimation units
- 8µm - 90µm spot sizes available
- Compact size
- Fine focus adjustment and Integrated co-axial gas delivery on cutting heads
- CCTV viewing options
- Through the lens (TTL) illumination options
- Sealed to IP54 industrial standard
- Easy access cover glass and focus lens
- Range of formats for increased application flexibility.

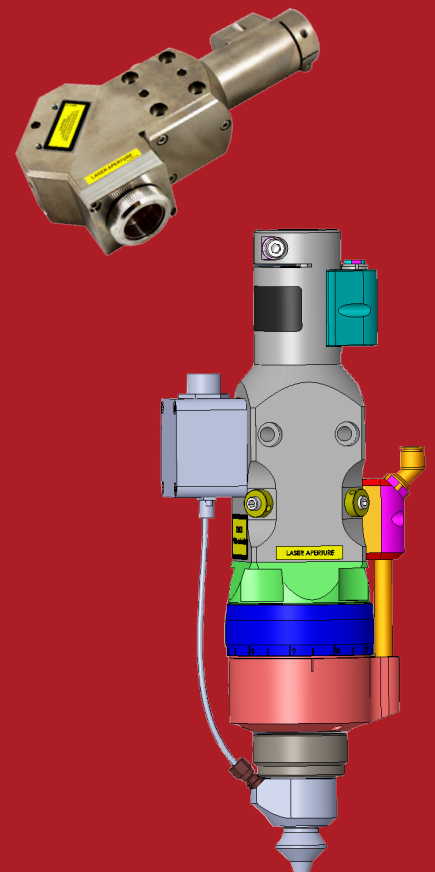



Service and Support

We believe that our relationship with you begins well before any purchase is made.

Pre-Sales Support

Our knowledgeable and skilled field sales representatives will be on hand to help at all times throughout your purchasing journey. Even if you are not yet ready to make a purchase they will be happy to help you work through your requirements and suggest the optimal solution to whatever challenge(s) you are facing.

Much of this work would be carried out using our in-house Application Labs, based at key locations around the globe and run by skilled SPI experts, all of whom have extensive experience in materials engineering and Laser applications.

“Whatever the challenge, we can work directly with you....”

Whatever the challenge, we can work directly with you, from initial investigation all the way through the product lifecycle, in order to deliver the very best output for your requirements.

Online Support

If you are unsure of exactly what type of Laser you require, or even the best application for your requirements, then spilasers.com is a great place to begin your manufacturing journey; packed with information and insights on everything Fiber Laser related, it's your one stop shop to achieving your Laser processing goal(s).

We continually update our site with application insights and white papers to help educate our customers and the market on the best ways to process specific applications, as well as publishing an array of technical papers on key topics / challenges in the industrial Laser processing community.

Visit spilasers.com today and register to receive updates on everything from the latest product information through to newly released application insights and webinars.

Try Before You Buy

For customers wanting to evaluate and verify process capability on their own equipment we will be happy to provide a Laser in situ, via **a 30 day trial at your premises**, allowing you the time to make a thorough review of its performance.

Our product support staff will be on hand to help prepare you for integration, focusing on all aspects including establishing an effective control interface.

Even if you are unsure of suitability we will send you an appropriate Fiber Laser for a no obligation trial. You will have the opportunity to evaluate the Laser for your specific application, with as much support as we are able to provide.

To enquire about this service visit www.spilasers.com/support

Application Labs

We know that purchasing new capital equipment or investing in a new supplier of Lasers can be a costly and demanding process; we are constantly working to make that task as easy as possible for our customers.

With over 100 years combined experience in materials processing, our Applications Laboratory teams are ideally suited to provide our customers with the very best support in sourcing the most efficient Fiber Laser solution, whatever their goal.

Located in Southampton (UK), Santa Clara (USA) and Shanghai (China) our Applications Laboratories are equipped with our latest Pulsed and CW Fiber Lasers and can be made available to our customers to carry out early stage development, helping find the perfect advanced manufacturing solution.

“With over 100 years combined experience in materials processing.”

Our customers are typically systems integrators, job shops, factory automation specialists, OEMs, academic and other institutions looking for high quality Fiber Lasers at competitive prices. With our extensive industry expertise, knowledge of the latest innovative processing techniques and customer focused approach we work in partnership with you to ensure that from day one you not only receive the best products but also the very best levels of solution support.

Working with you at your facilities

Our Applications Team can be outsourced to work directly with customers on your site to help improve applications process optimisation and to develop/implement novel applications to benefit your manufacturing processes.

Our diverse customer base includes manufacturers and processors in the semiconductor, electronics, consumer electronics, automotive, medical, food and packaging and general industrial sectors. As a consequence our skills and experience can be invaluable in helping find solutions for a wide variety of manufacturing challenges.

For more information on our Application Labs visit:
spilasers.com/support



Establishing applications ‘know how’

A key part of the applications labs remit is to establish the know-how to support our customers with in-depth knowledge of Laser materials processing for the fast and successful implementation of manufacturing processes utilising our Pulsed and CW Fiber Lasers.

Our extensive web based process database and application insights provide a valuable learning library for potential users. For more intensive research our applications team are on hand to work with you to investigate specific requirements, creating innovative solutions and case-specific feedback to inform your decision.

Bespoke training, in-depth application assessment and process optimisation can be provided at any of our global labs, ensuring our customers receive maximum support in identifying the optimum solution(s) to their manufacturing challenges.

Contact your local sales representative to discuss your application requirements and arrange for a ‘proof of concept’ trial or visit. www.spilasers.com

Our Continued Service

We regard customer service as an integral and essential part of our overall quality policy, which is why we run a number of after sales programs designed to get the most from your Laser.

Warranty and Repair

Our Lasers are designed and manufactured for years of use with little to no intervention on the manufacturing floor. This low maintenance advantage allows all our Lasers to benefit from 'Fit & Forget' technology. In the unlikely event of an electrical or optical failure accessing the internals of the Laser can only be addressed by factory trained personnel.

All our Fiber Lasers come with a fully comprehensive warranty and we run a global network of authorised technical centres, staffed by highly skilled engineers who can undertake all electronic repairs, guaranteeing fast, efficient and personal handling.

In the unlikely event your Laser incurs an optical failure, a repair will be undertaken at one of our Regional Service Centres or Product Centres. At all times during repair work we will remain in contact with you; from informing you your Laser has been received by our repair facility and is under investigation, through to submitting a failure report for your attention, and confirming a date for your Laser to be repaired and delivered back to you.

And rest assured, even though we are committed to continued development and innovation, our service commitment extends for years after certain models are discontinued or upgraded, ensuring your business productivity is not affected.

Supporting your Marketing

We know that marketing your machines is vital for a successful launch. Our e-newsletters reach 100,000+ mailboxes worldwide each year and we often collaborate on these with our customers.

In addition we also offer help to support your sales team, via referral of leads and supply of application samples, as well as providing interactive tools and technical datasheets to assist you in a sale.

We believe in adding value to all our customers, when you buy from us you are buying more than just a Laser, you are purchasing a commitment to an ongoing partnership.

To enquire about how we can support you contact us via:
sales@spilasers.com

Training Courses

As well as providing you with advice and guidance ahead of your purchase, our Application Labs and Service and Support teams add value after your purchase, **helping to train your staff in fault diagnostics, electronic repair of our Lasers and Laser processing and optimisation**, as well as providing training on the latest user techniques and developments specific to an SPI Laser.

Our skilled engineers run a number of global training courses throughout the year from both a user and service perspective.

In addition we carry out regular customer training programs enabling our customers' engineering and support teams to confidently service and support our Lasers at their end users' sites.

To enquire about any of these services visit: www.spilasers.com/support



Global Operations - Sales & Service

With our headquarters and manufacturing base located in the United Kingdom along with operations in China, Korea and the US, our global reach ensures we are among the industry leaders for Fiber Laser production. In addition our network of approved distributors spans the globe, ensuring that wherever you are in world you can be sure of our local service.

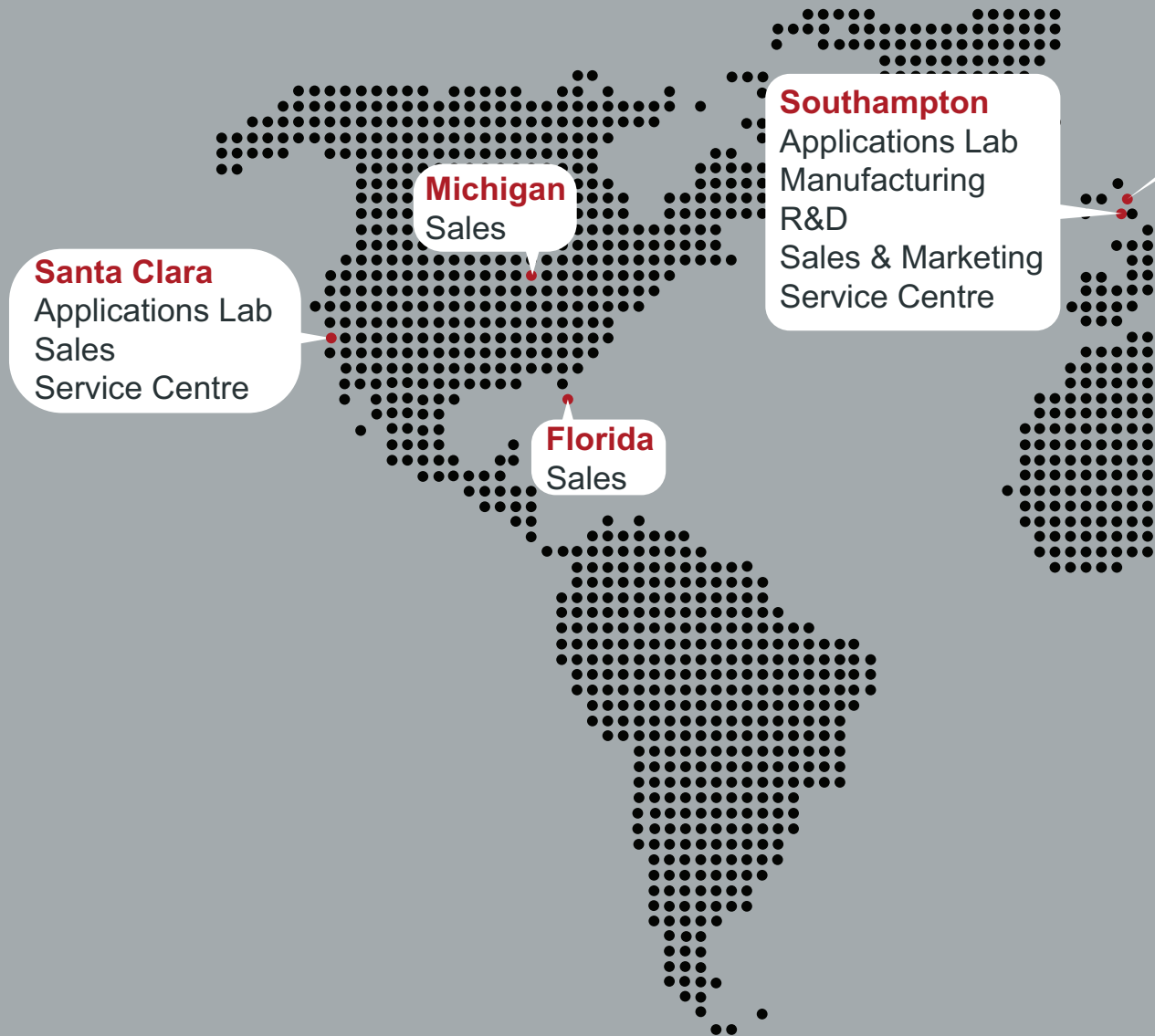

Santa Clara
Applications Lab
Sales
Service Centre

Michigan
Sales

Florida
Sales

Southampton
Applications Lab
Manufacturing
R&D
Sales & Marketing
Service Centre

UK Head Office & Manufacturing

SPI Lasers UK Ltd, 6 Wellington Park, Tollbar Way, Hedge End Southampton, SO30 2QU, UK

UK Manufacturing

SPI Lasers UK Ltd, Cosford Lane, Swift Valley, Rugby CV21 1QN

USA

SPI Lasers LLC, 4000 Burton Drive, Santa Clara California 95054, USA

Phone: +44 1489 779 696
www.spilasers.com

Phone: +44 1788 570 321
www.spilasers.com

Phone: +1 408 454 1170
www.spilasers.com



China

SPI Lasers (Shanghai) Co Ltd,
Room 108 and 112, Building 3, No.
7 Guijing Road, Caohejing Hi-tech
Park, Shanghai, PRC

Phone: +86 21 6171 9470

www.spilasers.cn

Korea

A-1201, 1682,
Jungsan-dong, Ilsandong-gu,
Goyang-si, Gyeonggi-do,
Republic of Korea

Phone: +82 31-926-7580

www.spilasers.kr

RV-0117



UK Head Office

SPI Lasers UK Ltd, 6 Wellington Park,
Tollbar Way, Hedge End,
Southampton, SO30 2QU, United Kingdom
Phone: +44 (0) 1489 779-696
Website: www.spilasers.com