

**YANSIMALAR III**  
**REFLECTIONS III**



Havuz tutamak, kaymaz, karo ve mozaikleri  
Pool handles, antislips, tiles and mosaics.



## Yeniliklerle havuzlar daha güzel!

Havuzlar hayatımızda gitgide daha fazla yer tutarken, havuz kaplama malzemelerinin lider ismi Serapool, yenilikçi çabalarına hız kesmeden devam ediyor. Üstün kaliteli ürünlerini çeşitlendirerek, havuz kullanıcılarının artan ve farklılaşan beklentilerine cevap veriyor. Günümüzde çok daha fazla sayıda insanın ulaşabildiği bir yaşam zevki olan havuz yapımında kullanılan porselen malzemenin sağlıklı ve hijyenik oluşuyla değer kazanıyor. Spor yaparak sağlıklarını korumak, hayattan daha fazla keyif almak, yaşam alanlarını güzelleştirmek, yakın çevrelerinin peyzajına estetik katmak isteyen havuz severler, en iyiyi ve en yeniyi hak ediyor. Serapool, bugüne değin gerçekleştirdiği tüm üretimlerde yüzde yüz porselen kullanarak, alanında elde ettiği haklı güveni, yine tamamı porselen yepyeni ürünlerle pekiştiriyor. Beş yüzden fazla ürün çeşidiyle, işine verdiği önemi ortaya koyuyor. Daima daha iyinin arayışında olan Serapool, denenmemiş, uygulanmamış farklı ebat, renk ve dokulardaki ürünleriyle, havuz kaplama malzemelerinde yeni bir dönemin müjdesini veriyor, yeniliklerini havuz severlerle paylaşıyor. Büyük beğeni toplayan bu yenilikler, havuz dünyasında uyandırdığı yankı ile Serapool'un heyecanına heyecan katıyor. İncelikle düşünülmüş, özenle araştırması yapılmış, büyük emekle tasarlanmış daha göz alıcı üretimler için güç ve motivasyon sağlayan Serapool, şimdi aynı hızla devam eden değişim sürecinin yeniliklerini de havuz kullanıcılarının beğenilerine sunuyor.

**Havuz sahibi olmanın ayrıcalıklı keyfini doyasıya yaşatmak için!**

## The pools are more beautiful with innovation!

While pools are getting more important in our lives day by day, Serapool, "the leader name of the pooling materials", quickly responds to the constantly changing and increasing expectations of pool users by diversifying their superior quality products. Serapool's products, which are produced from porcelain (which is a healthy and hygienic material) now add value to the pools that more people can reach today. Serapool produces all products from 100% porcelain to find a magnificent solution for people who love life, doing sports, protects their health and adds beauty to the beauty of their living spaces, from the day it was established until today. Thanks to these magnificent solutions which made by Serapool, it has become a source of pride by earning the pleasure of all customers. Serapool, showing its importance given to own job with its product range of more than five hundred products, never give up creativity and Serapool has always been in search of the better. And, now, Serapool gives to everyone good news of an entirely new era with new surfaces, colours and size which nobody has produced until now. Products with all the fine details in this new era will add excitement and increase Serapool's motivation.

**To have a privileged enjoyment of being a pool owner!**



TS EN 14411



ISO 9001: 2015

# YANSIMALAR III REFLECTIONS III

**Havuz Tutamak, Kaymaz, Karo ve Mozaikleri**  
Tiles, Handles, Antislip Tiles and Mosaics for Pools

## İÇİNDEKİLER CONTENTS

4 - 8

**Havuz Sistemleri ve Detaylar**  
Pool Systems and Details

10 - 22

**Tutamak, Kaymaz ve Köşeleri**  
Handle, Antislip and Corners

24 - 25

**Pötikare Pahlı Merdiven Kaymazı ve Köşeleri**  
Petit Carre Rounded Antislip Stair Steps Tile And Corners

28

**Teras Kaymazları**  
Terrace Antislip Tiles

30 - 31

**Dış Mekan Karoları**  
Outdoor Tiles

33 - 34

**İç ve Dış Bükey Parçalar**  
Concave and Convex Parts

36 - 38

**Porselen Karolar**  
Porcelain Tiles

40 - 44

**Porselen Mozaikler**  
Porcelain Mosaics

46

**Porselen Mozaikler - Versicolor Serisi**  
Porcelain Mosaics - Versicolor Series

48 - 49

**SeraBella Porselen Mozaikler**  
SeraBella Porcelain Mosaics

51 - 58

**Kanallar**  
Channels

60 - 62

**Izgaralar**  
Gratings

64

**Aksesuarlar**  
Accessories

66

**Agora Rölyef Karolar**  
Agora Relief Tiles

67

**Bordürler**  
Borders

69 - 70

**Projelerimizden Bazıları**  
View Some of Our Projects

71

**Teknik Özellikler**  
Technical Features

## Havuz Sistemleri ve Detaylar

Pool Systems and Details

### Üstten Taşma Detayları

Top Overflow Details

**10207**

Detay 1 / Detail 1

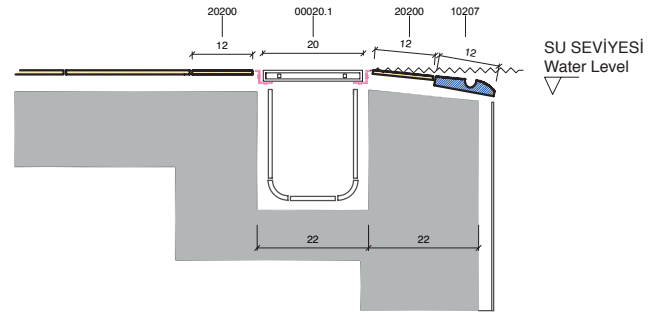
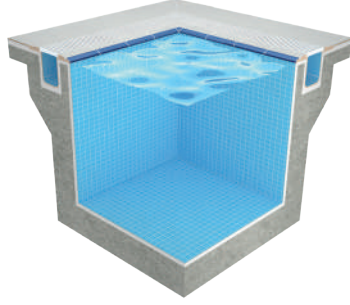

**10227**

Detay 2 / Detail 2

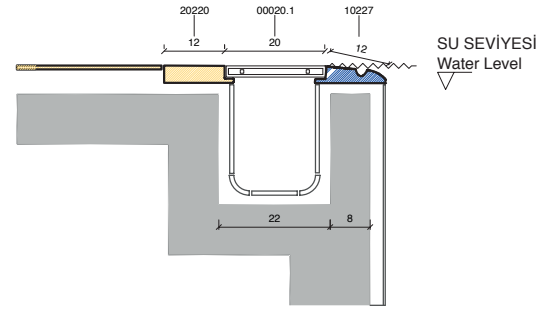
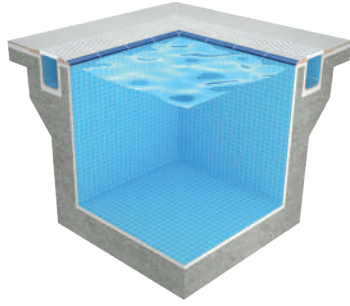

**C150.107**

Detay 3 / Detail 3

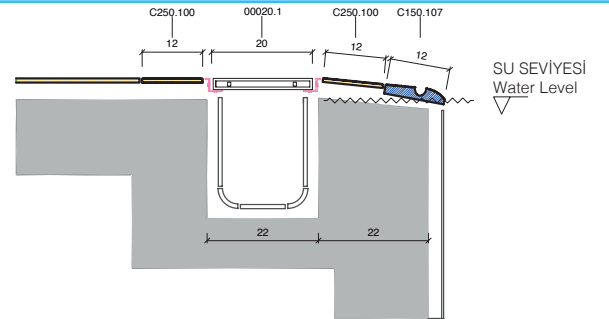
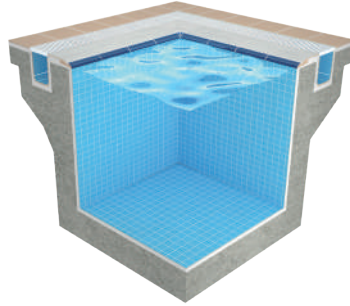

**17207**

Detay 4 / Detail 4

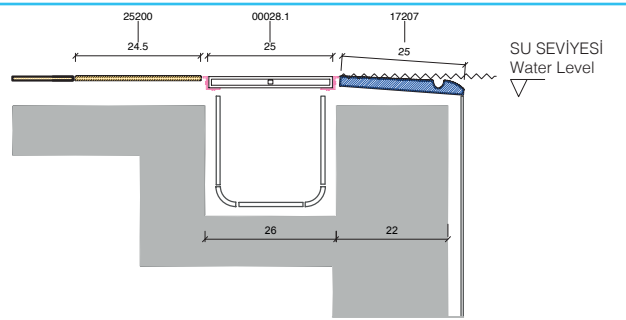
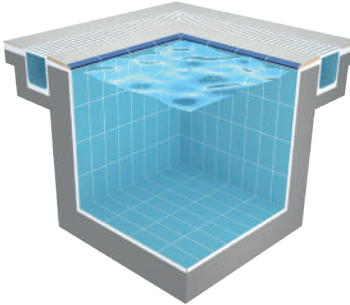

**17227**

Detay 5 / Detail 5

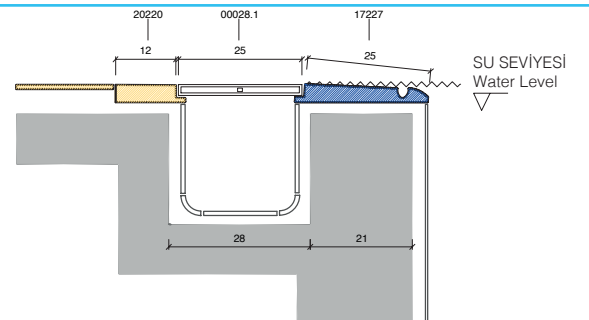
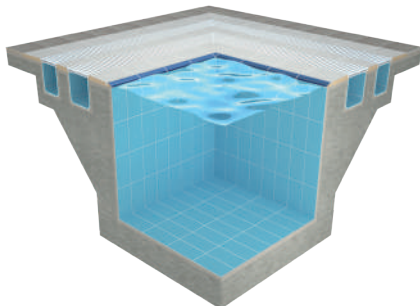



## Havuz Sistemleri ve Detaylar

### Pool Systems and Details

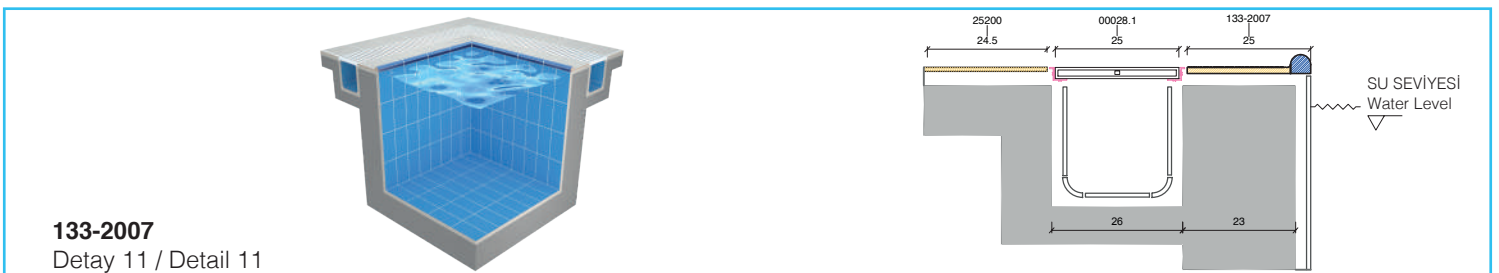
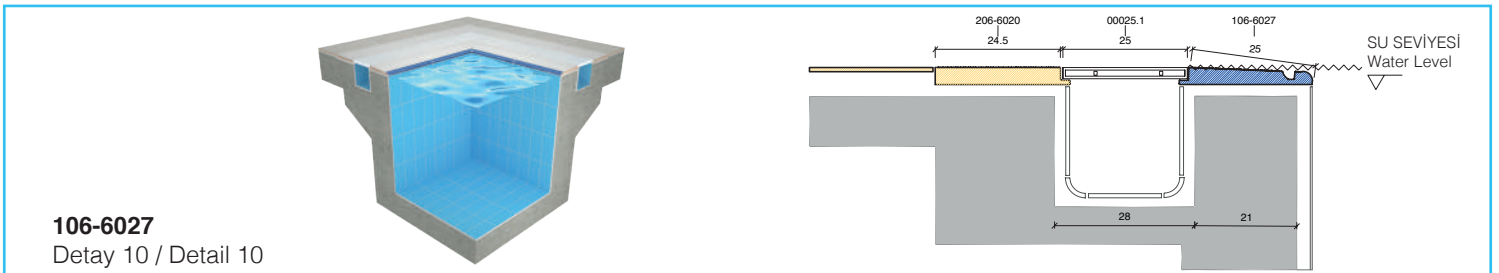
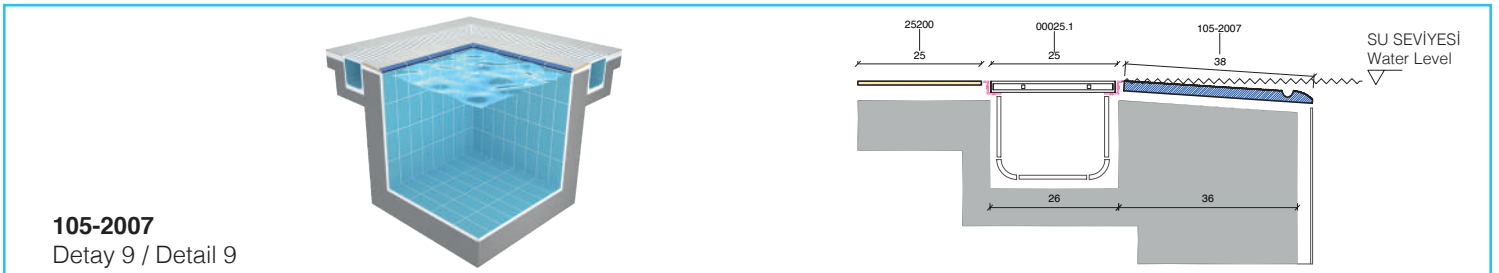
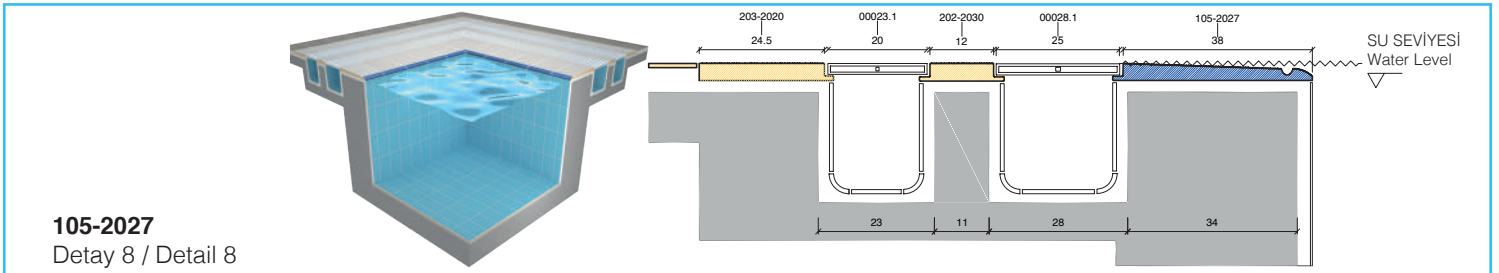
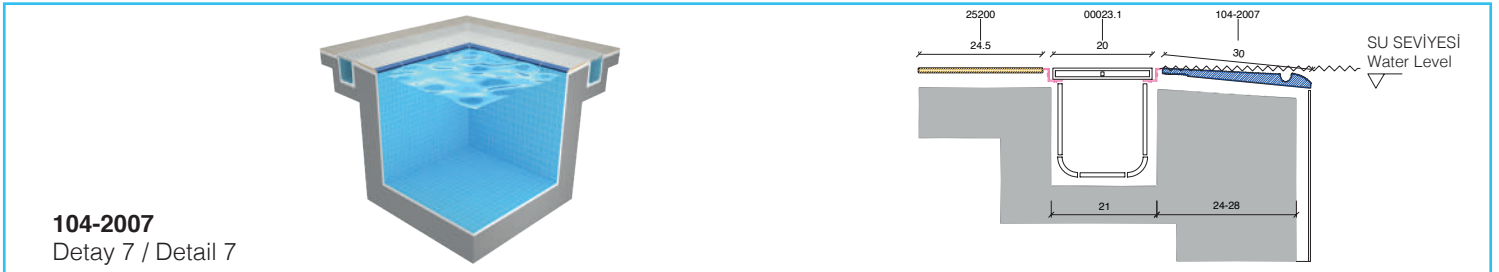
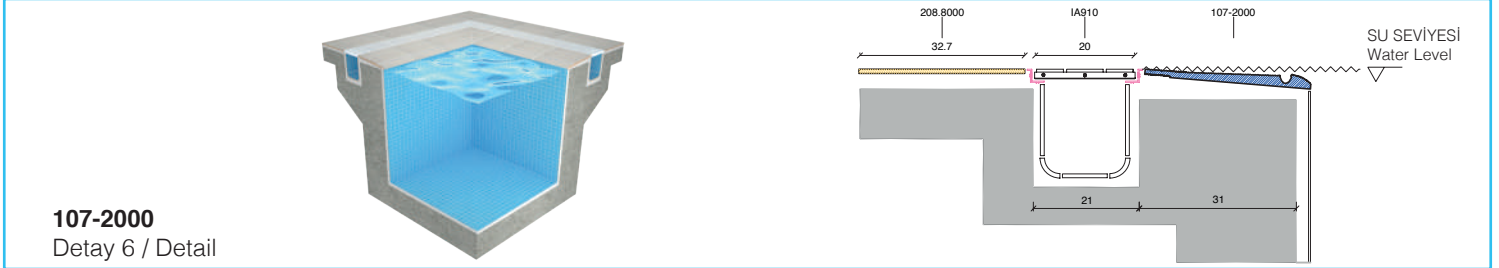

## Havuz Sistemleri ve Detaylar

Pool Systems and Details

### Skimmerli Detaylar

Special Details for Skimmer Details

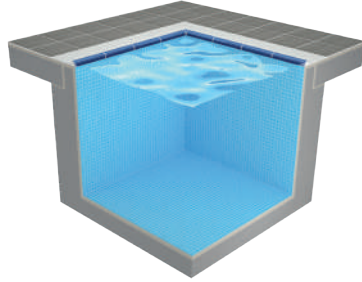

**11207**  
Detay 12 / Detail 12

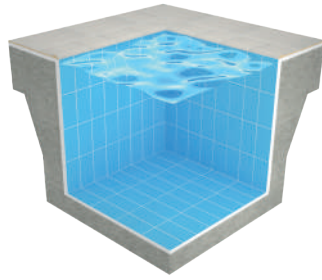
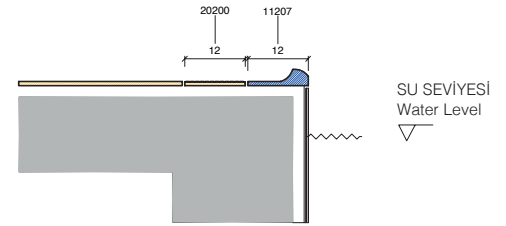

**103-8000**  
Detay 13 / Detail 13

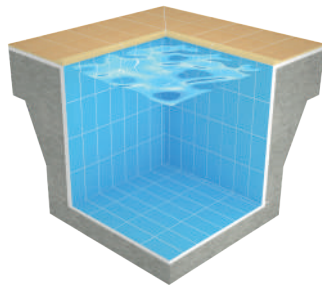
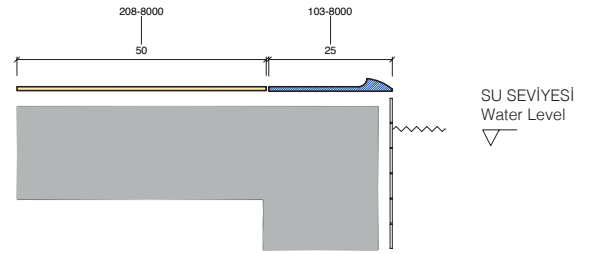

**1018-1004**  
Detay 14 / Detail 14

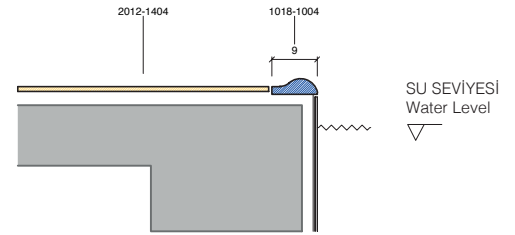

### Hazır Savak Kanalları

Channels - Low Water Level Over Flow

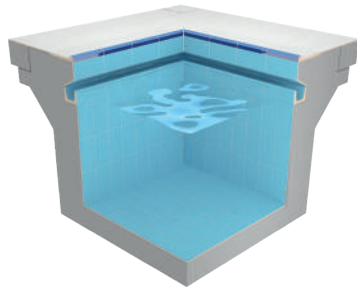

**K101**  
Detay 15 / Detail 15

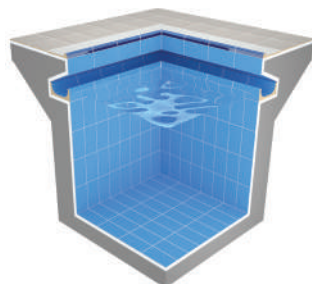
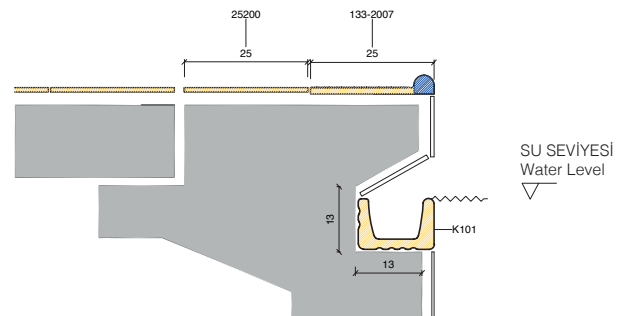

**K201**  
Detay 16 / Detail 16

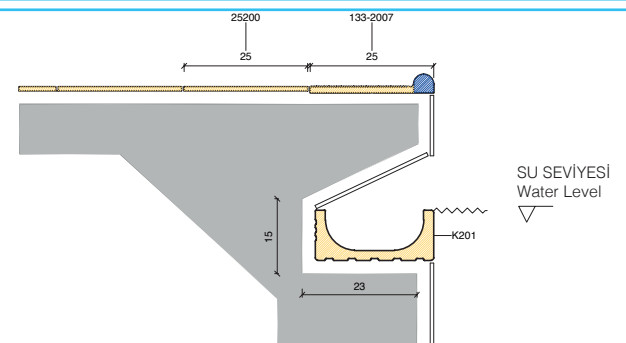

## Havuz Sistemleri ve Detaylar

### Channels for High Water Level Overflow

**K301**

Detay 17 / Detail 17

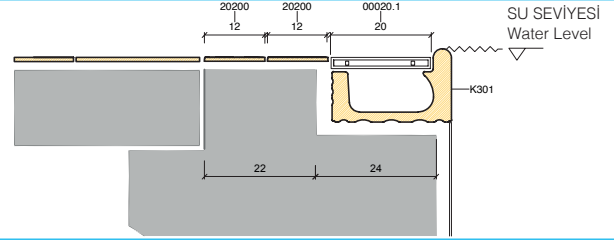
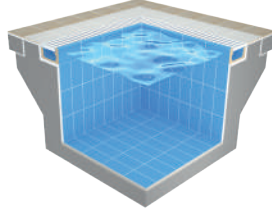
**K401**

Detay 18 / Detail 18

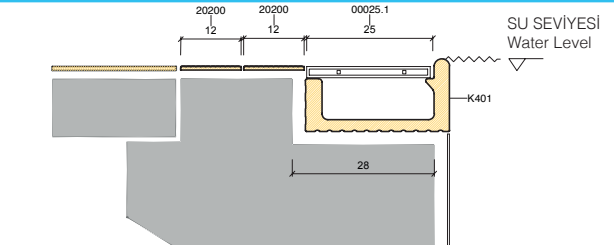
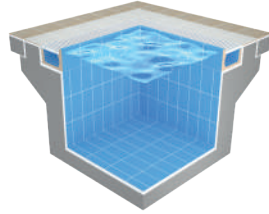
**K501**

Detay 19 / Detail 19

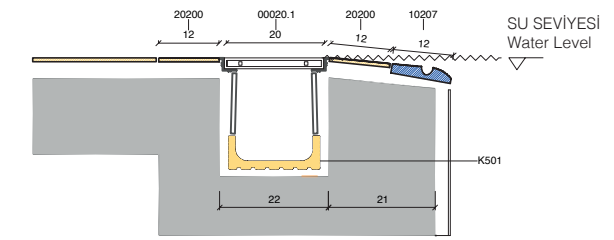
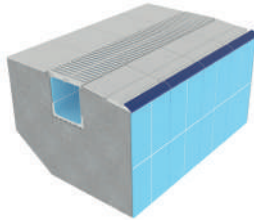
**K601**

Detay 20 / Detail 20

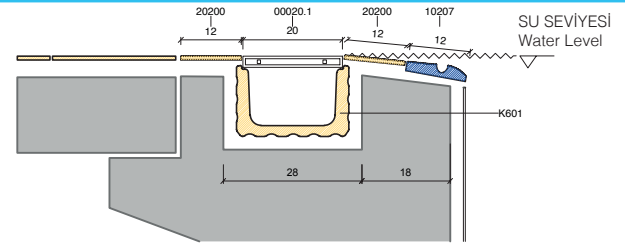
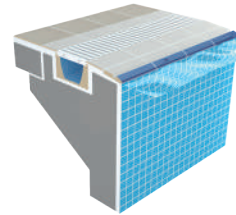
**KP101**

Detay 21 / Detail 21

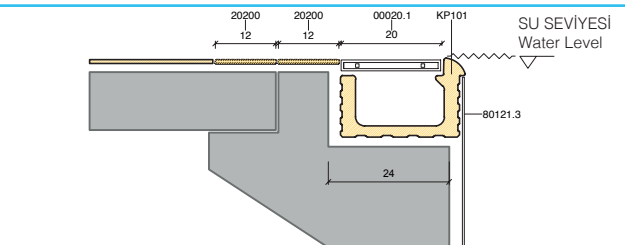
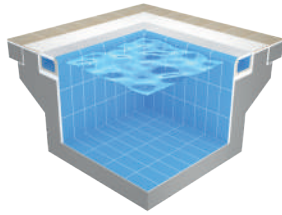
**KP201**

Detay 22 / Detail 22

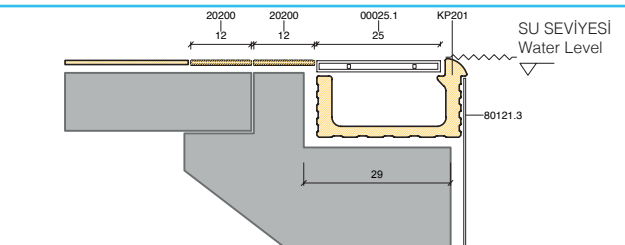
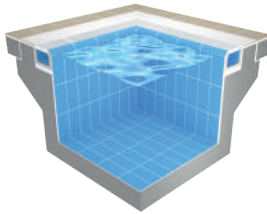
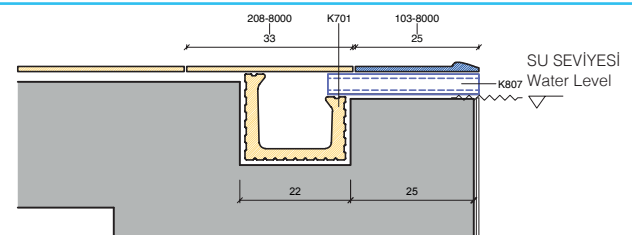
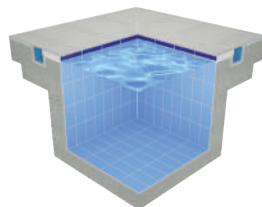

**Tünel Sistem Detayı**  
 Tunnel System Detail



## Merdiven Kaymazları ve Bükeyler

Antislip Stairs and Angled Parts

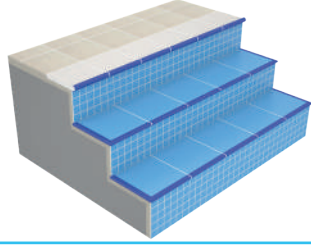
Merdiven Detayı  
Stairs Detail



Bükey Parçalar Detayı  
Angled Part Details

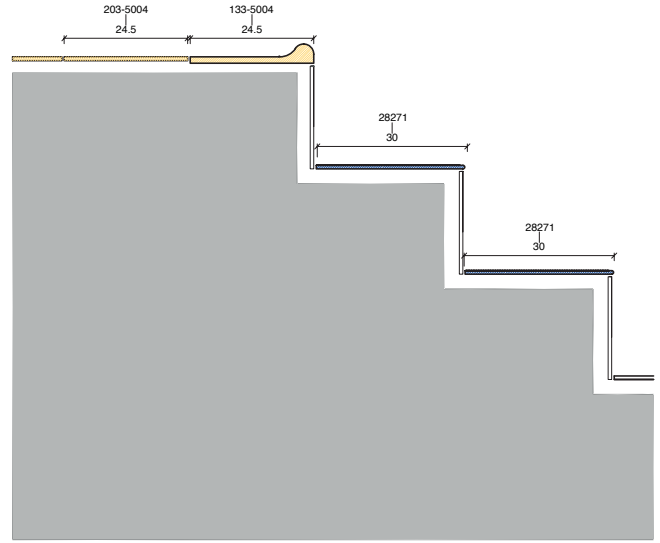
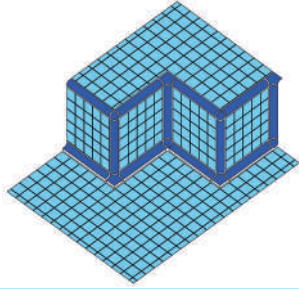





**Tutamak, Kaymaz ve Köşeleri**  
Handles, Antislips and Corners



## Çizgili Tutamak, Kaymaz ve Köşeleri

Striped Handles, Antislips and Corners

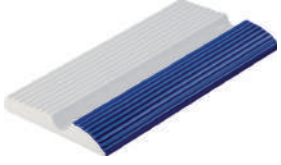

**C150-107** (12,5 x 25 cm)  
Çizgili Tutamak (Kobalt - Sırsız)  
Striped Handle (Cobalt - Unglazed)

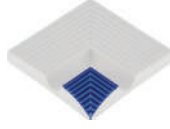

**C150-307** (12,5 x 12,5 cm)  
Çizgili tutamak İç Köşesi (Kobalt - Sırsız)  
Striped Handle Internal Corner (Cobalt - Unglazed)

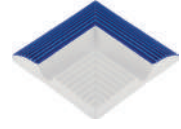

**C150-407** (12,5 x 12,5 cm)  
Çizgili tutamak Dış Köşesi (Kobalt - Sırsız)  
Striped Handle External Corner  
(Cobalt - Unglazed)



**17107** (25 x 25 cm)  
Çizgili Tutamak (Kobalt - Sırsız)  
Striped Handle (Cobalt - Unglazed)



**17107 İK** (25 x 25 cm)  
Çizgili Tutamak İç Köşe (Kobalt - Sırsız)  
Striped Handle Internal Corner (Cobalt - Unglazed)

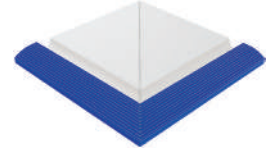

**17107 DK** (25 x 25 cm)  
Çizgili Tutamak Dış Köşe (Kobalt - Sırsız)  
Striped Handle External Corner  
(Cobalt - Unglazed)



**C250-100** (12,5 x 25 cm)  
Çizgili Kaymaz (Sırsız)  
Striped Antislip Tile (Unglazed)



**C250-500** (12,5 x 12,5 cm)  
Çizgili Kaymaz Köşesi (Sırsız)  
Striped Antislip Corner (Unglazed)

## Pavrimento Tutamak, Kaymaz ve Köşeleri

Pavrimento Handles, Antislips and Corners



**1023-0207** (8 x 25 cm)  
Pavrimento Tutamak (Kobalt)  
Pavrimento Handle (Cobalt)



**1023-0200** (8 x 25 cm)  
Pavrimento Tutamak (Sırsız)  
Pavrimento Handle (Unglazed)

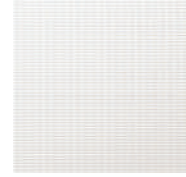

**25200** (25 x 25 cm)  
Pötikare Pavrimento Kaymaz – L (Sırsız)  
Petit Carre Pavrimento Antislip – L (Unglazed)



**20200** (12,5 x 25 cm)  
Pötikare Kaymaz (Sırsız)  
Petit Carre Antislip Tile (Unglazed)



**50200** (12,5 x 12,5 cm)  
Pötikare Kaymaz Köşe (Sırsız)  
Petit Carre Antislip Tile Corner (Unglazed)



**25200 K** (25 x 25 cm)  
Pötikare Pavrimento Kaymaz Köşe – L (Sırsız)  
Petit Carre Pavrimento Antislip Corner – L  
(Unglazed)

**Pötikare Tutamak, Kaymaz ve Köşeleri**

## Petit Carre Handles, Antislips and Corners



**10200** (12,5 x 25 cm)  
Pötikare Tutamak (Sırsız)  
Petit Carre Handle (Unglazed)



**10210** (12,5 x 25 cm)  
Pötikare Oluklu Tutamak (Sırsız)  
Petit Carre Handle (Unglazed)



**30200** (12,5 x 12,5 cm)  
Pötikare Tutamak İç Köşe (Sırsız)  
Petit Carre Handle  
Internal Corner (Unglazed)



**40200** (12,5 x 12,5 cm)  
Pötikare Tutamak Dış Köşe (Sırsız)  
Petit Carre Handle  
External Corner (Unglazed)



**10201** (12,5 x 25 cm)  
Pötikare Tutamak (Açık Mavi - Sırsız)  
Petit Carre Handle  
(Light Blue - Unglazed)



**10211** (12,5 x 25 cm)  
Pötikare Oluklu Tutamak (Açık Mavi - Sırsız)  
Petit Carre Handle With Outlet  
(Light Blue - Unglazed)

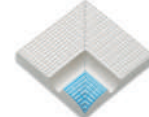

**30201** (12,5 x 12,5 cm)  
Pötikare Tutamak İç Köşe (Açık Mavi - Sırsız)  
Petit Carre Handle  
Internal Corner (Light Blue - Unglazed)

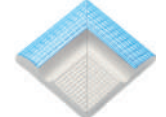

**40201** (12,5 x 12,5 cm)  
Pötikare Tutamak Dış Köşe  
(Açık Mavi - Sırsız)  
Petit Carre Handle  
External Corner (Light Blue - Ungl.)



**10207** (12,5 x 25 cm)  
Pötikare Tutamak (Kobalt - Sırsız)  
Petit Carre Handle (Cobalt - Ungl.)



**10217** (12,5 x 25 cm)  
Pötikare Oluklu Tutamak (Kobalt - Sırsız)  
Petit Carre Handle With Outlet  
(Cobalt - Unglazed)

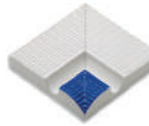

**30207** (12,5 x 12,5 cm)  
Pötikare Tutamak İç Köşe (Kobalt - Sırsız)  
Petit Carre Handle Internal Corner  
(Cobalt - Unglazed)

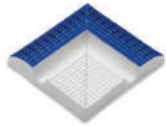

**40207** (12,5 x 12,5 cm)  
Pötikare Tutamak Dış Köşe  
(Kobalt - Sırsız)  
Petit Carre Handle External Corner  
(Cobalt - Unglazed)



**10237-2** (12,5 x 25 cm)  
Pötikare Tutamak  
Bitiş Parçası - Sağ (Kobalt - Sırsız)  
Petit Carre Handle  
End Part - Right (Cobalt - Ungl.)



**10237-1** (12,5 x 25 cm)  
Pötikare Tutamak Bitiş Parçası - Sol  
(Kobalt - Sırsız)  
Petit Carre Handle End Part - Left  
(Cobalt - Unglazed)



**10231-2** (12,5 x 25 cm)  
Pötikare Tutamak Bitiş Parçası - Sağ  
(Açık Mavi - Sırsız)  
Petit Carre Handle End Part - Right  
(Light Blue - Unglazed)



**10231-1** (12,5 x 25 cm)  
Pötikare Tutamak Bitiş Parçası - Sol  
(Açık Mavi - Sırsız)  
Petit Carre Handle End Part - Left  
(Light Blue - Unglazed)



**20201** (12,5 x 25 cm)  
Pötikare Kaymaz (Açık Mavi)  
Petit Carre Antislip (Light Blue)



**20207** (12,5 x 25 cm)  
Pötikare Kaymaz (Kobalt)  
Petit Carre Antislip (Cobalt)

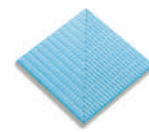

**50201** (12,5 x 12,5 cm)  
Pötikare Kaymaz Köşe (Açık Mavi)  
Petit Carre Antislip Corner (Light Blue)



**50207** (12,5 x 12,5 cm)  
Pötikare Kaymaz Köşe (Kobalt)  
Petit Carre Antislip Corner (Cobalt)



## Pötikare Profilli Tutamak, Kaymaz ve Köşeleri

### Petit Carre Profiled Handles, Antislips Tile and Corners



**10227** (12,5 x 25 cm)  
Pötikare Profilli Tutamak (Kobalt - Sırsız)  
Petit Carre Profiled Handle (Cobalt - Unglazed)

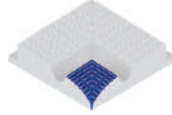

**30227** (12,5 x 12,5 cm)  
Pötikare Profilli Tutamak İç Köşe (Kobalt - Sırsız)  
Petit Carre Profiled Handle Internal Corner  
(Cobalt - Unglazed)

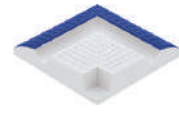

**40227** (12,5 x 12,5 cm)  
Pötikare Profilli Tutamak Dış Köşe  
(Kobalt - Sırsız)  
Petit Carre Profiled Handle External Corner  
(Cobalt - Unglazed)



**20220** (12,5 x 25 cm)  
Pötikare Profilli Kaymaz (Sırsız)  
Petit Carre Profiled Antislip (Unglazed)



**50220.3** (12,5 x 12,5 cm)  
Pötikare Profilli Kaymaz İç Köşe (Sırsız)  
Petit Carre Profiled Antislip  
Internal Corner (Unglazed)



**50220.4** (12,5 x 12,5 cm)  
Pötikare Profilli Kaymaz Dış Köşe (Sırsız)  
Petit Carre Profiled Antislip  
External Corner (Unglazed)



**202-2030** (12,5 x 25 cm)  
Pötikare Çift Profilli Kaymaz (Sırsız)  
Petit Carre Double Profiled  
Antislip (Unglazed)



**202-2030 K** (12,5 x 12,5 cm)  
Pötikare Çift Profilli Kaymaz Köşe (Sırsız)  
Petit Carre Double Profiled  
Antislip Corner (Unglazed)

\* Ürün ölçüsüne yaklaşık 2 cm profil boyu ilave edilecektir. / For profile handles, 2 cm profile length should be considered separately.

## Pötikare Setli Tutamak ve Köşeleri

### Petit Carre Ridged Handles and Corners

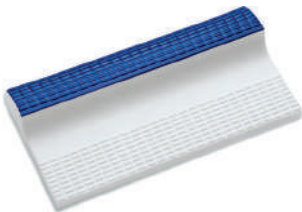

**11207** (12,5 x 25 cm)  
Pötikare Setli Tutamak (Kobalt - Sırsız)  
Petit Carre Ridged Handle (Cobalt - Unglazed)

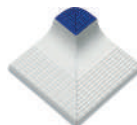

**31207** (12,5 x 12,5 cm)  
Pötikare Setli Tutamak İç Köşe (Kobalt - Sırsız)  
Petit Carre Ridged Handle  
Internal Corner (Cobalt - Unglazed)

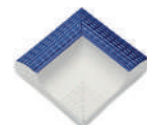

**41207** (12,5 x 12,5 cm)  
Pötikare Setli Tutamak Dış Köşe (Kobalt - Sırsız)  
Petit Carre Ridged Handle  
External Corner (Cobalt - Unglazed)

## Pötikare Tutamak, Kaymaz ve Köşeleri

### Petit Carre Handles, Antislips and Corners



**17207** (25 x 25 cm)  
Pötikare Tutamak – L (Kobalt - Sırsız)  
Petit Carre Handle – L  
(Cobalt - Unglazed)

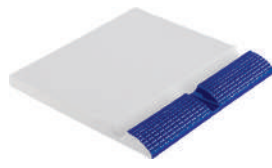

**17217** (25 x 25 cm)  
Pötikare Oluklu Tutamak – L (Kobalt - Sırsız)  
Petit Carre Handle With Outlet – L  
(Cobalt - Unglazed)

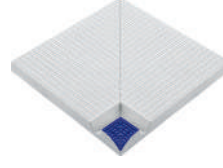

**37207** (25 x 25 cm)  
Pötikare Tutamak İç Köşe – L (Kobalt - Sırsız)  
Petit Carre Handle  
Internal Corner – L (Cobalt - Unglazed)

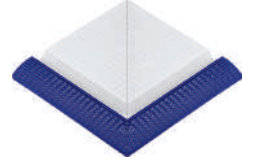

**47207** (25 x 25 cm)  
Pötikare Tutamak Dış Köşe – L  
(Kobalt - Sırsız)  
Petit Carre Handle  
External Corner – L (Cobalt - Unglazed)



**17200** (25 x 25 cm)  
Pötikare Tutamak – L (Sırsız)  
Petit Carre Handle – L (Unglazed)



**17210** (25 x 25 cm)  
Pötikare Oluklu Tutamak – L (Sırsız)  
Petit Carre Handle  
With Outlet – L (Unglazed)

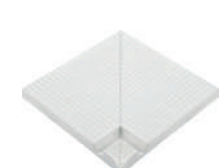

**37200** (25 x 25 cm)  
Pötikare Tutamak İç Köşe – L (Sırsız)  
Petit Carre Handle  
Internal Corner – L (Unglazed)



**47200** (25 x 25 cm)  
Pötikare Tutamak Dış Köşe – L (Sırsız)  
Petit Carre Handle  
External Corner – L (Ungazed)

## Pötikare Profilli Tutamak, Kaymaz ve Köşeleri

### Petit Carre Profiled Handles, Antislips and Corners



**17227** (25 x 25 cm)  
Pötikare Profilli Tutamak – L  
(Kobalt - Sırsız)  
Petit Carre Profiled Handle – L  
(Cobalt - Unglazed)

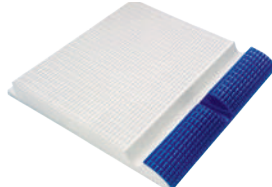

**17237** (25 x 25 cm)  
Pötikare Profilli Oluklu Tutamak - L  
(Kobalt - Sırsız)  
Petit Carre Profiled Handle  
With Outlet – L (Cobalt - Unglazed)



**37227** (25 x 25 cm)  
Pötikare Profilli Tutamak İç Köşe – L  
(Kobalt - Sırsız)  
Petit Carre Profiled Handle Internal  
Corner – L (Cobalt - Unglazed)

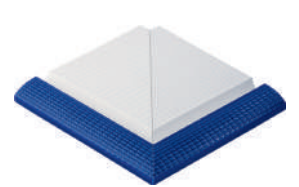

**47227** (25 x 25 cm)  
Pötikare Profilli Tutamak Dış Köşe  
(Kobalt - Sırsız)  
Petit Carre Profiled Handle External  
Corner (Cobalt - Unglazed)

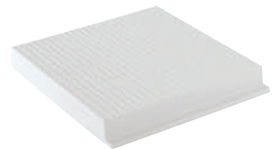

**203-2020** (25 x 25 cm)  
Pötikare Profilli Kaymaz – L  
(Sırsız)  
Petit Carre Profiled Antislip – L  
(Unglazed)



**203-2020 İK** (25+25 x 25+25 cm)  
Pötikare Profilli Kaymaz İç Köşe – L  
(Sırsız)  
Petit Carre Profiled Antislip  
Internal Corner – L (Unglazed)



**203-2020 DK** (25 x 25 cm)  
Pötikare Profilli Kaymaz Dış Köşe – L (Sırsız)  
Petit Carre Profiled Antislip  
External Corner – L (Unglazed)



**203-2030** (25 x 25 cm)  
Pötikare Çift Profilli Kaymaz – L  
(Sırsız)  
Petit Carre Double Profiled  
Antislip Tile – L (Unglazed)



**203-2030 K** (25+25 x 25+25 cm)  
Pötikare Çift Profilli Kaymaz - L Köşe (Sırsız)  
Petit Carre Double Profiled  
Antislip Tile – L Corner (Unglazed)

\* Bu ürünlerin 24,5 cm olan ön-arka kenarlarında boyut kalibrasyonu yapılmamaktadır. / Calibration is not possible for 24,5 cm front and rear sides of products.

\* Ürün ölçüsüne yaklaşık 2 cm profil boyu ilave edilecektir. / For profile handles, 2 cm profile length should be considered separately.

## Pötikare Profilli Tutamak ve Köşeleri

### Petit Carre Profiled Handles and Corners

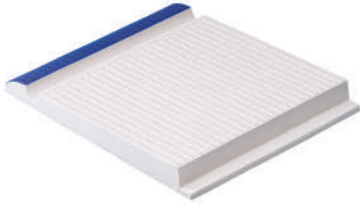

**104-2027** (30 x 25 cm)  
Pötikare Profilli Tutamak (Kobalt - Sırsız)  
Petit Carre Profiled Handle (Cobalt - Unglazed)

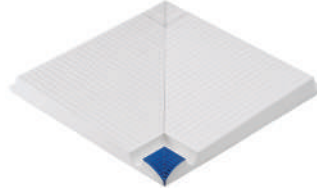

**104-2027 İK** (30 x 30 cm)  
Pötikare Profilli Tutamak İç Köşe (Kobalt - Sırsız)  
Petit Carre Profiled Handle Internal Corner  
(Cobalt - Unglazed)



**104-2027 DK** (18,8+25 x 18,8+25 cm)  
Pötikare Profilli Tutamak  
Dış Köşe (Kobalt - Sırsız)  
Petit Carre Profiled Handle  
External Corner (Cobalt - Unglazed)

\* Bu ürünlerin 24,5 cm olan kenarlarında boyut kalibrasyonu yapılmamaktadır. / Calibration is not possible for 24,5 cm sides of products.

\* Ürün ölçüsüne yaklaşık 2 cm profil boyu ilave edilecektir. / For profile handles, 2 cm profile length should be considered separately.

## Esnek Boyut Pötikare Tutamak ve Köşeleri

### Adjustable Petit Carre Handles and Corners



**104-2007** (30 x 25 cm)  
Esnek Boyut Pötikare Tutamak (Kobalt - Sırsız)  
Adjustable Petit Carre Handle  
(Cobalt - Unglazed)



**104-2007 İK** (30 x 30 cm)  
Esnek Boyut Pötikare Tutamak  
İç Köşe (Kobalt - Sırsız)  
Adjustable Petit Carre Handle  
Internal Corner (Cobalt - Unglazed)

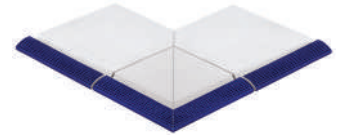

**104-2007 DK** (24+25 x 24+25 cm)  
Esnek Boyut Pötikare Tutamak  
Dış Köşe (Kobalt - Sırsız)  
Adjustable Petit Carre Handle  
External Corner (Cobalt - Unglazed)

\* Bu ürünlerin 24,5 cm olan kenarlarında boyut kalibrasyonu yapılmamaktadır. / Calibration is not possible for 24,5 cm sides of products.

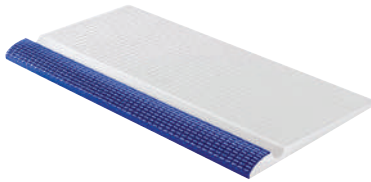

**106-2007** (25 x 50 cm)  
Esnek Boyut Pötikare Tutamak (Kobalt - Sırsız)  
Adjustable Petit Carre Handle  
(Cobalt - Unglazed)

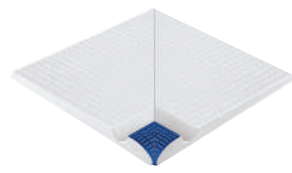

**106-2007 İK** (25 x 25 cm)  
Esnek Boyut Pötikare Tutamak  
İç Köşe (Kobalt - Sırsız)  
Adjustable Petit Carre Handle  
Internal Corner (Cobalt - Unglazed)

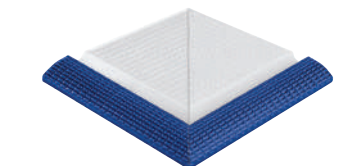

**106-2007 DK** (25 x 25 cm)  
Esnek Boyut Pötikare Tutamak  
Dış Köşe (Kobalt - Sırsız)  
Adjustable Petit Carre Handle  
External Corner (Cobalt - Unglazed)

## Olimpik Pötikare Tutamak ve Köşeleri

### Olympic Petit Carre Handles and Corners

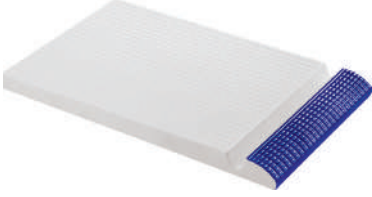

**105-2007** (38 x 25 cm)  
Olimpik Pötikare Tutamak (Kobalt - Sırsız)  
Olympic Petit Carre Handle (Cobalt - Unglazed)



**105-2007 İK** (38 x 38 cm)  
Olimpik Pötikare Tutamak İç Köşe (Kobalt - Sırsız)  
Olympic Petit Carre Handle Internal Corner  
(Cobalt - Unglazed)



**105-2007 DK** (25+25 x 25+25 cm)  
Olimpik Pötikare Tutamak  
Dış Köşe (Kobalt - Sırsız)  
Olympic Petit Carre Handle  
External Corner (Cobalt - Unglazed)

\* Bu ürünlerin 24,5 cm olan kenarlarında boyut kalibrasyonu yapılmamaktadır. / Calibration is not possible for 24,5 cm sides of products.

## Olimpik Pötikare Profilli Tutamak ve Köşeleri

### Olympic Petit Carre Profiled Handles and Corners



**105-2027** (38 x 25 cm)  
Olimpik Pötikare Profilli Tutamak  
(Kobalt - Sırsız)  
Olympic Petit Carre  
Profiled Handle (Cobalt - Unglazed)



**105-2027 İK** (38 x 38 cm)  
Olimpik Pötikare Profilli Tutamak  
İç Köşe (Kobalt - Sırsız)  
Olympic Petit Carre Profiled  
Handle Internal Corner (Cobalt - Unglazed)



**105-2027 DK** (25+25 x 25+25 cm)  
Olimpik Pötikare Profilli Tutamak  
Dış Köşe (Kobalt - Sırsız)  
Olympic Petit Carre Profiled  
Handle External Corner (Cobalt - Un-  
glazed)

\* Bu ürünlerin 24,5 cm olan kenarlarında boyut kalibrasyonu yapılmamaktadır. / Calibration is not possible for 24,5 cm sides of products.

\* Ürün ölçüsüne yaklaşık 2 cm profil boyu ilave edilecektir. / For profile handles, 2 cm profile length should be considered separately.

## Elegant XL Profilli Tutamak ve Köşeleri

### Elegant Profiled Handles - XL and Corners



**106-6027** (25 x 50 cm)  
Elegant Profilli Tutamak - XL (Kobalt - Sırsız)  
Elegant Profiled Handle - XL (Cobalt - Unglazed)



**106-6027 İK** (25 x 25 cm)  
Elegant Profilli Tutamak İç Köşe - XL (Kobalt - Sırsız)  
Elegant Profiled Handle Internal Corner - XL (Cobalt  
- Unglazed)



**106-6027 DK** (25+50 x 25+50 cm)  
Elegant Profilli Tutamak  
Dış Köşe - XL (Kobalt - Sırsız)  
Elegant Profiled Handle  
External Corner - XL (Cobalt - Unglazed)

\* Ürün ölçüsüne yaklaşık 2 cm profil boyu ilave edilecektir. / For profile handles, 2 cm profile length should be considered separately.

## Elegant XL Profilli Kaymaz ve Köşeleri

Elegant Profiled Antislip Tiles - XL and Corners



**206-6020** (25 x 50 cm)  
Elegant Profilli Kaymaz - XL (Sırsız)  
Elegant Profiled Antislip - XL (Unglazed)



**206-6020 İK** (25+50 x 25+50 cm)  
Elegant Profilli Kaymaz - XL İç Köşe (Sırsız)  
Elegant Profiled Antislip - XL  
Internal Corner (Unglazed)



**206-6020 DK** (25 x 25 cm)  
Elegant Profilli Kaymaz - XL Dış Köşe (Sırsız)  
Elegant Profiled Antislip - XL External Corner  
(Unglazed)

\* Ürün ölçüsüne yaklaşık 2 cm profil boyu ilave edilecektir. / For profile handles, 2 cm profile length should be considered separately.

## Pötikare Tutamak Üzeri Rakam Yazıları

Depth Marking on the Petit Carre Handles



**17207-270** (25 x 25 cm)  
Pötikare Tutamak Üzeri Rakam Yazısı  
Depth Marking on Petit Carre Handle



**17227-270** (25 x 25 cm)  
Pötikare Profilli Tutamak Üzeri Rakam Yazısı  
Depth Marking on Petit Carre Profiled Handle



**104-2007-270** (30 x 25 cm)  
Pötikare Esnek Boyut Tutamak Üzeri Rakam Yazısı  
Depth Marking on Adjustable Petit Carre Handle



**104-2027-270** (30 x 25 cm)  
Pötikare Profilli Tutamak Üzeri Rakam Yazısı  
Depth Marking on Petit Carre Profiled Handle



**105-2007-270** (38 x 25 cm)  
Olimpik Pötikare Tutamak Üzeri Rakam Yazısı  
Depth Marking on Olympic Petit Carre Handle



**105-2027-270** (38 x 25 cm)  
Olimpik Pötikare Profilli Tutamak Üzeri Rakam Yazısı  
Depth Marking on Olympic Petit Carre Profiled Handle

Rakam yazılarında kobalt rengin yansımından dolayı ton farkı olabilir. Ürün üzerine talep edilen rakam yazısı yazılabilir.  
There may be colour tone different due to the reflection feature of cobalt colour. Any kind figure can be written on the handle.



## Pötikare Açılı Tutamak

Petit Carre Angled Handle



**11427** (12,5 x 14,5 x 25 cm)  
Pötikare Açılı Tutamak (Kobalt - Sırsız)  
Petit Carre Angled Handle  
(Cobalt - Unglazed)

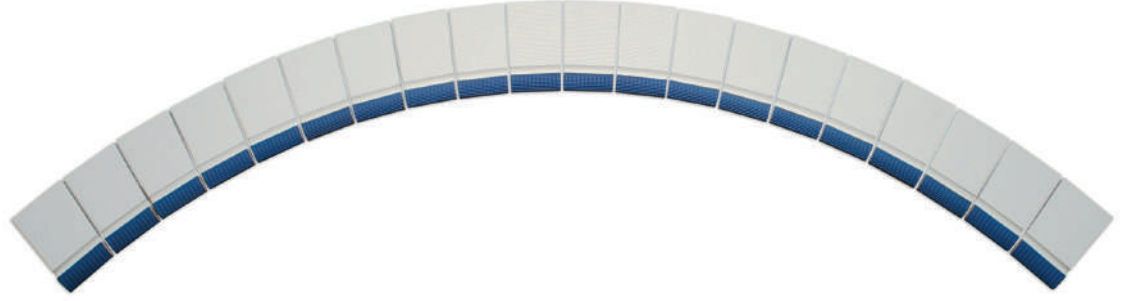

Yaklaşık 3 m çap / Diameters is about 3 meters

## Pötikare Puzzle Tutamaklar

Petit Carre Puzzle Handle

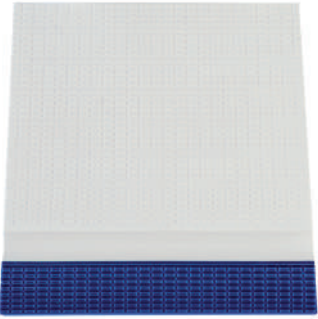

**11527** (25 x 23 cm)  
Pötikare Puzzle Tutamak (Dışa Dönüş)(Kobalt - Sırsız)  
Petit Carre Puzzle Handle (Handle Turn Out) (Cobalt - Unglazed)



**11627** (23 x 25 cm)  
Pötikare Puzzle Tutamak (İç Dönüş)(Kobalt - Sırsız)  
Petit Carre Puzzle Handle (Handle Turn Into)(Cobalt - Unglazed)

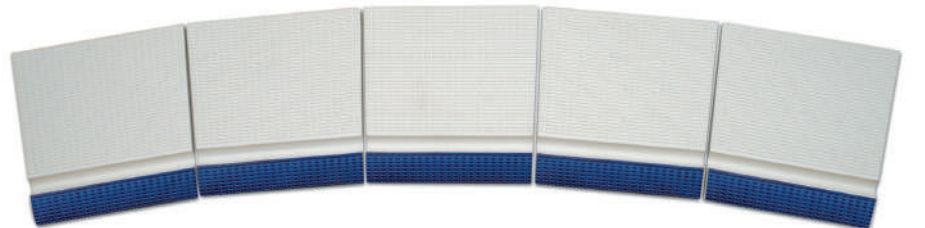

## Ali Bey Pötikare Tutamak ve Köşeleri

Ali Bey Petit Carre Handles and Corners

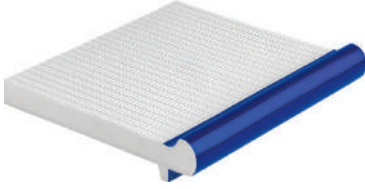

\*143-2007 (25 x 25 cm)  
Ali Bey Pötikare Tutamak (Kobalt - Sırsız)  
Ali Bey Petit Carre Handle (Cobalt - Unglazed)



143-2007 İK (25 x 25 cm)  
Ali Bey Pötikare Tutamak  
İç Köşe (Kobalt - Sırsız)  
Ali Bey Petit Carre Handle  
Internal Corner (Cobalt - Unglazed)

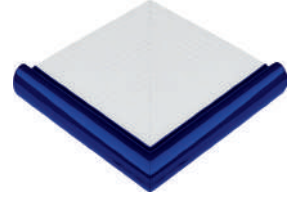

143-2007 DK (25 x 25 cm)  
Ali Bey Pötikare Tutamak  
Dış Köşe (Kobalt - Sırsız)  
Ali Bey Petit Carre Handle  
External Corner  
(Cobalt - Unglazed)

## Pietra Pötikare Tutamak ve Köşeleri

Pietra Petit Carre Handles and Corners



\*133-2007 (25 x 25 cm)  
Pietra Pötikare Tutamak (Kobalt - Sırsız)  
Pietra Petit Carre Handle (Cobalt - Unglazed)



133-2007 İK (25 x 25 cm)  
Pietra Pötikare Tutamak  
İç Köşe (Kobalt - Sırsız)  
Pietra Petit Carre Handle  
Internal Corner (Cobalt - Unglazed)



133-2007 DK (25 x 25 cm)  
Pietra Pötikare Tutamak  
Dış Köşe (Kobalt - Sırsız)  
Pietra Petit Carre Handle  
External Corner (Cobalt - Ungl.)

## Pietra Rölyef Tutamak, Kaymaz ve Köşeleri

Pietra Relief Antislip Handles and Corners



\*133-5004 (25 x 25 cm)  
Pietra Rölyef Tutamak (Kotto)  
Pietra Relief Handle (Cotto)



\*203-5004 (25 x 25 cm)  
Pietra Rölyef Kaymaz (Kotto)  
Pietra Relief Antislip Tile (Cotto)

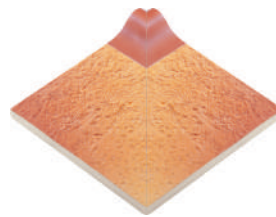

133-5004 İK (25 x 25 cm)  
Pietra Rölyef Tutamak  
İç Köşe (Kotto)  
Pietra Relief Handle  
Internal Corner (Cotto)

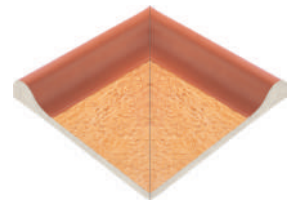

133-5004 DK (25 x 25 cm)  
Pietra Rölyef Tutamak  
Dış Köşe (Kotto)  
Pietra Relief Handle  
External Corner (Cotto)







## Apache Linear Tutamak ve Köşeleri

### Apache Linear Handles and Corners



**103-8000** (25 x 25 cm)  
Apache Linear Tutamak (Sırsız)  
Apache Linear Handle (Unglazed)



**103-8000 İK** (25 x 25 cm)  
Apache Linear Tutamak İç Köşe (Sırsız)  
Apache Linear Handle  
Internal Corner (Unglazed)



**103-8000 DK** (25 x 25 cm)  
Apache Linear Tutamak Dış Köşe (Sırsız)  
Apache Linear Handle External Corner (Unglazed)

## Apache Tutamak ve Köşeleri

### Apache Handles and Corners



**122-8000** (25 x 25 cm)  
Apache Tutamak (Sırsız)  
Apache Handle (Unglazed)

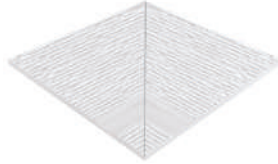

**122-8000 İK** (25 x 25 cm)  
Apache Tutamak İç Köşe (Sırsız)  
Apache Handle Internal Corner (Unglazed)



**122-8000 DK** (25 x 25 cm)  
Apache Tutamak Dış Köşe (Sırsız)  
Apache Handle External Corner (Unglazed)



**106-8000** (25 x 50 cm)  
Apache Tutamak (Sırsız)  
Apache Handle (Unglazed)

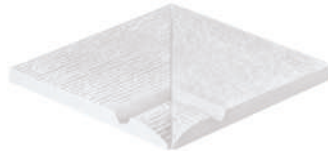

**106-8000 İK** (25 x 25 cm)  
Apache Tutamak İç Köşe (Sırsız)  
Apache Handle Internal Corner (Unglazed)



**106-8000 DK** (25 x 25 cm)  
Apache Tutamak Dış Köşe (Sırsız)  
Apache Handle External Corner (Unglazed)



**106-8007** (25 x 50 cm)  
Apache Tutamak (Kobalt - Sırsız)  
Apache Handle (Cobalt - Unglazed)

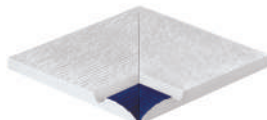

**106-8007 İK** (25 x 25 cm)  
Apache Tutamak İç Köşe (Kobalt - Sırsız)  
Apache Handle Internal Corner  
(Cobalt - Unglazed)

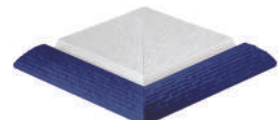

**106-8007 DK** (25 x 25 cm)  
Apache Tutamak Dış Köşe (Kobalt - Sırsız)  
Apache Handle External Corner  
(Cobalt - Unglazed)

## Apache Tutamak ve Köşeleri

### Apache Handles and Corners

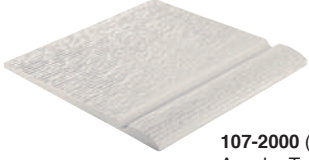

**107-2000** (33 x 33 cm)  
Apache Tutamak (Sırsız)  
Apache Handle (Unglazed)

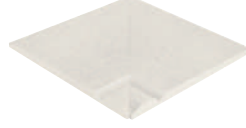

**107-2000 İK** (33 x 33 cm)  
Apache Tutamak İç Köşe (Sırsız)  
Apache Handle Internal Corner (Unglazed)



**107-2000 DK** (33 x 33 cm)  
Apache Tutamak Dış Köşe (Sırsız)  
Apache Handle External Corner (Unglazed)

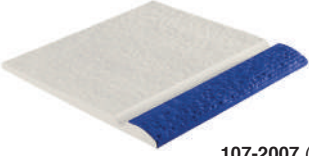

**107-2007** (33 x 33 cm)  
Apache Tutamak (Kobalt - Sırsız)  
Apache Handle (Cobalt - Unglazed)

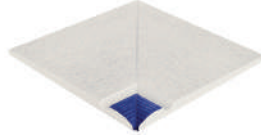

**107-2007 İK** (33 x 33 cm)  
Apache Tutamak İç Köşe (Kobalt - Sırsız)  
Apache Handle Internal Corner  
(Cobalt - Unglazed)

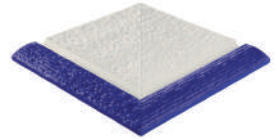

**107-2007 DK** (33 x 33 cm)  
Apache Tutamak Dış Köşe (Kobalt - Sırsız)  
Apache Handle External Corner  
(Cobalt - Unglazed)

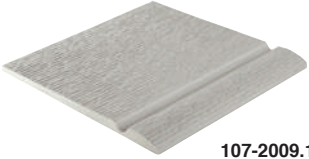

**107-2009.1** (33 x 33 cm)  
Apache Tutamak (Gri)  
Apache Handle (Grey)

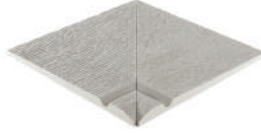

**107-2009.1 İK** (33 x 33 cm)  
Apache Tutamak İç Köşe (Gri)  
Apache Handle Internal Corner (Grey)

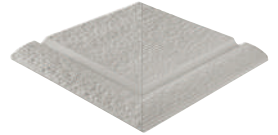

**107-2009.1 DK** (33 x 33 cm)  
Apache Tutamak Dış Köşe (Gri)  
Apache Handle External Corner (Grey)

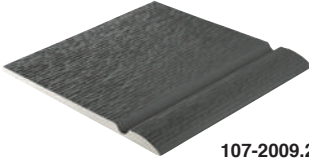

**107-2009.2** (33 x 33 cm)  
Apache Tutamak (Antrasit Gri)  
Apache Handle (Anthracite Grey)

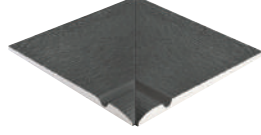

**107-2009.2 İK** (33 x 33 cm)  
Apache Tutamak İç Köşe (Antrasit Gri)  
Apache Handle Internal Corner (Anthracite Grey)

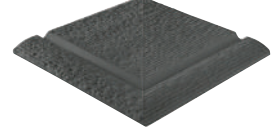

**107-2009.2 DK** (33 x 33 cm)  
Apache Tutamak Dış Köşe (Antrasit Gri)  
Apache Handle External Corner  
(Anthracite Grey)



**\*107-2001** (33 x 33 cm)  
Apache Tutamak (Mavi)  
Apache Handle (Blue)

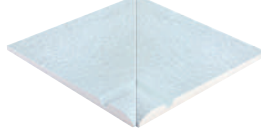

**\*107-2001 İK** (33 x 33 cm)  
Apache Tutamak İç Köşe (Mavi)  
Apache Handle Internal Corner (Blue)



**\*107-2001 DK** (33 x 33 cm)  
Apache Tutamak Dış Köşe (Mavi)  
Apache Handle External Corner (Blue)

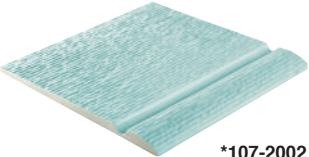

**\*107-2002** (33 x 33 cm)  
Apache Tutamak (Turkuaz)  
Apache Handle (Turquoise)

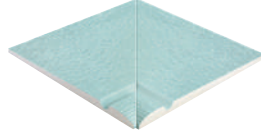

**\*107-2002 İK** (33 x 33 cm)  
Apache Tutamak İç Köşe (Turkuaz)  
Apache Handle Internal Corner (Turquoise)

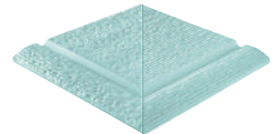

**\*107-2002 DK** (33 x 33 cm)  
Apache Tutamak Dış Köşe (Turkuaz)  
Apache Handle External Corner (Turquoise)

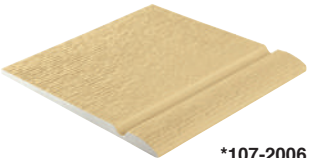

**\*107-2006** (33 x 33 cm)  
Apache Tutamak (Sarı)  
Apache Handle (Yellow)

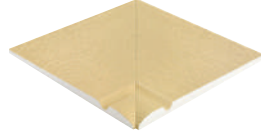

**\*107-2006 İK** (33 x 33 cm)  
Apache Tutamak İç Köşe (Sarı)  
Apache Handle Internal Corner (Yellow)



**\*107-2006 DK** (33 x 33 cm)  
Apache Tutamak Dış Köşe (Sarı)  
Apache Handle External Corner (Yellow)

## Apache Tutamak Uç

Apache Handle



**1024-0200** (9 x 50 cm)  
Apache Tutamak Uç (Sırsız)  
Apache Handle Piece (Unglazed)



**1024-0207** (9 x 50 cm)  
Apache Tutamak Uç (Kobalt)  
Apache Handle Piece (Cobalt)

## Natural Tutamak Uç

Natural Handle Peice



**1018-1004** (9 x 50 cm)  
Natural Tutamak Uç (Kotto)  
Natural Handle Piece (Cotto)



**1018-1009.1** (9 x 50 cm)  
Natural Tutamak Uç (Gri)  
Natural Handle Piece (Grey)



**1018-1008.2** (9 x 50 cm)  
Natural Tutamak Uç (Bej)  
Natural Handle Piece (Beige)



**1018-1007** (9 x 50 cm)  
Natural Tutamak Uç (Kobalt)  
Natural Handle Piece (Cobalt)

## Natural Wood Tutamak Uç

Natural Wood Handle Piece



**1019-1404** (9x45 cm)  
Natural Wood Tutamak Uç (Kotto)  
Natural Wood Handle Piece (Cotto)



**1019-1408.2** (9x45 cm)  
Natural Wood Tutamak Uç (Bej)  
Natural Wood Handle Piece (Beige)





**SERA**  
**POOL**

**Pötikare Pahlı Merdiven Kaymazı ve Köşeleri**  
Petit Carre Rounded Side Antislip Stair Step Tile and Corners



## Pötikare Pahlı Kaymaz ve Köşeleri

### Petit Carre Rounded Side Stair Step Antislip Tile and Corners



**21200** (12,5 x 25 cm)  
Pötikare Pahlı Kaymaz (Sırsız)  
Petit Carre Rounded Side Stair Step  
Antislip Tile (Unglazed)



**21200 İK** (12,5 x 12,5 cm)  
Pötikare Pahlı Kaymaz İç Köşe (Sırsız)  
Petit Carre Rounded Side Stair Step Antislip  
Internal Corner (Unglazed)



**21200 DK** (12,5 x 12,5 cm)  
Pötikare Pahlı Kaymaz Dış Köşe (Sırsız)  
Petit Carre Rounded Side Stair Step Antislip  
External Corner (Unglazed)



**21221** (12,5 x 25 cm)  
Pötikare Pahlı Kaymaz (Açık Mavi)  
Petit Carre Rounded Side Stair Step  
Antislip Tile (Light Blue)

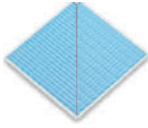

**21221 İK** (12,5 x 12,5 cm)  
Pötikare Pahlı Kaymaz İç Köşe (Açık Mavi)  
Petit Carre Rounded Side Stair Step Antislip  
Internal Corner (Light Blue)

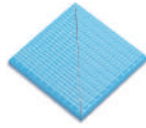

**21221 DK** (12,5 x 12,5 cm)  
Pötikare Pahlı Kaymaz Dış Köşe (Açık Mavi)  
Petit Carre Rounded Side Stair Step Antislip  
External Corner (Light Blue)



**21227** (12,5 x 25 cm)  
Pötikare Pahlı Kaymaz (Kobalt)  
Petit Carre Rounded Side Stair Step  
Antislip Tile (Cobalt)

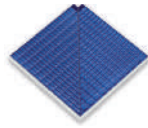

**21227 İK** (12,5 x 12,5 cm)  
Pötikare Pahlı Kaymaz İç Köşe (Kobalt)  
Petit Carre Rounded Side Stair Step Antislip  
Internal Corner (Cobalt)

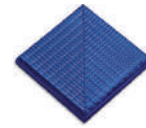

**21227 DK** (12,5 x 12,5 cm)  
Pötikare Pahlı Kaymaz Dış Köşe (Kobalt)  
Petit Carre Rounded Side Stair Step Antislip  
External Corner (Cobalt)



**21271** (12,5 x 25 cm)  
Pötikare Pahlı Kaymaz (Kobalt – Açık Mavi)  
Petit Carre Rounded Side Stair Step  
Antislip Tile (Cobalt - Light Blue)

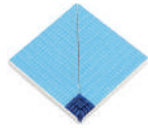

**21271 İK** (12,5 x 12,5 cm)  
Pötikare Pahlı Kaymaz İç Köşe (Kobalt – Açık Mavi)  
Petit Carre Rounded Side Stair Step Antislip  
Internal Corner (Cobalt - Light Blue)

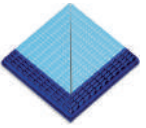

**21271 DK** (12,5 x 12,5 cm)  
Pötikare Pahlı Kaymaz Dış Köşe (Kobalt – Açık Mavi)  
Petit Carre Rounded Side Stair Step Antislip  
External Corner (Cobalt - Light Blue)

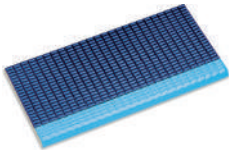

**21277** (12,5 x 25 cm)  
Pötikare Pahlı Kaymaz (Açık Mavi - Kobalt)  
Petit Carre Rounded Side Stair Step  
Antislip Tile (Light Blue - Cobalt)

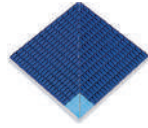

**21277 İK** (12,5 x 12,5 cm)  
Pötikare Pahlı Kaymaz İç Köşe (Açık Mavi - Kobalt)  
Petit Carre Rounded Side Stair Step Antislip  
Internal Corner (Light Blue - Cobalt)

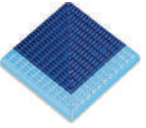

**21277 DK** (12,5 x 12,5 cm)  
Pötikare Pahlı Kaymaz Dış Köşe  
(Açık Mavi-Kobalt)  
Petit Carre Rounded Side Stair Step Antislip  
External Corner (Light Blue - Cobalt)



**21211** (12,5 x 25 cm)  
Pötikare Pahlı Kaymaz (Açık Mavi - Sırsız)  
Petit Carre Rounded Side Stair Step  
Antislip Tile (Light Blue - Unglazed)



**21211 İK** (12,5 x 12,5 cm)  
Pötikare Pahlı Kaymaz İç Köşe (Açık Mavi - Sırsız)  
Petit Carre Rounded Side Stair Step Antislip  
Internal Corner (Light Blue - Unglazed)

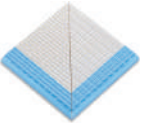

**21211 DK** (12,5 x 12,5 cm)  
Pötikare Pahlı Kaymaz Dış Köşe  
(Açık Mavi - Sırsız)  
Petit Carre Rounded Side Stair Step Antislip  
External Corner (Light Blue - Unglazed)



**21217** (12,5 x 25 cm)  
Pötikare Pahlı Kaymaz (Kobalt - Sırsız)  
Petit Carre Rounded Side Stair Step  
Antislip Tile (Cobalt - Unglazed)



**21217 İK** (12,5 x 12,5 cm)  
Pötikare Pahlı Kaymaz İç Köşe (Kobalt - Sırsız)  
Petit Carre Rounded Side Stair Step Antislip  
Internal Corner (Cobalt - Unglazed)

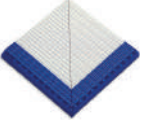

**21217 DK** (12,5 x 12,5 cm)  
Pötikare Pahlı Kaymaz Dış Köşe  
(Kobalt - Sırsız)  
Petit Carre Rounded Side Stair Step Antislip  
External Corner (Cobalt - Unglazed)

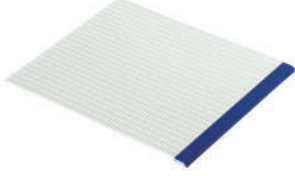
**Pötikare Merdiven Kaymazı ve Köşeleri****Petit Carre Antislip Stair Step Tile and Corners**

**28217** (25 x 30 cm)  
Pötikare Merdiven Kaymazı (Kobalt - Sırsız)  
Petit Carre Stair Step Antislip  
(Cobalt - Unglazed)



**28217 SAĞ** (30 x 30 cm)  
Pötikare Merdiven Kaymazı  
Bitiş Parçası - Sağ (Kobalt - Sırsız)  
Petit Carre Stair Step Antislip  
Ending Part – Right (Cobalt - Unglazed)

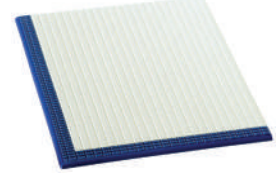

**28217 SOL** (30 x 30 cm)  
Pötikare Merdiven Kaymazı  
Bitiş Parçası - Sol (Kobalt - Sırsız)  
Petit Carre Stair Step Antislip  
Ending Part – Left (Cobalt - Unglazed)

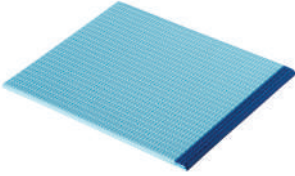

**28271** (25 x 30 cm)  
Pötikare Merdiven Kaymazı (Kobalt - Açık Mavi)  
Petit Carre Stair-Step Antislip  
(Cobalt - Light Blue)

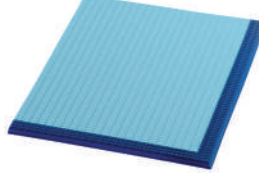

**28271 SAĞ** (30 x 30 cm)  
Pötikare Merdiven Kaymazı  
Bitiş Parçası – Sağ (Kobalt - Açık Mavi)  
Petit Carre Stair-Step Antislip  
Ending Part – Right (Cobalt - Light Blue)

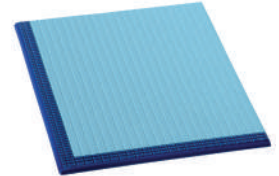

**28271 SOL** (30 x 30 cm)  
Pötikare Merdiven Kaymazı  
Bitiş Parçası – Sol (Kobalt - Açık Mavi)  
Petit Carre Stair-Step Antislip  
Ending Part – Left (Cobalt - Light Blue)

**Pötikare Merdiven Kaymazı ve Köşeleri - L****Petit Carre Antislip Stair Step Tile and Corners – L**

**207-2027** (30 x 30 cm)  
Pötikare Merdiven Kaymazı – L  
(Kobalt - Sırsız)  
Petit Carre Antislip Stair  
Step Tile – L (Cobalt - Unglazed)



**207-2027 İK** (30 x 30 cm)  
Pötikare Merdiven Kaymazı İç Köşe – L (Kobalt  
- Sırsız)  
Petit Carre Antislip Stair Step  
Internal Corner – L (Cobalt - Unglazed)

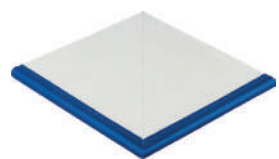

**207-2027 DK** (30 x 30 cm)  
Pötikare Merdiven Kaymazı Dış Köşe – L  
(Kobalt - Sırsız)  
Petit Carre Antislip Stair Step  
External Corner – L (Cobalt - Unglazed)

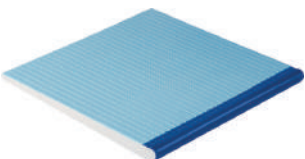

**217-2027** (30 x 30 cm)  
Pötikare Merdiven Kaymazı – L (Kobalt - Açık Mavi)  
Petit Carre Antislip Stair Step Tile – L  
(Cobalt - Light Blue)

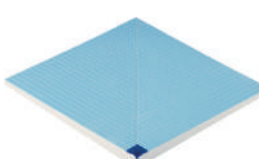

**217-2027 İK** (30 x 30 cm)  
Pötikare Merdiven Kaymazı İç Köşe – L (Kobalt  
- Açık Mavi)  
Petit Carre Antislip Stair Step Internal Corner – L  
(Cobalt - Light Blue)

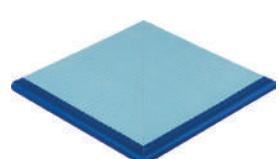

**217-2027 DK** (30 x 30 cm)  
Pötikare Merdiven Kaymazı Dış Köşe – L  
(Kobalt - Açık Mavi)  
Petit Carre Antislip Stair Step  
External Corner – L (Cobalt - Light Blue)



## Pötikare Kaymaz Üzerine Rakam Yazısı ve Oklar

Depth Marking and Warning Signs on the Petit Carre Antislip Tile



**22207** (12,5 x 25 cm)  
Pötikare Kobalt Kaymaz Üzeri Sırsız Rakam  
Unglazed Numbers and Inscriptions On Antislip Tile Cobalt Blue Petit Carre (Unglazed)



**24200** (12,5 x 25 cm)  
Pötikare Sırsız Kaymaz Üzeri Kobalt Ok  
Cobalt Blue Arrow On Antislip Tile Unglazed Petit Carre

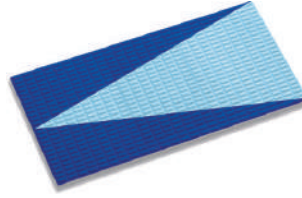

**23200** (12,5 x 25 cm)  
Pötikare Kobalt Kaymaz Üzeri Mavi Ok  
Blue Arrow On Petit Carre Antislip Tile Cobalt



**22270** (12,5 x 25 cm)  
Pötikare Sırsız Kaymaz Üzeri Kobalt Yazı  
Cobalt Blue Letter On Antislip Tile Unglazed Petit Carre (Cobalt)



**22200** (12,5 x 25 cm)  
Pötikare Sırsız Kaymaz Üzeri "Atlamayın" İşareti  
No Diving Sign On Unglazed Antislip Tile



**25-270** (25 cm)  
25'lik Izgara Arası Rakam Yazısı  
Number and Inscription Between 25 cm Grating



**20-270** (20 cm)  
20'lik Izgara Arası Rakam Yazısı  
Number and Inscription Between 20 cm Grating

## Merdiven Basamağı – Porselen

Porcelain Stair Step

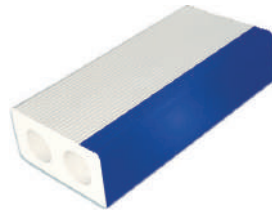

**M0107** (12,5 x 25 x 6 cm)  
Porselen Merdiven Basamağı (Kobalt - Sırsız)  
Porcelain Stair Step (Cobalt - Unglazed)

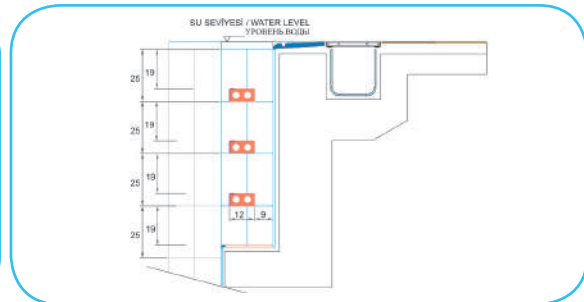
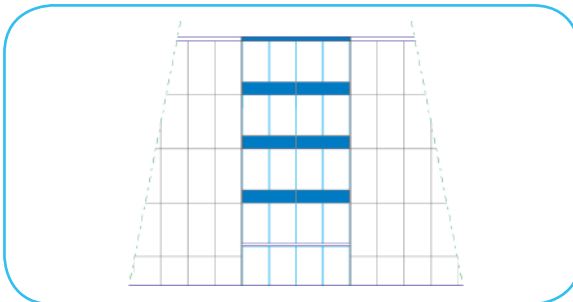
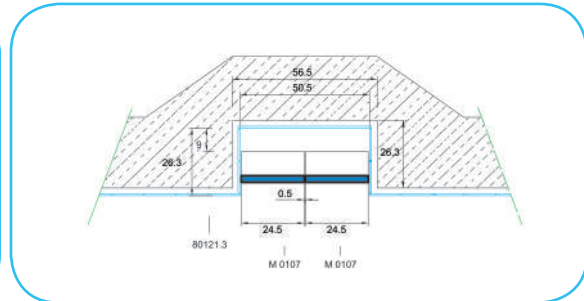
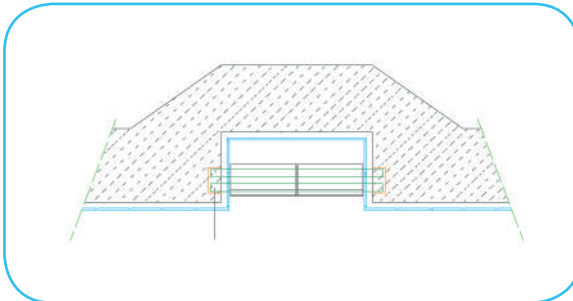





Teras Kaymazları  
Terrace Antislip Tiles



## Duna Teras Kaymazları

### Duna Terrace Antislip Tiles



**25300** (25 x 25 cm)  
Duna Kaymaz (Bej)  
Duna Antislip Tile (Beige)



**25304** (25 x 25 cm)  
Duna Kaymaz (Kotto)  
Duna Antislip Tile (Cotto)

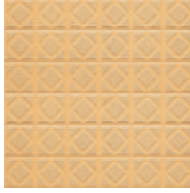

**25306** (25 x 25 cm)  
Duna Kaymaz (Sarı)  
Duna Antislip Tile (Yellow)



**25309** (25 x 25 cm)  
Duna Kaymaz (Gri)  
Duna Antislip Tile (Grey)

## Duna Teras Kaymazları

### Duna Terrace Antislip Tiles



**\*20304** (12,5 x 25 cm)  
Duna Kaymaz (Kotto)  
Duna Antislip Tile (Cotto)



**\*20306** (12,5 x 25 cm)  
Duna Kaymaz (Sarı)  
Duna Antislip Tile (Yellow)

## Rölyef Teras Kaymazları

### Relief Terrace Antislip Tiles



**25400** (25 x 25 cm)  
Rölyef Kaymaz (Bej)  
Relief Antislip Tile (Beige)



**25404** (25 x 25 cm)  
Rölyef Kaymaz (Kotto)  
Relief Antislip Tile (Cotto)



**25406.1** (25 x 25 cm)  
Rölyef Kaymaz (Sarı)  
Relief Antislip Tile (Yellow)



**25409** (25 x 25 cm)  
Rölyef Kaymaz (Gri)  
Relief Antislip Tile (Grey)



**25400-K** (25 x 25 cm)  
Rölyef Kaymaz (Korundlu)(Bej)  
Relief Antislip Tile (Corund)(Beige)



**25404-K** (25 x 25 cm)  
Rölyef Kaymaz (Korundlu)(Kotto)  
Relief Antislip Tile (Corund)(Cotto)

## Yıldız Teras Kaymazları

### Star Terrace Antislip Tiles



**\*203-7000 T** (25 x 25 cm)  
Yıldız Kaymaz (Bej)  
Star Antislip Tile (Beige)



**\*203-7009.4 T** (25 x 25 cm)  
Yıldız Kaymaz (Gri)  
Star Antislip Tile (Grey)

\*Stoklarla sınırlıdır. / Limited with stock quantity.





**SERA**  
**POOL**

**Diş Mekan Karoları**  
Outdoor Tiles



## Natural Wood Dış Mekan Karoları

### Natural Wood Outdoor Tiles



**2012-1404** (45 x 45 cm)  
Natural Wood Dış Mekan Karosu (Kotto)  
Natural Wood Outdoor Tile (Cotto)



**2012-1408.2** (45 x 45 cm)  
Natural Wood Dış Mekan Karosu (Bej)  
Natural Wood Outdoor Tile (Beige)

## Spinello Dış Mekan Karoları

### Spinello Outdoor Tiles



**\*207-1309** (33 x 33 cm)  
Spinello Dış Mekan Karosu (Gri)  
Spinello Outdoor Tile (Grey)

## Limpus Dış Mekan Karoları

### Limpus Outdoor Tiles



**\*2011-1809.1** (60 x 60 cm)  
Limpus Dış Mekan Karosu (Gri)  
Limpus Outdoor Tile (Grey)

## Apache Dış Mekan Karoları

### Apache Outdoor Tiles



**208-8000** (33 x 50 cm)  
Apache Dış Mekan Karosu (Sırsız)  
Apache Outdoor Tile (Unglazed)



**208-8009.1** (33 x 50 cm)  
Apache Dış Mekan Karosu (Gri)  
Apache Outdoor Tile (Grey)



**208-8009.2** (33 x 50 cm)  
Apache Dış Mekan Karosu (Antrasit)  
Apache Outdoor Tile (Anthracite)

## Traverten Dış Mekan Karoları

### Traverten Outdoor Tiles



**\*2010-1508.2** (30 x 60 cm)  
Traverten Bone Dış Mekan Karosu (Koyu Bej)  
Traverten Bone Outdoor Tile (Dark Beige)



**\*2010-1508.1** (30 x 60 cm)  
Traverten Bone Dış Mekan Karosu (Açık Bej)  
Traverten Bone Outdoor Tile (Light Beige)

## Natural Serawood Dış Mekan Karoları

### Natural Serawood Outdoor Tiles

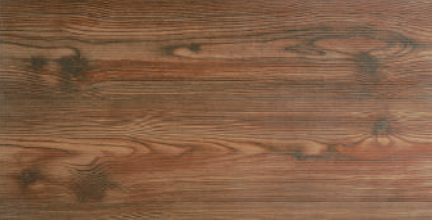

**\*2010-1404** (30 x 60 cm)  
Natural Serawood Dış Mekan Karosu (Kotto)  
Natural Serawood Outdoor Tile (Cotto)

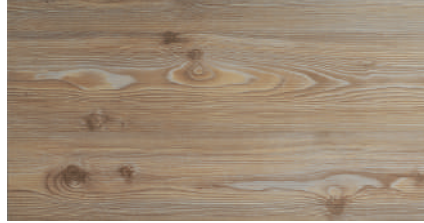

**\*2010-1408.2** (30 x 60 cm)  
Natural Serawood Dış Mekan Karosu (Bej)  
Natural Serawood Outdoor Tile (Beige)



**\*2010-1409** (30 x 60 cm)  
Natural Serawood Dış Mekan Karosu (Gri)  
Natural Serawood Outdoor Tile (Grey)

## Slate Dış Mekan Karoları

### Slate Outdoor Tiles



**209-2100** (33 x 66 cm)  
Slate Dış Mekan Karosu (Bej)  
Slate Outdoor Tile (Beige)



**209-2109** (33 x 66 cm)  
Slate Dış Mekan Karosu (Gri)  
Slate Outdoor Tile (Grey)

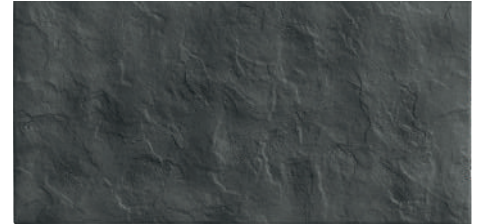

**209-2109.2** (33 x 66 cm)  
Slate Dış Mekan Karosu (Antrasit Gri)  
Slate Outdoor Tile (Anthracite grey)





**SERA**  
**POOL**

**İç ve Dış Bükümlü Parçalar**  
Concave and Convex Parts

1.20m



## İç ve Dış Bükey Parçalar

## Concave and Convex Parts



**60100** (4 x 25 cm)  
Yer Birleştirme İç Bükey (Sırsız)  
Concave Joining Piece (Unglazed)



**60110** (4 x 4 cm)  
Yer Birleştirme İç Bükey Köşe (Sırsız)  
Concave Joining Piece Corner (Unglazed)



**60120** (4 x 4 cm)  
Yer Birleştirme İç Bükey Ayak (Sırsız)  
Concave Joining Base (Unglazed)

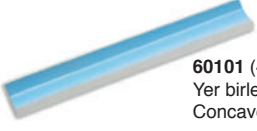

**60101** (4 x 25 cm)  
Yer birleştirme iç bükey (Açık Mavi)  
Concave joining Piece (Light Blue)



**60111** (4 x 4 cm)  
Yer Birleştirme İç Bükey Köşe (Açık Mavi)  
Concave Joining Piece Corner (Light Blue)



**60121** (4 x 4 cm)  
Yer Birleştirme İç Bükey Ayak (Açık Mavi)  
Concave Joining Base (Light Blue)



**60103** (4 x 25 cm)  
Yer Birleştirme İç Bükey (Beyaz)  
Concave Joining Piece (White)



**60113** (4 x 4 cm)  
Yer Birleştirme İç Bükey Köşe (Beyaz)  
Concave Joining Piece Corner (White)



**60123** (4 x 4 cm)  
Yer Birleştirme İç Bükey Ayak (Beyaz)  
Concave Joining Base (White)



**60107** (4 x 25 cm)  
Yer Birleştirme İç Bükey (Kobalt)  
Concave Joining Piece (Cobalt)



**60117** (4 x 4 cm)  
Yer Birleştirme İç Bükey Köşe (Kobalt)  
Concave Joining Piece Corner (Cobalt)



**60127** (4 x 4 cm)  
Yer Birleştirme İç Bükey Ayak (Kobalt)  
Concave Joining Base (Cobalt)



**60200** (4 x 25 cm)  
Yer Birleştirme Dış Bükey (Sırsız)  
Convex Joining Piece (Unglazed)



**60210** (4 x 4 cm)  
Yer Birleştirme Dış Bükey Köşe (Sırsız)  
Convex Joining Piece Corner (Unglazed)



**60220** (4 x 4 cm)  
Yer Birleştirme Dış Bükey Ayak (Sırsız)  
Convex Joining Base (Unglazed)



**60201** (4 x 25 cm)  
Yer Birleştirme Dış Bükey (Açık Mavi)  
Convex Joining Piece (Light Blue)



**60211** (4 x 4 cm)  
Yer Birleştirme Dış Bükey Köşe (Açık Mavi)  
Convex Joining Piece Corner (Light Blue)



**60221** (4 x 4 cm)  
Yer Birleştirme Dış Bükey Ayak (Açık Mavi)  
Convex Joining Base (Light Blue)



**60203** (4 x 25 cm)  
Yer Birleştirme Dış Bükey (Beyaz)  
Convex Joining Piece (White)



**60213** (4 x 4 cm)  
Yer Birleştirme Dış Bükey Köşe (Beyaz)  
Convex Joining Piece Corner (White)



**60223** (4 x 4 cm)  
Yer Birleştirme Dış Bükey Ayak (Beyaz)  
Convex Joining Base (White)



**60207** (4 x 25 cm)  
Yer Birleştirme Dış Bükey (Kobalt)  
Convex Joining Piece (Cobalt)



**60217** (4 x 4 cm)  
Yer Birleştirme Dış Bükey Köşe (Kobalt)  
Convex Joining Piece Corner (Cobalt)



**60227** (4 x 4 cm)  
Yer Birleştirme Dış Bükey Ayak (Kobalt)  
Convex Joining Base (Cobalt)

## İç ve Dış Bükey Parçalar – 2

## Concave and Convex Parts – 2



**63100** (6,5 x 25 cm)  
Yer Birleştirme İç Bükey (Sırsız)  
Concave Joining Piece (Unglazed)

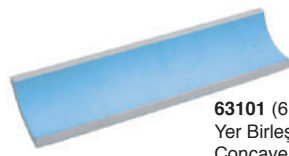

**63101** (6,5 x 25 cm)  
Yer Birleştirme İç Bükey (Açık Mavi)  
Concave Joining Piece (Light Blue)



**63107** (6,5 x 25 cm)  
Yer Birleştirme İç Bükey (Kobalt)  
Concave Joining Piece (Cobalt)



**63200** (6,5 x 25 cm)  
Yer Birleştirme Dış Bükey (Sırsız)  
Convex Joining Piece (Unglazed)



**63201** (6,5 x 25 cm)  
Yer Birleştirme Dış Bükey (Açık Mavi)  
Convex Joining Piece (Light Blue)



**63207** (6,5 x 25 cm)  
Yer Birleştirme Dış Bükey (Kobalt)  
Convex Joining Piece (Cobalt)

## 90° Porselen Köşebentler

### 90° Porcelain Brackets

#### C SERİSİ İÇ KÖŞEBENT INTERNAL BRACKETS – C SERIES



**60190** (3,2x3,2x25 cm)  
90° İç Köşebent (Sırsız)  
90° Internal Bracket (Unglazed)

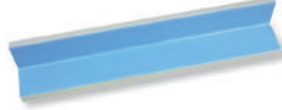

**60191** (3,2x3,2x25 cm)  
90° İç Köşebent (Açık Mavi)  
90° Internal Bracket (Light Blue)



**60197** (3,2x3,2x25 cm)  
90° İç Köşebent (Kobalt)  
90° Internal Bracket (Cobalt)

#### C SERİSİ DIŞ KÖŞEBENT EXTERNAL BRACKETS – C SERIES



**60290** (4,1x4,1x25 cm)  
90° Dış Köşebent (Sırsız)  
90° External Bracket (Unglazed)



**60291** (4,1x4,1x25 cm)  
90° Dış Köşebent (Açık Mavi)  
90° External Bracket (Light Blue)



**60297** (4,1x4,1x25 cm)  
90° Dış Köşebent (Kobalt)  
90° External Bracket (Cobalt)

#### B SERİSİ İÇ KÖŞEBENT INTERNAL BRACKET – B SERIES



**61190** (2,5x2,5x25 cm)  
90° İç Köşebent (Sırsız)  
90° Internal Bracket (Unglazed)

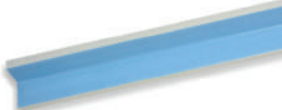

**61191** (2,5x2,5x25 cm)  
90° İç Köşebent (Açık Mavi)  
90° Internal Bracket (Light Blue)



**61197** (2,5x2,5x25 cm)  
90° İç Köşebent (Kobalt)  
90° Internal Bracket (Cobalt)

#### B SERİSİ DIŞ BÜKEY EXTERNAL BRACKETS – B SERIES



**61290** (3,5x3,5x25 cm)  
90° Dış Köşebent (Sırsız)  
90° External Bracket (Unglazed)



**61291** (3,5x3,5x25 cm)  
90° Dış Köşebent (Açık Mavi)  
90° External Bracket (Light Blue)



**61297** (3,5x3,5x25 cm)  
90° Dış Köşebent (Kobalt)  
90° External Bracket (Cobalt)





**SERA**  
**POOL**

**Porselen Karolar**  
Porcelain Tiles



## Fotosera

### Photosera

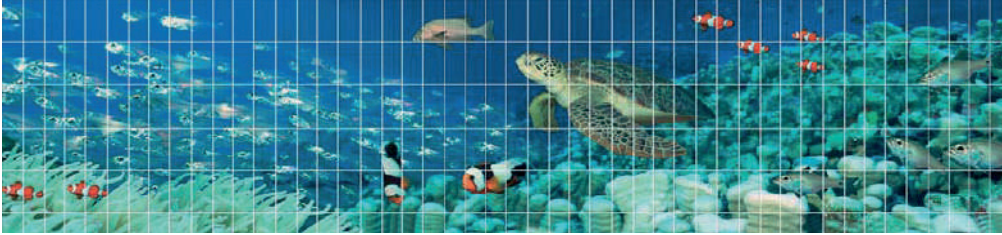

FS-049

600x150 cm

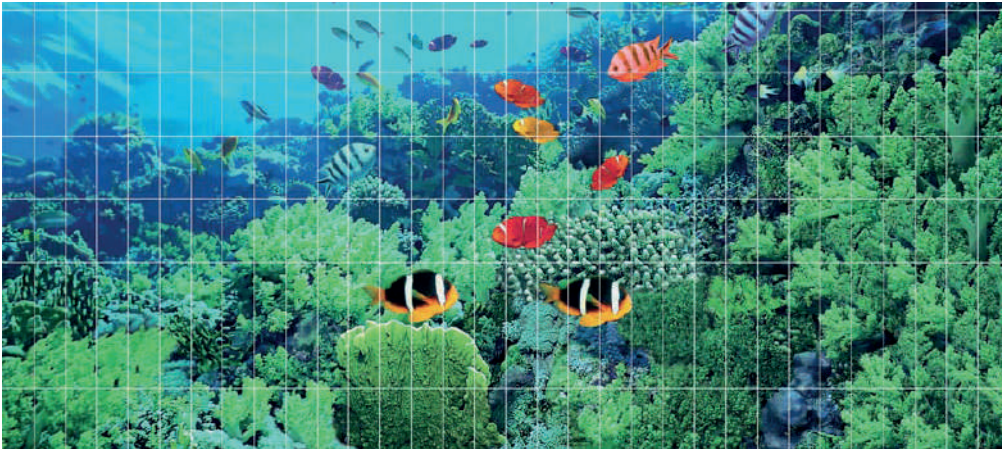

FS-021

400x200 cm

FS-022

200x100 cm

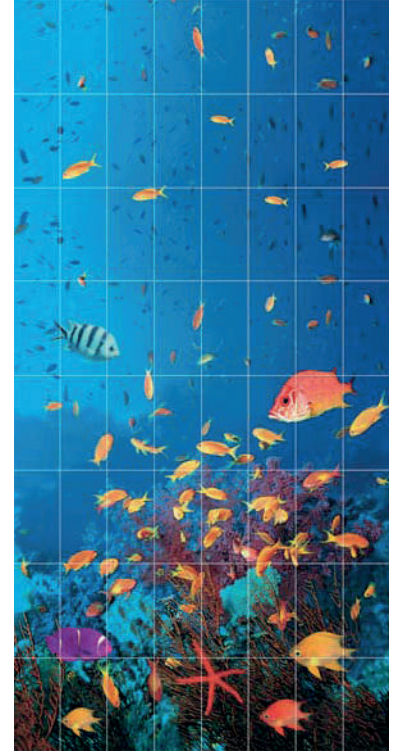

FS-001

100x200 cm

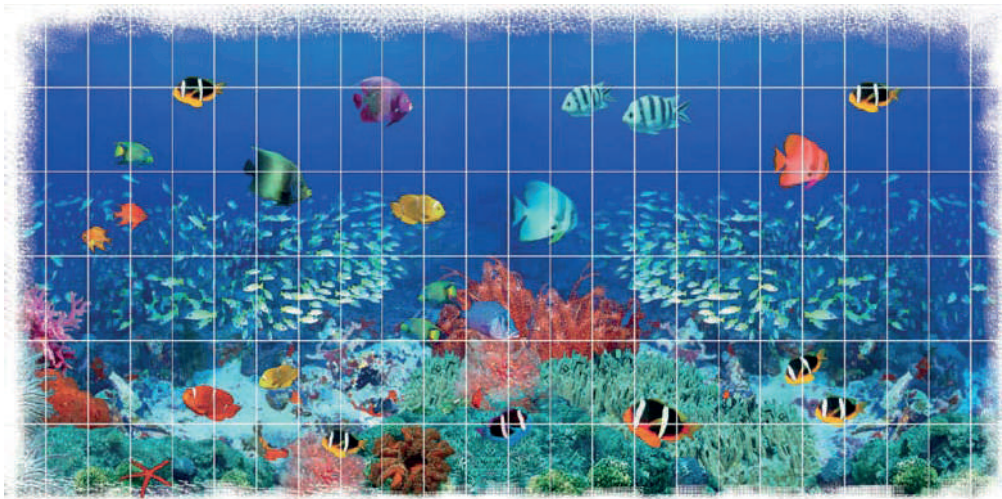

FS-006

300x150 cm

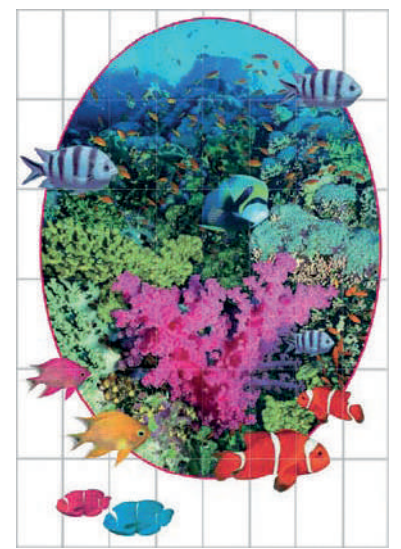

FS-012

100x150 cm



## Porselen Karo Bordürler

### Porcelain Tile Borders



**80001** (12,5 x 25 cm)  
Dalgalı Bordür  
Wavy Border



**80002** (12,5 x 25 cm)  
İstiridye Bordür  
Oyster Border



**F8003** (12,5 x 25 cm)  
F Bordür 1 – Delphino  
F Border 1 – Delphino



**\*F8005** (12,5 x 25 cm)  
F Bordür 3 – Smarty  
F Border 3 – Smarty

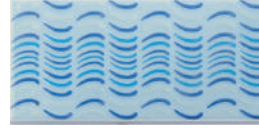

**\*F8007** (12,5 x 25 cm)  
F Bordür 5 – Onde  
F Border 5 – Onde



**\*F8008-B** (12,5 x 25 cm)  
F Bordür 6 – Ninfee B  
F Border 6 – Ninfee B



**\*F8010** (12,5 x 25 cm)  
F Bordür 8 – Klyps  
F Border 8 – Klyps



**\*F8011-A** (12,5 x 25 cm)  
F Bordür 9 – Fish A  
F Border 9 – Fish A



**\*F8012-A** (12,5 x 25 cm)  
F Bordür 10 – Hands  
F Border 10 – Hands

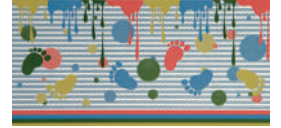

**\*F8012-B** (12,5 x 25 cm)  
F Bordür 10 – Feet  
F Border 10 – Feet

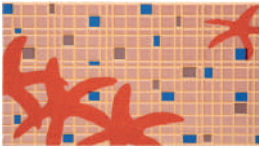

**\*T8013** (14 x 25 cm)  
T Bordür 10 – Seastar  
T Border 10 – Seastar



**\*T8014** (14 x 25 cm)  
T Bordür 11 – Hippocamus  
T Border 11 – Hippocamus



**\*T80151-A** (14 x 25 cm)  
T Bordür – Albatros A  
T Border – Albatros A



**\*T80151-B** (14 x 25 cm)  
T Bordür – Albatros B  
T Border – Albatros B



**\*T8016** (12 x 33 cm)  
Bordür – Infinity 1 – Mavi  
Border – Infinity 1 – Blue



**\*T8017** (12 x 33 cm)  
Bordür – Infinity 1 - Gri  
Border – Infinity 1 – Grey

\*Stoklarla sınırlıdır. / Limited with stock quantity.

## Porselen Karolar

### Porcelain Tiles



**80147** (25 x 50 cm)  
Porselen Karo (Kobalt)  
Porcelain Tile (Cobalt)



**80141.3** (25 x 50 cm)  
Porselen Karo (Açık Mavi)  
Porcelain Tile (Light Blue)

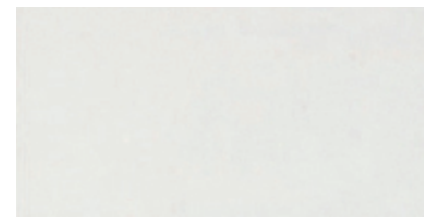

**80143** (25 x 50 cm)  
Porselen Karo (Beyaz)  
Porcelain Tile (White)

## Porselen Karolar

### Porcelain Tiles



**80127** (12,5 x 25 cm)  
Porselen Karo (Kobalt)  
Porcelain Tile (Cobalt)



**80121.1** (12,5 x 25 cm)  
Porselen Karo (Koyu Mavi)  
Porcelain Tile (Dark Blue)



**80121.2** (12,5 x 25 cm)  
Porselen Karo (Mavi)  
Porcelain Tile (Blue)



**80121.3** (12,5 x 25 cm)  
Porselen Karo (Açık Mavi)  
Porcelain Tile (Light Blue)



**80121.4** (12,5 x 25 cm)  
Porselen Karo (Su Mavisi)  
Porcelain Tile (Aqua Blue)



**80122.1** (12,5 x 25 cm)  
Porselen Karo (Koyu Yeşil)  
Porcelain Tile (Dark Green)



**80122.2** (12,5 x 25 cm)  
Porselen Karo (Yeşil)  
Porcelain Tile (Green)



**80122.3** (12,5 x 25 cm)  
Porselen Karo (Turkuaz)  
Porcelain Tile (Turquoise)



**\*80122.4** (12,5 x 25 cm)  
Porselen Karo (Su Yeşili)  
Porcelain Tile (Aqua Green)



**\*80122.5** (12,5 x 25 cm)  
Porselen Karo (Nil Yeşili)  
Porcelain Tile (Nile Green)



**80125** (12,5 x 25 cm)  
Porselen Karo (Kırmızı)  
Porcelain Tile (Red)



**80126** (12,5 x 25 cm)  
Porselen Karo (Sarı)  
Porcelain Tile (Yellow)



**80123** (12,5 x 25 cm)  
Porselen Karo (Beyaz)  
Porcelain Tile (White)



**80129** (12,5 x 25 cm)  
Porselen Karo (Siyah)  
Porcelain Tile (Black)

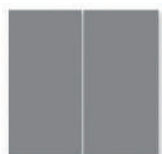

**80129.1** (12,5 x 25 cm)  
Porselen Karo (Gri)  
Porcelain Tile (Grey)

\*Stoklarla sınırlıdır. / Limited with stock quantity.

## Porselen Kaymaz Karolar

### Porcelain Antislip Tiles



**80131.3** (12,5 x 25 cm)  
Kaymaz Karo (Açık Mavi)  
Antislip Tile (Light Blue)



**80133** (12,5 x 25 cm)  
Kaymaz Karo (Beyaz)  
Antislip Tile (White)



**80137** (12,5 x 25 cm)  
Kaymaz Karo (Kobalt)  
Antislip Tile (Cobalt)

\*Bu kaymaz malzemelerin uygulaması (yapıştırma ve derz dolgu) aşamasında temizliğe çok dikkat edilmelidir. Temizliğin özenle yapılması gerekmektedir. Geç kalınması durumunda temizlenmesi mümkün değildir.  
\*It is advisable to pay close attention to cleanness at the moment of tiling of this material. As soon as the tiling is finished, material cleaning should be started immediately.

## Porselen Karolar

### Porcelain Tiles

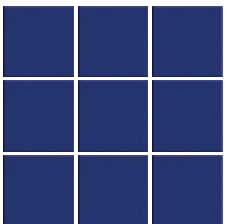

**80097** (10 x 10 cm)  
Porselen Karo (Kobalt)  
Porcelain Tile (Cobalt)

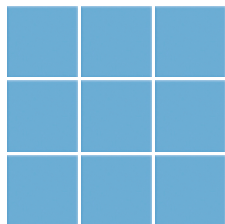

**80091.2** (10 x 10 cm)  
Porselen Karo (Mavi)  
Porcelain Tile (Blue)

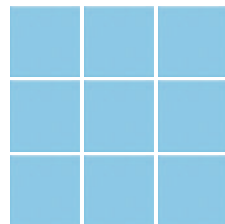

**80091.3** (10 x 10 cm)  
Porselen Karo (Açık Mavi)  
Porcelain Tile (Light Blue)

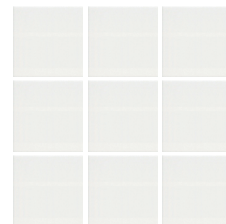

**80093** (10 x 10 cm)  
Porselen Karo (Beyaz)  
Porcelain Tile (White)





**SERA**  
**POOL**

**Porselen Mozaikler**  
Porcelain Mosaics



## Porselen Mozaikler

### Porcelain Mosaics

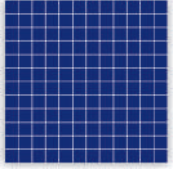

**80017** (2,5 x 2,5 cm)  
Mozaik (Kobalt)  
Mosaic (Cobalt)

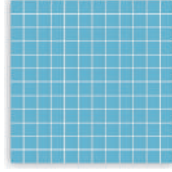

**80011.2** (2,5 x 2,5 cm)  
Mozaik (Mavi)  
Mosaic (Blue)

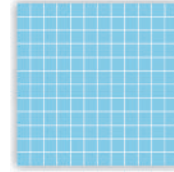

**80011.3** (2,5 x 2,5 cm)  
Mozaik (Açık Mavi)  
Mosaic (Light Blue)

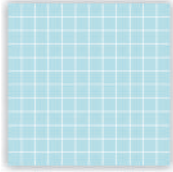

**80011.4** (2,5 x 2,5 cm)  
Mozaik (Su Mavis)  
Mosaic (Aqua Blue)

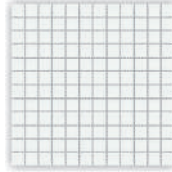

**80013** (2,5 x 2,5 cm)  
Mozaik (Beyaz)  
Mosaic (White)

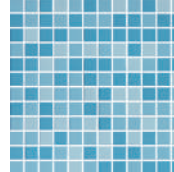

**80011.3 H** (2,5 x 2,5 cm)  
Mozaik Karışım  
(Mavi - Açık Mavi - Su Mavis)  
Mixed Mosaic  
(Blue - Light Blue - Aqua Blue)

## Porselen Mozaikler

### Porcelain Mosaics

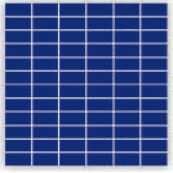

**80037** (2,5 x 5 cm)  
Mozaik (Kobalt)  
Mosaic (Cobalt)

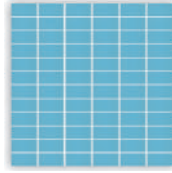

**80031.2** (2,5 x 5 cm)  
Mozaik (Mavi)  
Mosaic (Blue)

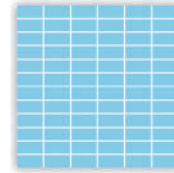

**80031.3** (2,5 x 5 cm)  
Mozaik (Açık Mavi)  
Mosaic (Light Blue)

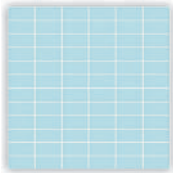

**80031.4** (2,5 x 5 cm)  
Mozaik (Su Mavis)  
Mosaic (Aqua Blue)



**80033** (2,5 x 5 cm)  
Mozaik (Beyaz)  
Mosaic (White)

## Porselen Mozaikler

### Porcelain Mosaics



**80077** (5 x 10 cm)  
Mozaik (Kobalt)  
Mosaic (Cobalt)

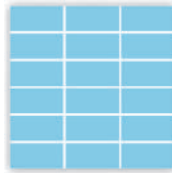

**80071.3** (5 x 10 cm)  
Mozaik (Açık Mavi)  
Mosaic (Light Blue)



**80073** (5 x 10 cm)  
Mozaik (Beyaz)  
Mosaic (White)

## Porselen Kaymaz Mozaikler

### Antislip Porcelain Mosaics

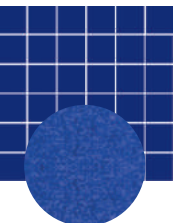

**80067** (5 x 5 cm)  
Kaymaz Mozaik (Kobalt)  
Antislip Mosaic (Cobalt)

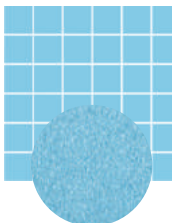

**80061.3** (5 x 5 cm)  
Kaymaz Mozaik (Açık Mavi)  
Antislip Mosaic (Light Blue)



**80063** (5 x 5 cm)  
Kaymaz Mozaik (Beyaz)  
Antislip Mosaic (White)



## Porselen Mozaikler

### Porcelain Mosaics

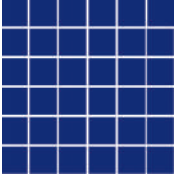

**80057** (5 x 5 cm)  
Mozaik (Kobalt)  
Mosaic (Cobalt)

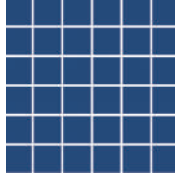

**80051.1** (5 x 5 cm)  
Mozaik (Koyu Mavi)  
Mosaic (Dark Blue)

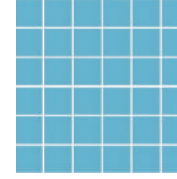

**80051.2** (5 x 5 cm)  
Mozaik (Mavi)  
Mosaic (Blue)

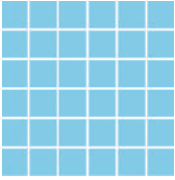

**80051.3** (5 x 5 cm)  
Mozaik (Açık Mavi)  
Mosaic (Light Blue)

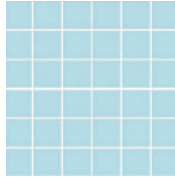

**80051.4** (5 x 5 cm)  
Mozaik (Su Mavisı)  
Mosaic (Aqua Blue)

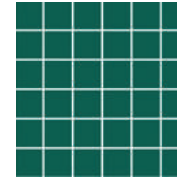

**80052.1** (5 x 5 cm)  
Mozaik (Koyu Yeşil)  
Mosaic (Dark Green)

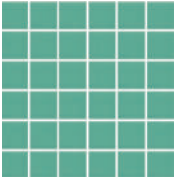

**80052.2** (5 x 5 cm)  
Mozaik (Yeşil)  
Mosaic (Green)

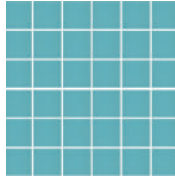

**BC735** (5 x 5 cm)  
Mozaik (Turkuaz)  
Mosaic (Turquoise)  
Serabella

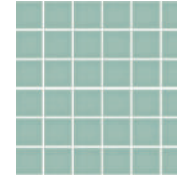

**\*80052.4** (5 x 5 cm)  
Mozaik (Su Yeşili)  
Mosaic (Aqua Green)

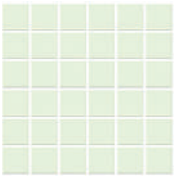

**BC704** (5 x 5 cm)  
Mozaik (Açık Yeşil)  
Mosaic (Light Green)  
Serabella

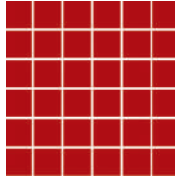

**\*80055.1** (5 x 5 cm)  
Mozaik (Kırmızı)  
Mosaic (Red)



**80053** (5 x 5 cm)  
Mozaik (Beyaz)  
Mosaic (White)

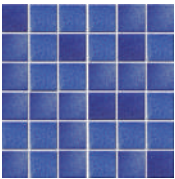

**80057H** (5 x 5 cm)  
Mozaik (Kobalt Armoni)  
Mosaic (Cobalt Harmony)

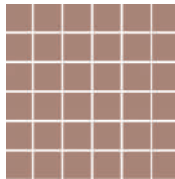

**\*80058.1** (5 x 5 cm)  
Mozaik (Koyu Sütü Kahve)  
Mosaic (Dark Pale Brown)

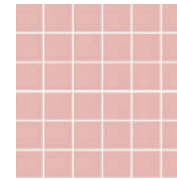

**\*80055.11** (5 x 5 cm)  
Mozaik (Gül Pembe)  
Mosaic (Rose Pink)

\*Diğer renk seçeneklerimiz için Serabella Bellacolors kataloğümüzü inceleyiniz. / For please check our Serabella Catalogue for other color options.

## Porselen Mozaik Armoni Serisi

### Porcelain Mosaic Harmony Series

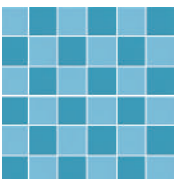

**80051.2H** (5 x 5 cm)  
Mozaik – İkili mavi karışım (Mavi – Açık Mavi)  
Binary Blue Mixed Mosaics (Blue – Light Blue)

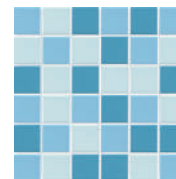

**80051.3H** (5 x 5 cm)  
Mozaik – Üçlü mavi karışım (Mavi – Açık Mavi – Su Mavisı)  
Triple Blue Mixed Mosaics (Blue – Light Blue – Aqua Blue)

\*İsteğe bağlı olarak size özel renk karışımları yapılabilmektedir. / Colour blends can be made as desired.

## Mat Mozaikler

### Matt Mosaics

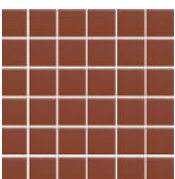

**\*81054.1** (5 x 5 cm)  
Mozaik (Mat Kotto)  
Mosaic (Matt Cotto)

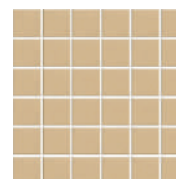

**\*81058.2** (5 x 5 cm)  
Mozaik (Mat Bej)  
Mosaic (Matt Beige)

\*Stoklarla sınırlıdır. / Limited with stock quantity.

## Porselen Mozaik Miniser Bordürler

Porcelain Mosaic Borders – Miniser



**80151 A** (5 x 30 cm)  
Dalgali Bordür  
Wavy Border



**80151 B** (5 x 30 cm)  
Dalgali Bordür  
Wavy Border



**80153** (5 x 30 cm)  
Kare Bordür  
Square Border



**80152 A** (5 x 30 cm)  
Zigzaglı Bordür  
Zigzag Border



**80152 B** (5 x 30 cm)  
Zigzaglı Bordür  
Zigzag Border



**80154** (5 x 30 cm)  
Diamond Bordür  
Diamond Border

## Porselen Mozaik Seramin Bordürler

Porcelain Mosaic Borders – Seramin



**80161.1** (5 x 5 cm)  
Mozaik Bordür - 1 (Kobalt - Beyaz)  
Mosaic Border - 1 (Cobalt - White)



**80161.2** (5 x 5 cm)  
Mozaik Bordür - 2 (Kobalt - Beyaz)  
Mosaic Border - 2 (Cobalt - White)



**80161.3** (5 x 5 cm)  
Mozaik Bordür - 3 (Kobalt - Beyaz)  
Mosaic Border - 3 (Cobalt - White)



**80161.4** (5 x 5 cm)  
Mozaik Bordür - 4 (Kobalt - Beyaz - Açık Mavi)  
Mosaic Border - 4 (Cobalt - White - Light Blue)





## Desenlerden Bazıları

### Some of Our Design



**Y143-3 Yunus** (5 x 5 cm)  
 270 x 660 cm (8,26 m<sup>2</sup>)  
 pano ebadı / pattern size  
 270 x 660 cm (23,23 m<sup>2</sup>)



**Y245-1 Yunus** (5 x 5 cm)  
 450 x 270 cm (6,15 m<sup>2</sup>)  
 pano ebadı / pattern size  
 450 x 270 cm (12,39 m<sup>2</sup>)



**Y245-3 Yunus** (5 x 5 cm)  
 420 x 240 cm (4,87 m<sup>2</sup>)  
 pano ebadı / pattern size  
 420 x 240 cm (10,28 m<sup>2</sup>)



**Y245-4 Yunus** (5 x 5 cm)  
 360 x 180 cm (3,95 m<sup>2</sup>)  
 pano ebadı / pattern size  
 360 x 180 cm (6,62 m<sup>2</sup>)



**Y245-5 Yunus** (5 x 5 cm)  
 480 x 180 cm (5,50 m<sup>2</sup>)  
 pano ebadı / pattern size  
 480 x 180 cm (8,82 m<sup>2</sup>)



**Y345-1 Yunus** (5 x 5 cm)  
 570 x 360 cm (16,43 m<sup>2</sup>)  
 pano ebadı / pattern size  
 570 x 360 cm (22,67 m<sup>2</sup>)



**Y345-2 Yunus** (5 x 5 cm)  
 720 x 330 cm (9,92 m<sup>2</sup>)  
 pano ebadı / pattern size  
 720 x 330 cm (24,24 m<sup>2</sup>)



**Y345-4 Yunus** (5 x 5 cm)  
 540 x 330 cm (7,81 m<sup>2</sup>)  
 pano ebadı / pattern size  
 540 x 330 cm (18,18 m<sup>2</sup>)



**Y345-7 Yunus** (5 x 5 cm)  
 360 x 300 cm (7,26 m<sup>2</sup>)  
 pano ebadı / pattern size  
 360 x 300 cm (11,02 m<sup>2</sup>)



**Y345-8 Yunus** (5 x 5 cm)  
 240 x 420 cm (6,51 m<sup>2</sup>)  
 pano ebadı / pattern size  
 240 x 420 cm (10,28 m<sup>2</sup>)



**Y745-1 Yunus** (5 x 5 cm)  
 810 x 420 cm (19,93 m<sup>2</sup>)  
 pano ebadı / pattern size  
 810 x 420 cm (34,70 m<sup>2</sup>)

**Y745-2 Yunus** (5 x 5 cm)  
 510 x 270 cm (8,26 m<sup>2</sup>)  
 pano ebadı / pattern size  
 510 x 270 cm (14,05 m<sup>2</sup>)



**Y745-3 Yunus** (5 x 5 cm)  
 570 x 300 cm (11,56 m<sup>2</sup>)  
 pano ebadı / pattern size  
 570 x 300 cm (17,44 m<sup>2</sup>)

## Desenlerden Bazıları

Some of Our Design



**SD-100 Nazar Boncuğu 1** (5x5 cm)  
210 x 240 cm (4,40 m<sup>2</sup>)  
pano ebadı / pattern size  
210 x 240 cm (5,14 m<sup>2</sup>)



**SD-101 Nazar Boncuğu 3** (5x5 cm)  
240 x 270 cm (5,50 m<sup>2</sup>)  
pano ebadı / pattern size  
240 x 270 cm (6,62 m<sup>2</sup>)



**SD-115 Kuğu 1** (5x5 cm)  
240 x 180 cm (3,77 m<sup>2</sup>)  
pano ebadı / pattern size  
240 x 180 cm (4,40 m<sup>2</sup>)



**SD-117 Deniz Yıldızı 2** (5x5 cm)  
420 x 390 cm (8,91 m<sup>2</sup>)  
pano ebadı / pattern size  
40 x 240 cm (16,72 m<sup>2</sup>)

**SD-109 Nazar Boncuğu 2** (5x5 cm)  
330 x 270 cm (7,52 m<sup>2</sup>)  
pano ebadı / pattern size  
330 x 270 cm (9,09 m<sup>2</sup>)

**SD-102 Nazar Boncuğu 4** (5x5 cm)  
360 x 390 cm (11,56 m<sup>2</sup>)  
pano ebadı / pattern size  
60 x 390 cm (14,32 m<sup>2</sup>)

**SD-114 Kuğu 2** (5x5 cm)  
480 x 330 cm (11,85 m<sup>2</sup>)  
pano ebadı / pattern size  
480 x 330 cm (16,16 m<sup>2</sup>)



**SD-118 Deniz Yıldızı 1** (5x5 cm)  
240 x 240 cm (3,77 m<sup>2</sup>)  
pano ebadı / pattern size  
240 x 240 cm (5,88 m<sup>2</sup>)



**SD-140 Desen 1** (5x5 cm)  
390 x 390 cm (11,67 m<sup>2</sup>)  
pano ebadı / pattern size  
390 x 390 cm (15,51 m<sup>2</sup>)



**SD-141 Çelen** (5x5 cm)  
390 x 360 cm (10,75 m<sup>2</sup>)  
pano ebadı / pattern size  
390 x 360 cm (14,32 m<sup>2</sup>)



**SD-144 Desen 2** (5x5 cm)  
420 x 420 cm (11,85 m<sup>2</sup>)  
pano ebadı / pattern size  
420 x 420 cm (18,00 m<sup>2</sup>)



**SD-150 Palmiye 1** (5x5 cm)  
240 x 330 cm (5,32 m<sup>2</sup>)  
pano ebadı / pattern size  
240 x 330 cm (8,08 m<sup>2</sup>)



**SD-122 Deniz atı** (5x5 cm)  
270 x 510 cm (12,49 m<sup>2</sup>)  
pano ebadı / pattern size  
270 x 510 cm (14,05 m<sup>2</sup>)

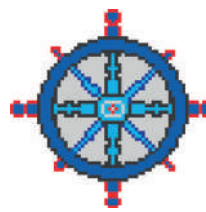

**SD-152 Dümen** (5x5 cm)  
330 x 300 cm (6,15 m<sup>2</sup>)  
pano ebadı / pattern size  
330 x 300 cm (10,10 m<sup>2</sup>)



**SD-153 Kaplumbağa** (5x5 cm)  
390 x 300 cm (7,25 m<sup>2</sup>)  
pano ebadı / pattern size  
390 x 300 cm (11,94 m<sup>2</sup>)



**SD-154 Ördek** (5x5 cm)  
300 x 450 cm (8,64 m<sup>2</sup>)  
pano ebadı / pattern size  
300 x 450 cm (13,78 m<sup>2</sup>)



**SD-155 Balık** (5x5 cm)  
270 x 270 cm (5,70 m<sup>2</sup>)  
pano ebadı / pattern size  
270 x 270 cm (7,43 m<sup>2</sup>)



**SD-156 Balık 3** (5x5 cm)  
240 x 240 cm (3,68 m<sup>2</sup>)  
pano ebadı / pattern size  
240 x 240 cm (5,88 m<sup>2</sup>)



**SD-157 Uçak** (5x5 cm)  
300 x 150 cm (4,13 m<sup>2</sup>)  
pano ebadı / pattern size  
300 x 150 cm (4,60 m<sup>2</sup>)





**Porselen Mozaikler - Versicolor Serisi**  
Porcelain Mosaics - Versicolor Series



## Porselen Mozaikler - Versicolor Serisi

### Porcelain Mosaics – Versicolor Series

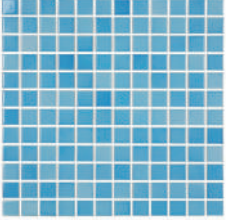

**VC.2.01.0100** (2,5 x 2,5 cm)  
Versicolor Mozaik (Mavi + Açık Mavi)  
Versicolor Mosaic (Blue + Light Blue)

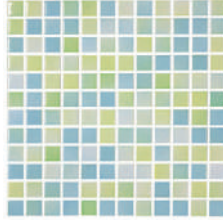

**VC.2.01.0602** (2,5 x 2,5 cm)  
Versicolor Mozaik (Sarı + Yeşil)  
Versicolor Mosaic (Yellow + Green)



**VC.2.01.0605** (2,5 x 2,5 cm)  
Versicolor Mozaik (Kırmızı + Turuncu)  
Versicolor Mosaic (Red + Orange)

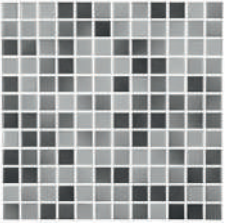

**VC.2.01.0913** (2,5 x 2,5 cm)  
Versicolor Mozaik (Siyah + Gri)  
Versicolor Mosaic (Black + Grey)

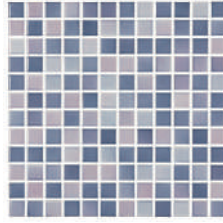

**VC.2.01.1016** (2,5 x 2,5 cm)  
Versicolor Mozaik (Eflatun + Pembe)  
Versicolor Mosaic (Purple + Pink)



**VC.2.01.1112** (2,5 x 2,5 cm)  
Versicolor Mozaik (Hardal + Lacivert)  
Versicolor Mosaic (Mustard + Dark Blue)



**VC.2.01.1412** (2,5 x 2,5 cm)  
Versicolor Mozaik (Turkuaz + Lacivert)  
Versicolor Mosaic (Turquoise + Dark Blue)



**VC.2.01.1508** (2,5 x 2,5 cm)  
Versicolor Mozaik (Bej + Kahve)  
Versicolor Mosaic (Beige + Brown)

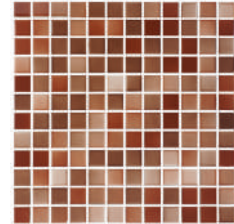

**VC.2.01.4647** (2,5 x 2,5 cm)  
Versicolor Mozaik (Kızıl Kahve + Kahve)  
Versicolor Mosaic (Reddish Brown + Brown)



**VC.2.01.5644** (2,5 x 2,5 cm)  
Versicolor Mozaik (Açık Kırmızı + Kırmızı)  
Versicolor Mosaic (Light Red + Red)

## Porselen Mozaikler – Versicolor Serisi

### Porcelain Mosaics – Versicolor Series

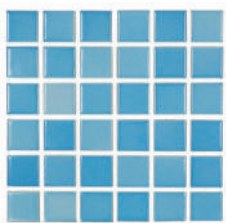

**VC.2.05.0100** (5 x 5 cm)  
Versicolor Mozaik (Mavi + Açık Mavi)  
Versicolor Mosaic (Blue + Light Blue)

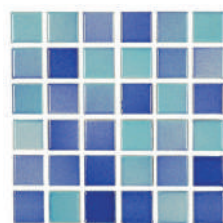

**VC.2.05.1412** (5 x 5 cm)  
Versicolor Mozaik (Turkuaz + Lacivert)  
Versicolor Mosaic (Turquoise + Dark Blue)



**VC.2.05.1112** (5 x 5 cm)  
Versicolor Mozaik (Hardal + Lacivert)  
Versicolor Mosaic (Mustard + Dark Blue)





**SERA**  
**POOL**

**SeraBella Porselen Mozaikler**  
SeraBella Porcelain Mosaics



## SeraBella Miele Mozaikler

### SeraBella Miele Mosaics

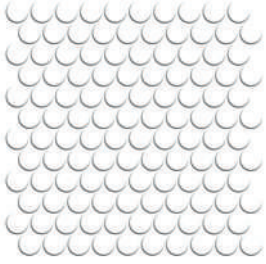

**M112S** (ø 2,65 cm)  
Miele Saten (Beyaz Saten)  
Miele Satin (Satin White)

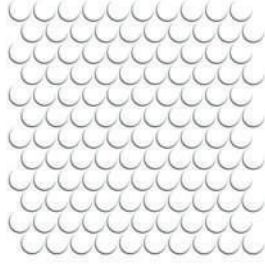

**M112** (ø 2,65 cm)  
Miele (Beyaz)  
Miele (White)

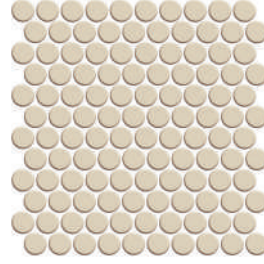

**M101** (ø 2,65 cm)  
Miele (Bej)  
Miele (Beige)

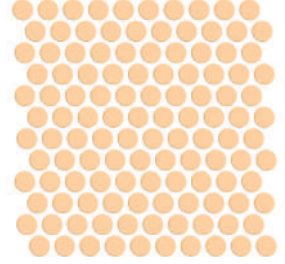

**M113** (ø 2,65 cm)  
Miele (Krem)  
Miele (Cream)

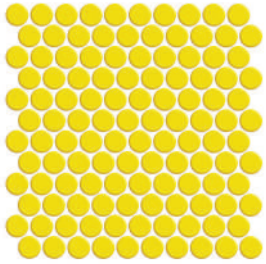

**M140** (ø 2,65 cm)  
Miele (Sarı)  
Miele (Yellow)

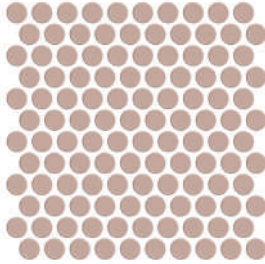

**M161** (ø 2,65 cm)  
Miele (Açık Kahve)  
Miele (Light Brown)

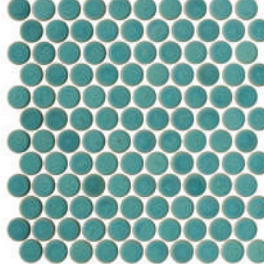

**M135** (ø 2,65 cm)  
Miele (Turkuaz)  
Miele (Turquoise)

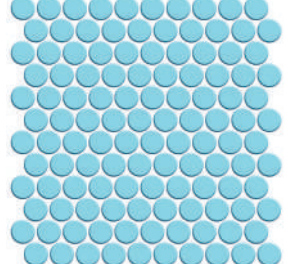

**M103** (ø 2,65 cm)  
Miele (Açık Mavi)  
Miele (Light Blue)

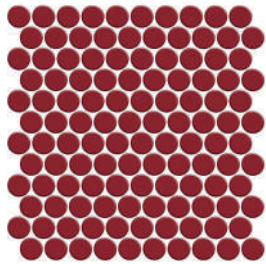

**M163** (ø 2,65 cm)  
Miele (Vişne Kırmızı)  
Miele (Cherry Red)

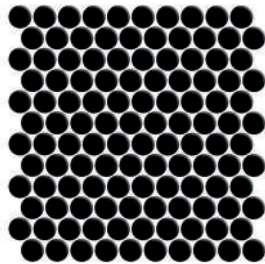

**M143** (ø 2,65 cm)  
Miele (Siyah)  
Miele (Black)

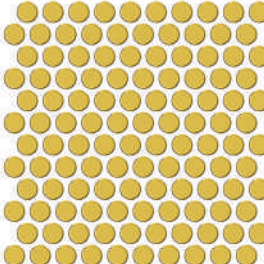

**M197** (ø 2,65 cm)  
Miele (Altın)  
Miele (Gold)

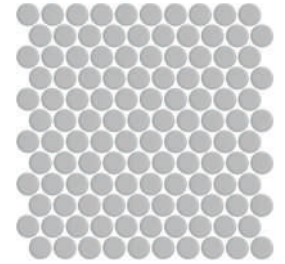

**M198** (ø 2,65 cm)  
Miele (Platin)  
Miele (Silver)

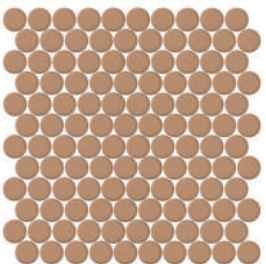

**M199** (ø 2,65 cm)  
Miele (Bronz)  
Miele (Bronze)

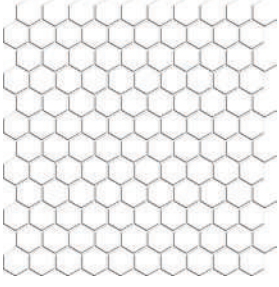

**SeraBella Hexagon Versicolor Mozaikler****SeraBella Hexagon Versicolor Mosaics**

**HG112S** (2,65 cm)  
Hexagon Saten (Beyaz Saten)  
Hexagon Satin (Satin White)

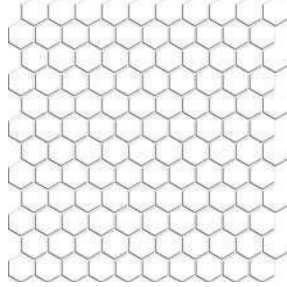

**HG112** (2,65 cm)  
Hexagon (Beyaz)  
Hexagon (White)

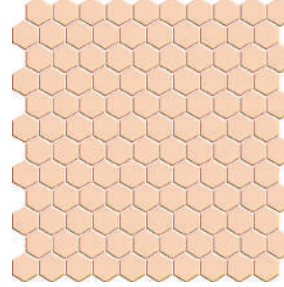

**HG113** (2,65 cm)  
Hexagon (Krem)  
Hexagon (Cream)

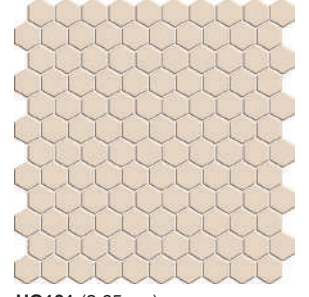

**HG101** (2,65 cm)  
Hexagon (Bej)  
Hexagon (Beige)

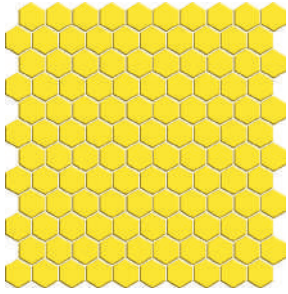

**HG140** (2,65 cm)  
Hexagon (Sarı)  
Hexagon (Yellow)

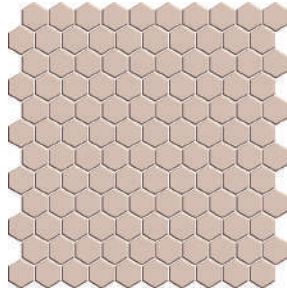

**HG161** (2,65 cm)  
Hexagon (Açık Kahve)  
Hexagon (Light Brown)

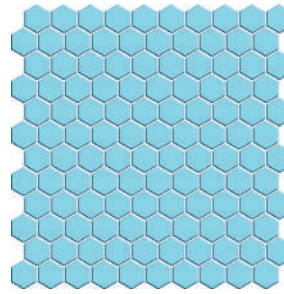

**HG103** (2,65 cm)  
Hexagon (Açık Mavi)  
Hexagon (Light Blue)

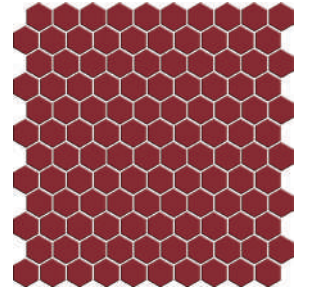

**HG163** (2,65 cm)  
Hexagon (Vişne Kırmızı)  
Hexagon (Cherry Red)

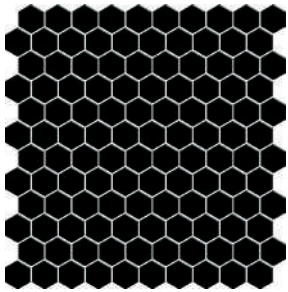

**HG143** (2,65 cm)  
Hexagon (Siyah)  
Hexagon (Black)

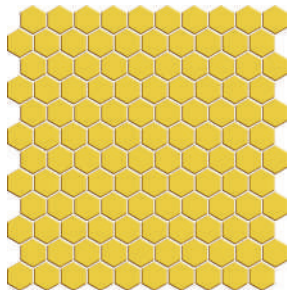

**HG197** (2,65 cm)  
Hexagon (Altın)  
Hexagon (Gold)

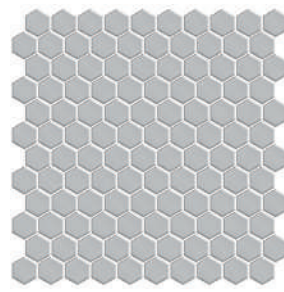

**HG198** (2,65 cm)  
Hexagon (Platin)  
Hexagon (Silver)

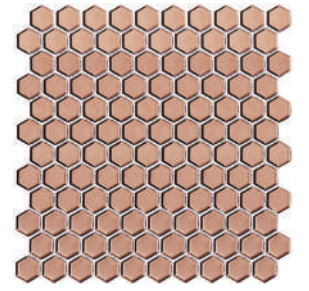

**HG199** (2,65 cm)  
Hexagon (Bronz)  
Hexagon (Bronze)

**SeraBella Hexagon Versicolor Porselen Mozaikler****SeraBella Hexagon Versicolor Porcelain Mosaics**

**HG0147** (2,65 cm)  
Hexagon Versicolor (Bej + Kahve)  
Hexagon Versicolor (Beige + Brown)

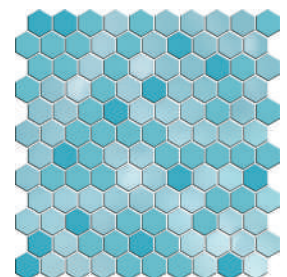

**HG0314** (2,65 cm)  
Hexagon Versicolor (Havuz Mavisi)  
Hexagon Versicolor (Pool Blue)

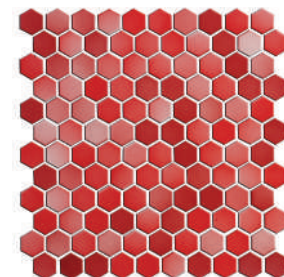

**HG5644** (2,65 cm)  
Hexagon Versicolor (Açık Kırmızı+ Kırmızı)  
Hexagon Versicolor (Light Red + Red)

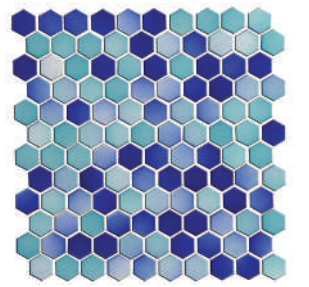

**HG3559** (2,65 cm)  
Hexagon Versicolor (Turkuaz + Lacivert)  
Hexagon Versicolor (Turquoise + Dark Blue)



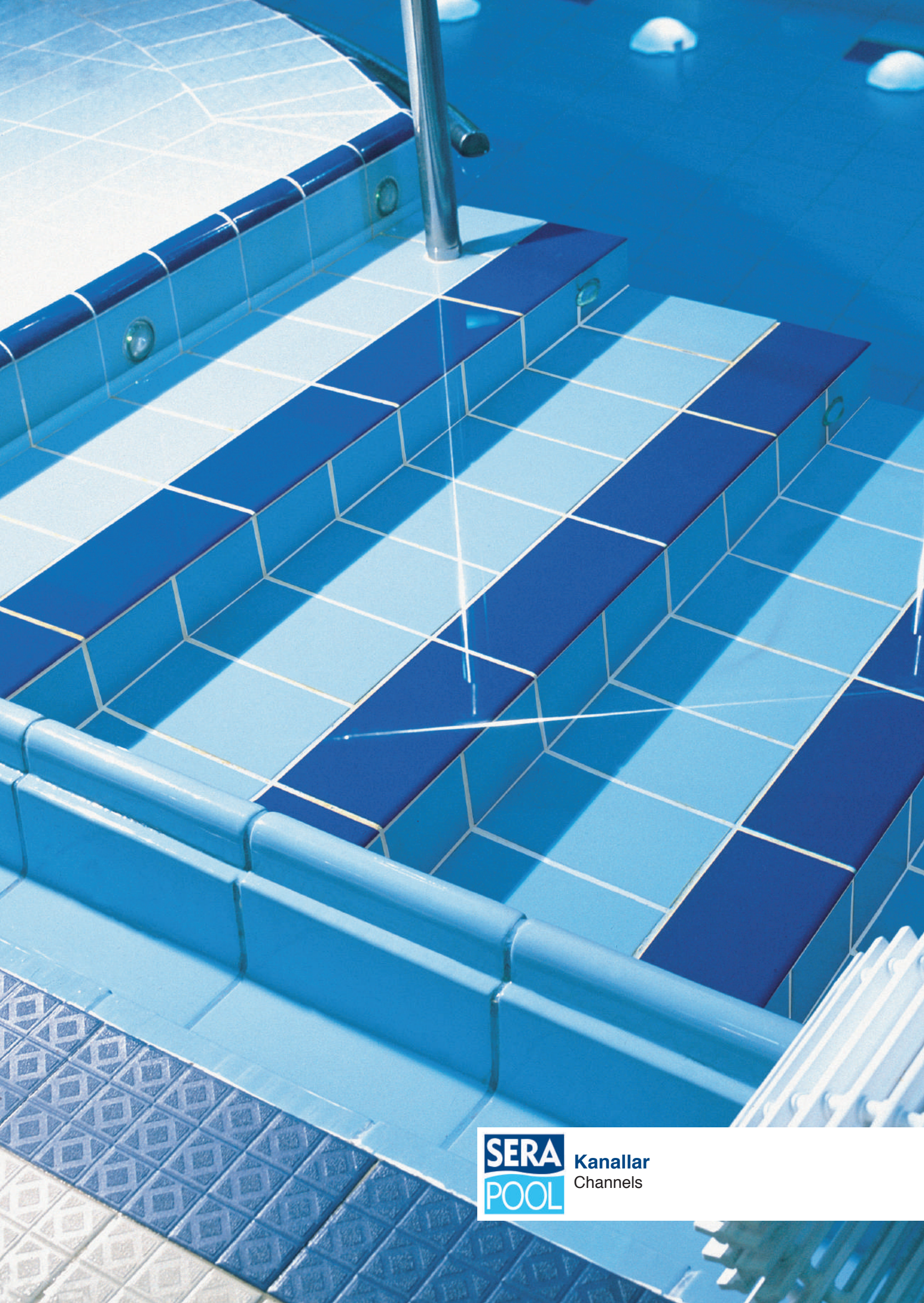

**SERA** Kanallar  
**POOL** Channels



**Tünel Sistem**

## Tunnel System

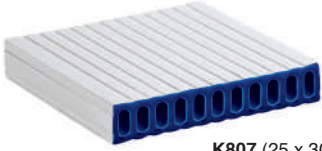

**K807** (25 x 30 cm)  
Tünel Sistem (Kobalt - Sırsız)  
Tunnel System (Cobalt - Unglazed)



**K701** (20 x 25 cm)  
Tünel Kanalı (Açık Mavi)  
Tunnel Channel (Light Blue)



**K721** (20 x 25 cm)  
Tünel Kanalı Delikli (Açık Mavi)  
Tunnel Channel With Outlet  
(Light Blue)



**K731** (20 x 20 cm)  
Tünel Kanalı İç Köşe  
(Açık Mavi)  
Tunnel Channel Internal  
Corner (Light Blue)



**K741** (21,8 x 21,8 cm)  
Tünel Kanalı Dış Köşe (Açık Mavi)  
Tunnel Channel External  
Corner (Light Blue)

**İçten Taşma Kanalı – 1 (Açık Mavi)**

## Internal Overflow Channel – 1 (Light Blue)

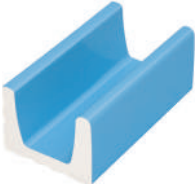

**K101** (15 x 25 cm)  
İçten Taşma Kanalı – 1  
(Açık Mavi)  
Internal Overflow Channel – 1  
(Light Blue)



**K121** (15 x 25 cm)  
İçten Taşma Kanalı – 1  
Delikli (Açık Mavi)  
Internal Overflow Channel  
– 1 With Outlet (Light Blue)

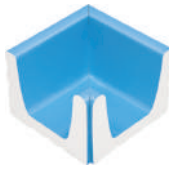

**K131** (15 x 15 cm)  
İçten Taşma Kanalı – 1  
İç Köşe (Açık Mavi)  
Internal Overflow Channel – 1  
Internal Corner (Light Blue)

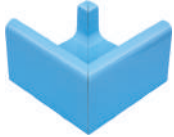

**K141** (15,5 x 15,5 cm)  
İçten Taşma Kanalı – 1  
Dış Köşe (Açık Mavi)  
Internal Overflow Channel – 1  
External Corner (Light Blue)



**K151** (15 x 12,5 cm)  
İçten Taşma Kanalı – 1  
Yarım Parça (Açık Mavi)  
Internal Overflow Channel – 1  
Half Piece (Light Blue)



**K161** (15 x 12,5 cm)  
İçten Taşma Kanalı – 1  
Yarım Parça Delikli (Açık Mavi)  
Internal Overflow Channel – 1  
Half Piece With Outlet (Light Blue)

**İçten Taşma Kanalı – 1 (Beyaz)**

## Internal Overflow Channel – 1 (White)



**K103** (15 x 25 cm)  
İçten Taşma Kanalı – 1  
(Beyaz)  
Internal Overflow Channel – 1  
(White)



**K123** (15 x 25 cm)  
İçten Taşma Kanalı – 1  
Delikli (Beyaz)  
Internal Overflow Channel – 1  
With Outlet (White)



**K133** (15 x 15 cm)  
İçten Taşma Kanalı – 1  
İç Köşe (Beyaz)  
Internal Overflow Channel – 1  
Internal Corner (White)



**K143** (15,5 x 15,5 cm)  
İçten Taşma Kanalı – 1  
Dış Köşe (Beyaz)  
Internal Overflow Channel – 1  
External Corner (White)



**K153** (15 x 12,5 cm)  
İçten Taşma Kanalı – 1  
Yarım Parça (Beyaz)  
Internal Overflow Channel – 1  
Half Piece (White)



**K163** (15 x 12,5 cm)  
İçten Taşma Kanalı – 1  
Yarım Parça Delikli (Beyaz)  
Internal Overflow Channel – 1  
Half Piece With Outlet (White)

## İçten Taşma Kanalı – 1 (Gri)

Internal Overflow Channel – 1 (Grey)



**K109.1** (15 x 25 cm)  
İçten Taşma Kanalı – 1 (Gri)  
Internal Overflow Channel – 1  
(Grey)



**K129.1** (15 x 25 cm)  
İçten Taşma Kanalı – 1 Delikli  
(Gri)  
Internal Overflow Channel – 1  
With Outlet (Grey)



**K139.1** (15 x 15 cm)  
İçten Taşma Kanalı – 1 İç Köşe (Gri)  
Internal Overflow Channel – 1  
Internal Corner (Grey)



**K149.1** (15,5 x 15,5 cm)  
İçten Taşma Kanalı – 1  
Dış Köşe (Gri)  
Internal Overflow Channel – 1  
External Corner (Grey)



**K159.1** (15 x 12,5 cm)  
İçten Taşma Kanalı – 1  
Yarım Parça (Gri)  
Internal Overflow Channel – 1  
Half Piece (Grey)



**K169.1** (15 x 12,5 cm)  
İçten Taşma Kanalı – 1  
Yarım Parça Delikli (Gri)  
Internal Overflow Channel – 1  
Half Piece With Outlet (Grey)

## İçten Taşma Kanalı – 1 (Kobalt)

Internal Overflow Channel – 1 (Cobalt)

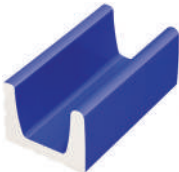

**K107** (15 x 25 cm)  
İçten Taşma Kanalı – 1 (Kobalt)  
Internal Overflow Channel – 1  
(Cobalt)

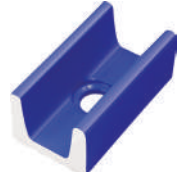

**K127** (15 x 25 cm)  
İçten Taşma Kanalı – 1 Delikli  
(Kobalt)  
Internal Overflow Channel – 1  
With Outlet (Cobalt)



**K137** (15 x 15 cm)  
İçten Taşma Kanalı – 1 İç Köşe  
(Kobalt)  
Internal Overflow Channel – 1  
Internal Corner (Cobalt)

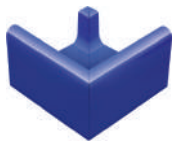

**K147** (15,5 x 15,5 cm)  
İçten Taşma Kanalı – 1  
Dış Köşe (Kobalt)  
Internal Overflow Channel – 1  
External Corner (Cobalt)



**K157** (15 x 12,5 cm)  
İçten Taşma Kanalı – 1  
Yarım Parça (Kobalt)  
Internal Overflow Channel – 1  
Half Piece (Cobalt)



**K167** (15 x 12,5 cm)  
İçten Taşma Kanalı – 1  
Yarım Parça Delikli (Kobalt)  
Internal Overflow Channel – 1  
Half Piece with Outlet (Cobalt)

## İçten Taşma Kanalı – 2 (Açık Mavi)

Internal Overflow Channel – 2 (Light Blue)

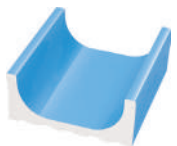

**K201** (23,8 x 25 cm)  
İçten Taşma Kanalı – 2  
(Açık Mavi)  
Internal Overflow Channel – 2  
(Light Blue)

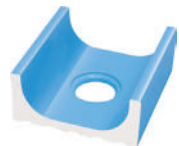

**K221** (23,8 x 25 cm)  
İçten Taşma Kanalı – 2 Delikli  
(Açık Mavi)  
Internal Overflow Channel – 2  
With Outlet (Light Blue)



**K231** (23,8 x 23,8 cm)  
İçten Taşma Kanalı – 2 İç Köşe  
(Açık Mavi)  
Internal Overflow Channel – 2  
Internal Corner (Light Blue)

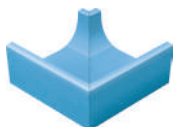

**K241** (24,4 x 24,4 cm)  
İçten Taşma Kanalı – 2 Dış Köşe  
(Açık Mavi)  
Internal Overflow Channel – 2  
External Corner (Light Blue)



**K251** (23,8 x 12,5 cm)  
İçten Taşma Kanalı – 2 Yarım  
Parça (Açık Mavi)  
Internal Overflow Channel – 2  
Half Piece (Light Blue)



**K261** (23,8 x 12,5 cm)  
İçten Taşma Kanalı – 2  
Yarım Parça Delikli (Açık Mavi)  
Internal Overflow Channel – 2 Half  
Piece with outlet (Light Blue)



## Savak Kanalı - 1 (Açık Mavi)

Weir Channel - 1 (Light Blue)

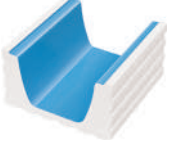

**K601** (22,3 x 25 cm)  
Savak Kanalı - 1 (Açık Mavi)  
Weir Channel - 1 (Light Blue)

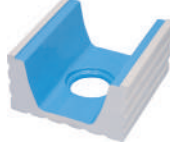

**K621** (22,3 x 25 cm)  
Savak Kanalı - 1 Delikli  
(Açık Mavi)  
Weir Channel - 1 With Outlet  
(Light Blue)



**K631** (22,3 x 23 cm)  
Savak Kanalı - 1 İç Köşe  
(Açık Mavi)  
Weir Channel - 1 Internal Corner  
(Light Blue)



**K651** (22,3 x 12,5 cm)  
Savak Kanalı - 1 Yarım  
Parça (Açık Mavi)  
Weir Channel - 1 Half Piece  
(Light Blue)

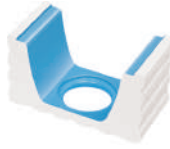

**K661** (22,3 x 12,5 cm)  
Savak Kanalı - 1 Yarım Parça Delikli  
(Açık Mavi)  
Weir Channel - 1 Half Piece  
With Outlet (Light Blue)

## Savak Kanalı - 2 (Açık Mavi)

Weir Channel - 2 (Light Blue)

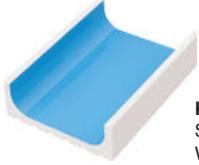

**K501** 18 x 25 cm)  
Savak Kanalı - 2 (Açık Mavi)  
Weir Channel - 2 (Light Blue)

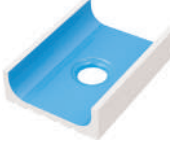

**K521** (18 x 25 cm)  
Savak Kanalı - 2 Delikli (Açık Mavi)  
Weir Channel - 2 With Outlet  
(Light Blue)



**K531** (18 x 18,7 cm)  
Savak Kanalı - 2 İç Köşe  
(Açık Mavi)  
Weir Channel - 2  
Internal Corner (Light Blue)

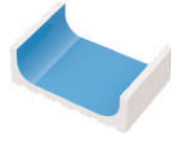

**K551** (18 x 12,5 cm)  
Savak Kanalı - 2 Yarım Parça  
(Açık Mavi)  
Weir Channel - 2 Half Piece  
(Light Blue)

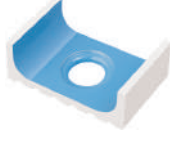

**K561** (18 x 12,5 cm)  
Savak Kanalı - 2 Yarım Parça Delikli  
(Açık Mavi)  
Weir Channel - 2 Half Piece  
With Outlet (Light Blue)

## Üstten Taşma Kanalı Tutamaklı - 1 (Açık Mavi)

Top Overflow Channel with Handle - 1 (Light Blue)



**K301** (23,8 x 25 cm)  
Üstten Taşma Kanalı - 1  
(Açık Mavi)  
Top Overflow Channel - 1  
(Light Blue)



**K321** (23,8 x 25 cm)  
Üstten Taşma Kanalı - 1 Delikli  
(Açık Mavi)  
Top Overflow Channel - 1  
With Outlet (Light Blue)



**K331** (23,8 x 23,8 cm)  
Üstten Taşma Kanalı - 1  
İç Köşe (Açık Mavi)  
Top Overflow Channel - 1  
Internal Corner (Light Blue)

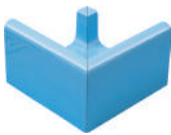

**K341** (24,4 x 24,4 cm)  
Üstten Taşma Kanalı - 1  
Dış Köşe (Açık Mavi)  
Top Overflow Channel - 1  
External Corner (Light Blue)



**K351** (23,8 x 12,5 cm)  
Üstten Taşma Kanalı - 1  
Yarım Parça (Açık Mavi)  
Top Overflow Channel - 1  
Half Piece (Light Blue)

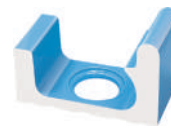

**K361** (23,8 x 12,5 cm)  
Üstten Taşma Kanalı - 1  
Yarım Parça Delikli (Açık Mavi)  
Top Overflow Channel - 1  
Half Piece With Outlet  
(Light Blue)

## Üstten Taşma Kanalı Tutamaklı – 1 (Beyaz)

Top Overflow Channel with Handle – 1 (White)



**K303** (23,8 x 25 cm)  
Üstten Taşma Kanalı – 1 (Beyaz)  
Top Overflow Channel – 1 (White)



**K323** (23,8 x 25 cm)  
Üstten Taşma Kanalı – 1  
Delikli (Beyaz)  
Top Overflow Channel – 1  
With Outlet (White)



**K333** (23,8 x 23,8 cm)  
Üstten Taşma Kanalı – 1 İç Köşe  
(Beyaz)  
Top Overflow Channel – 1  
Internal Corner (White)



**K343** (24,4 x 24,4 cm)  
Üstten Taşma Kanalı – 1  
Dış Köşe (Beyaz)  
Top Overflow Channel – 1  
External Corner (White)



**K353** (23,8 x 12,5 cm)  
Üstten Taşma Kanalı – 1  
Yarım Parça (Beyaz)  
Top Overflow Channel – 1  
Half Piece (White)



**K441** (23,8 x 12,5 cm)  
Üstten taşma kanalı – 1  
Yarım Parça Delikli (Beyaz)  
Top Overflow Channel – 1 Half  
Piece with Outlet (White)

## Üstten Taşma Kanalı Tutamaklı – 1 (Gri)

Top Overflow Channel with Handle – 1 (Grey)



**K309.1** (23,8 x 25 cm)  
Üstten Taşma Kanalı – 1 (Gri)  
Top Overflow Channel – 1 (Grey)



**K329.1** (23,8 x 25 cm)  
Üstten Taşma Kanalı – 1 Delikli  
(Gri)  
Top Overflow Channel – 1  
With Outlet (Grey)



**K339.1** (23,8 x 23,8 cm)  
Üstten taşma kanalı – 1  
İç Köşe (Gri)  
Top Overflow Channel – 1  
Internal Corner (Grey)



**K349.1** (24,4 x 24,4 cm)  
Üstten Taşma Kanalı – 1  
Dış Köşe (Grey)  
Top Overflow Channel – 1  
External Corner (Grey)



**K359.1** (23,8 x 12,5 cm)  
Üstten Taşma Kanalı – 1  
Yarım Parça (Gri)  
Top Overflow Channel – 1  
Half Piece (Grey)



**K369.1** (23,8 x 12,5 cm)  
Üstten Taşma Kanalı – 1  
Yarım Parça Delikli (Gri)  
Top Overflow Channel – 1  
Half Piece With Outlet (Grey)

## Üstten Taşma Kanalı Tutamaklı – 1 (Kobalt)

Top Overflow Channel with Handle – 1 (Cobalt)



**K307** (23,8 x 25 cm)  
Üstten Taşma Kanalı – 1 (Kobalt)  
Top Overflow Channel – 1  
(Cobalt)



**K327** (23,8 x 25 cm)  
Üstten Taşma Kanalı – 1  
Delikli (Kobalt)  
Top Overflow Channel – 1  
With Outlet (Cobalt)



**K337** (23,8 x 23,8 cm)  
Üstten Taşma Kanalı – 1  
İç Köşe (Kobalt)  
Top Overflow Channel – 1  
Internal Corner (Cobalt)

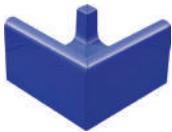

**K347** (24,4 x 24,4 cm)  
Üstten Taşma Kanalı – 1  
Dış Köşe (Kobalt)  
Top Overflow Channel – 1  
External Corner (Cobalt)



**K357** (23,8 x 12,5 cm)  
Üstten Taşma Kanalı – 1  
Yarım Parça (Kobalt)  
Top Overflow Channel – 1  
Half Piece (Cobalt)

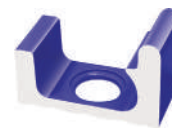

**K367** (23,8 x 12,5 cm)  
Üstten Taşma Kanalı – 1  
Yarım Parça Delikli (Kobalt)  
Top Overflow Channel – 1  
Half Piece With Outlet (Cobalt)



**Üstten Taşma Kanalı – 3 (Açık Mavi)**

Top Overflow Channel – 3 (Light Blue)

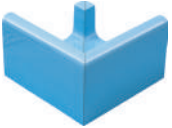
**K401** (28,6 x 25 cm)  
Üstten Taşma Kanalı – 3  
(Açık Mavi)  
Top Overflow Channel  
With Handle – 3 (Light Blue)**K421** (28,6 x 25 cm)  
Üstten Taşma Kanalı – 3 Delikli  
(Açık Mavi)  
Top Overflow Channel  
With Handle – 3 With Outlet  
(Light Blue)**K431** (28,6 x 28,6 cm)  
Üstten Taşma Kanalı – 3  
İç Köşe (Açık Mavi)  
Top Overflow Channel – 3  
Internal Corner (Light Blue)**K441** (29,2 x 29,2 cm)  
Üstten Taşma Kanalı – 3 Dış Köşe  
(Açık Mavi)  
Top Overflow Channel – 3  
External Corner (Light Blue)**K451** (28,6 x 12,5 cm)  
Üstten Taşma Kanalı – 3  
Yarım Parça (Açık Mavi)  
Top Overflow Channel – 3  
Half Piece (Light Blue)**K461** (28,6 x 12,5 cm)  
Üstten Taşma Kanalı – 3  
Yarım Parça Delikli (Açık Mavi)  
Top Overflow Channel – 3  
Half Piece With Outlet (Light Blue)**Üstten Taşma Kanalı Tutamaklı – 3 (Beyaz)**

Top Overflow Channel with Handle – 3 (White)

**K403** (28,6 x 25 cm)  
Üstten Taşma Kanalı – 3  
(Beyaz)  
Top Overflow Channel – 3  
(White)**K423** (28,6 x 25 cm)  
Üstten Taşma Kanalı – 3  
Delikli (Beyaz)  
Top Overflow Channel – 3  
(White)**K433** (28,6 x 28,6 cm)  
Üstten Taşma Kanalı – 3  
Yarım Parça (Beyaz)  
Top Overflow Channel – 3  
Half Piece (White)**K443** (29,2 x 29,2 cm)  
Üstten Taşma Kanalı – 3  
Yarım Parça Delikli (Beyaz)  
Top Overflow Channel – 3  
Half Piece With Outlet (White)**K453** (28,6 x 12,5 cm)  
Üstten Taşma Kanalı – 3  
İç Köşe (Beyaz)  
Top Overflow Channel – 3  
Internal Corner (White)**K463** (28,6 x 12,5 cm)  
Üstten Taşma Kanalı – 3  
Dış Köşe (Beyaz)  
Top Overflow Channel – 3  
External Corner (White)**Üstten Taşma Kanalı Tutamaklı – 3 (Gri)**

Top Overflow Channel with Handle – 3 (Grey)

**K409.1** (28,6 x 25 cm)  
Üstten Taşma Kanalı – 3 (Gri)  
Top Overflow Channel – 3  
(Grey)**K429.1** (28,6 x 25 cm)  
Üstten Taşma Kanalı – 3  
Delikli (Gri)  
Top Overflow Channel – 3  
With Outlet (Grey)**K439.1** (28,6 x 28,6 cm)  
Üstten taşma kanalı – 3  
İç Köşe (Gri)  
Top Overflow Channel – 3  
Internal Corner (Grey)**K449.1** (29,2 x 29,2 cm)  
Üstten taşma kanalı – 3  
Dış Köşe (Gri)  
Top Overflow Channel – 3  
External Corner (Grey)**K459.1** (28,6 x 12,5 cm)  
Üstten Taşma Kanalı – 3  
Yarım Parça (Gri)  
Top Overflow Channel – 3  
Half Piece (Grey)**K469.1** (29 x 12,5 cm)  
Üstten taşma kanalı – 3  
Yarım Parça Delikli (Gri)  
Top Overflow Channel – 3  
Half Piece with outlet (Grey)

## Üstten Taşma Kanalı Tutamaklı – 3 (Kobalt)

Top Overflow Channel with Handle – 3 (Cobalt)



**K407** (28,6 x 25 cm)  
Üstten Taşma Kanalı – 3  
(Kobalt)  
Top Overflow Channel – 3  
(Cobalt)



**K427** (28,6 x 25 cm)  
Üstten Taşma Kanalı – 3  
Delikli (Kobalt)  
Top Overflow Channel – 3  
With Outlet (Cobalt)



**K437** (28,6 x 28,6 cm)  
Üstten taşma kanalı – 3 İç Köşe  
(Kobalt)  
Top Overflow Channel – 3  
Internal Corner (Cobalt)



**K447** (29,2 x 29,2 cm)  
Üstten taşma kanalı – 3 Dış Köşe  
(Kobalt)  
Top Overflow channel – 3  
External Corner (Cobalt)



**K457** (28,6 x 12,5 cm)  
Üstten Taşma Kanalı – 3  
Yarım Parça (Kobalt)  
Top Overflow channel – 3  
Half Piece (Cobalt)



**K467** (28,6 x 12,5 cm)  
Üstten Taşma Kanalı – 3  
Yarım Parça Delikli (Kobalt)  
Top Overflow Channel – 3  
Half Piece (Cobalt)

## Profilli Kanal – 1 (Açık Mavi)

Niche Type Profiled Channel – 1 (Light Blue)



**KP101** (23,6 x 25 cm)  
Profilli Kanal – 1 (Açık Mavi)  
Niche Type Profiled Channel – 1  
(Light Blue)



**KP121** (23,6 x 25 cm)  
Profilli Kanal – 1 Delikli  
(Açık Mavi)  
Niche Type Profiled Channel – 1  
With Outlet (Light Blue)

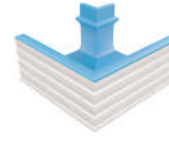

**KP131** (23,6 x 23,6 cm)  
Profilli Kanal – 1 İç Köşe  
(Açık Mavi)  
Niche Type Profiled Channel – 1  
Internal Corner (Light Blue)



**KP141** (24,2 x 24,2 cm)  
Profilli Kanal – 1 Dış Köşe  
(Açık Mavi)  
Niche Type Profiled Channel – 1  
External Corner (Light Blue)



**KP151** (23,6 x 12,5 cm)  
Profilli Kanal – 1 Yarım Parça  
(Açık Mavi)  
Niche Type Profiled Channel – 1  
Half Piece (Light Blue)



**KP161** (23,6 x 12,5 cm)  
Profilli Kanal – 1  
Yarım Parça Delikli (Açık Mavi)  
Niche Type Profiled Channel – 1  
Half Piece With Outlet (Light Blue)

## Profilli Kanal – 1 (Beyaz)

Niche Type Profiled Channel – 1 (White)



**KP103** (23,6 x 25 cm)  
Profilli Kanal – 1 (Beyaz)  
Niche Type Profiled Channel – 1  
(White)



**KP123** (23,6 x 25 cm)  
Profilli Kanal – 1 Delikli (Beyaz)  
Niche Type Profiled Channel – 1  
With Outlet (White)



**KP133** (23,6 x 23,6 cm)  
Profilli Kanal – 1 İç Köşe  
(Beyaz)  
Niche Type Profiled Channel – 1  
Internal Corner (White)



**KP143** (24,2 x 24,2 cm)  
Profilli Kanal – 1 Dış Köşe  
(Beyaz)  
Niche Type Profiled Channel – 1  
External Corner (White)



**KP153** (23,6 x 12,5 cm)  
Profilli Kanal – 1 Yarım Parça  
(Beyaz)  
Niche Type Profiled Channel – 1  
Half Piece (White)



**KP163** (23,6 x 12,5 cm)  
Profilli Kanal – 1  
Yarım Parça Delikli (Beyaz)  
Niche Type Profiled Channel – 1  
Half Piece With Outlet (White)



**Profilli Kanal – 1 (Gri)**

## Niche Type Profiled Channel – 1 (Grey)

**KP109.1** (23,6 x 25 cm)  
Profilli Kanal – 1 (Gri)  
Niche Type Profiled Channel – 1  
(Grey)**KP129.1** (23,6 x 25 cm)  
Profilli Kanal – 1 Delikli (Gri)  
Niche Type Profiled Channel – 1  
With Outlet (Grey)**KP139.1** (23,6 x 23,6 cm)  
Profilli Kanal – 1 İç Köşe (Gri)  
Niche Type Profiled Channel – 1  
Internal Corner (Grey)**KP149.1** (24,2 x 24,2 cm)  
Profilli Kanal – 1 Dış Köşe (Gri)  
Niche Type Profiled Channel – 1  
External Corner (Grey)**KP159.1** (23,6 x 12,5 cm)  
Profilli Kanal – 1 Yarım Parça (Gri)  
Niche Type Profiled Channel – 1  
Half Piece (Grey)**KP169.1** (23,6 x 12,5 cm)  
Profilli Kanal – 1  
Yarım Parça Delikli (Gri)  
Niche Type Profiled Channel – 1  
Half Piece With Outlet (Grey)**Profilli Kanal – 1 (Kobalt)**

## Niche Type Profiled Channel – 1 (Cobalt)

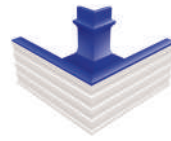
**KP107** (23,6 x 25 cm)  
Profilli Kanal – 1 (Kobalt)  
Niche Type Profiled Channel – 1  
(Cobalt)**KP127** (23,6 x 25 cm)  
Profilli Kanal – 1 Delikli (Kobalt)  
Niche Type Profiled Channel – 1  
With Outlet (Cobalt)**KP137** (23,6 x 23,6 cm)  
Profilli Kanal – 1 İç Köşe (Kobalt)  
Niche Type Profiled Channel – 1  
Internal Corner (Cobalt)**KP147** (24,2 x 24,2 cm)  
Profilli Kanal – 1 Dış Köşe  
(Kobalt)  
Niche Type Profiled Channel – 1  
External Corner (Cobalt)**KP157** (23,6 x 12,5 cm)  
Profilli Kanal – 1  
Yarım Parça (Kobalt)  
Niche Type Profiled Channel – 1  
Half Piece (Cobalt)**KP167** (23,6 x 12,5 cm)  
Profilli Kanal – 1  
Yarım Parça Delikli (Kobalt)  
Niche Type Profiled Channel – 1  
Half Piece With Outlet (Cobalt)**Profilli Kanal – 2 (Açık Mavi)**

## Niche Type Profiled Channel – 2 (Light Blue)

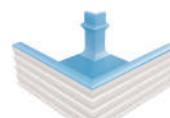
**KP201** (29,1 x 25 cm)  
Profilli Kanal – 2 (Açık Mavi)  
Niche Type Profiled Channel – 2  
(Light Blue)**KP221** (29,1 x 25 cm)  
Profilli Kanal – 2 Delikli (Açık Mavi)  
Niche Type Profiled Channel – 2  
With Outlet (Light Blue)**KP231** (29,1 x 29,1cm)  
Profilli Kanal – 2 İç Köşe  
(Açık Mavi)  
Niche Type Profiled Channel – 2  
Internal Corner (Light Blue)**KP241** (29,7 x 29,7 cm)  
Profilli Kanal – 2 Dış Köşe  
(Açık Mavi)  
Niche Type Profiled Channel – 2  
External Corner (Light Blue)**KP251** (29,1 x 12,5 cm)  
Profilli Kanal – 2 Yarım Parça  
(Açık Mavi)  
Niche Type Profiled Channel – 2  
Half Piece (Light Blue)**KP261** (29,1 x 12,5 cm)  
Profilli Kanal – 2  
Yarım Parça Delikli (Açık Mavi)  
Niche Type Profiled Channel – 2  
Half Piece With Outlet (Light Blue)

## Profilli Kanal – 2 (Beyaz)

### Niche Type Profiled Channel – 2 (White)



**KP203** (29,1 x 25 cm)  
Profilli Kanal – 2 (Beyaz)  
Niche Type Profiled Channel – 2  
(White)



**KP223** (29,1 x 25 cm)  
Profilli Kanal – 2 Delikli (Beyaz)  
Niche Type Profiled Channel – 2  
With Outlet (White)



**KP233** (29,1 x 29,1 cm)  
Profilli Kanal – 2 İç Köşe (Beyaz)  
Niche Type Profiled Channel – 2  
Internal Corner (White)



**KP243** (29,7 x 29,7 cm)  
Profilli Kanal – 2 Dış Köşe  
(Beyaz)  
Niche Type Profiled Channel – 2  
External Corner (White)



**KP253** (29,1 x 12,5 cm)  
Profilli Kanal – 2 Yarım Parça  
(Beyaz)  
Niche Type Profiled Channel – 2  
Half Piece (White)



**KP263** (29,1 x 12,5 cm)  
Profilli Kanal – 2  
Yarım Parça Delikli (Beyaz)  
Niche Type Profiled Channel – 2  
Half Piece With Outlet (White)

## Profilli Kanal – 2 (Gri)

### Niche Type Profiled Channel – 2 (Grey)



**KP209.1** (29,1 x 25 cm)  
Profilli Kanal – 2 (Gri)  
Niche Type Profiled Channel – 2  
(Grey)



**KP229.1** (29,1 x 25 cm)  
Profilli Kanal – 2 Delikli (Gri)  
Niche Type Profiled Channel – 2  
With Outlet (Grey)



**KP239.1** (29,1 x 29,1 cm)  
Profilli Kanal – 2 İç Köşe (Gri)  
Niche Type Profiled Channel – 2  
Internal Corner (Grey)



**KP249.1** (29,7 x 29,7 cm)  
Profilli Kanal – 2 Dış Köşe (Gri)  
Niche Type Profiled Channel – 2  
External Corner (Grey)



**KP259.1** (29,1 x 12,5 cm)  
Profilli Kanal – 2 Yarım Parça (Gri)  
Niche Type Profiled Channel – 2  
Half Piece (Grey)



**KP269.1** (29,1 x 12,5 cm)  
Profilli Kanal – 2 Yarım Parça  
Delikli (Gri)  
Niche Type Profiled Channel – 2  
Half Piece With Outlet (Grey)

## Profilli Kanal – 2 (Kobalt)

### Niche Type Profiled Channel – 2 (Cobalt)



**KP207** (29,1 x 25 cm)  
Profilli Kanal – 2 (Kobalt)  
Niche Type Profiled Channel – 2  
(Cobalt)



**KP227** (29,1 x 25 cm)  
Profilli Kanal – 2 Delikli (Kobalt)  
Niche Type Profiled Channel – 2  
With Outlet (Cobalt)

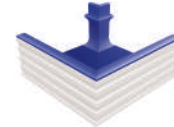

**KP237** (29,1 x 29,1 cm)  
Profilli Kanal – 2  
İç Köşe (Kobalt)  
Niche Type Profiled Channel – 2  
Internal Corner (Cobalt)



**KP247** (29,7 x 29,7 cm)  
Profilli Kanal – 2 Dış Köşe  
(Kobalt)  
Niche Type Profiled Channel – 2  
External Corner (Cobalt)



**KP257** (29,1 x 12,5 cm)  
Profilli Kanal – 2 Yarım Parça  
(Kobalt)  
Niche Type Profiled Channel – 2  
Half Piece (Cobalt)



**KP267** (29,1 x 12,5 cm)  
Profilli Kanal – 2  
Yarım Parça Delikli (Kobalt)  
Niche Type Profiled Channel – 2  
Half Piece With Outlet (Cobalt)





**SERA** Izgaralar  
**POOL** Gratings



## Porselen Izgara ve Köşesi - Pötikare

Porcelain Grating and Corner - Petit Carre



**IP900** (25 x 50 cm)  
Porselen Izgara Pötikare (Sırsız)  
Porcelain Grating Petit Carre  
(Unglazed)

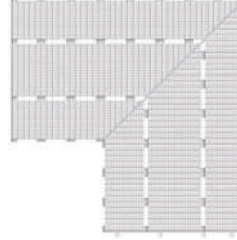

**IP900K** (38,5 x 38,5 cm)  
Porselen Izgara Pötikare Köşe (Sırsız)  
Porcelain Grating Petit Carre Corner  
(Unglazed)

## Porselen Izgara ve Köşeleri - Apache

Porcelain Grating and Corner - Apache

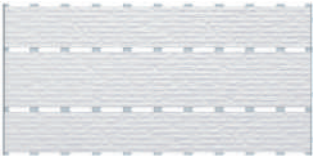

**IA900** (25 x 50 cm)  
Porselen Izgara Apache (Sırsız)  
Porcelain Grating Apache  
(Unglazed)



**IA900K** (38,5 x 38,5 cm)  
Porselen Izgara Apache Köşe (Sırsız)  
Porcelain Grating Apache Corner  
(Unglazed)



**IA909.1** (25 x 50 cm)  
Porselen Izgara Apache (Gri)  
Porcelain Grating Apache (Grey)



**IA909.1K** (38,5 x 38,5 cm)  
Porselen Izgara Apache Köşe (Gri)  
Porcelain Grating Apache Corner  
(Grey)



**IA909.2** (25 x 50 cm)  
Porselen Izgara Apache  
(Antrasit Gri)  
Porcelain Grating Apache  
(Anthracite Grey)



**IA909.2K** (38,5 x 38,5 cm)  
Porselen Izgara Apache Köşe  
(Antrasit Gri)  
Porcelain Grating Apache Corner  
(Anthracite Grey)

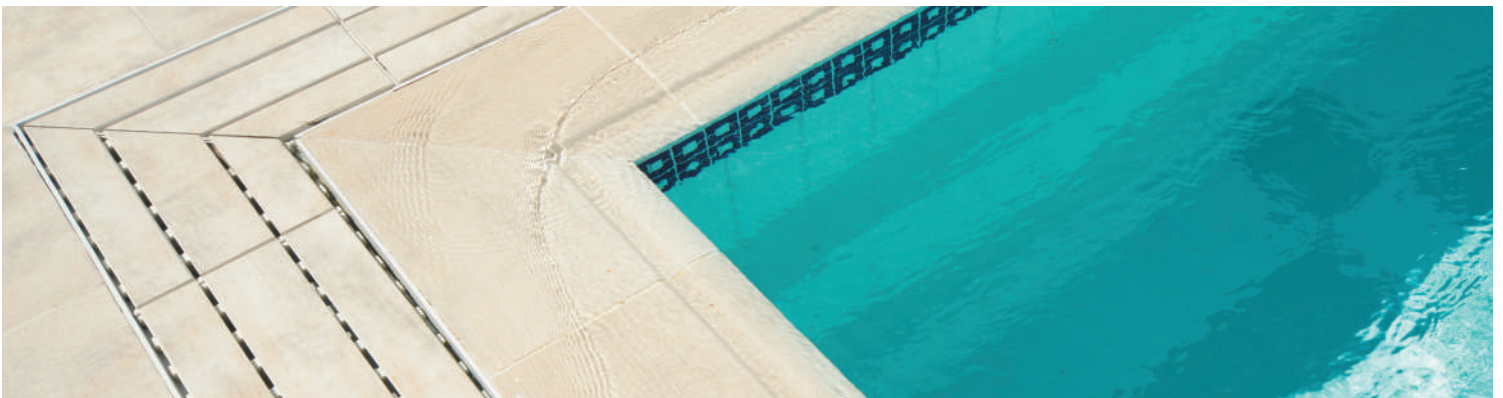



## Porselen Izgara ve Köşesi - Pötikare

Porcelain Grating and Corner - Petit Carre



**IP910** (20 x 50 cm)  
Porselen Izgara Pötikare (Sırsız)  
Porcelain Grating Petit Carre (Unglazed)

## Porselen Izgara ve Köşeleri - Apache

Porcelain Grating and Corner - Apache



**IA910** (20 x 50 cm)  
Porselen Izgara Apache (Sırsız)  
Porcelain Grating Apache  
(Unglazed)



**IA919.1** (20 x 50 cm)  
Porselen Izgara Apache (Gri)  
Porcelain Grating Apache (Grey)



**IA919.2** (20 x 50 cm)  
Porselen Izgara Apache (Antrasit Gri)  
Porcelain Grating Apache  
(Anthracite Grey)



## Paslanmaz Telli ABS Izgaralar

### Stainless Steel Wire ABS Grating

#### TEK GEÇMELİ SINGLE JOINT



**00023.1** (20 cm)  
Paslanmaz Telli ABS Izgara (Krem)  
ABS Grating With Stainless Steel Wire Rope  
(Cream)



**00028.1** (25 cm)  
Paslanmaz Telli ABS Izgara (Krem)  
ABS Grating With Stainless Steel Wire Rope  
(Cream)



**\*00028.3** (25 cm)  
Paslanmaz Telli ABS Izgara (Gri)  
ABS Grating With Stainless Steel Wire Rope  
(Grey)

#### ÇİFT GEÇMELİ DOUBLE JOINT



**00020.1** (20 cm)  
Paslanmaz Telli ABS Izgara (Krem)  
ABS Grating With Stainless Steel Wire  
Rope (Cream)



**00025.1** (25 cm)  
Paslanmaz Telli ABS Izgara (Krem)  
ABS Grating With Stainless Steel Wire Rope  
(Cream)



**\*00025.3** (25 cm)  
Paslanmaz Telli ABS Izgara (Gri)  
ABS Grating With Stainless Steel Wire Rope  
(Grey)

#### IZGARA KÖŞELERİ 90° GRATING CORNERS 90°



**00021.1** (20 cm)  
ABS Izgara Köşesi 90° (Krem)  
Wire Rope ABS Grating Corner 90°(Cream)

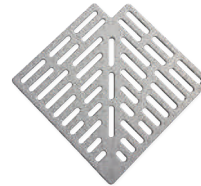

**00026.1** (25 cm)  
ABS Izgara Köşesi 90° (Krem)  
Wire Rope ABS Grating Corner 90° (Cream)

#### IZGARA KÖŞELERİ 45° GRATING CORNERS 45°



**00022.1** (20 cm)  
ABS Izgara Köşesi 45° (Krem)  
Wire Rope ABS Grating Corner 45° (Cream)



**00027.1** (25 cm)  
ABS Izgara Köşesi 45° (Krem)  
Wire Rope ABS Grating Corner 45°(Cream)

#### IZGARA PROFİLLERİ GRATING PROFILES



**00011.1**  
PVC Köşebent (Krem)  
PVC Angle (Cream)



**\*00011.3**  
PVC Köşebent (Gri)  
PVC Angle (Grey)

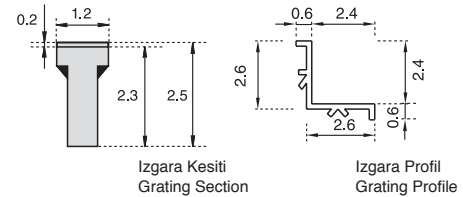





**SERA**  
**POOL**

**Aksesuarlar**  
Accessories



## Duř Teknesi 1 - Özel Parçalar

### Shower Tub 1 - Special Pieces



**97103** (12,5 x 12,5 cm)  
Ara Parça (Beyaz)  
Trim Piece (White)



**97133** (12,5 x 12,5 cm)  
İç Köşe (Beyaz)  
Internal Corner (White)



**97123** (12,5 x 12,5 cm)  
İç Parça (Beyaz)  
Internal Piece (White)



**97143** (12,5 x 12,5 cm)  
İç Parça Diagonal (Beyaz)  
Diagonal Internal Piece (White)



**97153** (12,5 x 12,5 cm)  
İç Parça Orta (Beyaz)  
Internal Middle Piece (White)

## Duř Teknesi 2

### Shower Tub 2



**99103** (10,5 x 25 cm)  
Duř Teknesi 2 (Beyaz)  
Shower Tub 2 (White)

## Yağmur Kanalları

### Rain Channels



**70100** (12,5 x 25 cm)  
Yağmur Kanalı (Sırsız)  
Rain Channels (Unglazed)



**70110** (12,5 x 25 cm)  
Yağmur Kanalı Delikli (Sırsız)  
Perforated Rain Channels (Unglazed)



**70120** (12,5 x 25 cm)  
Yağmur Kanalı Tek Taraf (Sırsız)  
One-Sided Rain Channel (Unglazed)



**70130** (12,5 x 12,5 cm)  
Yağmur Kanalı Köşe (Sırsız)  
Rain Channels Corner (Unglazed)

## Süpürgelik

### Cove Base



**66100** (10 x 20 cm)  
Süpürgelik (Sırsız)  
Cove Base (Unglazed)



**66110**  
Süpürgelik İç Köşe (Sırsız)  
Cove Base Internal Corner (Unglazed)



**66120**  
Süpürgelik Dış Köşe (Sırsız)  
Cove Base External Corner (Unglazed)

## Süzgeçler

### Filters



**00076.3**  
ABS Sessiz Boşaltma Süzgeci  
(Mavi) Ø75  
ABS Silent Drain Filter (Blue) Ø75



**00010**  
Metal Süzgeç Ø50  
Metal Drain + Filter Ø50



**00075**  
Metal Süzgeç Ø75  
Metal Drain + Filter Ø75







## Agora Rölyef Karolar

### Agora Relief Tiles

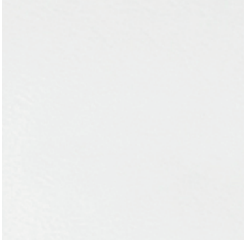

**25403** (25 x 25 cm)  
Agora Rölyef Karo (Beyaz)  
Agora Relief Tiles (White)



**25407** (25 x 25 cm)  
Agora Rölyef Karo (Kobalt)  
Agora Relief Tiles (Cobalt)



**25402** (25 x 25 cm)  
Agora Rölyef Karo (Yeşil)  
Agora Relief Tiles (Green)



**25402.3** (25 x 25 cm)  
Agora Rölyef Karo (Turkuaz)  
Agora Relief Tiles (Turquoise)



**25405.2** (25 x 25 cm)  
Agora Rölyef Karo (Bordo)  
Agora Relief Tiles (Burgundy)

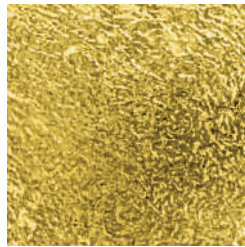

**25497** (25 x 25 cm)  
Agora Rölyef Karo (Altın)  
Agora Relief Tiles (Gold)

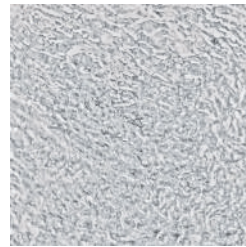

**25498** (25 x 25 cm)  
Agora Rölyef Karo (Platin)  
Agora Relief Tiles (Platinum)

## Agora & Lucido Rölyef Karolar - D

### Agora & Lucido Relief Tiles - D



**25403-D** (25 x 25 cm)  
Agora & Lucido Rölyef Karo (Beyaz)  
Agora & Lucido Relief Tiles (White)

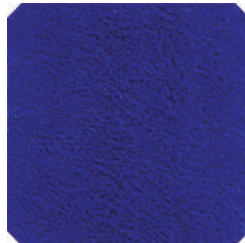

**25407** (25 x 25 cm)  
Agora & Lucido Rölyef Karo (Kobalt)  
Agora & Lucido Relief Tiles (Cobalt)



**25402** (25 x 25 cm)  
Agora & Lucido Rölyef Karo (Yeşil)  
Agora & Lucido Relief Tiles (Green)



**25402.3** (25 x 25 cm)  
Agora & Lucido Rölyef Karo (Turkuaz)  
Agora & Lucido Relief Tiles (Turquoise)



**25405.2** (25 x 25 cm)  
Agora & Lucido Rölyef Karo (Bordo)  
Agora & Lucido Relief Tiles (Burgundy)

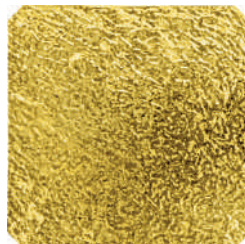

**25497** (25 x 25 cm)  
Agora & Lucido Rölyef Karo (Altın)  
Agora & Lucido Relief Tiles (Gold)

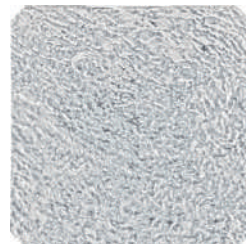

**25498** (25 x 25 cm)  
Agora & Lucido Rölyef Karo (Platin)  
Agora & Lucido Relief Tiles (Platinum)

## Lucido Aksesuarlar

### Lucido Accessories



**LD112** (2,5 x 2,5 cm)  
Lucido (Beyaz)  
Lucido (White)



**LD143** (2,5 x 2,5 cm)  
Lucido (Siyah)  
Lucido (Black)



**LD134** (2,5 x 2,5 cm)  
Lucido (Kobalt)  
Lucido (Cobalt)



**LD197** (2,5 x 2,5 cm)  
Lucido (Altın)  
Lucido (Gold)



**LD198** (2,5 x 2,5 cm)  
Lucido (Platin)  
Lucido (Platinum)



**LD199** (2,5 x 2,5 cm)  
Lucido (Bronz)  
Lucido (Bronze)



## Majesty Bordürler

### Majesty Borders



**BR634.A** (8 x 25 cm)  
Majesty Bordür (Kobalt)  
Majesty Border (Cobalt)



**BR697.A** (8 x 25 cm)  
Majesty Bordür (Altın)  
Majesty Border (Gold)



**BR698.A** (8 x 25 cm)  
Majesty Bordür (Platin)  
Majesty Border (Platinum)



**BR634.B** (8 x 23,5 x 27,5 cm)  
Majesty Bordür (Kobalt)  
Majesty Border (Cobalt)



**BR697.B** (8 x 23,5 x 27,5 cm)  
Majesty Bordür (Altın)  
Majesty Border (Gold)



**BR698.B** (8 x 23,5 x 27,5 cm)  
Majesty Bordür (Platin)  
Majesty Border (Platinum)

## Mare Bordürler

### Mare Borders



**BR712** (8,5 x 25 cm)  
Mare Bordür (Beyaz)  
Mare Border (White)



**BR797** (8,5 x 25 cm)  
Mare Bordür (Altın)  
Mare Border (Gold)



**BR798** (8,5 x 25 cm)  
Mare Bordür (Platin)  
Mare Border (Platinum)

## Antik Bordürler

### Antique Borders



**BR812** (5,75 x 25 cm)  
Antique Bordür (Beyaz)  
Antique Border (White)



**BR897** (5,75 x 25 cm)  
Antique Bordür (Altın)  
Antique Border (Gold)



**BR898** (5,75 x 25 cm)  
Antique Bordür (Platin)  
Antique Border (Platinum)

## Hera Bordürler

### Hera Borders



**BR1012** (7,2 x 25 cm)  
Hera Bordür (Beyaz)  
Hera Border (White)



**BR1097** (7,2 x 25 cm)  
Hera Bordür (Altın)  
Hera Border (Gold)



**BR1098** (7,2 x 25 cm)  
Hera Bordür (Platin)  
Hera Border (Platinum)

## Lugga Bordürler

### Lugga Borders

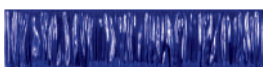

**BR1212** (7 x 25 cm)  
Lugga Bordür (Kobalt)  
Lugga Border (Cobalt)



**BR1297** (7 x 25 cm)  
Lugga Bordür (Altın)  
Lugga Border (Gold)



**BR1298** (7 x 25 cm)  
Lugga Bordür (Platin)  
Lugga Border (Platinum)





**Projelerimizden Bazıları**  
View Some of Our Projects



## Projelerimizden Bazıları

### View Some of Our Projects

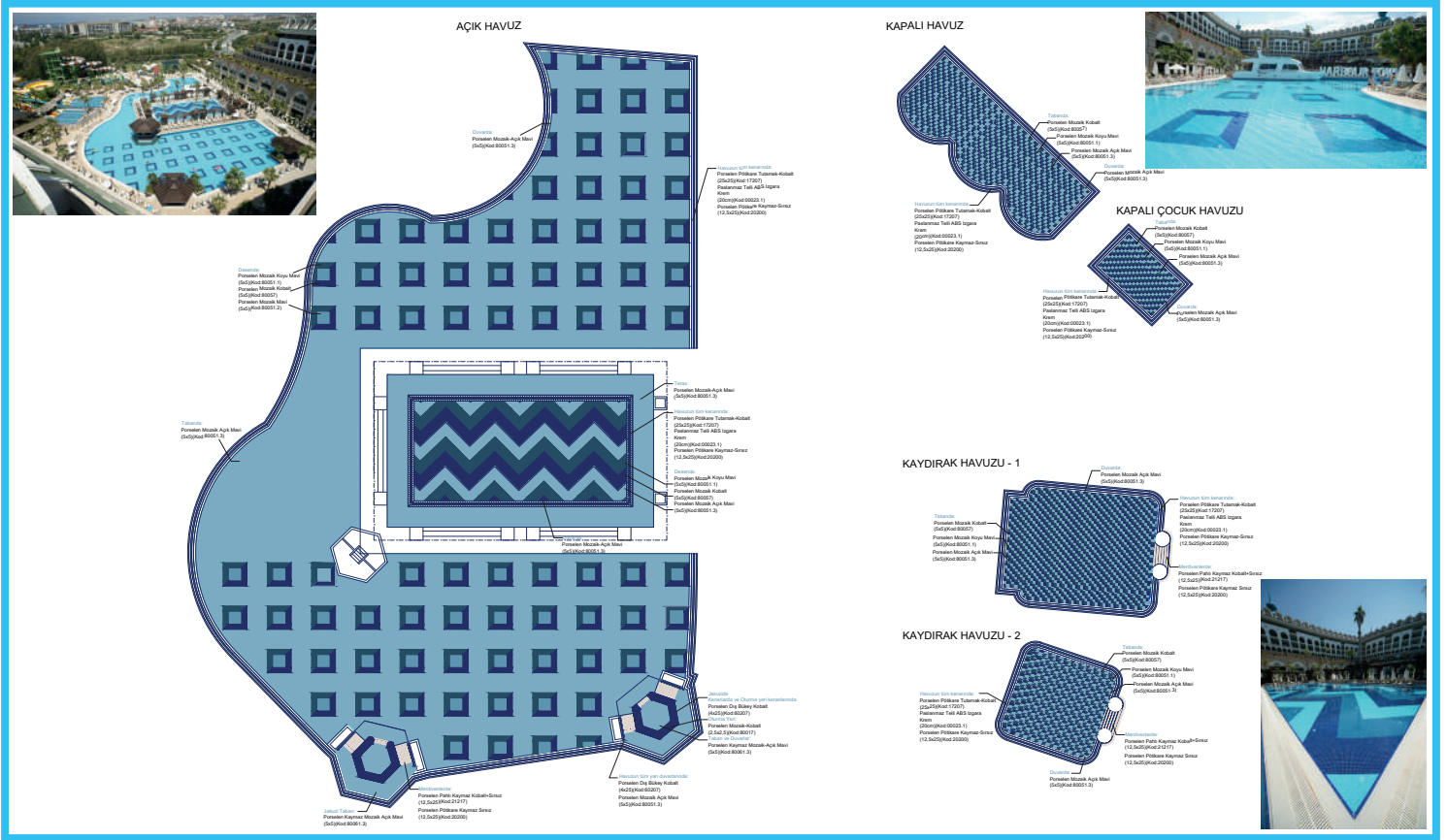

"Crystal Sunset Otel Projesi"

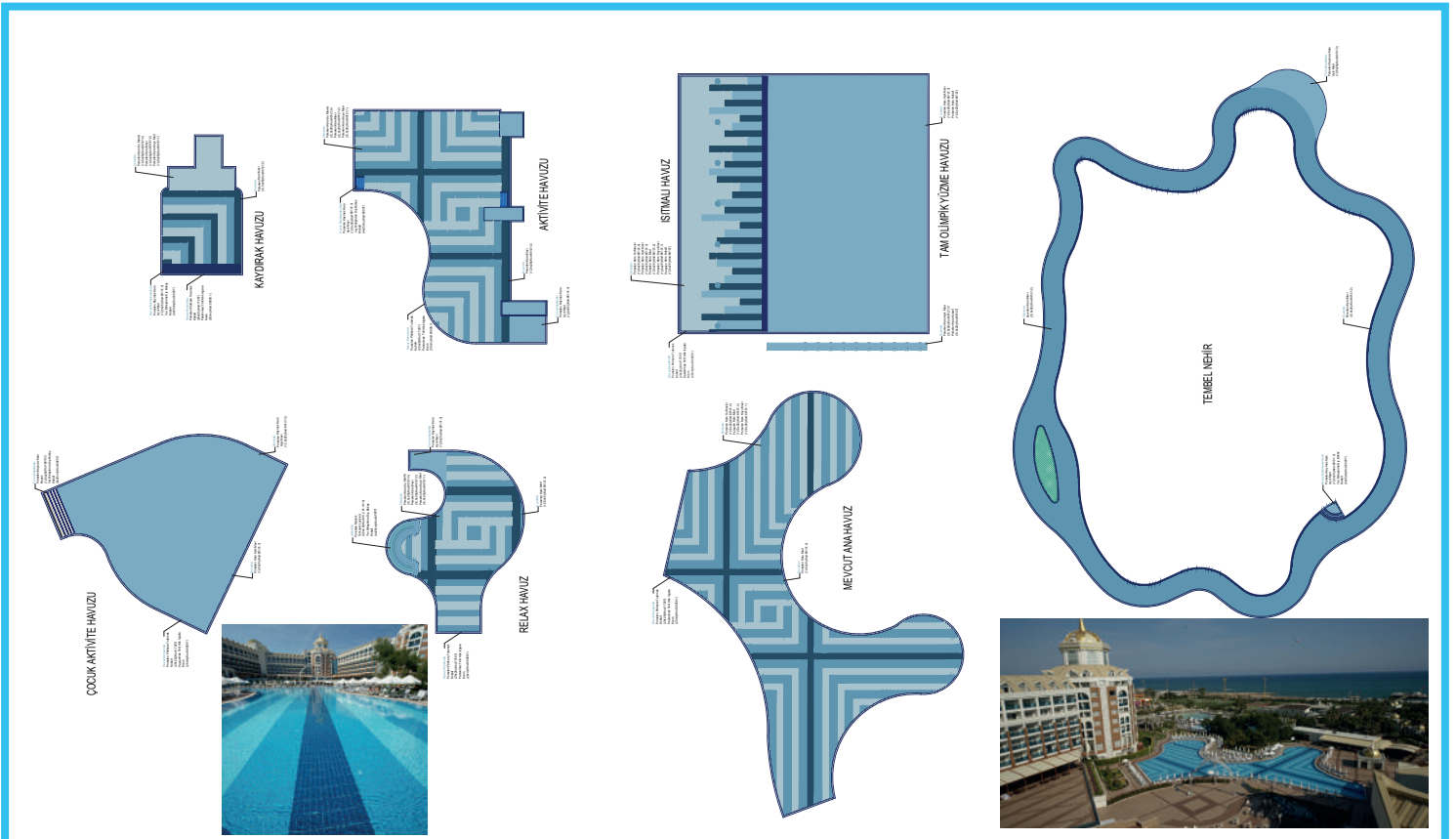

"Delphin Botanik Otel Projesi"





## Projelerimizden Bazıları

### View Some of Our Projects

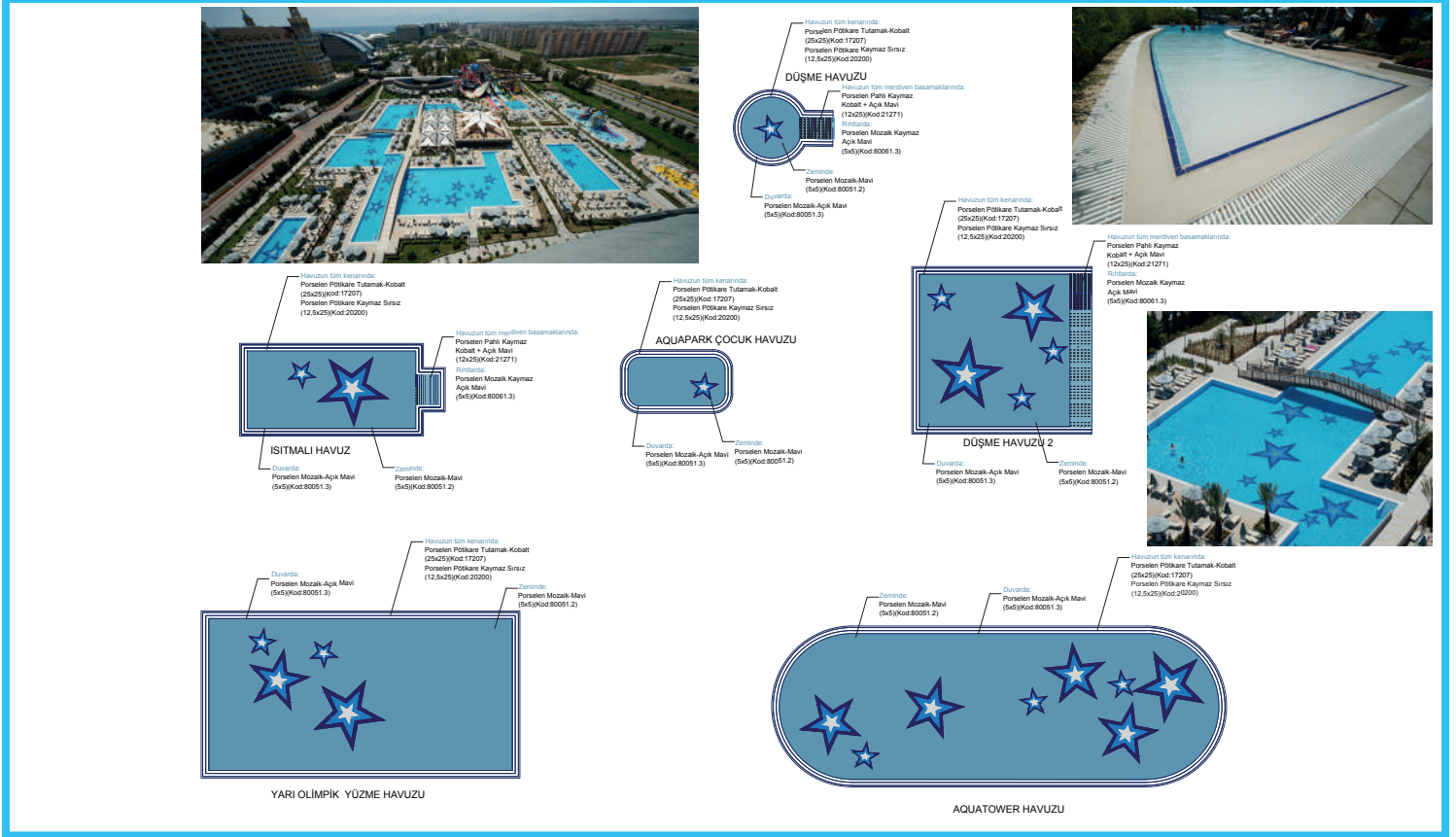

"Royal Seginus Otel Projesi"

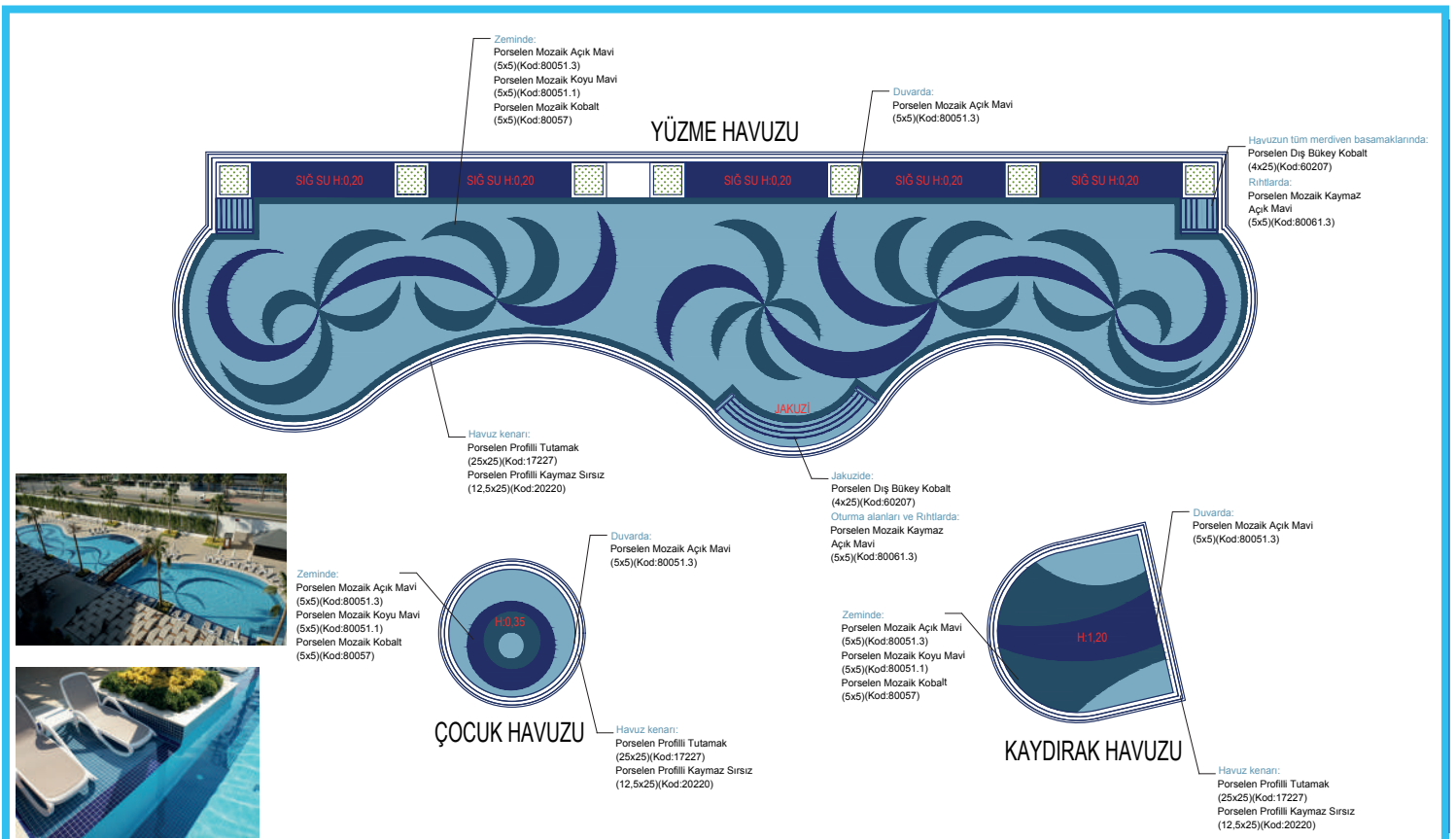

"Marypalece Otel Projesi"

# SERAPOL TEKNİK ÖZELLİKLERİ

## SERAPOL TECHNICAL SPECIFICATION



BOYUT VE YÜZEY KALİTESİ DIMENSIONS AND SURFACE QUALITY	TEST STANDARD NO TEST METHOD	N < 7cm	7 cm ≤ N < 15 cm	N ≥ 15 cm	
<b>UZUNLUK GENİŞLİK</b> Length and width		(mm)	(mm)	%	(mm)
Her bir karonun (2 veya 4 kenar) ortalama boyutunun çalışma boyutundan (W) sapması, The permissible deviation of the average size for each tile (2 or 4 sides) from the work size (W)	EN ISO 10545-2	± 0,5 mm	± 0,9 mm	± % 0,6	± 2 mm
<b>KALINLIK</b> Thickness					
Her bir karonun kalınlık ortalamasının çalışma kalınlığından sapması, The permissible deviation, of the average thickness of each tile from the work size thickness	EN ISO 10545-2	± 0,5 mm	± 0,5 mm	± % 5	± 0,5 mm
<b>KENARLARIN DÜZGÜNLÜĞÜ</b> Straightness of sides					
İlgili çalışma boyutuna göre düzgünlükten en çok sapma, The maximum permissible deviation from straightness, related to the corresponding work sizes	EN ISO 10545-2	-	± 0,75 mm	± % 0,5	± 1,5 mm
<b>GÖNYEDEN SAPMA</b> Rectangularity					
İlgili çalışma boyutuna göre gönyeden en çok sapma, The maximum permissible deviation from rectangularity related to the corresponding work sizes.	EN ISO 10545-2	-	± 0,75 mm	± % 0,5	± 2 mm
<b>YÜZEY DÜZGÜNLÜĞÜ</b> Surface flatness					
a- Çalışma boyutundan hesaplanan köşegene göre merkez eğriliği, Centre curvature, related to diagonal calculated from the work sizes;	EN ISO 10545-2	-	± 0,75 mm	± % 0,5	± 2 mm
b-İlgili kenarın çalışma boyutuna göre kenar eğriliği, Edge curvature, related to the corresponding work sizes;	EN ISO 10545-2	-	± 0,75 mm	± % 0,5	± 2 mm
c-Çalışma boyutundan hesaplanan köşegene göre yüzey çarpıklığı, Warpage, related to diagonal calculated from the work sizes.	EN ISO 10545-2	-	± 0,75 mm	± % 0,5	± 2 mm
<b>YÜZEY KALİTESİ</b> Surface quality	EN ISO 10545-2	Karoların en az % 95'inde, görünümü bozacak gözle görülür kusurlar olmamalıdır. A minimum of 95 % of the tiles shall be free from visible defects that would impair the appearance of a major area of tiles			
<b>FİZİKSEL ÖZELLİKLER</b> PHYSICAL PROPERTIES					
<b>SU EMME (%)</b> Water absorption (in % by mass)	EN ISO 10545-3	E ≤ % 0,5 ( Her bir karoda maksimum % 0,6) (Individual maximum 0,6 %)			
Serapool Mozaik Grubu Su Emme (%) Serapool Mosaic Group Water absorption (in % by mass)	EN ISO 10545-3	% 0,5 < E ≤ % 3 ( Her bir karoda maksimum % 3,3) (Individual maximum 3,3 %)			
<b>KIRILMA DAYANIKLILIĞI</b> Breaking strength					
Kalınlık ≥ 7,5 mm / Thickness ≥ 7,5 mm	EN ISO 10545-4	Min. 1300 N / Not less than 1300 N			
Kalınlık < 7,5 mm / Thickness < 7,5 mm	EN ISO 10545-4	Min. 700 N / Not less than 700 N			
<b>EĞİLME DAYANIMI</b> Flexural tensile strength or modulus of rupture	EN ISO 10545-4	Min. 35 (N/mm <sup>2</sup> ) (Her bir karoda min. % 32 N/mm <sup>2</sup> ) Average minimum 35 N/mm <sup>2</sup> Individual minimum 32 N/mm <sup>2</sup>			
<b>AŞINMA DAYANIMI</b> Abrasion resistance					
Sırsız karolarda derin aşınma direnci / Resistance to deep abrasion of unglazed tiles	EN ISO 10545-6	Max.175 mm <sup>3</sup>			
Yer kaplamasında kullanılacak sırlı karolarda yüzey aşınma direnci Resistance to surface abrasion of glazed tiles intended for use on floors	EN ISO 10545-7	Min.3 sınıf			
<b>LİNEER ISIL GENLEŞME KATSAYISI</b> Coefficient of linear thermal expansion	EN ISO 10545-8	< 9 x 10 <sup>-6</sup> K <sup>-1</sup>			
<b>TERMAL ŞOK DİRENCİ</b> Thermal shock resistance	EN ISO 10545-9	Dayanıklidir. Resistant			
<b>ÇATLAMA DAYANIKLILIĞI</b> Crazing resistance	EN ISO 10545-11	Dayanıklidir. Resistant			
<b>DONMA DİRENCİ</b> Frost resistance	EN ISO 10545-12	Dayanıklidir. Resistant			
<b>KAYMAZLIK (Yer Karoları)</b> Slipperiness (Floor Tiles)	CEN / TS 16165	Kaymazlık değeri için katalogta ilgili seriye bakınız See the corresponding series in the catalogue For a non-slip value			
<b>BAĞ DAYANIMI, YAPIŞMA</b> Bond strength/adhesion	TS EN 12004-2:2017-04	Çimento bazlı C2 tip yapıştırıcı ile min.1 N/mm <sup>2</sup> Cementitious adhesive, type C2			
<b>RUTUBET GENLEŞMESİ (%)</b> Moisture expansion	EN ISO 10545-10	Max.% 0,05			
<b>KÜÇÜK RENK FARKLILIKLARI TAYİNİ</b> Small colour differences					
a) Glazed Tiles	EN ISO 10545-16	ΔEcmc < 0,75			
b) Unglazed Tiles	EN ISO 10545-16	ΔEcmc < 1			
<b>DARBE DİRENCİ</b> Impact resistance	EN ISO 10545-5	Min. 0,55			
<b>KİMYASAL ÖZELLİKLER CHEMICAL PROPERTIES</b>					
<b>LEKELENMEYE DAYANIKLILIK</b> Resistance to staining	EN ISO 10545-14	Min 3. Sınıf			
<b>DÜŞÜK DERİŞİMLİ ASİT VE BAZLARA DAYANIKLILIK</b> Resistance to low concentrations of acids and alkalis	EN ISO 10545-13	ULA			
<b>YÜKSEK DERİŞİMLİ ASİT VE BAZLARA DAYANIKLILIK No<sup>1</sup></b> Resistance to high concentrations of acids and alkalis No <sup>1</sup>	EN ISO 10545-13	UHA			
<b>EVLERDE KULLANILAN TEMİZLİK MALZEMELERİNE VE YÜZME HAVUZU TUZLARINA DAYANIKLILIK</b> Resistance to household chemicals and swimming pool salts	EN ISO 10545-13	UA			
<b>AÇIĞA ÇIKAN KURŞUN VE KADMIYUM</b> Release of dangerous substances (Lead and Cadmium)	EN ISO 10545-15	Kurşun (Lead) < 0,1 mg/dm <sup>2</sup> Kadmiyum (Cadmium) < 0,01 mg/dm <sup>2</sup>			

Not 1: Metal görünümlü mozaiklerin yüksek derişimli asit ve bazlara dayanıklılığı yoktur. / Metal looking mosaics has no endurance against highly concentrated.

Not 2: Serapool ürünleri, yukarıdaki tabloda belirtilen standartlara uygundur. / All Serapool products are compliant with the standards indicated on the table above.

Not 3: Serapool ürünleri mozaikler hariç TS EN 14411 Ek-G standardına uygun olarak üretilmektedir. Serapool mozaikleri ise TS EN 14411 Ek-H standardına uygun olarak üretilmektedir. / Except mosaics, Serapool products are produced according to TS EN 14411 – G standard. Serapool mosaics are produced according to TS EN 14411 – H standard.



Yetkili Satıcı / Authorized Dealer



[www.serapool.com](http://www.serapool.com)