

## Piezo Switch Prolonged Signal



PSE IV 16

**Description**

- Switch available in version Standard, with Lettering, starting from 22 mm diameter with Point Illumination or Ring Illumination
- Assembly by mounting with nut
- Pins, Wire, Crimp Terminal male or Cable with Faston

**Approvals**

- EMC directive 2004/108/EWG EMC directive 2004/108/EWG
- DGUV Test Certificate: FW 11040 Requirements for Food Processing Equipment
- MIL-STD Certificate Number: 202F Method 107G, 202F Method 204D, 202F Method 213B, 416D Method RS103, 810E Method 501.3, 810E Method 502.3, 810E Method 507.3
- VDE Certificate Number: DIN EN 61000-4-2, DIN EN 61000-4-4, DIN EN 61000-4-5

**Characteristics**

- Housing material types: plastic, aluminum or stainless steel, ring illuminated version additionally made of polyamide
- Variety of design options regarding size, colour, shape, connection or lettering
- High reliability, long lifetime with more than 20 mill. actuations
- Easy to clean due to a tightly closed surface (IP 69K)
- piezo switch for a longer switching signal duration
- For use in harsh environments, both indoors and outdoors

**Other versions on request**

- switch with short switching pulse, type: PSE NO
- switch for explosion proof applications, type: PSE EX
- switch with enhanced vandal proof protection, type: PSE HI
- as keypad, type: Piezo Keypad

**Weblinks**

[html-datasheet](#), [General Product Information](#), [Approvals](#), [RoHS](#), [CHINA-RoHS](#), [e-Shop](#), [CAD-Drawings](#), [Product News](#), [Detailed request for product](#)

**Technical Data****Electrical Data**

Switching Function	N.O.
Supply Voltage	Ring Illumination VDC 12 / 24, 24 VDC Point Illumination,
Switching Voltage	max. 32 / 48 VAC/DC
Switching Current	max. 1 A
Rated Breaking Capacity	10 W
Lifetime	20 mill. at Rated Braking Capacity
Switch Resistance OFF	> 10 MΩ
Switch Resistance ON	< 1 Ω
Capacity	30 pF
N.O. Closing Impulse Duration	15 sec depending on actuating force, time and speed. Longer impulse time up to 50 sec available on request.
Contact Configuration	free polarity

**Mechanical Data**

Actuating Force	3 - 5 N
Actuating Travel	0.002 mm
Shock Protection	IK 02
Starting Torque	2.5 Nm

**Climatical Data**

Operating Temperature	-20 to +60 °C
Storage Temperature	-20 to +60 °C
IP-Protection	IP 67 , IP 69K from front side, Front Side / Rear Side DIN EN 60069-2-30 Db (Moist heat - air test with 55°C / 93% humidity)

Salt Spray Test (acc. to DIN 50021-SS)	24 h / 48 h / 96 h Residence Time
--	-----------------------------------

**Material**

Housing (depending on type)	Stainless Steel, Aluminium anodized, Polyamide
Actuating Area / Insert (with Ring Illumination)	Stainless Steel, Aluminium anodized
Illuminated Ring (Ring Illumination)	Polyamide

## Dimensions

PSE M16 with Pins

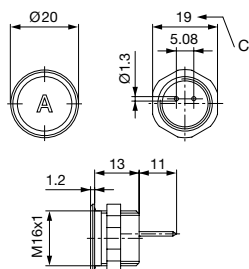

PSE M16 with Crimp Terminal male

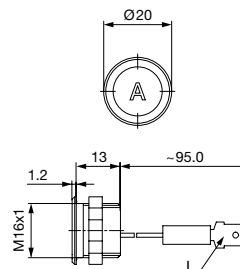

Version available on request

PSE M16 with AMP

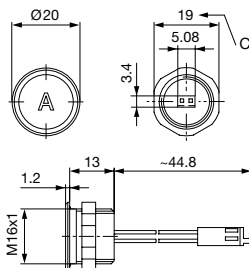

PSE M16 with Wires

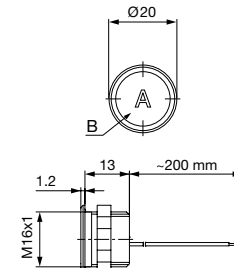

Version available on request

PSE M19 with Pins

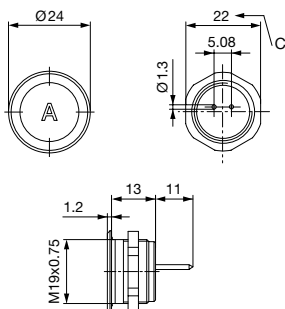

PSE M19 with Crimp Terminal male

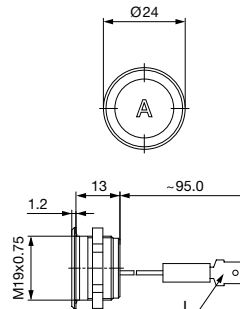

Version available on request

Version available on request

PSE M19 with Cable with Faston, elevated front design

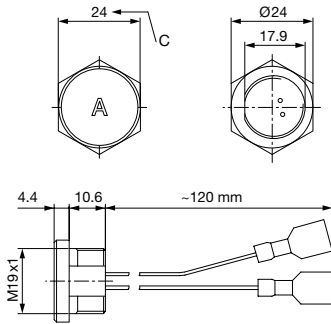

Version available on request

PSE M24 RI

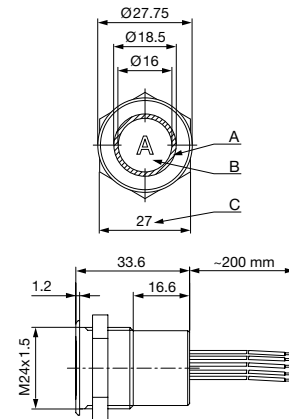

Version available on request

PSE M27 RI

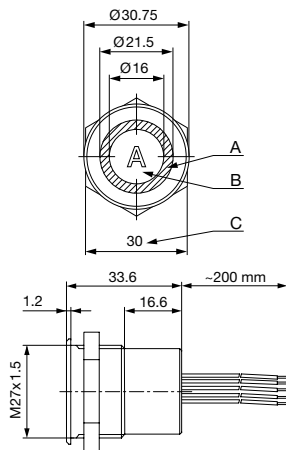

Version available on request

PSE M30 RI

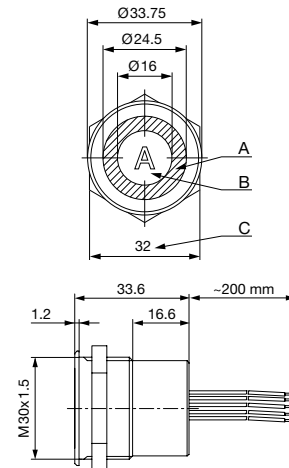

Version available on request

Legend:

- A = Illumination Area
- B = Actuating Area
- C = Width Across Flats
- I = Crimp Terminal male 6.3 x 0.8
- PI = Point Illumination
- RI = Ring Illumination

Lettering:

- either with/without lettering
- position of the connections with respect to the position of the lettering is not defined

## Dimensions

PSE M16

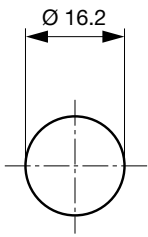

PSE M19

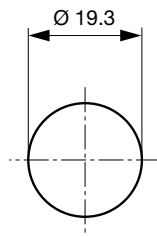

PSE M24

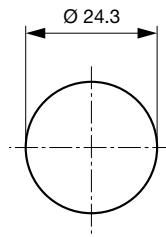

PSE M27

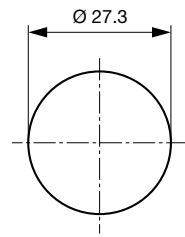

PSE M30

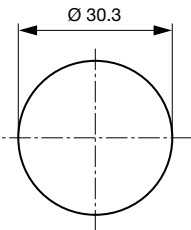

## Diagrams

PSE M24 RI / PSE M27 RI / PSE M30 RI, 12/24 V

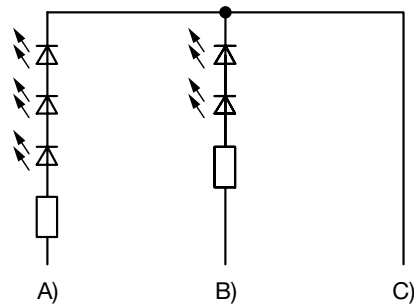

- A) Cable 1 (color of the LEDs), Supply voltage first LED group
- B) Cable 3 (color of the LEDs), Supply voltage second LED group
- C) Cable 2 (black), Common mass of both LED groups
- D) Cable 4 and 5 (white), Input and output PSE switch

PSE M24 RI / PSE M27 RI / PSE M30 RI, 5 V

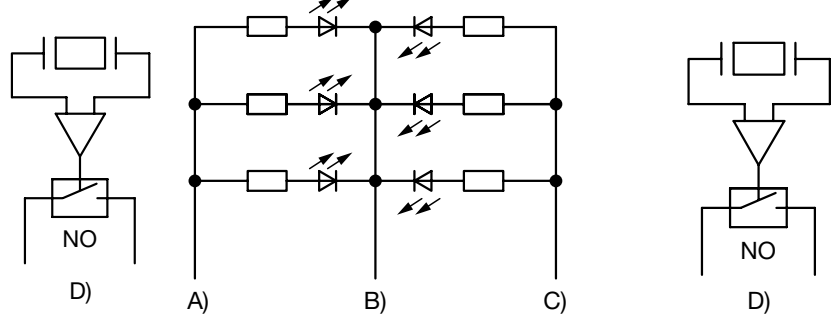

- A) Cable 1 (color of the LEDs), Supply voltage first LED group
- B) Cable 2 (black), Common mass of both LED groups
- C) Cable 3 (color of the LEDs), Supply voltage second LED group
- D) Cable 4 and 5 (white), Input and output PSE switch

## Lettering

The last three digits in the order number define the lettering:

001-074

Standard Lettering



101-

Customized Lettering

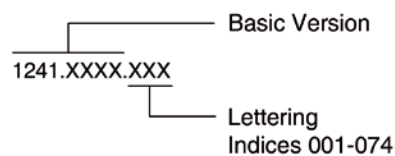
## Ordering Example for Lettering



## Order Index Lettering

001 = <b>A</b>	021 = <b>U</b>	041 = ÷	061 = <b>EIN</b>
002 = <b>B</b>	022 = <b>V</b>	042 =	062 = <b>AUS</b>
003 = <b>C</b>	023 = <b>W</b>	043 = =	063 = <b>AUF</b>
004 = <b>D</b>	024 = <b>X</b>	044 = #	064 = <b>AB</b>
005 = <b>E</b>	025 = <b>Y</b>	045 =	065 = <b>ON</b>
006 = <b>F</b>	026 = <b>Z</b>	046 =	066 = <b>OFF</b>
007 = <b>G</b>	027 = <b>0</b>	047 = →	067 = <b>UP</b>
008 = <b>H</b>	028 = <b>1</b>	048 = ←	068 = <b>DOWN</b>
009 = <b>I</b>	029 = <b>2</b>	049 =	069 = <b>HIGH</b>
010 = <b>J</b>	030 = <b>3</b>	050 =	070 = <b>LOW</b>
011 = <b>K</b>	031 = <b>4</b>	051 = %	071 = <b>ON/OFF</b>
012 = <b>L</b>	032 = <b>5</b>	052 = √	072 = <b>START</b>
013 = <b>M</b>	033 = <b>6</b>	053 = <b>CTRL</b>	073 = <b>RESET</b>
014 = <b>N</b>	034 = <b>7</b>	054 = <b>RETURN</b>	074 = 
015 = <b>O</b>	035 = <b>8</b>	055 = <b>SHIFT</b>	075 = 
016 = <b>P</b>	036 = <b>9</b>	056 = <b>LOCK</b>	076 = 
017 = <b>Q</b>	037 = <b>+</b>	057 = <b>STOP</b>	
018 = <b>R</b>	038 = <b>-</b>	058 = <b>ENTER</b>	
019 = <b>S</b>	039 = <b>.</b>	059 = <b>BACK</b>	
020 = <b>T</b>	040 = <b>x</b>	060 = <b>LINE</b>	

## Variants

Mounting Diameter	Terminal	Housing Material, Twist Protection	Colour of Housing	Actuator area	Illumination, LED	Type	Order Number
16	Flexible wire	Aluminum ,	red	F	non-illuminated	PSE 16 IV	1241.3046.3
16	Flexible wire	Aluminum ,	black	F	non-illuminated	PSE 16 IV	1241.3046.7
16	Flexible wire	Aluminum ,	Alu natural	F	non-illuminated	PSE 16 IV	1241.3046.8
16	Quick Connect Terminal	Aluminum ,	gold	F	non-illuminated	PSE 16 IV	1241.2434.1
16	Quick Connect Terminal	Aluminum ,	red	F	non-illuminated	PSE 16 IV	1241.2434.3
16	Quick Connect Terminal	Aluminum ,	blue	F	non-illuminated	PSE 16 IV	1241.2434.4
16	Quick Connect Terminal	Aluminum ,	green	F	non-illuminated	PSE 16 IV	1241.2434.5
16	Quick Connect Terminal	Aluminum ,	black	F	non-illuminated	PSE 16 IV	1241.2434.7
16	Quick Connect Terminal	Aluminum ,	Alu natural	F	non-illuminated	PSE 16 IV	1241.2434.8
16	Quick Connect Terminal	Stainless Steel ,	Stainless Steel	F	non-illuminated	PSE 16 IV	1241.2607
16	Flexible wire	Plastics ,	black	F	non-illuminated	PSE 16 IV	1241.3201

Legend:

Type:

PI = RU = Point Illumination

RI = Ring Illumination

K = Plastics

Alu = Aluminium

ES = Stainless steel

F = Finger guidance

E = without finger guidance

IV = prolonged signal

The nut with gasket are enclosed in the box.

Other mounting diameters, materials, colors, connections, supply voltages as customized products possible.  
Special materials for use in salt and chlorine containing environment on request.

## Accessories

### Description

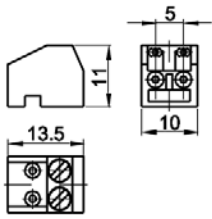

[Connecting Terminal PSE IV](#)  
Connecting Terminal for Pin Versions of PSE IV

PSE IV

0701.9225