



Saf-T-Stor® Gas Cylinder Storage Cabinet

Saf-T-8

Assembly Instructions

Providing Reliable Engineered Solutions

TABLE OF CONTENTS:

- PAGE 1 | COVER, TOOLS REQ'D
- PAGE 2 | HARDWARE PROVIDED & PARTS LIST
- PAGE 3 | ASSEMBLY INSTRUCTIONS
- PAGE 4 | ASSEMBLY INSTRUCTIONS (CONTINUED)

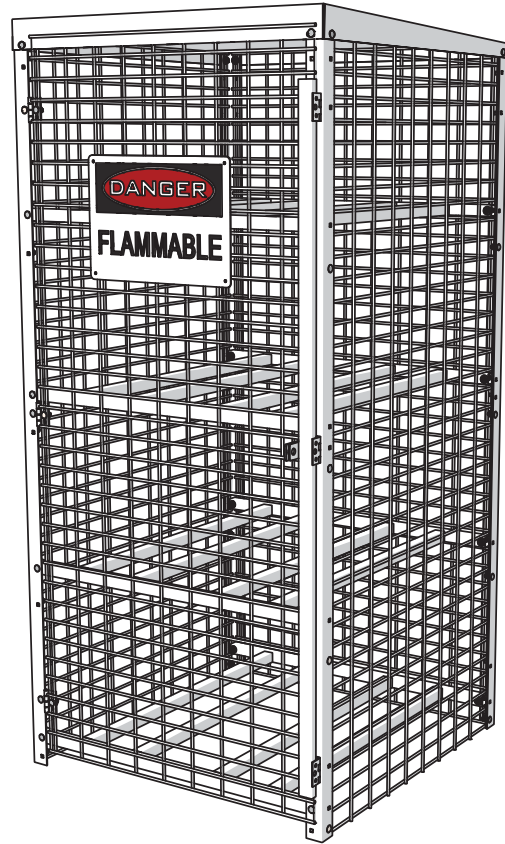

TOOLS REQUIRED:

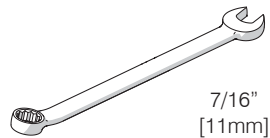
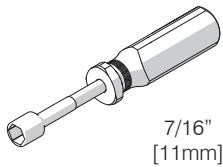

OPEN END WRENCH

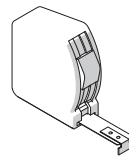

MEASURING TAPE

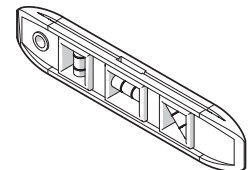

LEVEL

HARDWARE PROVIDED:

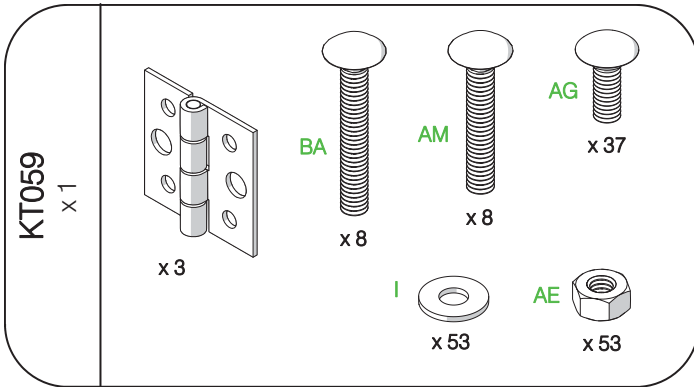

HARDWARE LIST:

- (I) 1/4" FLAT WASHER
- (AE) 1/4"-20 HEX NUT
- (AG) 1/4"-20 x 3/4" SQUARE NECK CARRIAGE BOLT
- (AM) 1/4"-20 x 1-1/2" SQUARE NECK CARRIAGE BOLT
- (BA) 1/4"-20 x 1-3/4" SQUARE NECK CARRIAGE BOLT

PARTS LIST:

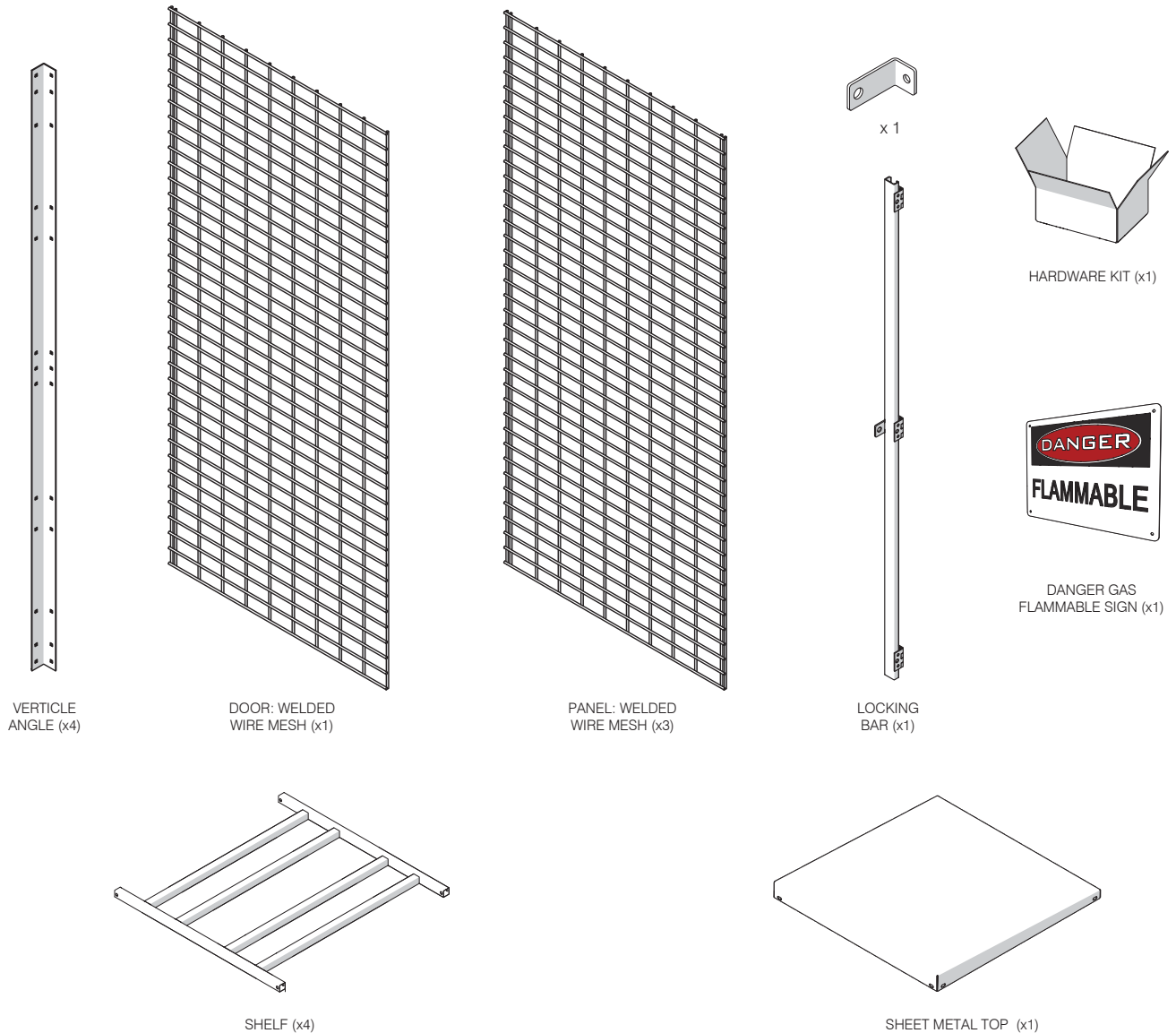

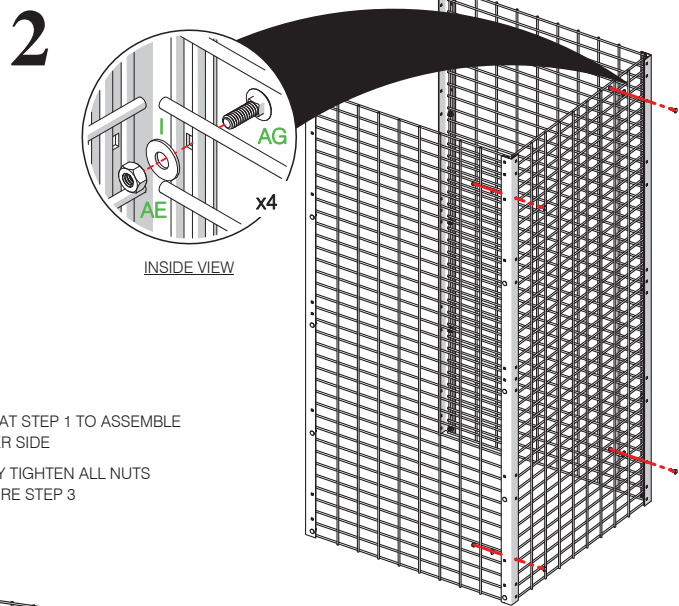
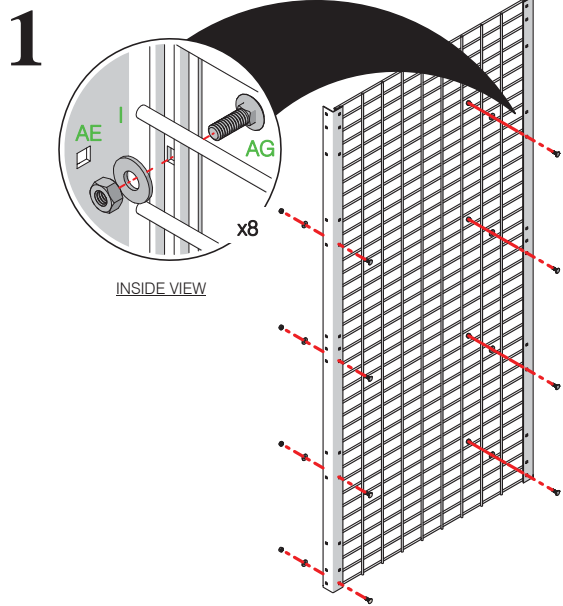

NOTE:

- REPEAT STEP 1 TO ASSEMBLE OTHER SIDE
- FULLY TIGHTEN ALL NUTS BEFORE STEP 3

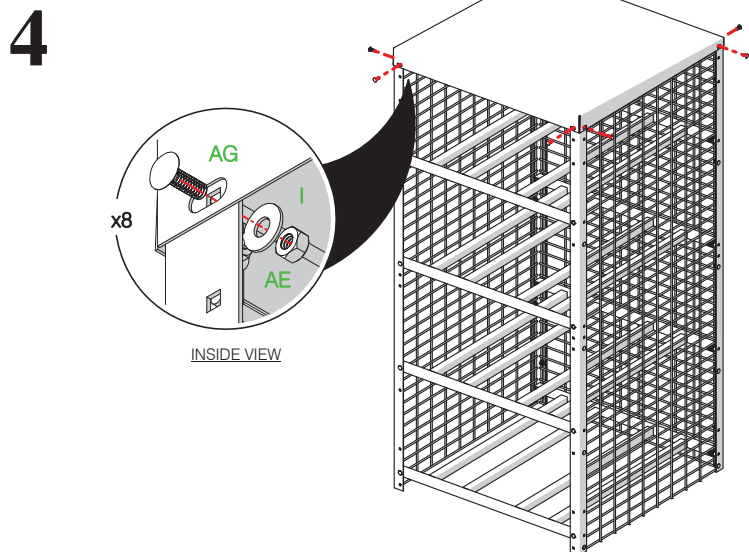
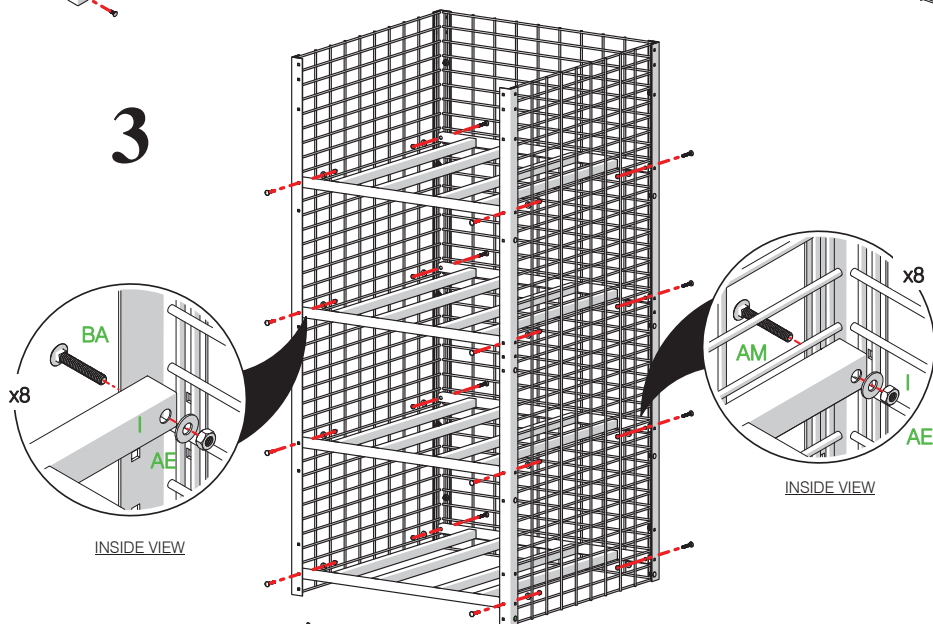

5

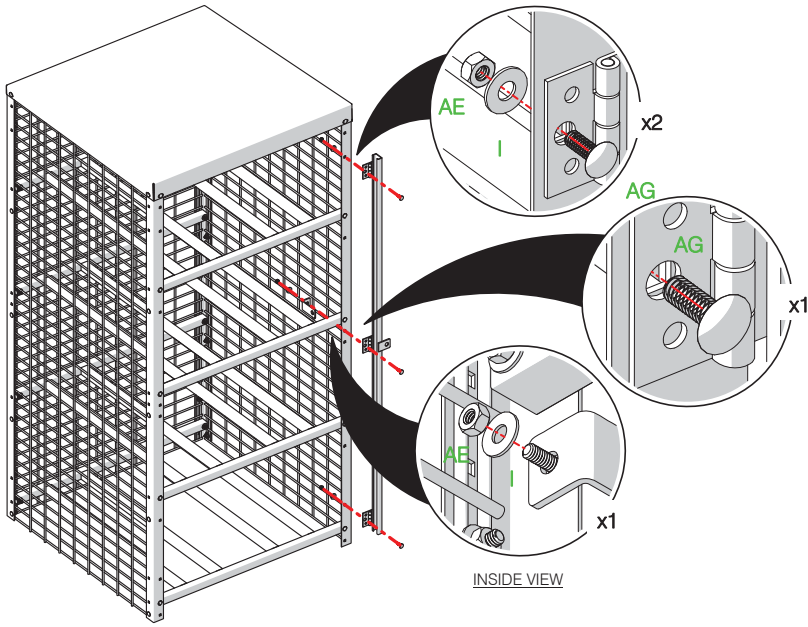

6

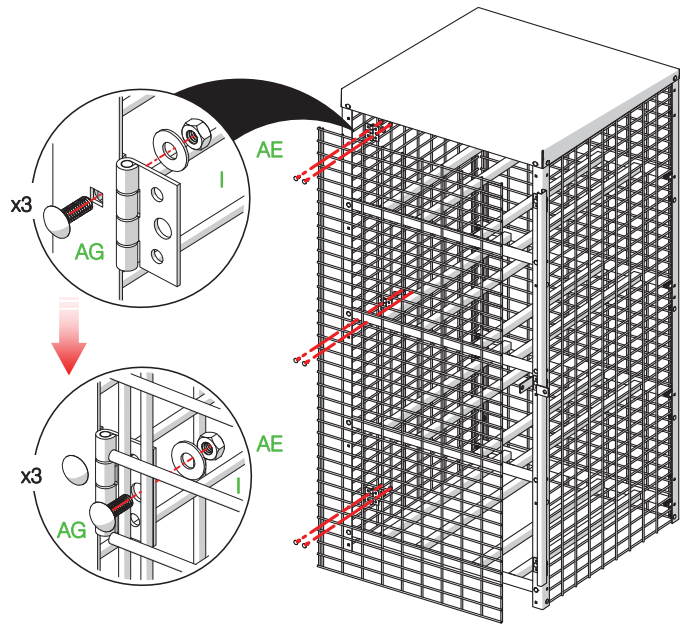

NOTE: FULLY TIGHTEN ALL NUTS

7

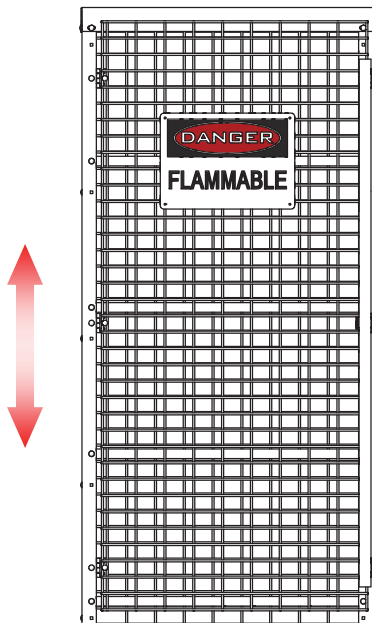

NOTE:

- CHECK DOOR ALIGNMENT, ADJUST DOOR HEIGHT ACCORDINGLY.
- ZIP TIE DANGER SIGN TO LOCKER DOOR