



In many more sophisticated drive systems there is a requirement for high power ratings, combined with compact drive design. This led to the development of Ribbed Belts, which combine the advantages of high flexibility with excellent power transmission.

Features & Benefits:

- High resistance to oil, heat, dust and cracking
- Uniform load distribution all over the cross section
- Top fabric layer for lateral stiffness
- Only one belt required. No matching. Uniform Tension
- Constant speed ratio, the ribs never sink inside the pulley
- Suitable for drives with inside and outside idlers
- Extremely flexible with reduced thickness
- Can be used on drives from the reverse side and in compact layouts
- High Surface speed combined with high speed ratios smaller pulley diameters
- Less Noise, vibration and weight. Ideal for domestic appliance drives

Applications

- For compact drives with high speed ratios
- For drives requiring minimum maintenance
- For drives in a noise-sensitive environment
- For serpentine drives, V-flat drives, and drives with reverse bend idlers

Section J, L and M - used on general machinery

Section H - Used on domestic appliances, e.g. washing machines, dryers

Section K - Used in automotive industry for ancillary drives

RIBBED/POLY V-BELTS : PH

PIX 'X' Power

Standard : RMA IP26

Features :

- Oil Resistant
- Antistatic
- Temperature range : -18°C to +100°C
- Maximum belt linear speed : 50m/sec
- Can be used for speed ratios up to 1:30
- ATEX certified FRAS belts are available
- No of Ribs per Sleeve : 320

Useful Information

Manufacturing Range

- 280 - 5080 mm

Rec. Min Pulley Dia.

- 13 (mm)

Weight per metre (Kgs)

- 0.006

Max Belt Speed m/sec

- 50

Nominal Length : Effective Length (Le) in mm

'PIX' FRAS belts conforms to : II 2GD c IIB X (Test report no. IB-03-4-934)

Belt Ref	Effective Length (inches)	Belt Ref	Effective Length (inches)	Belt Ref	Effective Length (inches)	Belt Ref	Effective Length (inches)	Belt Ref	Effective Length (inches)	Belt Ref	Effective Length (inches)
PH 440	17.3	PH 914	36.0	PH 1194	47.0	PH 1309	51.5	PH 1895	74.6	PH 1975	77.7
PH 585	23.0	PH 955	37.5	PH 1200	47.2	PH 1316	51.8	PH 1900	74.8	PH 1992	78.4
PH 559	22.0	PH 965	38.0	PH 1222	48.1	PH 1321	52.0	PH 1904	74.9	PH 2083	82.0
PH 698	27.5	PH 975	38.4	PH 1230	48.4	PH 1333	52.5	PH 1915	75.4	PH 2155	84.8
PH 735	28.9	PH 990	39.0	PH 1244	49.0	PH 1371	54.0	PH 1930	76.0		
PH 762	30.0	PH 1016	40.0	PH 1262	49.7	PH 1397	55.0	PH 1938	76.2		
PH 813	32.0	PH 1080	42.5	PH 1270	50.0	PH 1439	56.7	PH 1945	76.5		
PH 858	33.8	PH 1092	43.0	PH 1285	50.6	PH 1475	58.1	PH 1951	76.8		
PH 864	34.0	PH 1096	43.1	PH 1290	50.8	PH 1600	63.0	PH 1956	77.0		
PH 886	34.9	PH 1168	46.0	PH 1301	51.2	PH 1854	73.0	PH 1970	77.5		

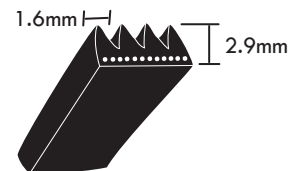

RIBBED/POLY V-BELTS : PJ

PIX 'X' Power

Standard : RMA IP26

Features :

- Oil Resistant
- Antistatic
- Temperature range : -18°C to +100°C
- Maximum belt linear speed : 50m/sec
- Can be used for speed ratios up to 1:30
- ATEX certified FRAS belts are available
- No of Ribs per Sleeve : 240

Useful Information

Manufacturing Range

- 280 - 5080 mm

Rec. Min Pulley Dia.

- 20 de (mm)

Weight per metre (Kgs)

- 0.011

Max Belt Speed m/sec

- 50

Nominal Length : Effective Length (Le) in mm

'PIX' FRAS belts conforms to : II 2GD c IIB X (Test report no. IB-03-4-934)

Belt Ref	Effective Length (inches)	Belt Ref	Effective Length (inches)	Belt Ref	Effective Length (inches)	Belt Ref	Effective Length (inches)	Belt Ref	Effective Length (inches)	Belt Ref	Effective Length (inches)
PJ 280	11	PJ 737	29	PJ 1116	43.9	PJ 1301	51	PJ 1663	65.5	PJ 2083	82
PJ 330	13	PJ 762	30	PJ 1123	44	PJ 1309	51.5	PJ 1702	67	PJ 2100	82.5
PJ 356	14	PJ 813	32	PJ 1130	44.5	PJ 1316	51.5	PJ 1752	69	PJ 2108	82.9
PJ 362	14	PJ 836	32.9	PJ 1142	44.9	PJ 1321	52	PJ 1753	69	PJ 2155	84.5
PJ 381	15	PJ 838	33	PJ 1143	45	PJ 1333	52.5	PJ 1778	70	PJ 2210	87
PJ 406	16	PJ 864	34	PJ 1150	45	PJ 1355	53	PJ 1780	70	PJ 2260	88.9
PJ 414	16	PJ 870	34.2	PJ 1168	46	PJ 1358	53.5	PJ 1795	70.7	PJ 2337	92
PJ 432	17	PJ 889	35	PJ 1194	47	PJ 1371	54	PJ 1854	73	PJ 2489	98
PJ 457	18	PJ 914	36	PJ 1200	47	PJ 1372	54	PJ 1880	74	PJ 2500	98.4
PJ 483	19	PJ 920	36.2	PJ 1219	48	PJ 1397	55	PJ 1892	74.4		
PJ 508	20	PJ 955	37.5	PJ 1222	48	PJ 1428	56	PJ 1895	74.5		
PJ 533	20.9	PJ 965	38	PJ 1244	49	PJ 1435	56.5	PJ 1905	75		
PJ 559	22	PJ 991	39	PJ 1245	49	PJ 1439	56.5	PJ 1910	75		
PJ 584	23	PJ 1016	40	PJ 1254	49.4	PJ 1461	57.5	PJ 1915	75.5		
PJ 610	24	PJ 1031	40.6	PJ 1257	49.5	PJ 1473	58	PJ 1920	75.6		
PJ 640	25.2	PJ 1054	41.5	PJ 1262	49.5	PJ 1475	58	PJ 1930	76		
PJ 660	26	PJ 1065	41.9	PJ 1270	50	PJ 1549	61	PJ 1956	77		
PJ 686	27	PJ 1092	43	PJ 1280	50.4	PJ 1580	62.2	PJ 1965	77.5		
PJ 711	28	PJ 1105	43.5	PJ 1285	50.5	PJ 1600	63	PJ 1981	78		
PJ 723	28.5	PJ 1110	43.5	PJ 1295	50.9	PJ 1651	65	PJ 1992	78.5		

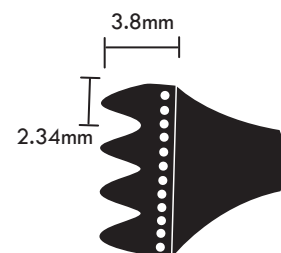

RIBBED/POLY V-BELTS : PK

PIX 'X' Power

Standard : RMA IP26

Features :

- Oil Resistant
- Antistatic
- Temperature range : -18°C to +100°C
- Maximum belt linear speed : 50m/sec
- Can be used for speed ratios up to 1:30
- ATEX certified FRAS belts are available
- No of Ribs per Sleeve : 150

Useful Information

Manufacturing Range

- 280 - 5080mm

Rec. Min Pulley Dia.

- 50 (mm)

Weight per metre (Kgs)

- 0.018

Max Belt Speed m/sec

- 50

Nominal Length : Effective Length (Le) in mm

'PIX' FRAS belts conforms to : II 2GD c IIB X (Test report no. IB-03-4-934)

Belt Ref	Effective Length (inches)	Belt Ref	Effective Length (inches)	Belt Ref	Effective Length (inches)	Belt Ref	Effective Length (inches)	Belt Ref	Effective Length (inches)	Belt Ref	Effective Length (inches)	Belt Ref	Effective Length (inches)
PK 559	22	PK 835	32.9	PK 954	37.6	PK 1165	45.9	PK 1397	55	PK 2145	84.4	PK 2845	112
PK 605	23.8	PK 841	33.1	PK 962	37.8	PK 1180	46.5	PK 1439	56.7	PK 2155	84.8	PK 2895	114
PK 625	24.6	PK 845	33.3	PK 970	38.2	PK 1190	46.8	PK 1450	57.1	PK 2170	85.4	PK 2921	115
PK 630	24.8	PK 858	33.8	PK 975	38.4	PK 1200	47.2	PK 1460	57.5	PK 2235	88	PK 2997	118
PK 648	25.5	PK 865	34	PK 985	38.8	PK 1215	47.8	PK 1475	58.1	PK 2362	93	PK 3124	123
PK 698	27.5	PK 870	34.3	PK 990	39	PK 1222	48.1	PK 1520	59.8	PK 2460	96.9	PK 3327	131
PK 725	28.5	PK 875	34.5	PK 995	39.2	PK 1230	48.4	PK 1600	63	PK 2515	99	PK 3492	137.5
PK 735	28.9	PK 886	34.9	PK 1000	39.4	PK 1245	49	PK 1610	63.4	PK 2743	108		
PK 775	30.5	PK 890	35	PK 1010	39.8	PK 1262	49.7	PK 1655	65.2				
PK 780	30.7	PK 905	35.6	PK 1015	40	PK 1270	50	PK 1854	73				
PK 790	31.1	PK 913	36	PK 1020	40.2	PK 1285	50.6	PK 1895	74.6				
PK 795	31.3	PK 920	36.2	PK 1065	41.9	PK 1301	51.2	PK 1930	76				
PK 800	31.5	PK 925	36.4	PK 1080	42.5	PK 1309	51.5	PK 1956	77				
PK 805	31.7	PK 930	36.6	PK 1090	43	PK 1321	52	PK 1980	78				
PK 812	32	PK 935	36.8	PK 1100	43.3	PK 1330	52.4	PK 1992	78.4				
PK 825	32.5	PK 940	37	PK 1125	44.3	PK 1345	53	PK 2030	79.9				
PK 830	32.7	PK 945	37.2	PK 1150	45.3	PK 1371	54	PK 2050	80.7				

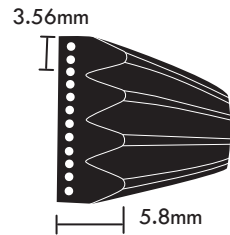

RIBBED/POLY V-BELTS : PL

PIX 'X' Power

Standard : RMA IP26

Features :

- Oil Resistant
- Antistatic
- Temperature range : -18°C to +100°C
- Maximum belt linear speed : 50m/sec
- Can be used for speed ratios up to 1:30
- ATEX certified FRAS belts are available
- No of Ribs per Sleeve : 110

Useful Information

Manufacturing Range

- 280 - 5080 mm

Rec. Min Pulley Dia.

- 75 de (mm)

Weight per metre (Kgs)

- 0.038

Max Belt Speed m/sec

- 50

Nominal Length : Effective Length (Le) in mm

'PIX' FRAS belts conforms to : II 2GD c IIB X (Test report no. IB-03-4-934)

Belt Ref	Effective Length (inches)	Belt Ref	Effective Length (inches)	Belt Ref	Effective Length (inches)	Belt Ref	Effective Length (inches)	Belt Ref	Effective Length (inches)	Belt Ref	Effective Length (inches)	Belt Ref	Effective Length (inches)
PL 865	34.05	PL 1080	42.50	PL 1270	50.00	PL 1476	58.10	PL 1930	76.00	PL 2362	93.00	PL 3696	145.50
PL 954	37.50	PL 1092	43.00	PL 1285	50.60	PL 1499	59.00	PL 1943	76.50	PL 2461	96.90	PL 4051	159.50
PL 991	39.00	PL 1100	43.30	PL 1295	51.00	PL 1519	59.80	PL 1956	77.00	PL 2476	97.50	PL 4191	165.00
PL 945	37.20	PL 1125	44.30	PL 1300	51.20	PL 1562	61.50	PL 1981	78.00	PL 2515	99.00	PL 4250	167.30
PL 955	37.60	PL 1149	45.20	PL 1308	51.50	PL 1600	63.00	PL 1991	78.40	PL 2565	101.00	PL 4470	176.00
PL 960	37.80	PL 1151	45.30	PL 1321	52.00	PL 1613	63.50	PL 2019	79.50	PL 2705	106.50	PL 4622	182.00
PL 970	38.20	PL 1166	45.90	PL 1333	52.50	PL 1651	65.00	PL 2020	79.50	PL 2743	108.00	PL 5029	198.00
PL 975	38.40	PL 1168	46.00	PL 1334	52.50	PL 1656	65.20	PL 2029	79.90	PL 2845	112.00	PL 5080	200.00
PL 986	38.80	PL 1181	46.50	PL 1346	53.00	PL 1664	65.50	PL 2050	80.70	PL 2890	113.80		
PL 991	39.00	PL 1189	46.80	PL 1371	54.00	PL 1715	67.50	PL 2070	81.50	PL 2895	114.00		
PL 996	39.20	PL 1194	47.00	PL 1397	55.00	PL 1727	68.00	PL 2096	82.50	PL 2921	115.00		
PL 1001	39.40	PL 1199	47.20	PL 1422	56.00	PL 1764	69.50	PL 2134	84.00	PL 2997	118.00		
PL 1011	39.80	PL 1214	47.80	PL 1435	56.50	PL 1765	69.50	PL 2144	84.40	PL 3086	121.50		
PL 1016	40.00	PL 1219	48.00	PL 1440	56.70	PL 1803	71.00	PL 2154	84.80	PL 3124	123.00		
PL 1021	40.20	PL 1222	48.10	PL 1450	57.10	PL 1841	72.50	PL 2169	85.40	PL 3288	129.40		
PL 1041	41.00	PL 1229	48.40	PL 1460	57.50	PL 1842	72.50	PL 2197	86.50	PL 3289	129.50		
PL 1064	41.90	PL 1245	49.00	PL 1462	57.60	PL 1854	73.00	PL 2235	88.00	PL 3327	131.00		
PL 1075	42.30	PL 1262	49.70	PL 1473	58.00	PL 1895	74.60	PL 2324	91.50	PL 3493	137.50		

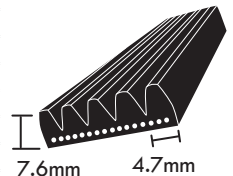

RIBBED/POLY V-BELTS : PM

PIX 'X' Power

Standard : RMA IP26

Features :

- Oil Resistant
- Antistatic
- Temperature range : -18°C to +100°C
- Maximum belt linear speed : 50m/sec
- Can be used for speed ratios up to 1:30
- ATEX certified FRAS belts are available
- No of Ribs per Sleeve : 52

Useful Information

Manufacturing Range

- 280 - 5080 mm

Rec. Min Pulley Dia.

- 180 de (mm)

Weight per metre (Kgs)

- 0.151

Max Belt Speed m/sec

- 50

Nominal Length : Effective Length (Le) in mm

'PIX' FRAS belts conforms to : II 2GD c IIB X (Test report no. IB-03-4-934)

Belt Ref	Effective Length (inches)	Belt Ref	Effective Length (inches)	Belt Ref	Effective Length (inches)	Belt Ref	Effective Length (inches)
PM 2286	90.0	PM 2832	111.5	PM 3327	131.0	PM 4191	165.0
PM 2362	93.0	PM 2845	112.0	PM 3493	137.5	PM 4470	176.0
PM 2388	94.0	PM 2896	114.0	PM 3531	139.0	PM 4623	182.0
PM 2461	96.9	PM 2921	115.0	PM 3696	145.5	PM 4648	183.0
PM 2515	99.0	PM 2997	118.0	PM 3734	147.0	PM 4800	188.9
PM 2693	106.0	PM 3010	118.5	PM 4051	159.5	PM 5029	198.0
PM 2743	108.0	PM 3124	123.0	PM 4089	161.0	PM 5080	200.0

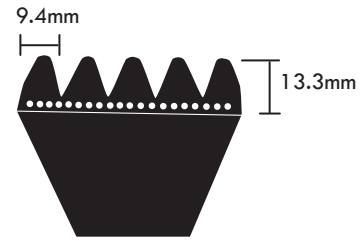

INSTALLATION & MAINTENANCE - RIBBED BELTS

1. Make sure that the power is off and machine stops completely before setting the belt or during maintenance.
2. Do not use excessive force to set the belt. Reduce centre distance by using the motor slide for smooth setting, when using the tension pulley the belt should be loosened beforehand.
3. Make sure that oil does not stick to the belt while setting the belt.
4. When the centre distance is long, or when using PJ or PK type with small pitches make sure that you do not mis-set the belt by a ridge.
5. Tension the drive properly.
6. With a multi belt system make sure that the pulley groove dimensions are perfect.
7. Check if the pulley groove is worn or damaged in operation. If the pulley tip gets smaller (sharpened) replace the pulley, since it can cause shortened belt life.

Installation Procedure

The following installation procedure should be strictly adhered to achieve the satisfactory performance from the ribbed belt drive:

1. Switch off the main supply before beginning with the exercise of installation.
2. Bring the pulleys closer to each other so that the belt can be removed easily.
3. Inspect the pulley grooves for any scores, sharp edges, dirt & rust. Clean them as required.
4. Ensure the alignment of pulleys. Make sure that the shafts are also properly aligned.
5. Mount the ribbed belt with no tension. Make sure that the ribs have been properly seated in the grooves.
6. Tension the ribbed belts as per the procedure given below.
7. Give some running time to the drive so that the belts are properly seated in the grooves.
8. Guard the drive properly.

Tensioning Procedure

It is imperative that to achieve the best from your ribbed belt drive, a proper tension be maintained in the drive. Under or over tensioning can cause the ribbed belt to fail prematurely. The following steps should be worked out to ensure the proper tension in the drive.

1) Fit the belt on the pulleys with no tension.

2) Draw two perpendicular lines across the belt at about 80% of the belt span between the pulleys as shown in the figure. Say for example the lines are placed 1000 mm apart. (A).

3) Increase the distance between two lines by 0.5 to 0.75% i.e. by 5 to 7.5 mm for an initial spacing of 1000 mm, so that the (A) now becomes 1007.5 mm.

4) Run the drive under load for about 10 minutes.

5) Check the tension of the belt (spacing between two lines) & readjust if necessary.

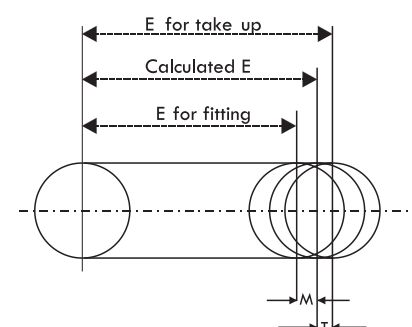
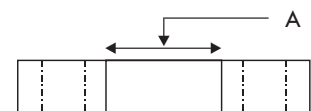
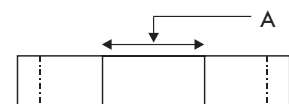
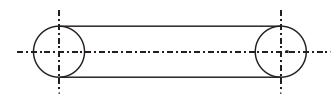

L (mm)	PJ		PK		PL		PM	
	M	T	M	T	M	T	M	T
<750	-10	+10	-11	+13				
750 to 1200	-10	+15	-12	+16	-15	+20		
1200 to 2000	-15	+20	-16	+22	-20	+20		
2000 to 3500	-20	+30	-23	+32	-30	+35	-40	+50
3500 to 5000					-40	+50	-50	+70

How to Use the Idler Pulley

Be careful when you use the idler pulley since it might cause misalignment or shorten the belt service life through flex fatigue. The idler pulley is used when the pulley is fixed, when you want to reduce vibration, or to increase the contact angle of the small pulley. When you use an idler pulley, please follow the instructions given below. Please contact us if you use an outside idler, in particular, since it considerably reduces the belt service life.

Instructions to Use the Idler Pulley

- Use the idler pulley on the slack side of the belt.
- Use the idler pulley at inside of the belt, rather than outside.
- Do not place the idler pulley close to other pulleys.
- The idler pulley should be flat, without any flanges.
- Do not use the belt for clutching device using idler.
- Correct the power transmission capacity if the contact angle might be changed.

1. When using the inside idler pulley

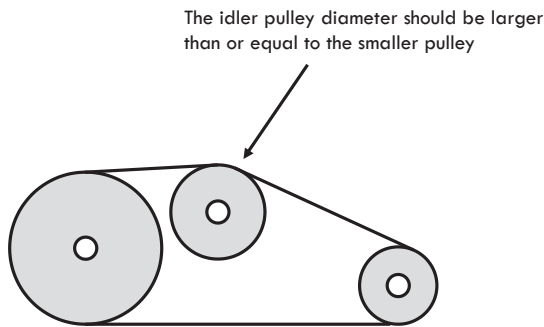

2. When using the outside idler pulley

- Use the flat idler pulley without any crown.
- Position of the idler pulley should be near to the small pulley.

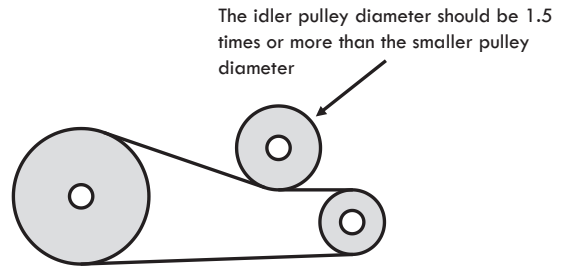

TROUBLE SHOOTING

PROBLEMS	CAUSES	REMEDIES
Ribbed belt breaking after a short period of running	a, Forcing the belt over pulley during installation b, Overloaded drive c, Ingress of foreign body	a, Use proper installation techniques b, Re-check the drive design c, Fit an effective guard
Cuts and splits in the rib	a, Pulley diameter too small b, Ambient temperature too high c, Abnormal belt slip	a, Re-design using the min. recommended diameter b, Ensure good ventilation c, Check drive tension
Severe belt vibrations	a, Overloaded drive b, Centre distance more than recommended c, High shock loading d, Too low belt tension	a, Redesigning drive may be necessary b, Use an inside Idler on the slack side c, Re-tension the drive
Cannot be re-tensioned	a, Insufficient allowance for re-tensioning b, Excessive stretch caused by overloaded drive.	a, Modify the drive b, Re-design the drive
Excessive wear of ribs	a, Starting torque too high b, Incorrect pulleys c, Excessive wear of grooves d, Poor drive alignment e, Smaller than recommended minimum pulley diameter f, Belt catching on protruding parts	a, Re-design the drive b, Re-machine the pulleys c, Re-align the pulleys d, Re-design using correct pulley diameters e, Remove protrusions
Excessive Noise	a, Contamination by oil, grease or chemicals	a, Protect the drive

PULLEY GROOVE DIMENSIONS

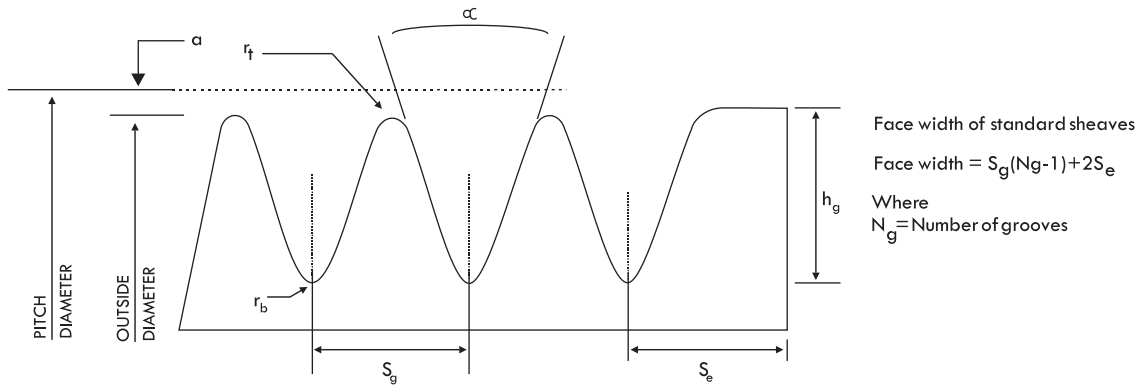

Cross Section	Minimum recommended outer diameter	Groove Angle $\pm 0.25^\circ$	S_g	r_t +0.15 -0.00	2α	r_b	h_g minimum	S_e
H / PH	13	40	1.60 ± 0.03	0.15	0.58	0.30 +0.00 -0.15	1.04	2.0 +0.5 -0.3
J / PJ	20	40	2.34 ± 0.03	0.20	0.76	0.40 +0.00 -0.15	1.77	3.0 +0.8 -0.4
K / PK	40	40	3.56 ± 0.05	0.25	0.96	0.50 +0.00 -0.15	3.16	3.0 +1.5 -0.0
L / PL	75	40	4.70 ± 0.05	0.40	1.54	0.40 +0.00 -0.15	4.63	10.0 +2.0 -1.0
M / PM	180	40	9.40 $\pm 0,08$	0.75	2.88	0.75 +0.00 -0.25	9.74	13.0 +3.0 -1.0

BELT DRIVE DESIGN

Drive Design Procedure for Ribbed Belts

This Design Manual should be used for industrial drive calculation with two standard pulleys only. Please contact us to know about more complex drive designs.

STEP 1 Application Data

1. Type of machine to be driven
2. Nominal Power (kW), P
3. Type & nominal speed of motor
4. Driven Shaft speed
5. Duty cycle category
6. Approximate centre distance

STEP 2 Determine the service factor & the design power

1. To determine the service factor (K) refer to table 31 on page 108
2. Design power : $P_d = P \times K$

STEP 3 Select the Ribbed Belt Section

Refer to the cross section selection chart IV on page 108

STEP 4 Select the effective diameter of the small pulley (de)

Refer to table 32 on page 109

STEP 5 Determine the speed ratio

$SR = R/r$
R = speed of faster shaft
r = speed of slower shaft

STEP 6 Calculate the Large pulley effective diameter (De)

$dp = de + (2 \times h)$, for h refer page 109
 $Dp = dp \times SR$
 $De = Dp - (2 \times h)$
Select the nearest pulley diameter from the table 33 on page 109
 Dp = Pitch Diameter of large pulley in mm

STEP 7 Calculate the belt linear speed

$$v = \frac{\pi \times dp \times n}{60000} \text{ m/s}$$

where,
 dp : Pitch Diameter of smaller pulley in mm
 n : Speed of faster shaft (rpm)

STEP 8 Calculate the effective belt length

$$L_e = 2C + \left[\frac{\pi \times (D_e + d_e)}{2} \right] + \frac{(D_e - d_e)^2}{4C}$$

STEP 9 Calculate the centre distance corresponding to the standard effective length

$$C = \frac{X}{4} + \left[\frac{1}{2} \times \frac{\sqrt{X^2 - (D_e - d_e)^2}}{4} \right]$$

where $X = L_e - \left[\frac{\pi \times (D_e + d_e)}{2} \right]$

STEP 10 Calculate the number of belt ribs

1. Determine the length correction factor, CI
2. Determine the arc of contact on the small pulley

$$\alpha = 180 - \left[\frac{60 \times (D_e - d_e)}{C} \right]$$

3. Determine the arc of contact correction factor, Ca
4. Determine the speed ratio correction factor, Cr
5. Determine the basic power rating per rib (BPR) (Please refer appropriate tables for BPR)
6. Calculate the number of belt ribs (CPR)
 $CPR = (BPR + Cr) \times CI \times Ca$
7. Calculate the number of belt ribs

$$\text{Number} = \frac{\text{Design Power}}{\text{CPR}}$$

(if the no. of Ribs comes in fraction, use next whole no.)

BELT DRIVE DESIGN

Drive Design Example for Ribbed Belts

This Design Manual should be used for industrial drive calculation with two standard pulleys only. Please contact us to know about more complex drive designs.

STEP 1 Application Data

1. Type of driven machine : Printing Machine
2. Nominal Power P: 20 kW
3. Type & nominal speed of motor: DC Motor, 1450 rpm
4. Driven Shaft speed: 884 rpm
5. Duty cycle category: Continuous, 24 hrs / day
6. Approximate centre distance: 500 mm

STEP 2 Determine the service factor & the design power

1. To determine the service factor (K) refer to table 31 on page 108 $K=1.5$
2. Design power : $P_d = P \times K$
 $P_d = 20 \times 1.5$
 $P_d = 30 \text{ kW}$

STEP 3 Select the Ribbed Belt Section

Refer to the cross section selection chart IV on page 108 is PL ($P_d=30\text{kW}$, $n=1450$)

STEP 4 Select the effective diameter of the small pulley (de)

Refer to table 32 on page 109 $d_e = 140 \text{ mm}$

STEP 5 Determine the speed ratio

$SR = n/N$ $SR = 1450/884$
 $n = \text{speed of faster shaft}$ $SR = 1.64$
 $N = \text{speed of slower shaft}$

STEP 6 Calculate the large pulley effective diameter (De)

$d_p = d_e + (2 \times h)$, $d_p = 140 + (2 \times 2.3)$
for h refer to page 109 $d_p = 144.6 \text{ mm}$
 $D_p = d_p \times SR$ $D_p = 144.6 \times 1.64$
 $D_p = 237.14 \text{ mm}$
 $D_e = D_p - (2 \times h)$ $D_e = 237.14 - (2 \times 2.3)$
 $D_e = 232.54 \text{ mm}$
Select the nearest pulley diameter from table 33 on page 109

STEP 7 Calculate the belt linear speed

$V = \frac{\pi \times d_p \times n}{60000} \text{ m/s}$

 $V = 3.14 \times 144.60 \times 1450 / 60000$
 $V = 10.97 \text{ m/s}$

STEP 8 Calculate the effective belt length

$$L_e = 2C + \left[\frac{\pi}{2} \times (D_e + d_e) \right] + \frac{(D_e - d_e)^2}{4C}$$

$$L_e = 2 \times 500 + \left[1.57 (236 + 140) \right] + \frac{(236 - 140)^2}{4 \times 500}$$

$$L_e = 1594.92 \text{ mm}$$

Standard effective length, $L_e = 1595 \text{ mm}$

STEP 9 Calculate the centre distance corresponding to the standard effective length

$$C = \frac{X}{4} + \left[\frac{1}{2} \times \frac{\sqrt{X^2 - (D_e - d_e)^2}}{4} \right]$$

where $X = L_e - \left[\frac{\pi}{2} \times (D_e + d_e) \right]$

$$X = 1595 - [1.57 \times (236 + 140)]$$

$$X = 1004.68$$

$$C = \frac{1004.68}{4} + \left[0.5 \times \frac{\sqrt{(1004.68)^2 - (236 - 140)^2}}{4} \right]$$

$$C = 500 \text{ mm}$$

STEP 10 Calculate the number of ribs

1. Determine the length correction factor from table 44 on page 115
 $C_l = 0.95$
2. Determine the arc of contact on the small pulley
 $\alpha = 180 - \left[\frac{60 \times (D_e - d_e)}{C} \right]$
 $\alpha = 180 - \left[\frac{60 \times (236 - 140)}{500} \right]$
 $\alpha = 168.50$
3. Determine the arc of contact correction factor from table 45 on page 115 $C_a = 0.96$
4. Determine the speed ratio correction factor from table 43 on page 115 $C_r = 0.120$
5. Determine the basic power rating per rib (BPR) from table 42 on page 114 = 2.291 kw
6. Calculate the corrected power rating per rib (CPR)
 $CPR = (BPR + C_r) \times C_l \times C_a = (2.291 + 0.12) \times 0.95 \times 0.96$
 $CPR = 2.199 \text{ kw / rib}$
7. Calculate the number of belt ribs
Number = Design power / Corrected Power Rating
 = $30 / 2.199 = 13.64$,
 Standard no. of ribs = 14

TABLE 31 : SERVICE FACTOR SELECTION

Driven Machine	Motor Class	Class A			Class B		
		D.C.Motors Shunt wound A.C.Motors Normal Torque Synchronous or Asynchronous DC Brushless Motors IC Engines Speed > 700rpm Turbines			DC Motors Compound & Series wound AC Motors High Torque Vector Control Reluctance Motors IC engines single cylinder Speed < 700rpm Line Shafts, clutches		
DUTY CYCLE CLASS		< 10H	10 - 16H	> 16H	< 10H	10 - 16H	> 16H
CLASS 1 : LOW EVEN TORQUE Vacuum Cleaners, liquid agitators, belt-conveyors, blowers, centrifugal fans, light conveyors		1.0	1.1	1.2	1.1	1.2	1.3
CLASS 2 : MEDIUM EVEN TORQUE Food agitators, mixers, laundry machines, generators, machine tools, blenders		1.1	1.2	1.3	1.2	1.3	1.4
CLASS 3 : TORQUE Bakery & woodwork m/c, brick m/c, rotary-compressors, pumps, heavy duty conveyors, exciters, printing m/c, spraying m/c, axial fan		1.2	1.3	1.4	1.3	1.4	1.5
CLASS 4 : VERY UNEVEN TORQUE Hammer mills, cement works, piston compressors, bucket elevators, hoists, flour mills, piston pumps, winches, paper mills		1.4	1.5	1.6	1.5	1.6	1.8
CLASS 5 : VERY UNEVEN TORQUE WITH OVERLOADS Crushers, grinder m/c, ball grinders, dredging m/c, agricultural m/c, industrial rubber machinery (Calenders, extruders, mixers)		1.6	1.7	1.8	1.7	1.8	2.0

CHART IV : CROSS SECTION SELECTION

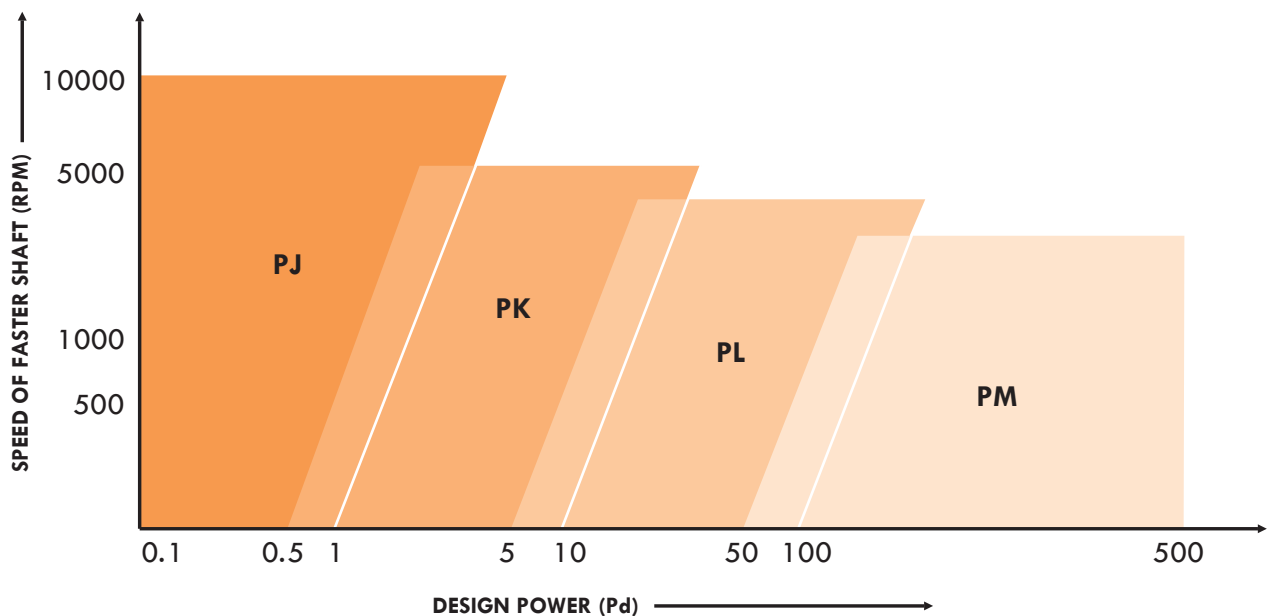

DEFINITION OF SMALL PULLEY EFFECTIVE DIAMETER (mm)

Pitch Diameter (mm) = Effective Diameter (mm) + (2 x h)

Belt Section	PJ	PK	PL	PM
h (mm)	1.05	1.6	2.3	2.6

TABLE 32 : DETERMINATION OF SMALL PULLEY EFFECTIVE DIAMETER (de)

n(rpm)	Design Power (kW)															
	0.25	0.5	1	2	4	7	10	20	30	50	75	100	125	150	175	200
100	45	60	75	95	125	160	180	224	250	315	355	400	450	500	500	500
300	40	50	63	80	106	125	140	180	212	250	280	315	355	355	400	400
500	35	45	60	75	95	112	125	160	180	224	250	280	315	315	355	355
750	35	45	56	67	85	106	118	150	170	200	224	250	280	280	315	315
1000	30	40	50	63	80	95	106	132	150	190	200	224	250	250	280	280
1500	30	35	45	60	71	85	95	125	140	170	180	200	212	224	236	250
2000	30	35	45	56	67	80	90	112	125	150	170	180	200	212	224	224
3000	25	30	40	50	60	71	80	100	112	132	150	160	170	180	190	200
4000	25	30	35	45	56	67	71	90	100	118	132	140	150	160	170	180
5000	20	30	35	40	50	60	67	80	95	106	125	132	140	150		
6000	20	25	30	40	50	56	63	75	85	100	112	125				
7000	20	25	30	40	45	56	60	75	85	95	106	118				
8000	20	25	30	35	45	50	56	71	80	90	100	112				
9000	20	20	30	35	40	50	56	67	75	85	95					
10000	20	20	30	35	40	45	50	63	75	80	90					

TABLE 33 : STANDARD PULLEYS

Effective Diameter (mm)	SECTION				Effective Diameter (mm)	SECTION			
	PJ no. of ribs 4, 8, 12, 16, 20	PK no. ribs 6, 8, 10, 12, 16, 20	PL no. ribs 6, 8, 10, 12, 16, 20	PM no. of ribs 6, 10, 16, 20		PJ no. of ribs 4, 8, 12, 16, 20	PK no. ribs 6, 8, 10, 12, 16, 20	PL no. ribs 6, 8, 10, 12, 16, 20	PM no. of ribs 6, 10, 16, 20
20	●				132	●	●	●	
25	●				140	●	●	●	
30	●				150		●	●	
35	●				160	●	●	●	
40	●				170		●	●	
45	●				180	●	●	●	●
50	●				190		●	●	●
56	●	●			200	●	●	●	●
60	●	●			212		●	●	●
63	●	●			224	●	●	●	●
67	●	●			236		●	●	
71	●	●			250	●	●	●	●
75	●	●	●		280	●	●	●	●
80	●	●	●		315	●	●	●	●
85	●	●	●		355	●	●	●	●
90	●	●	●		400	●	●	●	●
95	●	●	●		450		●	●	●
100	●	●	●		500		●	●	●
106	●	●	●		560				●
112	●	●	●		630			●	●
118	●	●	●		710				●
125	●	●	●		800			●	

TABLE 34 : SECTION PJ: BASIC POWER RATING PER RIB (kW) FOR SMALL PULLEY EFFECTIVE DIAMETER (mm)

de	SPEED OF THE SMALL PULLEY RPM																																		
	20	25	30	32	35	40	45	50	56	60	63	67	71	75	80	85	90	95	100	112	118	125	132	140	160	180	200	224	250	280	315	355	400		
100	0.048	0.007	0.010	0.010	0.010	0.014	0.015	0.017	0.021	0.023	0.024	0.025	0.027	0.030	0.032	0.034	0.037	0.038	0.038	0.045	0.048	0.051	0.054	0.058	0.067	0.074	0.084	0.094	0.104	0.110	0.110	0.151	0.170		
200	0.010	0.014	0.020	0.023	0.027	0.031	0.035	0.041	0.043	0.045	0.047	0.051	0.054	0.058	0.062	0.067	0.070	0.073	0.075	0.080	0.085	0.091	0.097	0.107	0.114	0.131	0.147	0.165	0.182	0.204	0.232	0.240	0.330	0.330	
300	0.013	0.021	0.025	0.030	0.034	0.040	0.045	0.054	0.061	0.065	0.071	0.075	0.080	0.087	0.091	0.100	0.105	0.111	0.118	0.134	0.141	0.151	0.158	0.170	0.195	0.220	0.244	0.271	0.305	0.341	0.370	0.433	0.487		
400	0.017	0.025	0.034	0.039	0.045	0.054	0.062	0.070	0.081	0.087	0.094	0.100	0.102	0.114	0.123	0.132	0.141	0.152	0.161	0.172	0.181	0.194	0.219	0.244	0.260	0.274	0.314	0.357	0.395	0.440	0.450	0.560	0.569	0.636	
500	0.022	0.034	0.042	0.048	0.055	0.066	0.076	0.087	0.100	0.110	0.114	0.123	0.132	0.141	0.152	0.161	0.172	0.181	0.194	0.219	0.244	0.260	0.274	0.314	0.357	0.395	0.440	0.450	0.560	0.560	0.701	0.785			
560	0.023	0.037	0.050	0.054	0.061	0.074	0.085	0.098	0.112	0.122	0.129	0.139	0.147	0.155	0.168	0.180	0.192	0.201	0.214	0.244	0.257	0.272	0.287	0.304	0.350	0.397	0.441	0.525	0.552	0.618	0.690	0.780	0.872		
600	0.026	0.042	0.051	0.058	0.065	0.079	0.090	0.104	0.120	0.131	0.137	0.147	0.158	0.165	0.180	0.191	0.205	0.218	0.230	0.260	0.272	0.291	0.308	0.328	0.374	0.421	0.471	0.610	0.590	0.660	0.730	0.831	0.931		
700	0.030	0.047	0.062	0.068	0.076	0.092	0.106	0.121	0.138	0.150	0.160	0.171	0.183	0.195	0.207	0.220	0.235	0.253	0.267	0.300	0.318	0.337	0.358	0.380	0.434	0.491	0.544	0.628	0.681	0.761	0.850	0.959	0.930		
720	0.031	0.048	0.063	0.070	0.079	0.094	0.110	0.124	0.142	0.155	0.164	0.174	0.188	0.200	0.213	0.220	0.244	0.258	0.274	0.308	0.327	0.347	0.367	0.390	0.445	0.504	0.560	0.694	0.701	0.781	0.860	0.984	1.072		
800	0.035	0.053	0.070	0.076	0.086	0.104	0.121	0.137	0.157	0.172	0.180	0.195	0.208	0.221	0.236	0.254	0.270	0.287	0.301	0.342	0.361	0.384	0.404	0.431	0.495	0.555	0.620	0.771	0.772	0.861	0.950	1.082	1.100		
900	0.040	0.059	0.076	0.086	0.097	0.117	0.135	0.154	0.176	0.190	0.203	0.217	0.233	0.251	0.268	0.284	0.300	0.321	0.338	0.381	0.402	0.428	0.454	0.481	0.550	0.621	0.690	0.821	0.860	0.961	1.040	1.200	1.210		
960	0.041	0.061	0.082	0.090	0.103	0.123	0.143	0.165	0.187	0.204	0.215	0.232	0.247	0.263	0.281	0.301	0.321	0.341	0.360	0.404	0.428	0.454	0.480	0.511	0.587	0.662	0.734	0.855	0.914	1.020	1.130	1.275	1.343		
1000	0.043	0.064	0.086	0.095	0.106	0.128	0.150	0.170	0.195	0.212	0.223	0.240	0.257	0.273	0.292	0.312	0.331	0.353	0.371	0.422	0.445	0.474	0.501	0.531	0.612	0.685	0.764	1.008	0.950	1.058	1.170	1.321	1.420		
1200	0.051	0.075	0.103	0.112	0.128	0.153	0.177	0.202	0.231	0.251	0.267	0.285	0.306	0.325	0.348	0.372	0.395	0.420	0.441	0.501	0.530	0.560	0.594	0.631	0.721	0.814	0.904	1.156	1.121	1.247	1.380	1.545	1.471		
1400	0.061	0.091	0.121	0.133	0.151	0.182	0.211	0.240	0.241	0.297	0.317	0.340	0.362	0.384	0.414	0.441	0.470	0.500	0.527	0.595	0.627	0.665	0.704	0.745	0.854	0.962	1.067	1.304	1.317	1.460	1.600	1.792	1.932		
1600	0.065	0.100	0.134	0.146	0.167	0.200	0.233	0.265	0.304	0.330	0.350	0.374	0.400	0.425	0.458	0.488	0.520	0.550	0.581	0.655	0.691	0.734	0.779	0.821	0.942	1.058	1.170	1.441	1.445	1.596	1.760	1.943	1.972		
1800	0.075	0.111	0.150	0.165	0.187	0.224	0.260	0.297	0.340	0.369	0.390	0.418	0.445	0.475	0.511	0.544	0.581	0.615	0.650	0.731	0.771	0.820	0.865	0.917	1.050	1.176	1.300	1.576	1.592	1.755	1.920	2.114	2.125		
2000	0.082	0.124	0.165	0.180	0.207	0.246	0.287	0.327	0.375	0.405	0.431	0.461	0.491	0.523	0.564	0.600	0.641	0.679	0.717	0.807	0.850	0.901	0.954	1.010	1.151	0.920	0.421	1.702	1.734	1.902	2.070	2.260	2.292		
2200	0.090	0.133	0.180	0.198	0.226	0.270	0.314	0.357	0.410	0.444	0.471	0.504	0.540	0.574	0.614	0.654	0.700	0.741	0.781	0.880	0.928	0.984	1.037	1.101	1.252	1.400	1.541	1.822	1.864	2.038	2.200	2.384	2.426		
2400	0.096	0.145	0.193	0.215	0.245	0.293	0.340	0.387	0.444	0.482	0.511	0.547	0.584	0.622	0.665	0.710	0.758	0.803	0.847	0.951	1.004	1.064	1.123	1.187	1.352	1.507	1.654	1.932	1.988	2.160	2.300	2.480	2.526		
2600	0.104	0.156	0.210	0.232	0.265	0.315	0.366	0.419	0.480	0.520	0.550	0.590	0.630	0.667	0.718	0.765	0.815	0.863	0.910	1.024	1.077	1.141	1.204	1.275	1.445	1.608	1.762	2.036	2.100	2.267	2.480	2.578	2.588		
2800	0.111	0.166	0.225	0.247	0.282	0.337	0.394	0.448	0.514	0.556	0.587	0.632	0.674	0.716	0.768	0.820	0.872	0.924	0.971	1.093	1.151	1.217	1.284	1.359	1.537	1.704	1.860	2.075	2.200	2.359	2.510	2.585	2.608		
2880	0.114	0.171	0.231	0.254	0.290	0.345	0.403	0.460	0.526	0.572	0.605	0.647	0.692	0.735	0.788	0.840	0.892	0.947	0.995	1.120	1.180	1.247	1.314	1.391	1.573	1.745	1.902	2.130	2.237	2.391	2.540	2.590	2.585		
3000	0.118	0.180	0.241	0.265	0.301	0.360	0.420	0.477	0.547	0.594	0.627	0.671	0.717	0.763	0.819	0.874	0.928	0.981	1.035	1.160	1.220	1.291	1.361	1.440	1.624	1.798	1.957	2.215	2.288	2.390	2.540	2.588			
3200	0.125	0.190	0.253	0.281	0.320	0.383	0.444	0.507	0.580	0.630	0.665	0.713	0.763	0.808	0.865	0.924	0.981	1.040	1.093	1.228	1.292	1.365	1.437	1.518	1.710	1.886	2.071	2.287	2.364	2.432	2.550	2.588			
3400	0.132	0.201	0.270	0.297	0.337	0.405	0.470	0.535	0.614	0.665	0.704	0.754	0.804	0.855	0.916	0.974	1.037	1.097	1.153	1.293	1.360	1.434	1.510	1.594	1.790	1.969	2.124	2.354	2.425	2.491	2.520				
3600	0.140	0.211	0.284	0.314	0.354	0.427	0.495	0.554	0.646	0.704	0.740	0.794	0.845	0.896	0.965	1.025	1.090	1.153	1.213	1.356	1.424	1.504	1.580	1.667	1.865	2.045	2.201	2.407	2.474	2.528					
3800	0.146	0.223	0.304	0.330	0.392	0.448	0.521	0.595	0.680	0.730	0.778	0.833	0.888	0.944	1.011	1.077	1.143	1.208	1.275	1.418	1.490	1.571	1.650	1.737	1.937	2.115	2.266	2.448	2.504	2.547					
4000	0.150	0.234	0.314	0.340	0.403	0.460	0.540	0.621	0.712	0.770	0.815	0.870	0.931	0.977	1.056	1.127	1.195	1.261	1.325	1.478	1.554	1.634	1.714	1.804	2.006	2.180	2.324	2.478	2.520	2.544					
4200	0.160	0.245	0.328	0.360	0.426	0.491	0.570	0.651	0.743	0.804	0.852	0.910	0.972	1.031	1.110	1.175	1.245	1.314	1.381	1.538	1.611	1.695	1.778	1.868	2.067	2.235	2.371	2.494	2.522	2.517					
4400	0.167	0.252	0.343	0.376	0.443	0.512	0.595	0.677	0.775	0.840	0.887	0.950	1.012	1.073	1.148	1.221	1.295	1.366	1.435	1.595	1.670	1.757	1.840	1.928	2.127	2.290	2.410	2.498	2.502						
4500	0.170	0.260	0.347	0.384	0.446	0.522	0.607	0.692	0.790	0.856	0.905	0.968	1.032	1.094	1.171	1.245	1.318	1.391	1.461	1.623	1.702	1.784	1.867	1.957	2.155	2.313	2.425	2.488							
4600	0.174	0.263	0.355	0.390	0.463	0.533	0.620	0.705	0.807	0.876	0.923	0.987	1.052	1.114	1.191	1.265	1.341	1.415	1.485	1.650	1.727	1.814	1.897	1.987	2.181	2.334	2.440	2.487							
4800	0.179	0.274	0.370	0.404	0.480	0.554	0.644	0.732	0.838	0.906	0.957	1.021	1.091	1.156	1.236	1.314	1.390	1.465	1.538	1.704	1.781	1.869	1.951	2.038	2.228	2.370	2.457	2.463							
5000	0.185	0.283	0.382	0.422	0.504	0.574	0.667	0.761	0.869	0.940	0.993	1.062	1.130	1.194	1.277	1.357	1.437	1.511																	

TABLE 35 : SECTION PJ: SPEED RATIO CORRECTION FACTOR (Cr)

Speed of small pulley in RPM	Speed Ratio	1.00 to 1.01	1.02 to 1.04	1.05 to 1.09	1.10 to 1.16	1.17 to 1.26	1.27 to 1.40	1.41 to 1.65	above 1.66	Speed Ratio	1.00 to 1.01	1.02 to 1.04	1.05 to 1.09	1.10 to 1.16	1.17 to 1.26	1.27 to 1.40	1.41 to 1.65	above 1.66
	100	0.00	0.00	0.00	0.00	0.00	0.00	0.00	0.00	0.00	4500	0.00	0.01	0.01	0.02	0.02	0.03	0.04
200	0.00	0.00	0.00	0.00	0.00	0.00	0.00	0.00	0.00	4600	0.00	0.01	0.01	0.02	0.02	0.03	0.04	0.04
300	0.00	0.00	0.00	0.00	0.00	0.00	0.00	0.00	0.00	4800	0.00	0.01	0.01	0.02	0.03	0.03	0.04	0.05
400	0.00	0.00	0.00	0.00	0.00	0.00	0.00	0.00	0.00	5000	0.00	0.01	0.01	0.02	0.03	0.03	0.04	0.05
500	0.00	0.00	0.00	0.00	0.00	0.00	0.00	0.00	0.00	5200	0.00	0.01	0.01	0.02	0.03	0.04	0.04	0.05
560	0.00	0.00	0.00	0.00	0.00	0.00	0.00	0.00	0.01	5400	0.00	0.01	0.01	0.02	0.03	0.04	0.04	0.05
600	0.00	0.00	0.00	0.00	0.00	0.00	0.00	0.00	0.01	5500	0.00	0.01	0.01	0.02	0.03	0.04	0.04	0.05
700	0.00	0.00	0.00	0.00	0.00	0.00	0.00	0.01	0.01	5600	0.00	0.01	0.02	0.02	0.03	0.04	0.05	0.05
720	0.00	0.00	0.00	0.00	0.00	0.00	0.00	0.01	0.01	5800	0.00	0.01	0.02	0.02	0.03	0.04	0.05	0.06
800	0.00	0.00	0.00	0.00	0.00	0.01	0.01	0.01	0.01	6000	0.00	0.01	0.02	0.02	0.03	0.04	0.05	0.06
900	0.00	0.00	0.00	0.00	0.00	0.01	0.01	0.01	0.01	6200	0.00	0.01	0.02	0.03	0.03	0.04	0.05	0.06
960	0.00	0.00	0.00	0.00	0.01	0.01	0.01	0.01	0.01	6400	0.00	0.01	0.02	0.03	0.03	0.04	0.05	0.06
1000	0.00	0.00	0.00	0.00	0.01	0.01	0.01	0.01	0.01	6600	0.00	0.01	0.02	0.03	0.04	0.04	0.05	0.06
1200	0.00	0.00	0.00	0.00	0.01	0.01	0.01	0.01	0.01	6800	0.00	0.01	0.02	0.03	0.04	0.05	0.06	0.06
1400	0.00	0.00	0.00	0.01	0.01	0.01	0.01	0.01	0.01	7000	0.00	0.01	0.02	0.03	0.04	0.05	0.06	0.07
1440	0.00	0.00	0.00	0.01	0.01	0.01	0.01	0.01	0.01	7200	0.00	0.01	0.02	0.03	0.04	0.05	0.06	0.07
1600	0.00	0.00	0.00	0.01	0.01	0.01	0.01	0.01	0.02	7400	0.00	0.01	0.02	0.03	0.04	0.05	0.06	0.07
1800	0.00	0.00	0.00	0.01	0.01	0.01	0.01	0.01	0.02	7400	0.00	0.01	0.02	0.03	0.04	0.05	0.06	0.07
2000	0.00	0.00	0.01	0.01	0.01	0.01	0.01	0.02	0.02	7600	0.00	0.01	0.02	0.03	0.04	0.05	0.06	0.07
2200	0.00	0.00	0.01	0.01	0.01	0.01	0.01	0.02	0.02	7800	0.00	0.01	0.02	0.03	0.04	0.05	0.06	0.07
2400	0.00	0.00	0.01	0.01	0.01	0.01	0.02	0.02	0.02	8000	0.00	0.01	0.02	0.03	0.04	0.05	0.06	0.08
2600	0.00	0.00	0.01	0.01	0.01	0.02	0.02	0.02	0.02	8200	0.00	0.01	0.02	0.03	0.04	0.06	0.06	0.08
2800	0.00	0.00	0.01	0.01	0.02	0.02	0.02	0.03	0.03	8400	0.00	0.01	0.02	0.03	0.05	0.06	0.07	0.08
2880	0.00	0.00	0.01	0.01	0.02	0.02	0.02	0.03	0.03	8600	0.00	0.01	0.02	0.04	0.05	0.06	0.07	0.08
3000	0.00	0.00	0.01	0.01	0.02	0.02	0.02	0.03	0.03	8800	0.00	0.01	0.02	0.04	0.05	0.06	0.07	0.08
3200	0.00	0.00	0.01	0.01	0.02	0.02	0.03	0.03	0.03	9000	0.00	0.01	0.02	0.04	0.05	0.06	0.07	0.09
3400	0.00	0.00	0.01	0.01	0.02	0.02	0.03	0.03	0.03	9200	0.00	0.01	0.02	0.04	0.05	0.06	0.07	0.09
3600	0.00	0.01	0.01	0.01	0.02	0.02	0.03	0.03	0.03	9400	0.00	0.01	0.03	0.04	0.05	0.06	0.08	0.09
3800	0.00	0.01	0.01	0.02	0.02	0.03	0.03	0.04	0.04	9600	0.00	0.01	0.03	0.04	0.05	0.07	0.08	0.09
4000	0.00	0.01	0.01	0.02	0.02	0.03	0.03	0.04	0.04	9800	0.00	0.01	0.03	0.04	0.05	0.07	0.08	0.09
4200	0.00	0.01	0.01	0.02	0.02	0.03	0.03	0.04	0.04	10000	0.00	0.01	0.03	0.04	0.05	0.07	0.08	0.10
4400	0.00	0.01	0.01	0.02	0.02	0.03	0.04	0.04	0.04									

TABLE 36 : SECTION PJ: LENGTH CORRECTION FACTOR (Cl)

Effective Length	Correction Factor
Up to 200	0.60
200 - 350	0.80
350 - 500	0.85
500 - 700	0.90
700 - 900	0.95
900 - 1200	1.00
1200 - 1500	1.05
1500 - 2000	1.10
2000 - 2500	1.15
above 2500	1.20

TABLE 37 : SECTION PJ: ARC OF CONTACT CORRECTION FACTOR (Ca)

Arc of Contact on Small Pulley	Correction Factor
100	0.72
110	0.76
120	0.80
130	0.84
140	0.88
150	0.91
160	0.94
170	0.97
180	1.00
190	1.02
200	1.05
210	1.07
220	1.09
230	1.11

TABLE 38 : SECTION PK: BASIC POWER RATING PER RIB (kW) FOR SMALL PULLEY EFFECTIVE DIAMETER (mm)

de	SPEED OF THE SMALL PULLEY RPM																															
	50	56	60	63	67	71	75	80	85	90	95	100	106	112	118	125	132	140	160	180	200	224	250	280	315	355	400	450	500	560	630	
100	0.222	0.031	0.034	0.037	0.041	0.047	0.051	0.057	0.064	0.068	0.074	0.080	0.087	0.094	0.101	0.107	0.114	0.125	0.144	0.167	0.191	0.215	0.244	0.275	0.314	0.354	0.401	0.454	0.504	0.567	0.636	
200	0.044	0.056	0.064	0.074	0.082	0.091	0.100	0.110	0.120	0.132	0.144	0.154	0.167	0.180	0.193	0.207	0.221	0.240	0.281	0.325	0.365	0.414	0.470	0.531	0.602	0.684	0.774	0.874	0.975	1.091	1.225	
300	0.065	0.084	0.094	0.104	0.110	0.120	0.132	0.145	0.160	0.175	0.192	0.210	0.225	0.244	0.262	0.282	0.304	0.324	0.351	0.411	0.475	0.535	0.610	0.689	0.778	0.881	1.002	1.134	1.280	1.424	1.597	1.794
400	0.081	0.108	0.125	0.138	0.154	0.171	0.190	0.211	0.230	0.251	0.275	0.295	0.321	0.344	0.366	0.398	0.425	0.460	0.540	0.621	0.701	0.800	0.902	1.021	1.157	1.312	1.484	1.673	1.861	2.084	2.337	
500	0.100	0.132	0.154	0.170	0.190	0.211	0.231	0.258	0.284	0.310	0.334	0.361	0.391	0.424	0.455	0.490	0.525	0.567	0.665	0.765	0.866	0.985	1.112	1.255	1.425	1.612	1.825	2.054	2.280	2.530	2.822	3.156
600	0.118	0.153	0.181	0.200	0.225	0.250	0.275	0.305	0.335	0.366	0.398	0.428	0.465	0.501	0.538	0.581	0.621	0.670	0.791	0.908	1.025	1.167	1.314	1.488	1.685	1.910	2.157	2.427	2.691	3.000	3.351	
700	0.134	0.178	0.208	0.230	0.256	0.287	0.315	0.351	0.388	0.424	0.460	0.495	0.536	0.580	0.622	0.671	0.718	0.771	0.914	1.048	1.184	1.344	1.518	1.714	1.841	2.198	2.478	2.784	3.082	3.428	3.817	
800	0.150	0.201	0.234	0.261	0.291	0.324	0.354	0.394	0.436	0.478	0.520	0.560	0.608	0.655	0.704	0.758	0.814	0.872	1.031	1.187	1.341	1.521	1.717	1.938	2.193	2.475	2.792	3.130	3.454	3.834	4.251	
900	0.166	0.224	0.261	0.305	0.345	0.382	0.421	0.470	0.518	0.566	0.611	0.662	0.717	0.773	0.831	0.885	0.908	0.976	1.152	1.324	1.494	1.695	1.911	2.157	2.437	2.751	3.092	3.462	3.811	4.214	4.651	
1000	0.180	0.246	0.286	0.316	0.356	0.394	0.438	0.487	0.537	0.585	0.637	0.685	0.746	0.805	0.861	0.932	1.001	1.077	1.268	1.455	1.644	1.864	2.104	2.371	2.674	3.015	3.384	3.777	4.148	4.566	5.013	
1200	0.211	0.285	0.334	0.372	0.421	0.467	0.515	0.575	0.635	0.693	0.753	0.811	0.882	0.950	1.021	1.101	1.181	1.273	1.498	1.720	1.940	2.196	2.474	2.782	3.131	3.514	3.925	4.357	4.754	5.180	5.607	
1400	0.244	0.329	0.385	0.424	0.481	0.536	0.592	0.659	0.730	0.796	0.864	0.934	1.012	1.094	1.172	1.264	1.355	1.462	1.721	1.971	2.225	2.518	2.825	3.170	3.560	3.981	4.420	4.861	5.257	5.652	6.010	
1600	0.250	0.337	0.395	0.435	0.495	0.551	0.607	0.677	0.745	0.818	0.888	0.955	1.040	1.122	1.203	1.300	1.394	1.501	1.764	2.027	2.281	2.581	2.896	3.250	3.644	4.067	4.511	4.954	5.346	5.732	6.065	
1800	0.273	0.366	0.431	0.480	0.541	0.604	0.666	0.743	0.823	0.903	0.977	1.051	1.144	1.235	1.333	1.428	1.530	1.640	1.940	2.224	2.500	2.824	3.165	3.541	3.955	4.396	4.851	5.285	5.647	5.975	6.189	
2000	0.300	0.407	0.477	0.530	0.600	0.671	0.742	0.826	0.914	1.000	1.085	1.170	1.271	1.375	1.470	1.572	1.670	1.831	2.151	2.461	2.765	3.115	3.484	3.884	4.316	4.769	5.210	5.611	5.907	6.111		
2200	0.329	0.447	0.525	0.582	0.660	0.737	0.814	0.907	1.004	1.098	1.191	1.285	1.394	1.506	1.613	1.742	1.865	2.008	2.356	2.690	3.020	3.396	3.781	4.199	4.643	5.082	5.497	5.830	6.023			
2400	0.381	0.520	0.611	0.681	0.774	0.864	0.954	1.063	1.178	1.286	1.396	1.506	1.637	1.765	1.892	2.038	2.184	2.347	2.745	3.124	3.489	3.901	4.311	4.734	5.158	5.532	5.811					
2600	0.405	0.553	0.654	0.728	0.824	0.925	1.021	1.140	1.262	1.381	1.497	1.614	1.752	1.890	2.024	2.180	2.334	2.507	2.924	3.325	3.704	4.125	4.535	4.950	5.344	5.660	5.825					
2800	0.431	0.590	0.695	0.776	0.881	0.984	1.088	1.216	1.345	1.470	1.594	1.718	1.864	2.012	2.155	2.320	2.481	2.665	3.101	3.517	3.902	4.326	4.734	5.131	5.477	5.711						
2880	0.440	0.605	0.711	0.795	0.901	1.007	1.115	1.245	1.377	1.505	1.634	1.761	1.911	2.058	2.206	2.375	2.536	2.724	3.171	3.590	3.978	4.404	4.805	5.191	5.515	5.710						
3000	0.454	0.625	0.738	0.822	0.934	1.043	1.154	1.287	1.425	1.558	1.691	1.822	1.977	2.130	2.280	2.451	2.624	2.814	3.270	3.690	4.087	4.511	4.906	5.287	5.555							
3200	0.477	0.655	0.777	0.867	0.985	1.101	1.217	1.359	1.504	1.645	1.784	1.921	2.084	2.244	2.402	2.581	2.758	2.953	3.425	3.862	4.256	4.670	5.045	5.364	5.572							
3400	0.500	0.690	0.817	0.910	1.034	1.158	1.280	1.430	1.581	1.728	1.872	2.017	2.187	2.354	2.518	2.705	2.891	3.094	3.575	4.015	4.406	4.808	5.151	5.415								
3600	0.522	0.724	0.855	0.954	1.084	1.214	1.340	1.497	1.655	1.810	1.960	2.112	2.288	2.462	2.632	2.825	3.014	3.224	3.711	4.150	4.537	4.917	5.222	5.417								
3800	0.543	0.754	0.891	0.995	1.131	1.266	1.400	1.566	1.728	1.890	2.045	2.202	2.385	2.565	2.741	2.941	3.134	3.347	3.841	4.279	4.651	5.003	5.256									
4000	0.564	0.784	0.929	1.035	1.174	1.310	1.455	1.629	1.800	1.966	2.130	2.291	2.480	2.660	2.844	3.048	3.244	3.466	3.956	4.387	4.743	5.056	5.255									
4200	0.584	0.812	0.967	1.075	1.224	1.370	1.515	1.691	1.866	2.041	2.210	2.376	2.570	2.756	2.942	3.150	3.350	3.567	4.064	4.481	4.813	5.086	5.211									
4400	0.602	0.842	0.995	1.116	1.266	1.421	1.571	1.754	1.936	2.112	2.286	2.456	2.655	2.845	3.036	3.245	3.448	3.666	4.157	4.560	4.862	5.083										
4500	0.612	0.854	1.016	1.135	1.292	1.445	1.598	1.784	1.966	2.147	2.325	2.497	2.697	2.893	3.082	3.294	3.495	3.714	4.201	4.591	4.877	5.066										
4600	0.622	0.870	1.031	1.151	1.311	1.468	1.623	1.811	2.000	2.183	2.361	2.535	2.737	2.933	3.124	3.335	3.540	3.758	4.240	4.621	4.888	5.046										
4800	0.640	0.897	1.063	1.190	1.352	1.516	1.677	1.870	2.064	2.250	2.431	2.610	2.817	3.015	3.207	3.422	3.624	3.841	4.308	4.662	4.891											
5000	0.665	0.927	1.098	1.225	1.395	1.562	1.724	1.922	2.121	2.314	2.500	2.680	2.891	3.092	3.284	3.496	3.700	3.914	4.364	4.684	4.867											
5200	0.675	0.947	1.127	1.260	1.434	1.605	1.774	1.977	2.180	2.375	2.564	2.748	2.960	3.162	3.355	3.571	3.766	3.975	4.407	4.691	4.818											
5400	0.691	0.971	1.157	1.293	1.472	1.647	1.820	2.029	2.235	2.432	2.624	2.811	3.025	3.228	3.421	3.633	3.828	4.031	4.435	4.675												
5500	0.707	0.987	1.171	1.310	1.491	1.666	1.844	2.053	2.261	2.461	2.655	2.841	3.054	3.260	3.451	3.661	3.854	4.054	4.444	4.664												
5600	0.715	0.996	1.186	1.325	1.508	1.687	1.861	2.077	2.287	2.488	2.682	2.871	3.084	3.291	3.481	3.690	3.880	4.075	4.447	4.641												
5800	0.720	1.017	1.212	1.354	1.544	1.727	1.904	2.123	2.337	2.542	2.737	2.925	3.141	3.343	3.535	3.737	3.924	4.108	4.447	4.585												
6000	0.735	1.040	1.238	1.385	1.578	1.765	1.945	2.167	2.384	2.590	2.787	2.975	3.192	3.392	3.580	3.778	3.954	4.131	4.428													
6200	0.746	1.060	1.264	1.414	1.610	1.800	1.985	2.211	2.425	2.634	2.834	3.024	3.237	3.436	3.620	3.812	3.981	4.142	4.395													
6400	0.760	1.080	1.287	1.441	1.640	1.834	2.021	2.248	2.470	2.678	2.876	3.065	3.278	3.472	3.652	3.837	3.991	4.142	4.344													
6800	0.784	1.117	1.333	1.490	1.695	1.895	2.090	2.321	2.544	2.754	2.952	3.137	3.344	3.528	3.694	3.861																

TABLE 39 : SECTION PK: SPEED RATIO CORRECTION FACTOR (Cr)

Speed of small pulley in RPM	Speed Ratio	1.00 to 1.03	1.04 to 1.08	1.09 to 1.15	1.16 to 1.24	1.25 to 1.48	1.49 to 2.00	2.01 to 2.75	above 2.76	Speed Ratio	1.00 to 1.03	1.04 to 1.08	1.09 to 1.15	1.16 to 1.24	1.25 to 1.48	1.49 to 2.00	2.01 to 2.75	above 2.76
	100	0.00	0.00	0.00	0.00	0.01	0.01	0.01	0.01	0.01	4400	0.00	0.06	0.12	0.18	0.24	0.28	0.31
200	0.00	0.00	0.01	0.01	0.01	0.01	0.01	0.01	0.02	4500	0.00	0.06	0.12	0.18	0.24	0.29	0.32	0.36
300	0.00	0.00	0.01	0.01	0.02	0.02	0.02	0.02	0.02	4600	0.00	0.06	0.12	0.19	0.25	0.29	0.33	0.37
400	0.00	0.01	0.01	0.02	0.02	0.03	0.03	0.03	0.03	4800	0.00	0.06	0.13	0.19	0.26	0.31	0.34	0.39
500	0.00	0.01	0.01	0.02	0.03	0.03	0.04	0.04	0.04	5000	0.00	0.07	0.14	0.20	0.27	0.32	0.35	0.41
560	0.00	0.01	0.02	0.02	0.03	0.04	0.04	0.04	0.05	5200	0.00	0.07	0.14	0.21	0.28	0.33	0.37	0.42
600	0.00	0.01	0.02	0.02	0.03	0.04	0.04	0.04	0.05	5400	0.00	0.07	0.15	0.22	0.29	0.35	0.38	0.44
700	0.00	0.01	0.02	0.03	0.04	0.04	0.05	0.05	0.06	5500	0.00	0.07	0.15	0.22	0.30	0.35	0.39	0.45
720	0.00	0.01	0.02	0.03	0.04	0.05	0.05	0.05	0.06	5600	0.00	0.08	0.15	0.23	0.30	0.36	0.40	0.45
800	0.00	0.01	0.02	0.03	0.04	0.05	0.06	0.06	0.06	5800	0.00	0.08	0.16	0.23	0.31	0.37	0.41	0.47
900	0.00	0.01	0.02	0.04	0.05	0.06	0.06	0.07	0.07	6000	0.00	0.08	0.16	0.24	0.32	0.38	0.43	0.49
960	0.00	0.01	0.03	0.04	0.05	0.06	0.07	0.08	0.08	6200	0.00	0.08	0.17	0.25	0.33	0.40	0.44	0.50
1000	0.00	0.01	0.03	0.04	0.05	0.06	0.07	0.08	0.08	6400	0.00	0.09	0.17	0.26	0.35	0.41	0.45	0.52
1200	0.00	0.02	0.03	0.05	0.06	0.08	0.09	0.10	0.10	6600	0.00	0.09	0.18	0.27	0.36	0.42	0.47	0.53
1400	0.00	0.02	0.04	0.06	0.08	0.09	0.10	0.11	0.11	6800	0.00	0.09	0.18	0.28	0.37	0.44	0.48	0.55
1440	0.00	0.02	0.04	0.06	0.08	0.09	0.10	0.12	0.12	7000	0.00	0.09	0.19	0.28	0.38	0.45	0.50	0.57
1600	0.00	0.02	0.04	0.06	0.09	0.10	0.11	0.13	0.13	7200	0.00	0.10	0.19	0.29	0.39	0.46	0.51	0.58
1800	0.00	0.02	0.05	0.07	0.10	0.12	0.13	0.15	0.15	7400	0.00	0.10	0.20	0.30	0.40	0.47	0.52	0.60
2000	0.00	0.03	0.05	0.08	0.11	0.13	0.14	0.16	0.16	7600	0.00	0.10	0.21	0.31	0.41	0.49	0.54	0.62
2200	0.00	0.03	0.06	0.09	0.12	0.14	0.16	0.18	0.18	7800	0.00	0.11	0.21	0.32	0.42	0.50	0.55	0.63
2400	0.00	0.03	0.06	0.10	0.13	0.15	0.17	0.19	0.19	8000	0.00	0.11	0.22	0.32	0.43	0.51	0.57	0.65
2600	0.00	0.04	0.07	0.11	0.14	0.17	0.18	0.21	0.21	8200	0.00	0.11	0.22	0.33	0.44	0.53	0.58	0.66
2800	0.00	0.04	0.08	0.11	0.15	0.18	0.20	0.23	0.23	8400	0.00	0.11	0.23	0.34	0.45	0.54	0.60	0.68
2880	0.00	0.04	0.08	0.12	0.16	0.18	0.20	0.23	0.23	8600	0.00	0.12	0.23	0.35	0.46	0.55	0.61	0.70
3000	0.00	0.04	0.08	0.12	0.16	0.19	0.21	0.24	0.24	8800	0.00	0.12	0.24	0.36	0.48	0.56	0.62	0.71
3200	0.00	0.04	0.09	0.13	0.17	0.21	0.23	0.26	0.26	9000	0.00	0.12	0.24	0.36	0.49	0.58	0.64	0.73
3400	0.00	0.05	0.09	0.14	0.18	0.22	0.24	0.28	0.28	9200	0.00	0.12	0.25	0.37	0.50	0.59	0.65	0.75
3600	0.00	0.05	0.10	0.15	0.19	0.23	0.26	0.29	0.29	9400	0.00	0.13	0.25	0.38	0.51	0.60	0.67	0.76
3800	0.00	0.05	0.10	0.15	0.21	0.24	0.27	0.31	0.31	9600	0.00	0.13	0.26	0.39	0.52	0.62	0.68	0.78
4000	0.00	0.05	0.11	0.16	0.22	0.26	0.28	0.32	0.32	9800	0.00	0.13	0.26	0.40	0.53	0.63	0.69	0.79
4200	0.00	0.06	0.11	0.17	0.23	0.27	0.30	0.34	0.34	10000	0.00	0.14	0.27	0.41	0.54	0.64	0.71	0.81

TABLE 40 : SECTION PK: LENGTH CORRECTION FACTOR (Cl)

Effective Length	Correction Factor
Up to 1000	0.90
1000 - 1400	0.95
1400 - 2000	1.00
2000 - 2300	1.05
2300 - 2500	1.10
above 2500	1.15
1200 - 1500	1.05
1500 - 2000	1.10
2000 - 2500	1.15
above 2500	1.20

TABLE 41 : SECTION PK: ARC OF CONTACT CORRECTION FACTOR (Ca)

Arc of Contact on Small Pulley	Correction Factor
100	0.72
110	0.76
120	0.80
130	0.84
140	0.88
150	0.91
160	0.94
170	0.97
180	1.00
190	1.02
200	1.05
210	1.07
220	1.09
230	1.11

TABLE 42 : SECTION PL: BASIC POWER RATING PER RIB (kW) FOR SMALL PULLEY EFFECTIVE DIAMETER (mm)

de	75	80	85	90	95	100	106	112	118	125	132	140	150	160	170	180	190	200	212	224	236	250	280	315	355	400	450	500	560	630	800		
100	0.079	0.088	0.097	0.102	0.112	0.123	0.134	0.144	0.154	0.167	0.179	0.194	0.211	0.227	0.244	0.261	0.279	0.294	0.316	0.335	0.356	0.380	0.430	0.488	0.554	0.627	0.708	0.788	0.886	0.997	1.265		
200	0.149	0.169	0.184	0.200	0.218	0.233	0.256	0.275	0.297	0.320	0.342	0.370	0.403	0.435	0.470	0.502	0.535	0.568	0.602	0.642	0.684	0.729	0.825	0.937	1.061	1.205	1.361	1.516	1.695	1.911	2.420		
300	0.119	0.242	0.368	0.291	0.319	0.344	0.372	0.401	0.432	0.466	0.501	0.541	0.588	0.648	0.685	0.734	0.781	0.830	0.885	0.941	1.001	1.065	1.136	1.212	1.291	1.371	1.553	1.761	1.987	2.212	2.474	2.784	3.509
400	0.284	0.316	0.350	0.378	0.412	0.443	0.488	0.526	0.566	0.610	0.652	0.706	0.769	0.835	0.895	0.960	1.020	1.085	1.160	1.235	1.310	1.396	1.579	1.790	2.031	2.300	2.591	2.880	3.221	3.612	4.529		
500	0.349	0.386	0.427	0.471	0.510	0.550	0.600	0.646	0.692	0.750	0.803	0.870	0.944	1.025	1.111	1.203	1.311	1.259	1.336	1.421	1.519	1.611	1.716	1.941	2.201	2.496	2.821	3.176	3.525	3.936	4.402	5.475	
600	0.409	0.455	0.502	0.551	0.601	0.651	0.708	0.762	0.821	0.889	0.952	1.002	1.119	1.214	1.307	1.380	1.488	1.580	1.687	1.780	1.906	2.030	2.296	2.601	2.946	3.324	3.741	4.146	4.614	5.142	6.332		
700	0.472	0.525	0.578	0.638	0.692	0.746	0.813	0.881	0.946	1.020	1.100	1.184	1.291	1.400	1.507	1.610	1.715	1.820	1.945	2.071	2.196	2.337	2.641	2.990	3.384	3.814	4.281	4.734	5.252	5.836	7.094		
800	0.499	0.588	0.658	0.720	0.782	0.841	0.920	0.993	1.070	1.156	1.241	1.340	1.460	1.581	1.703	1.820	1.937	2.058	2.200	2.340	2.479	2.638	2.981	3.370	3.810	4.286	4.800	5.291	5.851	6.469	7.744		
900	0.589	0.657	0.730	0.801	0.873	0.940	1.025	1.090	1.191	1.286	1.380	1.491	1.623	1.762	1.895	2.049	2.157	2.291	2.445	2.601	2.755	2.932	3.310	3.741	4.218	4.738	5.288	5.812	6.405	7.032	8.270		
1000	0.625	0.690	0.773	0.848	0.926	1.000	1.083	1.173	1.260	1.363	1.463	1.581	1.722	1.866	2.009	2.149	2.288	2.427	2.591	2.720	2.921	3.110	3.502	3.955	4.458	5.000	5.571	6.111	6.711	7.342	8.519		
1000	0.649	0.722	0.802	0.882	0.958	1.032	1.128	1.220	1.311	1.415	1.522	1.640	1.790	1.937	2.085	2.229	2.374	2.518	2.691	2.860	3.027	3.221	3.631	4.088	4.614	5.167	5.752	6.303	6.890	7.534	8.654		
2000	0.760	0.853	0.942	1.040	1.128	1.220	1.327	1.410	1.544	1.670	1.791	1.933	2.111	2.285	2.457	2.621	2.795	2.961	3.161	3.360	3.552	3.779	4.249	4.750	5.352	5.961	6.550	7.151	7.742	8.294			
1400	0.870	0.974	1.082	1.118	1.219	1.337	1.460	1.575	1.716	1.856	1.994	2.155	2.313	2.493	2.721	2.943	3.160	3.376	3.587	3.780	4.046	4.287	4.490	4.800	5.360	5.970	6.608	7.237	7.820	8.266	8.588		
1440	0.892	1.000	1.112	1.189	1.327	1.432	1.563	1.691	1.820	1.965	2.109	2.275	2.479	2.685	2.882	3.081	3.279	3.471	3.701	3.929	4.151	4.403	4.937	5.521	6.142	6.781	7.401	7.924	8.400	8.730			
1600	0.979	1.005	1.219	1.337	1.460	1.575	1.716	1.856	1.994	2.155	2.313	2.493	2.721	2.943	3.160	3.376	3.587	3.780	4.046	4.287	4.490	4.800	5.360	5.970	6.608	7.237	7.820	8.266	8.588				
1800	1.085	1.219	1.350	1.482	1.616	1.748	1.902	2.059	2.211	2.390	2.564	2.764	3.011	3.255	3.491	3.710	3.959	4.186	4.451	4.712	4.968	5.257	5.847	6.472	7.104	7.691	8.181	8.777					
2000	1.120	1.328	1.482	1.623	1.771	1.913	2.086	2.252	2.421	2.615	2.809	3.025	3.292	3.554	3.810	4.062	4.310	4.551	4.838	5.111	5.379	5.679	6.281	6.903	7.500	8.002	8.346						
2200	1.289	1.446	1.604	1.762	1.922	2.078	2.261	2.446	2.619	2.836	3.041	3.276	3.562	3.841	4.112	4.381	4.642	4.900	5.196	5.478	5.755	6.059	6.660	7.256	7.785	8.167							
2400	1.385	1.557	1.728	1.808	2.065	2.236	2.433	2.630	2.824	3.014	3.251	3.484	3.746	4.062	4.375	4.672	4.966	5.245	5.512	5.820	6.111	6.387	6.682	7.230	7.700	7.991							
2800	1.570	1.767	1.963	2.157	2.350	2.539	2.761	2.953	3.200	3.448	3.692	3.966	4.295	4.619	4.890	5.225	5.510	5.779	6.089	6.376	6.637	6.921	7.411	7.775									
3800	1.608	1.805	2.001	2.205	2.402	2.595	2.826	3.050	3.270	3.522	3.771	4.051	4.387	4.713	5.021	5.321	5.590	5.878	6.185	6.467	6.729	7.000	7.464	7.777									
3800	1.918	2.156	2.392	2.625	2.810	3.083	3.349	3.600	3.860	4.146	4.422	4.726	5.089	5.428	5.742	6.032	6.300	6.538	6.788	6.996	7.108	7.289	7.484										
4000	2.068	2.329	2.578	2.833	3.081	3.321	3.602	3.874	4.140	4.436	4.721	5.028	5.389	5.720	6.020	6.281	6.511	6.708	6.891	7.016	7.081												
4200	2.140	2.412	2.678	2.933	3.189	3.432	3.719	4.000	4.265	4.563	4.850	5.158	5.513	5.833	6.190	6.361	6.568	6.732	6.872	6.945													
4400	2.210	2.490	2.762	3.026	3.260	3.538	3.831	4.109	4.380	4.684	4.965	5.272	5.617	5.923	6.219	6.411	6.590	6.680	6.806														
4500	2.248	2.529	2.800	3.071	3.332	3.587	3.883	4.165	4.410	4.739	5.021	5.321	5.664	5.964	6.219	6.422	6.585	6.694	6.753														
4600	2.280	2.565	2.842	3.118	3.380	3.638	3.935	4.210	4.490	4.789	5.070	5.370	5.704	5.995	6.233	6.429	6.571	6.659															
4800	2.290	2.638	2.922	3.201	3.471	3.730	4.030	4.315	4.586	4.882	5.159	5.450	5.769	6.038	6.252	6.414	6.516																
5000	2.410	2.688	3.001	3.279	3.554	3.811	4.112	4.401	4.670	4.966	5.233	5.512	5.812	6.059	6.241	6.361	6.400																
5200	2.462	2.770	3.063	3.351	3.628	3.891	4.195	4.479	4.746	5.032	5.294	5.560	5.838	6.051	6.200	6.274																	
5400	2.515	2.828	3.127	3.420	3.696	3.962	4.264	4.546	4.810	5.090	5.341	5.588	5.841	6.019	6.122																		
5500	2.542	2.855	3.159	3.448	3.729	3.993	4.294	4.577	4.835	5.110	5.356	5.595	5.832	5.992	6.073																		
5600	2.568	2.901	3.187	3.479	3.760	4.022	4.325	4.602	4.860	5.130	5.368	5.590	5.817	5.959	6.016																		
5800	2.617	2.930	3.240	3.536	3.812	4.078	4.375	4.651	4.901	5.158	5.381	5.585	5.771	5.870																			
6000	2.658	2.982	3.288	3.582	3.862	4.126	4.420	4.686	4.925	5.169	5.374	5.554	5.702																				
6200	2.690	3.020	3.332	3.627	3.902	4.163	4.451	4.710	4.938	5.165	5.349	5.504	5.602																				
6400	2.735	3.058	3.371	3.663	3.941	4.196	4.474	4.721	4.937	5.148	5.290	5.430																					
6600	2.760	3.088	3.400	3.667	3.970	4.219	4.488	4.723	4.922	5.111	5.245	5.331																					
6800	2.788	3.120	3.430	3.721	3.988	4.228	4.490	4.711	4.894	5.061	5.163	5.214																					
7000	2.805	3.139	3.451	3.737	4.000	4.233	4.481	4.689	4.852	4.991	5.067																						
7200	2.825	3.162	3.467	3.748	4.002	4.229	4.461	4.650	4.796	4.905	4.942																						
7400	2.848	3.174	3.473	3.750	3.992	4.211	4.430	4.602	4.724	4.801																							
7600	2.858	3.180	3.480	3.742	3.981	4.186	4.388	4.540	4.634	4.678																							
7800	2.862	3.184	3.470	3.731	3.958	4.152	4.332	4.461	4.530																								
8000	2.860	3.177	3.461	3.714	3.929	4.102	4.266	4.369	4.409																								
8200	2.856	3.166	3.442	3.680	3.820	4.047	4.188	4.261																									
8400	2.846	3.151	3.421	3.647	3.834	3.982	4.095	4.140																									
8600	2.832	3.129	3.387	3.600	3.775	3.901	3.990																										
8800	2.809	3.100	3.349	3.551	3.705	3.811	3.871																										
9000	2.786	3.065	3.301	3.488	3.624	3.710	3.738																										
9200	2.755	3.028	3.245	3.418	3.537	3.580																											
9400	2.720	2.981	3.188	3.338	3.432	3.471																											
9600	2.680	2.927	3.117	3.250	3.324																												
9800	2.532	2.867	3.039	3.151	3.201																												
10000	2.588	2.804	2.959	3.048	3.072																												

SPEED OF THE SMALL PULLEY RPM

TABLE 43 : SECTION PL: SPEED RATIO CORRECTION FACTOR (Cr)

Speed of small pulley in RPM	Speed Ratio	1.00 to 1.02	1.03 to 1.06	1.07 to 1.08	1.09 to 1.16	1.17 to 1.26	1.27 to 1.40	1.41 to 1.74	above 1.75	Speed Ratio	1.00 to 1.02	1.03 to 1.06	1.07 to 1.08	1.09 to 1.16	1.17 to 1.26	1.27 to 1.40	1.41 to 1.74	above 1.75
	100	0.000	0.000	0.000	0.000	0.010	0.010	0.010	0.010	0.010	4400	0.000	0.060	0.120	0.180	0.240	0.300	0.360
200	0.000	0.000	0.010	0.010	0.010	0.010	0.020	0.020	0.020	4500	0.000	0.060	0.120	0.180	0.240	0.300	0.360	0.430
300	0.000	0.000	0.010	0.010	0.020	0.020	0.020	0.030	0.030	4600	0.000	0.060	0.120	0.190	0.250	0.310	0.370	0.430
400	0.000	0.010	0.010	0.020	0.020	0.030	0.030	0.040	0.040	4800	0.000	0.060	0.130	0.190	0.260	0.320	0.390	0.450
500	0.000	0.010	0.010	0.020	0.030	0.030	0.040	0.050	0.050	5000	0.000	0.070	0.140	0.200	0.270	0.340	0.410	0.470
560	0.000	0.010	0.020	0.020	0.030	0.040	0.050	0.050	0.050	5200	0.000	0.070	0.140	0.210	0.280	0.350	0.420	0.490
600	0.000	0.010	0.020	0.020	0.030	0.040	0.050	0.060	0.060	5400	0.000	0.070	0.150	0.220	0.290	0.360	0.440	0.510
700	0.000	0.010	0.020	0.030	0.040	0.050	0.060	0.070	0.070	5500	0.000	0.070	0.150	0.220	0.300	0.370	0.450	0.520
720	0.000	0.010	0.020	0.030	0.040	0.050	0.060	0.070	0.070	5600	0.000	0.080	0.150	0.230	0.300	0.380	0.450	0.530
800	0.000	0.010	0.020	0.030	0.040	0.050	0.060	0.080	0.080	5800	0.000	0.080	0.160	0.230	0.310	0.390	0.470	0.550
900	0.000	0.010	0.020	0.040	0.050	0.060	0.070	0.090	0.090	6000	0.000	0.080	0.160	0.240	0.320	0.410	0.490	0.570
960	0.000	0.010	0.030	0.040	0.050	0.060	0.080	0.090	0.090	6200	0.000	0.080	0.170	0.250	0.330	0.420	0.500	0.590
1000	0.000	0.010	0.030	0.040	0.050	0.070	0.080	0.090	0.090	6400	0.000	0.090	0.170	0.260	0.350	0.430	0.520	0.600
1200	0.000	0.020	0.030	0.050	0.060	0.080	0.100	0.110	0.110	6600	0.000	0.090	0.180	0.270	0.360	0.450	0.530	0.620
1400	0.000	0.020	0.040	0.060	0.080	0.090	0.110	0.130	0.130	6800	0.000	0.090	0.180	0.280	0.370	0.460	0.550	0.640
1440	0.000	0.020	0.040	0.060	0.080	0.100	0.120	0.140	0.140	7000	0.000	0.090	0.190	0.280	0.380	0.470	0.570	0.660
1600	0.000	0.020	0.040	0.060	0.090	0.110	0.130	0.150	0.150	7200	0.000	0.100	0.190	0.290	0.390	0.490	0.580	0.680
1800	0.000	0.020	0.050	0.070	0.100	0.120	0.150	0.170	0.170	7400	0.000	0.100	0.200	0.300	0.400	0.500	0.600	0.700
2000	0.000	0.030	0.050	0.080	0.110	0.140	0.160	0.190	0.190	7600	0.000	0.100	0.210	0.310	0.410	0.510	0.620	0.720
2200	0.000	0.030	0.060	0.090	0.120	0.150	0.180	0.210	0.210	7800	0.000	0.110	0.210	0.320	0.420	0.530	0.630	0.740
2400	0.000	0.030	0.060	0.100	0.130	0.160	0.190	0.230	0.230	8000	0.000	0.110	0.220	0.320	0.430	0.540	0.650	0.760
2600	0.000	0.040	0.070	0.110	0.140	0.180	0.210	0.250	0.250	8200	0.000	0.110	0.220	0.330	0.440	0.550	0.660	0.770
2800	0.000	0.040	0.080	0.110	0.150	0.190	0.230	0.260	0.260	8400	0.000	0.110	0.230	0.340	0.450	0.570	0.680	0.790
2880	0.000	0.040	0.080	0.120	0.160	0.190	0.230	0.270	0.270	8600	0.000	0.120	0.230	0.350	0.460	0.580	0.700	0.810
3000	0.000	0.040	0.080	0.120	0.160	0.200	0.240	0.280	0.280	8800	0.000	0.120	0.240	0.360	0.480	0.590	0.710	0.830
3200	0.000	0.040	0.090	0.130	0.170	0.220	0.260	0.300	0.300	9000	0.000	0.120	0.240	0.360	0.490	0.610	0.730	0.850
3400	0.000	0.050	0.090	0.140	0.180	0.230	0.280	0.320	0.320	9200	0.000	0.120	0.250	0.370	0.500	0.620	0.750	0.870
3600	0.000	0.050	0.100	0.150	0.190	0.240	0.290	0.340	0.340	9400	0.000	0.130	0.250	0.380	0.510	0.630	0.760	0.890
3800	0.000	0.050	0.100	0.150	0.210	0.260	0.310	0.360	0.360	9600	0.000	0.130	0.260	0.390	0.520	0.650	0.780	0.910
4000	0.000	0.050	0.110	0.160	0.220	0.270	0.320	0.380	0.380	9800	0.000	0.130	0.260	0.400	0.530	0.660	0.790	0.930
4200	0.000	0.060	0.110	0.170	0.230	0.280	0.340	0.400	0.400	10000	0.000	0.140	0.270	0.410	0.540	0.680	0.810	0.950

TABLE 44 : SECTION PL: LENGTH CORRECTION FACTOR (Cl)

Effective Length	Correction Factor
Up to 1300	0.90
1300 - 1750	0.95
1750 - 2500	1.00
2500 - 3750	1.05
3750 - 4500	1.10
4500 - 5250	1.15
above 5250	1.20

TABLE 45 : SECTION PL: ARC OF CONTACT CORRECTION FACTOR (Ca)

Arc of Contact on Small Pulley	Correction Factor
100	0.72
110	0.76
120	0.80
130	0.84
140	0.88
150	0.91
160	0.94
170	0.97
180	1.00
190	1.02
200	1.05
210	1.07
220	1.09
230	1.11

TABLE 46 : SECTION PM: BASIC POWER RATING PER RIB (kW) FOR SMALL PULLEY EFFECTIVE DIAMETER (mm)

de	180	190	200	212	224	250	280	315	355	400	450	500	560	630	700
100	0.631	0.687	0.741	0.807	0.871	1.012	1.174	1.354	1.568	1.810	2.071	2.330	2.641	3.000	3.353
200	1.187	1.293	1.397	1.524	1.648	1.920	2.228	2.574	2.981	3.445	3.945	4.441	5.032	5.711	6.381
300	1.712	1.867	2.021	2.204	2.384	2.781	3.232	3.740	4.332	5.004	5.730	6.443	7.291	8.267	9.225
400	2.217	2.417	2.620	2.860	3.099	3.614	4.200	4.861	5.631	6.500	7.435	8.352	9.440	10.677	11.878
500	2.705	2.953	3.198	3.495	3.784	4.418	5.136	5.944	6.880	7.940	9.064	10.172	11.466	12.930	14.340
560	2.990	3.265	3.536	3.865	4.190	4.890	5.685	6.574	7.610	8.774	10.010	11.212	12.621	14.195	15.702
600	3.177	3.471	3.760	4.110	4.455	5.200	6.044	6.991	8.086	9.312	10.620	11.890	13.363	15.006	16.565
700	3.637	3.973	4.308	4.708	5.104	5.955	6.924	8.001	9.242	10.630	12.091	13.501	15.114	16.885	18.530
720	3.727	4.072	4.414	4.826	5.231	6.104	7.096	8.200	9.466	10.885	12.375	13.808	15.444	17.236	18.884
800	4.084	4.464	4.840	5.290	5.735	6.690	7.772	8.971	10.349	11.878	13.472	14.992	16.705	18.549	20.202
900	4.519	4.937	5.354	5.855	6.344	7.400	8.590	9.905	11.400	13.052	14.753	16.352	18.126	19.969	21.547
960	4.774	5.216	5.660	6.185	6.705	7.815	9.068	10.441	12.005	13.720	15.473	17.105	18.882	20.693	22.182
1000	4.940	5.400	5.857	6.402	6.941	8.084	9.377	10.795	12.396	14.150	15.932	17.572	19.350	21.120	22.531
1200	5.748	6.284	6.811	7.443	8.061	9.381	10.847	12.440	14.208	16.090	17.933	19.548	21.154	22.519	
1400	6.504	7.108	7.704	8.411	9.101	10.561	12.171	13.885	15.744	17.645	19.405	20.810			
1440	6.648	7.264	7.874	8.595	9.302	10.782	12.414	14.148	16.015	17.905	19.632	20.966			
1600	7.207	7.871	8.527	9.299	10.052	11.625	13.330	15.109	16.971	18.771	20.276				
1800	7.850	8.571	9.274	10.100	10.900	12.554	14.310	16.087	17.855	19.411					
2000	8.435	9.198	9.940	10.808	11.641	13.338	15.094	16.792	18.356						
2200	8.954	9.750	10.521	11.415	12.264	13.966	15.660	17.201							
2400	9.401	10.221	11.011	11.912	12.762	14.421	15.995	17.283							
2600	9.776	10.609	11.401	12.292	13.128	14.696	16.075								
2800	10.071	10.903	11.687	12.555	13.345	14.772									
2880	10.165	10.990	11.769	12.622	13.391	14.742									
3000	10.281	11.101	11.855	12.682	13.412	14.641									
3200	10.402	11.194	11.911	12.671	13.314										
3400	10.433	11.180	11.840	12.511	13.044										
3600	10.363	11.050	11.635	12.192											
3800	10.188	10.798	11.290												
4000	9.905	10.422													

TABLE 47 : SECTION PM: SPEED RATIO CORRECTION FACTOR (Cr)

Speed Ratio	1.00 to 1.01	1.02 to 1.04	1.05 to 1.06	1.07 to 1.14	1.15 to 1.24	1.25 to 1.48	1.49 to 2.00	above 2.01
100	0.00	0.01	0.01	0.02	0.03	0.05	0.06	0.07
200	0.00	0.01	0.02	0.04	0.07	0.09	0.11	0.14
300	0.01	0.02	0.03	0.06	0.10	0.14	0.17	0.20
400	0.01	0.02	0.04	0.08	0.14	0.19	0.23	0.27
500	0.01	0.03	0.05	0.10	0.17	0.24	0.29	0.34
560	0.01	0.03	0.06	0.11	0.19	0.26	0.32	0.38
600	0.01	0.03	0.06	0.12	0.20	0.28	0.34	0.41
700	0.01	0.04	0.08	0.14	0.24	0.33	0.40	0.47
720	0.01	0.04	0.08	0.15	0.24	0.34	0.41	0.49
800	0.02	0.04	0.09	0.16	0.27	0.38	0.46	0.54
900	0.02	0.05	0.10	0.18	0.30	0.43	0.52	0.61
960	0.02	0.05	0.10	0.19	0.32	0.45	0.55	0.65
1000	0.02	0.05	0.11	0.20	0.34	0.47	0.57	0.68
1200	0.02	0.06	0.13	0.24	0.41	0.57	0.69	0.81
1400	0.03	0.08	0.15	0.28	0.47	0.66	0.80	0.95
1440	0.03	0.08	0.16	0.29	0.49	0.68	0.83	0.97
1600	0.03	0.09	0.17	0.32	0.54	0.76	0.92	1.08
1800	0.04	0.10	0.19	0.36	0.61	0.85	1.03	1.22
2000	0.04	0.11	0.22	0.41	0.68	0.95	1.15	1.35
2200	0.04	0.12	0.24	0.45	0.74	1.04	1.26	1.49
2400	0.05	0.13	0.26	0.49	0.81	1.13	1.38	1.62
2600	0.05	0.14	0.28	0.53	0.88	1.23	1.49	1.76
2800	0.06	0.15	0.30	0.57	0.95	1.32	1.61	1.89
2880	0.06	0.16	0.31	0.58	0.97	1.36	1.65	1.94
3000	0.06	0.16	0.32	0.61	1.01	1.42	1.72	2.03
3200	0.06	0.17	0.35	0.65	1.08	1.51	1.84	2.16
3400	0.07	0.18	0.37	0.69	1.15	1.61	1.95	2.30
3600	0.07	0.19	0.39	0.73	1.22	1.70	2.07	2.43
3800	0.08	0.21	0.41	0.77	1.28	1.80	2.18	2.57
4000	0.08	0.22	0.43	0.81	1.35	1.89	2.30	2.70

TABLE 48 : SECTION PM: LENGTH CORRECTION FACTOR (CI)

Effective Length	Correction Factor
Up to 2750	0.95
2750 - 3750	1.00
3750 - 5000	1.05
5000 - 7000	1.10
7000 - 9000	1.15
above 9000	1.20

TABLE 49 : SECTION PM: ARC OF CONTACT CORRECTION FACTOR (Ca)

Arc of Contact on Small Pulley	Correction Factor
100	0.72
110	0.76
120	0.80
130	0.84
140	0.88
150	0.91
160	0.94
170	0.97
180	1.00
190	1.02
200	1.05
210	1.07
220	1.09
230	1.11

TROUBLE SHOOTING

PROBLEMS	CAUSES	REMEDIES
Ribbed belt breaking after a short period of running	<ul style="list-style-type: none"> a, Forcing the belt over pulley during installation. b, Overloaded drive c, Ingress of foreign body d, Drive stalled 	<ul style="list-style-type: none"> a, Use proper installation techniques b, Re-check the drive design c, Fit an effective guard d, Check for lubrication
Cuts and splits in the rib	<ul style="list-style-type: none"> a, Pulley diameter too small b, Ambient temperature too high c, Abnormal belt slip d, Contamination by chemicals 	<ul style="list-style-type: none"> a, Re-design using the min. recommended diameter. b, Ensure good ventilation c, Check drive tension d, Protect the drive
Severe belt vibrations	<ul style="list-style-type: none"> a, Overloaded drive b, Centre distance more than recommended c, High shock loading d, Too low belt tension e, Unbalanced pulleys 	<ul style="list-style-type: none"> a, Redesigning drive may be necessary b, Use an inside idler on the slack side c, Re-tension the drive d, Balance the pulleys
Cannot be re-tensioned	<ul style="list-style-type: none"> a, Insufficient allowance for re-tensioning b, Excessive stretch caused by overloaded drive c, Incorrect belt length 	<ul style="list-style-type: none"> a, Modify the drive b, Re-design the drive c, Use belt of proper length
Excessive wear of ribs	<ul style="list-style-type: none"> a, Starting torque too high b, Incorrect pulleys c, Excessive wear of grooves d, Poor drive alignment e, Smaller than recommended minimum pulley diameter f, Belt catching on protruding parts g, Wrong section of belt for pulleys h, Too low belt tension 	<ul style="list-style-type: none"> a, Re-design the drive b, Re-machine the pulleys c, Re-machine pulleys d, Re-align the pulleys e, Re-design using correct pulley diameters f, Remove protrusions g, Correct the belt section h, Re-tension the drive
Excessive Noise	<ul style="list-style-type: none"> a, Contamination by oil, grease or chemicals 	<ul style="list-style-type: none"> a, Protect the drive