

Precisa Balances Series 490 IB/IT/IS

Operating Instructions

Precisa

■ The Balance of Quality ■

350-8114-000a3

Identification

Customer service

Precisa Gravimetrics AG
Moosmattstrasse 32
CH-8953 Dietikon
Tel. +41-44-744 28 28
Fax. +41-44-744 28 38
email service@precisa.ch

<http://www.precisa.com>

Refer to our website for information about local customer service centers and details of their addresses.

Copyright

These operating instructions are protected by copyright. All rights reserved. No part of the operating instructions may be reproduced, processed, duplicated or published in any form by photocopying, microfilming, reprinting or other process, in particular electronic means, without the written agreement of Precisa Gravimetrics AG.

© Precisa Gravimetrics AG, 8953 Dietikon, Switzerland, 2006.

1 Overview

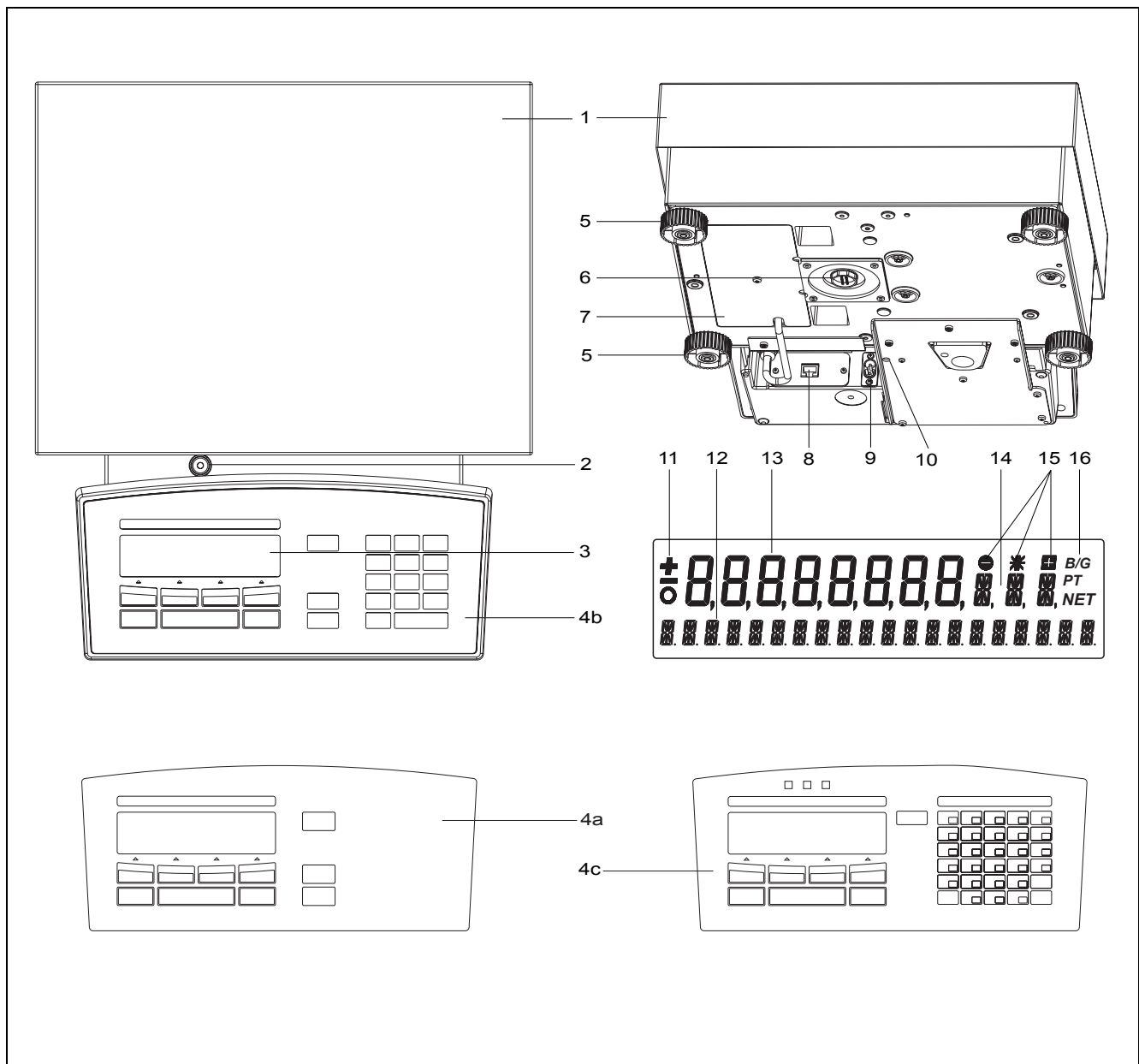

No.	Description	Section / Page	No.	Description	Section / Page
1	Weighing pan	2 / 3	8	Serial interface, RJ45 socket	13.1 / 34
2	Levelling bubble	7.6 / 11	9	Power connection socket	7.5
3	Display		10	Mechanical anti-theft protection	
4a	Control panel IB	8.1 / 13	11	Prefix display	7.9 / 12
4b	Control panel IT for: - text entry - manual tara input - reference input with preceding « * »	see also 9.2 / 23 9.3 / 24	12	Info display	
4c	Control panel IS for: - text entry - working with the „Smart Application“ see in separate manual		13	Measurement display	
5	Adjustable feet	7.6 / 11	14	Unit display	8.3.3 / 15
6	Locking pin, below balance weighing	3 / 4	15	Weight check	11 / 31
7	Cable storage 1.5m		16	Symbol display	

2 Inspection and assembly

Inspect delivery for complete supply immediately on unpacking all components.

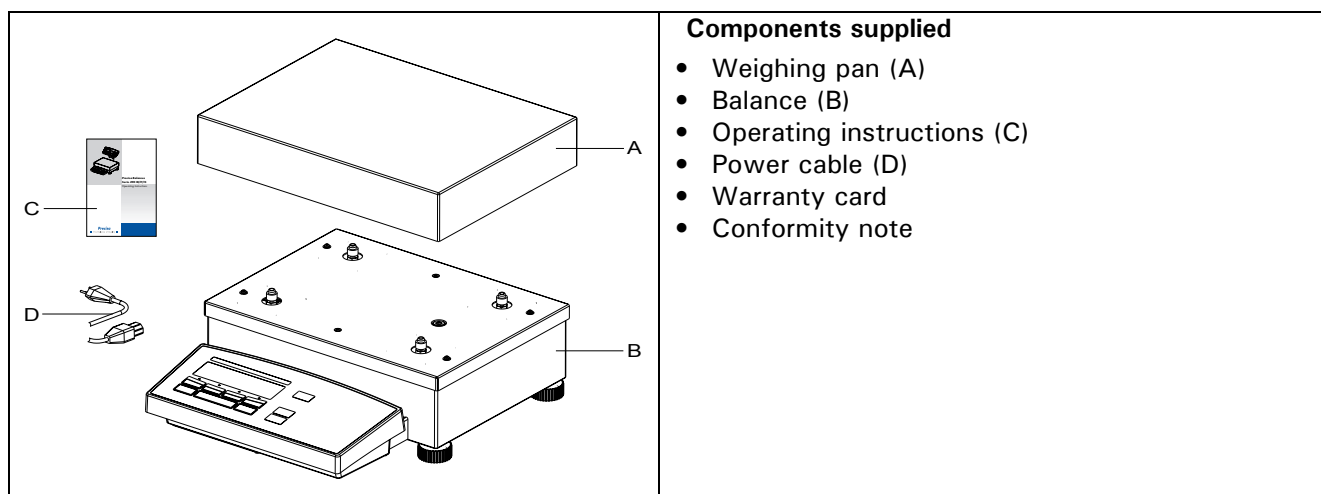

The balance is delivered in partly dismantled condition. Assemble the individual components in the following sequence:

- Place the weighing pan (A) in position
- Insert the power cable (D) into the socket at the rear of the balance(9).

! NOTE

A screwdriver is required for assembly.

All parts must fit together easily. Do not apply force. Precisa Customer Service will be pleased to help you with any problems.

■ 3 *Below-balance weighing*

3 Below-balance weighing

Objects which, because of their size or shape, cannot be put on the scale, can be weighed by means of below-balance weighing.

The necessary parts are available as accessories (see chapter 4 "Accessories").

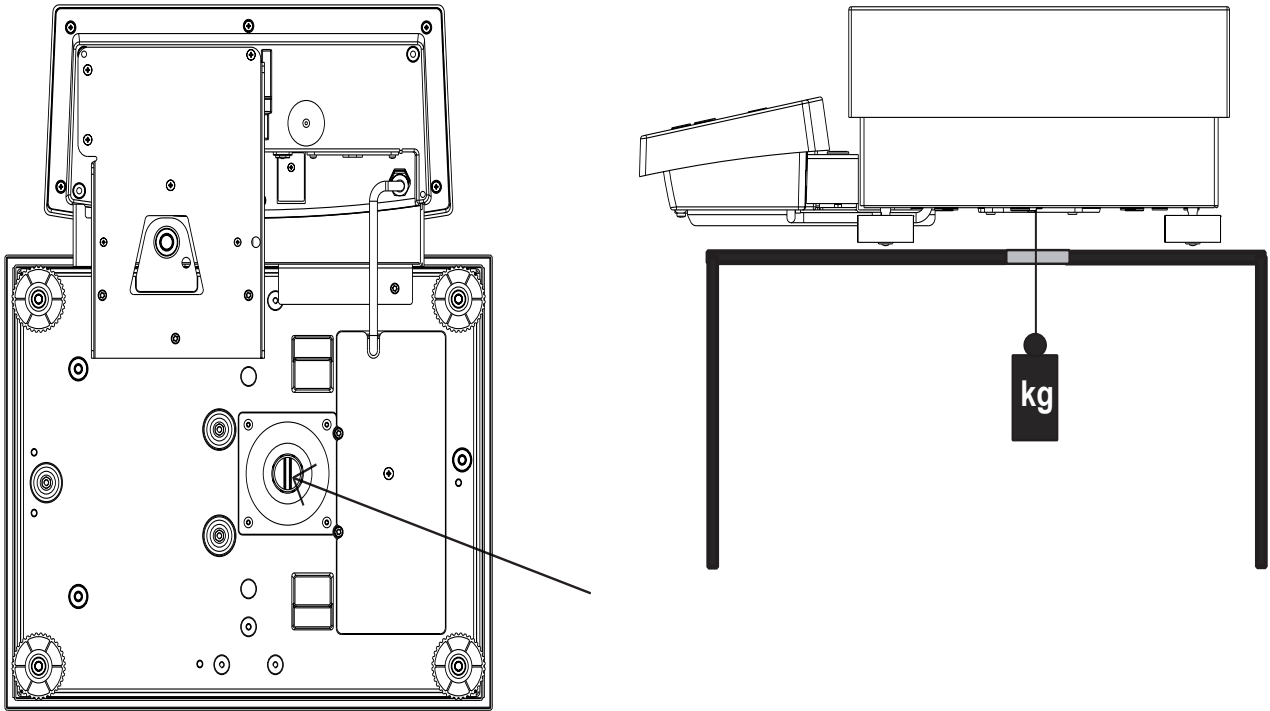

4 Accessories

Accessorie	Article number
Post for rear mounted display series 490	350-8655
Device for wall-mounted terminal (Cable in terminal 1.5m)	350-8654
Cable to terminal, 3m	350-8623
Cable to terminal, 5m	350-8624
Second display, free-standing, Cable 1.5m	350-8504
Second display, wall-mounted, Cable 3m	350-8516
CCE-Bar code scanner to be connected to the smartbox	350-8531
CCE-Bar code scanner to be connected to Interface-Box RS232 (350-8506)	350-8856
Interface RS232	350-8506
Interface 20 mA current loop passiv	350-8526
Ethernet Interface	350-8573
Analog output -10 V... + 10 V (Resolution 10 mV)	350-8508
Input/Output module (6 TTL inputs, 8 Relay outputs)	350-8509
Signal-lamp with 3 bulbs (green, yellow, red)	350-8510
Horn for signal lamp	350-8533
Multiplexer for up to 7 balances (RS232)	350-8513
Datacable RJ45 - RJ45, 0.75 m	350-8525
Datacable RJ45 - RJ45, 1.5 m	350-8520
Datacable RJ45 - RJ45, 3 m	350-8521
Datacable RJ45 - DB9 female (PC), 1.5m	350-8557
Datacable RJ45 - DB25 female (PC), 1.5m	350-8558
Datacable RJ45 - DB25 male (Printer), 1.5m	350-8559
Cable for reference balance	350-8534
Below the balance weighing feature	350-8630
Below the balance weighing feature, IP65	350-8635
Dust cover for display	490-4002
Uninterruptable Power Supply (UPS)	350-8576
Anti-theft device	350-8555
Set for OIML/CE approval series 490	350-8577
Set for OIML/CE approval series 460	350-8578

■ Contents

	Identification	1	8.5.1	Activating the application menu	21
1	Overview	2	8.5.2	Selecting an application program	21
2	Inspection and assembly	3	9	Application	23
3	Below-balance weighing	4	9.1	Units	23
4	Accessories	5	9.2	Count	23
	5	9.3	Percent	24
5	Introduction	8	9.4	Calculator	25
5.1	Useful tips on the Operating Instructions	8	9.5	Paper	26
5.2	Warranty card	8	9.6	Net-Total	26
5.3	Conformity	8	9.7	Sum	27
6	Safety	9	9.8	Animal	28
6.1	Representations and symbols	9	10	Statistics	29
6.2	Safety recommendations	9	11	Check-Weighing	31
7	Set up	10	12	User profiles (MUM, Multiuser Memory)	32
7.1	Unpacking the balance	10	12.1	Activating a user	32
7.2	Transport and shipping	10	12.2	Creating a new user profile	32
7.3	Storage	10	12.3	Changing the password and password protection	33
7.4	Choosing a suitable location	11	12.4	Clearing a user	33
7.5	Connecting the balance to the mains ..	11	12.5	Setting the user	33
7.6	Levelling	11	13	Data transfer	34
7.7	Calibration of the balance	11	13.1	Connection scheme	34
7.8	Dual Range and Floating Range balances	12	13.2	Remote control-commands	35
7.9	Standardized balance	12	13.2.1	Examples for the remote control	36
7.10	Switching on the balance	12	14	Service	37
7.11	Auto-Standby Mode	12	14.1	Maintenance and servicing	37
8	Operation	13	14.2	Error messages	37
8.1	Menu control operation principle	13	14.2.1	Notes on correcting faults	37
8.1.1	Operating in the Weighing mode	13	14.3	Calibration	38
8.1.2	Operation in the programming mode ..	14	14.3.1	External calibration by means of ICM ..	38
8.2	Setting the factory configuration	14	14.3.2	External calibration with freely selectable weight	39
8.3	Device configuration	14	14.3.3	Internal calibration	39
8.3.1	Activating the configuration menu	15	14.3.4	Automatic calibration	39
8.3.2	Language function	15	14.4	Automatic Repeatability Test (ART) ...	40
8.3.3	Selecting the weight unit	15	14.5	Software update	40
8.3.4	Print functions	16	15	Menu trees	42
8.3.5	Calibration functions	17	15.1	Configuration menu tree	42
8.3.6	Weighing mode	17	15.2	Application menu tree	44
8.3.7	Interface functions	18			
8.3.8	Date and time	18			
8.3.9	Anti-theft encoding	19			
8.3.10	Key tone	20			
8.3.11	Contrast	20			
8.4	Special operating keys	20			
8.4.1	The tare key	20			
8.4.2	The print key	20			
8.4.3	The change key	21			
8.5	Application menu	21			

5 Introduction

These balances are simple and functional to operate.

The versatile weighing programs allow you to use these balances not only for simple weighing procedures but also in a simple manner for carrying out various weighing applications such as, for example, percentage- or component counting weighings and document the measurements obtained accurately and unequivocally. Virtually all models can be delivered in weights and measures approved.

The most important basic production features of the Precisa balances include:



- Simple-to-use 10-key multifunction control panel
- LCD- or fluorescent display with multi-line display
- Anti-theft encoding with four-figure numerical code
- 10 user profiles (MUM Multiuser Memory)
- ICM-Autocalibration (intelligent calibration mode)
- RS232/V24 serial interface for data transfer
- ISO- and GLP-compliant reporting of results of measurements
- Capacity and residual tare display
- Storable user-configuration (UMM User Menu Memorized)
- Various application programs:
Piece counting, Percentage weighing, Formulation, Animal weighing, Calculator, Check and reference weighing
- Statistics program
- Appliance for below-balance weighing

5.1 Useful tips on the Operating Instructions

You should read through these operating instructions in their entirety, so that you can make optimum use of the full potential and the diverse features of the balance in your daily work.

These operating instructions contain guidance in the form of pictograms and keyboard diagrams, which should help you find the required information:

- Key names are presented in quotation marks and are highlighted in semi-bold script: «**ON/OFF**» or «**↻**».
- When explaining the operating steps, the appropriate display for the current operating step is shown for clarity at the left alongside the list of operating steps:

Display	Key	Step
		<i>Press repeatedly, until the language currently activated is displayed.</i>

5.2 Warranty card

A warranty card, which was filled in by your dealer before handing over the balance, is enclosed with the instruction manual.

!	NOTE
Check that the warranty card is enclosed with these operating instructions and is completely filled out.	

5.3 Conformity



The balance has been manufactured and tested in accordance with the standards and recommendations set out in the enclosed certificate of conformity.

The power adaptor produced for the operation of the balance and intended exclusively for this application, complies with Electrical Protection Class II.

6 Safety

6.1 Representations and symbols

Important safety instructions are highlighted with the appropriate symbol:

 DANGER
Warning of a possible danger which can lead to death or to serious injuries.
 CAUTION
Warning of a possibly dangerous situation which can lead to less severe injuries or damage.
 NOTE
Tips and important rules on the correct operation of the balance.

6.2 Safety recommendations

- When using the balance in surroundings with increased safety requirements the corresponding regulations must be observed.
- The balance may only be used with the power adaptor supplied exclusively for use with this balance.
- Before plugging in the power adaptor, make sure that the operating voltage stated on the power adaptor agrees with the mains voltage. If not, please refer to the Customer Service.
- If the power adaptor or its cable is damaged, the balance must immediately be disconnected from the electricity supply (pull out the power adaptor). The balance may only be operated with a power adaptor in perfect condition.
- If there is any reason to believe that it is no longer possible to operate the balance without danger, the balance must immediately be unplugged from the electricity supply (pull out power adaptor) and secured against inadvertent operation.
- In carrying out maintenance work, it is essential to heed the recommendations in chapter 14.1 "Maintenance and servicing".
- The balance must not be operated in an area subject to explosion risks.
- Take care when weighing liquids that no liquid is spilt into the inside of the balance or into connections on the rear of the equipment or the power adaptor.
If liquid is spilt on the balance, the latter must immediately be unplugged from the mains electricity supply (pull out power adaptor).
The balance may only be operated after it has first been re-checked by a Service technician.
- The operating instructions must be read by each operator of the balance and must be available at the workplace at all times. The balance may only be used for the weighing of solid-materials and of liquids filled into secure containers and for animal weighing and density determinations. The maximum allowable load of the balance must never be exceeded, otherwise the balance may be damaged.
- When using the balance in combination with other appliances, the current regulations for the safe use of the relevant attachments and their application in accordance with instructions must always be observed.

7 Set up

7.1 Unpacking the balance

The balances are delivered in an environmentally-friendly package, specifically developed for this precision instrument, which provides optimum protection for the balance during transportation.

NOTE

Retain the original packaging in order to avoid transportation damages when shipping or transporting the balance and to allow the balance to be stored in the best conditions if it is out of operation for an extended period.

In order to avoid damage, attention must be given to the following points when unpacking the balance:

- Unpack the balance carefully. It is a precision instrument.
- When outside temperatures are very low, the balance should first be stored for some hours in the unopened transport package in a dry room at normal temperature, so that no condensation settles on the balance when unpacking.
- Check the balance immediately after unpacking for externally visible damage. If you should find transport damage, please inform your Services representative immediately.
- If the balance is not to be used immediately after purchase but only at a later time, it should be stored in a dry place where fluctuations in temperature are as low as possible (see chapter 7.3 "Storage").
- Read through these operating instructions, even if you already have experience with balances, before you work with the balance and pay attention to the safety recommendations (see chapter 6 "Safety").

7.2 Transport and shipping

Your balance is a precision instrument. Treat it with care.

Avoid shaking, severe impacts and vibration during the transportation.

Take care that there are no significant temperature fluctuations during the transportation and that the balance does not become damp (condensation).

NOTE

The balance should preferably be dispatched and transported in the original packaging to avoid transportation damage.

7.3 Storage

If you would like to take the balance out of service for an extended period, disconnect it from the electricity supply, clean it thoroughly (see chapter 14.1 "Maintenance and servicing") and store it in a place which meets the following conditions:

- No violent shaking, no vibrations
- No significant temperature fluctuations
- No direct solar radiation
- No moisture

NOTE

The balance should preferably be stored in the original packaging, since this provides optimum protection for the balance.

7.4 Choosing a suitable location

The balance location must be chosen in such a way as to guarantee perfect operation of your balance, so that the allowable ambient conditions and prerequisites are met and maintained:

- Put the balance on a solid, firm and preferably vibration-proof, horizontal base
- Make sure that the balance cannot be shaken or knocked over
- Protect from direct solar radiation
- Avoid drafts and excessive temperature fluctuations

! NOTE

With difficult conditions (where the balance may be easily shaken or subject to vibration) the balance can nevertheless provide accurate results through suitable adjustment of the stability control (see chapter 8.3.6 "Weighing mode").

7.5 Connecting the balance to the mains

The following safety recommendations must be observed when connecting the balance to the mains:

! DANGER

The balance may only be operated with the power adaptor supplied.

Check before connecting the power adaptor to the mains supply that the operating voltage stated on the on the balance or on the power adaptor agrees with the local mains voltage.

If the operating voltage is not the same as the mains voltage, the balance or the power adaptor must on no account be connected to the mains supply. Contact the Customer Service.

7.6 Levelling

To function properly, the balance must be precisely horizontal.

The balance is fitted with one spirit level and two adjustable feet for level-control, with the aid of which it is possible to compensate for small height differences and/or unevennesses in the surface on which the balance is standing.

The two screw feet must be adjusted so that the air bubble is precisely in the centre of the sight glass of the bubble level.

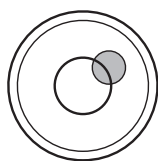

Incorrect

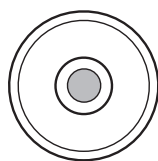

Correct

! NOTE

In order to get exact measurements, the balance must again be carefully levelled after each relocation.

7.7 Calibration of the balance

Since the Earth's gravity is not the same everywhere, each balance must – in accordance with the underlying physical weighing principle – be adjusted to compensate for the gravity at each location. This adjustment process, known as "calibration", must be carried out on initial installation and after each subsequent relocation. In order to get exact measurements, it is recommended moreover, that the balance should also be calibrated periodically.

! NOTE

■ 7 Set up

The balance must be calibrated on initial installation and after every relocation.

If you work in accordance with "Good Laboratory Practice GLP" observe the prescribed intervals between calibrations (adjustments).

Calibration is effected in the configuration menu. Depending on the balance model, this may be done externally, internally or automatically (see chapter 8.3.5 "Calibration functions" and see chapter 14.3 "Calibration").

With the aid of the "Intelligent Calibration Mode" the balance can itself determine the size of the calibration weight, which enables an exact calibration with different size weights (in 10 g, 50 g, 100 g and 500 g steps, depending on implementation).

7.8 Dual Range and Floating Range balances

With the Dual Range balances, weighing is always first carried out in the fine range, which is 10 times more precise. When the fine range is exceeded the balance switches automatically into the coarse range.

The Floating Range balances have a fine range (10 times more precise), which moves over the entire weight range. By pressing the tare key «T» the fine range can be called up as often as required over the entire weight range.

7.9 Standardized balance

The standardized balances are provided with the EC/OIML certification or meet the local standardisation regulations.

The balance range and certain functions of the weighing output differ from the standard program in the case of the standardized balances – in accordance with the EC/OIML provisions.

NOTE

If a circle appears in the main-display of a standardized balance, the indicated value is unstandardised.

In balances of class (1) the circle also stands for the warm-up phase.

Your Customer Service will be happy to assist you at any time if you have any questions on the standardization of the balance or on working with standardized balances.

7.10 Switching on the balance

- Press «ON/OFF» to switch on the balance.

The balance carries out a diagnostic test in order to check the most important functions. After completion of the start-up process (approximately ten seconds) "Zero" appears in the display.

The balance is ready for operation and is in the Weighing mode.

7.11 Auto-Standby Mode

The balance is equipped with an Auto-Standby mode, which can be activated or deactivated in the configuration menu.

If the Auto-Standby mode is activated, the balance automatically switches to Standby some time after the last weighing or key operation (current-saving function).

The delay before switching to Standby is defined in the configuration menu (see chapter 8.3.6 "Weighing mode").

- Press any button or put on a weight in order to switch the balance from the Standby mode back to the Weighing mode again.

8 Operation

The balance has two main menus available: the configuration menu and the application menu.

The basic program of the balance is defined in the **configuration menu**. With this, you can either work with the basic configuration programmed ex-works, or define and store a user configuration adapted to your specific needs.

In the **application menu**, you may define an application program which is suited to the specific weighing problem.

In addition, you may also define the parameters for the statistics program, check-reference weighing and the user profile in the application menu.

8.1 Menu control operation principle

The configuration menu and the application menu each have several menu levels in which the parameters for the different function programs of the balance are defined.

You can move within the menu with the cursor keys «←», «→», «↑» and «↓».

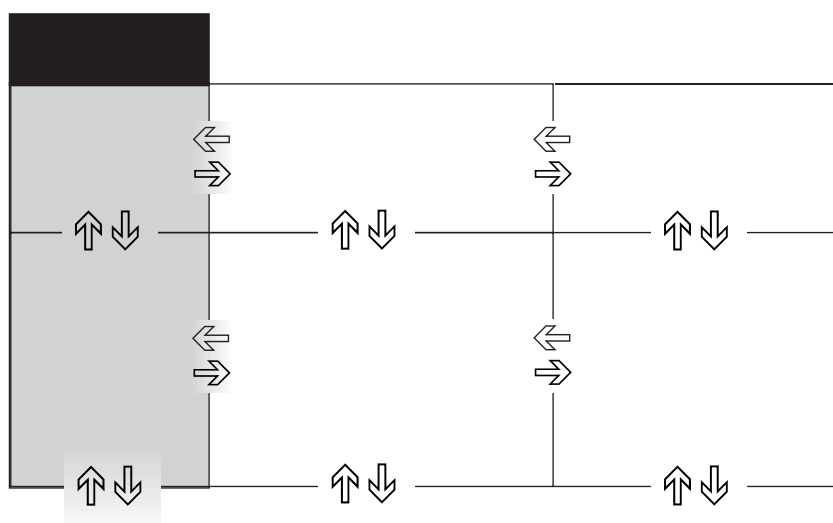

8.1.1 Operating in the Weighing mode

Keys type 1	Keys type 2	Designation	Function in Weighing mode
		«ON/OFF»	• Switching the balance on and off
		«MENU»	• Calling up the Configuration Menu and the Application Menu
		«T»	• Initiate Tare Function and/or Calibration Function
		«↻»	• Switches between the Basic program and the chosen application
		«PRINT»	• Start print function
		«←» «→»	• Function keys. Start the functions in the info-line.
		«↑» «↓»	
		«↔» «↕»	

















NOTE

For the operation of the «T», «↻» and «PRINT» see chapter 8.4 "Special operating keys".

■ 8 Operation

8.1.2 Operation in the programming mode

Keys type 1	Keys type 2	Designation	Function in programming mode
		«←», «→»	<ul style="list-style-type: none"> Changes within the menu level
		«↑», «↓»	<ul style="list-style-type: none"> Up/Down movements within the menu Changes selected parameters
		«← »	<ul style="list-style-type: none"> Selects parameters Stores the changed parameters
		« esc »	<ul style="list-style-type: none"> Interrupts an input Leaves the menu
		« ins »	<ul style="list-style-type: none"> Places insert marker (in text entry)
		« clr »	<ul style="list-style-type: none"> Deletes input (in text entry)
		« PRINT »	<ul style="list-style-type: none"> Inputs a point (in text entry)

The balance can also be operated by remote control. For the corresponding remote control-commands see chapter 13.2 "Remote control-commands".

8.2 Setting the factory configuration

- Press «**ON/OFF**» to switch the balance on.
- During the start-up process, hold down the «**T**» and «**MENU**» keys until „FACTORY CONFIG.“ appears in the display, then release the keys. The balance loads the factory configuration.

8.3 Device configuration

This section explains the structure of the configuration menu and its functions.

The basic adjustment of the balance is defined in the configuration:

Menu	Definable functions
UNIT-1	Unit in which the weighing results are displayed
SET DATA PRINT	Print formats; Type of values to be printed (individual values, continuous printout, time or load change dependent values, date, time, user, etc.)
SET CALIBRATION	Calibration method
SET WEIGHING MODE	Stability mode (Quality of the balance location), Auto-Standby mode, zero correction, tare method (rapid or standard tare)
SET INTERFACE	Baud rate, parity, handshake functions of the peripheral interface
SET DATE AND TIME	Date and time (standard format or American format p.m. and a.m.)
THEFTCODE	Activating/deactivating and changing the anti-theft code.
KEY TONE	Activation of the keypad sound
LANGUAGE	Display language (E, G, F)
CONTRAST	Screen contrast (only for balances with LCD display)

- The settings in the sub-paths pre-programmed at the factory are printed here in **bold**.
- For greater clarity, only that part of the menu tree which corresponds to the function is shown with each description of the function.
- You will find the entire menu tree for the configuration menu in see chapter 15.1 "Configuration menu tree".
- Explanations of the menu functions are printed in *italics*.

8.3.1 Activating the configuration menu

- Press «ON/OFF» to switch the balance on.
- Hold down the «MENU» key continuously during the start-up process (which takes about ten seconds) until „UNIT-1“ appears in the display.
- You can now change the configuration menu.

8.3.2 Language function

• LANGUAGE		
SPRACHE	DEUTSCH	<i>Selecting a language</i>
LANGUAGE	ENGLISH	
LANGUE	FRANCAISE	

Procedure for changing the language:

Display	Key	Step
<div style="border: 1px solid black; padding: 5px; text-align: center;"> ----- SPRACHE DEUTSCH </div>	«↓»	<i>Press repeatedly, until the language currently activated is displayed.</i>
<div style="border: 1px solid black; padding: 5px; text-align: center;"> ----- SPRACHE DEUTSCH </div>	«↵»	<i>The language now flashes.</i>
<div style="border: 1px solid black; padding: 5px; text-align: center;"> ----- LANGUAGE ENGLISH </div>	«↑»	<i>Press repeatedly until the language you require appears.</i>
<div style="border: 1px solid black; padding: 5px; text-align: center;"> ----- LANGUAGE ENGLISH </div>	«↵»	<i>To confirm the choice of language.</i>

Press «esc» to exit the menu.

8.3.3 Selecting the weight unit

• UNIT-1		
UNIT-1	g	<i>Gram</i>
	kg	<i>Kilogram</i>

	Bht	<i>Baht</i>

The balance can show results in different units, although with some balances display is not possible in milligram or kilogram because of the corresponding weight range.

Display	Weight unit	Conversion to gram
g	Gram	
(mg)	Milligram	0,001 g
(kg)	Kilogram	1000 g
GN	Grain	0,06479891 g
dwt	Pennyweight	1,555174 g
ozt	Troy ounce	31,10347 g
oz	Ounce	28,34952 g
Lb	Pound	453,59237 g
ct	Carat	0,2 g
C.M.	Carat Metric	0,2 g
tLH	Tael Hong Kong	37,4290 g
tLM	Tael Malaysia	37,799366256 g
tLT	Tael Taiwan	37,5 g
mo	Momme	3,75 g
t	Tola	11.6638038 g
Bht	Baht	15.2 g

■ 8 Operation

Procedure for changing the weight unit:

Display	Key	Step
UNIT-1 9	«↓»	Press repeatedly, until „UNIT-1“ is displayed.
UNIT-1 9	«↵»	The unit now flashes
UNIT-1 LB	«↓»	Press repeatedly, until the unit you require appears.
UNIT-1 LB	«↵»	To confirm the choice of unit.

Press «esc» to exit the menu.

8.3.4 Print functions

• SET DATA PRINT		
AUTOSTART	ON/OFF	Start print automatically on switching on/off
MODE	UNSTABLE STABLE LOADCHANGE CONTINUOUS TIMEBASE	Individual print, each value Individual print, stable value Print after load changes Continuous print after every integration time Continous print with time basis
TIMEBASE	2.0	Time basis (in seconds) freely selectable
SET PRINTFORMAT		DATE AND TIME ON/OFF BALANCE-ID ON/OFF PRODUCT-ID ON/OFF GROSS AND TARE ON/OFF UNITS ON/OFF USER ON/OFF LINEFEED OFF/1/2/..9/FROMFEED PRODUCT ttt... PRODUCTMODE HOLD DELETE COUNT

„SET PRINTFORMAT“

Elements which are switched on are printed in each case.

„UNITS“

All currently active units are printed out.

„PRODUCT ttt...“

The product name can be entered alpha-numerically.

„PRODUKTMODE“

- „HOLD“: The product name is stored.
- „DELETE“: The product name is deleted after each expression.
- „COUNT“: A counter, which is incremented by 1 after each expression is printed.

When a peripheral device (for example a printer) is connected, the balance interface must be configured in the sub-menu „SET INTERFACE“ (see chapter 8.3.7 "Interface functions").

8.3.5 Calibration functions

• SET CALIBRATION		
MODE	OFF EXTERNAL EXT.-DEF. INTERNAL AUTO	Closed External External with user-defined weight („DEF. n.nnn g“) with internal weight Automatic (AUTOCAL)
DEF.	0.000 g	Calibration weight for EXT.-DEF. mode
AUTOCAL.	TIME/TEMP. TEMPERATURE TIME	Auto-calibration on time and temperature Auto-calibration on temperature Auto-calibration on time
AUTOCAL.-TIME	6 h	Time for auto-calibration

For calibration of the balance see chapter 7.7 "Calibration of the balance" and see chapter 14.3 "Calibration". The setting depends on the balance model.

8.3.6 Weighing mode

• SET WEIGHING MODE		
FLOATINGDISPLAY	0.08 0.16 0.32	Input integration time (in seconds)
STABILITY	LOW MEDIUM HIGH	Setting the stability control (instability of the balance location)
AUTO-STANDBY	OFF 0.5 MIN. 1 MIN. 5 MIN. 10 MIN.	Auto-Standby not active or active after nn minutes
AUTO-ZERO	ON/OFF	Automatic zero correction on/off
QUICK-TARE	ON/OFF	Quick-Tare on/off

With the aid of the Weighing mode functions, you may define the quality of the balance location (see chapter 7.4 "Choosing a suitable location").

With the aid of the „AUTO-STANDBY“ function, you can define the period of non-use before the balance automatically switches into the energy-saving mode.

! NOTE

The Auto-Standby function only works with the automatic zero-correction activated („AUTO-ZERO“).

„FLOATINGDISPLAY“

The value set for „FLOATINGDISPLAY“ defines the period after which each new measurement is displayed. For the definition of this period, the quality of the balance location is crucial. The stability control must also be set appropriately.

Recommended values:

- Optimum balance location: „FLOATINGDISPLAY 0.08“
- Good balance location: „FLOATINGDISPLAY 0.16“
- Critical balance location: „FLOATINGDISPLAY 0.32“

! NOTE

The value of the Floating Display is a function of the stability control and the balance location. For balance location, see chapter 7.4 "Choosing a suitable location" and see chapter 8.3.6 "Weighing mode".

■ 8 Operation

„STABILITY“

The value set for the stability control depends on the quality of the balance location and must be correctly chosen in order to obtain optimum, reproducible results. Choose:

- Optimum balance location: „STABILITY LOW“
- Good balance location: „STABILITY MEDIUM“
- Critical balance location: „STABILITY HIGH“

„AUTO-STANDBY“

The Auto-Standby mode turns off the balance automatically, if:

- the balance is tared and has shown “Zero” for at least 5 minutes
- the balance has received no remote control command via the interface for at least 5 minutes,
- the automatic zero correction „AUTO-ZERO” is activated.

It is possible to re-start the balance after it has been switched off by an automatic Auto-Standby:

- Briefly press any key
- Put a weight on the balance
- Make a remote control command via the interface

„AUTO-ZERO“

If the automatic zero correction „AUTO-ZERO” is activated, the balance always gives a stable zero (e.g. even with fluctuations in room temperature).

8.3.7 Interface functions

• SET INTERFACE			
	BAUDRATE	300 600 1200 2400 4800 9600 19200	Select baud rate
	PARITY	7-EVEN-1STOP 7-ODD-1STOP 7-NO-2STOP 8-NO-1STOP	Select parity
	HANDSHAKE	NO XON-XOFF HARDWARE	Select handshake function

The RS232/V24 interface on the device is matched to the interface of a peripheral device with the aid of the interface functions (see chapter 13 "Data transfer").

8.3.8 Date and time

• SET DATE AND TIME			
	DATE	[DD.MM.YY]	Set date and time
	TIME	[HH.MM.SS]	
	FORMAT	STANDARD/US	

! NOTE

If a power failure occurs, the timer continues running. If this does not happen, this indicates that the instrument's backup battery has expired and has to be replaced by the Customer Service.

8.3.9 Anti-theft encoding

The balance can be protected against theft by using a freely selectable, four-digit numerical code:

- If the anti-theft code is deactivated, the instrument can be re-started and operated after a power outage without having to enter a code.
- If the anti-theft code is activated, the instrument requires the code to be input after each power outage.
- If the code is entered incorrectly, the instrument is locked.
- If the instrument is locked, it must first be disconnected from the power supply, then reconnected and unlocked by entering the correct code.
- After seven consecutive incorrect entries, the display reads „NO ACCESS, CALL SERVICE“. In this case only a service engineer can unlock the instrument again.



NOTE

The anti-theft encoding is deactivated in the factory settings.

The **preprogrammed code** set at the factory is: **8 9 3 7**

This code is the same in all balances. Therefore, for security reasons, enter your own code.

Keep your **own code** in a safe place.

• THEFTCODE			
THEFTCODE	----	THEFT-PROTECTION ON/OFF	Switch encoding on/off
		NEW CODE	---- Enter a new code

Procedure to activate the anti-theft encoding:

Display	Key	Step
THEFTCODE ----	«↓»	Press repeatedly, until the „THEFTCODE“ is displayed.
THEFTCODE 0 0 0 0	«←»	The first digit in the code flashes and can be changed.
THEFTCODE 8 0 0 0	«↓»	Press repeatedly, until the first digit in the code is set.
THEFTCODE 8 0 0 0	«⇒»	The second digit flashes. The code can now be entered fully.
THEFTCODE 8000	«←»	Confirm the theft code.
THEFT-PROTECTION OFF	«⇒»	The theft-protection can now be set.
THEFT-PROTECTION OFF	«←»	The display flashes, and the theft-protection can be activated.
THEFT-PROTECTION ON	«↓»	Activate the theft-protection.
THEFT-PROTECTION ON	«←»	Confirm the theft-protection.

The procedure for changing the code is as follows:

Display	Key	Step
NEW CODE 8 9 3 7	«↓»	Press repeatedly, until „NEW CODE“ appears. Set the new code as described above.

■ 8 Operation

8.3.10 Key tone

• KEY TONE	
KEY TONE	ON/OFF
Switch key tone on and off	

If the key tone is switched on, a short audio signal sounds each time a key is pressed.

8.3.11 Contrast

• CONTRAST	
CONTRAST	6
Set the contrast, only in LCD displays	

The display contrast can only be set in instruments with an LCD display.

8.4 Special operating keys

8.4.1 The tare key

- **Activating taring**
 - Ensure that the balance is in the Weighing mode
 - Briefly press «T»
 - The balance performs a tare operation.
- **Range selection**

(This option is only available on dual range or floating range balances)

 - Ensure that the balance is in the Weighing mode
 - Hold down «T» until „RANGE FINE ON“ or „RANGE FINE OFF“ is displayed
 - Release «T»
 - If „RANGE FINE OFF“ is selected the balance is working only in the coarse range and therefore the readability is 10 times lower than in the fine range.
- **Activating calibration**
 - Ensure that the balance is in the Weighing mode
 - Hold down «T» until „CALIBRATION“ is displayed
 - Release «T»
 - The balance carries out a calibration sequence in accordance with the settings in the configuration menu (see chapter 8.3.5 "Calibration functions") and reports these by means of a print-out.
- **Activating an automatic repeatability test (ART)**
 - Ensure that the balance is in the Weighing mode
 - Hold down «T» until „REPEATABILITY TEST“ is displayed
 - Release «T»
 - The balance carries out an automatic repeatability test and the results is printed out (see chapter 14.4 "Automatic Repeatability Test (ART)").



NOTE



The calibration can be interrupted with the «ON/OFF» key.

8.4.2 The print key

- **Print out an individual value or a report**
 - Ensure that the balance is in the Weighing mode
 - Briefly press «PRINT»
 - The individual value or report will be printed out.
- **Reset product counter to 1**
 - Ensure that the balance is in the Weighing mode
 - Hold down «PRINT» until „RESET PROD.-COUNTER“ is displayed
 - Release «PRINT»
 - The product counter will be reset to 1.
- **Print out a balance status**
 - Ensure that the balance is in the Weighing mode
 - Hold down «PRINT» until „PRINT STATUS“ is displayed

- Release «**PRINT**»
- The balance status will be printed out.
- **Print out the application-setup**
 - Ensure that the balance is in the Weighing mode
 - Hold down «**PRINT**» until „PRINT APPLICATIONS“ is displayed
 - Release «**PRINT**»
 - The application-setup will be printed out.
- **Print out the calibration information**
 - Ensure that the balance is in the Weighing mode
 - Hold down «**PRINT**» until „PRINT CALIBRATIONS“ is displayed
 - Release «**PRINT**»
 - Information on the last 50 calibrations is printed. The time and date, as well as the temperature in the balance at the time of calibration in degrees Celsius. If more than 50 calibrations have been performed, the oldest are deleted.

8.4.3 The change key

- **Switch to other applications**
 - As long as you hold «», all active applications are shown one after the other: if, for example, the statistics program, the check program and the count application are activated, „WEIGHING“, „STATISTIC“, „CHECK“ and „COUNT“ appear in the info-line one after the other:
 - Release «» when the application to which the balance should be switched, appears in the display.

8.5 Application menu

The balance application programs are called up using the application menu and adapted to the user's needs:

Menu	Definable functions
SET APP.	Select application program
SETUP APPLICATION	Specify parameters for the application program selected
SET STATISTIC	Statistics and storage functions
SET CHECK +/-	Define nominal weight and limits for comparison weighing
etc.	Other functions available. Refer to the Application Operating Instructions for the description.
AUTO-START ON/OFF	The selected application program can, if required, be loaded automatically every time the balance is switched on
SET USER	Define user profile

- The settings for the sub-menus programmed in works are printed here in **bold**
- For greater clarity, only that part of the menu tree which corresponds to this application is shown with each application description.
- You will find the complete menu tree for the application menu in see chapter 15.2 "Application menu tree".
- Explanations of the menu functions are printed in *italics*.

8.5.1 Activating the application menu

- Press «**MENU**» after the start-up procedure has ended in order to access the application menu.

8.5.2 Selecting an application program

• SELECT APPLICATION		
SET APP.	OFF	<i>normal weighing</i>
	UNITS	<i>different weight units</i>
	COUNT	<i>Piece counting</i>
	PERCENT	<i>Percent weighing</i>
	CALCULATOR	<i>Conversions</i>
	PAPER	<i>Determine paper weight (in g/cm²)</i>
	NET-TOTAL	<i>Add weighing results with intermediate tare</i>

■ 8 Operation

SUM	<i>Add weighing results without intermediate tare</i>
ANIMAL	<i>Animal weighing</i>
...	...
etc.	<i>Other functions available.</i>
	<i>Refer to the Application Operating Instructions for the description</i>

In this function-field, select the desired application program.

If an application program is selected in the „SET APP.“ menu, then only those sub-menus, which contain functions and parameters necessary to define the chosen application program are shown in the „SETUP APPLICATION“ menu.



NOTE

Refer to the Application Operating Instructions for a description of applications which are not described in these Operating Instructions.

9 Application

9.1 Units

• SETUP APPLICATION			
UNITS	UNIT-2	mg	<i>Milligram</i>
		----	----
		OFF	<i>not active</i>
	UNIT-3	GN	<i>Grain</i>
		----	----
		OFF	<i>not active</i>
	UNIT-4	ct	<i>Carat</i>
		----	----
		OFF	<i>not active</i>

Assigning the function keys:

Key	Function
«g»	Show measurement in unit 1, e.g. Gram
«mg»	Show measurement in unit 2, e.g. Milligramm
«GN»	Show measurement in unit 3, e.g. Grain
«ct» or «STO»	Show measurement in unit 4, e.g. Carat or Statistics functions if the statistics-program is activ



NOTE

For basic operation, Unit 1 is defined in the Configuration menu (standard unit for all weighing procedures, if the application program „UNIT“ is not called up, see chapter 8.3.3 "Selecting the weight unit").

English

Display	Key	Step
	«↺»	Press until „UNITS“ appears.
	«⇒»	The weight is displayed as milligrams,

By pressing the relevant function key the weight display is switched to the corresponding unit.

The weight is printed in the unit of measurement shown by pressing the «PRINT» key.

9.2 Count

• SETUP APPLICATION			
COUNT	KEY-1	5	<i>Reference-number of pieces = 5</i>
	KEY-2	10	<i>Reference-number of pieces = 10</i>
	KEY-3	25	<i>Reference-number of pieces = 25</i>
	KEY-4	50	<i>Reference-number of pieces = 50</i>

With the aid of the „COUNT“ program you can count items of uniform weight (screws, bearings, coins, etc.). For this, you must first weigh a defined number of items (for example 5 items) and assign the reference number of pieces to the reference weight so obtained by pressing the corresponding function key.



NOTE

Depending on the weight and tolerances of the objects to be counted, you should count a representative number of items for the regulation of the reference-weight.

■ 9 Application

Working without Tare value:

Display	Key	Step						
<table border="1"> <tr><td>+</td><td>0,0000</td><td>9</td></tr> <tr><td>COUNT</td><td></td><td></td></tr> </table>	+	0,0000	9	COUNT			«C»	Press until „COUNT“ appears.
+	0,0000	9						
COUNT								
<table border="1"> <tr><td>+</td><td>12,1596</td><td>9</td></tr> <tr><td>5</td><td>10</td><td>25 50</td></tr> </table>	+	12,1596	9	5	10	25 50		apply (or remove) e.g 25 pieces
+	12,1596	9						
5	10	25 50						
<table border="1"> <tr><td>+</td><td>25</td><td>PCS</td></tr> <tr><td>5</td><td>10</td><td>25 50</td></tr> </table>	+	25	PCS	5	10	25 50	«↑»	The weight is recalculated in pieces (PCS) and displayed. The reference quantity is set.
+	25	PCS						
5	10	25 50						

The quantity shown is printed by pressing the «PRINT» key.

Working with Tare value, manually input by hand or interface, eg. 20.0000g:

Display	Key	Step						
<table border="1"> <tr><td>+</td><td>10,0000</td><td>9</td></tr> <tr><td>COUNT</td><td></td><td></td></tr> </table>	+	10,0000	9	COUNT			«C»	Press until „COUNT“ appears.
+	10,0000	9						
COUNT								
<table border="1"> <tr><td>+</td><td>10,0000</td><td>9</td></tr> <tr><td>5</td><td>10</td><td>25 50</td></tr> </table>	+	10,0000	9	5	10	25 50	«↑»	25 is flashing, the point of reference is measured
+	10,0000	9						
5	10	25 50						
<table border="1"> <tr><td>+</td><td>35,0000</td><td>9</td></tr> <tr><td>5</td><td>10</td><td>25 50</td></tr> </table>	+	35,0000	9	5	10	25 50	«↑»	apply (or remove) e.g 25 pieces
+	35,0000	9						
5	10	25 50						
<table border="1"> <tr><td>+</td><td>35</td><td>PCS</td></tr> <tr><td>5</td><td>10</td><td>25 50</td></tr> </table>	+	35	PCS	5	10	25 50	«↑»	The weight is recalculated in pieces (PCS) and displayed. The reference quantity is set.
+	35	PCS						
5	10	25 50						

The quantity shown is printed by pressing the «PRINT» key.

9.3 Percent

• SETUP APPLICATION												
PERCENT	<table border="1"> <tr> <td>DECIMALS</td> <td>AUTO</td> <td rowspan="5">Enter number of decimal places. The number of places that can be selected after the decimal point depends on the balance model.</td> </tr> <tr><td></td><td>0</td></tr> <tr><td></td><td>1</td></tr> <tr><td></td><td>2</td></tr> <tr><td></td><td>etc.</td></tr> </table>	DECIMALS	AUTO	Enter number of decimal places. The number of places that can be selected after the decimal point depends on the balance model.		0		1		2		etc.
DECIMALS	AUTO	Enter number of decimal places. The number of places that can be selected after the decimal point depends on the balance model.										
	0											
	1											
	2											
	etc.											

With the aid of the „PERCENT“ program you can display and print out the weight of different measurements as a percentage of a previously defined reference weight.

Working without Tare value:

Display	Key	Step						
<table border="1"> <tr><td>+</td><td>13,4560</td><td>9</td></tr> <tr><td>PERCENT</td><td></td><td></td></tr> </table>	+	13,4560	9	PERCENT			«C»	Press until „PERCENT“ appears.
+	13,4560	9						
PERCENT								
<table border="1"> <tr><td>+</td><td>100,000</td><td>%</td></tr> <tr><td>SET</td><td></td><td></td></tr> </table>	+	100,000	%	SET			«←»	Place the reference weight on the balance to set the reference weight equal to 100%.
+	100,000	%						
SET								

All subsequent measurements will now be shown as percentages of the reference weight so defined.
The percentage shown is printed by pressing the «PRINT» key.

Working with Tare value, manually input by hand or interface, here e.g. 20.0000g:

Display	Key	Step						
<table border="1"> <tr><td>+</td><td>10,0000</td><td>9</td></tr> <tr><td>PERCENT</td><td></td><td></td></tr> </table>	+	10,0000	9	PERCENT			«C»	Press until „PERCENT“ appears.
+	10,0000	9						
PERCENT								

Display	Key	Step
<div style="border: 1px solid black; padding: 2px;"> + 10,0000 9 SET </div>	«←»	„SET“ is flashing. The point of reference is measured
<div style="border: 1px solid black; padding: 2px;"> + 30,0000 9 SET </div>		apply e.g. 20.0000g
<div style="border: 1px solid black; padding: 2px;"> + 130,000 % SET </div>	«←»	The weight is recalculated in percent (%) and displayed. The reference quantity is set.

All subsequent measurements will now be shown as percentages of the reference weight so defined. The percentage shown is printed by pressing the «**PRINT**» key.

9.4 Calculator

• SETUP APPLICATION		
CALCULATOR	SET KEY-1	NAME nnnnn FACTOR n.nnn e + n
		MODE F * WEIGHT F / WEIGHT
		DECIMALS n DISPLAY-TEXT nnn PRINTER-TEXT nnnnnnnn
	SET KEY-2	as for key 1
	SET KEY-3	as for key 1
	SET KEY-4	as for key 1

English

When the „CALCULATOR“ application is activated, each of the four function keys is assigned a calculation method with the following settings.

„NAME“

Function key name, max. 5 characters.

„FACTOR“

Factor by which the weight is to be offset.

„MODE“

Multiplication of the factor by the weight or division of the factor by the weight.

„DECIMALS“

Definition of number of decimal places are to be shown in the result.

„DISPLAY TEXT“

Unit shown in the display, max. 3 characters.

■ 9 Application





„PRINTER TEXT“

Unit being printed, max. 8 characters.

In the program operation, the previously defined names of the keys appear over the function keys.

After pressing a function key, the current measurement is converted in accordance with the factor assigned and the result shown or printed out after pressing the Print key.

Thus, for example, you can convert and display the weights of sample materials of known size directly into “gram per cubic metre”.

Display	Key	Step
		Press until „CALCULATOR“ appears.
		The measurement is recalculated accordingly.



The calculated measurement is printed with the set printer text by pressing the «PRINT» key.

9.5 Paper

The setting up of the „PAPER“ program is similar to that for the calculator (see chapter 9.4 "Calculator").

With the aid of this program you can convert and display the weights of paper samples of standard sizes directly in “gram per square metre”.

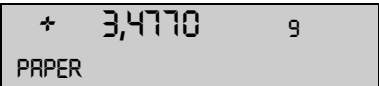
The standard variables 100 cm², 20x25 cm, A4 and 40x25 cm are set as defaults and are assigned to the function keys.

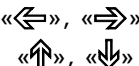
Display	Key	Step
		Hold down until „PAPER“ appears.
		The measurement is recalculated accordingly.

The calculated measurement is printed with the set printer text by pressing the «PRINT» key.

9.6 Net-Total

• SETUP APPLICATION	<i>There is no Setup menu for this application!</i>
NET-TOTAL	

With the aid of the „NET TOTAL“ program you can add individual weighing results, where the balance is tared to zero again before each individual weighing procedure.

Assignment of the function keys:

Key	Function
«STO i»	Take stable value and add to the sum of the components
«WAIT i»	Value not stabilized yet
«RES»	Reset
«INF»	Change to display the total weight („TOTAL“), residual capacity („RES. CAP.“), individual values and again back to the normal display. Press «esc» to exit the INF display.

Display	Key	Step
		Press until „NET-TOTAL“ appears.

Display	Key	Step
<div style="border: 1px solid black; padding: 2px;"> + 3,4770 9 STO 1 RES INF </div>	«←»	Store the stable weight applied and add it to the sum of the components; the balance is tared.
<div style="border: 1px solid black; padding: 2px;"> + 0,0000 9 STO 2 RES INF </div>	«←»	Add further weights
Retrieve the parameters:		
<div style="border: 1px solid black; padding: 2px;"> + 0,0000 9 TOTAL 100,5790 9 </div>	«↓»	Show the info display. Display the total of the added components.
<div style="border: 1px solid black; padding: 2px;"> + 0,0000 9 RES. CAP. 304,4210 9 </div>	«↓»	Display the remaining capacity.
<div style="border: 1px solid black; padding: 2px;"> + 0,0000 9 1= 3,4770 9 </div>	«↓»	Display the individual components.
<div style="border: 1px solid black; padding: 2px;"> + 0,0000 9 STO 2 RES INF </div>	«esc»	Exit the info display.
Clear the measurements:		
<div style="border: 1px solid black; padding: 2px;"> + 0,0000 9 STO 2 RES INF </div>	«↑»	Hold down the key until the acoustic signal sounds and the component counter is reset.
<div style="border: 1px solid black; padding: 2px;"> + 0,0000 9 STO 0 RES INF </div>		Measurements cleared, balance is ready for a new measurement.

A measurement log is printed by pressing the «**PRINT**» key.

9.7 Sum

- **SETUP APPLICATION** *There is no Setup menu for this application!*

With the aid of the „SUM“ program, you can add individual weighings, without the balance being tared to zero before each individual weighing.

Assignment of the function keys:

Key	Function
«STO i»	Take stable value and add to the sum of the components
«WAIT i»	Value not stabilized
«RES»	Reset
«INF»	Change to display the total weight („TOTAL“), residual capacity („RES. CAP.“), individual values and again back to the normal display. Press «esc» to exit the INF display.

Display	Key	Step
<div style="border: 1px solid black; padding: 2px;"> + 3,4770 9 SUM </div>	«C»	Press until „SUM“ appears.
<div style="border: 1px solid black; padding: 2px;"> + 3,4770 9 STO 1 RES INF </div>	«←»	Store the stable value and add it to the sum of the components.
<div style="border: 1px solid black; padding: 2px;"> + 8,58962 9 STO 2 RES INF </div>	«←»	Add further weights.

■ 9 Application

Display	Key	Step
Retrieve the parameters:		
	«↓»	Show the info display. Display the total of the added component.
	«↓»	Display the remaining capacity.
	«↓»	Display the individual components.
	«esc»	Exit the info display.
Clear the measurements:		
	«↑»	Hold down the key until the acoustic signal sounds and the component counter is reset.
		Measurements cleared, balance is ready for a new measurement.

A measurement log is printed by pressing the «**PRINT**» key.

9.8 Animal

• SETUP APPLICATION

ANIMAL	MEASURETIME	4	Enter time in seconds
--------	-------------	---	-----------------------

With the aid of the „ANIMAL“ program you can weigh live animals accurately, even if they move on the weighing pan.

The balance measures continuously throughout the period defined by the user in the Setup menu, averages the stored values at the end of the measuring period and displays average-measurement thus obtained.

Assignment of the function keys:

Key	Function
«MAN»	Manual release of the measurement.
«AUTO»	Automatic release of the measurement with a second delay after each load change.
«STO»	Statistics storage function if activated.

Display	Key	Step
	«C»	Press until „ANIMAL“ appears.
	«←»	Manual release of the measurement.
	«⇒»	Automatic release of the measurement with a second delay after each load change.
		Display the measurement result; the small circle in the display is active.
	«↓»	Statistics storage function if activated

The measurement result is printed by pressing the «**PRINT**» key.

10 Statistics

• SET STATISTIC

STATISTIC	MODE	OFF	Statistics program off
		STATISTIC	Statistics only
		RECORDER	Data storage only
		STAT./RECORDER	Statistics and storage
	COUNT	100	Number of values to be stored automatically (1..500).
	RECORDING	MANUAL	With «STO i» function key
		TIMEBASE	on a time basis
		LOADCHANGE	after every weight change
	TIMBASE	2.0	Time base for "storage" in seconds

Functions of the statistics program and storage functions:

„MODE“

In this function-field you may define whether only the statistics-program, only the storage-program or both programs simultaneously should be used.

„COUNT“

A number of measurements is laid down, after which automatic storage is to be terminated.

„RECORDING“

„MANUAL“: The «STO i» function key must be pressed for each value to be stored.

„LOADCHANGE“: The balance stores the measured value automatically after a load change.

„TIMEBASE“: The balance stores every value measured after a defined period (default: 2.0 seconds).

„TIMEBASE“

Definition of the time span for the recording of data in accordance with „RECORDING TIMEBASE“ (for example, every 2.0 seconds).















NOTE

In storing the first value a range of $\pm 50\%$ is determined. Subsequent values must be within this range otherwise an error message will be issued.

Assignment of the function keys:

Key	Function
«STO i»	Take value, start/stop of automatic recording
«AUTO i»	Automatic recording is running
«WAIT i»	Value not stabilized yet
«RES»	Before a new series of measurements the storage must be reset using «RES». The key must be held down until the acoustic signal sounds and the measurement counter is reset.
«END»	Permanently store data (only with recording activated)
«INF»	Change the display to the info display. Displayed information: - „Average value (AVERAGE)" - „Standard deviation (STD DEV.)" - „Relative standard deviation (STD DEV.-%)" - „Maximum (MAX)" - „Minimum (MIN)" - „individual values" Press «esc» to exit the info display.

■ 10 Statistics

Display	Key	Step
<pre> + 3,4770 9 STATISTIC </pre>		Press until „STATISTIC“ appears.
<pre> + 3,4770 9 STO 0 RES INF </pre>		Record a stable measurement.
<pre> + 3,4785 9 STO 1 RES INF </pre>		Record a second measurement.
<pre> + 3,4775 9 STO 2 RES INF </pre>		Record a third measurement.
Retrieve the parameters:		
<pre> + 0,0000 9 MEAN 3,4777 9 </pre>		Show info display. Average measurement
<pre> + 0,0000 9 STDE. 0,00076 9 </pre>		Standard deviation
<pre> + 0,0000 9 STDE-% 0,02 % </pre>		Relative standard deviation
<pre> + 0,0000 9 MAX 3,4785 9 </pre>		Maximum
<pre> + 0,0000 9 MIN 3,4770 9 </pre>		Minimum
<pre> + 0,0000 9 1= 3,4770 9 </pre>		Measurement 1
<pre> + 0,0000 9 2= 3,4785 9 </pre>		Measurement 2, etc.
<pre> + 3,4775 9 STO 2 RES INF </pre>		Exit info display.
Clear measurements:		
<pre> + 3,4775 9 STO 2 RES INF </pre>		Hold down the key until the acoustic signal sounds and the measurement counter is reset.
<pre> + 3,4775 9 STO 0 RES INF </pre>		Measurement cleared, balance ready for new statistics.

A statistics log is printed by pressing the «**PRINT**» key.

11 Check-Weighing

• SET CHECK +/-			
CHECK +/-	MODE	ON/OFF	Switch application on/off
	NOM.	100.000 g	Enter nominal weight
	TO	120.000 g	Define over limit
	TU	80.000 g	Define under limit

With the aid of the „CHECK +/-“ program you can check each measurement for its agreement with a defined reference-value plus/minus allowable deviations.

- The four function keys are not active.
- In the display „+“, „-“ and „→||←“ are active.
If „→||←“ lights up, the measured value lies within the specified tolerances.

! NOTE
As an accessory, a signal light is available for this type of display (see Accessories).

Display	Key	Step
		Press until „CHECK +/-“ appears. The check application is activated.

12 User profiles (MUM, Multiuser Memory)

10 different user profiles can be saved. They can be protected against changes by means of a personal 4-digit password. A profile consists of the configuration and application settings.

Anyone who does not wish to create a personal user profile can work with the balance as a "guest". The settings from the last user profile used are applied. If a "guest" works with the balance, device options and settings can be changed, although they are not saved when the balance is switched off.

• SET USER		
USER	ttt...	<i>User name</i>
NEW PASSWORD	----	<i>Enter user password</i>
CLEAR USER		<i>Clear active user</i>

12.1 Activating a user

- Press «ON/OFF» to switch on the balance.
- Hold down «C» constantly during the start-up process (approx. 10 seconds) until „NEW USER“ appears in the display.
- A new user can be selected by pressing the «←» key. The balance completes start-up and switches to Weighing mode.

12.2 Creating a new user profile

If no user profile has yet been defined, the balance can be used normally. In order to work with different user configurations, Work with Users must first be activated.

Display	Key	Step
+ 0,00000 9	«MENU»	Start the application menu.
----- SET APP. OFF	«↑»	Press repeatedly, until „SET USER“ is displayed.
----- SET USER	«⇒»	Switch into the user identification menu options.
----- USER	«←»	Activate the user name entry and enter the required name using the cursor keys. A user name may be up to 20 characters long.
----- USER EXAMPLE	«←»	Confirm the entry.
----- NEW PASSWORD ----	«↓»	If you wish, protect the user settings with a four-digit password.
----- NEW PASSWORD 0 0 0 0	«←»	The first digit of the password flashes and can be changed.
----- NEW PASSWORD 8 0 0 0	«↑» «↓»	Press until the first digit in the password is set.
----- NEW PASSWORD 8 0 0 0	«⇒»	The second digit flashes. The password can now be entered fully.
----- NEW PASSWORD 8 2 3 5	«←»	Confirm the password.

The user is defined. Press «esc» to exit the menu.

If there is a password set, it must be entered before making changes in the configuration and application menus.

NOTE
<p>Make a note of your personal password.</p> <p>If a user loses his password, he can be enabled again using the password 7 9 1 4.</p> <p>This password is the same for all balances and is always valid in parallel to the password which the user has selected.</p>

12.3 Changing the password and password protection

- The password can be entered by entering a new password.
- Password protection can be disabled by resetting the current password to **0 0 0 0**.

12.4 Clearing a user

A user can be cleared by selecting the „CLEAR USER“ option in the menu and pressing «↵» to confirm this entry.

If no further users are defined, Work with Users must be activated again in order to facilitate work with users.

Display	Key	Step
<div style="border: 1px solid black; padding: 5px; background-color: #f0f0f0;"> <p style="text-align: center;">-----</p> <p>CLEAR USER</p> </div>	«↓»	<i>Select the „CLEAR USER“ menu option.</i>
<div style="border: 1px solid black; padding: 5px; background-color: #f0f0f0;"> <p style="text-align: center;">-----</p> <p>SET USER</p> </div>	«↵»	<i>The active user is cleared.</i>

12.5 Setting the user

When the balance is started up, the system asks for the desired user profile.

Display	Key	Step
<div style="border: 1px solid black; padding: 5px; background-color: #f0f0f0;"> <p style="text-align: center;">-----</p> <p>USER EXAMPLE</p> </div>	«↑» «↓»	<i>Select the desired user profile and press the «↵» key to confirm.</i>

- If one of the defined user profiles is selected, the corresponding user password must be entered, where necessary. The user can then work with the balance.
- If „USER GUEST“ is selected, any available settings can be defined, although they are not saved.
- If „USER NEW“ is selected, the user name and the password must be entered in the application menu in order to define the user profile.

13 Data transfer

For data-transfers to peripheral devices, the balance is equipped with an RS232/V24-interface.

Before the data-transfer, the RS232 interface must be matched with the one in the peripheral device in the balance configuration menu (see chapter 8.3.7 "Interface functions").

• **Handshake**

The handshake is set to „NO“ (none) at the factory. It can be set to software handshake „XON-XOFF“, or to hardware handshake „HARDWARE“.

• **Baud rate**

Possible baud rates: 300, 600, 1200, 2400, 4800, 9600, 19200 baud.

• **Parity**

Possible parity: 7 even 1 stop, 7 odd 1 stop, 7 No 2 stop, 8 No 1 stop.

± 12 V	SB	1	2	3	4	5	6	7	8	SP
7-even-1	SB	1.DA	2.DA	3.DA	4.DA	5.DA	6.DA	7.DA	PB	SP
7-odd-1	SB	1.DA	2.DA	3.DA	4.DA	5.DA	6.DA	7.DA	PB	SP
7-no-2	SB	1.DA	2.DA	3.DA	4.DA	5.DA	6.DA	7.DA	1.SP	2.SP
8-no-1	SB	1.DA	2.DA	3.DA	4.DA	5.DA	6.DA	7.DA	8.DA	SP

SB: Start bit PB: Parity bit
 DA: Data bit SP: Stop bit

• **Display**

S	D7	D6	D5	D4	D3	D2	D1	D0	U	U	U
---	----	----	----	----	----	----	----	----	---	---	---

The data-transfer takes place in ASCII code:

1	2	3	4	5	6	7	8	9	10	11	12	13	14	15
B	B	B	S	D7	D6	D5	D4	D3	D2	D1	DP	D0	B	U	...	CR	LF

- B** Blank (space)
- S** Sign (+, -, space)
- DP** Decimal point
- D0...D7** Digits
- U ...** Unit (only if the weight is stable, otherwise no unit is send)
- CR** Carriage return
- LF** Line feed

!	NOTE
Unused positions are filled with spaces. The decimal point DP can be between D0 and D7.	

13.1 Connection scheme

• **Standard duplex connection**

Balance	RJ 45	D25 / D9	Peripheral device
RS 232 out	2 \longrightarrow	3 / 2	RS 232 in
RS 232 in	6 \longleftarrow	2 / 3	RS 232 out
GND	5 \longrightarrow	7 / 5	GND

• **Standard, duplex connection with additional hardware handshake in the peripheral device**

Balance	RJ 45	D25 / D9	Peripheral device
RS 232 out	2 \longrightarrow	3 / 2	RS 232 in

Balance	RJ 45	D25 / D9	Peripheral device
RS 232 in	6 ←	2 / 3	RS 232 out
GND	5	7 / 5	GND
CTS	3 ←	20 / 4	DTR
DTR	7 →	5 / 8	CTS

• Pin configuration of the RJ45 socket

Balance	RJ 45	Remark
n.c.	1	not connected
RS 232 out	2	Out (V24)
CTS	3	In (V24)
VDC	4	Out (9..16V)
GND	5	0V
RS 232 in	6	In (V24)
DTR	7	Out (V24)
EXTBUS	8	In (5V, logic)

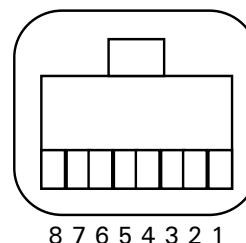

13.2 Remote control-commands

Command	Function
ACK	Acknowledge n=0 off; n = 1 on
CAL	Start calibration
D.....	Describe weight display (right-aligned)
DN	Reset weight display
@.....	Describe Info display
@N	Reset Info display
In	Set FLOATINGDISPLAY time nn = 0 t = 0.04 s n = 1 t = 0.08 s n = 2 t = 0.16 s n = 3 t = 0.32 s
N	Reset balance
OFF	Switch off balance
ON	Switch on balance
PCxxxx	Enter anti-theft code
PDT	Print out date and time
PRT	Start printing (Press «PRINT» key)
PST	Start print status
Pn (ttt.t)	Set print mode n = 0 Individually print each value (unstable) n = 1 Individually print each value (stable) n = 2 Print after change of load n = 3 Print after each integration period n = 4 Print on time basis in s (ttt.t)
R%k	Set current weight = 100% with k = 0...7 decimal places (k = A: use automatic positioning of decimal point)
REF%k rrr	Set reference weight rrr for 100% with k = 0...7 decimal places (k = A: use automatic positioning of decimal point)
Rnnn	Set current weight = nnn items
REFrrr	Set reference weight rrr for 1 item
Sn	Set stability n n = 0 low n = 1 medium n = 2 high

■ 13 Data transfer

Command	Function
SDTtmmjj hhmmss	Set date and time (German) (Tag, Monat, Jahr, Stunde, Minute, Sekunde)
SDTmmddy hhmmss	Set Date and Time (English) (Month, Day, Year, Hour, Minutes, Seconds)
T (ttt)	Tare or set tare to a specific value
Uxnn	Set unit x (1...4) of the balance with nn (0 = g, 1 = mg, 2 = kg, ...)
UxS	Switch balance to unit x (1...4)
ZERO	Zero balance (provided weight is stable and within the zero position range)



NOTE

Each remote control-command must terminate with «CR» «LF».
The commands are acknowledged if required.

13.2.1 Examples for the remote control

Input	Description of the function executed
D - - - - -	Five dashes are displayd
DTEST123	tESt123 is displayd
D	The display is dark
T100	-100.000 g (Tare set to 100 g)
T1	-1.000 g (Tare set to 1g)
T	Balance is tared

14 Service

14.1 Maintenance and servicing

The balance must be treated carefully and cleaned regularly. It is a precision instrument.

DANGER

For maintenance work, the balance must be separated from the power supply (remove power adaptor plug from socket). Also ensure that the balance cannot be reconnected to the power supply during the work by a third party.

Take care during cleaning that no liquid penetrates into the appliance. If liquid is spilt on the balance, the latter must immediately be disconnected from the electricity supply. The balance must only be used again after it has first been checked by a Service Engineer.

The connections on the rear of the appliance and the power adaptor must not come into contact with liquids.

Regularly dismantle the weighing pan and the weighing pan holder and remove any dirt or dust from under the weighing pan and on the balance housing with a soft brush or a soft, lint-free cloth, moistened with a mild soap solution.

The weighing pan and the holder can be cleaned under running water. Take care that both parts are completely dry before they are re-installed on the balance.

CAUTION

Never use solvents, acids, alkalis, paint thinners, scouring powders or other aggressive or corrosive chemicals for cleaning, since these substances attack the surfaces of the balance housing and can cause damage.

The regular maintenance of the balance by your Service Representative will guarantee unlimited function and reliability over many years and will extend the lifespan of the balance.

14.2 Error messages

The balance shows a description of the fault in the info-line.

NOTE

If an error occurs without a description of the error in the info-line, the Customer Service must be called.

14.2.1 Notes on correcting faults

The following table shows faults and their possible causes. If you cannot clear the fault using the table, please contact the Customer Service..

Fault	Possible cause
Weight display does not light	<ul style="list-style-type: none"> • Balance not switched on • Connection to power adaptor is interrupted • Power supply has failed (interruption to current) • The power adaptor is defective
"OL" is shown in display	<ul style="list-style-type: none"> • The weight range has been exceeded (Observe information on the maximum weight range)
"UL" is shown in display	<ul style="list-style-type: none"> • The weight range is below the range of the balance (Scale pan or scale pan holder missing)

■ 14 Service

Fault	Possible cause
The weight display fluctuates continuously	<ul style="list-style-type: none"> • The draft is too strong at the balance location • The balance support is vibrating or varying • The scale pan is touching a foreign body • The time chosen for FLOATINGDISPLAY is too short • The material being weighed is absorbing moisture • The material being weighed is being blown away or is evaporating • Strong temperature variations in the material being weighed
Results of weighing are clearly incorrect	<ul style="list-style-type: none"> • The balance was not correctly tared • The balance is not correctly levelled • The calibration is no longer correct • There are strong temperature variations
There is no display or only dashes	<ul style="list-style-type: none"> • The stability control (Balance functions) is set too sensitively • The time selected for „FLOATINGDISPLAY“ is unsatisfactory
Configuration menu cannot be changed	<ul style="list-style-type: none"> • The password lock is activated in the configuration menu
The display flashes continuously during calibration	<ul style="list-style-type: none"> • The balance location is not stable enough (Interrupt calibration with «ON/OFF» and relocate the balance in a better position) • Use of an imprecise calibration weight (only applies to external calibration)

14.3 Calibration

The calibration of the balance is fixed in the Configuration menu (see chapter 7.7 "Calibration of the balance" and see chapter 8.3.5 "Calibration functions").

Possible types of calibration, depending on the model of balance:

- External calibration by means of ICM (Intelligent Calibration Mode)
- External calibration with freely selectable weight
- Internal calibration
- Automatic calibration

! NOTE

The calibration can be interrupted at any time by pressing «ON/OFF».

14.3.1 External calibration by means of ICM

Depending on the type of balance, calibration weights in steps of 10 g, 50 g, 100 g and 500 g can be used, where the calibration weight must correspond to the precision of the balance.

For an external calibration by means of ICM, „SET CALIBRATION MODE EXTERNAL“ must be selected in the Configuration menu (see chapter 8.3.5 "Calibration functions").

Display	Key	Step
		<i>The balance is in Weighing mode.</i>
	«T»	<i>Press until „CALIBRATION“ appears.</i>
		<i>The balance carries out a Zero measurement „0000 g“ is shown flashing).</i>

Display	Key	Step
		After the zero measurement the display flashes with the recommended calibration weight.
		Place the calibration weight on the weighing pan. The display continues to flash.
		Calibration is complete when the display stops flashing

14.3.2 External calibration with freely selectable weight

For external calibration with user-definable weight, „SET CALIBRATION MODE EXT. -DEF.“ must be selected in the Configuration menu (see chapter 8.3.5 "Calibration functions").

Then, the effective value of the calibration weight (DEF. n.nnn g) must be entered with up to tenfold precision compared with the balance.

! NOTE

If calibration is carried out with the free weight, then only this weight may be used.

Then proceed as follows:

Display	Key	Step
		The balance is in Weighing mode.
	«T»	Press until „CALIBRATION“ appears.
		The balance carries out a Zero measurement „0000 g“ is shown flashing).
		After the zero measurement the display flashes with the previously entered calibration weight.
		Place the calibration weight. The display continues to flash.
		Calibration is complete when the display stops flashing

14.3.3 Internal calibration

For internal calibration with the built-in calibration weight „SET CALIBRATION MODE INTERNAL“ must be selected in the Configuration menu (see chapter 8.3.5 "Calibration functions").

Then proceed as follows:

- Switch to „WEIGHING“ with the Change key
- Press «T» until „CALIBRATION“ is shown.
- Calibration is finished after a certain period of time

14.3.4 Automatic calibration

For automatic calibration with the built-in calibration weight „SET CALIBRATION MODE AUTO“ must be selected in the Configuration menu (see chapter 8.3.5 "Calibration functions").

The balance now calibrates itself automatically every 24 hours and/or after each temperature change of 3 degrees Celsius, depending on the definition in the Configuration menu „SET CALIBRATION MODE AUTO“.

The time of the automatic calibration is as determined in the Configuration menu under „SET CALIBRATION

■ 14 Service

AUTOCAL. -TIME n h". (e.g. 6 h for 06.00 o'clock in the morning)

! NOTE

For automatic calibration by time and by time/temp. the date and time of the balance must first be correctly set (see chapter 8.3.8 "Date and time").





Calibration can also be effected manually at any time when auto-calibration is activated.

Automatic calibration then takes place only if no weight has been placed on the pan for at least five minutes.

It is recommended that the time for auto-calibration be set outside the normal business hours (for example, in the early morning).

14.4 Automatic Repeatability Test (ART)

During the Automatic Repeatability Test, the internal weight is measured 10 times, and the standard deviation is calculated from this and logged.

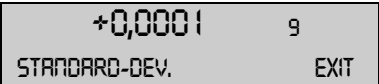
Display	Key	Step
		<i>The balance is in Weighing mode.</i>
	«T»	<i>Press until „REPEATABILITY TEST“ appears.</i>
		<i>The internal weight is applied and measured. 10 measurements are performed.</i>
	«↓»	<i>If required, the measuring program can be exited.</i>
		<i>The standard deviation of the measurement is calculated and displayed as a result, and the log is printed.</i>

14.5 Software update

Our balances are instruments which are being continuously advanced and improved. For this reason, it is possible to update to the latest version of the instrument software via the internet.

In order to update your software, you need to download the Download Tool from the website and install it onto a PC (Windows 95 or higher) with a serial interface.

The software for the balance can also be downloaded from the Downloads area on the website. This can then be loaded into the instrument with the aid of the download tool.

System requirements

- PC Windows 95 or higher
Serial data cable, depending on the PC's serial interface (see Accessories).

Installation of the download tool

- Download the Download Tool from the Downloads area on the website and install it onto your PC.
- Once the program has been successfully installed, you can start updating the balance software.

Balance software download

- Download the software for the balance from the website under Downloads and save it on your own PC.
- Connect the balance to the PC via the data cable and switch it on.
- Start the installed Download Tool.
- Open „downloaded balance software“ under the menu option „File“.

- Start the software update.
- The software has been updated once the message „Download successful“ appears.

15 Menu trees

15.1 Configuration menu tree

• UNIT-1		
UNIT-1	g mg kg ... Bht	
• SET DATA PRINT		
	AUTOSTART ON/OFF	
	MODE UNSTABLE STABLE LOADCHANGE CONTINUOUS TIMEBASE	
	TIMEBASE 2.0	
	SET PRINTFORMAT	DATE AND TIME ON/OFF BALANCE-ID ON/OFF PRODUCT-ID ON/OFF GROSS AND TARE ON/OFF UNITS ON/OFF USER ON/OFF LINEFEED OFF /1/2/..9/FORMFEED
	PRODUCT ttt...	
	PRODUCTMODE HOLD DELETE COUNT	
• SET CALIBRATION		
	MODE OFF EXTERNAL EXT.-DEF. INTERNAL AUTO	
	DEF. 0.000 g	
	AUTOCAL. TIME/TEMP. TEMPERATURE TIME	
	AUTOCAL.-TIME 6 h	
• SET WEIGHING MODE		
	FLOATINGDISPLAY 0.08 0.16 0.32	
	STABILITY LOW MEDIUM HIGH	
	AUTO-STANDBY OFF 0.5 MIN 1 MIN 5 MIN 10 MIN	
	AUTO-ZERO ON/OFF	
	QUICK-TARE ON/OFF	

• SET INTERFACE	
	BAUDRATE 300 600 1200 2400 4800 9600 19200
	PARITY 7-EVEN-1STOP 7-ODD-1STOP 7-NO-2STOP 8-NO-1STOP
	HANDSHAKE NO XON-XOFF HARDWARE
• SET DATE AND TIME	
	TIME [HH.MM.SS]
	DATE [DD.MM.YY]
	FORMAT STANDARD/US
• THEFTCODE	
THEFTCODE ----	THEFT-PROTECTION OFF/ON
	NEW CODE - - - -
• KEY TONE	
KEY TONE	ON/OFF
• LANGUAGE	
	LANGUAGE ENGLISH SPRACHE DEUTSCH LANGUE FRANCAISE
• CONTRAST	
CONTRAST	6

15.2 Application menu tree

• SET APP.	
	OFF
	UNITS
	COUNT
	PERCENT
	CALCULATOR
	PAPER
	NET-TOTAL
	SUM
	ANIMAL
	etc.

*Other applications available.
Refer to the Application Operating Instructions for the description.*

• SETUP APPLICATION	

*Division depends on the current application.
(see chapter 8.5 "Application menu")*

• SET STATISTIC	

MODE	OFF STATISTIC RECORDER STAT./RECORDER
COUNT	100
RECORDING	MANUAL TIMEBASE LOADCHANGE
TMEBASE	2.0

• SET CHECK +/-	

MODE	ON/OFF
NOM.	100.000 g
TO	120.000 g
TU	80.000 g

• AUTO-START	
AUTO-START	ON/OFF

• SET USER	

USER	ttt...
NEW PASSWORD	- - - -
CLEAR USER	