

NMEA 0183 (ver 2.0) Accepted Input Sentences

| Formatter | Description |
|-----------|---|
| BWC | Bearing and Distance to Waypoint |
| BWR | Bearing and Distance to Waypoint, Rhumb Line |
| DBT | Depth Below Transducer |
| DPT | Depth |
| GGA | Global Positioning System Fix Data |
| GLL | Geographic Position, Latitude/Longitude |
| RMA | Recommended Minimum Specific Loran-C Data |
| RMB | Recommended Minimum Navigation Information |
| RMC | Recommended Minimum Specific GPS/TRANSIT Data |
| VHW | Water Speed and Heading |
| VLW | Distance Travelled through the Water |
| VTG | Track Made Good and Ground Speed |
| ZDA | Time and Date |

NMEA 0183 (ver 2.0) Output Sentences

All sentences accepted by the FLS Platinum are also output.

Depth & log sentence information output from the unit will depend on the depth and log source selected. If the depth & log sources are set to local, then the depth and log sentences output will be the internally calculated depth/log data.

Sentences are output at 2 second intervals.

**We hope you enjoy using your ECHOPILOT FLS PLATINUM
WE ARE ALWAYS PLEASED TO TALK TO OUR CUSTOMERS.**

Information in this document is subject to change without notice. No part of this document may be reproduced or transmitted in any form or by any means, electronic or mechanical, for any purpose, without the express written permission of EchoPilot Marine Electronics Ltd.

Copyright © 2005 by EchoPilot Marine Electronics Ltd. All rights reserved.

Protected by USA Patent 5530680 and European (UK) Patent 0624253

Author: Paul Beeston
Last Updated: 29.11.2017 (Johnny Christensen)

For up to date information and advice, please telephone, browse our Website, or send us an E-Mail.

**e-mail: sales@echopilot.com
website: www.echopilot.com**

FLS PLATINUM FORWARD LOOKING SONAR INSTRUCTIONS

Daniamant 
Be safe at sea

ECHOPILOT 

DANIAMANT ELECTRONICS A/S

**Industrivej 24C,
3550 Slangerup, Denmark
Telephone: 0045 47373800
E-Mail: sales@echopilot.com /
service@echopilot.com
Webpage: www.echopilot.com**

Thank you for purchasing this Echopilot instrument.

Your new EchoPilot instrument has been manufactured to the highest standards by the dedicated staff of a company with many years of experience in marine electronics. You have invested in the most up to date technology available and in a product rigorously tested in the laboratory and at sea.

All goods of our manufacture are backed by a 2 year warranty. Expert advice and guidance is always available by Telephone +45 4737 3800 - just ask for customer service. If you are outside the UK you can still call us or any of our overseas distributors. We welcome the opportunity to talk to our customers.

Nobody enjoys reading manuals, but please continue to read this one! Installing your instrument correctly is vital to get the maximum performance, pleasure and safety from your equipment, so please take the time to read the instructions.

Please observe the following warnings:

Please do not cut the transducer cables - they are fine multi-core cable matched to the transducer.

Please do not remove the transducer plug from its cable - if a hole is too small make the hole bigger! Any join in the cable will reduce sensitivity / performance.

Disclaimer

Echopilot makes no warranty as to the accuracy or completeness of data that is included or may be downloaded or used in connection with this product, and EchoPilot disclaims any and all express, implied or statutory warranties including the implied warranty of merchantability and implied warranty of fitness for a particular purpose. It is the user's responsibility to use this product prudently. This product is intended to be used only as a secondary aid to navigation and must not be used for any purpose requiring precise measurement of distance, depth, location, or topography.

| | |
|----------------------------------|-----------|
| Operating Instructions | 4 |
| Switching on | 4 |
| Keypad Operation - Overview | 5 |
| Operating Modes | 5 |
| Changing the Unit Settings | 11 |
| Operating a Repeater Unit | 15 |
| How FLS Technology Works | 16 |
| Some Guidance on Use | 17 |
| Installation Instructions | 18 |
| Transducer Installation | 18 |
| Wiring Diagrams | 21 |
| Fitting the Transmitter Box | 22 |
| Applying Power | 23 |
| Maintenance | 23 |
| Fault Finding | 24 |
| Technical Specification | 25 |
| Technical Drawings | 26 |

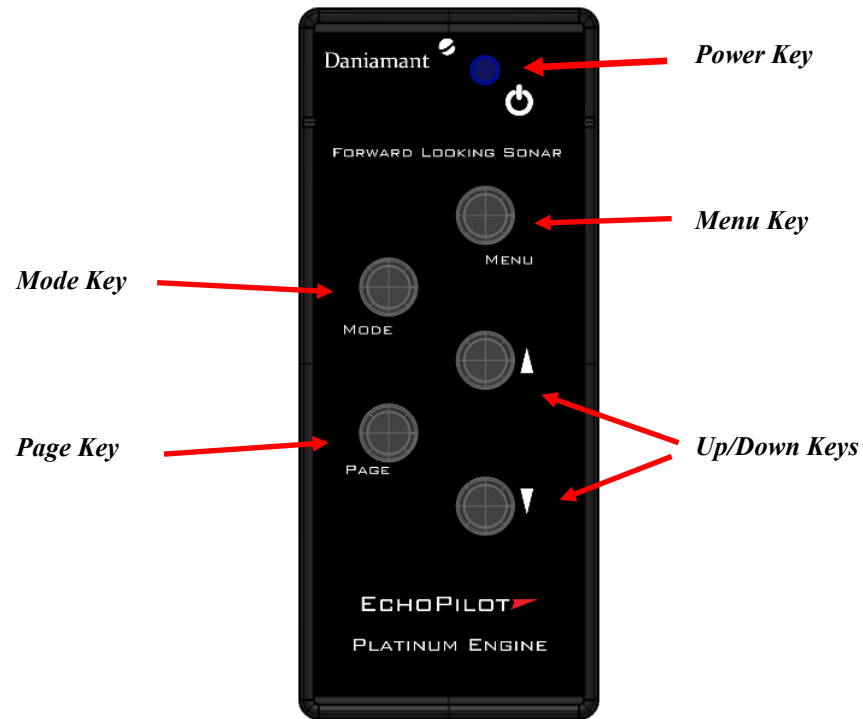

Switching On

The FLS Platinum is switched on by pressing and holding the power key until a single beep is heard. The unit will then display the introduction screen that includes the unit software version, shortly followed by the FLS sonar display.

The sonar data displayed on the screen will depend on the sea bed below the transducer. The unit will always switch on in 'Auto Range' mode which means that if a good seabed signal is received, a suitable range will be chosen for the current depth. Pressing the up or down arrows will turn off auto mode and the user will now have control of the range with the up and down arrows.

Keypad Operation - Overview

Power Key: Switches the unit on and off.

Menu Key: Selects the menu which allows the user to modify the unit settings. See the section **Changing the Unit Settings** for more information on the menu.

Up/Down Keys: When in FLS Mode (sonar data displayed), changes the sonar range up or down accordingly. When in the menu, the up and down arrows change the selected option. See the section **Changing the Unit Settings** for more information on the menu.

Mode Key: Cycles between FLS mode, GPS mode and Test Mode. When in the menu, the mode key returns the user to the current mode. See the relevant sections for more information on each mode.

Page Key: When in FLS mode, changes the information displayed in the information bar at the bottom of the screen. See **FLS Mode** section for more information. When in Test Mode, cycles through three test screens that will aid in testing the unit and provide diagnostic information. See **Test Mode** section for more information. The page key has no effect in GPS Mode. See **GPS Mode** section for more information.

Operating Modes

FLS Mode

FLS Mode is the sonar operating mode that displays the sonar image of the seabed ahead and below the transducer. There are eight forward range settings (20m, 40m, 60m, 80m, 100m, 150m, 200m and Auto) that are selectable with the up and down arrow keys. When the upper range is reached with the up arrow (200m), a further press puts the unit onto the 'Auto' range. Similarly, when the lower range is reached with the down arrow, a further press puts the unit onto the Auto range. A press of either arrow key while Auto is on will switch the Auto off and the user will retain manual control of the range.

When returning to manual range, the range selected will be the last range selected by the Auto function until the user presses an arrow key to change range.

Auto Range

When Auto range is selected, the range will automatically be set, based on the current digital depth (displayed in bottom left hand corner). If the digital depth is invalid due to a poor sonar signal (indicated by the depth figure flashing) the range will remain on the last selected range for a valid depth. The status indicator box in the top right hand corner of the display shows whether Auto range has been selected.

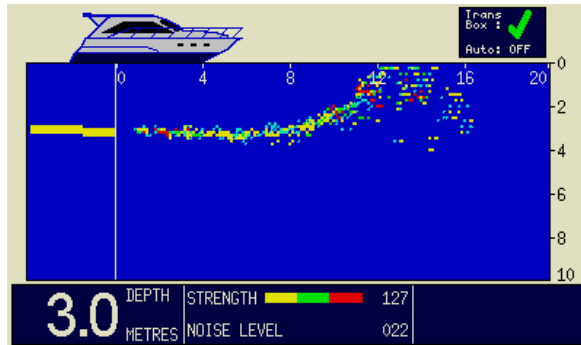

The sonar display in FLS Mode

Status Indicator Box

This box is displayed in the top right hand corner of the screen in FLS Mode and shows that the Transmitter Box is connected and is communicating with the display correctly. A green tick indicates a successful connection and a red cross indicates that the transmitter box is not properly connected (no power to the transmitter box and/or not connected to the display unit).

The status indicator also shows whether Auto Range is on or off.

History Display

The FLS Platinum displays a 15 second history to the left of the vertical line (0m line) on the sonar display. The history plot is based on the digital depth readout and gives the user a little more information about the shape of the seabed behind the vessel.

As the history plot is the last 15 seconds of seabed, the area of seabed covered will depend on the speed of the vessel. For example, if the vessel speed is 5 knots (2.5 metres per second), then the history plot will cover a distance of 38m. Higher speeds will give greater distances but with less accuracy.

Transmitter box

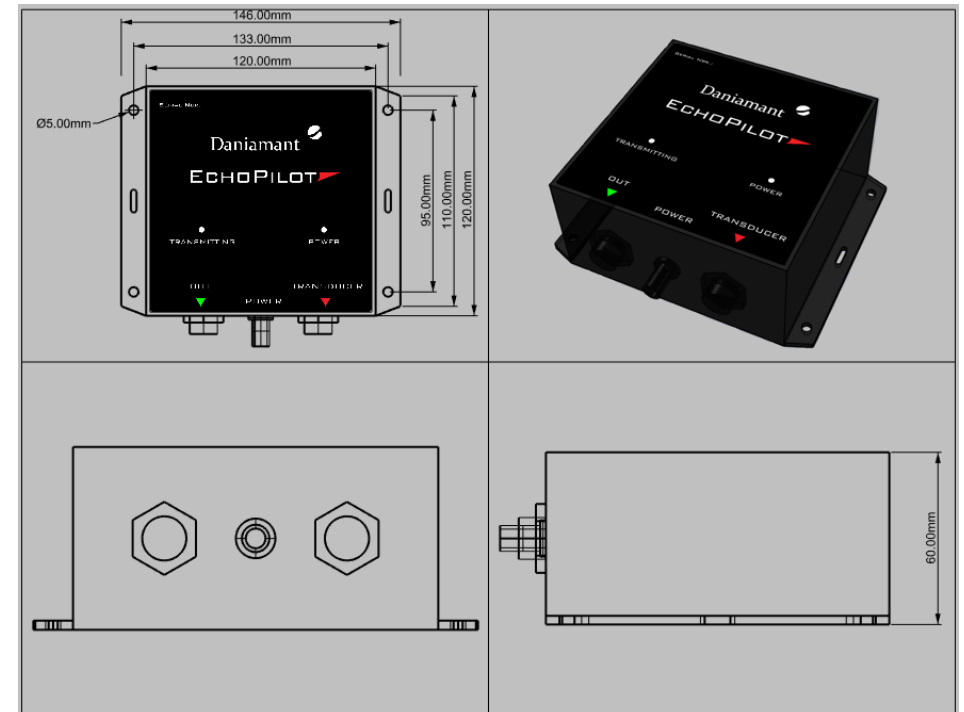

Video Interface

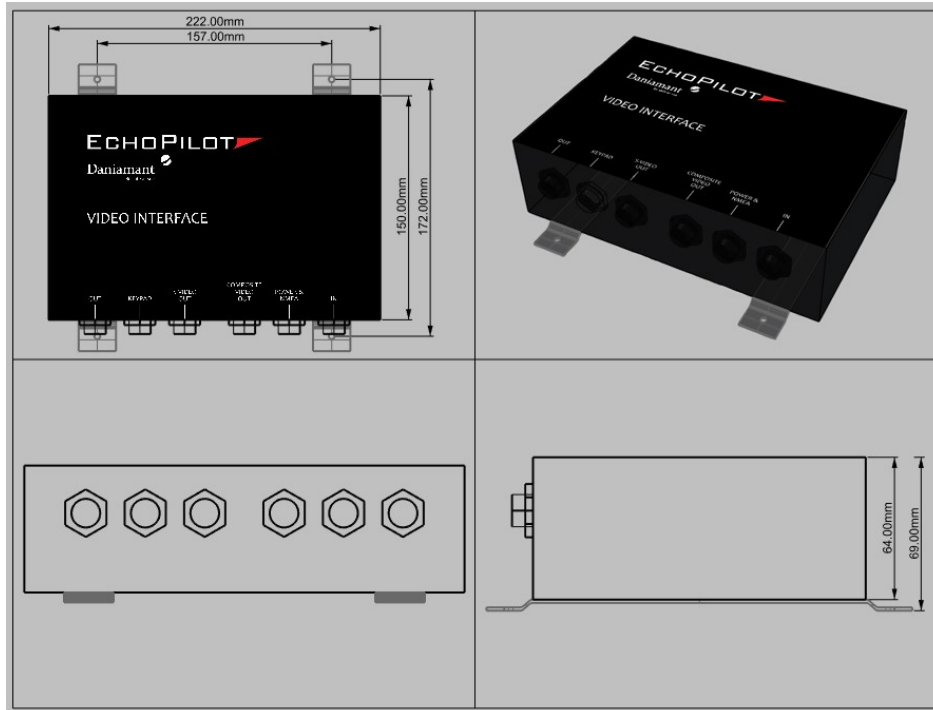

Do under no circumstances unscrew the two mounting brackets !

Information Window

This is the window at the bottom of the display and displays the current depth and other optional information. Pressing the page key will scroll through a number of combinations of this information, the combinations also being dependent on whether GPS or Log displays are turned off in the menu.

The possible combinations of information are:-

- *Depth Only*
- *Depth + Echo Strength*
- *Depth + Speed (log displays enabled)*
- *Depth + Speed + Log (log displays enabled)*
- *Depth + Speed + Echo Strength (log displays enabled)*
- *Depth + GPS (GPS displays enabled)*
- *Depth + Speed + GPS (log and GPS displays enabled)*

Speed and log info can only be displayed if either a paddle wheel transducer is connected to the display unit (speed through the water) or a GPS is connected to the unit (speed over the ground). The source of the speed is selected in the menu.

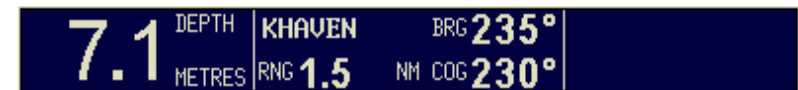

The GPS info box displays waypoint information if it is available from a connected GPS. If no data is available or no GPS is connected, the fields are shown as above.



The Echo Strength Indicator displays the average peak strength of received echo over the last 4 pings. The coloured bar will increase in length as the strength increases and the colour of the bar will change at certain thresholds.

FLS PLATINUM OPERATING

If the bar is yellow, the signal is weak and there is likely to be no (or extremely poor) seabed picture displayed.

If the bar increases to green, the signal is above the acceptable threshold level to generate a seabed picture. The picture may be slightly disappointing at this level.

If the bar increases to red, the signal is very good and the seabed picture should also be good.

GPS Mode

The GPS mode requires an external GPS to be connected and allows the user to view GPS data such as:-

- *Current position (Lat/Long)*
- *Current time (UTC + offset)*
- *Speed and course over the ground (COG and SOG)*
- *Waypoint info (ID, cross track error (XTE) + steer direction, range and true bearing to waypoint)*

The depth is also displayed in GPS Mode.

| GPS DATA | |
|-------------------|--------------------|
| POS: FIX | TIME: 16:37:21 |
| LAT: 50°43.900'N | LONG: 001°30.000'W |
| SOG: 5.1 KTS | COG: 230° |
| WPT: KHAVEN | XTE: 0.1 NM R |
| RNG 1.5 NM | T.BRG 235° |
| DEPTH: 7.1 METRES | |

GPS Mode data including depth

FLS PLATINUM - TECHNICAL SPECS

| Specification | FLS Platinum |
|------------------------|---|
| Voltage | 12v or 24v DC |
| Current Consumption | Display-700mA with max brightnes (300 mA min) Transmitter Box - 50mA |
| Operating frequency | 200 kHz |
| Display type | 3rd party |
| Viewing Area | Depending on display type |
| Forward Range | 20 to 200 metres |
| Maximum Depth Range | 10 to 100 metres |
| Display Update Rates | 1-2 updates / sec |
| NMEA | 0183 Version 2.0 |
| Built-in Test Facility | Yes |
| Repeater Option | Yes |
| Alarm | Shallow |
| Transducers | FLS Platinum professional |

FLS PLATINUM - FAULT FINDING

Some Common Faults

Display or transmitter box doesn't switch on (no display or LEDs lit):-

- Battery not connected
- Battery voltage too low

Transmitter box LED not flashing:-

- No power to display unit or display not switched on
- 12m data cable not connected properly
- Power not cleanly applied to transmitter box - re-make connection

No seabed visible and transmitter box LED is flashing:-

- Transducer not connected (or not connected properly) - use Test Mode
- Incorrect range selected (try using the 'Auto' setting!)

Poor seabed picture or excessive noise:-

- Suitable range not selected (try to fill screen with seabed)
- Poor connection of transducer
- Battery voltage low - use Test Mode to check Tx voltage
- Transducer mounted at an angle
- Turbulence at transducer location
- Interference from other 200KHz sounders (same boat or other boats)
- Turbulence/wake from other boats
- Polluted water or Plankton bloom (usually early summer)
- Dirty transducer/covered with barnacles
- Choppy sea state - can cause surface noise

FLS PLATINUM OPERATING

Test Mode

This mode allows the user to obtain diagnostic data about the unit should a fault occur with the display, transmitter box or transducer. The page key scrolls between 3 test pages.

A-Scan and Angle Graphs

These graphs display the sonar signal strength and associated calculated angles over a 30m range. If the depth is greater than 30m, these graphs will not show the received seabed echo and angle of the seabed.

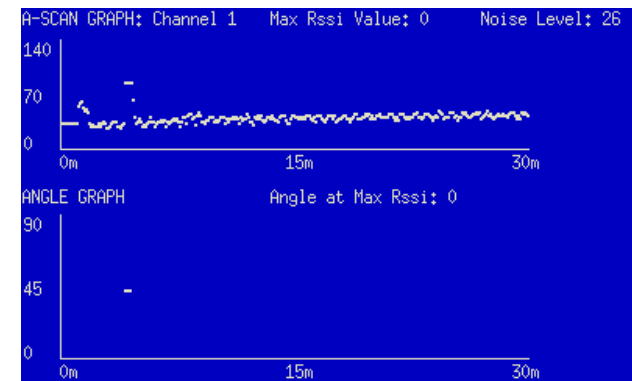

The A-Scan and Angle Graphs

The A-scan graph of a flat seabed will show a low signal level up to the depth of the seabed and should then increase significantly to a higher level when the seabed is reached. This is the returned echo from the seabed. The angle graph will show angles between 0 and 90 degrees. The angles should start at about 60-70 degrees at the seabed depth and will decrease gradually as the range of the received echo increases (for a flat seabed).

The up arrow key allows the user to scroll between the 3 receive channels (A-Scan graph only). Each channel must be displaying similar A-Scan graphs for the angle to be calculated correctly. Low or very different echo levels on any of the 3 channels will cause poor performance of the FLS unit.

FLS PLATINUM OPERATING

Diagnostics

This screen displays some diagnostic information about the unit. It shows the software version of both the transmitter box and the display, the status of the communications link with the transmitter box, the transmitter dc voltage supply and also tests the settings memory on the display (EEPROM).

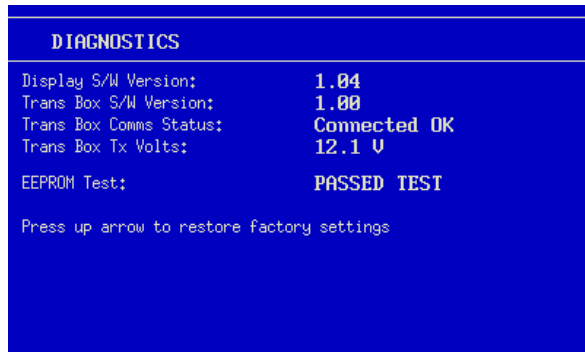

| DIAGNOSTICS | |
|--|--------------|
| Display S/W Version: | 1.04 |
| Trans Box S/W Version: | 1.00 |
| Trans Box Comms Status: | Connected OK |
| Trans Box Tx Volts: | 12.1 U |
| EEPROM Test: | PASSED TEST |
| Press up arrow to restore factory settings | |

Diagnostic Data

'Trans Box Comms Status' should read 'Connected OK'. Any other messages mean an error has occurred on the communications link with the transmitter box. If this is the case, the user should ensure that the transmitter box has power and the data link cable is connected securely at both ends (transmitter box and display).

'Trans Box Tx Volts' should read approximately 12 Volts. If the transmitter box supply voltage is at exactly 12 Volts, then the Tx Volts should be about 9-10 Volts. This will result in slight reduced performance but should still perform well. If 14 Volts or more are supplied to the transmitter box, maximum transmit power will be achieved.

Factory settings can be restored by pressing the up arrow key on this page.

FLS PLATINUM INSTALLATION

Interference

Other depth sounders especially those that operate at 200 kHz must be wired so they can be switched off if interference occurs. (This may appear as 'submarine' like echoes coupled with a reduction in sensitivity).

Applying Power

When power is applied to the FLS Platinum system, 2 LEDs on the transmitter box show the status of power and the communications link to the display unit.

The left LED shows power is reaching the box and this should be lit as soon as power is applied to the transmitter box.

The right LED should also light upon applying power to the transmitter box. If successful communication with the display is made, the LED will flash to show that the display unit is in FLS Mode and that the transmitter box is receiving transmission requests from the display. If this LED is not flashing, check that the display has power connected and is switched on - and that the 12m data cable is connected properly at both ends.

Maintenance

Keep transducer 'O' rings and locking ring thread well greased with a silicone grease. Protect plugs and cables from chafe. Clean the transducer face regularly and check for barnacles etc. With care, this may be done afloat. If you have never done this before, phone us first! You may anti-foul the transducer. Avoid long term exposure of the LCD to direct sunlight.

FLS PLATINUM INSTALLATION

Fitting the Transmitter box

The transmitter box should ideally be mounted on a vertical surface, within reach of the transducer cable (2m) and protected from excessive moisture.

Plugs and sockets

The 2m transducer cable (8 pin plug) connects to the right hand socket of the transmitter box marked **TX**.

The pre-wired (5 pin) 12m cable is connected from the left hand socket on the transmitter box marked **OUT** to the right hand socket (viewing display from the rear) marked **IN** on the display unit. An optional repeater can be connected with a second 12m cable connected to the **OUT** connector on the master unit and the **IN** connector on the repeater unit.

The short cable for the power supply and NMEA (in and out) plugs into the centre (8 pin) socket on both the master unit and the optional repeater unit. If NMEA is required on the Repeater unit, a cable for carrying NMEA data from the master to the Repeater unit is also required.

Power is also required for the lower transmitter box and should be supplied through an on/off switch (not supplied) mounted conveniently near the display. Power may be 12 or 24 Volts.

The transmitter box draws approximately 50mA of current when power is applied, even when the display is switched off. Therefore, power should be removed via the switch when not in use.

An optional paddle wheel for water speed may also be attached to the 8 pin cable on the master unit if required.

Please refer to the wiring diagrams on page 21 for further details on connecting up the video interface and transmitter box.

FLS PLATINUM OPERATING

NMEA Viewer

This page allows incoming data from a GPS or other NMEA compatible instrument to be viewed to ensure that the NMEA connection is correct and that the appropriate sentences are being received. 4 pages can be scrolled using the up arrow keys to view all the sentence types that the unit can receive and whether any data is being received.

Each line under each sentence type is in field order as specified in NMEA 0183 ver 2.0.

Changing the Unit Settings

A simple menu system allows the user to change the unit settings. Pressing the menu key while in any of the display modes enters the menu, presenting the following page:-

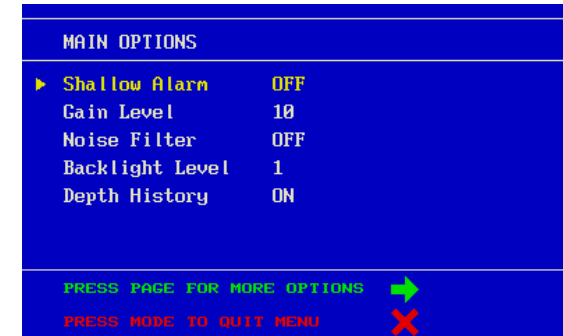

The desired menu option is chosen using the menu key. When the arrow cursor is alongside the appropriate option, pressing the up or down arrow keys changes the setting.

Pressing the page key presents the user with another set of options. There are 4 menu pages:

- *Main Options*
- *Display Options 1*
- *Display Options 2*
- *Depth and Log Options*

The unit will return to the sonar display after 10 seconds if no buttons are pressed

FLS PLATINUM OPERATING

within that time. Alternatively, the user can return to the sonar display by pressing the mode key.

Shallow Alarm

The Shallow Alarm can be set to Off or 1m to 20m. When a certain number of echoes occur above this setting, an alarm will sound (1 second on, 1 second off). The alarm setting is retained after power down.

The shallow alarm is provided as a guide to warn the user that echoes are appearing above the set level. It should be noted that in some conditions (particularly in noisy sonar conditions) the alarm may be triggered by echoes from the sea surface (in choppy water), or turbulence generated by other vessels. As experience is gained with the FLS, the user should be able to identify this kind of noise.

Gain Level

The gain level controls the amount of sonar signal level accepted by the FLS. The higher the value, the more signal will be accepted and give a stronger echo on the display - but will also increase the amount of noise that will show. A lower value will filter more of the signal and reduce the amount of noise - but will give a weaker echo on the display. Max is recommended for most uses.

Noise Filter

This setting allows the user to reduce the amount of 'clutter' on the sonar display. The filter lever sets the number of times an echo must occur within a similar location before it is displayed.

Setting the filter to off means that echoes only need to appear once in order to be displayed. This gives much more detail and responsiveness on the display but will also increase the amount of noise displayed (from air bubbles for example) which is more random. The low, medium and high settings increase the filter gradually and hence reduce the responsiveness and number of echoes displayed.

The off setting is recommended as a starting point for most users.

Depth History

Allows the user to switch on or off the depth history display.

Key Bleep

Allows the user to switch on or off the key bleep

Colour Mode

6 colour modes are provided to allow a choice of colour sets to be selected by the

FLS PLATINUM INSTALLATION

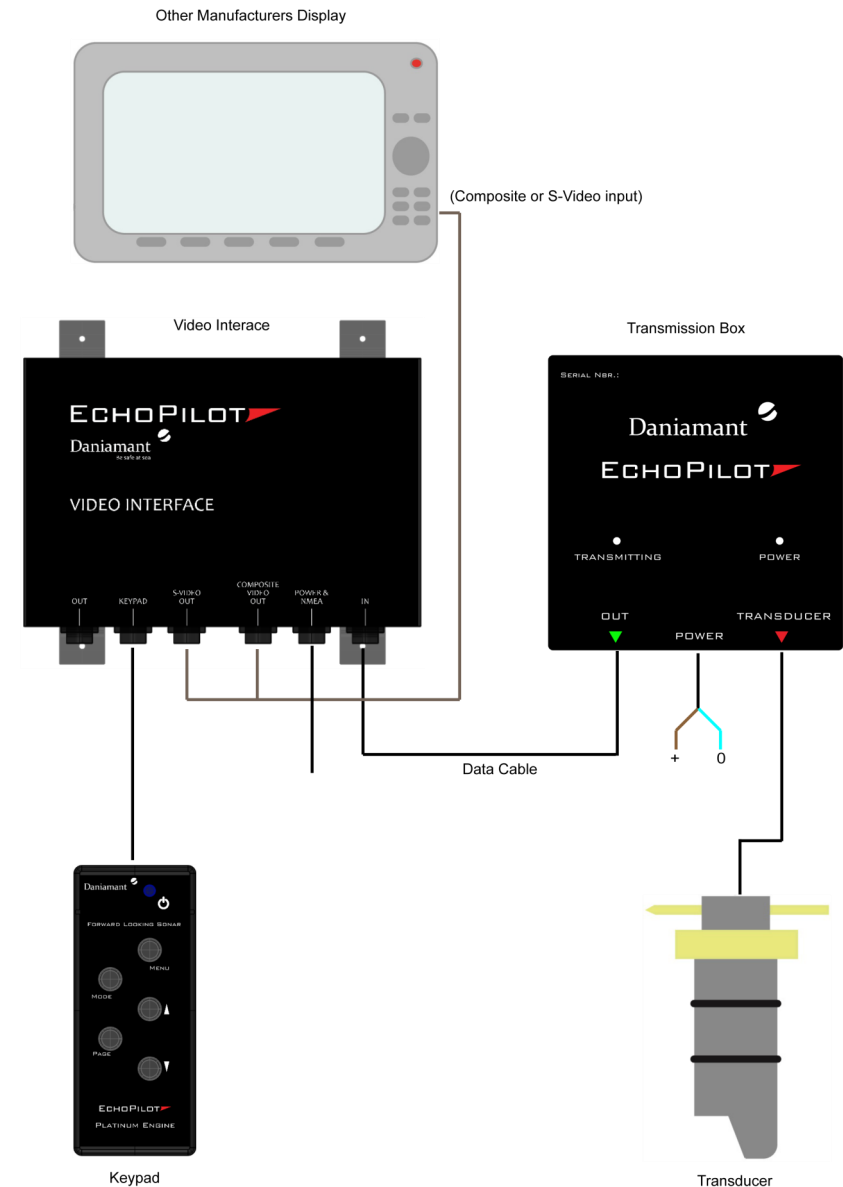

FLS PLATINUM INSTALLATION

Fitting the Skin Fitting

A hole in the boat must be taken seriously! - If in doubt use an experienced shipwright.

- For the Log plastic skin fitting - cut a 45 mm (1 3/4") diameter hole.
- For the Professional bronze skin fitting - cut a hole 60 mm (2 1/2") in diameter.
- Fit the skin fitting with reinforcing pads if needed or wedges if required to ensure the transducer is as near to vertical as possible (fore/aft AND port/starboard).
- Use plenty of underwater sealant, but take care to clean off the thread thoroughly afterwards.
- Secure with the nut on the inside. Do not use excessive force on the nut.
- If the vessel will be floated **before** the transducer is fitted, the blanking cap provided must be fitted to seal the skin fitting. (N.B. for our American customers, for "skin fitting" read "thru-hull fitting").

Safety

The transducer provided is designed to shear off (in the event of a severe impact), flush with the hull, leaving the solid epoxy filled portion in the through hull fitting, and thus poses no risk of water ingress.

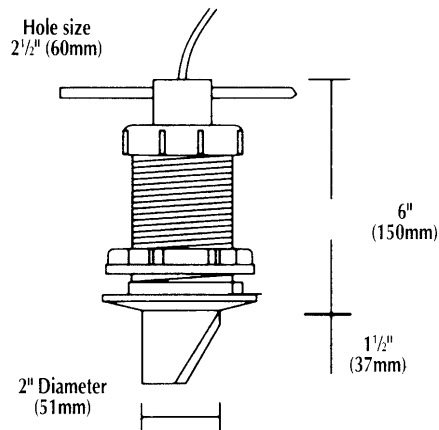

**Professional
Transducer**

FLS PLATINUM OPERATING

user. 3 sets are for daytime use (light background colours) and 3 for night-time use (dark background colours).

Echoes Colour

The echoes displayed in FLS Mode can be either strength encoded or 'mono'. Strength encoded echoes use colours to show strength variations between echoes - with red being the strongest echo, then green, then yellow, then light blue for the weakest echoes. Mono colour selects a single suitable colour that all echoes will be displayed as, depending on the colour mode chosen.

Boat Length

Allows the user to set the displayed boat length to match their own boat (up to a maximum of 20m).

Boat Type

3 boat types are available to the user: 2 motor boats and 1 sailing boat.

Bow Offset

This is the distance from the boat's bow to the transducer position and allows the user to obtain a more realistic picture of the seabed with respect to the vessel.

GPS Displays

Allows the GPS displays to be switched off in the information window in FLS Mode. This reduces the number of combinations that can be cycled through.

Log Displays

Allows the speed and log displays to be switched off in the information window in FLS Mode. This reduces the number of combinations that can be cycled through.

UTC Offset

Allows an offset to be applied to the received UTC time so that the local time can be displayed in GPS mode.

Language

Allows one of the currently available languages to be selected for unit operation.

Depth Source

Allows either local (FLS transducer) or NMEA to be chosen as the depth source. If NMEA is selected, the depth data will be searched for automatically in the incoming NMEA data.

FLS PLATINUM OPERATING

Depth Units

Units can be set to Metres or Feet.

Depth Offset

The Depth Offset can be set from -3.0m to +3.0m. If the offset is positive, the set offset will be added to the calculated depth below transducer to give depth below the surface. If the offset is negative, the set offset will be subtracted from the calculated depth below transducer to give depth below the keel.

This offset only applies to the digital depth readout in the bottom left hand corner of the display and NOT the graphical seabed picture.

Log Reset

Pressing the up or down keys will reset the current log trip distance.

Log Source

Allows either local (paddle wheel) or NMEA to be chosen as the log source. If NMEA is selected, the speed/log data will be searched for automatically in the incoming NMEA data. NMEA STW (speed through water) searches for speed through water data in the appropriate sentences. NMEA SOG (speed over ground) searches for speed over ground data in the appropriate sentences.

Log Units

Units can be set to either Knots, KPH or MPH.

Log Cal.

The optional Log transducer supplied with the FLS Platinum produces pulses which are proportional to the speed of the boat. It is these pulses which give you your speed. However, due to boat hull design, the water flow at the sensor can be faster or slower than the actual water speed of the boat. The FLS Platinum allows for the log speed, trip and total trip displays to show between 20% - 250% of the actual log sensor reading.

Operating a Repeater Unit

A repeater display unit is identical to a master display unit and operates in exactly the same way. The repeater unit will treat the master unit as a transmitter box and will communicate with it in the same way as it would a transmitter box.

It should be noted that changing range on a repeater unit will be independent of the master unit so they may both be on different ranges (unless both units are set to Auto Range). However, it is the range selected on the master unit that will dictate

FLS PLATINUM INSTALLATION

Sailing Boats

On a fin keeled boat, alongside the keel and perhaps 60cm or 2 feet out - because the beam is approximately 15 degrees overall in the horizontal plane, is often a well protected position. But this is unsuitable for a winged keel or large bulb as the signal from the transducer could impinge on these. Just forward of the keel is an alternative, but take care when hoisting the boat in a sling!

Do not fit the transducer too far forward where it will come out of the water as the vessel pitches. The transducer looks ahead as well as down and you need to see what is under your boat as well as what is ahead. When manoeuvring in shallows you will wish to know what is under the keel or rudder.

A long keel boat is harder, choose the position with the minimum angle of deadrise (ie the flattest area) and fit the transducer with a pair of wedge shaped chocks if necessary, so that it is as near to vertical as possible with the boat upright. On boats with slack bilges it may be necessary to fit the professional transducer, even on a small vessel, because its skin fitting has more useable thread. If the transducer leans forward the seabed will appear to slope up and if it leans aft there may be surface clutter.

Choose a position with good access so that the transducer can be withdrawn for cleaning if necessary.

Remember that sonar cannot see around corners, so stand under the boat with your head near the proposed position. You must be able to see from your toes up to above the horizontal ahead. If the boat has a full or deep forefoot obstructing the view a more forward position may be called for.

FLS PLATINUM INSTALLATION

Transducer Installation

The choice of transducer position will have a major effect on final performance so please consider carefully all factors and if in any doubt, telephone the factory.

Motor Boats

On a small planing hull fit the transducer as far aft as reasonably possible. On a stern drive boat (inboard or outboard) typically fit just in front of the engine(s). On a shaft driven boat (not V drive) forward of the shaft log or stern gland, but behind the gearbox. On larger vessels fit further forward to increase effective range.

Keep inboard of the lower spray rail if possible.

Do not fit downstream of any other through hull fittings (for example intakes, log, toilet sea cocks etc) and choose a location with good access for withdrawing the transducer for cleaning.

The transducer should ideally be vertical in the fore and aft plane at running trim. If it leans forward the seabed will appear to slope up, and if it rakes aft then a degree of surface clutter may show. Some heel to port or starboard is acceptable, to a maximum of 5 degrees.

Avoid the temptation to fit the transducer too far forward as it may then be out of solid water when at speed or pitching. Also remember the transducer looks down as well as ahead, so when manoeuvring in shallow waters you may wish to see there is water for the propellers and rudders.

Sonar cannot see around corners so before installing stand under the boat with your head near the proposed position and check that you can see from your toes up to above the horizontal ahead. If the boat has a full or deep forefoot and is shallow aft a forward mounted transducer maybe necessary.

FLS PLATINUM OPERATING

the transmission pulse length set by the transmitter box and also the A-Scan channel displayed in Test Mode.

A master unit and a repeater unit will be interchangeable so that if a fault should occur in the master unit for any reason, the repeater may be used as a direct replacement.

Demo Mode

To enter demo mode, ensure the unit is switched off first. Then press and hold the power button until a second beep is heard. The sonar display should appear with one of the 3 demo seabeds. 'Demo Mode' will appear in the Status Indicator box in the top right hand corner of the display.

Pressing the up or down arrow key will cycle the demo display around 3 demo screens. The menu is operational but some settings will have no effect in demo mode. In particular, shallow alarm (although the alarm bell will be shown), gain level, noise filter, colour mode and echoes colour will not work in demo mode.

HOW FLS TECHNOLOGY WORKS

Sonar Beam

The EchoPilot FLS is a unique and patented invention. It can see through a full arc of 90 degrees, from straight ahead to straight down.

The transducer has a fairly narrow horizontal beam of approximately 15 degrees (port to starboard). In practice, as sensitivity reduces with distance (especially at the edges of the beam), the polar diagram looks more like an elongated balloon.

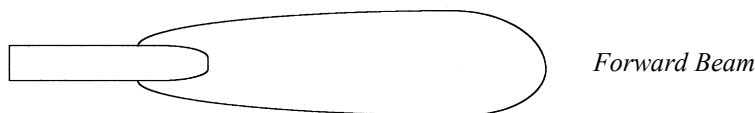

Distance Ahead

The distance ahead that the FLS can see depends on the depth of water below the vessel, and the laws of physics. The transmit 'ping' radiates at all angles down and out from the vessel, hits the sea bed and some of it is returned to the transducer's receiver.

As the 'ping' travels further away from the boat, it hits the sea bed at an increasingly acute angle. At a certain point the angle will be so acute that the 'ping' is not returned, and the sea bed information is lost - this determines the maximum view ahead.

When on a flat muddy bottom (e.g. river or estuary) the FLS will show the seabed up to three to five times the depth away from the boat. This ratio increases to eight to nine times if the seabed shoals upward. Rocky bottoms are better targets than muddy ones, and hard vertical surfaces like quay walls, rocks or coral reefs will often be seen at considerable distances.

SOME GUIDANCE ON USE

The Digital Depth Display

This ADDITIONAL information (in the bottom left-hand corner) is the calculated depth from the angle data that is received and processed by the FLS. Unlike older FLS models, the depth can now be calculated regardless of the selected range and therefore can be useful for the user in selecting the correct range. The depth relies on a good quality sonar signal and care should be taken in poor sonar conditions (e.g. turbulence from passing boats or another sounder running at the same frequency causing excessive noise). Care has been taken to prevent false depth readings in noisy sonar conditions but cannot be guaranteed in all conditions.

Practice

When learning to interpret the screen practise with clear targets, e.g. a quay wall. Try moving around an obstruction very gently to see what the maximum range is that different targets become visible.

!!!! WARNING !!!!

If approaching a target select a range longer than you think you need. Most people (including us!) seriously underestimate distances to quays, buoys, walls etc.

Note that going astern can push turbulence past the transducer reducing sensitivity or sometimes obliterating all the picture so take care! Manoeuvre with the minimum use of astern (reverse) power, especially with the propeller (on twin screw vessels) on the side of the transducer.

Turbulence from other vessels, especially in shallow water can also adversely affect performance. Algae (normally in spring), Plankton and pollution can all show up as 'noise' on the screen.

Operating the FLS Platinum at Speed

Ultrasonic signals travel well through solids and liquids but are greatly attenuated in air. It follows that a stream of turbulence and air bubbles will limit the performance of the FLS system, or any depth system for that matter. However, if a place can be found on the hull where there is a clear flow of water, then good results can be obtained even at speed.