

# Cast Iron Performance

WOODBURNING • MULTI-FUEL • GAS • ELECTRIC





# Cast Iron Performance

Dovre takes its company name from a range of Norwegian mountains, and has more than 60 years' experience in manufacturing stoves and fireplaces for the harshest of Arctic winters.



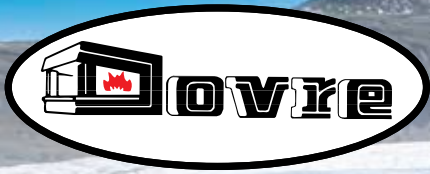

# The Dovre Range...



## Traditional Wood & Multi-fuel Stoves.....6 - 21

A comprehensive collection of classically designed stoves, incorporating the unmistakable atmosphere of a real log or smokeless fuelled fire. From the compact 250 to the grander 760CB, that true traditional ambience can be perfectly attained in rooms of all sizes.

## Vintage Contemporary Wood Stoves.....22 - 27

For those with a more contemporary taste, the eye-catching Vintage range with distinctive retro styling, brings woodburning stoves right into the heart of modern living.



## Astroline Contemporary Wood & Multi-fuel Stoves..... 28 - 41

With superb modern styling, the Astroline series of woodburning & multi-fuel stoves takes the design of cast iron stoves into the 21st Century. The high elevations make a bold style statement but they also permit extra heating capacity.

## Contemporary Wood & Multi-fuel Cassette Fireplaces.....42 - 45

Designed to create a striking centrepiece at the very heart of your home, Dovre cassette fireplaces impress with their high levels of heating efficiency and clean geometric lines. With a double-sided cassette your fire can even be enjoyed from two rooms at once!



## Traditional Wood & Multi-fuel Insert & Canopied Fireplaces.....46 - 55

At home in both traditional and contemporary homes this collection of fireplaces can be built either into a fireplace or combined with optional canopies to create a stunning centrepiece for large fireplace openings and inglenooks.

## Traditional Gas Stoves ..... 56 - 59

With their traditional styling, Dovre Gas stoves combine the classic atmosphere of a real log or coal stove with the added convenience and ease of a modern gas fire. They can also benefit from the latest optional remote control systems that allow complete control from the comfort of your sofa.



## Traditional Electric Stoves .....60 - 63

There are two models in the range, incorporating our unique VeriFlame™ technology, and boasting a choice of glow and flame effects, individually hand-painted logs and full remote control. With superior realism and up to 2kW of heat output, a Dovre Electric stove will always be a pleasure to come home to.



# The Dovre Difference...

## Durable and Reliable

Cast iron has many advantages – durability, better heat retention and longevity, as well as the ability to be crafted into a huge variety of shapes and textures, giving aesthetic beauty and immediate appeal whether your interior style is traditional or contemporary.

Over the decades, Dovre's product range has been continuously developed and refined. Today, its woodburning and multi-fuel stoves offer advanced cleanburn technology for improved combustion efficiency and care for the environment. Its airwash systems help keep the door glass clean, whilst there are also many models fuelled with the convenience of gas or electricity.

Whatever your choice - wood, multi-fuel, gas or electric - your Dovre stove or fireplace will be beautifully reliable and built to the uncompromising standards you would expect from our Scandinavian heritage.

## Wood and Multi-fuel Stoves and Fireplaces

Dovre stoves and fires are designed to burn wood and smokeless fuels and have been independently tested to exacting standards for safety, heating efficiency and emissions. The 250, 225, 525, 500, 700 and Vintage models have also been approved for the burning of wood in Smoke Control areas\*.

**Wood** – Wood is the better fuel in environmental terms being carbon neutral, as the amount of carbon dioxide released into the atmosphere is approximately the same as that absorbed by the tree during growth. It is also a renewable resource, particularly when derived from plantations and cultivated woodland. For optimum results, we recommend logs should be seasoned for 2 years or more to achieve a moisture content below 20%†. This will not only give up to twice the output of freshly felled timber but help avoid a build up of tar in your flue. Furthermore, if you can obtain hardwood logs this is better still, as they will have around twice the calorific value of softwoods, of equivalent weight.



**Solid fuels** – anthracite and manufactured smokeless fuels can be burnt on multi-fuel models which feature a fixed or riddling grate. Please note, however, that bituminous coal or petroleum based fuels must never be used on your stove.

## Gas Stoves

All Dovre gas stoves are available with natural gas or LPG and, depending on model, feature a highly realistic coal or log effect fire.

These highly efficient stoves are available as manual operation and



have the option to upgrade to either a standard remote, allowing heat regulation once the pilot light has been lit manually, or a programmable remote with additional thermostatic and timer controls.

## Electric Stoves

A Dovre electric can be as easy to install as plugging in and

switching on! Both the 280 and 425 feature our unique VeriFlame™ technology with low energy LED illumination and hand painted fuel bed.

With the heater discreetly located underneath, plus feature a remote control allowing you to adjust the heat between off, 1kW and 2kW in addition to the VeriFlame™ effects which can run without any heat at all.



## Warranty Information

Your Dovre retailer will provide you with a Five Year Warranty for your new stove castings and a Two Year Warranty on steel parts and gas and electric 'engines' used in stoves and fires. Full details are on our website at [www.dovre.co.uk](http://www.dovre.co.uk)



\*250, 225, 525 & Vintage stoves are approved when fitted with a Smoke Control Kit.

†All efficiencies quoted in this brochure are for seasoned wood with a moisture content of less than 20%







## Expert Retailer Network

We take great care to ensure that our stoves and fireplaces are designed, tested and manufactured to the highest possible quality and safety standards. We are just as concerned to make certain that they are sold and installed correctly so that you enjoy years of pleasure from your purchase.

Accordingly, you will find our products are only available from experienced, independent retailers who will be happy to show you a selection of models locally in their showrooms, often fully operational. These independent retailers will discuss your individual requirements both technical (such as sizing the heat output to your room and advising on your flue type) and design; and ensure that you select the most appropriate product for your home. They will also be able

to advise on or assist with the installation process as well as help provide any after-sales support and servicing of your appliance that you may require in the future.

Whilst we encourage our retailers to promote fireplace products and their outlets via the internet, we do not believe suitable levels of customer care and satisfaction can be obtained from nationwide online sales and we would strongly recommend that you consider this when undertaking your research and making a purchasing decision. Further, please be aware that we do not offer technical support (beyond our statutory responsibilities) to products bought via nationwide online sales, where this support would normally be offered by one of our qualified, independent retailers.



Astroline 3CB with Pedestal

# 250

## Multi-Fuel & Wood Stoves



Dovre 250CBW with short leg option

### PRODUCT CODES

DV-250CBS	Matt black woodburner with cleanburn and airwash systems
DV-250CBW	Matt black woodburner/smokeless fuel with cleanburn
DV-250	Matt black multi-fuel with riddling grate and airwash system
DV-250BLK	Black enamel multi-fuel with riddling grate and airwash system
DV-250MJB	Majolica Brown enamel multi-fuel with riddling grate and airwash system
DV-250IV	Ivory enamel multi-fuel with riddling grate and airwash system
DV250SCKIT	Smoke control kit

### FINISHES



Traditional  
Matt Black



Majolica  
Brown enamel



Ivory  
enamel



Black  
enamel

The Dovre 250 multi-fuel is designed to suit a huge range of applications from a cottage kitchen to a modern town-house living room, especially as it is approved for smoke control areas. It has a large glass door panel and ornately cast side panels both adding to the visual appeal. Manufactured from only premium grade cast iron, the 250 is at home whether burning wood (logs up to 30cm long may be used) or a variety of solid fuels, and is equipped with a sophisticated airwash system to keep the door glass cleaner. Matt black woodburning and woodburning/smokeless fuel versions with cleanburn for improved heating efficiency are also available. Shorter legs are an option on the 250CBW model.

- All cast iron construction
- Woodburning or multi-fuel versions
- Airwash system
- DV-250 approved for Smoke Control Areas†
- Colour matched enamel flue pipe also available
- Maximum heat output: 4.9kW
- High efficiency: up to 77%
- Top or rear flue exit
- Flue diameter: 125mm
- Weight: 79kg

†When fitted with a Smoke Control Kit







# 425

## Multi-Fuel & Wood Stoves



Dovre 425 multi-fuel stove in Black enamel

### PRODUCT CODES

DV-425CBW	Matt Black woodburner with cleanburn
DV-425	Matt Black multi-fuel with riddling grate and airwash system
DV-425BLK	Black enamel multi-fuel with riddling grate and airwash system
DV-425MJB	Majolica Brown enamel multi-fuel with riddling grate and airwash system
DV-425IV	Ivory enamel multi-fuel with riddling grate and airwash system

### FINISHES



Traditional  
Matt Black



Majolica  
Brown enamel



Ivory  
enamel



Black  
enamel

Available in a selection of deep enamel finishes as well as traditional matt black, the Dovre 425 has the style and performance to bring a warming glow to many a home. The woodburning version features Dovre's latest Cleanburn system whilst the multi-fuel version, complete with riddling grate, is capable of burning a variety of solid fuels or logs and incorporates an airwash system to help keep the window clean.

- All cast iron construction
- Woodburning or multi-fuel versions
- Airwash system
- Colour matched enamel flue pipe also available
- Maximum heat output: 8kW
- High efficiency: up to 83%
- Top or rear flue exit
- Flue diameter: 150mm
- Weight: 130kg
- Gas and Electric versions also available, see pages 58 - 59 and 62 - 63





# 500

## Woodburning Stove



Dovre 500 woodburning stove

### PRODUCT CODES

DV-500CBW Matt Black woodburner with cleanburn

### FINISHES



Traditional  
Matt Black

The Dovre 500 is a masterpiece of casting proficiency and up-to-date technology. Not only does it offer classic stove appeal but it also features a separate ashpan door, for easier removal of ash. This dedicated woodburning stove, incorporates a special cleanburn system that is so effective it has been approved by the Department of the Environment for use in smoke control areas.

- All cast iron construction
- Woodburner
- Airwash system
- DV-500CBW approved for Smoke Control Areas
- Colour matched enamel flue pipe also available
- Maximum heat output: 8kW
- High efficiency: up to 79%
- Top or rear flue exit
- Flue diameter: 150mm
- Weight: 118 - 124kg







Dovre 500 with clear door, shown with Pembroke warm white mantel available from Stovax.

Dovre 640CB woodburning stove. Shown with Claremont antique white marble mantel available from Stovax.





# 640CB

## Woodburning Stove

This well-proportioned stove features a side loading door as well as a front glass door and separate ashpan door. The side door allows logs of up to 50cm in length to be loaded into the stove so that less sawing is required when owners are providing their own timber. There is also a cleanburn system for improved fuel efficiency, an airwash system to help keep the door glass clean and a choice of top or rear flue outlets.

- All cast iron construction
- Woodburner
- Cleanburn and Airwash system
- Side door for loading
- Maximum heat output: 9kW
- High efficiency: up to 79%
- Top or rear flue exit
- Flue diameter: 150mm
- Weight: 158kg



Dovre 640CB woodburning stove

### PRODUCT CODES

DV-640CBW Matt Black woodburner with cleanburn and airwash

### FINISHES



Traditional  
Matt Black









# 700

## Multi-fuel & Wood Stoves

Like the woodburning version of the Dovre 500, the larger 700CBW also incorporates special cleanburn technology that is so efficient the Department of the Environment has approved it for use in smoke control areas. There is also an airwash system to help keep the panoramic window clean.

Alternatively, you can select the 700 multi-fuel. This model has a fixed grate that is perfect for burning smokeless fuels or logs and also includes Dovre's airwash system to ensure you enjoy the best possible view of your fire, as well as a useful side door for the loading of longer logs.

- All cast iron construction
- Woodburning or multi-fuel versions
- Airwash system
- DV-700CBW approved for Smoke Control Areas
- Maximum heat output:  
11kW (CBW) / 12kW (MFF)
- High efficiency: up to 75%
- Top or rear flue exit
- Flue diameter: 150mm
- Weight: 180kg (CBW)/175kg (MFF)



Dovre 700MFF

### PRODUCT CODES

DV-700CBW	Matt Black woodburner with cleanburn and airwash
DV-700MFF	Matt Black multi-fuel with fixed grate and airwash system

### FINISHES



Traditional  
Matt Black



APPROVED FOR SMOKE  
CONTROL AREAS



# 760CB

## Woodburning Stove



Dovre 760CB

### PRODUCT CODES

DV-760CBW Matt Black woodburner with cleanburn and airwash

DV-AIRKIT-K01 Outside air kit

### FINISHES



Traditional  
Matt Black

Big brother to the Dovre 640CB, the 760CB is a truly impressive stove. It features Cleanburn and Airwash systems, a side loading door as well as a glass front door, separate ashpan door and up to 11kW of heat. The side door allows logs of up to 52cm to be loaded – so there is less sawing if you are using your own wood.

- All cast iron construction
- Woodburner
- Cleanburn and Airwash system
- Side door for loading
- Maximum heat output: 11kW
- High efficiency: up to 75%
- Top or rear flue exit
- Flue diameter: 150mm
- Weight: 180kg







# 225

## Multi-Fuel & Wood Stoves



Dovre 225 in Anthracite

### PRODUCT CODES

DV-225CBS	Anthracite woodburner with cleanburn and airwash systems
DV-225MF	Anthracite multi-fuel with riddling grate and airwash system
DV-225SCKIT	Dovre 225, Smoke Control Area Kit (suitable for DV-225MF)

### FINISHES



Anthracite

New to the Dovre range of woodburning and multi-fuel stoves is the distinctive 225. Featuring a square firebox, subtle curving details and compact dimensions, the Dovre 225 is a versatile yet powerful stove that offers style and quality in equal measure.

With a 1950's inspired design, unique detailing and stylish Anthracite finish, the 225 has a fresh look that is at home in both modern and traditional interiors. Incorporating the latest Cleanburn and Airwash technology, this highly efficient stove provides an excellent view of the flame picture through its glass window. The 225 really does combine the best of the past with the technological advancements of the present.

- All cast iron construction
- Woodburning or multi-fuel versions
- Airwash and Cleanburn systems
- Maximum heat output: 4.6kW
- High efficiency: up to 83%
- DV-225MF approved for Smoke Control Areas\*
- Top or rear flue exit
- Flue diameter: 125mm
- Weight: 100kg (WB) / 118kg (MF)
- Maximum log length: 30cm

\* When fitted with a Smoke Control Kit



† Subject to official listing









Dovre 525 stove in Anthracite. Shown with Brompton wooden mantel in white available from Stovax.



# 525

## Multi-Fuel & Wood Stoves

The Dovre 525 is an attractive modern-traditional stove with a 1950's inspired design and outstanding heating efficiency. The tall elegant legs and refined reeding in the side panels accentuate the portrait lines of the firebox creating a real centre piece in your living space. Complemented by distinctive features including the designer door lever, the 525 combines a quality cast iron construction with striking aesthetics.

Available in a smart Anthracite finish, the 525 provides plenty of ambient heat as well as beautiful views of the flames through the generous window that is kept clean and clear by the latest Cleanburn and Airwash technology.

- All cast iron construction
- Woodburning or multi-fuel versions
- Airwash and Cleanburn systems
- Maximum heat output: 8kW
- High efficiency: up to 82%
- DV-525MF approved for Smoke Control Areas\*
- Top or rear flue exit
- Flue diameter: 150mm
- Weight: 120kg (WB)/134kg (MF)
- Maximum log length: 40cm

\*When fitted with a Smoke Control Kit



Dovre 525 in Anthracite

### PRODUCT CODES

- DV-525CBW Anthracite woodburner with cleanburn and airwash
- DV-525MF Anthracite multi-fuel with riddling grate and airwash system
- DV-225SCKIT Dovre 525, Smoke Control Area Kit (suitable for DV-525MF)

### FINISHES



Anthracite



†Subject to official listing







# 30

## Vintage Wood Stoves

With its compact lines and nostalgic retro style, the Vintage 30 may be the smallest in the new Vintage range, but this compact stove will always make a big impact.

The Vintage 30 has been designed with Dovre's Airwash technology to keep your window clean, so you can enjoy the beautiful rolling flame picture to its full potential.

Available in a choice of either an Anthracite or White Enamel finish, the Vintage 30 is supported by four cylindrical legs that match your chosen finish. Alternatively, for something extra special, opt for the tablet stand to increase the visual impact.

- All cast iron construction
- Woodburner
- Airwash system
- Cleanburn technology
- Approved for Smoke Control Areas\*
- Maximum heat output: 5kW
- High efficiency: up to 80%
- Top or rear flue exit
- Flue diameter: 150mm
- Weight: 95kg
- Maximum log length: 30cm

\*When fitted with a Smoke Control Kit



Dovre Vintage 30 in Anthracite

### PRODUCT CODES

DV-VIN30	Anthracite woodburner with cleanburn and airwash
DV-VIN30WH	White enamel woodburner with cleanburn and airwash
DV-TBVIN30	Anthracite tablet stand
DV-TBVIN30WH	White enamel tablet stand
DV-VINSCKIT	Smoke Control Kit

### FINISHES



# 35

## Vintage Wood Stoves



Dovre Vintage 35 in Anthracite with tablet stand

### PRODUCT CODES

DV-VIN35 Anthracite woodburner with cleanburn and airwash  
DV-VIN35WH White enamel woodburner with cleanburn and airwash

DV-TBIN35 Anthracite tablet stand  
DV-TBIN35WH White enamel tablet stand

DV-VINSCKIT Smoke Control Kit

### FINISHES



Anthracite



White enamel

The high efficiency Vintage 35 has a contemporary design which echoes the smooth, distinctive style of appliances from the 1960s and '70s.

The state of the art Cleanburn combustion system and outstanding glass cleaning effects of the Airwash, deliver an impressive flame picture to create the perfect atmosphere in your home. Available in a choice of sophisticated Anthracite or on-trend White enamel finishes, with four cylindrical legs or a stunning tablet stand, there is a Vintage 35 woodburning stove to complement any stylish interior.

- All cast iron construction
- Woodburner
- Airwash system
- Cleanburn technology
- Approved for Smoke Control Areas\*
- Maximum heat output: 7kW
- High efficiency: up to 83%
- Top or rear flue exit
- Flue diameter: 150mm
- Weight: 125kg
- Maximum log length: 35cm

\*When fitted with a Smoke Control Kit

Also see picture on page 75





Dovre Vintage 35 in White enamel.  
Shown with Stovax Ivory Enamelled flue pipe.

Please note: The stove and flue pipe are not designed to be colour matched.







# 50

## Vintage Wood Stoves

The Vintage 50 is the largest woodburning stove in the Vintage range and has a wide, landscape window through which to enjoy the captivating, rolling flames created by Dovre's Cleanburn system, that is so efficient the Department of the Environment has approved it for use in Smoke Control Areas\*.

With 9kW of heating power, the Vintage 50 has the capacity to heat large rooms with ease. Its designer retro looks are perfectly complemented by a choice of either Anthracite or White enamel finishes creating a striking focal point for any interior space. The Vintage 50 is supported by four cylindrical legs, or to make an even bigger style statement, display it on the optional tablet stand.

- All cast iron construction
- Woodburner
- Airwash system
- Cleanburn technology
- Approved for Smoke Control Areas\*
- Maximum heat output: 9kW
- High efficiency: up to 84%
- Top or rear flue exit
- Flue diameter: 150mm
- Weight: 155kg
- Maximum log length: 50cm

\*When fitted with a Smoke Control Kit



Dovre Vintage 50 in Anthracite with tablet stand

### PRODUCT CODES

DV-VIN50	Anthracite woodburner with cleanburn and airwash
DV-VIN50WH	White enamel woodburner with cleanburn and airwash
DV-TBIN50	Anthracite tablet stand
DV-TBIN50WH	White enamel tablet stand
DV-VINSCKIT	Smoke Control Kit

### FINISHES

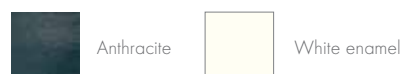









# 1CB

## Astroline Wood Stove

With superb modern styling, the Astroline 1CB takes the design of cast iron stoves into the 21st Century. The high elevations not only represent a style statement but they also permit extra heating capacity, as logs up to 37.5cm in length can be positioned in a 'wigwam' shape and provide up to 10kW of warmth; ideal for larger, open plan living spaces.

Further, the Astroline 1CB features all of Dovre's latest cleanburn technology, including a secondary combustion system to reduce soot emissions and to improve fuel efficiency, whilst a powerful airwash system helps to keep the huge ceramic glass panel clean. Together, they create exceptional flames and a wonderful view of the fire.

- All cast iron construction
- Woodburner
- Cleanburn and Airwash system
- Maximum heat output: 10kW
- High efficiency: up to 78%
- Top or rear flue exit
- Flue diameter: 150mm
- Weight: 140kg



Astroline 1CB

### PRODUCT CODES

DV-ASTBLK Anthracite coloured woodburner with anthracite side panels, cleanburn & airwash system

### FINISHES



Anthracite



# 2CB

## Astroline Wood Stoves



### PRODUCT CODES

DV-ASTRO2/L Anthracite coloured woodburner with anthracite side panels, cleanburn, airwash system and outside combustion air connection

### FINISHES



Anthracite

Smaller sister to the Astroline 1CB and with similar contemporary styling, the Astroline 2CB features the latest cleanburn and airwash technology for impressive heating performance and efficiency. The large ceramic glass panel also provides the superb views and comforting ambience that only a real log fire can bring. For draught reduction, there is a model with built in outside air connection which, if required, can be used to draw combustion air directly into the appliance, not from the room, but from outside.

Pedestal and wood store versions are also available - please see pages 32 - 33.

- All cast iron construction
- Woodburner
- Cleanburn and Airwash systems
- Outside combustion air facility
- Maximum heat output: 8kW
- High efficiency: up to 78%
- Top or rear flue exit
- Flue diameter: 150mm
- Weight: 140kg







# 2CB

## Astroline Wood Stoves

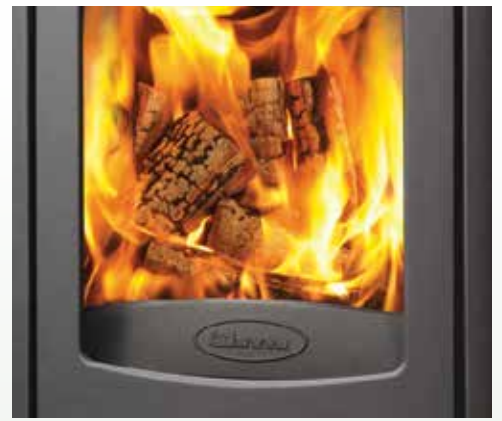

Astroline 2CB with pedestal

### PRODUCT CODES

DV-ASTRO2/P

Anthracite coloured woodburner with pedestal base, cleanburn, airwash and outside combustion air connection

DV-ASTRO2/WB

Anthracite coloured woodburner with wood store base, cleanburn, airwash and outside combustion air connection

### FINISHES



Anthracite

Retaining the same firebox characteristics, heat output and high efficiency of the original 2CB, the Pedestal and Wood Store variants offer two more styling options to attract the eye and make a bigger impact in the room. Whether for taller inglenooks or to stand proudly in the centre of a wall, the stylish 2CB stoves have the versatility to match and punctuate your own contemporary tastes.

For draught reduction, both models have a built in outside air connection which, if required, can be used to draw combustion air directly into the appliance from outside rather than from the room.

- All cast iron construction
- Woodburner
- Cleanburn and Airwash systems
- Outside combustion air facility
- Maximum heat output: 8kW
- High efficiency: up to 78%
- Top or rear flue exit
- Flue diameter: 150mm
- Weight: 158kg











# 3CB

## Astroline Wood & Multi-fuel Stoves

With sleek and contemporary styling, Dovre's new Astroline 3 not only offers you an exceptional view of the fire but also a choice of two distinctive variants as well as either woodburning or multi-fuel versions of each. The state-of-the-art cleanburn combustion system provides stunning flames within the firebox and these can be seen from more than 180° thanks to the angled glass side panels and the large main window. Combustion and efficiency is also aided by an outside air connection which can reduce draughts within your room.

Choose from the Astroline 3CB with a pedestal or, alternatively, the design with a 'wood store' base.

- All cast iron construction
- Woodburning or multi-fuel versions
- Cleanburn and Airwash system
- Outside combustion air facility
- Maximum heat output: 10kW
- High efficiency: up to 75%
- Top or rear flue exit
- Flue diameter: 150mm
- Weight: 158 - 171kg

Also see picture on page 5



Astroline 3CB with pedestal

### PRODUCT CODES

DV-ASTRO3CB/P	Anthracite coloured woodburner with pedestal base, cleanburn and outside combustion air connection
DV-ASTRO3CB/WB	Anthracite coloured woodburner with wood store base, cleanburn and outside combustion air connection
DV-ASTRO3MF/P	Anthracite coloured multi-fuel with pedestal base, riddling grate, cleanburn and outside combustion air connection
DV-ASTRO3MF/WB	Anthracite coloured multi-fuel with wood store base, riddling, cleanburn and outside combustion air connection
DV-HSF3.2	Heat shield*

\*The optional heat shield can be used to reduce the minimum distance to combustible materials by up to half. Please refer to the instruction manual for further details.

### FINISHES

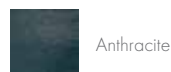

Anthracite



# 4CB

## Astroline Wood & Multi-fuel Stoves



Astroline 4CB with pedestal

### PRODUCT CODES

DV-ASTRO4CB/P	Anthracite coloured woodburner with pedestal base, cleanburn and outside combustion air connection
DV-ASTRO4CB/WB	Anthracite coloured woodburner with wood store base, cleanburn and outside combustion air connection
DV-ASTRO4MF/P	Anthracite coloured multi-fuel with pedestal base, riddling grate, cleanburn and outside combustion air connection
DV-ASTRO4MF/WB	Anthracite coloured multi-fuel with wood store base, riddling, cleanburn and outside combustion air connection
DV-HSF4.1	Heat shield*

\*The optional heat shield can be used to reduce the minimum distance to combustible materials by up to half. Please refer to the instruction manual for further details.

### FINISHES



Anthracite



Similar in looks to the Astroline 3CB, this model is also available in either woodburning or multi-fuel versions and with a choice of pedestal or wood store bases.

Featuring an extensive front window and glass side panels, you are able to enjoy to the full the exceptional swirling flames produced by Dovre's very latest cleanburn system. An external combustion air facility also helps to reduce draughts in the room as well as improve heating efficiency - and with up to 10kW of warmth that's a very cosy thought for any winter's night!

- All cast iron construction
- Woodburning or multi-fuel versions
- Cleanburn and Airwash systems
- Outside combustion air facility
- Maximum heat output: 10kW
- High efficiency: up to 75%
- Top or rear flue exit
- Flue diameter: 150mm
- Weight: 168 - 181kg









# 350CB

## Astroline Wood Stoves

Designed to complement the most modern architecture and interior design, the Astroline 350CB brings its own unique style to the traditional world of stoves. The large flame view area, particularly on the version that has glass side panels, and sophisticated cleanburn will provide you with the home heating pleasure for which Dovre is famed.

- All cast iron construction
- Woodburner
- Cleanburn and Airwash system
- Maximum heat output: 6kW
- High efficiency: up to 81%
- Top or rear flue exit
- Flue diameter: 125mm
- Weight: 110kg



Astroline 350CB/3

### PRODUCT CODES - ASTROLINE 350CB

DV-350CBW Anthracite coloured woodburner with cleanburn and airwash system

### PRODUCT CODES - ASTROLINE 350CB/3

DV-350CB/3 Anthracite coloured woodburner with glass side panels, cleanburn & airwash system

### FINISHES



Anthracite









# 360CB

## Astroline Wood Stoves

Wider than the Astroline 350CB, and with additional heating capacity, this superb stove also features Dovre's very latest cleanburn and airwash technology. So you will enjoy an impressive view of the flames - even more so with the 3 sided version - as well as all the comforts of a real fire.



Astroline 360CB/3

- All cast iron construction
- Woodburner
- Cleanburn and Airwash system
- Maximum heat output: 8kW
- High efficiency: up to 74%
- Top or rear flue exit
- Flue diameter: 125mm
- Weight: 110kg

### PRODUCT CODES - ASTROLINE 360CB

DV-360CBW Anthracite coloured woodburner with cleanburn and airwash system

### PRODUCT CODES - ASTROLINE 360CB/3

DV-360CB/3 Anthracite coloured woodburner with glass side panels, cleanburn & airwash system

### FINISHES



Anthracite





# 2510

## Wood & Multi-fuel Double Sided Cassette Fire



### PRODUCT CODES

DV-2510DSMF	Anthracite coloured woodburner with fan-assisted air circulation
DV-K.10.25D/3	Optional 3 sided frame
DV-K.10.25D/4	Optional 4 sided frame
DV-K2100	Optional multi-fuel basket

### FINISHES



Anthracite

*Note: a standard 13amp domestic electricity supply is also required for this appliance to power the built-in electric fan.*

This superb cassette is a dedicated double-sided design that is ideal for new build and major renovation projects. It offers both excellent heating capacity (complete with thermostat and integral fan unit for quicker warming of the room) and great views of the fire to adjacent rooms using a central flue. The 2510 can burn wood or smokeless fuels and produces up to 9kW of heat.

- All cast iron construction
- Woodburner and multi-fuel option
- Fan-assisted double-sided cassette with thermostatic control
- Maximum heat output: 9kW
- High efficiency: up to 78%
- Flue diameter: 150mm
- Weight: 170kg





# 2520

## Wood & Multi-fuel Cassette Fire



2520 Cassette fire with optional 3-sided frame

### PRODUCT CODES

DV-2520BS	Matt black woodburner with convection system and airwash system
DV-K20.25/3	Optional 3-sided frame
DV-K2100	Optional multi-fuel basket

### FINISHES

	Traditional Matt Black
--	------------------------

*Note: a standard 13amp domestic electricity supply is also required for this appliance to power the built-in electric fan.*

This large bow-fronted cassette features a sophisticated airwash system to ensure you enjoy a superbly panoramic view of the fire. Although a dedicated woodburner, the multi-fuel basket option also allows you to burn smokeless fuels should you wish. Whichever your preference, the 2520 will heat your room with a gentle stream of warm convected air or, by using the integral electric fans, a powerful flow of thermostatically-controlled heat.

- All cast iron construction
- Woodburner and multi-fuel option
- Cleanburn and Airwash systems
- Fan-assisted convection system with thermostatic control
- Maximum heat output: 11kW
- High efficiency: up to 80%
- Flue diameter: 150mm
- Weight: 190kg





SARAH BIBRA





Dovre 1800 fireplace with optional canopy, plinth and side panels



# 1800

## Multi-Fuel Fireplace



Dovre 1800 fireplace with optional canopy, plinth and side panels

### PRODUCT CODES

DV-1800W Matt black multi-fuel

**Accessories** For canopies, base plinths and side panels, see pages 66 & 67

### FINISHES



Traditional  
Matt Black

For smaller fireplaces and rooms, the Dovre 1800 has all the advantages of larger models, including high efficiency and excellent heat output, but with more compact dimensions. The 1800 is also offered with a choice of accessories to help you create your own individual fireplace setting.

- All cast iron construction
- Multi-fuel
- Suitable for use in smaller inglenooks (with optional steel canopy, base plinth and side panels) or as a built-in fireplace
- Suitable for use with a room heating convection system
- Maximum heat output: 8kW
- High efficiency: up to 80%
- Flue diameter: 150mm
- Weight: 75kg



# 2000

## Multi-Fuel Fireplace



Dovre 2000 fireplace with optional canopy and side panels

### PRODUCT CODES

DV-2000MFR Matt black multi-fuel

Accessories For canopies, base plinths and side panels, see pages 66 & 67

DV-DGBS2\* Optional back boiler (1.5kW)

\* Whilst stocks last

### FINISHES

 Traditional Matt Black

Complete with integral riddling grate, the Dovre 2000 fireplace has been designed to burn wood or a variety of smokeless fuels. It also has the option of a back boiler that can provide hot water when the fire is being used.

- All cast iron construction
- Multi-fuel
- Suitable for use in smaller inglenooks (with optional steel canopy, base plinth and side panels) or as a built-in fireplace
- Suitable for use with a room heating convection system
- Maximum heat output: 11kW
- High efficiency: up to 71%
- Flue diameter: 186mm
- Weight: 165kg











Dovre 2300CB fireplace with optional canopy, plinth and side panels



# 2300CB

## Woodburning Fireplace



Dovre 2300CB as a built-in fireplace

### PRODUCT CODES

DV-2300W Matt black woodburner with cleanburn and airwash system

Accessories For canopies, base plinths and side panels, see pages 66 & 67

### FINISHES



Traditional  
Matt Black



As a dedicated woodburner the Dovre 2300CB is equally at home as a built-in fireplace with a sophisticated convection system or in a dramatic inglenook. Open the doors and enjoy the full ambience of a real fire, close the doors and a sophisticated airwash system keeps the glass cleaner for a full view of the fire. With these features and the inclusion of an aerated baffle for greater efficiency and lower emissions, the 2300CB takes crackling log fires into a new era.

- All cast iron construction
- Cleanburn woodburner
- Suitable for use in smaller inglenooks (with optional steel canopy, base plinth and side panels) or as a built-in fireplace
- Suitable for use with a room heating convection system
- Maximum heat output: 9kW
- High efficiency: up to 77%
- Flue diameter: 186mm
- Weight: 150kg









# 2400CB

## Woodburning Fireplace



Dovre 2400CB showing impressive Panorama door

### PRODUCT CODES

DV-2400CB Matt Black woodburner with cleanburn, airwash and bi-fold doors

DV-2400CBPAN Matt Black woodburner with cleanburn, airwash and Panorama door

Accessories For canopy and side panels see pages 66 & 67.

### FINISHES



Traditional  
Matt Black



This model can either be built in to a fireplace or combined with an optional canopy to create a stunning centrepiece for large fireplace openings and inglenooks. With a 9kW capacity and suitable for wood and smokeless fuels, the 2400CB incorporates a state-of-the-art cleanburn system and is offered in either standard or Panorama versions. The standard model features bi-fold doors with four windows whilst the Panorama has a single door with a large, elegantly curved window for maximum view of your fire.

- All cast iron construction
- Cleanburn woodburner
- Suitable for use in smaller inglenooks (with optional steel canopy, base plinth and side panels) or as a built-in fireplace
- Maximum heat output: 9kW
- High efficiency: up to 72%
- Flue diameter: 188mm
- Weight: 130kg





# 2700

## Woodburning Fireplace



### PRODUCT CODES

DV-2700W	Matt black woodburner with airwash system
Accessories	For canopies, base plinths and side panels see pages 66 & 67

### FINISHES



Traditional  
Matt Black

Whether you install the 2700 a part of an inglenook setting or build it into a fireplace this classic Dovre model allows you to enjoy all the character of a real fire with the doors open, or a slower, more efficient combustion with the doors closed. Inserted into a fireplace setting, you can even use the special convection chamber to duct warm air to outlet grilles above the fireplace or even distribute it to other parts of your home.

- All cast iron construction
- Woodburner
- Suitable for use in smaller inglenooks (with optional steel canopy, base plinth and side panels) or as a built-in fireplace
- Suitable for use with a room heating convection system
- Maximum heat output: 10kW
- High efficiency: up to 77%
- Flue diameter: 186mm
- Weight: 135kg









# 280

## Gas Stoves

The 280 Gas blends Dovre's pedigree in casting with the latest gas flame technology. Choose from either realistic coal or log-effect fuel effects, the latter sporting a new glowing ember bed feature for the ultimate real fire ambiance. Both fuel effects are available in conventional flue versions, whilst the log effect is also available in a balanced flue model.

The 280 comes with manual control or, for total ease and convenience, upgrade to one of two command remote controls.

- All cast iron construction
- Balanced and Conventional flue with realistic log-effect fire
- Conventional flue models with coal-effect
- Colour matched enamel flue pipe available
- Optional remote controls
- High Efficiency: up to 81%
- Max. heat output: 3.6kW (CF)/3.5kW (BF)
- Ignition system requires no electricity supply
- Top or rear flue exit: 125mm (CF)/152mm (BF)
- LPG and Natural Gas versions available
- Automatic safety shutdown in the event of pilot light failure or flue blockage
- Weight: 50kg (CF)/54.4kg (BF)
- Electric version available, see pages 60 - 61

### FINISHES

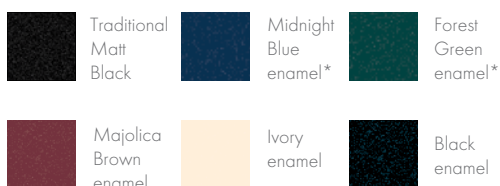

\*While Stocks Last



Dovre 280 Gas conventional flue version with coal-effect fire.

### PRODUCT CODES

#### 280 CONVENTIONAL FLUE WITH LOG-EFFECT FIRE

Natural Gas	LPG
DV541-010	DV541-409
DV541-042	DV541-440
_____	_____
_____	_____
DV541-116	DV541-475
DV541-093	DV541-456

#### 280 BALANCED FLUE WITH LOG-EFFECT FIRE

Natural Gas	LPG
DV541-148	DV541-503
DV541-169	DV541-531
_____	_____
_____	_____
DV541-262	DV541-733
DV541-213	DV541-599

#### 280 CONVENTIONAL FLUE WITH COAL-EFFECT FIRE

Natural Gas	LPG	
DV-280CFNG*	DV-280CFLPG*	Matt Black
DV-280CFNGIV*	DV-280CFLPGIV*	Ivory
DV-280CFNGGR*	_____	Forest Green
DV-280CFNGBL*	_____	Midnight Blue
DV-280CFNGMJB*	DV-280CFLPGMJB*	Majolica Brown
DV-280CFNGBK*	DV-280CFLPGBK*	Black enamel

### HEAT OUTPUT

#### 280 CONVENTIONAL FLUE (LOG-EFFECT)

**Energy Input: Nat. Gas:** 4.55kW, LPG: 4.55kW  
**Heat Output: Nat. Gas:** 3.4kW, LPG: 3.4kW

#### 280 BALANCED FLUE (LOG-EFFECT)

**Energy Input: Nat. Gas:** 4.3kW, LPG: 4.3kW  
**Heat Output: Nat. Gas:** 3.5kW, LPG: 3.5kW

#### 280 CONVENTIONAL FLUE (COAL-EFFECT)

**Energy Input: Nat. Gas:** 4.6kW, LPG: 4.4kW  
**Heat Output: Nat. Gas:** 3.6kW, LPG: 3.2kW

### OPTIONAL REMOTE CONTROLS†



8455: Standard (Left)  
 8456: Programmable (Right)

† Once the pilot has been ignited manually, the Standard remote control allows you to vary the flame height and heat output from your armchair. The Programmable version also enables you to set the stove to switch itself on and off twice a day, to the temperature you select, so that you can wake up or come home to a cosy room and glowing fire.

# 425

## Gas Stoves



Dovre 425 Gas in traditional Matt Black

### PRODUCT CODES

#### 425 CONVENTIONAL FLUE

Natural Gas	LPG
DV-425CFNG	DV-425CFPLPG
DV-425CFNGIV	DV-425CFPLPGIV
_____	_____
_____	_____
DV-425CFNGMJB	DV-425CFPLPGMJB
DV-425CFNGBK	DV-425CFPLPGBK

#### 425 BALANCED FLUE

Natural Gas	LPG	
DV-425BFNG	DV-425BFPLPG	Matt Black
DV-425BFNGIV	DV-425BFPLPGIV	Ivory
DV-425BFNGGR*	_____	Forest Green
DV-425BFNGBL*	_____	Midnight Blue
DV-425BFNGMJB	DV-425BFPLPGMJB	Majolica Brown
DV-425BFNGBK	DV-425BFPLPGBK	Black enamel

### HEAT OUTPUT

#### 425 CONVENTIONAL FLUE

**Energy Input:** Nat. Gas: 6.6kW, LPG: 6.4kW

**Heat Output:** Nat. Gas: 5.3kW, LPG: 5.1kW

#### 425 BALANCED FLUE

**Energy Input:** Nat. Gas: 6.45kW, LPG: 6.1kW

**Heat Output:** Nat. Gas: 5.3kW, LPG: 5.0kW



### OPTIONAL REMOTE CONTROLS†

8455: Standard (Left)

8456: Programmable (Right)

† Once the pilot has been ignited manually, the Standard remote control allows you to vary the flame height and heat output from your armchair. The Programmable version also enables you to set the stove to switch itself on and off twice a day, to the temperature you select, so that you can wake up or come home to a cosy room and glowing fire.

Incorporating up-to-the-minute gas fire technology, Dovre's 425 Gas stove features all the charm and atmosphere of a superb log-effect fire with exceptionally realistic glow and gently dancing flames. It is available in both balanced flue and conventional flue versions. Add to this a choice of six colour options, top or rear flue exits, natural gas or LPG variants and remote control options and you should be able to find the perfect stove for your home.

- All cast iron construction
- Realistic log-effect fire
- Conventional and Balanced flue versions
- Colour matched enamel flue pipe also available
- Optional remote controls
- High Efficiency: up to 80%
- Max. heat output: 5.3kW
- Ignition system requires no electricity supply
- LPG and Natural Gas versions available
- Automatic safety shutdown in the event of pilot light failure or flue blockage
- Top or rear flue exit: 125mm (CF)/152mm (BF)
- Weight: 74kg (CF)/81.5kg (BF)
- Multi-fuel, Wood & Electric versions also available, see pages 8 - 9 and 62 - 63

### FINISHES



\*While Stocks Last











# 280

## Electric Stoves

If you do not have a chimney or want to locate a stove in a space where it would be difficult to install a flue then the electric version of the 280 could be the answer. Once plugged in to a normal 13amp socket, you simply use the remote control to turn it on or off, adjust the heat between the 1kW or 2kW settings or to select one of three flame brightness levels using the unique VeriFlame™ technology. The additional option of a subtle blue flame effect on the highest level makes the stove's 'log' fire one of the most authentic available. It truly is real fire ambience at the press of a button!







Dovre 280 Electric in traditional Matt Black

- All cast iron construction
- Exceptionally realistic log-effect with hand painted fuel bed and logs
- Choose from three brightness levels using unique VeriFlame™ technology
- Flame effect can be operated with or without heat output
- High Efficiency: 99%
- Discreetly concealed fan heater with 1kW and 2kW settings
- Requires no flue, hearth or chimney
- Plugs into standard 13amp socket
- Safe to use in most locations around the home or conservatory
- Can be moved from room to room
- Weight: 50kg
- Gas version also available, see pages 56 - 57

### PRODUCT CODES

DV-280E	Matt Black, log-effect fire
DV-280EIV	Ivory enamel, log-effect fire
DV-280EMJB	Majolica Brown enamel, log-effect fire
DV-280EBK	Black enamel, log-effect fire

### FINISHES

			
Traditional Matt Black	Majolica Brown enamel	Ivory enamel	Black enamel



REMOTE CONTROL  
SUPPLIED





# 425

## Electric Stoves



Dovre 425 Electric in traditional Matt Black

### PRODUCT CODES

DV-425E	Matt Black, log-effect fire
DV-425EIV	Ivory enamel, log-effect fire
DV-425EMJB	Majolica Brown enamel, log-effect fire
DV-425EBK	Black enamel, log-effect fire

### FINISHES



Traditional  
Matt Black



Majolica  
Brown enamel



Ivory  
enamel



Black  
enamel



REMOTE CONTROL  
SUPPLIED

**VeriFlame**  
TECHNOLOGY



Instant glow, instant flames and instant heat, that's the promise of the impressive 425 Electric. You can select from three different flame brightness levels using unique VeriFlame™ technology to provide your ideal style of fire, including the additional blue flame effect on the high setting. There are even reflective sides to ensure the flames appear realistic from all angles so - whether you use the built-in fan heater or not - you can enjoy a perfect picture of warmth at anytime.

- All cast iron construction
- Exceptionally realistic log-effect with hand painted fuel bed and logs
- Choose from three brightness levels using unique VeriFlame™ technology
- Flame effect can be operated with or without heat output
- High Efficiency: 99%
- Discreetly concealed fan heater with 1kW and 2kW settings
- All functions operated from remote control
- Requires no flue, hearth or chimney
- Plugs into standard 13amp socket
- Safe to use in most locations around the home or conservatory
- Can be moved from room to room
- Weight: 74kg
- Multi-fuel, Wood & Gas versions also available, see pages 8 - 9 and 58 - 59



# Canopies

## Plinths & Side Panels

Our range of canopies, plinths & side panels has been specially designed to complement Dovre appliances whether installed freestanding in an inglenook or a recessed fireplace. They are manufactured to the highest standards & help ensure a lifetime of fireside pleasure.

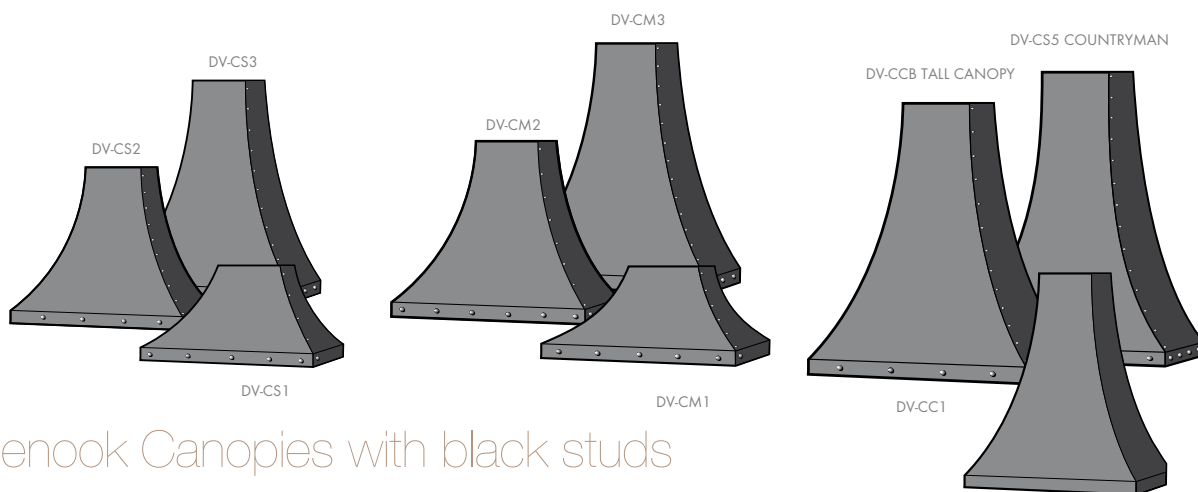

### Inglenook Canopies with black studs

Non-standard heights available to special order. Please allow 3-4 weeks for delivery.

All dimensions are quoted in millimetres

#### 1800 FIREPLACE

CODE	DESCRIPTION	HEIGHT	BASE WIDTH	TOP WIDTH	BASE DEPTH	TOP DEPTH
DV-CM1	Small 1800 Canopy	325	530	260	310	145
DV-CM2	Medium 1800 Canopy	700	685	260	460	235
DV-CM3	Tall 1800 Canopy	950	685	230	460	235

#### 2000 & 2700 FIREPLACES

CODE	DESCRIPTION	HEIGHT	BASE WIDTH	TOP WIDTH	BASE DEPTH	TOP DEPTH
DV-CS1	Small 2700 Canopy	360	710	410	400	260
DV-CS2	Medium 2000/2700 Canopy	685	900	350	570	300
DV-CS3	Tall 2000/2700 Canopy	1070	900	300	560	290

#### 'COUNTRYMAN' FOR 2000 & 2700 FIREPLACES

The Traditional 'olde worlde' styled canopy with heavy, more rugged, black studded strap trim

CODE	DESCRIPTION	HEIGHT	BASE WIDTH	TOP WIDTH	BASE DEPTH	TOP DEPTH
DV-CS5	Countryman Canopy	1070	900	300	560	290

#### 2300CB FIREPLACES

CODE	DESCRIPTION	HEIGHT	BASE WIDTH	TOP WIDTH	BASE DEPTH	TOP DEPTH
DV-CCB	Tall 2300 Canopy	835	820	260	490	235

#### 2400 FIREPLACES

CODE	DESCRIPTION	HEIGHT	BASE WIDTH	TOP WIDTH	BASE DEPTH	TOP DEPTH
DV-CC1	2400 Canopy	805	755	300	535	260



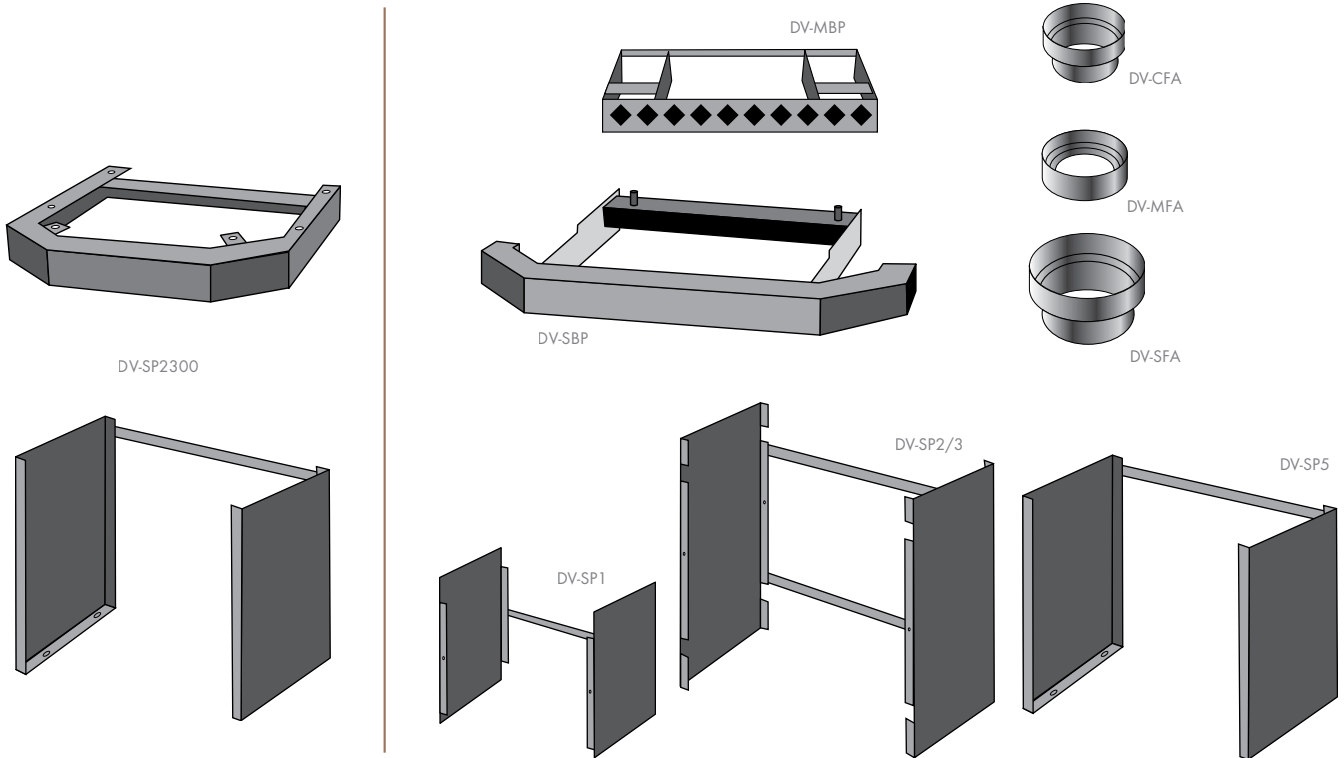

## 1800, 2000, 2400 & 2700 Fireplaces

All dimensions are quoted in millimetres

### PLINTH

Designed to improve convection on appliances used in freestanding installations, base plinths will also enhance the visual appearance of your fireplace

CODE	DESCRIPTION	HEIGHT	WIDTH	DEPTH
DV-MBP	1800 Base Plinth (Black)	80	510	315
DV-SBP	2000/2700 Base Plinth (Black)	80	725	485

### SIDE PANELS UNITS

For use with freestanding type installations where the sides of the appliance may be exposed to view, for example with an extra wide inglenook.

CODE	DESCRIPTION	HEIGHT	WIDTH	DEPTH
DV-SP1	1800 Side Panel Unit (Black)	470	530	290
DV-SP2	2700 Side Panel Unit (Black)	740	720	400
DV-SP3	2000 Side Panel Unit (Black)	780	720	350
DV-SP5	2400 Side Panel Unit (Black)	520	635	400

### FLUE ADAPTORS

CODE	DESCRIPTION	FLUE PIPE DIAMETER
DV-MFA	1800 Flue Adaptor	5 $\frac{1}{4}$ " - 6" (134 - 153)
DV-SFA	2000/2700 Flue Adaptor	7 $\frac{1}{4}$ " - 8" (185 - 204)

## 2300CB Fireplaces

### PLINTH, SIDE PANEL & FLUE ADAPTOR

CODE	DESCRIPTION	HEIGHT	WIDTH	DEPTH
DV-SP2300	Side Panel & Base Plinth kit for 2300CB (Black)	520	670	535
DV-CFA	Flue Adaptor		7 $\frac{1}{4}$ " - 8" (185 - 204)	

# Accessories

To help you get the best performance from your stove or fireplace and keep it in good condition, inside and out, Stovax (Dovre's distributor in the UK and Republic of Ireland) offers a wide range of cleaning and maintenance products. Stovax also supplies a wide variety of fireplace accessories. Your Dovre retailer will be able to give you full details or you may view the complete range at [www.stovax.com](http://www.stovax.com).



## Fireplace, Stove & Hearth Accessories

Included in the brochure is an outstanding selection of fireplace and stove tools. Expertly crafted with a variety of styling options and available in wrought iron, black, brass and chrome finishes, this exquisite range of accessories comprises individual tools alongside complete companion sets. There are also a number of classically designed pails, scuttles and holders for your coals, logs and kindling – functional and stylish accompaniments to your Dovre stove or fireplace.



## Contemporary Steel Log Holders

For more modern interiors, Stovax has developed a range of contemporary log holders in matt black steel. These are highly attractive and a superb pairing to Dovre's range of contemporary Vintage and Astroline series stoves.



## Product Improvement, Safety Information & Warranty

Dovre reserves the right to amend any specifications herein or to make any product design changes. Please note that, due to studio lighting and the limitations of the printing process, colour reproduction of enamel finishes may vary from actual product. Please consult your Dovre retailer for more accurate colours.

Your Dovre retailer will provide you with a Five Year Warranty for your new stove castings and a Two Year Warranty on steel parts and gas & electric 'engines' used in stoves and fires. The continuation of the warranty is dependant on your appliance being serviced by an appropriately qualified person 12 months after installation and annually thereafter. Please note, these warranties exclude certain consumable and naturally wearing parts such as grates, baffles, firebricks and glass. Full details are on our website at [www.dovre.co.uk](http://www.dovre.co.uk) Furthermore, by law all installations also require a Carbon Monoxide Monitor be supplied and fitted.

Please note that all parts of these stoves and fires, particularly the glass panel in the door, become extremely hot during operation and can result in serious injury and burns if touched. It is therefore recommended that a fireguard complying with BS 8423:2002 is used in the presence of young children, the elderly or infirm.

# Flue Pipe

## Matching Enamelled Flue Pipe

For the fully colour co-ordinated installation of your stove, and optimum performance, we offer high quality enamel coloured flue pipe. However, please note that due to the different production processes we cannot guarantee a perfect match between pipe and stove.

The flue pipe diameters required for each model are given on each of the product pages.



	BLACK ENAMEL	MIDNIGHT BLUE ENAMEL	FOREST GREEN ENAMEL	IVORY ENAMEL
<b>127mm diameter</b>				
305mm (1') straight without door	DV-F512BLK	DV-F512BL	DV-F512GR	DV-F512IV
610mm (2') straight without door	DV-F524BLK	DV-F524BL	DV-F524GR	DV-F524IV
915mm (3') straight without door	DV-F536BLK	DV-F536BL	DV-F536GR	DV-F536IV
915mm (3') straight with door	DV-FD536BLK	DV-FD536BL	DV-FD536GR	DV-FD536IV
90° bend without door	DV-FE590BLK	DV-FE590BL	DV-FE590GR	DV-FE590IV
135° bend with door	DV-FED545BLK	DV-FED545BL	DV-FED545GR	DV-FED545IV
Tee + end cap	DV-FT5BLK	-	-	-
125mm - 150mm increaser	DV-F5-6INCBLK	-	-	-
<b>152mm diameter</b>				
305mm (1') straight without door	DV-F612BLK	DV-F612BL	DV-F612GR	DV-F612IV
610mm (2') straight without door	DV-F624BLK	DV-F624BL	DV-F624GR	DV-F624IV
915mm (3') straight without door	DV-F636BLK	DV-F636BL	DV-F636GR	DV-F636IV
915mm (3') straight with door	DV-FD636BLK	DV-FD636BL	DV-FD636GR	DV-FD636IV
90° bend without door	DV-FE690BLK	DV-FE690BL	DV-FE690GR	DV-FE690IV
135° bend without door	DV-FE645BLK	DV-FE645BL	DV-FE645GR	DV-FE645IV

## Professional XQ™ Chimney Systems

Stovax (Dovre's distributor in the UK and Republic of Ireland) also offers a comprehensive range of stove and fireplace chimney systems, the Stovax Professional XQ™ collection. Crafted from 304L grade stainless steel for a durable outer finish, the fully sealed components offer water tight protection for the insulation within.

With innovative decorative options, the ability to specify a colour for your system and with a host of technical advancements such as their Twist-Lock system, the Professional XQ™ range provides an attractive, versatile and reliable solution for your flue system. Furthermore, the Professional XQ™ range carries a 10 year conditional warranty offering complete peace of mind.



For further information or to request a brochure, simply contact your local retailer or visit [www.stovax.com/chimneysystems](http://www.stovax.com/chimneysystems).



# Dimensions

## P6/7 | 250 Wood & Multi-Fuel Stoves

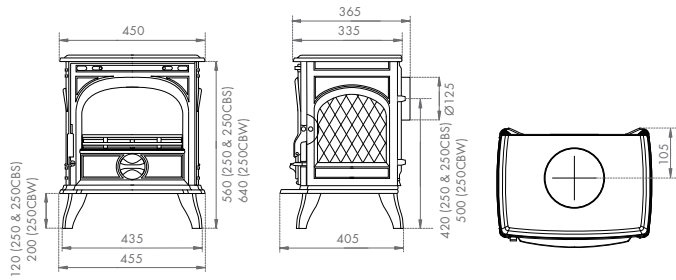

## P16/17 | 760CB Wood Stove

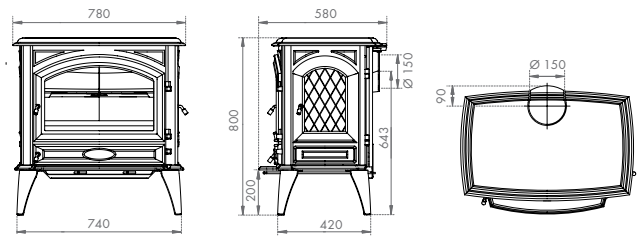

## P8/9 | 425 Multi-Fuel Stoves

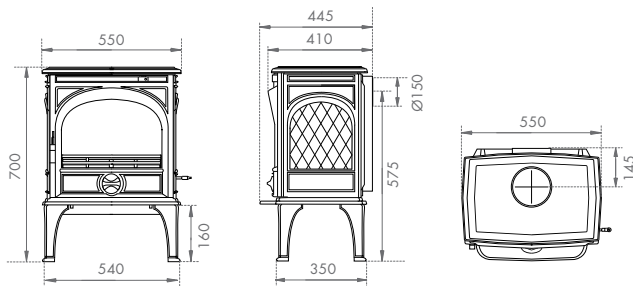

## P18/19 | 225 Wood & Multi-Fuel Stoves

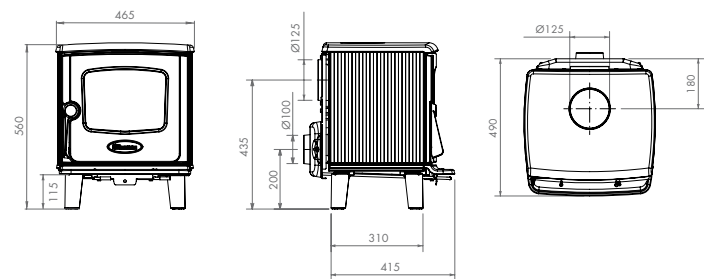

## P10/11 | 500 Wood Stove

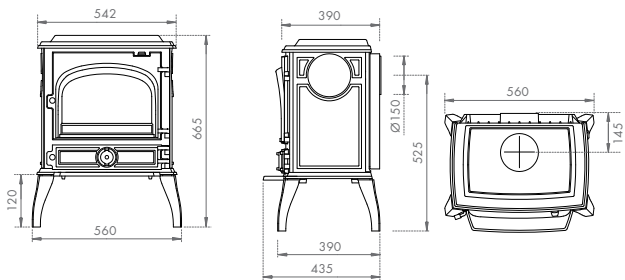

## P20/21 | 525 Wood & Multi-Fuel Stoves

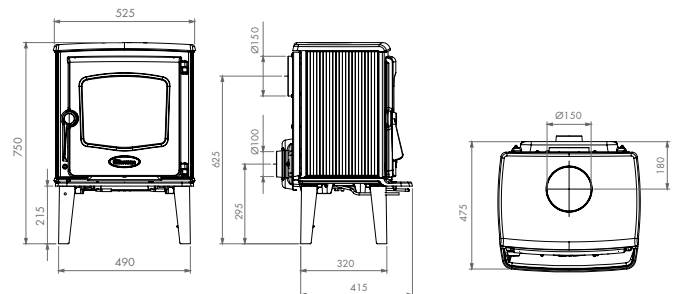

## P12/13 | 640CB Wood Stove

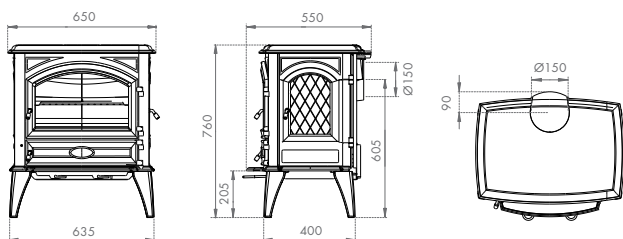

## P22/23 | Vintage 30 Wood Stove

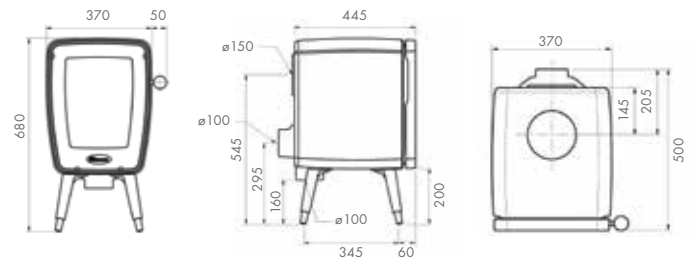

## P14/15 | 700 Multi-Fuel & Wood Stoves

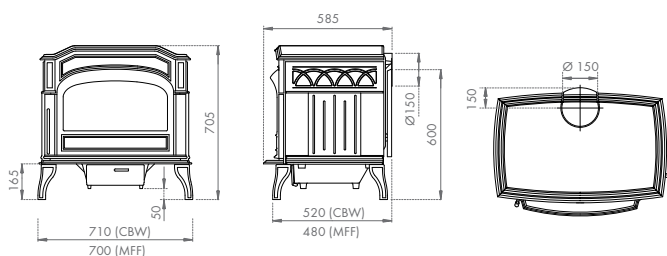

## P24/25 | Vintage 35 Wood Stove

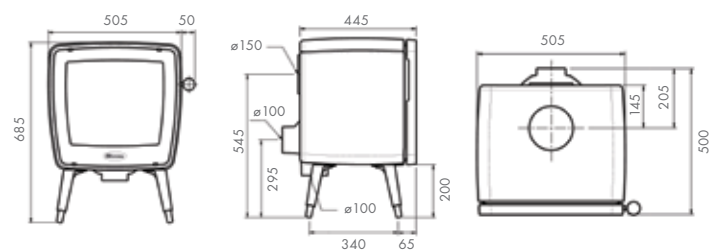

# Correct Installation

A HETAS approved installer should undertake a site survey prior to purchase and must install any Dovre stove or fireplace. Your Dovre retailer will be able to advise on this. The below information is to assist you in your choice of a suitable Dovre fire or stove. It is not intended to be all the information required to install your fire or stove; this can be obtained from your local Dovre retailer or you can view/download the relevant full installation instructions from the Dovre website at [www.dovre.co.uk](http://www.dovre.co.uk)

## P26/27 | Vintage 50 Wood Stove

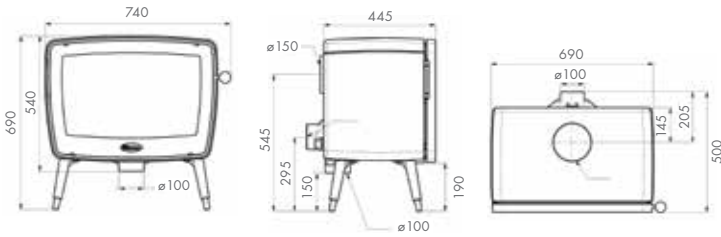

## P28/29 | Astroline 1CB Wood Stove

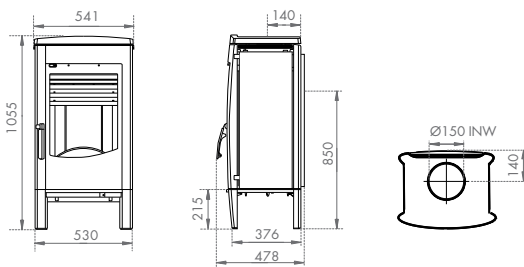

## P30/31 | Astroline 2CB Wood Stove

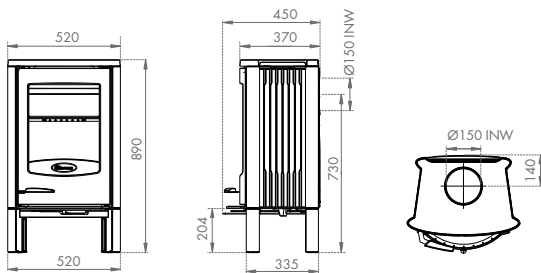

## P32/33 | Astroline 2CB Wood Stove - Pedestal

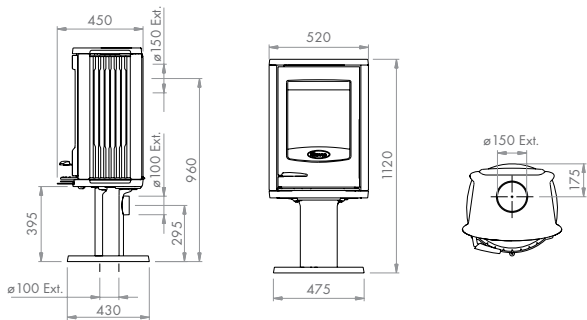

## P32/33 | Astroline 2CB Wood Stove - Wood Store

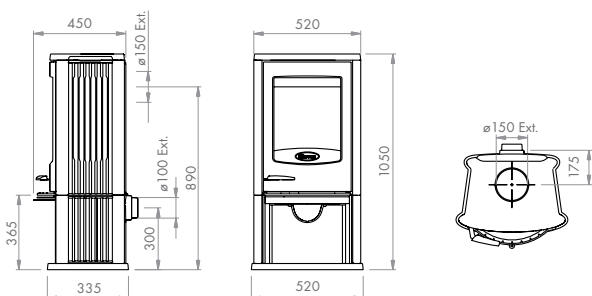

## P34/35 | Astroline 3CB Multi-Fuel & Wood Stoves

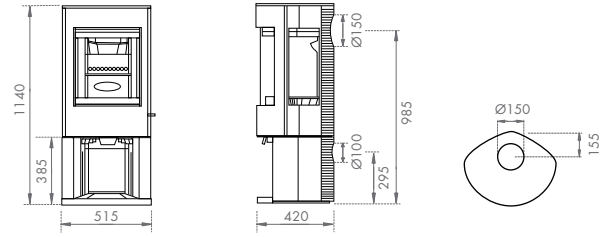

## P36/37 | Astroline 4CB Multi-Fuel & Wood Stoves

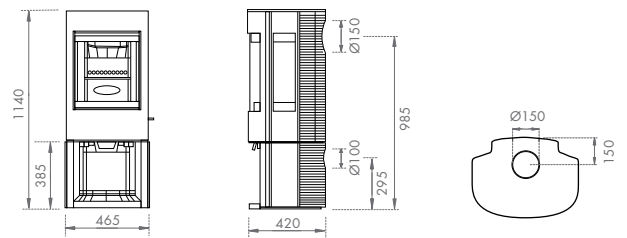

## P38/39 | Astroline 350CB Wood Stove

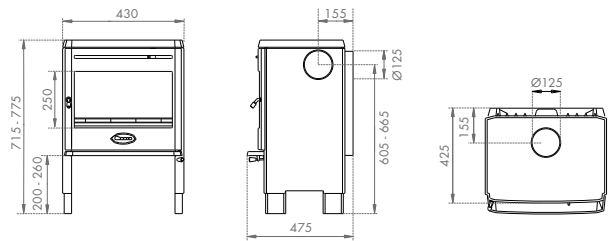

## P38/39 | Astroline 350CB/3 Wood Stove

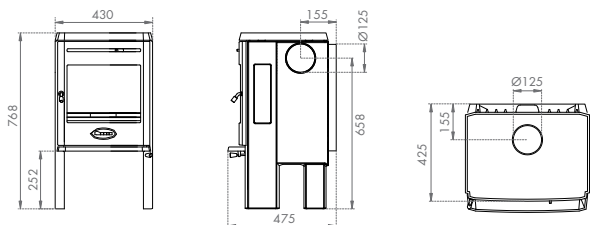

## P40/41 | Astroline 360CB Wood Stove

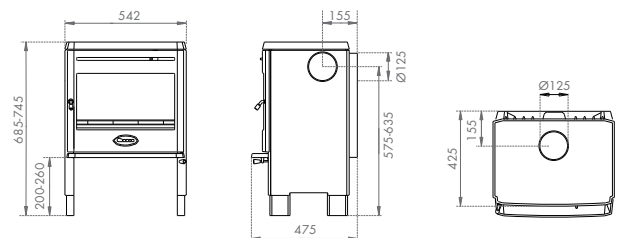

# Dimensions

P40/41 | Astroline 360CB/3 Wood Stove

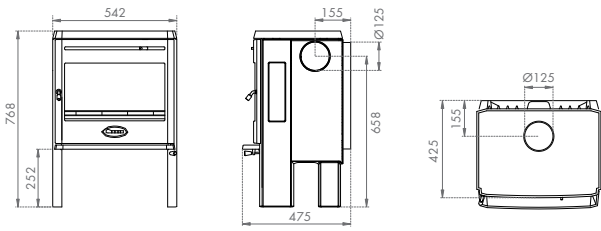

P50/51 | 2300CB Wood Fireplace†

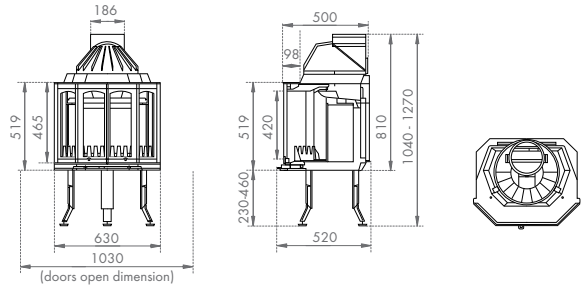

P42/43 | 2510 Double-Sided Cassette Fire

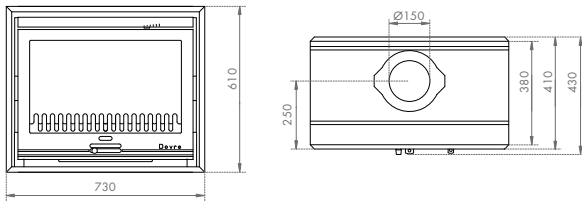

P52/53 | 2400CB Wood Fireplace†

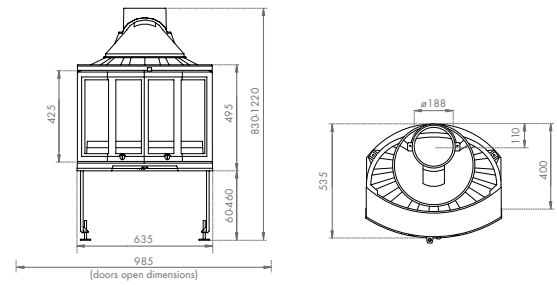

P44/45 | 2520 Cassette Fire

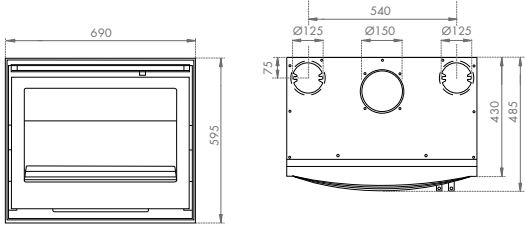

P54/55 | 2700 Wood Fireplace†

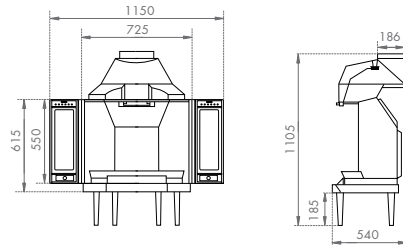

P46/47 | 1800 Multi-Fuel Fireplace†

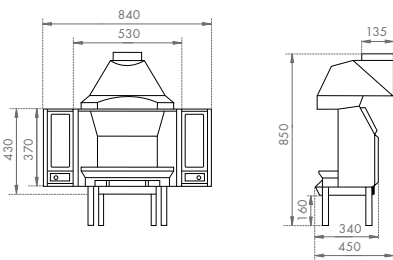

P56/57 | 280 Gas Stoves

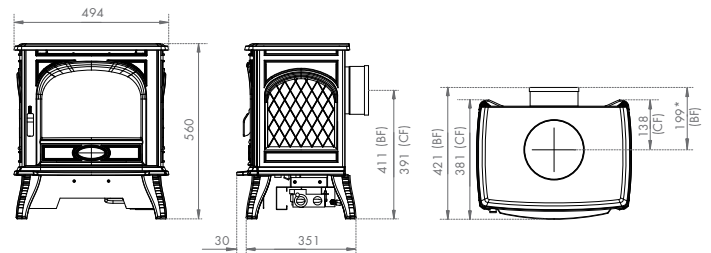

\*To end of rear flue spigot. Full installation instructions with information on balanced flue configurations are available from [www.dovre.co.uk](http://www.dovre.co.uk)

P48/49 | 2000 Multi-Fuel Fireplace†

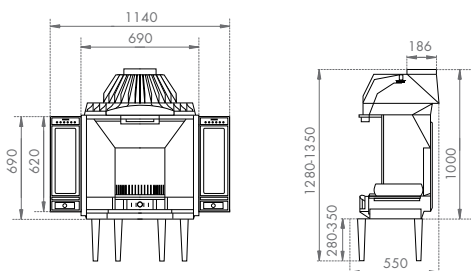

P58/59 | 425 Gas Stoves

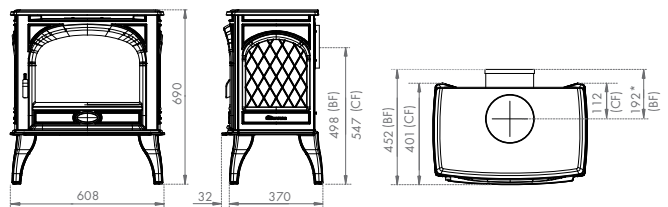

\*To end of rear flue spigot. Full installation instructions with information on balanced flue configurations are available from [www.dovre.co.uk](http://www.dovre.co.uk)



# Correct Installation

A HETAS approved installer should undertake a site survey prior to purchase and must install any Dovre stove or fireplace. Your Dovre retailer will be able to advise on this. The below information is to assist you in your choice of a suitable Dovre fire or stove. It is not intended to be all the information required to install your fire or stove; this can be obtained from your local Dovre retailer or you can view/download the relevant full installation instructions from the Dovre website at [www.dovre.co.uk](http://www.dovre.co.uk)

## P60/61 | 280 Electric Stoves

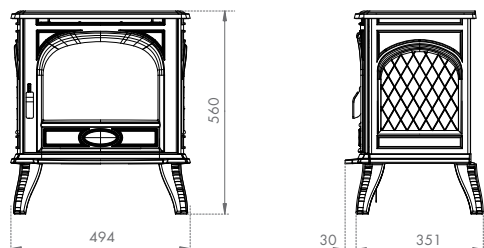

## P62/63 | 425 Electric Stoves

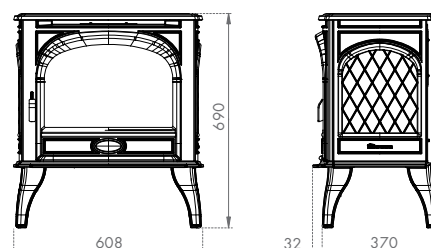

All fire and flame photography has been taken from genuine products; however, the exact appearance of the flame picture for any appliance will vary depending on the nature of the flue type, installation surroundings, local geographical features and the way in which the appliance is operated. Some of the room sets in this brochure have been created for aesthetic purposes. When designing your own installation, please observe the minimum distance to combustible materials as stated in the installation instructions.

**Please note:** The operation and appearance of gas appliances depends on variable factors such as the gas pressure supplied.

Stovax gratefully acknowledges the assistance of the following companies with photographic settings:

Apple Conservatories - [www.appleconservatories.com](http://www.appleconservatories.com) • Ashore - 01392 477763 • Debenhams - [www.debenhams.com](http://www.debenhams.com) • Eclectique - [www.eclectique.co.uk](http://www.eclectique.co.uk)  
Fagins Antiques - [www.faginsantiques.com](http://www.faginsantiques.com) • Farmington Stone Fireplaces - [www.farmington.co.uk](http://www.farmington.co.uk) • Furniture Village - [www.furniturevillage.co.uk](http://www.furniturevillage.co.uk) • McBains Antiques - 01392 366261  
Toby's Antiques - [www.tobysreclamation.co.uk](http://www.tobysreclamation.co.uk) • House of Fraser - [www.houseoffraser.co.uk](http://www.houseoffraser.co.uk) • Laura Ashley - [www.lauraashley.com](http://www.lauraashley.com) • Merchant House Antiques - [www.merchanthouseantiques.co.uk](http://www.merchanthouseantiques.co.uk)  
Orange Tree - [www.theorangetree.co.uk](http://www.theorangetree.co.uk) • Original Style - [www.originalstyle.com](http://www.originalstyle.com) • St Bridget Nurseries - [www.stbridgetnurseries.co.uk](http://www.stbridgetnurseries.co.uk) • Amos Lighting - [www.amoslighting.co.uk](http://www.amoslighting.co.uk)  
Pilgrim Antiques - [www.pilgrimantiques.co.uk](http://www.pilgrimantiques.co.uk) • Pedlars - [www.pedlars.co.uk](http://www.pedlars.co.uk)



Dovre Vintage 35 in Anthracite



To view the complete range of brochures within the Stovax group, simply scan this code or visit [www.stovax.com](http://www.stovax.com)



United Kingdom & Republic of Ireland distributors for Dovre:

**Stovax Limited**  
Falcon Road, Sowton Industrial Estate,  
Exeter, Devon EX2 7LF

**Solid Fuel Trade Sales tel:** 01392 474000  
**Gas & Electric Trade Sales tel:** 01392 261900  
**Other depts tel:** 01392 474011  
**Fax:** 01392 219932  
**E-mail:** [dovre@stovax.com](mailto:dovre@stovax.com)  
**Internet:** [www.dovre.co.uk](http://www.dovre.co.uk)

Your local Dovre retailer:

£2.00



DOVRE1213