

NEW ROLLING METHOD OF REVERSING COLD ROLLING MILL

Authors Name and Affiliations

Yohei Kannaka, Tanehiro Kikkawa / Rolling Mill Department, Technology & Engineering Division , JP Steel Plantech Co. / Yokohama, Japan

Contact data

Address ; 3-1, Kinko-cho, Kanagawa-ku Yokohama Japan / Phone;+81-45-440-5942 /

E-mail ; kannakayo@steelplantech.co.jp

Summary

A reversing cold rolling mill has been suffering from such drawbacks as unrolled portions necessarily produced in head and tail ends reduce yield, and time consuming works including removing of coils, threading of the strip and holding of the strip with the tension reel, which result in decreasing productivity.

There has been developed a new rolling method and facility (Zoom-Mill™, Zero-Oriented Off-gauge Minimization) that allows a leader strip and a product coil are connected using a spot welding machine and are finished through even-number passes in a reversing cold rolling mill. It is expected to reduce unrolled portions (improvement of yield) as well as improvement of productivity.

The first Zoom-Mill™ was put into practical use and commercial operation started in March 2010. This mill is working very well as intended initially, achieving approximately 1% improvement of product yield of the products immediately after commencement of operation.

Productivity of the mill was also sharply increased along quick learning curve.

Key Words

Cold Rolling Mill, Zoom-Mill™, Off-gauge, Minimization, Yield, Productivity, Labor saving, Leader strip, Spot welder, Even-numbered Pass

1. Introduction

For the production of cold rolling steel strips in a yearly production capacity range from 150,000 to 300,000 tons, a reversing cold rolling mill, which requires relatively minimal capital investment, is put into use. The reversing cold rolling mill is used mainly for producing coils of ordinary carbon steel in emerging countries, and is used for producing small lots of a variety of coils of high-grade steel or special steel in advanced countries. Since it is not continuous rolling, a reversing cold rolling mill has its drawbacks: unrolled portions produced in the head and tail ends reduce yield, and time-consuming work such as the replacement of coils, threading of the strip and holding of the strip with the winding reel decrease productivity.

In this work, the development of a new rolling method (Zoom-Mill™, or zero-oriented off-gauge minimization) that enables unrolled portions to be reduced using a leader strip and a spot welding machine, thereby aiming to improve productivity, will be presented.

2. Outline of Reversing Cold Rolling Mill

(1) Outline of reversing cold rolling mill and rolling method

As illustrated in Figure 1, a reversing cold rolling mill is comprised mainly of a mill proper, a winding machine (pay-off reel), an entry winding machine

(entry tension reel) and a delivery winding machine (delivery tension reel).

There are many cases in which a shearing machine for dividing a strip is installed on the delivery side of the mill, and also a strip press is disposed on the entry side. A pickled hot coil is inserted into the pay-off reel, the head end is inserted into the gripper to allow the strip to be wound around the delivery tension reel after being threaded up to the tension reel, specified reduction is carried out by the roll force cylinders in the mill, and tension between the mill and each reel is established. After that, rolling of the first pass is started. The tension becomes lost when the hot coil is taken out from the payoff reel, so reduction of off-gauge is implemented by applying tension due to friction force using a strip press in the mill. In the case when productivity is given a higher priority compared to yield, the strip press may be not used, and the second pass is immediately started. With regard to the second pass, the tail end is inserted into the gripper of the entry tension reel, and the process continues as with the first pass. After this, rolling is repeated several times until reaching the target thickness of product. There are cases in which a product is finished through odd-number passes, such as one, three, five passes, etc., or cases in which a product is finished through even-number passes such as two, four, six passes, etc.

However, the case in which a product is finished mainly through odd-number passes seems to be dominant because of the constraint from the equipment constituting the line, the constraint from the flow being continued to the following line, or the like.

A final process such as that illustrated in Figure 1 is an example in which a product coil is taken out from the delivery tension reel after being subjected to odd-numbered passes.

Although a portion that does not become a product because of not being rolled (off-gauge portion) is included in the both end of a strip, the end on the entry side is cut out by means of a shearing machine on the delivery side of the mill and is taken from the entry tension reel as a small coil (pup coil) to be disposed. On the other hand, an off-gauge portion on the end on the delivery side remains in the inner periphery of the product coil taken out from the delivery tension reel, and is disposed in the following line or by an end user.

(2) Conventional technology for reducing an unrolled portion

Until now, there have been proposed several measures for reducing an unrolled portion (off-gauge portion) produced on both ends of rolled material in the longitudinal direction.

One method is to roll with no tensioning so that both ends of the material in the longitudinal direction are each released from the tension reel, and after that, reverse rolling is continued by holding the material again with the tension reel.^[1]

Since this method is to carry out rolling without tensioning any portion near both ends, there is an anxiety that strip threading will become unstable, or the shape and/or tolerance thickness of the strip will become worse. Moreover, since the rolling is carried out without tensioning at a low speed, and it takes time to have a strip held by and released from the tension reel, reduction in productivity is unavoidable.

The second method is such that a coil preparation line is provided next to reversible rolling equipment.^[2]

In the coil preparation line, there are works to make a coil prolonged by weld-joining the respective ends of the strip to each other, or to weld a dummy member (leader piece) to both ends of the strip. This method requires installation costs, a long installation area, operating personnel and operational costs aside from rolling facilities.

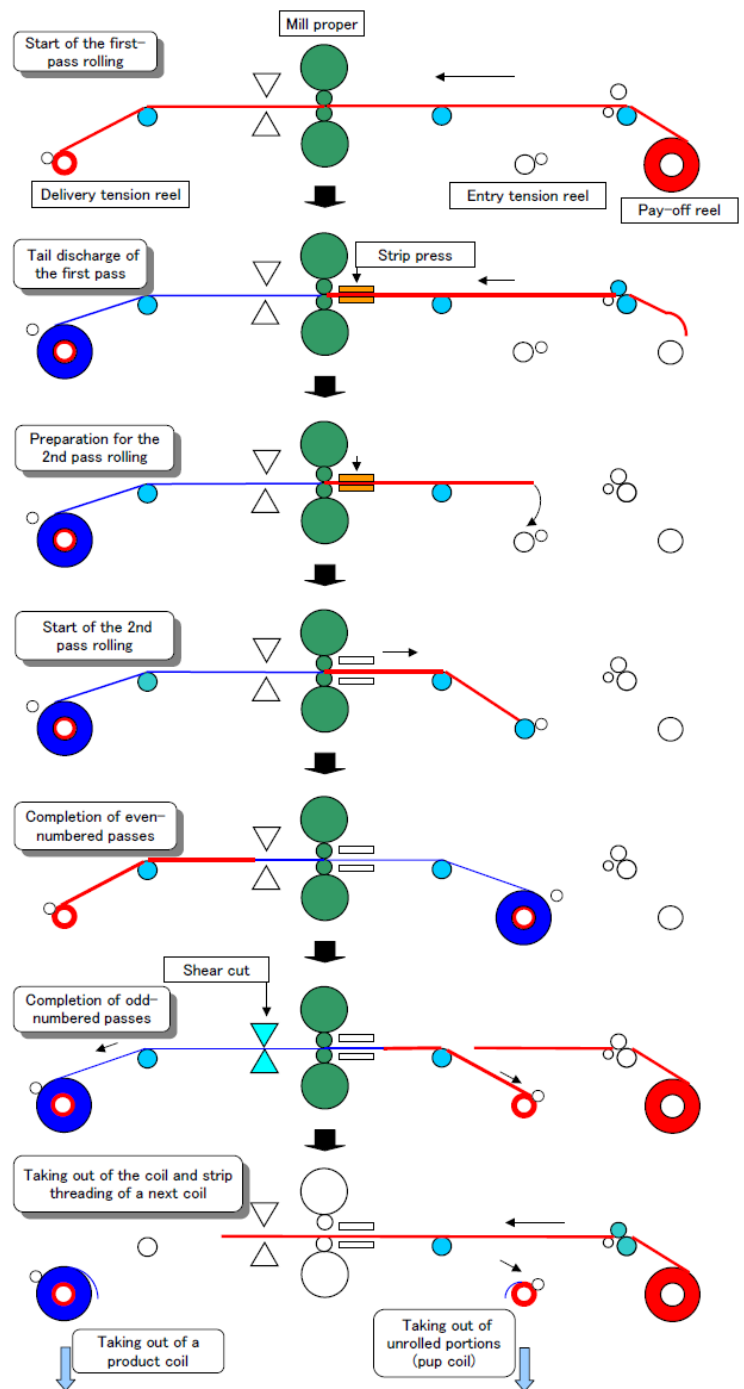

Figure 1. Conventional rolling method of a reversing cold rolling mill

3. Development of Zoom-Mill™ using a Leader Strip and a Spot Welder

(1) Background of development

As described in the previous section, unrolled portions are produced in the head and tail ends of coil in conventional reversing rolling mills; then, the unrolled portions would be reduced by weld-joining the portion to the head end of a base coil on the line as a leader strip prepared in advance. If a spot welding machine having a track record in strip passing of process lines is employed, relatively inexpensive facilities can be set up, and the time of operation can be shortened due to a short welding time.

At the time of development, factors such as the strength and durability of the welded portion, whether adequate rolling tension would be obtained by spot welding, and whether there would be a problem if rolling oil becomes involved were checked.

(2) Test on a pilot line

After various basic data were collected regarding the strength of a spot welded point using a direct stress machine, a spot welding machine (Figure 2) was installed in a pilot line and tested. The strength and durability of welded portions were checked by implementing winding/rewinding repeatedly in a state in which a tension was applied between a pay-off reel and a tension reel.



Figure 2. Experimental equipment of spot welding machine

(3) Test results

Required numbers of welding points for each combination of strip thicknesses, which were summarized on the basis of test results, are illustrated in Figure 3.

Here, required rolling tension is set at 60 kN on assumption that taper tension is to be employed at a pass in one portion. It is revealed that 12 points or

more are enough to cover every case. And, a test was conducted by applying gear oil with a brush to check the strength of welding when rolling oil would be involved, but any degradation in the welding strength was not found. This is thought that the reason why the oil ingredient might become burn out instantaneously is due to an arc at welding.

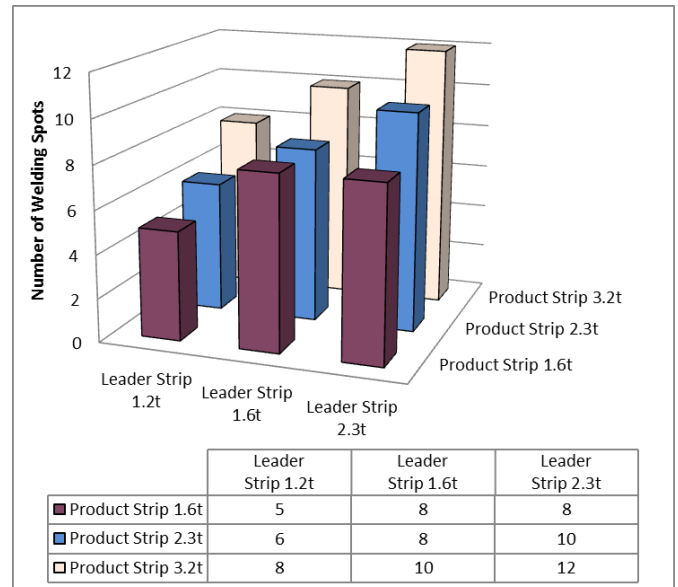

Figure 3. Required number of welding spots for 900mm width strip

4. Achievement of Applying Zoom-Mill™ into a Practical Mill

(1) Concept for applying Zoom-Mill™ into a practical mill

If a leader strip is provided to both a head end and a tail end, the yield is significantly improved; however, this inhibits productivity because of the time spent dealing with leader strip remaining in the inner periphery. At the time of application into a practical machine, it was decided to employ a rolling method to finish through even-number passes in a manner in which a leader strip is provided only to the delivery tension reel and connected to the head end of a hot coil using a spot welding machine.

The basic concept of the application into a practical machine is illustrated in Figure 4.

The welded portion is cut off from the leader strip by means of a delivery shearing machine after completion of rolling and is brought out using an entry coil car while being attached to the product coil to be dealt with at an off-line location. This is due to the fact that the facility for dealing with welded portions is not located on the rolling line, and also the time involved hinders productivity.

A leader strip and the head end of a coil are connected by a spot welding machine and are finished through even-numbered passes

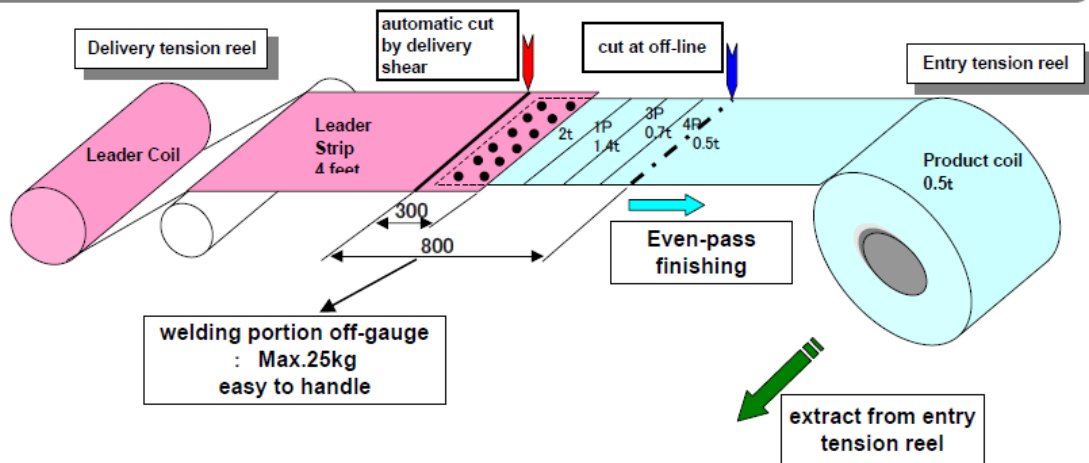

Figure 4. Basic concept of Zoom-Mill™

(2) Structure and arrangement of the welding machine

A welding machine that is brought into a reversing mill destined for Southeast Asia is illustrated in Figure 5

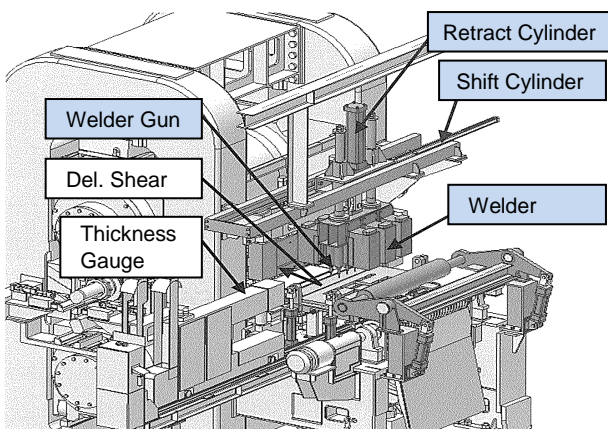

Figure 5. Arrangement of a Zoom welding machine

The welding machine consists of six pieces of transformers, 12 sets of welding guns, a hoisting and lowering device, a shifting device, etc., and is arranged coaxially with a delivery thickness gauge so that the standby position is located above the thickness gauge. Because of this, the line is not much extended in the longitudinal direction of rolling, so, even when the welding machine is not in use, the unrolled length does not become longer. Moreover, the welding machine can be retracted to the drive side, as with the strip thickness gauge that can be retracted to the drive side, which allows maintenance such as replacement of welding gun tips to be easily carried out at an off-line location. As described above, since the line length does not vary from the original design even when this welding machine is installed, it can be applied not only to a

new facility but also to existing reversing rolling mills as additional equipment.

(3) Zoom rolling method

The Zoom rolling method is illustrated in Figure 6. A leader strip, which is previously installed onto the delivery tension reel, and the head end of a strip from the payoff reel are welded each other using the spot welding machine described earlier. Spot welding of 6 locations x 2 times = 12 locations (24 points) is basically carried out (depending on the width of products). The welded portion is moved back to the vicinity of the mill bite, specific reduction is carried out by the roll force cylinders in the mill, and tension between the mill and each reel is established; after that, rolling of the first pass is started. A strip press is used for the tail end in the first pass to reduce off-gauge as with conventional rolling, and similar works as with conventional rolling are carried out from the second pass. The last pass is to be even-numbered, and the strip is cut by a shearing machine at the position shown in Figure 4, to be wound onto the entry tension reel. At that time, the next strip that has already been prepared is immediately supplied from the payoff reel, and welding starts with the leader strip that is on standby on the delivery side of the mill.

Incidentally, the leader strip can be easily set by being subjected to conventional rolling, providing a finish of a wide width through even-numbered passes, and by being shear cut with a little more than 10 m remaining at the delivery tension reel in the last pass

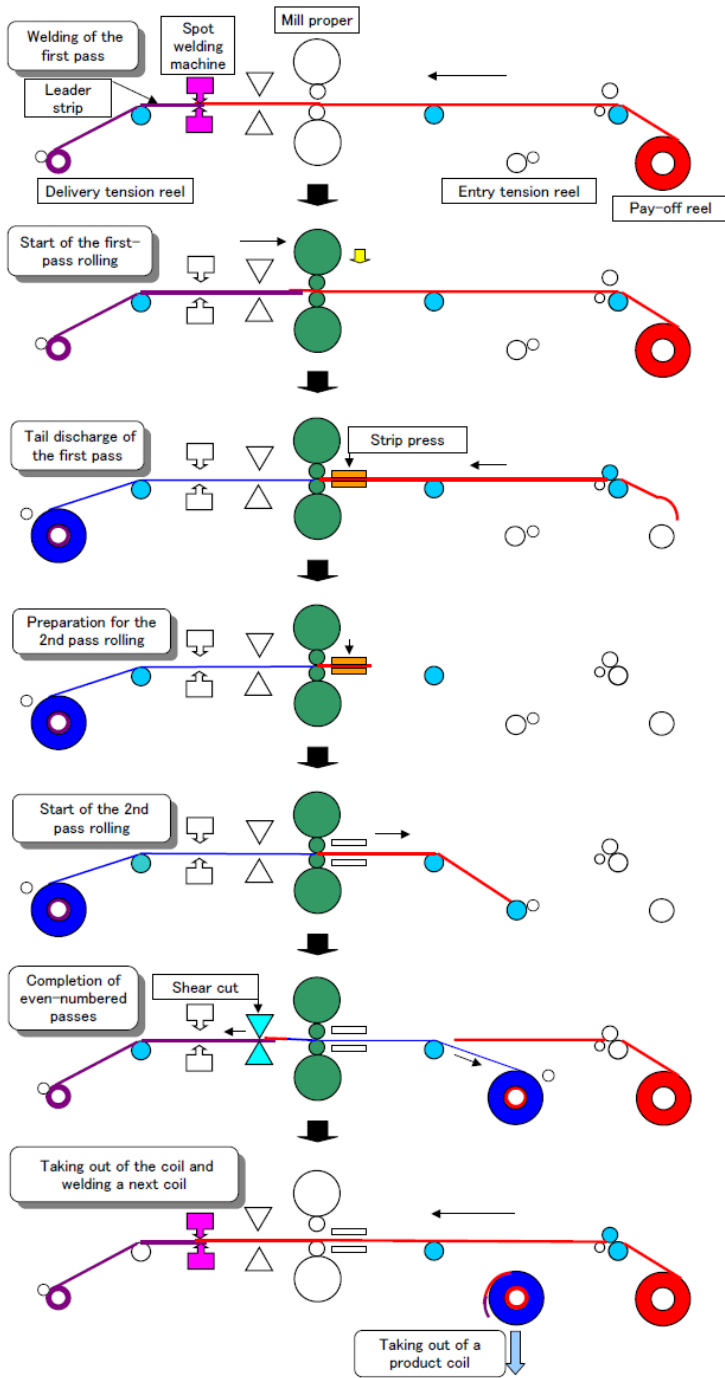

Figure 6. Procedure of Zoom rolling method

5. Effects of Zoom Rolling Method

(1) Effect of reduction of unrolled portion

The effect of the reduction of unrolled portion by means of this rolling method is illustrated in Figure 7. The rate of off-gauge by means of this rolling method is 0.7%, which is improved by 1.4% as compared with conventional rolling, and also improved by 0.9% as compared with the conventional rolling using a strip press. In case of a mill having an annual yield of 250,000 tons, it

means that hot coils of 2,250–3,500 tons per year would be saved.

In addition, since it is possible to roll from the head end by applying tension, this rolling method is thought to be superior in regard to the strip threading stability, strip thickness accuracy and strip flatness, as compared with other off-gauge reduction methods.

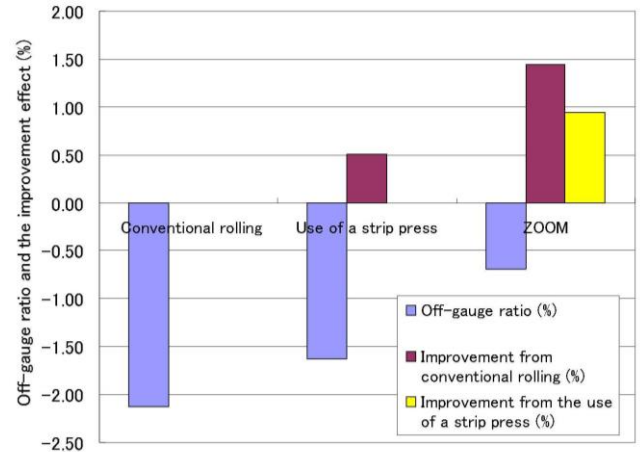

Figure 7. Effect of reduction of unrolling portions

(2) Effect of productivity improvement

As illustrated in Table 1, it is known that processing time per coil (excluding rolling time) can be reduced in accordance with this rolling method, even though spot welding consumes some time, since it is not necessary to spend time waiting for a rolled coil being taken to an off-line position, threading the next strip to the delivery tension reel and winding it several rounds while holding it. Moreover, since a small coil (pup coil) of an unrolled portion is not produced, the work of taking it out by fastening with a band is eliminated.

Table 1. Processing time per coil(excluding rolling time)

Pass No.	Unit in Minutes			
	Conventional rolling		Zoom rolling	
	Coil Change, Threading	Set-up, Coolant Spray	Coil Change, Threading	Set-up, Coolant Spray
1	0.9	0.3	1.3	0.3
2	0.9	0.3	0.9	0.3
3	0	0.3	0	0.3
4	0	0.3	0	0.3
5	0	0.3	0	0.3
6	2.1	0.3	0	0.3
Total	3.9	1.8	2.2	1.8
	5.7		4.0	

Figure 8 shows production tons per hour (T/H) of the case in which average gauge products each having an individual strip width were rolled by finishing through four, five and six passes in a certain steelmaking plant. In spite of the same workload, the more the number of passes was increased, the lower the productivity became due to the increase of time for changing passes, acceleration / deceleration, and so on. Figure 9 shows a comparison of ordinary rolling through five passes and the case in which the Zoom rolling method was applied when finished through four and six passes, respectively. It is confirmed that the productivity was further improved by applying Zoom rolling in case of four passes; and even in case of six passes, productivity improved, as compared with ordinary

five-pass rolling owing to the contribution of shortened processing time per coil.

Figure 10 shows the effect of increased production by Zoom rolling. The productivity has been increased by approximately 10% at four passes, and by approximately 2% at six passes. In the case in which even-numbered passes are introduced into a practical operation, it is not possible to reduce the number of passes of all the processes, but it is necessary to increase the number of passes of substantially half the processes. A trial calculation for the case of a mill having an annual yield of 250,000 tons revealed that the annual operation of 5,402 hours was reduced to 5,096 hours and the productivity was improved by 6% by employing this rolling method.

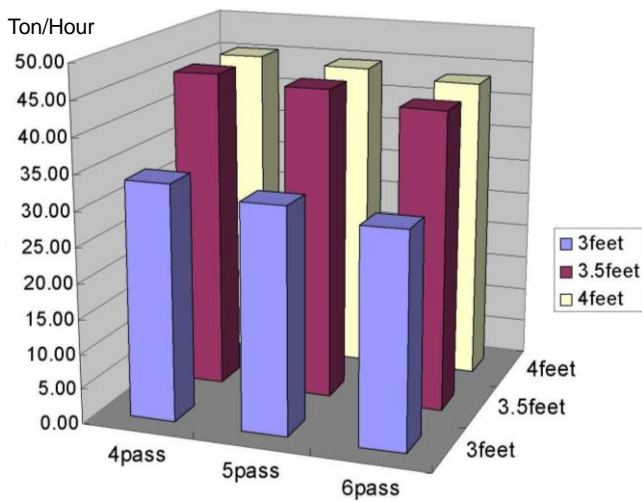

Figure 8. Production rate for respective strip widths

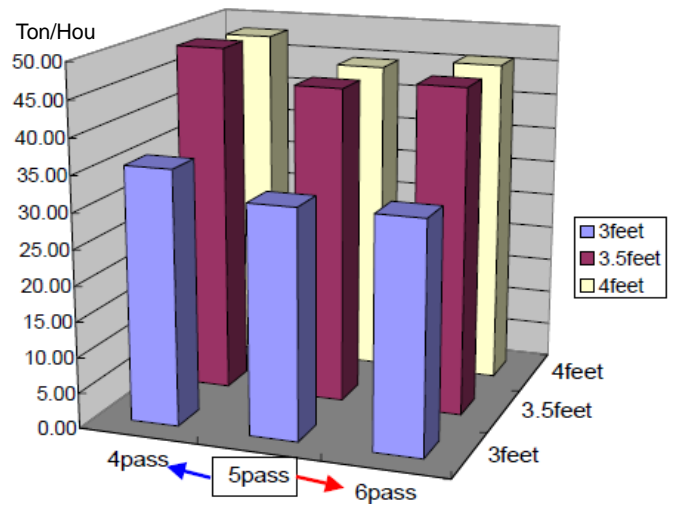

Figure 9. Production rate for each strip width when Zoom is applied

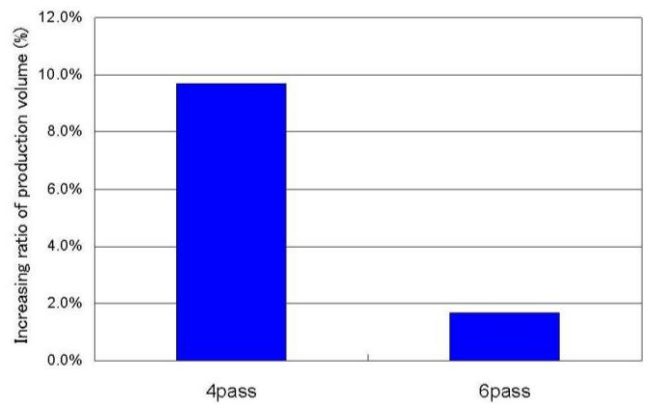

Figure 10. Effect of production rate increase by adapting Zoom rolling

6. Recent developments

Zoom-Mill™ is easily adaptable to special steel rolling such as high-tensile steel, stainless steel, electrical steel with the same arrangement as ordinary carbon steel rolling.

Figure 11 shows the strength of the tensile test spot welding between an ordinary carbon steel and a special steel. If the product strip is the one of the above special steel and leader strip is carbon steel, the strength of the spot welding has equivalent tensile strength as compared to spot welding between ordinary carbon steel each other.

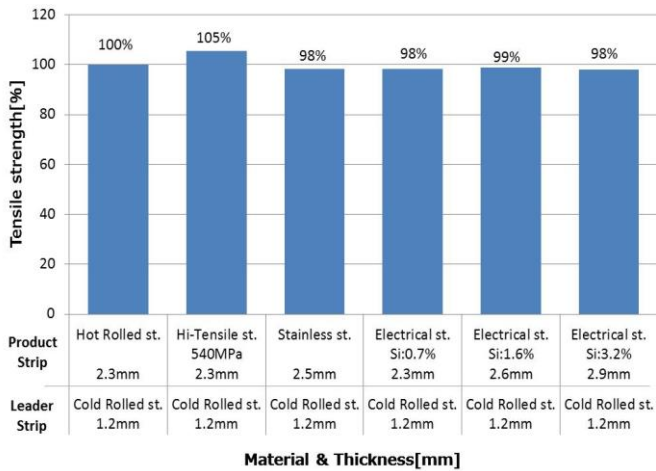

Figure 11. Tensile Strength in spot welding of special steel & ordinary steel

Above results suggest that Zoom-Mill™ can be applied to broad range of materials such as ordinary carbon steel high-tensile steel, electrical steel and stainless steel.

Beside the advantage of off-gauge improvement, it must be noted that the merits are higher in case of special steel due to higher unit price.

7. References of Zoom-Mill™

Zoom-Mill™ was put into practical use and commercial operation started in March 2010 (Figure 12 and Figure 13). Approximately 1% improvement of yield of the mill was achieved immediately.

Productivity of the mill was also sharply increased along quick learning curve.

Owing to excellent result, the client had placed three orders of Zoom-Mill™s to SPCO up to now.



Figure 12. Zoom device in erection



Figure 13. Zoom-Mill™ in operation

Conclusion

A new rolling method and facility (Zoom-Mill™) has been developed that allows a leader strip and product coil to be connected using a spot welding machine and finished through even-number passes in a reversing cold rolling mill. It is expected to reduce unrolled portions (improvement of yield) as well as improve productivity

In the recent years, it has become important to form a recycling-based society in order to help prevent global warming, and the promotion of "reduce, reuse and recycle" is required in every industrial area. Reduce (no production and no use of excessive goods), which does not generate greenhouse gases, is particularly regarded to be most important. This rolling technology follows these criteria, illustrating that JP Steel Plantech Co. intends to develop products that are environmental friendly, as well as to promote the use of this rolling method and its facilities.

Acknowledgements

The author wishes to thank Yieh Phui (China) Technomaterial Co.,Ltd. that firstly applied Zoom rolling to the existing mills. I would also like to thank my colleagues and former colleagues who have been being involved in development of Zoom-Mill™.

References

- [1] Jpn. Pat. Appln. KOHYO Publication No.1999-500065
- [2] Jpn. Pat. Appln. KOKAI Publication No.1999-342402