

DRAINAGE SYSTEMS PRODUCT GUIDE



Welcome to Ashworth

Ashworth has long been recognised as a competitive, reliable & efficient supplier to the **Drainage** Market. Ashworth's product offering has grown and is now more diverse and includes **Sound Attenuated** and **Syphonic Type Systems** in addition to vital traditional products such as **Cast Iron Rainwater, Soil, and Drain** systems.

At Ashworth customer service is paramount, so we have regionally focussed highly skilled internal and external sales personnel.

Ashworth also acknowledge that stock and supply of product is critical to your success and therefore significant stock holdings are in place coupled with an improved logistics infrastructure to meet the needs of Major Projects or Small Works.

Ashworth deliver the complete Drainage offering.



OUR CUSTOMERS

As a leading distributor of quality products and services to the mechanical services and process industries markets, we cover a wide range of customer types, both large and small. We focus our expertise specifically to our customers in our chosen markets.

These include:

- Fire protection contractors and fabricators
- Mechanical services contractors
- Plumbers
- Heating engineers
- Drainage contractors
- Local and government authorities
- International petrochemical companies and associated contractors
- OEM and in-house company engineers
- Secondary distribution channels

SERVICE

We pride ourselves on supplying an unrivalled range of products and services from recognised market leading manufacturers. These products are stocked in depth at all our sites which are linked via a sophisticated IT network to facilitate the sourcing of additional products in rapid time, thus improving on-site deliveries.

We service the UK from our network of strategically placed branches, all of which employ teams of knowledgeable staff equipped to answer the needs of our customers' enquiries.

They are all trained to problem solve received enquiries, whether that be sourcing a new range of products or simply providing service on our stocked ranges.

We strive to be at the forefront of innovations and will introduce new product ranges and services on a regular basis, thus providing our customers with the opportunity to differentiate their own service to their clients.

Our objectives in service are to provide:

- A friendly and helpful service to all our customers
- A quick and efficient response to all enquiries
- A core range of products to satisfy immediate customer requirements
- Innovative and efficient solutions to customer needs

PART OF A GLOBAL NETWORK, WITH STRONG SISTER BRANDS





MECHANICAL SERVICES

The Ashworth brand has long been associated with the Mechanical Services market, offering a broad range of Tubes, Valves and Fittings.



PRESSURE PLASTICS

Ashworth are now the UK's leading distributor in supplying to the Process market. This is enhanced by our highly experienced sales teams knowledgeable in Process Valves and Pressure Plastics.



FIRE PROTECTION

Ashworth, the market leader in Fire Protection, has recognised the need to respond to the critical levels of service demanded in this fast-track environment. Alongside our standard packages we can offer a bespoke package of equipment and services dedicated to Industry Standards and Insurance Regulations.



HEATING PRODUCTS

Our expertise within this market sector has led to the inclusion of further products in our extensive range. Our technically aware staff are always available to offer advice and support to customers on all types of Heating and Ventilation projects.



DRAINAGE

As UK leader in the supply of Drainage Systems, we offer a product range in a variety of materials including Cast Iron, Stainless Steel, PVC, HDPE and Aluminium to service the commercial internal and external Rainwater, Soil and Waste markets.



SANITARY WARE

Through our association with sister brands, within our group, Graham, Neville Lumb, and Folkard Bolding - we are able to supply a comprehensive range of Commercial Sanitary Ware for all applications.



INDUSTRY

The Ashworth team has extensive knowledge and experience in the supply of Quality Tube and Process Valves to all aspects of Industry. Our competence in this area covers both the customer and manufacturing ends of the business.



CONTACT US

For more information regarding Ashworth products please contact our experienced sales team who will be more than happy to help.

FREEPHONE 0800 783 7680

SUPPLIER INFORMATION

HOROBIN	Web - www.horobin.co.uk Tel - 01902 604060
NORMA	Web - www.norma.co.uk Tel - 01635 521880
WADE	Web - www.wadedrainage.co.uk Tel - 01787 475151
SGPAM UK	Web - www.saint-gobain-pam.co.uk Tel - 0115 9300681
GEBERIT	Web - www.geberit.co.uk Tel - 01926 516800
POLYPIPE TERRAIN	Web - www.polypipe.com Tel - 01622 795200
POLYPIPE Building Products	Web - www.polypipe.co.uk Tel - 0845 2700886
DURAPIPE	Web - www.durapipe.co.uk Tel - 01543 279909
BLUCHER	Web - www.blucher.co.uk Tel - 01937 838000
ALUMASC	Web - www.alumasc-exteriors.co.uk Tel - 01744 648400
BLM	Web - www.britishlead.co.uk Tel - 01707 324595

Conversion tables

LENGTH	<i>ins to mm</i>	25.40000	<i>mm to ins</i>	0.03937
	<i>ft to m</i>	0.30480	<i>m to ft</i>	3.28084
AREA	<i>ins² to mm²</i>	645.16000	<i>mm² to ins²</i>	0.00155
	<i>ft² to m²</i>	0.09290	<i>m² to ft²</i>	10.76390
VOLUME	<i>ins³ to mm³</i>	16387.10000	<i>mm³ to ins³</i>	0.00006
	<i>ft³ to m³</i>	0.02831	<i>m³ to ft³</i>	35.31470
CAPACITY	<i>pints to litres</i>	0.56820	<i>litres to pints</i>	1.75980
	<i>gallons to litres</i>	4.54600	<i>litres to gallons</i>	0.21998
WEIGHT	<i>lbs to kg</i>	0.45360	<i>kg to lbs</i>	2.204622
	<i>tons to tonnes</i>	1.01600	<i>tonnes to tons</i>	0.98420
PRESSURE	<i>lbs/in to kN/m²</i>	6.89476	<i>kN/m² to lbs/in²</i>	0.14500
HEAT FLOW	<i>BTU/h to Watts</i>	0.29310	<i>Watts to BTU/h</i>	3.41300
TEMPERATURE	<i>°F to °C</i>	-32 x 0.55°		
	<i>°C to °F</i>	x 1.8 + 32		

BROCHURE CONTENTS

HOROBIN	
Horobin Drain Testing Equipment	6
NORMA	
NORMACONNECT - Drainage Couplings	7
WADE INTERNATIONAL LTD	
Quality Drainage Products	8
Floor Gullies & Access Covers	9
Roof Outlets	10
Linear Drainage	11
SAINT-GOBAIN PAM UK	
Benefits of Cast Iron	14
EPAMS Syphonic System	15
Ensign EEZI-FIT	15
Ensign Soil	16-17
Ensign Drain	17
Timesaver Heritage and Timesaver Soil	18
Timesaver Drain	19
Classical Plus Rainwater (semi-gloss black finish)	20
Classical Express (Primed Finish) - Classical Express Plus (semi-gloss black finish)	21
Classical Rainwater (primed finish)	22-23
GEBERIT	
Geberit HDPE Soil & Waste Systems	24-26
Geberit HDPE Syphonic Roof Drainage - Suspended Rail & Bracketry	27
Geberit Silent - dB20	28
POLYPIPE TERRAIN	
Polypipe HDPE Drainage Systems	33-35
Terrain Acoustic dB12	37
Terrain Soil & Waste	40-42
Terrain Rainwater	43
POLYPIPE BUILDING PRODUCTS	
Soil & Waste	50-52
Traps	52
Overflow & Waste Systems	53-54
Rainwater Systems	54-55
DURAPIPE	
Vulkathene Chemical Waste	56-57
Friaphon Soil System	58
BLUCHER	
Europe Push-fit pipes & fittings - Domestic Floor Drains	60
Industrial Floor Drains - Linear Drainage Channel - Access Covers - Grease Separators	61
ALUMASC	
Heritage Cast Aluminium Rainwater Systems	62-63
Heritage Downpipe Systems	63
Aqualine GX Contemporary Pressed Rainwater Systems	64
Harmer Roof, Shower & Floor Drains	65
BRITISH LEAD	
BLM 100% recycled lead	66
Lead Worker tips from BLM	67

DRAINAGE SYSTEMS PRODUCT SELECTOR

ROOF LEVEL



- SGPAM Classical Gutters
- Alumasc PPC Gutters
- Harmer Roof Outlets
- BLM Lead Flashing
- Wade Roof Outlets
- Geberit Syphonic Rainwater
- SGPAM Epams Syphonic Rainwater
- Terrain Syphonic Rainwater

PIPES & FITTINGS



- SGPAM Cast Iron
 - Ensign Soil & Waste
 - Timesaver Soil
 - Classical Rainwater
 - Epams Syphonic Rainwater
 - Geberit
 - HDPE Soil & Waste
 - dB20 Sound Attenuated Soil & Waste
 - HDPE Syphonic Rainwater
 - Polypipe Terrain
 - dB12 Sound Attenuated Soil System
 - HDPE Soil & Waste / Siphonic Rainwater
 - Terrain Soil & Waste
 - Durapipe Friaphon Soil
 - Vulcathene Chemical Waste
 - Blucher European Stainless Steel
- Other Products:
- NormaConnect Stainless Couplers

FLOOR LEVEL



- Wade - Floor Drains & Stainless Channel Drainage
- Harmer - Floor & Shower Outlets
- Blucher - Stainless Floor Outlets & Channel Drainage

BASEMENT/
BELOW GROUND



- SGPAM - Timesaver Drain
- Ensign Drain
- Geberit - HDPE
- Polypipe - HDPE

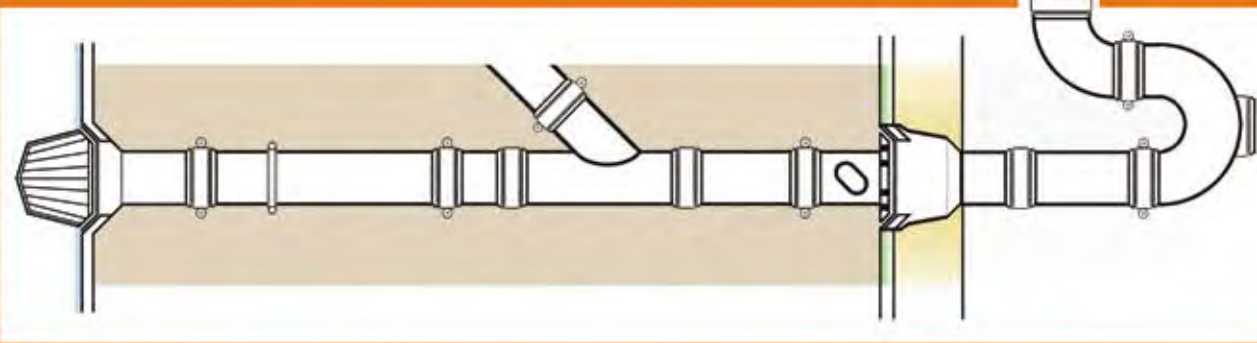

Associated Products & Add Ons:

- Bracketry
- Lead Accessories
- Sealants/Mastic
- Wire Balloons/Gutter Guard
- Weathering Slates
- Roof/Vent Connectors

- Bracketry/Pipe Support Systems
- Drain Testing Equipment
- Fire Collars
- Solvent Glue/Cleaner
- Roof/Floor Drains
- Traps
- Pan Connectors
- Silicone/Mastics
- Silicone Guns
- RW Pipe-nails/Bobbins/Screws
- Strap On Bosses
- Tools/Fixings
- Holesaws
- Protec Pipe Endcaps

- Drain Testing Equipment
- Support Bracketry
- Tools/Fixings
- PPE

Ashworth

SUPPLYING MECHANICAL SERVICES
AND PROCESS CONTRACTORS

HORO BIN DRAIN TESTING EQUIPMENT

Horobin manufactures a comprehensive range of drain testing equipment suitable for all sizes of drains and sewers. They also manufacture MDPE Pipe pressure testing equipment, Standpipes for temporary water supplies, and Drain Tracing Dye.

Horobin products are commonly used within the following markets:

- Construction and Civil Engineering
- Water and Sewerage
- Gas, Oil, Chemicals and Petrochemicals
- Food Processing and Brewing
- Pollution Control and the Controlling of Discharges into Waterways
- Telecommunications
- Agriculture
- Ship Repair
- Mining and Quarrying

Drain Testing Systems



- The complete answer for pressure testing drains and sewers of any diameter.
- The Horobin "Drain Test Kit" is the only complete kit on the market for pressure testing 100mm drains.
- Suitable for pressure testing drains and sewers to BS.8005 and EN1610.
- Superior design and quality ensures ease of use.
- Horobin guaranteed quality.

Drain Rods and Tools



- Ideal for use with short drain runs up to 30m.
- Available with either universal or lockfast fittings.
- Compatible with most other brands.
- Wide range of add-ons available - Rubber plungers, worm screws etc.
- Available in 19mm, 21mm, and 25mm diameter rods. Lengths are 3ft/1.5m/2m.
- Horobin quality guaranteed

HORO BIN DRAIN TESTING EQUIPMENT

HORO BIN DRAIN TESTING EQUIPMENT

ORDER CODE	DESCRIPTION	MANUFACTURERS REF
EQRN867	19mm P/T Test Plug for 25mm MDPE	73821
EQRN877	25mm P/T Test Plug for 32mm MDPE	73831
EQRN887	32mm P/T Test Plug for 40mm MDPE	73841
EQRN897	40mm P/T Test Plug for 50mm MDPE	73011
12050600	50mm Steel Test Plug	73021
12050610	75mm Steel Test Plug	73041
12050620	100mm Steel Test Plug	73061
12050630	150mm Steel Test Plug	73091
EQRN987	200mm Steel Test Plug	73551
12050800	50mm Inflatable PVC Sealing Bag	83011
12050810	75mm Inflatable PVC Sealing Bag	83021
12050820	100mm Inflatable PVC Sealing Bag	83031
12050830	150mm Inflatable PVC Sealing Bag	83051
12050150	100mm Air Test Gauge	79101
12050280	0.5inch Brass Nipple cap	79031
12050900	Inflator for PVC Air Bags	84011
12050170	Air Test Kit Complete - suitable any size Drain	79109
12050210	'Drain Clear' Set Universal - 10 Rods, 3 Tools in a case	47011
12050100	'Drain Clear' Set Lockfast - 10 Rods, 3 Tools in a case	47012
EQRN977	Drain Test Kit inc 2no. 100mm Test Plugs	79119
EQRN425	Box of 12 Smoke Matches	79391
EQRN410	200grams Red Drain Tracing Dye	79191
EQRN412	200grams Green Drain Tracing Dye	79211

(Please contact your nearest Ashworth branch for full product listings)

Drain Tracing Dye



- Drain Tracing Dyes are supplied in 200gram and 100gram Poly-jars in a range of 6 colours - green, red, blue, orange, yellow and violet.
- Drain Tracing Dye is used for detecting the flow of water in drains or pipes, identifying individual drain runs into a common gully, and tracing leaks in drains.
- Dyes are non-toxic and odourless. They are approved by the National Rivers Authorities, Water Companies and Local Authorities.
- Green Dye contains 50% Fluorescence. The other colours are made from 100% food grade products.
- Use 5ml of dye per 10 litres of cold water. The best method is to mix the dye into a bucket of water, and then add to the flow of drain. A 200gram jar will trace up to 15,000 litres in chemical free water.

For more information on our range of Drain Testing Equipment contact one of our experienced Sales Advisors

0800 783 7680

NORMA COUPLINGS

NORMACONNECT couplings offer the suitable solution for any kind of problem and their efficiency has been proven many times over in various applications. The flexibility of the complete range is made to perfectly match YOUR requirements.



NORMACONNECT STAINLESS STEEL DRAINAGE PIPE COUPLINGS

ORDER CODE	DESCRIPTION	MANUFACTURERS REF
99320180	Norma Connect coupling 50mm	0245 8135 050
99320190	Norma Connect coupling 70mm	0245 8136 070
99320200	Norma Connect coupling 100mm	0245 8139 100
99320210	Norma Connect coupling 150mm	0245 8141 150
99320220	Norma Connect coupling 200mm	0245 8142 200

(The above range also available in 125mm, 250mm and 300mm)

NORMACONNECT STAINLESS STEEL RESTRAINT COLLARS

ORDER CODE	DESCRIPTION	MANUFACTURERS REF
99320310	Norma Connect restraint collar 50mm	0262 8401 050
99320320	Norma Connect restraint collar 70mm	0262 8402 070
99320330	Norma Connect restraint collar 100mm	0262 8405 100
99320340	Norma Connect restraint collar 150mm	0262 8407 150

(The above range also available in 125mm, 200mm, 250mm and 300mm)



(Please contact your nearest Ashworth branch for full product listings)

NORMACONNECT GRIP COUPLINGS FOR CONNECTING UNRESTRAINED PLAIN ENDED METAL PIPES

Features

- Double lip sealing mechanism
- Ozone/UV/flame resistance due to anchoring ring
- Standard strip insert for prevention of seal damage, accommodate pipe gaps and increase shear strength
- Quick to install
- Lightweight
- Compact - ideal for tight space envelopes
- Tested against flammability, vacuum sealability, vibration and burst pressure

Technical

- Available diameters: 26.9mm up to 711.2mm
- Maximum allowable working pressures:
 - 16 bar for couplings up to and including 170mm
 - Between 16 bar and 3 bar for couplings from 170mm to 711.2mm
- Available in W2, W4 and W5 stainless steel grades
- Available with EPDM or NBR seals
- Accommodates pipe gaps up to 35mm
- Accommodates pipe (axial) offset up to 3mm
- Accommodates angular pipe deflection up to 2 degrees in all directions
- Equalises external pipe diameter differences up to 6mm
- Equalises pipe ovality up to 60mm
- Compensates for (temperature related) longitudinal expansions up to 10mm

For the full range of NormaConnect Grip Couplings please call our experienced sales team who will be happy to help

0800 783 7680



(Please contact your nearest Ashworth branch for full product listings)

QUALITY DRAINAGE PRODUCTS

A privately owned UK company with more than 40 years experience in the industry, Wade is established as a leading manufacturer of quality drainage products. Much of the success of the business is attributable to an on-going commitment to put technology to practical use, to generate fresh ideas, and to guarantee quality assured production. Wade offers a comprehensive range in which choices of material, size and style enable the specifier to select products that will meet his/her requirements.

Product Range

Floor Gullies - versions are available for use in finished or unfinished floors, with trapped or non-trapped body of cast iron or PVC, and with grating or cover of nickel bronze, polished bronze, cast iron or stainless steel; bodies are easily connected to all pipework in general use.

Access Covers - sometimes referred to as cleanouts or rodding eyes, complement wall and floor finishes. Versions are available for use in unfinished floors and in floors finished with ceramics, vinyl, marble, paviers, terrazzo, carpet or wood. Most covers are sealed; SuperSeal covers have additional benefits of being quick release and double sealed.

Roof Outlets - Wade offers a range of roof outlets with versions for use with different types of roof construction (warm, cold, inverted, no fines screed) for installation in different types of deck (concrete, metal, wood) with different types of waterproofing membrane (mastic asphalt, built-up felt roofing, single ply) a selection of which is shown in the technical section of this notebook.

Linear Drainage - comprises stainless steel channel, available in a range of profiles to fit a range of gratings of stainless steel, nickel bronze or cast iron. Versions are suitable for specialised applications such as fire-fighting lifts, thresholds and where dual-level drainage is required.

Automatic Grease Converters - PERMANENTLY convert the grease in waste water from kitchen and food processing operations into water soluble, biodegradable products. A mains powered Automatic Dosing Unit is an option being more frequently called for.

Non-freeze Water Points - provide an external water source for plant watering, area cleaning, vehicle wash down and similar activities.

Water Hammer Arrestors - are designed to eliminate vibrations in pipework caused by fast closing valves within the pipework system.

Quality

Certification of compliance with BS EN ISO 9001 underlines the Wade commitment to quality and service.

Service

Technical advice and further product information is available from the Wade Technical Services Department at Halstead, Essex, from Wade Technical Consultants located throughout the UK and from selected distributors worldwide. A free lecture/seminar service is available for schools, colleges and professional organisations.

Factory tours and C.P.D sessions on drainage topics are available by appointment.

Information Technology

Version 2.2 of Wade Drainage Products on CD-ROM contains an interactive electronic catalogue which enables the user to build specifications of compatible products for a selected application, as well as our PDF format Technical handbooks. Wade-CAD is included for users who require drawings of Wade products; files are in both DXF and AutoCAD DWG format.

Visit our website for online versions of the electronic catalogue, price list, Wade-CAD and PDF format Technical handbooks.



Floor Gullies



Floor Gullies



Floor Gullies



Grease Converters



Access Covers

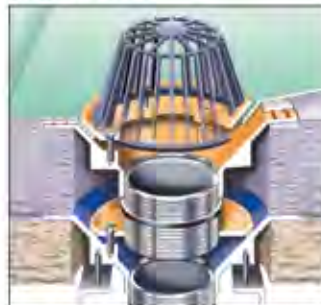

Roof Outlets



Linear Drainage



Wade International Ltd. premises, Halstead, Essex

Wade International Limited
Third Avenue
Halstead
Essex CO9 2SX



Tel : +44 (0) 1787 475151
Fax : +44 (0) 1787 475579
email : tech@wadedrainage.co.uk
website : www.wadedrainage.co.uk

Ask your Ashworth branch for a copy of the 'Wade Drainage Products Selection and Installation Guide'

FLOOR GULLIES AND ACCESS COVERS



Wade offers a comprehensive range of quality floor drains, floor gullies and access covers, to suit a myriad of applications. For most floor finishes and construction types, Wade can offer a tailor made solution from their standard floor drain range. For applications beyond that, Wade can also design and produce special products to suit your specification.



VARI-LEVEL TRAPPED AND NON-TRAPPED GULLIES

Vari-Level floor drains, floor gullies and access covers have a fine thread to enable accurate installation at finished floor level.

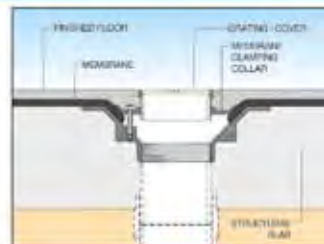
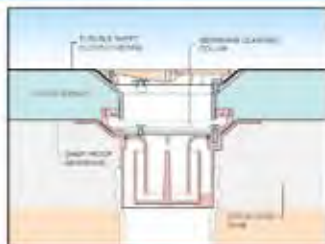

DIRECT CONNECTION GRATINGS AND ACCESS COVERS

Direct connection gratings and access covers will connect to standard pipework systems by means of proprietary couplings.

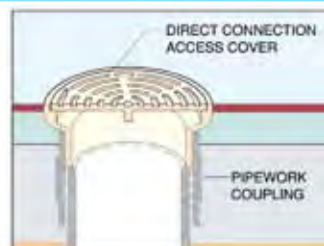
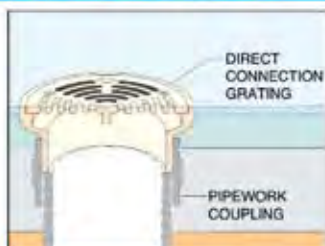

STAINLESS STEEL TRAPPED AND NON-TRAPPED GULLIES

Stainless steel floor gullies are particularly suited for use in areas associated with food production.

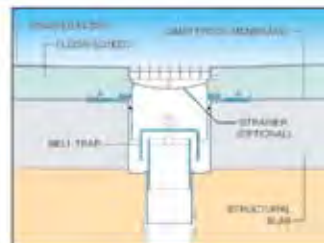
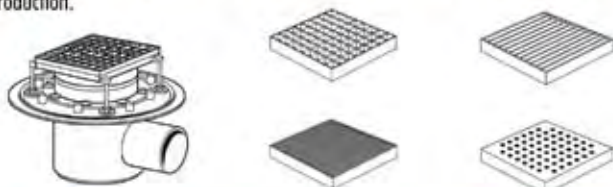

GULLIES FOR UNFINISHED FLOORS

Multi-Level floor gullies are height adjustable, for use in unfinished floors (trapped & non-trapped versions available).

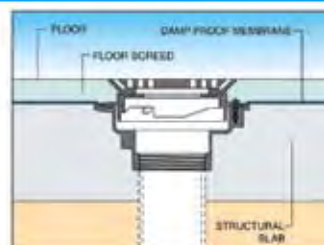
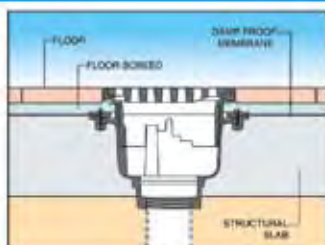

SHOWER GULLIES

This range features an extremely compact 'P' trapped or vertical trapped outlet ABS gully body, with a choice of eight different tops.



ROOF OUTLETS



Wade designs and manufactures roof outlets for use with specific types of roof construction, worldwide. This guide illustrates the range of standard assembly types available to suit most common applications. Custom made products and accessories can be designed to suit particular applications. Please contact our Technical Services Dept for details.



ROOF OUTLETS FOR WARM ROOF

Wade offers a range of roof outlets for use in warm roofs, suitable for use with a wide range of insulation thicknesses.



3400 Series (Medium Sump) roof outlet with optional accessories. Load-bearing applications

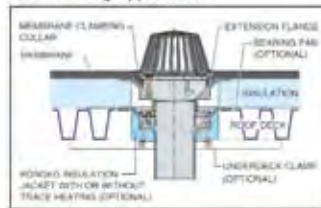

Non Load-bearing applications

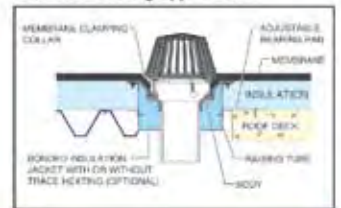

ROOF OUTLETS FOR COLD ROOF

Wade offers a range of roof outlets for use in cold roofs, illustrated above.



3400 Series (Medium Sump) roof outlet.

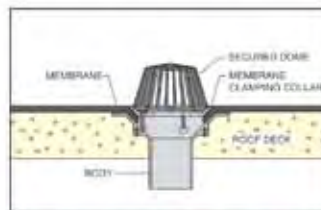

3100 Series (Deep Sump) roof outlet with optional accessories.

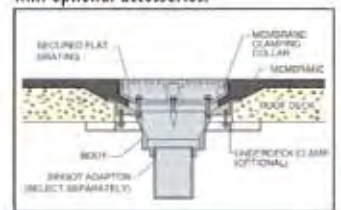

ROOF OUTLETS FOR INVERTED ROOF/NO FINES SCREED

Wade offers a range of roof outlets for use in inverted and no-fines screed roofs, as illustrated above.



3400 Series (Medium Sump) roof outlet with optional accessories.

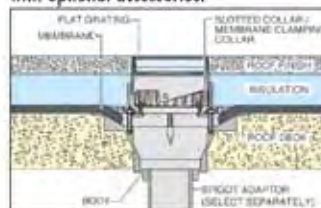

3100 Series (Deep Sump) roof outlet with optional accessories.

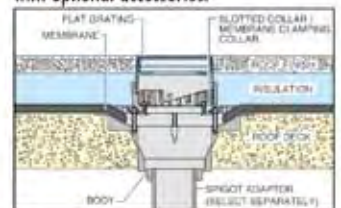

PARAPET OUTLETS AND BALCONY OUTLETS

Wade offers a range of reversible parapet outlets, downspout nozzles and balcony outlets.

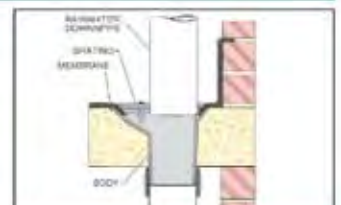

GREEN ROOF/PLANTING AREA DRAINAGE OUTLETS

Wade offers a range of products providing drainage of moisture in planting areas without loss of soil.

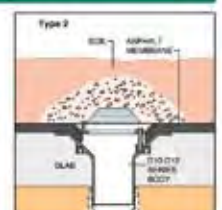
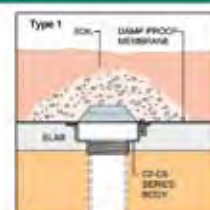
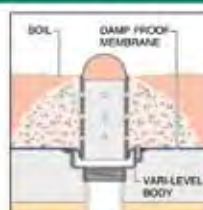

LINEAR DRAINAGE



In addition to offering a wide range of standard products, Wade designs and manufactures custom made products to suit particular applications. Recent projects include banks, hospitals, hotels, laboratories, leisure centres, municipal buildings, museums, private residences and sports arenas. Availability of faceted channel systems extends choice for specifiers.



STAINLESS STEEL CHANNEL AND GRATING

Channel for use with gratings is available in a range of profiles to suit a variety of floor finishes.

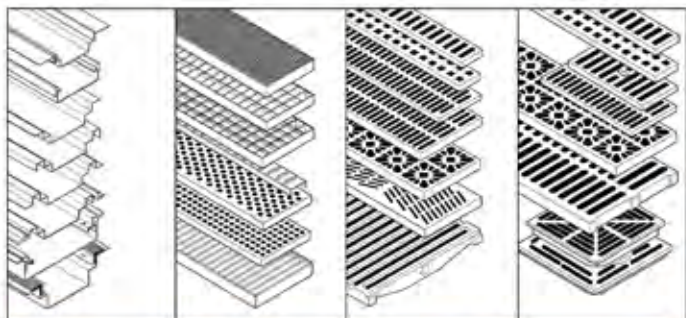

Typical Installations

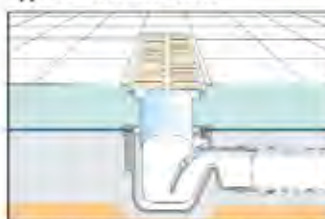

With G304 LD 'P' trapped cast iron gully body

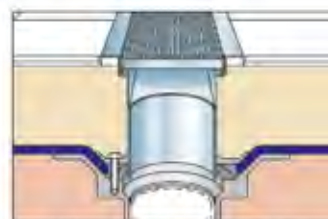

With D1004 LD Non-trapped cast iron body

DUAL-LEVEL DRAINAGE CHANNEL

Provides primary drainage at finished floor level plus secondary drainage at membrane level.

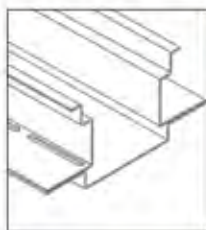

Single Secondary Drainage (SSD) with Channel Profile RP

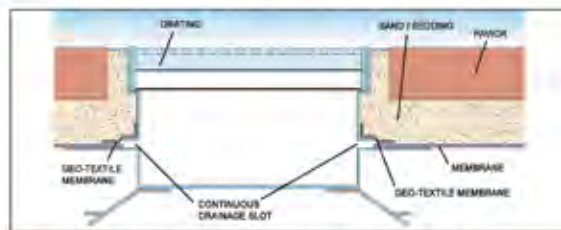

Double Secondary Drainage (DSD) with Channel Profile RP

SUPASLOT CHANNEL

Supaslot channels are suited for large areas with only low volumes of waste water such as in abattoirs, butcheries, dairies, breweries etc. Neat and unobtrusive, the channels are a popular choice as a barrier between designated wet and dry zones, such as between dishwashing and cooking areas of a kitchen.

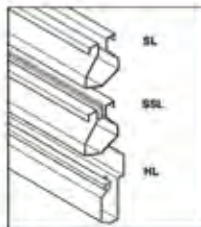

HIDDEN CHANNEL

Hidden channels are suited for draining large areas finished with block paving and can be designed to accommodate a range of paving thicknesses and flow rate requirements.

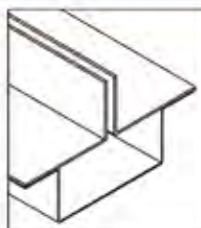

Spec Code: HC

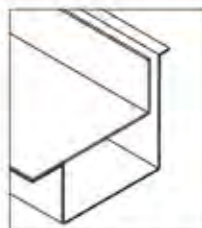

Spec Code: HCE

Designed for use against a wall



A question of time?

The answer's EEZI.

The Ensign cast iron drainage system has already answered 'The Burning Question' with its superior fire resistance. It silenced the opposition with its 'Hearing is Believing' campaign, proving to be the quietest system on the market.

Now there's Ensign **EEZI-FIT**, a new push-fit range of socketed fittings and coupling in 100 & 150mm diameter, designed for above ground gravity sanitary applications, that combines all the benefits of cast iron with the simplicity of push-fit assembly.

Ensign – the most comprehensive range on the market

Ensign offers individual cast iron drainage systems for above and below ground applications, and is the only system, tested and Kitemark approved to the product standard BS EN 877 in the UK.



EEZI-FIT – the next generation of cast iron systems

A quick to install push-fit coupling and a range of push-fit socketed fittings compatible with all products within the existing Ensign range – improving even further the most versatile above ground system on the market.

The EEZI-FIT coupling and fittings are intended for use for gravity – above ground sanitary applications – in accordance with BS EN 12056; and designed to meet product standard BS EN 877:1999.

Included in the range are single and double branches with up to four waste connections – and a new manifold connector – making it an ideal solution for flats and apartments.



Quality Assurance

BS EN ISO 9001:2000
Registered No:FM12908

The Ensign system is manufactured under the BS EN ISO 9001: 2000 Quality Assurance Scheme. Continual checks made throughout the year by the BSI inspectorate, ensure that the set standards are maintained.



Product Certification

BS EN 877:1999 Kitemark KM51733
Ensign is the only cast iron system to be tested and awarded Kitemark approval to the new product standard in the UK. Ensign EEZI-FIT is included under the above certification for sanitary applications

Summary of Applicable Standards

UK and European Standard BS EN 877:1999
BS EN 14366:2004 – laboratory measurement of noise from waste water systems.
BS EN 8233:1999 – code of practice for governing acoustics within buildings.

Product Standards

BS EN 681/ISO 4633 – specification for elastomeric seals for joints in pipework and pipelines.

Codes of Practice Standards

BS EN 12056-2 – code of practice for gravity drainage systems inside buildings – sanitary pipework.



Features

- A range of 100 & 150mm diameter push-fit fittings and coupling.
- New gasket design that makes the joint simple to install and completed in seconds.
- New multi-waste radius branches with up to four boss connections available either plain or with rear access door.
- New manifold connector with extended spigot length.
- The range connects to standard Ensign double spigot pipe and is fully compatible with all Ensign double spigot fittings.
- Red epoxy coated.
- Kitemark to BS EN 877:1999 for gravity soil installations (0.5 bar performance).
- Coupling has been tested to 2 bar pressure suitably restrained – better than any push-fit gravity system on the market.
- Electrical continuity can be accommodated if required.

Benefits

all the benefits of cast iron – with the advantages of push-fit assembly.

- The natural non-combustibility of cast iron – providing superior fire resistance – and no additional protection required – giving further labour saving opportunities.
- Ensign and Ensign EEZI-FIT, when installed with the ductile iron bracket fitted with the new acoustic dampener, are the quietest cast iron systems and the quietest material by up to 10dB(A) over any other system.
- The Ensign mechanical joint can be positioned in the system to allow dismantling for future retro-fit.
- The new manifold design eliminates having a joint in the floor slab for further ease of installation.
- Presents opportunities to reduce time for testing the installation.
- Cast iron as a drainage material requires fewer brackets than other systems like HDPE, Stainless Steel and UPVC (see BS EN 12056 guidelines Table NF1).
- No specialist tools required.
- Ideal solution for flats and apartments which demand a high level of acoustic performance and fire safety.

EEZI-FIT is available in **NEW** 150mm sizes

Environment Standard

BS EN ISO 14001: 2004

Saint-Gobain Pam manufacturing sites, including Sinclair at Telford, have been awarded the 'Manufacturing to Environmental Standards' accreditation BS EN ISO 14001: 2004 which was developed to help manufacturers maintain and improve their management of environmental responsibilities and assist them in ensuring compliance with environmental laws and regulations.

Saint-Gobain Pam operates to Integrated Pollution and Preventative Control (IPCC) regulations, and has implemented comprehensive environmental management systems throughout its manufacturing sites.

Ensign EEZI-FIT is made from **97% recyclable materials and is 100% recyclable**



Technical Advisory Service

Saint-Gobain Pam offers a comprehensive technical advisory service. The technical team can provide the customer with installation advice and 'take-off' service free of charge.

Tel: 01952 262529 Fax: 01952 262592



BENEFITS OF CAST IRON

Fire Safety

- Cast iron is proven to be the safest material in the event of a fire.
 - ◆ Non combustible
 - ◆ Flame resistant for 4 hours
 - ◆ No emission of toxic fumes or sooty smog - biggest killer in any fire
 - ◆ Eliminates the threat of fire spread to other compartments completely, unlike some plastic systems
 - ◆ No fire collars

Acoustic Performance

- The Ensign cast iron system has been tested to the new standard BS EN 14366:2004 at an independent testing laboratory.
 - ◆ Ensign out-performs any other material by up to 9dB(A) for structure borne noise at 2l/s or 4l/s.
 - ◆ Out-performing all sound attenuated plastic systems and HDPE
 - ◆ A difference of 4dB(A) is the equivalent of noise x 2
 - ◆ Opportunities to save on expensive insulation costs

Sustainable

- Cast iron is one of the most sustainable materials for drainage.
 - ◆ Made from 97% recyclable material - is 100% recyclable with a residual value that ensures this happens
 - ◆ Cast iron should never be a candidate for landfill
 - ◆ Life time promise - not uncommon to exceed 100 years life with minimal environmental impact
 - ◆ Best drainage solution for brownfield sites - re-using existing land
 - ◆ Less bedding required, less insulation - less is more when it comes to safeguarding natural resources
 - ◆ Greenpeace recommended - no greater approbation

Strength

- The strongest soil and drain material
 - ◆ Superior crush resistance
 - ◆ Exceptional resistance to over vigorous rodding
 - ◆ Best in areas of unstable ground
 - ◆ Best against accidental damage and vandalism

Ease of Installation

- Cast iron drainage systems have no added complications
 - ◆ No fire collars/cladding, expansion joints, thermal limiters, sound insulation
 - ◆ Requires less brackets (see BS EN 12056-2 guidelines, table NF.1)
 - ◆ No special tools to buy or hire

Versatility - Cost Effective

- Cast iron drainage systems are the most versatile on the market
 - ◆ Simple mechanical high performing couplings
 - ◆ Push-fit couplings to reduce installation time
 - ◆ Future retro-fit - can be dismantled and redirected on refurbishments
 - ◆ Ideal choice for PFI buildings - minimal maintenance for 30 years
 - ◆ Fit and forget

The Three Big Names in Cast Iron Drainage



First choice for:

- Listed Buildings
- Buildings of Character
- Conservation Areas
- Quality Homes

Traditional cast iron rainwater and gutter systems to BS 460



First choice for:

- New Commercial and Public Buildings
- Offices, Shopping Centres, Retail
- Hospitals, Schools, Prisons
- Hotels, Flats, Apartments

Complete cast iron drainage systems for above and below ground to BS EN 877



First choice for:

- Refurbishment
- Commercial and Public Buildings
- External Pipework
- Underbuilding Drainage

Complete cast iron drainage systems for above and below ground to BS 416 and BS 437



EPAMS SYPHONIC SYSTEM NEW RANGE

A complete Syphonic rainwater system consisting of Steel Syphonic Roof outlets, and cast iron pipework to BS EN 877.

EPAMS is fully supported by computer software to correctly calculate the system criteria, and a technical team to provide design and on-site advice throughout the project.

Epams combines the benefits of syphonic design:

- Smaller number of outlets
- Smaller diameter of pipework
- Fewer downpipes
- Possibility of reduced below ground drainage

.....with the benefits of cast iron

- Strength to withstand negative pressures
- Acoustic performance
- Long life



Features

- Steel outlets in 50, 75, 100 and 125mm diameters
- Suitable for most types of commercial roof
- Pipes and fittings from 50mm to 300mm diameter
- Stainless steel couplings and grip collars for joints at changes in direction.

EPAMS consists of steel roof outlets in 50, 75, 100, and 125mm diameters in variations to suit any roof type connecting to SMU cast iron pipework in diameters 50 to 300mm diameter manufactured to BS EN 877.

The EPAMS range is the ideal choice for syphonic rainwater drainage, with its strong, high capacity outlets and the peace of mind of cast iron pipes and fittings, which are non-combustible, quieter than other materials, has a longer life expectancy and its mechanical resistance means it easily withstands the positive and negative pressures. Saint-Gobain Pam is a member of the Syphonic Rainwater Drainage Association (SRDA)

EPAMS

ORDER CODE	DESCRIPTION	MANUFACTURERS REF
50mm		
99230000	Syphonic Roof Outlet with Plate	171081
99230008	Syphonic Roof Outlet for PVC Membrane	171286
99230016	Syphonic Roof Outlet with Flange	171288
99230024	Syphonic Roof Outlet to be Welded	171283
75mm		
99230002	Syphonic Roof Outlet with Plate	171287
99230010	Syphonic Roof Outlet for PVC Membrane	171287
99230018	Syphonic Roof Outlet with Flange	171289
99230026	Syphonic Roof Outlet to be Welded	171284
Other Items		
99230032	Elevating Kit Gravel Protection Height 90mm	171291
99230034	Elevating Kit Gravel Protection Height 250mm	171292
99230036	Anti Vortex Grille	171293
99230038	Kit of 3 Fixing Screws/Nuts/Bolts	171295

(Please contact your nearest Ashworth branch for full product listing)

ENSIGN EEZI-FIT NEW RANGE

A quick to install push-fit coupling and a range of push-fit socketed fittings compatible with all products within the existing Ensign range – improving even further the most versatile above ground system on the market.

Features

- A range of 100 & 150mm diameter push-fit fittings and coupling.
- New gasket design that makes the joint simple to install and completed in seconds.
- New multi-waste radius branches with up to four boss connections available either plain or with rear access door.
- New manifold connector with extended spigot length.
- The range connects to standard Ensign double spigot pipe and is fully compatible with all Ensign double spigot fittings.
- Red epoxy coated.
- Kitemark to BS EN 877:1999 for gravity soil installations (0.5 bar performance).
- Coupling has been tested to 2 bar pressure suitably restrained – better than any push-fit gravity system on the market.
- Electrical continuity can be accommodated if required.

ENSIGN EEZI-FIT BS EN 877 - Kitemark Approved

ORDER CODE	DESCRIPTION	MANUFACTURERS REF	
100mm			
99202500	Coupling	EZ001	208191
99202510	88 deg Bend Plain	EZ002	208192
99202520	45 deg bend	EZ002	208193
99202530	88 deg bend door heel	EZ005	208194
99202540	88 deg Branch Rad Curve	EZ06R	208195
99202550	45 deg Branch Single	EZ006	208196
99202560	88 deg Branch Rad Curve Door Back	EZ07R	208197
99202570	88 deg Branch Rad Curve Double	EZ010R	208198
99202580	Boss Pipe 1-60 Bosses Push-Fit	EZ090	208199
99202590	Boss Pipe 2-60 Bosses Push-Fit Opposed	EZ091	208200
99202600	Boss Pipe 2-60 Bosses Push-Fit @90	EZ092	208201
99202610	Boss Pipe 3-60 Bosses Push-Fit	EZ093	208202
99202620	Manifold 2-50 Waste Connections ext Tail	EZ094	208203
99202630	EEZI-FIT Gaskets (bag of 10)		208204
99202640	Continuity Clips (bag of 30)		208462
99202650	Rubber Grommets for Boss Connection (bag of 10)		208205
99202660	51mm Hole Saw		208206
99202670	EEZI-FIT Lubricant (500 gram tub)		199037

Note: 150mm available early 2009



ENSIGN SOIL & DRAIN

The Complete Pipe System

Ensign is the complete above and below ground drainage solution for all building needs, transporting fluid waste through the building, out and beyond. Ensign is the ONLY cast iron system to be Kitemark approved to product standard BS EN 877.

Features

- Largest above ground diameter range: 50 to 600mm
- Below ground range: 100 to 600mm diameters
- Pipes epoxy lined for superior chemical resistance
- Fittings internally and externally epoxy coated
- Two-piece ductile iron couplings capable of up to 5bar pressure suitability restrained
- Push-fit drain couplings for fast pipe laying
- Economical connections to waste pipes:
 - ♦ Compression fit boss pipes
 - ♦ Mult-waste manifolds in 100 and 150mm diameters
 - ♦ Push-fit bank ends
 - ♦ Alternative BSPT options
- New radius boss branches single and double with 4 boss positions and extended spigot to pass through the floor slab
- Ductile iron brackets
- Acoustic brackets for exceptional performance
- Extensive range of access fittings for ease of maintenance
- Lightweight and cost effective



SAINT-GOBAIN
PAM UK



Design of the symbol, comprising the registered wordmark, is the property of Kitemark.

For more information call
0800 783 7680

(Please contact your nearest Ashworth branch for full product listings)

ENSIGN SOIL

ENSIGN SOIL BS EN 877 - KITEMARK APPROVED

ORDER CODE	DESCRIPTION	MANUFACTURERS REF	
50mm			
99202245	3m Pipe	156363	EP000
99200100	Coupling - Two Piece Ductile	156398	EC002
99200172	Push Fit Joint - No Ears	192268	EC001P
99200176	Push Fit Joint - Eared	192267	EC001E
99201560	Pipe Bracket - Ductile Iron	156408	EF048
99200270	88deg Bend - Short Radius	191437	EF002
99200720	88deg Branch Single	191469	EF006
99201230	Access Pipe Round Door	191516	EF014
99201525	P Trap Access Door Bottom	156419	EF037
99201940	Blank End Plain	191570	EF070
99201995	Universal Connector 50x56/48/40	155759	EF071
99202120	Single Boss Pipe Compression 50mm	156371	EF090
70mm			
99202260	3m Pipe	156455	EP000
99200110	Coupling - Two Piece Ductile	156493	EC002
99200173	Push Fit Joint - No Ears	192269	EC001P
99200177	Push Fit Joint - Eared	192268	EC001E
99201565	Pipe Bracket - Ductile Iron	156505	EF048
99200320	88deg Bend - Short Radius	191442	EF002
99200685	88deg Bend - Short Radius Rear Access	156472	EF005
99200765	88deg Branch Single	191475	EF006
99201235	Access Pipe Round Door	191517	EF014
99201380	Taper Pipe x 50mm	191532	EF028
99201530	P Trap Access Door Bottom	156618	EF037
99202070	Expansion Plug	191582	EF074
99201945	Blank End Plain	191571	EF070
99202110	Single Boss Pipe Compression 50mm	156460	EF090
99201655	Stack Support Pipes	191856	EF050
99201705	Stack Support Bracket c/w Rubber Seal	191857	EF051
99201730	Cantilever Arm Bracket for Stack Support	192329	EF052
100mm			
99202265	3m Pipe	156563	EP000
99200120	Coupling - Two Piece Ductile	156634	EC002
99200174	Push Fit Joint - No Ears	192272	EC001P
99200178	Push Fit Joint - Eared	192271	EC001E
99201570	Pipe Bracket - Ductile Iron	156646	EF048
99201607	Bracket Acoustic	199883	EF048AD
99200370	88deg Bend - Short Radius	191447	EF002
99201305	88deg Bend - Long Radius	191549	EF02L
99200680	88deg Bend - Short Radius Rear Access	156589	EF005
99201620	88deg Bend - Long Radius Rear Access	156607	EF05L
99201765	88deg Long Tail Bend	191567	EF055
99200810	45deg Branch Single	191483	EF006
99201810	88deg Branch Single (Radius)	156696	EF06R
99201900	88deg Branch Single Rear Access (Radius)	156697	EF07R
99201150	88deg Double Branch	191511	EF010
99202190	88deg Double Branch (Radius)	157643	EF010R
99201510	x 100mm 88deg Corner Branch	191558	EF035
99201520	88deg Corner Branch - Long Tail	191559	EF036
99201240	Access Pipe Round Door	191518	EF014
99201350	Offset x 75mm projection	191526	EF024
99201385	Taper Pipe x 50mm	191533	EF028
99201535	P Trap Access Door Bottom	156667	EF037
99202105	Branch Trap	191587	EF080
99202055	Roof Connector (for Asphalt)	191581	EF073
99202075	Expansion Plug	191583	EF074
99202355	Stench Trap	155841	EF061
99201950	Blank End Plain	191572	EF070
99202010	Blank End x 2" (Push Fit Connector)	191578	EF071
99202115	Single Boss Pipe Compression 50mm	156573	EF090
99202155	Double Boss Pipe Compression Opposed 50mm	156575	EF091
99202160	Double Boss Pipe Compression 90 Deg 50mm	191849	EF092
99202180	Manifold Connector (suitable for push-fit 38/32mm waste)	175626	EF094
99201635	Stack Support Pipes	191562	EF050
99201710	Stack Support Bracket c/w Rubber Seal	191843	EF051
99201730	Cantilever Arm Bracket for Stack Support	192329	EF052
99202365	Boss Branches Single x 4 Boss	208644	EF096
99202370	Boss Branches Double x 4 Boss	208653	EF097

(The above Ensign Soil range is available up to 600mm dia.)

To discuss your Ensign requirements further with an experienced Ashworth Sales Advisor

Freephone: 0800 783 7680

(Please contact your nearest Ashworth branch for full product listings)

ENSIGN SOIL

ENSIGN SOIL BS EN 877 - - KITEMARK APPROVED



ORDER CODE	DESCRIPTION	MANUFACTURERS REF	
150mm			
99202270	3m Pipe	156827	EP000
99200140	Coupling - Two Piece Ductile	156888	EC002
99200175	Push Fit Joint - No Ears	192315	EC001P
99200179	Push Fit Joint - Eared	192316	EC001E
99201575	Pipe Bracket - Ductile Iron	156898	EF048
99200410	88deg Bend - Short Radius	191459	EF002
99201310	88deg Bend - Medium Radius	191550	EF02L
99200690	88deg Bend - Short Radius Rear Access	156845	EF005
99201125	88deg Branch Single	191501	EF006
99201835	x 100mm 88deg Branch Single (Radius)	156889	EF06R
99201925	x 100mm 88deg Branch Single Rear Access (Radius)	156875	EF07R
99201200	x 100mm 88deg Double Branch (Radius)	156862	EF010R
99201245	Access Pipe Round Door	191519	EF014
99201400	Taper Pipe x 100mm	191540	EF028
99201540	P' Trap Access Door Bottom	156911	EF037
99202080	Expansion Plug	191584	EF074
99201955	Blank End Plain	191574	EF070
99202135	Single Boss Pipe Compression 50mm	156836	EF090
99202350	Manifold Connector (suitable for push-fit 50mm waste)	175629	EF094
99201645	Stack Support Pipes	191564	EF050
99201720	Stack Support Bracket c/w Rubber Seal	191845	EF051
200mm			
99202280	3m Pipe	156951	EP000
99200150	Coupling - Two Piece Ductile	156998	EC002
99201580	Pipe Bracket - Ductile Iron	177745	EF048
99200435	88deg Bend - Short Radius	191462	EF002
99200895	88deg Branch Single	191505	EF006
99201410	Taper Pipe x 150mm	191544	EF028
99201960	Blank End Plain	191575	EF070
250mm			
99202290	3m Pipe	157049	EP000
99200160	Coupling - Two Piece Ductile	175552	EC002
99201582	Wild Steel Pipe Support Bracket - Stand Off	192260	EF048MS
99200495	88deg Bend - Short Radius	191463	EF002
99201440	Taper Pipe x 200mm	191547	EF028
99201970	Blank End Plain	191576	EF070
300mm			
99202295	3m Pipe	157114	EP000
99200170	Coupling - Two Piece Ductile	175510	EC002
99200582	Wild Steel Pipe Support Bracket - Stand Off	192261	EF048MS
99200515	88deg Bend - Short Radius	191431	EF002
99201455	Taper Pipe x 250mm	191531	EF028
99201975	Blank End Plain	191569	EF070

The above Ensign Soil Range is available up to 600mm dia.

Call us for more information.

DONT FORGET Your Hanging Systems

Call us for a brochure



ENSIGN DRAIN

ENSIGN DRAIN BS EN 877 - - KITEMARK APPROVED



ORDER CODE	DESCRIPTION	MANUFACTURERS REF	
100mm			
99220100	3m Pipe	155349	ED000
99220170	Coupling - Two Piece Ductile	155369	ED001
99220235	Push Fit Drain Coupling	175622	ED004
99220640	Pipe Bracket - Ductile Iron	175593	ED048
99220200	45deg Bend - Short Radius	191765	ED002
99220545	45deg Bend - Medium Radius	191772	ED02M
99220530	88deg Bend - Long Radius	191774	ED02L
99220690	88deg Bend - Long Radius Heel Rest	192289	ED007
99220260	45deg Branch Single	191782	ED006
99220320	45deg Branch Double	191798	ED010
99220470	Access Pipe Oval Door	191805	ED014
99220605	P' Trap Access Door Bottom	182482	ED037
99220875	Expansion Plug	191823	ED074
99220830	Blank End Plain	191818	ED070
99220900	Connector to Supersleve	191813	ED076
99220790	Bellmouth fitted with Sealed Cover	191852	ED066
99220920	Puddle Flange	191829	ED078
99220450	x 100mm 45deg Inspection Chamber	191832	ED012
150mm			
99220120	3m Pipe	155414	ED000
99220175	Coupling - Two Piece Ductile	155433	ED001
99220240	Push Fit Drain Coupling	175623	ED004
99220645	Pipe Bracket - Ductile Iron	175594	ED048
99220205	45deg Bend - Short Radius	191766	ED002
99220550	45deg Bend - Medium Radius	191773	ED02M
99220535	88deg Bend - Medium Radius	191775	ED02L
99220625	88deg Bend - Heel Rest	192290	ED007
99220270	45deg Branch Single	191784	ED006
99220475	Access Pipe Oval Door	191806	ED014
99220570	x 100mm Taper Pipe	191810	ED028
99220610	P' Trap Access Door Bottom	182483	ED037
99220880	Expansion Plug	191824	ED074
99220835	Blank End Plain	191819	ED070
99220905	Connector to Supersleve	191814	ED076
99220795	Bellmouth fitted with Sealed Cover	191853	ED066
99220925	Puddle Flange	191830	ED078
99220455	x 100mm 45deg Inspection Chamber	191833	ED012
99220460	x 150mm 45deg Inspection Chamber	191834	ED012
200mm			
99220130	3m Pipe	155448	ED000
99220180	Coupling - Two Piece Ductile	155462	ED001
99220650	Pipe Bracket - Ductile Iron	177743	ED048
99220210	45deg Bend - Short Radius	191767	ED002
99220285	45deg Branch Single	191787	ED006
99220505	Access Pipe Rectangular Door	191809	ED015
99220580	x 150mm Taper Pipe	191812	ED028
99220840	Blank End Plain	191820	ED070
250mm			
99220140	3m Pipe	155476	ED000
99220185	Coupling - Two Piece Ductile	175591	ED001
99220212	45deg Bend - Short Radius	191879	ED002
99220290	45deg Branch Single	191881	ED006
300mm			
99220150	3m Pipe	155493	ED000
99220190	Coupling - Two Piece Ductile	175602	ED001
	45deg Bend - Short Radius	191880	ED002
99220295	45deg Branch Single	191882	ED006

(The above Ensign Drain range is available up to 600mm dia.)



TIMESAVER HERITAGE

The Timesaver soil system Kitemarked to BS416 Part 2 now contains a push-fit coupling that turns a mechanical pipe system into one with a traditional socket appearance of yesteryear, but without the labour intensive caulked jointing method.

The black primer coating of the Timesaver system makes it easy to overpaint for external soil stacks, and is the perfect solution for listed buildings and those situated in areas of conservation.

The Heritage couplings are available in 50, 75 (new) and 100mm diameters, and can be used on the majority of the Timesaver soil fittings. (NOTE: cannot be used with old beaded Timesaver soil fittings)

Pipes are available in the standard 3m lengths, and in 75mm and 100mm a 1.8m (6ft) length has been made available.



TIMESAVER HERITAGE SYSTEM - BS416 PART 2 - BS KITEMARK APPROVED

ORDER CODE	DESCRIPTION	MANUFACTURERS REF	
50mm			
99160055	3m Double Spigot Pipe	GT00	08863
99161627	Heritage Coupling Eared	GT05E	09425
99161625	Heritage Coupling Plain	GT05P	09426
99161628	Heritage Slip Coupling Eared	GT05S	09427
99161636	Wall Spacer Plate Black (to suit GT05E)		09432
75mm			
99160040	1.8m (6ft) Double Spigot Pipe	206854	GT00
99161652	Heritage Coupling Eared	206856	GT05E
99161650	Heritage Coupling Plain	206855	GT05P
99161654	Heritage Coupling Slip	206836	GT05S
99161637	Wall Spacer Plate (to suit GT05E)	206838	
100mm			
99160050	1.8m (6ft) Double Spigot Pipe	192423	GT00
99160070	3m Double Spigot Pipe	156567	GT00
99161632	Heritage Coupling Eared	192420	GT05E
99161630	Heritage Coupling Plain	192421	GT05P
99161634	Heritage Slip Coupling Eared	192422	GT05S
99161638	Wall Spacer Plate Black (to suit GT05E)	156132	
99161640	Mild Steel Bracket to suit 100mm Coupling	192425	
99161642	Mild Steel Bracket (extended arm by 450mm)	192333	EF063

TIMESAVER SOIL

Prestigious commercial buildings built in the 1970's to the mid 90's which are serviced by cast iron soil stacks will more than likely be Timesaver. If the building is to be refurbished and changes required, the latest Timesaver range is best suited to the original pipework.

- Traditional British standard design fittings
- Extensive range of access fittings ie bends/branches door side
- Strap-on-boss fitting to connect waste to the main stack
- Pipes and fittings black primer coated

TIMESAVER SOIL - BS416 PART 2 - BS KITEMARK APPROVED

ORDER CODE	DESCRIPTION	MANUFACTURERS REF	
50mm			
99160055	3m Pipe	156368	GT00
99160100	Standard Coupling	191691	GT01
99161280	Support Bracket	191720	GT48
99160135	87.5deg Short Radius Plain Bend	191620	GT02
99160235	87.5deg Short Radius Rear Access Bend	191636	GT03
99160355	87.5deg Single Plain Branch	191649	GT06
99160520	87.5deg Single Rear Access Branch	191665	GT07
99161360	Blank Cap Plain	191724	GT70
99160750	Single Boss Pipe x 50mm Compression	192236	GT106
99161610	Continuity Clips to suit 50, 75 & 100mm GT01 Coupling (Pack of 25)	191189	GT965
75mm			
99160060	3m Pipe	156456	GT00
99160105	Standard Coupling	191692	GT01
99161285	Support Bracket	191721	GT48
99160145	87.5deg Short Radius Plain Bend	191622	GT02
99160245	87.5deg Short Radius Rear Access Bend	191638	GT03
99160375	87.5deg Single Plain Branch	191653	GT06
99160540	87.5deg Single Rear Access Branch	191668	GT07
99160850	Access Pipe Oval Door	191697	GT14
99161080	Taper Pipe x 50mm	191710	GT28
99161365	Blank Cap Plain	191725	GT70
99160755	Single Boss Pipe x 50mm BSPT	191739	GT106
100mm			
99160070	3m Pipe	156557	GT00
99160110	Standard Coupling	191693	GT01
99160560	Support Bracket	191722	GT48
99160165	87.5deg Short Radius Plain Bend	191631	GT02
99160210	87.5deg Long Radius Plain Bend	191630	GT02L
99160255	87.5deg Short Radius Rear Access Bend	191642	GT03
99160295	87.5deg Short Radius Side Access Bend	191646	GT04
99161235	87.5deg Long Tail Bend	191688	GT43
99160390	87.5deg Single Plain Branch	191660	GT06
99160550	87.5deg Single Rear Access Branch	191674	GT07
99160595	87.5deg Single RH Side Access Branch	191679	GT08
99160600	87.5deg Single LH Side Access Branch	191680	GT09
99160630	87.5deg Double Plain Branch	191683	GT10
99160790	87.5deg Double Access Branch	191685	GT11
99161150	Corner Branch	191687	GT35
99160855	Access Pipe Oval Door	191698	GT14
99161055	Offset 75mm projection	191705	GT24
99161085	Taper Pipe x 50mm	191711	GT28
99161370	Blank Cap Plain	191726	GT70
99161175	P Trap with Heel Access	191717	GT37
99160760	Single Boss Pipe x 50mm Compression	192237	GT106
99160770	Double Boss Pipe x 50mm Compression Opposed	192240	GT109
99160805	Double Boss Pipe x 50mm Compression 90 deg	192241	GT115
99160845	Strap-on-boss	192323	GT133
PBCTS180	64mm Hole Saw	192326	
99160450	87.5deg Branch with 50mm BSPT Rear Boss	191743	GT06
150mm			
99160080	3m Pipe	156831	GT00
99160115	Standard Coupling	191694	GT01
99161295	Support Bracket	191723	GT48
99160175	87.5deg Short Radius Plain Bend	191634	GT02
99160420	87.5deg Single Plain Branch	191664	GT06
99160635	87.5deg Double Plain Branch x 100mm	191684	GT10
99160860	Access Pipe Oval Door	191699	GT14
99161095	Taper Pipe x 100mm	191713	GT28
99161375	Blank Cap Plain	191727	GT70
99160765	Single Boss Pipe x 50mm Compression	192239	GT106
99161605	Continuity Clips to suit 150mm GT01 (Pack of 25)	191190	GT96L

TIMESAVER DRAIN

The below ground system is recognised as the strongest of all the drainage systems in any material. The substantial section thickness of BS437, makes it the first choice for under building drainage, especially commercial buildings, where fit and forget is a high priority and provides peace of mind. Timesaver drain also excels in areas of unstable ground, and ground containing methane gases. Ideal for shallow trenches or under roads.

- Traditional British standard fittings
 - ◆ Access fittings
 - ◆ Gully traps
 - ◆ Raising pieces
- ◆ Inspection chamber
- ◆ Intercepting traps
- ◆ Anti-flooding devices



TIMESAVER DRAIN - BS437 - BS KITEMARK APPROVED



ORDER CODE	DESCRIPTION	MANUFACTURERS REF	
100mm			
99180100	3m Pipe	156668	TD00
99180110	Standard Coupling	191294	TD01
99180120	Coupling Stepped Soil - Drain	191297	TD02
99181100	Hanging Bracket or Wall Fixing M12	191358	TD640
99180144	87.5deg Medium Radius Plain Bend	191219	TD06
99180136	45deg Medium Radius Plain Bend	191215	TD06
99180190	87.5deg Medium Radius Bend with Heel Rest	191230	TD07
99180452	87.5deg Long Radius Bend	191244	TD15
99180490	87.5deg Long Radius Bend with Heel Rest	191246	TD22
99180540	100mm x 45deg Plain Branch	191248	TD37
99181030	Access Pipe	191344	TD56
99180500	Blank Cap Plain	191326	TD34
99180635	45deg Clearing Arm Bend	191292	TD425
99180330	Adaptor to Supersleeve	191350	TD118
99181054	87.5deg Gully Trap Plain	191399	TD60
99181180	Taper Gully Inlet	191368	TD684
99181130	265mm Heavy Grate (For Gully Inlets)	191391	TD651
99180860	87.5deg Garage Gully Trap 300 x 600 deep	191410	TD554
99180870	Galv. Sediment pan for TD554	191184	TD554P
99180865	350mm x 55mm Grating for TD554	191382	TD554G
99181240	Loose Puddle Flange	191371	TD777
99180430	Inspection Chamber one 100mm branch each side	191306	TD14
99180470	Inspection Chamber two 100mm branch each side	191312	TD17
150mm			
99180102	3m Pipe	156832	TD00
99180112	Standard Coupling	191295	TD01
99180122	Coupling Stepped Soil - Drain	191298	TD02
99181102	Hanging Bracket or Wall Fixing M12	191359	TD640
99180166	45deg Medium Radius Plain Bend	191223	TD06
99180192	87.5deg Medium Radius Bend with Heel Rest	191231	TD07
99180420	87.5deg Long Radius Bend	191245	TD15
99180495	87.5deg Long Radius Bend with Heel Rest	191247	TD22
99180552	150mm x 45deg Plain Branch	191253	TD37
99181032	Access Pipe	191345	TD56
99180590	x 100mm Diminishing Pipe	191333	TD41
99180502	Blank Cap Plain	191327	TD34
99180335	Adaptor to Supersleeve	191351	TD118
99181056	87.5deg Gully Trap Plain	191400	TD60
99181242	Loose Puddle Flange	191372	TD777
99180432	Inspection Chamber one 100mm branch each side	191307	TD14
99180475	Inspection Chamber two 100mm branch each side	191313	TD17
99181224	Anti-Flooding Trunk Valve 'Eureka'	191420	TD750
225mm			
99180104	3m Pipe	157042	TD00
99180114	Standard Coupling	191296	TD01
99180184	45deg Medium Radius Plain Bend	191228	TD06
99180568	225mm x 45 deg Plain Branch	191259	TD37
99181034	Access Pipe	191346	TD56
99180600	x 150mm Diminishing Pipe	191335	TD41
NEW	x 250mm Diminishing Pipe to Ensign	192431	TD41
99180504	Blank Cap Plain	191328	TD34
99180405	Inspection Chamber one 150mm branch each side	191310	TD14
99180484	Inspection Chamber two 150mm branch each side	191316	TD17

Pipe Support Systems

To compliment the Drainage Systems contained within this guide Ashworth also sell Pipe Support Systems

For more information please speak to one of our experienced sales advisors

WIN A NINTENDO Wii
For your chance to win a fantastic Nintendo Wii...

VISIT US ONLINE!
www.ashworth.eu.com

For more information on Saint-Gobain Pipelines visit:

www.saint-gobain-pam.co.uk

(Please contact your nearest Ashworth branch for full product listings)

CLASSICAL PLUS RAINWATER (SEMI-GLOSS BLACK FINISH)

Pre-painted ready to install, cast iron rainwater systems in a semi-gloss, black finish for immediate installation. The coating is a Performance Polymer Alloy specifically designed to provide a long lasting tough coating for exterior applications to metal.

- Available on standard half round gutter systems and the circular downpipes and fittings
- The only cast iron system with a factory applied finished coat tested for 1000 hours salt spray and ultra-violet resistance
- Cuts installation time by up to 60%
- Durable long lasting, even finish
- Installation can be completed in a day

ROUND PIPE & FITTINGS

ORDER CODE	DESCRIPTION	MANUFACTURERS REF	
65mm			
99143130	1830mm Pipe with Eared Socket	192448	A585
99143120	1830mm Pipe with Plain Socket	192447	A585
99143180	Loose Socket Eared	192453	A586
99144230	Loose Socket Plain	192561	A586
99143210	Front Shoe Eared	192456	A588
99144310	Front Shoe Plain	192569	A588
99143240	Access Pipe Uneared	192460	A590
99143260	92.5deg Bend	192462	A591
99143270	112.5deg Bend	192463	A591
99143280	135deg Bend	192464	A591
99143350	92.5deg Branch	192471	A592
99143360	112.5deg Branch	192472	A592
99143370	135deg Branch	192473	A592
99143420	x 75mm projection Offset	192478	A594
99143440	x 150mm projection Offset	192480	A594
99143460	x 305mm projection Offset	192482	A594
99143470	x 380mm projection Offset	192483	A594
99143480	x 455mm projection Offset	192484	A594
99144326	Rainwater Diverter Kit	192397	A593
75mm			
99143150	1830mm Pipe with Eared Socket	192450	A585
99143140	1830mm Pipe with Plain Socket	192449	A585
99143190	Loose Socket Eared	192454	A586
99144240	Loose Socket Plain	192562	A586
99143220	Front Shoe Eared	192457	A588
99144320	Front Shoe Plain	192570	A588
99143250	Access Pipe Uneared	192461	A590
99143290	92.5deg Bend	192465	A591
99143300	112.5deg Bend	192466	A591
99143310	135deg Bend	192467	A591
99143380	92.5deg Branch	192474	A592
99143390	112.5deg Branch	192475	A592
99143400	135deg Branch	192476	A592
99143490	x 75mm projection Offset	192485	A594
99143510	x 150mm projection Offset	192487	A594
99143520	x 230mm projection Offset	192488	A594
99143530	x 305mm projection Offset	192489	A594
99143540	x 380mm projection Offset	192490	A594
99143550	x 455mm projection Offset	192491	A594
99144328	Rainwater Diverter Kit	192398	A593
100mm			
99143170	1830mm Pipe with Eared Socket	192452	A585
99143160	1830mm Pipe with Plain Socket	192451	A585
99143200	Loose Socket Eared	192455	A586
99143230	Front Shoe Eared	192458	A588
99144260	Access Pipe Uneared	192564	A590
99143320	92.5deg Bend	192468	A591
99143330	112.5deg Bend	192469	A591
99143340	135deg Bend	192470	A591
99143410	92.5deg Branch	192477	A592
99143560	x 75mm projection Offset	192492	A594
99143580	x 150mm projection Offset	192494	A594
99143600	x 305mm projection Offset	192496	A594
99143610	x 380mm projection Offset	192497	A594
99143620	x 455mm projection Offset	192498	A594

(Please contact your nearest Ashworth branch for full product listings)

CLASSICAL PLUS RAINWATER (cont.) (SEMI-GLOSS BLACK FINISH)

HEADS

ORDER CODE	DESCRIPTION	MANUFACTURERS REF	
300x250x200mm Rectangular			
99143000	65mm dia. Outlet	192435	A484
99143010	75mm dia. Outlet	192436	A484
99143020	100mm dia. Outlet	192437	A484
250x180x175mm Rectangular			
99143030	65mm dia. Outlet (Castellated Head)	192438	A485
99143040	75mm dia. Outlet	192439	A485
99143050	100mm dia. Outlet	192440	A485
Other Sizes			
99143060	210 x 160 x 185mm x 65mm outlet Flat Hopper Head	192441	A750
99143070	210 x 160 x 185mm x 75mm outlet Flat Hopper Head	192442	A750
99143080	250 x 215 x 215mm x 100mm outlet Flat Hopper Head	192443	A750
99143090	225 x 125 x 125mm x 65mm outlet Box Head	192444	AB41
99143100	225 x 125 x 125mm x 75mm outlet Box Head	192445	AB41
99143110	280 x 150 x 130mm x 100mm outlet Box Head	192446	AB42

HALF ROUND GUTTER

ORDER CODE	DESCRIPTION	MANUFACTURERS REF	
100mm			
99144130	1830mm Gutter	192551	G800
99143640	90deg Angle Right Hand	192500	G801
99143630	135deg Angle Right Hand	192499	G801
99143720	90deg Angle Left Hand	192508	G802
99143710	135deg Angle Left Hand	192507	G802
99144270	90deg Angle Double Socket	192566	G8020
99143790	Union Clip	192515	G803
99143830	Stop End for Spigot	192519	G804
99143870	Stop End for Socket	192523	G805
99143910	65dia Outlet Nozzle with Sockets	192527	G806
99143920	75dia Outlet Nozzle with Sockets	192528	G806
99143990	65dia Outlet Dropend with Socket	192535	G807
99144040	65dia Outlet Dropend with Spigot	192540	G808
99144090	Cast Iron Fascia Bracket (Plus coated mild steel roller brackets also available)	192545	G809
115mm			
99144140	1830mm Gutter	192552	G800
99143660	90deg Angle Right Hand	192502	G801
99143650	135deg Angle Right Hand	192501	G801
99143740	90deg Angle Left Hand	192510	G802
99143730	135deg Angle Left Hand	192509	G802
99144290	90deg Angle Double Socket	192567	G8020
99143800	Union Clip	192516	G803
99143840	Stop End for Spigot	192520	G804
99143880	Stop End for Socket	192524	G805
99143930	65dia Outlet Nozzle with Sockets	192529	G806
99143940	75dia Outlet Nozzle with Sockets	192530	G806
99144000	65dia Outlet Dropend with Socket	192536	G807
99144050	65dia Outlet Dropend with Spigot	192541	G808
99144100	Cast Iron Fascia Bracket (Plus coated mild steel roller brackets also available)	192546	G809
99142110	Joining Kit for G800 Gutter System - Pack 20 (100,115,125mm)	192284	G873

(The above HALF ROUND 'PLUS' range is also available in 125mm and 150mm)



CLASSICAL EXPRESS (PRIMED FINISH)

Classical Express is a true 'half round' gutter profile with increased flow rates over existing half round and a unique jointing clip making installation easier than ever.

- 125mm size – flow capacity of 1.5 litres per second
- Double spigot design connected by the unique clips – completed in minutes in any weather
- Fast, clean and easier to install
- Unique jointing clip enables joint to be completed in only minutes
- Drastically reduces installation times
- Use with existing 75mm Classical round downpipes
- Higher flow capacity than existing 125mm or 150mm 'half round'
- Cost effective
- Available in primer or 'PLUS' finish coat (semi-gloss black paint) options
- Double Spigot design, so fewer fittings required

Classical Express Benefits

- True half round profile gives significantly higher flow rates than traditional half round
- System able to cope with increased rainfall attributed to climate change
- Joint can be completed in a matter of minutes and in any weather
- Reduces the time and cost for scaffolding which may have to be hired
- Reduces the total installed time
- Double spigoted design means fewer fittings so ordering, delivery and stocking are much simpler
- Competitively priced against other metal manufacturers
- Lower cost than existing 125mm and 150mm half round profiles



EXPRESS GUTTER

ORDER CODE	DESCRIPTION	MANUFACTURERS REF	
125mm			
99144400	1830mm Gutter	192349	G880
99144410	90deg Angle (Internal / External)	192341	G881
99144420	45deg Angle (Internal / External)	192342	G882
99144430	Transitional Connector to 115mm & 125mm BS460 Gutter	192343	G883
99144440	Stop End	192344	G884
99144450	75dia Outlet Nozzle	192345	G885
99144460	Cast Iron Fascia Bracket	192340	G886
99144470	Gutter Jointing Clip (Box of 20)	192346	G887

CLASSICAL EXPRESS PLUS (SEMI-GLOSS BLACK FINISH)

Classical Express Plus features and benefits are the same as for Classical Express.

The Classical Express Plus System is available in the factory applied semi-gloss black finish for immediate installation.

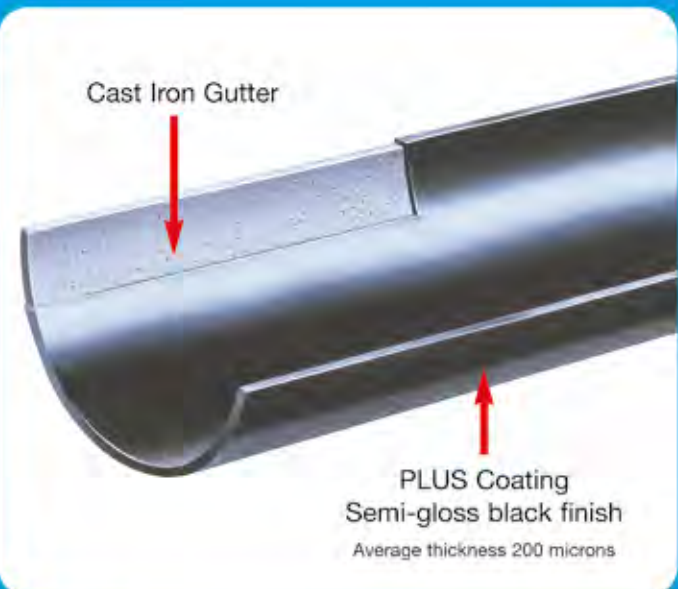

EXPRESS PLUS

ORDER CODE	DESCRIPTION	MANUFACTURERS REF	
125mm			
99144500	1830mm Gutter	192350	G880
99144504	90deg Angle (Internal / External)	192351	G881
99144508	45deg Angle (Internal / External)	192352	G882
99144510	Transitional Connector to 115mm & 125mm BS460 Gutter	192353	G883
99144512	Stop End	192354	G884
99144502	75dia Outlet Nozzle	192355	G885
99144506	Cast Iron Fascia Bracket	192356	G886
99144470	Gutter Jointing Clip (Box of 20)	192346	G887



Conserve Your Rainwater

Rainwater Diverter Kits available to suit pipework in 65mm and 75mm diameters. Supplied in a primer or the Plus finish - the kits include all of the connecting pieces to fit off the standard shelf water butts.

All Saint Gobain PAM products are
100% Recyclable



BBA Approval

Saint-Gobain Pam have been awarded a British Board of Agreement third party accreditation for its standard range of half round gutter systems and circular downpipes systems, within the Standard range.

It should be noted that these are the only cast iron rainwater and gutter systems with BBA approval and manufactured under BS EN ISO 9001:1994 scheme of quality assurance.

CLASSICAL RAINWATER (PRIMED FINISH)

The only cast iron rainwater system with BBA Certification. The Classical range of cast iron rainwater and gutter systems offers a choice of 8 gutter profiles with downpipes and fittings available in round and rectangular.

Features:

- High resistance to impact (accidental and vandalism) a major consideration for inner cities, town shopping precincts and schools etc
- Secure against - heavy snow falls and high winds
- Rigidity to comfortably accommodate the weight of ladders for routine maintenance
- The physical properties of cast iron will be sustained throughout its life (provided adequately painted and maintained)

The classical range is coated in a black water based primer ready for on site painting carrying the distinctive C product identification marking.



Classical



There are eight Classical gutter systems; four half round profiles - Half Round, Deep Half Round, Beaded Half Round and the new Classical Express true half round profile, three decorative profiles - Ogee, Notts. Ogee, Moulded No. 46 and the square profile Box gutter. There are also two Rainwater downpipe systems available, Round and Rectangular.

All Rainwater gutter systems are supplied in either a black primer coating ready for on-site painting or with a black semi-gloss top coat.



Half Round

Available in the following sizes - 100mm (4"), 115mm (4 1/2"), 125mm (5"), and 150mm (6") with outlets to fit 65mm (2 1/2"), 75mm (3"), and 100mm (4") round downpipes.



Deep Half Round

Available in the following sizes - 100mm x 75mm (4" x 3") and 125mm x 75mm (5" x 3") with outlets to fit 65mm (2 1/2") and 75mm (3") round downpipes.



Beaded Half Round

Available in the following sizes - 100mm (4"), 115mm (4 1/2"), 125mm (5"), with outlets to fit 65mm (2 1/2"), 75mm (3").



Classical / Express / Express Plus

Available in the following sizes - 125mm (5") for use with existing 75mm (3") round downpipes.



Moulded No. 46

Available in the following sizes - 100mm x 75mm (4" x 3"), 125mm x 100mm (5" x 4"), 150mm x 100mm (6" x 4") and has outlets to fit round and rectangular downpipes.



Ogee

Available in the following sizes - 100mm (4"), 115mm (4 1/2"), 125mm (5"), and has outlets to fit 65mm (2 1/2"), 75mm (3") round downpipes.



Notts. Ogee

Available in the following sizes - 115mm (4 1/2"), with outlets to fit 65mm (2 1/2"), 75mm (3") round downpipes.



Box

Square section gutter with high capacity with outlets for 65mm (2 1/2") and 75mm (3") round downpipes and 100mm x 75mm (4" x 3") rectangular downpipes.

(Please contact your nearest Ashworth branch for full product listings)

CLASSICAL RAINWATER (cont.) (PRIMED FINISH)

ROUND PIPE & FITTINGS

ORDER CODE	DESCRIPTION	MANUFACTURERS REF	
65mm			
99141414	1830mm Pipe with Eared Socket	191912	AS85
99141412	1830mm Pipe with Plain Socket	191910	AS85
99142044	Wall Spacer Plate	192213	AS84
99141424	Loose Socket Eared	191921	AS86
99142056	Loose Socket Plain	192219	AS86
99141220	Galvanised Steel Screw to Wall Bracket	192301	AS48
99141430	Front Shoe Eared	191924	AS88
99142072	Front Shoe Plain	192227	AS88
99141438	Access Pipe Unearthed	191928	AS90
99141442	92.5deg Bend	191930	AS91
99141460	112.5deg Bend	191931	AS91
99141462	135deg Bend	191932	AS91
99141476	92.5deg Branch	191939	AS92
99141478	112.5deg Branch	191940	AS92
99141480	135deg Branch	191941	AS92
99141492	x 75mm projection Offset	191946	AS94
99141496	x 150mm projection Offset	191948	AS94
99141500	x 305mm projection Offset	191950	AS94
99141502	x 380mm projection Offset	191951	AS94
99141504	x 455mm projection Offset	191952	AS94
99141535	Rainwater Diverter Kit	192395	AS93

75mm			
99141418	1830mm Pipe with Eared Socket	191916	AS85
99141416	1830mm Pipe with Plain Socket	191914	AS85
99142046	Wall Spacer Plate	192214	AS84
99141426	Loose Socket Eared	191922	AS86
99142058	Loose Socket Plain	192220	AS86
99142125	Galvanised Steel Screw to Wall Bracket	192302	AS48
99141432	Front Shoe Eared	191925	AS88
99142074	Front Shoe Plain	192228	AS88
99141440	Access Pipe Unearthed	191929	AS90
99141464	92.5deg Bend	191933	AS91
99141466	112.5deg Bend	191934	AS91
99141468	135deg Bend	191935	AS91
99141482	92.5deg Branch	191942	AS92
99141484	112.5deg Branch	191943	AS92
99141486	135deg Branch	191944	AS92
99141506	x 75mm projection Offset	191953	AS94
99141510	x 150mm projection Offset	191955	AS94
99141514	x 305mm projection Offset	191957	AS94
99141516	x 380mm projection Offset	191958	AS94
99141518	x 455mm projection Offset	191959	AS94
99141536	Rainwater Diverter Kit	192396	AS93

100mm			
99141422	1830mm Pipe with Eared Socket	191919	AS85
99141420	1830mm Pipe with Plain Socket	191918	AS85
99142048	Wall Spacer Plate	192215	AS84
99141428	Loose Socket Eared	191923	AS86
99142060	Loose Socket Plain	192221	AS86
99142130	Galvanised Steel Screw to Wall Bracket	192303	AS48
99141434	Front Shoe Eared	191926	AS88
99141436	Front Shoe Plain	191927	AS88
99142062	Access Pipe Unearthed	192222	AS90
99142064	Access Pipe with Ears	192223	AS90
99141470	92.5deg Bend	191936	AS91
99141472	112.5deg Bend	191937	AS91
99141474	135deg Bend	191938	AS91
99141490	92.5deg Branch	191945	AS92
99141520	x 75mm projection Offset	191960	AS94
99141524	x 150mm projection Offset	191962	AS94
99141528	x 305mm projection Offset	191964	AS94
99141530	x 380mm projection Offset	191965	AS94
99141532	x 455mm projection Offset	191966	AS94

For more information on

Classical

Rainwater products contact one of our experienced sales advisors.

CLASSICAL RAINWATER (cont.) (PRIMED FINISH)

HEADS

ORDER CODE	DESCRIPTION	MANUFACTURERS REF	
300x250x200mm Rectangular			
99141384	65mm dia. Outlet	191897	A484
99141386	75mm dia. Outlet	191898	A484
99141388	100mm dia. Outlet	191899	A484
99141392	100 x 75mm Rectangular Outlet	191900	A484
250x180x175mm Rectangular			
99141394	65mm dia. Outlet (Castellated Head)	191901	A485
99141396	75mm dia. Outlet	191902	A485
99141398	100mm dia. Outlet	191903	A485
Other Sizes			
99141400	210 x 160 x 185mm x 65mm outlet Flat Hopper Head	191904	A750
99141402	210 x 160 x 185mm x 75mm outlet Flat Hopper Head	191905	A750
99141404	250 x 215 x 215mm x 100mm outlet Flat Hopper Head	191906	A750
99141406	225 x 125 x 125mm x 65mm outlet Box Head	191907	AB41
99141408	225 x 125 x 125mm x 75mm outlet Box Head	191908	AB41
99141410	280 x 150 x 130mm x 100mm outlet Box Head	191909	AB42



HALF ROUND GUTTER

ORDER CODE	DESCRIPTION	MANUFACTURERS REF	
100mm			
99142012	1830mm Gutter	192191	G800
99141638	90deg Angle Right Hand	192004	G801
99141636	135deg Angle Right Hand	192003	G801
99141654	90deg Angle Left Hand	192012	G802
99141652	135deg Angle Left Hand	192011	G802
99142066	90deg Angle Double Socket	192224	G8020
99141668	Union Clip	192019	G803
99141676	Stop End for Spigot	192023	G804
99141684	Stop End for Socket	192027	G805
99141692	65dia Outlet Nozzle with Sockets	192031	G806
99141694	75dia Outlet Nozzle with Sockets	192032	G806
99141708	65dia Outlet Drapend with Socket	192039	G807
99141720	65dia Outlet Drapend with Spigot	192044	G808
99141728	Cast Iron Fascia Bracket	192049	G809
99142109	Galvanised Mild Steel Side Fixing Rafter Bracket	192243	G870
99142105	Galvanised Mild Steel Top Fixing Rafter Bracket	192247	G871
99142101	Galvanised Mild Steel Rise & Fall Bracket	192251	G872
115mm			
99142014	1830mm Gutter	192192	G800
99141642	90deg Angle Right Hand	192006	G801
99141640	135deg Angle Right Hand	192005	G801
99141658	90deg Angle Left Hand	192014	G802
99141656	135deg Angle Left Hand	192013	G802
99142068	90deg Angle Double Socket	192225	G8020
99141670	Union Clip	192020	G803
99141678	Stop End for Spigot	192024	G804
99141686	Stop End for Socket	192028	G805
99141696	65dia Outlet Nozzle with Sockets	192033	G806
99141698	75dia Outlet Nozzle with Sockets	192034	G806
99141710	65dia Outlet Drapend with Socket	192040	G807
99141722	65dia Outlet Drapend with Spigot	192045	G808
99141730	Cast Iron Fascia Bracket	192050	G809
99142111	Galvanised Mild Steel Side Fixing Rafter Bracket	192244	G870
99142106	Galvanised Mild Steel Top Fixing Rafter Bracket	192248	G871
99142102	Galvanised Mild Steel Rise & Fall Bracket	192252	G872
99142110	Joining Kit for G800 Gutter System -Pack 20 (100,115,125mm)	192284	G873

(The above Half Round is also available in 125mm and 150mm)

CLASSICAL RAINWATER (cont.) (PRIMED FINISH)

OGEE GUTTER

ORDER CODE	DESCRIPTION	MANUFACTURERS REF	
115mm			
99142036	1830mm OG Gutter	192206	G840
99141906	135deg Angle Internal	192138	G841
99141908	90deg Angle Internal	192139	G841
99141918	135deg Angle External	192144	G842
99141920	90deg Angle External	192145	G842
99141928	Union Clip	192149	G843
99141934	Stop End for Socket (Internal)	192152	G844
99141940	Stop End for Spigot (External)	192155	G845
99141946	65dia Outlet Nozzle	192158	G846
99141970	Cast Iron Fascia Bracket (steel brackets also available)	192170	G849
125mm			
99142036	1830mm OG Gutter	192206	G840
99141906	135deg Angle Internal	192140	G841
99141908	90deg Angle Internal	192141	G841
99141918	135deg Angle External	192146	G842
99141920	90deg Angle External	192147	G842
99141928	Union Clip	192150	G843
99141934	Stop End for Socket (Internal)	192153	G844
99141940	Stop End for Spigot (External)	192156	G845
99141946	65dia Outlet Nozzle	192159	G846
99141970	Cast Iron Fascia Bracket (steel brackets also available)	192171	G849

(The above OGEE range is also available in 100mm) (also available in Plus finish)

MOULDED NO.46 GUTTER

ORDER CODE	DESCRIPTION	MANUFACTURERS REF	
125mmx100mm			
99142032	1830mm Gutter	192202	G830
99141858	135deg Angle Internal	192114	G831
99141860	90deg Angle Internal	192115	G831
99141866	135deg Angle External	192118	G832
99141868	90deg Angle External	192119	G832
99141872	Union Clip	192121	G833
99141876	Stop End for Spigot (Left Hand)	192123	G834
99141880	Stop End for Socket (Right Hand)	192125	G835
99141890	100dia Outlet Nozzle	192130	G836
99141892	100 x 75sect Outlet Nozzle	192131	G836
99141886	65dia Outlet Nozzle	192128	G836
99141888	75dia Outlet Nozzle	192129	G836
99142100	Cast Iron Fascia Bracket	192242	G839

(The above MOULDED No.46 range also available in 100mm x 75mm and 150mm x 100mm)

HALF ROUND BEADED GUTTER

ORDER CODE	DESCRIPTION	MANUFACTURERS REF	
115mm			
99142026	1830mm Double Beaded Gutter	192198	G820
99141792	135deg Angle Right Hand	192081	G821
99141794	90deg Angle Right Hand	192082	G821
99141804	135deg Angle Left Hand	192088	G822
99141806	90deg Angle Left Hand	192092	G822
99141814	Union Clip	192087	G823
99141820	Stop End for Spigot	192095	G824
99141826	Stop End for Socket	192098	G825
99141832	65dia Outlet Nozzle with Sockets	191101	G826
99141834	75dia Outlet Nozzle with Sockets	191102	G826
99141730	Cast Iron Fascia Bracket	192050	G809

(The above HALF ROUND BEADED range also available in 100mm and 125mm)



GEBERIT HDPE DRAINAGE SYSTEMS

The Geberit HDPE Drainage System represents the future of drainage and the real alternative to traditional systems. It combines flexibility, durability and reliability with environmental properties that put other pipe systems to shame. Geberit HDPE is the total solution for all types of drainage including above ground, below ground and chemical waste.

- Manufactured from High Density Polyethylene, a material with inherent properties which provide many advantages over other piping systems, making HDPE the material of choice across Europe.

Geberit HDPE

the future of
drainage
technology



- crush & impact resistant
- chemical & abrasion resistant
- superior acoustic characteristics
- temperature stable
- lightweight & easy to prefab
- flexibility of installation
- environmentally friendly

Above and Below Ground

Geberit HDPE provides specifiers and installers with complete flexibility above and below ground.

- The properties of HDPE mean that pipe and fittings are resistant to crushing, abrasion, impact and extremes of temperature. Combined with the flexibility of several jointing methods and the option of off-site prefabrication, Geberit Drainage offers substantial material and labour savings.
- Pipe is lightweight, fully recyclable and uses less energy in its manufacture, making it one of the most environmentally friendly drainage systems available.

Chemical drainage

Geberit HDPE also offers considerable resistance to chemicals including radio-active effluents. Insoluble in all inorganic or organic solutions at 20 degrees C.

- Geberit HDPE is resistant to over 750 chemicals as well as hard wearing and durable in the toughest of environments.
- Ideal for use in hospitals, laboratories, chemical plants and commercial kitchens.
- Geberit HDPE provides the complete package with a wide range of fittings, including glass laboratory waste traps and secure jointing which provides specifiers with a flexible alternative that is fit for purpose.

GEBERIT HDPE DRAINAGE SYSTEMS

GEBERIT HDPE

ORDER CODE	DESCRIPTION	MANUFACTURERS REF
63mm		
69300800	Pipe 5m Plain End	364.000.16.0
69300802	Bend 135°	364.045.16.1
69300804	Long Tail Bend 90°	364.055.16.1
69300816	Bend 91.5°	364.088.16.1
69300826	Single Y Equal Branch 135°	364.120.16.1
69300834	Single Equal Branch 91.5°	364.170.16.1
69300836	Access Pipe with Screwed Cover 90°	364.451.16.1
69300860	Expansion Socket	364.700.16.1
69300862	Compression Joint	364.740.16.1
69300864	Compression Stop End	364.750.16.1
69300866	Electrofusion Coupling	364.771.16.1
69300870	Electrofusion Anchor Point	364.776.16.1
69300876	Ring Seal Sockets	364.779.16.1
69300878	Protection Caps	364.802.92.1
69300880	PE Weld on Caps	364.812.16.1
69300886	Adjustable Pipe Brackets x 0.5" BSP Thread - Guide and Anchor	364.841.00.2
69300888	Adjustable Pipe Brackets x M10 Thread - Not suitable as Anchor	364.843.00.2
69300890	Guide Bracket - Steel (rail only) electro Galvanised	364.861.00.1
69300894	Protecting Caps for Weathering Slates	364.989.16.1
75mm		
69300900	Pipe 5m Plain End	365.000.16.0
69300904	Bend 135°	365.045.16.1
69300906	Long Tail Bend 90°	365.055.16.1
69300908	Bend 91.5°	365.088.16.1
69300916	Single Y Branch x 63mm 135°	365.120.16.1
69300918	Single Y Equal Branch 135°	365.125.16.1
69300924	Single Branch x 63mm 91.5°	365.170.16.1
69300928	Single Equal Branch 91.5°	365.175.16.1
69300954	Access Pipe with Screwed Cover 90°	365.451.16.1
69300963	Concentric Reducer x 63mm	365.570.16.1
69300968	Short Eccentric Reducer x 63mm	365.571.16.1
69300970	Expansion Socket	365.700.16.1
69300974	Adaptor with Male Thread 2.5"	365.729.16.1
69300994	Compression Stop End	365.750.16.1
69300998	Electrofusion Coupling	365.771.16.1
69301000	Electrofusion Anchor Point	365.776.16.1
69301004	Ring Seal Sockets	365.779.16.1
69301008	Protection Caps	365.802.92.1
69301012	PE Weld on Caps	365.812.16.1
69301016	Adjustable Pipe Brackets x 0.5" BSP Thread - Guide and Anchor	365.841.00.2
69301018	Adjustable Pipe Brackets x M10 Thread - Not suitable as Anchor	365.843.00.2
69301020	Guide Bracket - Steel (rail only) electro Galvanised	365.861.00.1
90mm		
69301040	Pipe 5m Plain End	366.000.16.0
69301042	Bend 135°	366.045.16.1
69301044	Long Tail Bend 90°	366.055.16.1
69301046	Bend 91.5°	366.088.16.1
69301062	Single Y Branch x 50mm 135°	366.112.16.1
69301064	Single Y Branch x 56mm 135°	366.115.16.1
69301066	Single Y Branch x 63mm 135°	366.120.16.1
69301068	Single Y Branch x 75mm 135°	366.125.16.1
69301070	Single Y Equal Branch 135°	366.130.16.1
69301072	Single Branch x 50mm 91.5°	366.162.16.1
69301074	Single Branch x 56mm 91.5°	366.165.16.1
69301080	Single Equal Branch 91.5°	366.180.16.1
69301090	Access Pipe with Screwed Cover 90°	366.451.16.1
69301094	Contraction Sleeve	366.550.16.1
669301160	Protecting Caps for Weathering Slates	366.989.16.1
110mm		
69301162	Pipe 5m Plain End	367.000.16.0
69301168	Bend 135°	367.045.16.1
69301172	Long Tail Bend 135°	367.046.16.1
69301176	Long Tail Bend 90°	367.055.16.1
69301180	Bend 91.5°	367.088.16.1
69301192	Single Y Branch x 50mm 135°	367.112.16.1
69301194	Single Y Branch x 56mm 135°	367.115.16.1
69301196	Single Y Branch x 63mm 135°	367.120.16.1
69301198	Single Y Branch x 75mm 135°	367.125.16.1
69301200	Single Y Branch x 90mm 135°	367.130.16.1
69301202	Single Y Equal Branch 135°	367.135.16.1
69301210	Single Branch 91.5° Swept Entry	367.163.16.1
69301212	Single Branch x 56mm 91.5°	367.165.16.1
69301214	Single Branch x 63mm 91.5°	367.170.16.1
69301216	Single Branch x 75mm 91.5°	367.175.16.1
69301218	Single Branch x 90mm 91.5°	367.180.16.1

GEBERIT HDPE DRAINAGE SYSTEMS

GEBERIT HDPE

ORDER CODE	DESCRIPTION	MANUFACTURERS REF
69301220	Single Equal Branch 91.5°	367.185.16.1
69301238	Double Y Branch x110mm	367.235.16.1
69301272	Access Pipe with Screwed Cover 90°	367.451.16.1
69301276	Access Pipe with Screwed Cover 135°	367.453.16.1
69301280	Access Pipe with Oval Access Cover	367.454.16.1
69301282	Complete Stop End	367.471.16.1
69301296	Short Eccentric Reducer x 63mm	367.571.16.1
69301298	Concentric Reducer x 75mm	367.575.16.1
69301300	Short Eccentric Reducer x 75mm	367.576.16.1
69301304	Concentric Reducer x 90mm	367.580.16.1
69301308	Short Eccentric Reducer x 90mm	367.581.16.1
69301312	Expansion Socket	367.700.16.1
69301316	Compression Joint	367.740.16.1
69301330	Compression Stop End	367.750.16.1
69301332	Electrofusion Coupling	367.771.16.1
69301336	Electrofusion Anchor Point	367.776.16.1
69301338	Ring Seal Sockets	367.779.16.1
69301340	Protection Caps	367.802.92.1
69301344	PE Weld on Caps	367.812.16.1
69301348	Adjustable Pipe Brackets x 0.5" BSP Thread - Guide and Anchor	365.841.00.2
69301350	Adjustable Pipe Brackets x M10 Thread - Not suitable as Anchor	365.843.00.2
69301354	Guide Bracket - Steel (rail only) electro Galvanised	367.861.00.1
69301358	DuoFix Straight Connector	367.887.16.1
69301360	Protecting Caps for Weathering Slates	367.989.16.1
69300210	Straight WC Connector	152.400.16.1
125mm		
69301372	Pipe 5m Plain End	368.000.16.0
69301374	Bend 135°	368.045.16.1
69301376	Long Tail Bend 90°	368.055.16.1
69301378	Bend 91.5°	368.088.16.1
69301390	Single Y Branch x 63mm 135°	368.120.16.1
69301392	Single Y Branch x 75mm 135°	368.125.16.1
69301394	Single Y Branch x 90mm 135°	368.130.16.1
69301396	Single Y Branch x 110mm 135°	368.135.16.1
69301398	Single Y Equal Branch 135°	368.139.16.1
69301400	Single Branch x 63mm 91.5°	368.170.16.1
69301402	Single Branch x 75mm 91.5°	368.175.16.1
69301404	Single Branch x 90mm 91.5°	368.180.16.1
69301406	Single Branch x 110mm 91.5°	368.185.16.1
69301408	Single Equal Branch 91.5°	368.189.16.1
69301414	Access Pipe with Screwed Cover 90°	368.451.16.1
69301420	Access Pipe with Oval Access Cover	368.454.16.1
69301426	Short Eccentric Reducer x 63mm	368.571.16.1
69301428	Short Eccentric Reducer x 75mm	368.576.16.1
69301430	Concentric Reducer x 90mm	368.580.16.1
69301434	Short Eccentric Reducer x 90mm	368.581.16.1
69301440	Long Eccentric Reducer x 110mm	368.584.16.1
69301442	Short Eccentric Reducer x 110mm	368.586.16.1
69301444	Expansion Socket	368.700.16.1
69301450	Electrofusion Coupling	368.771.16.1
69301454	Electrofusion Anchor Point	368.776.16.1
69301458	Ring Seal Sockets	368.779.16.1
69301462	Protection Caps	368.802.92.1
69301464	PE Weld on Caps	368.812.16.1
69301474	Adjustable Pipe Brackets x 0.5" BSP Thread - Guide and Anchor	368.841.00.2
69301478	Adjustable Pipe Brackets x M10 Thread - Not suitable as Anchor	368.843.00.2
69301482	Guide Bracket - Steel (rail only) electro Galvanised	368.861.00.1
160mm		
69301486	Pipe 5m Plain End	369.000.16.0
69301488	Bend 135°	369.045.16.1
69301492	Long Tail Bend 90°	369.055.16.1
69301496	Bend 91.5°	369.088.16.1
69301498	Single Y Branch x 75mm 135°	369.125.16.1
69301500	Single Y Branch x 90mm 135°	369.130.16.1
69301502	Single Y Branch x 110mm 135°	369.135.16.1
69301504	Single Y Branch x 125mm 135°	369.139.16.1
69301506	Single Y Equal Branch 135°	369.145.16.1
69301508	Single Branch x 75mm 91.5°	369.175.16.1
69301510	Single Branch x 110mm 91.5°	369.185.16.1
69301512	Single Equal Branch 91.5°	369.195.16.1
69301520	Access Pipe with Screwed Cover 90°	369.451.16.1
69301524	Access Pipe with Oval Access Cover	369.454.16.1
69301528	Concentric Reducer x 110mm	369.535.16.1
69301536	Long Eccentric Reducer x 110mm	369.584.16.1
69301538	Short Eccentric Reducer x 110mm	369.586.16.1
69301540	Long Eccentric Reducer x 125mm	369.587.16.1

GEBERIT HDPE DRAINAGE SYSTEMS

GEBERIT HDPE

ORDER CODE	DESCRIPTION	MANUFACTURERS REF
69301542	Short Eccentric Reducer x 125mm	369.588.16.1
69301546	Expansion Socket	369.700.16.1
69301544	Electrofusion Coupling	369.771.16.1
69301568	Electrofusion Anchor Point	369.776.16.1
69301572	Ring Seal Sockets	369.779.16.1
69301576	Protection Caps	369.802.92.1
69301580	PE Weld on Caps	369.812.16.1
69301586	Adjustable Pipe Brackets x 0.5" BSP Thread - Guide and Anchor	369.841.00.2
69301588	Adjustable Pipe Brackets x M10 Thread - Not suitable as Anchor	369.843.00.2
69301590	Guide Bracket - Steel (rail only) electro Galvanised	369.861.00.1
200mm		
69301594	Pipe 5m Plain End	370.000.16.0
69301598	Long Turn Butt Welded Bend 150° (30°)	370.030.16.1
69301604	Long Turn Butt Welded Bend 135° (45°)	370.045.16.1
69301612	Long Turn Butt Welded Bend 90°	370.055.16.1
69301616	Single Y Branch x 75mm 135°	370.125.16.1
69301620	Single Y Branch x 110mm 135°	370.135.16.1
69301624	Single Y Branch x 125mm 135°	370.139.16.1
69301628	Single Y Branch x 160mm 135°	370.145.16.1
69301632	Single Y Equal Branch 135°	370.146.16.1
69301640	Single Branch x 110mm 91.5°	370.185.16.1
69301642	Single Branch x 160mm 91.5°	370.195.16.1
69301646	Single Equal Branch 91.5°	370.196.16.1
69301650	Access Pipe with Oval Access Cover	370.454.16.1
69301654	Long Eccentric Reducer x 110mm	370.584.16.1
69301656	Long Eccentric Reducer x 125mm	370.587.16.1
69301658	Long Eccentric Reducer x 160mm	370.594.16.1
69301662	Expansion Socket	370.700.16.1
69301680	Electrofusion Coupling	370.775.16.1
69301684	Pipe Brackets x 1" Nut	370.840.00.1
69301690	Guide Bracket - Steel (rail only) electro Galvanised	370.861.26.1
250mm		
69301700	Pipe 5m Plain End	371.000.16.0
69301704	Long Turn Butt Welded Bend 135°	371.045.16.1
69301712	Long Turn Butt Welded Bend 90°	371.055.16.1
69301716	Single Y Branch x 110mm 135°	371.135.16.1
69301720	Single Y Branch x 125mm 135°	371.139.16.1
69301724	Single Y Branch x 160mm 135°	371.145.16.1
69301728	Single Y Branch x 200mm 135°	371.146.16.1
69301732	Single Y Equal Branch 135°	371.147.16.1
69301736	Access Pipe with Oval Access Cover	371.454.16.1
69301740	Long Eccentric Reducer x 200mm	371.596.16.1
69301744	Expansion Socket	371.700.16.1
69301752	Electrofusion Coupling	371.775.16.1
69301756	Pipe Brackets x 1" Nut	371.840.00.1
315mm		
69301780	Pipe 5m Plain End	372.000.16.0
69301784	Long Turn Butt Welded Bend 135°	372.045.16.1
69301788	Long Turn Butt Welded Bend 90°	372.055.16.1
69301792	Single Y Branch x 110mm 135°	372.135.16.1
69301796	Single Y Branch x 125mm 135°	372.139.16.1
69301800	Single Y Branch x 160mm 135°	372.145.16.1
69301804	Single Y Branch x 200mm 135°	372.146.16.1
69301808	Single Y Branch x 250mm 135°	372.147.16.1
69301812	Single Y Equal Branch 135°	372.148.16.1
69301816	Access Pipe with Oval Access Cover	372.454.16.1
69301820	Long Eccentric Reducer x 200mm	372.596.16.1
69301824	Long Eccentric Reducer x 250mm	372.598.16.1
69301828	Expansion Socket	372.700.16.1
69301852	Electrofusion Coupling	372.775.16.1
69301856	Pipe Brackets x 1" Nut	372.840.00.1

HDPE SYSTEMS

Sizes include 40mm, 50mm, 56mm, 63mm, 75mm, 90mm, 110mm, 125mm, 150mm, 200mm, 250mm, 315mm.

For full listing of Geberit HDPE products, please ask in-store for catalogue

For more information on HDPE systems
CALL: 0800 783 7680

GEBERIT HDPE DRAINAGE SYSTEMS

GEBERIT HDPE

ORDER CODE	DESCRIPTION	MANUFACTURERS REF
------------	-------------	-------------------

40mm		
69300520	Pipe 5m Plain End	360.000.16.0
69300522	Bend 135°	360.045.16.1
69300524	Long Tail Bend 90°	360.055.16.1
69300526	Single Y Equal Branch 135°	360.109.16.1
69300528	Single Equal Branch 91.5°	360.159.16.1
69300532	Expansion Socket	360.700.16.1
69300534	Compression Joint	360.740.16.1
69300536	Compression Stop End	360.750.16.1
69300538	Electrofusion Coupling	360.771.16.1
69300540	Ring Seal Sockets	360.779.16.1
69300542	Protection Caps	360.802.92.1
69300546	Adjustable Pipe Brackets x 0.5" BSP Thread - Guide and Anchor	360.841.00.2
69300547	Adjustable Pipe Brackets x M10 Thread - Not suitable as Anchor	360.843.00.2

50mm		
69300550	Pipe 5m Plain End	361.000.16.0
69300552	Bend 135°	361.045.16.1
69300554	Long Tail Bend 90°	361.055.16.1
69300562	Single Y Equal Branch 135°	361.112.16.1
69300566	Single Equal Branch 91.5°	361.162.16.1
69300576	Expansion Socket	361.700.16.1
69300600	Compression Joint	361.740.16.1
69300620	Compression Stop End	361.750.16.1
69300624	Electrofusion Coupling	361.771.16.1
69300636	Ring Seal Sockets	361.779.16.1
69300640	Covers With Seal	361.781.16.1
69300644	Protection Caps	361.802.92.1
69300648	PE Weld on Caps	361.812.16.1
69300656	Adjustable Pipe Brackets x 0.5" BSP Thread - Guide and Anchor	361.841.00.2
69300660	Adjustable Pipe Brackets x M10 Thread - Not suitable as Anchor	361.843.00.2

56mm		
69300720	Pipe 5m Plain End	363.000.16.0
69300724	Bend 135deg	363.045.16.1
69300728	Long Tail Bend 90deg	363.055.16.1
69300736	Single Y Equal Branch 135deg	363.115.16.1
69300734	Single Y Branch x 50mm 135deg	363.112.16.1
69300740	Single Equal Branch 91.5deg	363.165.16.1
69300738	Single Branch x 50mm 91.5deg	363.162.16.1
69300758	Expansion Socket	363.700.16.1
69300764	Compression Joint	363.740.16.1
69300766	Compression Stop End	363.750.16.1
69300772	Electrofusion Coupling	363.771.16.1
69300776	Ring Seal Sockets	363.779.16.1
69300780	Protection Caps	363.802.92.1
69300782	PE Weld on Caps	363.812.16.1
69300788	Adjustable Pipe Brackets x 0.5" BSP Thread - Guide and Anchor	363.841.00.2
69300790	Adjustable Pipe Brackets x M10 Thread - Not suitable as Anchor	363.843.00.2

GEBERIT HDPE - CHEMICAL WASTE FITTINGS

ORDER CODE	DESCRIPTION	MANUFACTURERS REF
------------	-------------	-------------------

69300120	Anti-siphonic Dilution Trap for Chemical/Industrial Laboratories	152.090.16.1
69300124	Glass Receiver (0.6 litre) for Dilution Trap	152.095.00.1
69300126	Glass Receiver (2.3 litre) for Dilution Trap	152.096.00.1
69300102	50mm P-Traps	152.039.16.1
69300112	56mm P-Traps	152.044.16.1
69300104	50mm Running Traps	152.040.16.1
69300118	56mm Running Traps	152.046.16.1
69300254	50mm Laboratory Waste Rectangular with Strainer	352.389.08.1
69300250	Fixing Brackets for 352.389.08.1 Waste	352.368.00.1
69300244	Waste 60x1/8" for Vitriified Clay Sink	352.329.08.1



(Please contact your nearest Ashworth branch for full product listing)

GEBERIT HDPE DRAINAGE SYSTEMS

GEBERIT HDPE - TOOLING

ORDER CODE	DESCRIPTION	MANUFACTURERS REF
------------	-------------	-------------------

69300456	"Media" Welding Machine 40-160mm	359.662.00.1
69300304	"Universal" Welding Machine 50-315mm	356.201.00.1
69300502	Tension device 40mm for Media and Universal Machine	359.817.00.1
69300504	Tension device 50mm for Media and Universal Machine	359.818.00.1
69300492	Tension device 56mm for Media and Universal Machine	359.811.00.1
69300498	Tension device 110mm for Media and Universal Machine	359.814.00.1
69300500	Tension device 160mm for Media and Universal Machine	359.816.00.1
69300490	Tension device 63mm for Media and Universal Machine	359.809.00.1
69300494	Tension device 75mm for Media and Universal Machine	359.812.00.1
69300496	Tension device 90mm for Media and Universal Machine	359.813.00.1
69300506	Tension device 125mm for Media and Universal Machine	359.819.00.1
69300478	40-160mm Hand Operated Plane	359.799.00.0
69300332	40-200mm Universal Electric Plane 230v	359.082.00.1
69300462	Metal Case for KSS-160	359.683.00.1
69300294	Electrofusion Machine for 40-160mm 240v 1100w	356.220.00.1
69300286	Scraper	356.118.00.1
69301944	Grease Pencil Yellow	958.782.00.1



GEBERIT HDPE - ACOUSTICS

ORDER CODE	DESCRIPTION	MANUFACTURERS REF
------------	-------------	-------------------

-	110mm Universal Pipe Bracket M10 Female x 0.5" Male Thread	310.812.26.1
-	160mm Universal Pipe Bracket M10 Female x 0.5" Male Thread	315.812.26.1
-	63mm Universal Pipe Bracket M10 Female x 0.5" Male Thread	306.812.26.1
-	75mm Universal Pipe Bracket M10 Female x 0.5" Male Thread	307.812.26.1
-	90mm Universal Pipe Bracket M10 Female x 0.5" Male Thread	308.812.26.1
-	Acoustic Tube 56/63mm - 5mm thick for solid-bourne sound	306.920.00.1
-	Isol Acoustic Strip 150x12mm for airborne sound insulation	310.920.00.1
-	Isol Acoustic Mat for airborne sound insulation	356.001.00.1
-	Isol Acoustic Mat with self adhesive backing	356.002.00.1

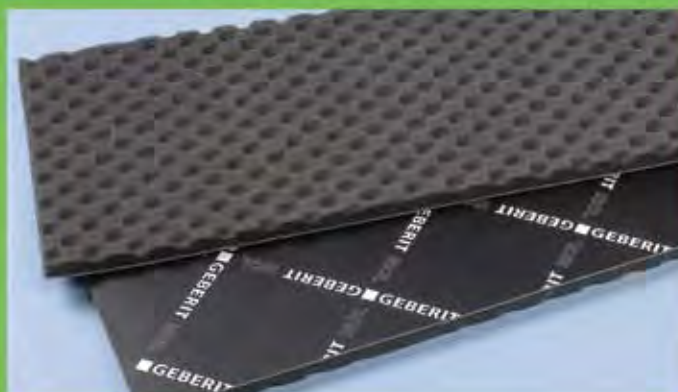

GEBERIT HDPE - FIRE PROTECTION

ORDER CODE	DESCRIPTION	MANUFACTURERS REF
------------	-------------	-------------------

-	50/56mm Intumescent Sleeve/Collar 90min Fire Rating	363.815.00.1
-	75mm Intumescent Sleeve/Collar 90min Fire Rating	365.815.00.1
-	90mm Intumescent Sleeve/Collar 90min Fire Rating	366.815.00.1
-	110mm Intumescent Sleeve/Collar 90min Fire Rating	367.815.00.1
-	125mm Intumescent Sleeve/Collar 90min Fire Rating	368.815.00.1
-	160mm Intumescent Sleeve/Collar 90min Fire Rating	369.815.00.1
-	200mm Intumescent Sleeve/Collar 90min Fire Rating	370.815.00.1

An intumescent sleeve is designed to prevent the spread of fire and smoke where PVC-u and/or HDPE Pipes penetrate a fire rated barrier wall or floor. All installations should be made in conjunction with a suitable mastic and installed in strict accordance with the installation instructions supplied.

GEBERIT HDPE SYPHONIC RAINWATER

Used across the world, Geberit Pluvia is the leading syphonic roof drain system. Architects, consultants and contractors have chosen Pluvia for some of the most prestigious and ground breaking building design and construction projects due to the freedom of flexibility it provides.

Pluvia uses the proven principles of gravity drainage, enhanced by induced syphonic action due to the innovative design of the Pluvia roof outlet. This allows the complete drainage of a roof area with smaller diameter pipes than would be necessary for a conventional gravity system.

Key Features:

- Flexibility of architectural and building design.
- Pipework laid level - no fall necessary.
- Fewer downpipes required - Saving space, materials and installation time.
- Less underground drainage, meaning less groundworks.
- Self cleaning action.
- Minimum 10 year guarantee with installation by approved installer.



GEBERIT HDPE - SYPHONIC ROOF DRAINAGE

ORDER CODE	DESCRIPTION	MANUFACTURERS REF
69300370	56mm Series 5 St/Steel Flanged 6litre Pluvia Outlet	359.500.00.1
69300372	56mm Series 5 PVC Clad St/Steel Flanged 6litre Pluvia Outlet	359.501.00.1
69300392	Gravel Ring for 56mm Series 5 Pluvia Outlet	359.511.00.1
69300394	Clamping Ring for 56mm Series 5 Pluvia Outlet	359.512.00.1
69300398	56mm Series 5 St/Steel 6litre Pluvia Outlet (without Flange)	359.514.00.1
69300426	Series 7 Pluvia Basic Outlet with Insulation Block	359.551.00.1
69300427	Series 7 320x320 Stainless Steel Contact Sheet	359.554.00.1
69300428	Series 7 320x320 Copper Contact Sheet	359.555.00.1
69300429	Series 7 320x320 Aluminium Contact Sheet	359.556.00.1
69300430	Series 7 600x600 Insulation Sheet	359.558.00.1
69300433	Series 7 Outlet Grating (Spares)	359.561.00.1
69300434	Series 7 Pluvia Basic Outlet without Insulation Block	359.563.00.1
69300438	Series 7 500 x 500 Contact Foil Sarnafil PVC	359.575.00.1

GEBERIT HDPE - SUSPENDED RAIL AND BRACKETRY

ORDER CODE	DESCRIPTION	MANUFACTURERS REF
69300710	5m Steel Rail Galvanised	362.863.26.1
69300712	Rail Joining Bracket for 40-200mm dia	362.864.26.1
69300674	Mounting Plate 0.5" Thread	362.826.26.1
69300678	Mounting Plate 1" Thread	362.828.26.1
69300686	Circular Mounting Plate M10	362.837.26.1
69300690	Circular Mounting Plate 0.5" Thread	362.839.26.1
69300694	10m Plastic Insert Strip for Pipe Bracket to suit 40-160mm dia	362.846.00.1
69300698	Rail Support Clamp	362.862.26.1
69300714	Tension Wedge for Sliding and Anchor Bracket	362.865.26.1
69300632	50mm Electroweld Tape for Fixed Point	361.776.16.1
69300664	50mm Support Shells - Galv Inside with Black painted finish	361.850.00.1
69300774	56mm Electroweld Tape for Fixed Point	363.776.16.1
69300792	56mm Support Shells - Galv Inside with Black painted finish	363.850.16.1
69300796	56mm Rail Hanging Bracket	363.861.00.0

Geberit HDPE Drainage System

As we become more aware of our environment and the impact that building practices have upon it, manufacturers, specifiers and installers are all looking for more responsible ways to construct buildings.

Geberit HDPE provides a real alternative to traditional materials also offering many other benefits

- Suitable for above & below ground applications
- Superior acoustic performance
- Prefabrication reduces waste material on & off-site
- Multiple jointing methods offer installation flexibility
- Highly durable - resists abrasion, chemicals & impact
- Modern lightweight replacement for cast iron
- Can be fully integrated with PVC-u run-offs
- BBA Approved



Making an Electrofusion Joint

Minimal pipe preparation required. Clean/abraid pipe and push into coupling. Centre stop can be removed to allow use as a slip coupling.



Connect the leads to the coupling (box confirms good connection) and press the start button. The 'smart box' does the rest! A robust, watertight joint in just 60-80 seconds.



Assembled system can be dry jointed in position. Joints can then be fused at convenience prior to system testing. This speeds installation and utilises on-site personnel to their greatest effectiveness.

Why Geberit?

- Single supplier for piping and sanitary requirements.
- Quality products backed by technical, design and installation expertise.
- Comprehensive system guarantee on integrated Geberit installations
- Minimum 25 year warranty for PFI projects.
- Full training available, on-site and at Warwick Training Centre.
- CPD Approved training courses.
- Nationwide distribution for all systems.
- Simple, professional, comprehensive support for your operational needs.

**KNOW
HOW
INSTALLED**

GEBERIT SILENT - db20

Geberit Silent-db20

Noise Control in Drainage Systems

Silent-db20 is the new drainage system for buildings with increased levels of soundproofing. Its outstanding acoustic properties are achieved using patented high density material specially developed for this purpose. Ribbed fittings further improve sound dampening near impact zones and acoustically insulated pipe brackets prevent solid-borne sound.

The system is temperature stable and easy to install and the welded connections guarantee it to be leak proof.

Features

- Sound Insulation System
- Thicker material absorbs noise emissions
- Quality through development
- Fast and easy installation

GEBERIT HDPE SILENT DB20

DESCRIPTION	MANUFACTURERS REF
56mm	
Silent Pipe 3m Plain End	305.000.14.1
Double Sleeve Coupling Silent	305.002.14.1
PE Coupling (Mechanical)	305.003.14.2
Protection Cap for Pipe end Silent	305.005.14.1
Silent Equal Branch 45deg	305.054.14.1
Silent Equal Branch 88.5deg	305.058.14.1
Silent Bend 15deg	305.150.14.1
Silent Bend 30deg	305.300.14.1
Silent Bend 45deg	305.450.14.1
Silent Bend 60deg	305.600.14.1
Silent Bend 67deg	305.670.14.1
Universal Pipe Bracket Acoustic	305.812.25.1
Silent Bend 88.5deg	305.880.14.1
Silent Bend 88.5deg Extended	305.885.14.1
Air Admittance Valve 56mm - 63mm	305.900.00.1
Acoustic Tube	305.921.00.1

We supply the full range of Geberit Silent db20 products

if you can't see what you are looking for just give us a call

GEBERIT SILENT - db20
GEBERIT HDPE SILENT DB20

DESCRIPTION	MANUFACTURERS REF
75mm	
Silent Pipe 3m Plain End	307.000.14.1
Double Sleeve Coupling Silent	307.002.14.1
PE Coupling (Mechanical)	307.003.14.2
Expansion Socket 75mm Silent	307.012.14.1
Eccentric Reducer Short 75x56mm Silent	307.050.14.1
Silent Unequal Branch 45deg 75x56mm	307.054.14.1
Silent Unequal Branch 88.5deg 75x56mm	307.058.14.1
Eccentric Reducer Short 75x63mm Silent	307.060.14.1
Silent Unequal Branch 45deg 75x63mm	307.064.14.1
Silent Unequal Branch 88.5deg 75x63mm	307.068.14.1
Silent Equal Branch 45deg	307.074.14.1
Silent Equal Branch 88.5deg	307.078.14.1
Silent Bend 15deg	307.150.14.1
Silent Bend 30deg	307.300.14.1
Access Pipe 88.5deg 75mm Silent	307.333.14.1
Access Pipe 45deg 75mm Silent	307.345.14.1
Silent Bend 135deg	307.450.14.1
Silent Bend 60deg	307.600.14.1
Silent Bend 67deg	307.670.14.1
Silent Elbow 88.5deg	307.880.14.1
Silent Bend 88.5deg Extended	307.885.14.1
Automatic Air Admittance Valve for 75mm HDPE	307.900.00.1

GEBERIT HDPE SILENT DB20

DESCRIPTION	MANUFACTURERS REF
110mm	
Silent Pipe 3m Plain End	310.000.14.4
Double Sleeve Coupling Silent	310.002.14.1
PE Coupling (Mechanical)	310.003.14.2
Expansion Socket 110mm Silent	310.012.14.1
Eccentric Reducer Short D110x63mm Silent	310.050.14.1
Branch 45deg 110x63mm	310.054.14.1
Branch 88.5deg 110x63mm	310.058.14.1
Eccentric Reducer Short D110x63mm Silent	310.060.14.1
Silent Unequal Branch 45deg 110x63mm	310.064.14.1
Silent Unequal Branch 88.5deg 110x63mm	310.068.14.1
Eccentric Reducer Short 110x75mm Silent	310.070.14.1
Silent Unequal Branch 45deg 110x75mm	310.074.14.1
Silent Unequal Branch 88.5deg 110x75mm	310.078.14.1
Eccentric Reducer Short 110x90mm Silent	310.080.14.1
Silent Unequal Branch 45deg 110x90mm	310.084.14.1
Silent Unequal Branch Swept 88.5deg 110x90mm	310.088.14.1
Silent Double Equal Branch 110x110mm	310.102.14.1
Silent Corner Branch 110x 110mm	310.103.14.1
Silent Equal Branch 45deg	310.104.14.1
Silent Equal Branch 88.5deg	310.108.14.1
Silent Bend 15deg	310.150.14.1
Silent Bend 30deg	310.300.14.1
Silent Access Pipe 45deg Swept	310.333.14.1
Access Pipe 45deg 110mm	310.345.14.1
Silent Bend 45deg	310.450.14.1
Silent Bend 60deg	310.600.14.1
Silent Bend 67deg	310.670.14.1
Silent Elbow 88.5deg	310.880.14.1
WC Connector 110mm Silent	310.881.14.1
Silent Bend 88.5deg Extended	310.885.14.1
Air Admittance Valve 110mm (Silent db20)	310.900.14.1
Acoustic Tube 110mm	310.921.00.1

GEBERIT HDPE SILENT DB20

DESCRIPTION	MANUFACTURERS REF
160mm	
Silent Pipe 3m Plain End	315.001.14.1
Double Sleeve Coupling Silent	315.002.14.1
Silent Clamp Coupling	315.003.14.2
Silent Reducer 160x110mm	315.100.14.1
Silent Unequal Branch 45deg 160x110mm	315.104.14.1
Silent Unequal Branch 91.5deg 160x110mm	315.108.14.1
Silent Equal Branch 45deg	315.144.14.1
Silent Equal Branch 91.5deg	315.148.14.1
Silent Bend 15deg	315.150.14.1
Silent Bend 30deg	315.300.14.1
Silent Access Pipe	315.333.14.1
Silent Bend 45deg	315.450.14.1

GEBERIT



The complete solution

Fast & Flexible

Ashworth also supply Mepla



Features

- Lightweight
- High stability
- High temperature resistance
- Expansion resistance
- Hygienic
- Corrosion resistant
- Dia from 16 - 75 mm

For use with:

Hot and cold water supply,
Heating systems, Industrial and
dry air supply

The Mepla press connection system is designed for extremely fast installation. The pipes HDPE (high density polyethylene) outer layer makes bending easy and also reduces weight, while the middle metal layer ensures stability isn't compromised. And thanks to a plastic inner layer Mepla boasts both corrosion and expansion resistance, making it an incredibly flexible, lightweight and functional press connection system.

GEBERIT

Ashworth also supply Personal Protective Equipment and a wide range of tools



Contact your local branch for more information
or call 0800 783 7680

Roof to River

The Polypipe Terrain "Roof to River" concept is an exciting and comprehensive range of products for the management of rainwater, and which includes:

- Harnessing of rainwater through either gravity or siphonic systems
- Filtration and storage of rainwater to re-use
- Attenuation or soakaway of rainwater through the use of piping systems, modular cells and flow control devices
- All of the necessary pipework systems to connect a scheme together



Terrain, The Single Source Solution

Terrain offers a unique combination of above ground drainage, hot & cold water, heating, ventilation and rainwater harvesting systems.

This single source solution from Terrain is an unrivalled mix of products and system solutions for commercial buildings such as hospitals, hotels, leisure centres, sports stadiums, retail complexes, public buildings plus offices and apartments.

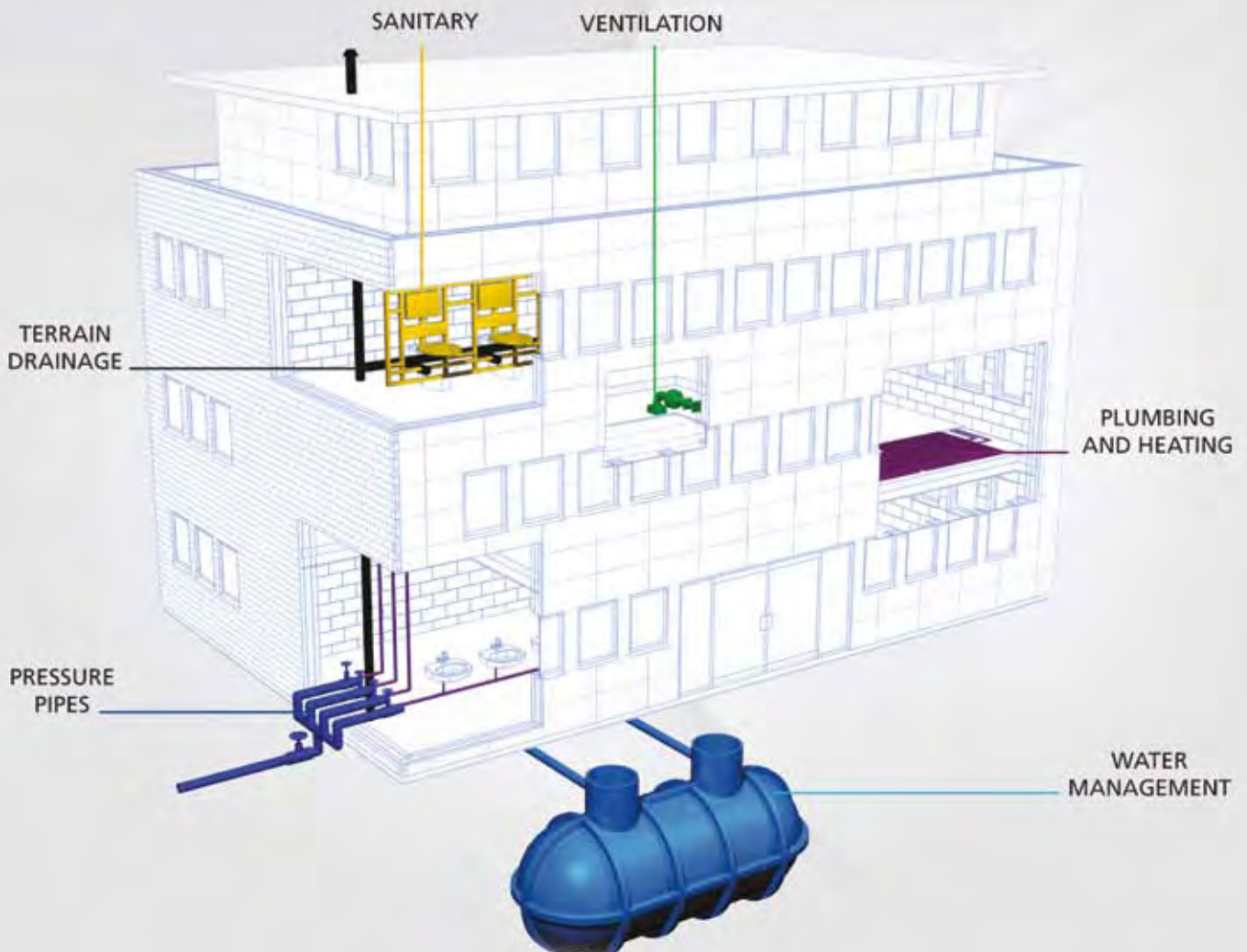

Terrain Drainage

Terrain HDPE

A modern high density polyethylene system which is ideal for non-pressure above and below ground drainage where traditional materials such as cast iron have previously been used.

- Lighter and stronger than traditional materials
- Easier to handle and quick to install
- Maintenance free, no painting
- Connection methods include electrofusion, mechanical coupling and butt welding
- System complies with unified standards EN 1519 and BBA certification
- Available in black



Terrain Acoustic dB12

A range of acoustically insulated pipes and fittings suitable for soil and waste, available in 40mm, 50mm, 110mm and 160mm. To suit locations requiring minimum transmission of noise levels.

- 3 layer polypropylene composite pipe
- Acoustic fittings with mineral additives
- Surpasses Part E performance requirements
- Uniquely achieves Class B1 fire protection
- Lightweight
- Available in blue



TERRAIN HDPE DRAINAGE SYSTEM

A modern high density polyethylene system with many advantages over traditional materials. The Terrain HDPE system is ideal for non-pressure above and below ground drainage where traditional materials such as cast iron have previously been used.

HDPE has the added benefit of being lighter than traditional materials & therefore much easier to handle and install.

Features & Benefits

- Improved noise attenuation against traditional materials
- Easy to install yet highly versatile
- A good resistance to hot water (max 95 degrees C)
- A good resistance to corrosion
- High resistance to chemical agents
- Highly resilient at low temperatures
- Available from 40mm OD to 315mm OD
- A number of connection methods can be applied (ie. electrofusion coupling, mechanical coupling, butt welding or ring seal joints)
- This system complies with unified standards EN 1519



TERRAIN HDPE DRAINAGE SYSTEM

HDPE DRAINAGE SYSTEM

ORDER CODE	DESCRIPTION	MANUFACTURERS REF
50mm		
68600000	Pipe x 5m	HDC300005
68600080	Pipe x 3m	HDN301003
68600480	Bend 45deg	HDC306005
68600600	Bend 90deg	HDC302005
68600740	Single Equal Branch 45deg	HDC309005
68601040	Single Equal Branch 90deg	HDC312005
68600150	Expansion Socket	HDN328003
68600430	Threaded Coupling / Compression Joint	HDN338003
68601950	Compression Stop End	HDN340003
68600350	Electrofusion Coupling	HDC350003
68600230	Ring Seal Sockets	HDN324003
68602000	End Cap With Seal	HDN340850
68602065	End Cap	HDC342005
68603000	Adjustable Pipe Brackets x M10 - Not suitable as Anchor	HDC396023
56mm		
68600005	Pipe x 5m	HDN300006
68600085	Pipe x 3m	HDN301004
68600485	Bend 45deg	HDN306006
68600605	Bend 90deg	HDN302006
68600745	Single Equal Branch 45deg	HDN309006
68601045	Single Equal Branch 90deg	HDN312006
68600155	Expansion Socket	HDN328004
68600435	Threaded Coupling / Compression Joint	HDN338004
68602855	Compression Stop End	HDN340004
68600355	Electrofusion Coupling	HDC350004
68600235	Ring Seal Sockets	HDN324004
68602005	End Cap With Seal	HDN340856
68602070	End Cap	HDC342006
68603005	Adjustable Pipe Brackets x M10 - Not suitable as Anchor	HDC396024
63mm		
68600010	Pipe x 5m	HDN300007
68600090	Pipe x 3m	HDN301005
68600490	Bend 45deg	HDN306007
68600610	Bend 90deg	HDN302007
68600545	Bend 88deg	HDN304005
68600750	Single Equal Branch 45deg	HDN309007
68601050	Single Equal Branch 90deg	HDN312007
68601860	Access Pipe with 90deg Screwed Access	HDN348005
68600160	Expansion Socket	HDN328005
68600440	Threaded Coupling / Compression Joint	HDN338005
68601960	Compression Stop End	HDN340005
68600360	Electrofusion Coupling	HDN350005
68600240	Ring Seal Sockets	HDN324005
68602075	End Cap	HDN342007
68603010	Adjustable Pipe Brackets x M10 - Not suitable as Anchor	HDN396025
75mm		
68600015	Pipe x 5m	HDC300009
68600095	Pipe x 3m	HDN301007
68600495	Bend 45deg	HDC306009
68600615	Bend 90deg	HDC302009
68600550	Bend 88deg	HDC304007
68600850	Single Y Branch x 63mm 45deg	HDN310014
68600755	Single Y Equal Branch 45deg	HDC309009
68601160	Single Branch x 63mm 90deg	HDN313010
68601055	Single Equal Branch 90deg	HDC312009
68601865	Access Pipe with 90deg Screwed Access	HDN348007
68602140	Concentric Reducer x 63mm	HDN336011
68602290	Short Eccentric Reducer x 63mm	HDN358011
68600165	Expansion Socket	HDN328007
68602905	Adapter with Male Thread 2.5"	HDN385021
68601965	Compression Stop End	HDN340007
68600365	Electrofusion Coupling	HDC350007
68600245	Ring Seal Sockets	HDN324007
68602080	End Cap	HDC342009
68603015	Adjustable Pipe Brackets x M10 - Not suitable as Anchor	HDC396027
90mm		
68600020	Pipe x 5m	HDN300011
68600100	Pipe x 3m	HDN301009
68600500	Bend 45deg	HDN306011
68600620	Bend 90deg	HDN302011
68600555	Bend 88deg	HDN304009
68600860	Single Y Branch x 50mm 45deg	HDN310015
68600865	Single Y Branch x 56mm 45deg	HDN310006
68600870	Single Y Branch x 63mm 45deg	HDN310018
68600875	Single Y Branch x 75mm 45deg	HDN310010

TERRAIN HDPE DRAINAGE SYSTEM

HDPE DRAINAGE SYSTEM cont.

ORDER CODE	DESCRIPTION	MANUFACTURERS REF
68600760	Single Y Equal Branch 45deg	HDN309011
68601170	Single Branch x 50mm 90deg	HDN313009
68601175	Single Branch x 56mm 90deg	HDN313034
68601060	Single Equal Branch 90deg	HDN312011
68601870	Access Pipe with 90deg Screwed Access	HDN348009
68602520	Contraction Sleeve x 110mm	HDN382001
68602300	Short Eccentric Reducer x 50mm	HDN358015
68602305	Short Eccentric Reducer x 56mm	HDN358016
68602310	Short Eccentric Reducer x 63mm	HDN358017
68602315	Short Eccentric Reducer x 75mm	HDN358019
68600170	Expansion Socket	HDN328009
68600450	Threaded Coupling / Compression Joint	HDN338009
68600370	Electrofusion Coupling	HDN350009
68600250	Ring Seal Sockets	HDN324009
68602085	End Cap	HDN342011
68603020	Adjustable Pipe Brackets x M10 - Not suitable as Anchor	HDN396029
110mm		
68600025	Pipe x 5m	HDC300013
68600105	Pipe x 3m	HDN301011
68600505	Bend 45deg	HDC306013
68600625	Bend 90deg	HDN302013
68600560	Bend 88deg	HDC304011
68600885	Single Y Branch x 50mm 45deg	HDC310019
68600890	Single Y Branch x 56mm 45deg	HDN310020
68600895	Single Y Branch x 63mm 45deg	HDN310021
68600900	Single Y Branch x 75mm 45deg	HDC310023
68600905	Single Y Branch x 90mm 45deg	HDN310025
68600765	Single Y Equal Branch 45deg	HDC309013
68600730	Single Branch 88deg Swapt Entry	HDC312025
68601200	Single Branch x 56mm 90deg	HDN313014
68601205	Single Branch x 63mm 90deg	HDN313015
68601210	Single Branch x 75mm 90deg	HDC313017
68601215	Single Branch x 90mm 90deg	HDN313019
68601065	Single Equal Branch 90deg	HDC312013
68601330	Double Y Branch x 110mm	HDC314005
68601875	Access Pipe with 90deg Screwed Access	HDC348011
68601915	Access Pipe with 45deg Screwed Access	HDN348110
68602035	Short Screwed end Cap / Stop End	HDN340111
68602335	Short Eccentric Reducer x 63mm	HDN358025
68602190	Concentric Reducer x 75mm	HDC336027
68602340	Short Eccentric Reducer x 75mm	HDC358027
68602195	Concentric Reducer x 90mm	HDN336029
68602345	Short Eccentric Reducer x 90mm	HDN358029
68600175	Expansion Socket	HDC328012
68600455	Threaded Coupling / Compression Joint	HDN338011
68601975	Compression Stop End	HDC340011
68600375	Electrofusion Coupling	HDN350011
68600255	Ring Seal Sockets	HDN324011
68602090	End Cap	HDC342013
68603025	Adjustable Pipe Brackets x M10 - Not suitable as Anchor	HDC396031
68602950	Straight Fan Connector	HDN365003
125mm		
68600030	Pipe x 5m	HDN300015
68600110	Pipe x 3m	HDN301013
68600510	Bend 45deg	HDN306015
68600630	Bend 90deg	HDN302015
68600565	Bend 88deg	HDN304013
68601400	Ventilation Branch	HDC316175
68600925	Single Y Branch x 63mm 45deg	HDN310031
68600930	Single Y Branch x 75mm 45deg	HDN310033
68600935	Single Y Branch x 90mm 45deg	HDN310035
68600940	Single Y Branch x 110mm 45deg	HDN310037
68600770	Single Y Equal Branch 45deg	HDN309015
68601220	Single Branch x 110mm 90deg	HDN313021
68601070	Single Equal Branch 90deg	HDN312015
68601880	Access Pipe with 90deg Screwed Access	HDN348013
68601935	Access Pipe with Oval Cover	HDN349003
68602360	Short Eccentric Reducer x 63mm	HDN358033
68602365	Short Eccentric Reducer x 75mm	HDN358035
68602220	Concentric Reducer x 90mm	HDN336037
68602370	Short Eccentric Reducer x 90mm	HDN358037
68602375	Short Eccentric Reducer x 110mm	HDN358039
68600180	Expansion Socket	HDN328013

TERRAIN HDPE DRAINAGE SYSTEM

HDPE DRAINAGE SYSTEM cont.

ORDER CODE	DESCRIPTION	MANUFACTURERS REF
68600380	Electrofusion Coupling	HDN350013
68600260	Ring Seal Sockets	HDN324013
68602095	End Cap	HDN342015
68603030	Adjustable Pipe Brackets x M10 - Not suitable as Anchor	HDN396033
160mm		
68600035	Pipe x 5m	HDC300017
68600115	Pipe x 3m	HDN301015
68600515	Bend 45deg	HDC306017
68600635	Bend 90deg	HDC302017
68600570	Bend 88deg	HDC304015
68600945	Single Y Branch x 110mm 45deg	HDC310039
68600950	Single Y Branch x 125mm 45deg	HDN310041
68600775	Single Y Equal Branch 45deg	HDC309017
68601225	Single Branch x 110mm 90deg	HDC313023
68601075	Single Equal Branch 90deg	HDC312017
68601885	Access Pipe with 90deg Screwed Access	HDC348015
68601940	Access Pipe with Oval Cover	HDN349005
68602230	Concentric Reducer x 110mm	HDN336041
68602400	Long Eccentric Reducer x 110mm	HDN358041
68602380	Short Eccentric Reducer x 110mm	HDC358038
68602405	Long Eccentric Reducer x 125mm	HDN358043
68602385	Short Eccentric Reducer x 125mm	HDN358040
68600185	Expansion Socket	HDC328015
68600385	Electrofusion Coupling	HDC350015
68600265	Ring Seal Sockets	HDN324015
68602045	Protection Caps	HDC342017
68603035	Adjustable Pipe Brackets x M10 - Not suitable as Anchor	HDC396035
200mm		
68600040	Pipe x 5m	HDC300019
68600520	Bend 45deg	HDN306019
68600660	Bend 90deg	HDC302019
68600955	Single Y Branch x 110mm 45deg	HDC310043
68600960	Single Y Branch x 125mm 45deg	HDN310045
68600965	Single Y Branch x 160mm 45deg	HDC310047
68600780	Single Y Equal Branch 45deg	HDC309019
68601235	Single Branch x 110mm 90deg	HDC313027
68601245	Single Branch x 160mm 90deg	HDC313031
68601080	Single Equal Branch 90deg	HDC312019
68602410	Long Eccentric Reducer x 110mm	HDN358045
68602415	Long Eccentric Reducer x 125mm	HDN358047
68602420	Long Eccentric Reducer x 160mm	HDN358049
68600190	Expansion Socket	HDN328017
68600390	Electrofusion Coupling	HDC350117
68603040	Pipe Brackets x 1/2" Nut	HDC396050
250mm		
68600045	Pipe x 5m	HDN300021
68600525	Bend 45deg	HDN306021
68600665	Bend 90deg	HDN302021
68600970	Single Y Branch x 110mm 45deg	HDN310049
68600975	Single Y Branch x 125mm 45deg	HDN310051
68600980	Single Y Branch x 160mm 45deg	HDN310053
68600985	Single Y Branch x 200mm 45deg	HDN310055
68600785	Single Y Equal Branch 45deg	HDN309021
68602425	Long Eccentric Reducer x 200mm	HDN358055
68600195	Expansion Socket	HDN328019
68600395	Electrofusion Coupling	HDC350119
68603045	Pipe Brackets x 1/2" Nut	HDN396052
315mm		
68600050	Pipe x 5m	HDN300023
68600530	Bend 45deg	HDN306023
68600670	Bend 90deg	HDN302023
68600990	Single Y Branch x 110mm 45deg	HDN310057
68600995	Single Y Branch x 125mm 45deg	HDN310059
68601000	Single Y Branch x 160mm 45deg	HDN310061
68601005	Single Y Branch x 200mm 45deg	HDN310063
68601010	Single Y Branch x 250mm 45deg	HDN310065
68600790	Single Y Equal Branch 45deg	HDN309023
68602430	Long Eccentric Reducer x 200mm	HDN358061
68602435	Long Eccentric Reducer x 250mm	HDN358063
68600200	Expansion Socket	HDN328021
68600400	Electrofusion Coupling	HDN350121
68603050	Pipe Brackets x 1/2" Nut	HDN396054

TERRAIN HDPE DRAINAGE SYSTEM

HDPE - ADAPTORS

ORDER CODE	DESCRIPTION	MANUFACTURERS REF
68602890	63mm x 2inch Adaptor With Female Thread	HDN384019
68602895	75mm x 2.5 inch Adaptor With Female Thread	HDN384021
68602900	63mm X 2 Inch Adaptor with Male Thread	HDN385019
68602910	110mm x 90mm Male PVC Adaptor with Ring Seal	HDN353003

HDPE - WC CONNECTORS

ORDER CODE	DESCRIPTION	MANUFACTURERS REF
68602940	110mm x 90mm Double Outlet Pan Connector	HDN374003
68602945	110mm x 110mm Double Outlet Pan Connector	HDN374001
68602950	110mm Straight Pan Connector	HDN365003
68602955	90mm Straight Pan Connector	HDN365001
68602960	110mm x 90Deg Connector	HDN364111
68602965	90mm x 90Deg Connector	HDN364001
68602970	Seal For WC Sleeves and Extended Bends	HDN388001
68602975	110mm Wall Hung Pan Protection Cap	HDN503110
68602980	90mm Wall Hung Pan Protection Cap	HDN503090

HDPE - SUPPORTS / BRACKETRY

ORDER CODE	DESCRIPTION	MANUFACTURERS REF
-	50mm Anchor Pipes	HDN344003
-	56mm Anchor Pipes	HDN344004
-	63mm Anchor Pipes	HDN344005
-	75mm Anchor Pipes	HDN344007
-	90mm Anchor Pipes	HDN344009
-	110mm Anchor Pipes	HDN344011
-	160mm Anchor Pipes	HDNNA
-	10m Plastic Insert Strip for Pipe Bracket to suit 40-160mm dia	HDN399003
-	50mm x M10 Adjustable Pipe Bracket	HDC396023
-	56mm x M10 Adjustable Pipe Bracket	HDN396024
-	63mm x M10 Adjustable Pipe Bracket	HDN396025
-	75mm x M10 Adjustable Pipe Bracket	HDC396027
-	90mm x M10 Adjustable Pipe Bracket	HDN396029
-	110mm x M10 Adjustable Pipe Bracket	HDC396031
-	125mm x M10 Adjustable Pipe Bracket	HDN396033
-	160mm x M10 Adjustable Pipe Bracket	HDC396035
-	200mm x 0.5 inch Pipe Bracket	HDC396050
-	250mm x 0.5 inch Pipe Bracket	HDN396052
-	315mm x 0.5 inch Pipe Bracket	HDN396054
-	M10 X 1mtr Threaded Bar	HDN408001
-	M10 Mounting Plate	HDN398003
-	0.5 inch Mounting Plate	HDN398001
-	0.5 inch Mounting Plate Galv	HDN398005
-	Plastic Strip 40-160 x 10 mtr	HDN399003
-	Plastic Strip 200-315 x 10mtr	HDN399003
-	30mmx50m	HDN399001

HDPE - ACOUSTICS

ORDER CODE	DESCRIPTION	MANUFACTURERS REF
-	90mm Acoustic Pipe Bracket	HDN251009
-	110mm Acoustic Pipe Bracket	HDN251011
-	160mm Acoustic Pipe Bracket	HDN251013
-	Antivibration inserts 30x30m (58mm-315mm)	HDN399222
-	Isol Acoustic Strip 150x12mm for airborne sound insulation	310.920.00.1
-	Isol Acoustic Mat for airborne sound insulation	356.001.00.1
-	Isol Acoustic Mat with self adhesive backing	356.002.00.1

For more information on Terrain Products please call our experienced Sales Team who can help with any enquiry you may have no matter how small.

0800 783 7680

(Please contact your nearest Ashworth branch for full product listings)

TERRAIN HDPE DRAINAGE SYSTEM

HDPE - FIRE PROTECTION

ORDER CODE	DESCRIPTION	MANUFACTURERS REF
-	50mm Fire Collar	HDC410003
-	56mm Fire Collar	HDN410005
-	63mm Fire Collar	HDN410007
-	75mm Fire Collar	HDC410009
-	90mm Fire Collar	HDN410011
-	110mm Fire Collar	HDC410013
-	125mm Fire Collar	HDN410015
-	160mm Fire Collar	HDN410017
-	200mm Fire Collar	HDC410019
-	250mm Fire Collar	HDN410021
-	315mm Fire Collar	HDN410023

An intumescent sleeve is designed to prevent the spread of fire and smoke where PVC-u and/or HDPE Pipes penetrate a fire rated barrier wall or floor. All installations should be made in conjunction with a suitable masticand installed in strict accordance with the installation instructions supplied.

TERRAIN SIPHONIC SYSTEM

Terrain Siphonic Roof Draining System

Terrain HydroMax is able to offer a siphonic rainwater drainage solution which is ideal for commercial applications such as warehouses, shopping centres and superstores.

Terrain HydroMax was developed to advance the siphonic principals to create a powerful means of literally sucking the rainwater from the roof. Using small diameter pipework running at full-bore flow, Terrain HydroMax can provide ten times more flow capacity than an equivalently sized gravity system on a single storey building.



- Designs in accordance with BS8490:2007
- Complies with BS EN 12056-3:2000
- Independent testing and approval from HR Wallingford
- Terrain HydroMax uses the most advanced design software package to create optimum drainage solutions
- High level carrier pipes installed horizontally without gradient
- High velocity flow ensures that systems are self cleaning
- Fewer collection pipes than traditional guttering systems, and smaller diameter pipes used
- Ideal for linking to rainwater harvesting solutions (routing of rainwater pipes can be designed to go straight to the collection tank)
- Cost effective with typical savings of 20% to 45% (resulting from significantly less below ground drainage, reduced trenching and backfilling requirements and reduced pipe diameters)

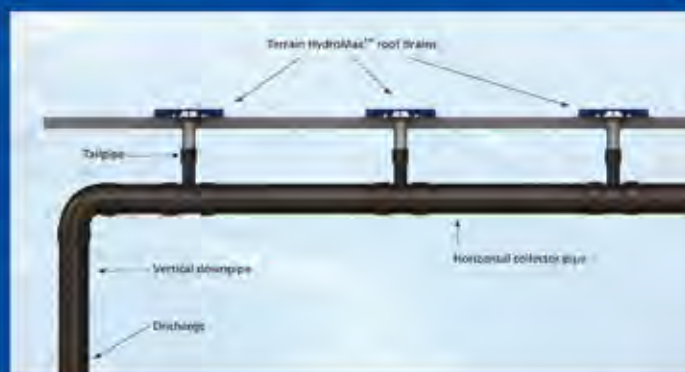

Siphonic Drainage

Polypipe Terrain's self-cleaning, high velocity flow HydroMax™ siphonic roof drainage system offers a quick and efficient way to remove large volumes of rainwater from roofs in a controlled manner. Designed to accommodate recent changes in storm patterns, it uses siphonic principles to 'suck' the rainwater from the roof into small diameter pipes, creating a flow capacity up to ten times greater than that of an equivalent gravity-fed system.

- Ten times the flow capacity of a conventional gravity system
- Substantially reduced pipe meterage, with smaller diameter pipes
- Pipe can run horizontally within building envelope
- Reduces underground drainage requirement
- Up to 45% cost saving overall
- Exceptionally accurate design software
- Much faster water removal rates



Gravity flow

A gravity drainage system limits capacity to one-third water that adheres to the inner pipe wall with a large two-thirds air core.



Terrain HydroMax™

In the Terrain HydroMax™ system, air is purged from the pipe so that it runs 100% full of water, normally achieving 10 to 15 times higher flow rates.

TERRAIN ACOUSTIC dB12

Terrain Acoustic dB12

A range of acoustically insulated pipes and fittings suitable for soil and waste, available in 40mm, 50mm, 110mm and 160mm. To suit locations requiring minimum transmission of noise levels.

- 3 layer polypropylene composite pipe
- Acoustic fittings with mineral additives
- Surpasses Part E performance requirements
- Uniquely achieves Class B1 fire protection
- Lightweight
- Available in blue



TERRAIN ACOUSTIC dB12

ORDER CODE	DESCRIPTION	MANUFACTURERS REF
40mm		
68700000	Single Socket Pipe 3m	AS65003PY
68700330	Bend 15 deg	AS650411
68700340	Bend 30 deg	AS650413
68700350	Bend 45 deg	AS650415
68700360	Bend 67 deg	AS650417
68700370	Bend 87 deg	AS650419
68700620	Branch 45 deg (40mm x 40mm)	AS650507
68700630	Branch 87 deg (40mm x 40mm)	AS650511
68700040	Double Depth Socket	AS650751
68700070	Triple Depth Socket	AS650771
68700100	Slip Coupler	AS650803
68700140	Double Socket	AS650853
68700850	Socket Plug	AS650951
68700890	Spigot Bend with Cap for Boss Adaptor (46-0)	AS650972
68700890	Spigot Bend with Cap for Boss Adaptor (53-5)	AS650973
68700930	Straight Fitting with Cap for Boss Adaptor (46-0)	AS650982
68700940	Straight Fitting with Cap for Boss Adaptor (50-0)	AS650983
68700950	Straight Fitting with Cap for Boss Adaptor (53-5)	AS650984
68700270	Acoustic Bracket M10	AS340043
68700810	Protection Cap for Socket	AS503001
68700190	Single-Lipped Seal	AS391003

TERRAIN ACOUSTIC dB12

TERRAIN ACOUSTIC dB12

ORDER CODE	DESCRIPTION	MANUFACTURERS REF
50mm		
68700010	Single Socket Pipe 3m	AS650053PY
68700380	Bend 15 deg	AS650421
68700390	Bend 30 deg	AS650423
68700400	Bend 45 deg	AS650425
68700410	Bend 67 deg	AS650427
68700420	Bend 87 deg	AS650429
68700540	Branch 45 deg (50mm x 50mm)	AS650513
68700590	Reducing Branch 45 deg (50mm x 40mm)	AS650557
68700600	Reducing Branch 87 deg (50mm x 40mm)	AS650561
68700690	Eccentric Reducer (50mm x 40mm)	AS650705
68700050	Double Depth Socket	AS650753
68700080	Triple Depth Socket	AS650773
68700110	Slip Coupler	AS650805
68700150	Double Socket	AS650855
68700720	Access with Cap	AS650901
68700860	Socket Plug	AS650953
68700910	Spigot Bend with Cap for Boss Adaptor (53-5)	AS650974
68700920	Spigot Bend with Cap for Boss Adaptor (60-0)	AS650975
68700960	Straight Fitting with Cap for Boss Adaptor (53-5)	AS650985
68700770	Push Fit Boss Adaptor (24-32)	AS334009
68700780	Push Fit Boss Adaptor (36-40)	AS523011
68700220	Acoustic Bracket G 1/2	AS252005
68700280	Acoustic Bracket M10	AS3400503
68700820	Protection Cap for Socket	AS503003
68700190	Single-Lipped Seal	AS391005

ORDER CODE	DESCRIPTION	MANUFACTURERS REF
110mm		
68700020	Single Socket Pipe 3m	AS650113PY
68700440	Bend 15 deg	AS650451
68700450	Bend 30 deg	AS650453
68700530	Bend 45 deg	AS650455
68700460	Bend 67 deg	AS650457
68700470	Bend 87 deg	AS650459
68700550	Branch 45 deg (110mm x 110mm)	AS650531
68700560	Branch 87 deg (110mm x 110mm)	AS650535
68700610	Reducing Branch 45 deg (110mm x 40mm)	AS650587
68700630	Reducing Branch 45 deg (110mm x 50mm)	AS650593
68700620	Reducing Branch 87 deg (110mm x 40mm)	AS650591
68700640	Reducing Branch 87 deg (110mm x 50mm)	AS650597
68700670	Double Branch 45 deg (110mm x 110mm)	AS650855
68700690	Eccentric Reducer (110mm x 40mm)	AS650717
68700700	Eccentric Reducer (110mm x 50mm)	AS650719
68700060	Double Depth Socket	AS650759
68700090	Triple Depth Socket	AS650779
68700120	Slip Coupler	AS650811
68700160	Double Socket	AS650861
68700730	Access with Cap	AS650907
68700870	Socket Plug	AS650959
-	Double Equal Branch (PVC)	AS659995
-	Single Branch (PVC)	AS659996
-	Four Way Boss (PVC)	AS659997
-	Corner Boss Branch (PVC)	AS659998
-	Universal Soil Manifold (PVC)	AS659999
68700310	WM Stand Pipe Bracket	AS4323100
68700230	Acoustic Bracket G 1/2	AS252011
68700290	Acoustic Bracket M10	AS3403114
68700250	Acoustic Bracket 1000 (M10)	AS3363100
68700830	Protection Cap for Socket	AS503007
68700200	Single-Lipped Seal	AS391015

TERRAIN ACOUSTIC dB12 - ACCESSORIES

ORDER CODE	DESCRIPTION	MANUFACTURERS REF
ACCESSORIES		
68701050	Threaded Rod 1m	AS408001
68701000	Pipe Cutter (50mm - 140mm) T1	AS458003
68701010	Pipe Cutter (100mm - 160mm) T2	AS458005
68701020	Beveller (32mm - 160mm)	AS460001

We also offer the full 160mm
Acoustic dB12 range

(Please contact your nearest Ashworth branch for full product listings)

Terrain Drainage

Terrain is the market leading range of soil and waste systems for commercial applications available with an extensive range of pipes and fittings in PVC, HDPE, and Polypropylene to suit almost every application.

Terrain Solvent Weld

Terrain Solvent Weld offers a neat way to achieve a permanent joint. Terrain Solvent Weld is a complete and comprehensive system.



Terrain Pushfit

Terrain Pushfit Soil & Waste System offers a comprehensive range of socketed pipe and fittings.



Both systems are available in: • Soil 82mm, 110mm and 160mm • Waste 32mm, 40mm and 50mm
• Available in grey, black, white and rustic brown

Fabrication Service

With the growing demand for off-site fabrication of soil and waste fittings, Polypipe Terrain offer a fabrication service at our dedicated facility in Aylesford, Kent. Pre-fabrication of soil stacks can vastly improve installation time and quality on site.

Prefabrication

Polypipe Terrain completes its comprehensive portfolio of solutions with an in-house specialist design and prefabrication service, offering bespoke solutions for drainage and pressure pipe products, from a single fitting to a complete system - the choice is yours.

Benefits of prefabrication

- Prefabrication under factory controlled conditions
- All components designed specifically for the project
- Reduced number of loose fittings on site and less packaging
- Individually identified components for site locations, ready to fit together like a jigsaw
- Complete process is kept in-house from design to manufacture



- Reduced labour cost
- Health and safety
- Speed of installation
- Reduced waste



TERRAIN SOIL & WASTE

Having pioneered the development of solvent-welded systems, Terrain soil and waste products represent the industry benchmark for quality, installation flexibility and product innovation backed by the highest levels of customer service.

Terrain systems include an extensive range of soil and waste drainage products for commercial, industrial, housing and public sector developments, all built on the strength of the Terrain brand. Systems include solvent-welded and push-fit options for both soil and waste drainage; overflow and trap systems; and a comprehensive range of adaptors and accessories. Products are available in a range of colours.

- Industry leading range of solvent and push-fit soil & waste solutions.
- Unique products offer unrivalled installation options.
- High quality finish colour matched to Terrain rainwater systems.
- Suitable for commercial and domestic installations.



Terrain Soil and Waste Systems

110mm seal ring adaptor turns a solvent socket into a seal-ring socket for expansion

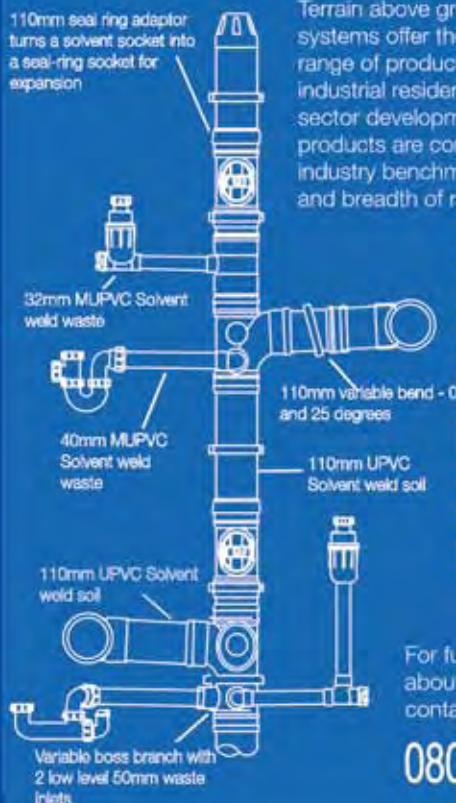

Terrain above ground drainage systems offer the installer a quality range of products for commercial, industrial residential and public sector developments. Terrain products are considered the industry benchmark for reliability and breadth of range.

For further information about this system please contact:

0800 783 7680

TERRAIN SOIL & WASTE

100 TERRAIN PVC-U SOLVENT SOIL (BS4514)

DESCRIPTION	COLOUR	MANUFACTURERS REF
110mm		
Pipe 3m Plain End	GBWR	100.4.30
Pipe 4m Plain End	GBWR	100.4.40
Ring Seal Adaptor	GBWR	109.4
Straight Coupler Double Socket	GBWR	110.4
Expansion Coupler	GBW	111.4
Slip coupler	GB	111.5.4
Swept Bend Double Socket 92.5°	GBWR	101.4.92
Swept Bend Double Socket 112.5°	GBWR	101.4.112
Swept Bend Double Socket 135°	GBWR	101.4.135
Spigot Socket Bend 92.5°	GBW	107.4.92
Spigot Socket Bend 135°	GBW	107.4.135
Variable Spigot Socket Bend	GW	107.4.025
Single Equal Branch Triple Socket 92.5° (3 boss)	GBWR	104.4.92
Single Equal Branch Triple Socket 92.5° (4 boss)	GBW	104.4.924
Single Equal Plain Branch 135°	GBW	104.4.135
Single Branch Spigot Outlet 92.5° (4 boss)	GB	104.104.92
Variable Single Equal Boss Branch Spigot Outlet	G	104.422.92
Variable Single Equal Boss Branch Socket Outlet	G	104.422.92
Corner Branch Triple Socket 92.5° (1 boss)	G	106.490.92
Double Branch Spigot Outlet 92.5° (4 boss)	G	106.104.92
Double Branch Socket Outlet 92.5° (4 boss)	GBW	106.4.92
Double Branch Socket Outlet 92.5° (no boss)	G	106.4.135
Access Pipe Double Socket	GBWR	138.4
Access Pipe Spigot Outlet	GB	139.4
Access Pipe Connector (4 boss)	GBW	137.4
Access Bend	GBW	103.4.92
Access Door	GBWR	135.4
Access Cap	GBWR	136.4
Two-Piece Pipe Bracket	Self	140.4
One Piece Pipe Bracket	GBWR	143.4
Weathering Apron	GBWR	131.4
Duct Cover	GBR	152.4
Socket Plug	GBW	130.4
Single Boss Pipe Double Socket x 32mm Waste Pipe	GBWR	120.4.125
Single Boss Pipe Double Socket x 40mm Waste Pipe	GBW	120.4.15
Four Way Boss Pipe Double Solvent Socket x 50mm Waste Pipe	GB	120.4.2
Single Boss Pipe Double Socket x 50mm Waste Pipe	GBW	123.4
Single Boss Pipe Spigot Outlet x 40mm Waste Pipe	GWR	120.412.15
Four Way Boss Pipe Solvent Spigot Outlet x 50mm Waste Pipe	GB	120.412.2
Universal Soil Manifold	G	119.412.15
Triple Boss Pipe Double Socket for x 40mm Waste Pipe	GBR	121.4.15
Socket/Spigot Reducer 110/50	GBWR	124.4.2
Automatic Air Admittance Valve	G	153.3.4
160mm		
Pipe 3m Plain End	G	100.6.30
Pipe 4m Plain End	G	100.6.40
Ring Seal Adaptor	G	109.6
Straight Coupler Double Socket	G	110.6
Expansion Coupler	G	111.6
Slip coupler	G	111.5.6
Swept Bend Double Socket 92.5°	G	101.6.92
Swept Bend Double Socket 135°	G	101.6.135
Single Equal Branch Triple Socket 92.5° (6 boss)	G	104.6.92
Single Equal Plain Branch 135°	G	104.6.135
Single Unequal Branch Triple Socket 92.5° (2 boss)	G	104.64.92
Double Unequal Branch 92.5° (2 boss)	G	106.64.92
Access Door	G	135.6
Access Cap	G	136.6
Two-Piece Pipe Bracket - Galvanised Steel	Galv	140.6
Two-Piece Pipe Bracket - Plastic Coated Steel	PC	140.6PC
Weathering Apron	G	131.6
Socket Plug	G	130.6

(To order the part you require simply attach the colour reference to the end of the product code, e.g. 100.4.40G for 100mm x 4m Grey Plain End Soil Pipe)



TERRAIN SOIL

Terrain Pushfit Soil

Produced to the same quality standards (BSEN 1329) as the Terrain Solvent soil systems, Terrain Pushfit soil & waste provides an ideal solution for refurbishment or replacement in both commercial or domestic applications.

The universal soil manifold allows multiple waste connections tight to floor level, being comfortably located in corner applications.

- Ultra compact design
- Four pushfit waste entries (c/w 3x blanking plugs)
- 110mm Pushfit socket/spigot format



100P TERRAIN PVC-U PUSH-FIT SOIL PVC

DESCRIPTION	COLOUR	MANUFACTURERS REF
Pipe 3m Single Socket	GBW	100P4.30
Pipe 4m Single Socket	GBW	100P4.40
Slip Coupler Double Socket	G	111.5P4
Straight Coupler Double Socket	GBW	110P4
Pipe End Socket Spigot/Socket	GBW	111P4
Swept Spigot/Socket Bend 92.5°	GBW	101P4.92
Tight Radius Bend Spigot/Socket 92.5°	G	107P4.92
Single Equal Branch Spigot Outlet 92.5° (5 boss)	GBW	104P4.92
Access Pipe and Cover Single Socket	GBW	139P4
Access Bend Single Socket 92.5°	GB	103P4.92
Access Single Equal Branch 92.5° (4 boss)	GBW	105P4.92
Double Equal Branch Spigot Outlet 92.5° (4 Boss)	GB	106P4.92
Strap on Boss for 32mm Waste Pipe	GBW	112P4.125
Strap on Boss for 40mm Waste Pipe	GBW	112P4.15
Adaptor Saddle for 40mm Waste Pipe	GBW	115P4
Universal Soil Manifold for BSS254/BSS255 32mm/40mm Waste	G	119P4.15
Triple Boss Collar	GBW	120P4.15
Short Bossed Pipe	G	123P4
x 50mm Reducer	GB	124P4.2
x 82mm Reducer	GB	124P4.3
Straight Fin Seal WC Connector	W	129P4.00
WC Connector 90° Fin Seal Bend	W	129P4.90
Access Cap	GBW	136P4
One Piece Pipe Bracket	GBWR	143.4

(To order the part you require simply attach the colour reference to the end of the product code.
e.g. 100P40G for 100mm x 4m Grey Single Socket Pipe)

TERRAIN SOIL CONNECTORS / ADAPTORS

DESCRIPTION	COLOUR	MANUFACTURERS REF
110mm		
Two Part Waste Boss Solvent Socket for 32mm Waste	GBW	112.4.125
Two Part Waste Boss Solvent Socket for 40mm Waste	G	112.4.15
Two Part Waste Boss Solvent Socket for 50mm Waste	GBW	112.4.2
Boss Adaptor Ring Seal Socket for 32mm Waste		
Boss Adaptor Ring Seal Socket for 40mm Waste	GBWR	117.15
Boss Adaptor Ring Seal Socket for 50mm Waste	GBW	117.2
Boss Adaptor 90° Bend Solvent Socket for 40mm Waste	GBW	117.15.90
Boss Adaptor 90° Bend Solvent Socket for 50mm Waste	GBW	117.2.90
WC Manifold Connector Fin Seal Spigot (5")		
WC Manifold Connector Fin Seal Spigot (14")	W	129.4.14
WC Manifold Connector Fin Seal Spigot (24")	W	129.4.24
WC Manifold Connector Fin Seal Spigot (34")	W	129.4.34
WC Connector Socket Outlet (2.5")		
WC Connector Socket Outlet (90°)	W	128.4.02
WC Connector Socket Outlet (92°)	W	128.4.90
WC Straight Connector Socket Outlet	W	128.405.92
WC Variable Bend Connector (adj 0-25°)	W	128.4.5
		128.4.025

(To order the part you require simply attach the colour reference to the end of the product code.
e.g. 112.125G for 100mm x 32mm Grey Two Part Waste Boss Solvent Socket)

TERRAIN WASTE

200 TERRAIN SOLVENT MUPVC WASTE (BSS255)

DESCRIPTION	COLOUR	MANUFACTURERS REF
32mm		
Pipe 4m Plain End	GBWR	200.125.40
Swept Bend Double Socket 135°	GBWR	201.125.135
Swept Bend Double Socket 165°	G	201.125.165
Swept Bend Double Socket 91.25°	GBWR	201.125.91
Knuckle Bend Double Socket 91.25°	GBWR	202.125.91
Swept Tee All Socket 135°	GW	204.125.135
Swept Tee All Socket 91.25°	GBWR	204.125.91
Spigot/Socket Bend 150°	GB	207.125.150
Spigot/Socket Bend 92.5°	GBW	207.125.92
Straight Coupler Double Socket	GBWR	210.125
Union Double Socket	G	211.125
MuPVC Spigot and BSP Threaded Socket to BSP Male	G	216.125
MuPVC Spigot and BSP Threaded Socket to BSP Female	G	217.125
Expansion Coupler Seal Ring and Solvent Socket	GW	225.125
Spigot/Socket Expansion Coupler	GW	227.125
Pipe Fixing Clip	GBWR	240.125
Expansion Fitting Fixing Clip	GW	242.125
40mm		
Pipe 4m Plain End	GBWR	200.15.40
Swept Bend Double Socket 135°	GBWR	201.15.135
Swept Bend Double Socket 165°	G	201.15.165
Swept Bend Double Socket 91.25°	GBWR	201.15.91
Swept Tee All Socket 135°	GW	204.15.135
Swept Tee All Socket 91.25°	GBWR	204.15.91
Swept Cross All Socket 91.25°	GW	206.15.91
Spigot/Socket Bend 150°	GBR	207.15.150
Spigot/Socket Bend 92.5°	GBW	207.15.92
Straight Coupler Double Socket	GBWR	210.15
Union Double Socket	G	211.15
MuPVC Socket and BSP Threaded Socket to BSP Male	G	212.15
MuPVC Socket and BSP Threaded Socket to BSP Female	GW	213.15
MuPVC Spigot and BSP Threaded Socket to BSP Male	G	216.15
MuPVC Spigot and BSP Threaded Socket to BSP Female	G	217.15
Level Invert Taper (Large End Spigot x Small End Socket)	G	223.15.125
Socket Reducer	GBWR	224.15.125
Expansion Coupler Seal Ring and Solvent Socket	GW	225.15
Spigot/Socket Expansion Coupler	GW	227.15
Access Plug	GBWR	237.15
Pipe Fixing Clip	GBWR	240.15
Expansion Fitting Fixing Clip	GW	242.15
50mm		
Pipe 4m Plain End	GBWR	200.2.40
Swept Bend Double Socket 135°	GBWR	201.2.135
Swept Bend Double Socket 165°	G	201.2.165
Swept Bend Double Socket 91.25°	GBWR	201.2.91
Swept Tee All Socket 135°	GBW	204.2.135
Swept Tee All Socket 91.25°	GBWR	204.2.91
Swept Cross All Socket 91.25°	G	206.2.135
Spigot/Socket Bend 92.5°	GW	207.2.92
Seal Ring Adaptor	GW	209.2
Straight Coupler Double Socket	GBWR	210.2
Union Double Socket	G	211.2
MuPVC Socket and BSP Threaded Socket to BSP Male	G	212.2
MuPVC Socket and BSP Threaded Socket to BSP Female	GW	213.2
MuPVC Spigot and BSP Threaded Socket to BSP Male	G	216.2
MuPVC Spigot and BSP Threaded Socket to BSP Female	GW	217.2
Level Invert Taper (Large End Spigot x Small End Socket)	G	223.2.15
Socket Reducer	GBWR	224.2.15
Expansion Coupler Seal Ring and Solvent Socket	GW	225.2
Spigot/Socket Expansion Coupler	G	227.2
Access Plug	GBWR	237.2
Pipe Fixing Clip	GBWR	240.2
Expansion Fitting Fixing Clip	GW	242.2
Vent Cowl	GW	250.2
Automatic Air Admittance Valve 32/40/50mm	W	253W

(To order the part you require simply attach the colour reference to the end of the product code.
e.g. 200.2.40G for 50mm x 4m Grey Plain End Pipe)

For more information on Terrain products please contact our experienced sales team on 0800 783 7680

TERRAIN WASTE

300 TERRAIN PUSH-FIT POLYPROPYLENE WASTE (B55254)

DESCRIPTION	COLOUR	MANUFACTURERS REF
32mm		
Pipe 3m Plain End	GBW	300.125.30
Swept Bend Double Socket 135°	GBW	301.125.135
Swept Bend Double Socket 91.25°	GBW	301.125.91
Knuckle Bend Double Socket 90°	GBW	302.125.90
Swept Tee All Socket 91.25°	GBW	304.125.91
Swivel Elbow Bend Single Socket/Spigot 90°	GW	307.125.90
Straight Coupler Double Socket	GBW	310.125
Tank Connector	GW	311.125
Access Plug	GBW	337.125
Pipe and Fitting Clip	GBW	340.125
40mm		
Pipe 3m Plain End	GBW	300.15.30
Swept Bend Double Socket 135°	GBW	301.15.135
Swept Bend Double Socket 91.25°	GBW	301.15.91
Knuckle Bend Double Socket 90°	GBW	302.15.90
Swept Tee All Socket 91.25°	GBW	304.15.91
Swivel Elbow Bend Single Socket/Spigot 90°	GW	307.15.90
Straight Coupler Double Socket	GBW	310.15
Tank Connector	GW	311.15
Socket Reducer 40mm Spigot x 32mm Socket	GBW	323.15.125
Access Plug	GBW	337.15
Pipe and Fitting Clip	GBW	340.15

(To order the part you require simply attach the colour reference to the end of the product code, e.g. 300.15.30G for 40mm x 3m Grey Plain End Pipe)

600 TERRAIN POLYPROPYLENE WASTE TRAPS

DESCRIPTION	COLOUR	MANUFACTURERS REF
32mm		
Spigot/Socket Bend 90° ('P' to 'S' Trap Converter)	W	607.125.90
Bottle 'P' Trap	W	611.125
Bottle 'P' Trap Self Re-Sealing	W	615.125
Tubular 'P' Trap	W	631.125
Tubular 'S' Trap	W	632.125
Tubular Running 'P' Trap	W	645.125
40mm		
Spigot/Socket Bend 90° ('P' to 'S' Trap Converter)	W	607.15.90
Bottle 'P' Trap	W	611.15
Bottle 'P' Trap Self Re-Sealing	W	615.15
Tubular 'P' Trap	W	631.15
Tubular 'S' Trap	W	632.15
Tubular Running 'P' Trap	W	645.15
Tubular 'P' Bath Trap with Overflow Hose	W	651.15
Tubular Lowline 'P' Bath Trap	W	657.15
Tubular Lowline 'P' Bath Trap with Overflow Hose	W	659.15
Bath Overflow Outlet Chrome-Plated	CPW	691.075
Washing Machine Trap	W	633.15
Washing Machine Standpipe	W	9250



TERRAIN WASTE

TERRAIN ACCESSORIES/ANCILLARIES

DESCRIPTION	COLOUR	MANUFACTURERS REF
50mm Intumescent Fire Collar for Pipes - 2 Hrs rating	S/Steel	1725.2
82mm Intumescent Fire Collar for Pipes - 2 Hrs rating	S/Steel	1725.3
110mm Intumescent Fire Collar for Pipes - 2 Hrs rating	S/Steel	1725.4
160mm Intumescent Fire Collar for Pipes - 2 Hrs rating	S/Steel	1725.6
Pipe Marking Template - for Access and Boss Connections	Blue	9105.500
Cleaning Fluid 125ml		9101.125
Cleaning Fluid 250ml		9101.250
Liquid Weld (Solvent Cement) 125ml		9100.125
Liquid Weld (Solvent Cement) 250ml		9100.250
Lubricant 250ml Tub (silicone)		9136.250
Lubricant 500ml Tub (soluble)		9136.500

500 TERRAIN PVC-U OVERFLOW

DESCRIPTION	COLOUR	MANUFACTURERS REF
19mm		
Pipe 4m Plain End	W	500.75.40
Bend Double Socket 135°	W	501.75.135
Bend Double Socket 91.25°	W	501.75.91
Bent Tank Connector 90°	W	502.75.90
Branch 91.25°	W	504.75.91
Straight Coupler Double Socket	W	510.75
Straight Tank Connector	W	511.75
Socket Reducer	W	524.75
Pipe Fixing Clip	W	540.75
Tundish	W	590.75

Terrain

Fabrication Service

Specialists in fabrication

The Terrain Fabrication team works closely with their Technical Services Department, employing the latest design and manufacturing technologies.

Together, they produce high quality pre-fabricated stacks and specials, either by making modifications to existing products from the entire Terrain range, or by designing bespoke components to overcome the most challenging drainage problems.

The fabrication team provides services in two key areas.

Specials

There are occasions on which even the most comprehensive product system will not meet the demands of a particularly complex design or installation. At times like this, the Terrain Fabrication Service is uniquely placed to help you.

Pre-fabrication

Shortage of skilled labour is just one reason for the growth of pre-fabrication within construction. Moving significant elements of the process from site to factory provides improvements in quality, cost and time as well as predictability, productivity and safety.

With unrivalled expertise in PVC and HDPE fabrication systems, The Fabrication Service has been helping specifiers and contractors overcome problems, both at the design stage and on site.

FOR FURTHER INFORMATION CONTACT

0800 783 7680



TERRAIN RAINWATER

Quality product, innovation and outstanding service – the combined promise that ensures every one of Terrain's five rainwater drainage systems will surpass your requirements, whatever the installation you're specifying.

Features and benefits

- Captive seals in all gutter systems
- Combination clipping system for quick reliable installation
- Fixing locations positioned outside the wet areas
- Expansion markings on ALL gutter fixings
- Dry jointed spigot-socket downpipe system
- EN607/EN12200/EN1462 Approved



2150 CRESCENT 110MM TRUE HALF ROUND GUTTER

DESCRIPTION	COLOUR	MANUFACTURERS REF
Gutter 4m	GBWR	2150.4.40
Joint Bracket	GBWR	2151.4
Support Bracket	GBWR	2152.4
Running Outlet to 68mm Round Pipe	GBWR	2153.4.25
135° Angle	GBWR	2154.4.135
90° Angle	GBWR	2154.4.90
Short External Stop End	GBWR	2155.4
Stop End Outlet to 68mm Round Pipe	GBWR	2157.4.25

(To order the part you require simply attach the colour reference to the end of the product code, e.g. 2150.4.40B for Black Crescent Gutter)

2250 CORNICHE 120X51MM RECTILINEAR GUTTER

DESCRIPTION	COLOUR	MANUFACTURERS REF
Gutter 4m	GBWR	2250.5.40
Joint Bracket	GBWR	2251.5
Support Bracket	GBWR	2252.5
Running Outlet to 68mm Round Pipe	GBWR	2253.5.23
135° Angle	GBWR	2254.5.135
90° Angle	GBWR	2254.5.90
Short External Stop End	GBWR	2255.5
Stop End Outlet to 68mm Round Pipe	GBWR	2257.5.23

(To order the part you require simply attach the colour reference to the end of the product code, e.g. 2250.5.40B for Black Corniche Gutter)

2350 STREAMLINE 137X73MM HIGH CAPACITY GUTTER

DESCRIPTION	COLOUR	MANUFACTURERS REF
Gutter 4m	BW	2350.6.40
Joint Bracket	BW	2351.6.12
Support Bracket	BW	2352.6
Running Outlet to 75mm Square Pipe	BW	2353.6.33
Running Outlet to 82mm Round Pipe	BW	2353.6.3
135° Angle	BW	2354.6.135
90° Angle	BW	2354.6.90
Short External Stop End	BW	2355.6

(To order the part you require simply attach the colour reference to the end of the product code, e.g. 2350.6.40B for Black Streamline Gutter)

(Please contact your nearest Ashworth branch for full product listing)

TERRAIN RAINWATER

2450 RAPIDFLOW 131X82MM DEEP ELLIPTICAL GUTTER

DESCRIPTION	COLOUR	MANUFACTURERS REF
Gutter 4m	BWR	2450.5.40
Joint Bracket	BWR	2451.5
Support Bracket	BWR	2452.5
Running Outlet to 68mm Square Pipe	BWR	2453.5.25
Running Outlet to 82mm Round Pipe	BWR	2453.5.3
135° Angle	BWR	2454.5.135
90° Angle	BWR	2454.5.90
Short External Stop End	BWR	2455.5
Stop End Outlet to 68mm Round Pipe	BWR	2457.5.25

2550 OMEGA 122X72MM DEEP OGEE GUTTER

DESCRIPTION	COLOUR	MANUFACTURERS REF
Gutter 4m	BWR	2550.5.40
Joint Union Bracket	BWR	2551.5
Support Bracket	BWR	2552.5
Running Outlet to 68/62mm Pipe	BWR	2553.5.25
135° External Angle	BWR	2554.5.135E
135° Internal Angle	BWR	2554.5.135I
90° External Angle	BWR	2554.5.90E
90° Internal Angle	BWR	2554.5.90I
Short External Stop End Left Hand	BWR	2555.5L
Short External Stop End Right Hand	BWR	2555.5R
Internal Stop End Left Hand	BWR	2556.5L
Internal Stop End Right Hand	BWR	2556.5R
Stop End Outlet Left Hand to 68mm	BWR	2557.5.25L
Stop End Outlet Right Hand to 68mm	BWR	2557.5.25R

TERRAIN GUTTER ADAPTORS

DESCRIPTION	COLOUR	MANUFACTURERS REF
Crescent to 115mm Cast Iron Spigot	GB	2158.4.45
Crescent to 115mm Cast Iron Socket	GB	2159.4.45
2100 Adaptor to other PVC-U Gutters	Sell	2167.4
Crescent to 115mm OG Cast Iron Spigot	GB	2168.4.45
Crescent to 115mm OG Cast Iron Socket	GB	2169.4.45
Rapidflow to Marley Deepflow	BWR	2458.5D

2100 ROUND 68MM RAINWATER DOWNPIPE

DESCRIPTION	COLOUR	MANUFACTURERS REF
Downpipe 2.5m	GBWR	2100.25.25
Downpipe 3m	GBWR	2100.25.30
Downpipe 4m	GBWR	2100.25.40
Downpipe 5.5m	GBWR	2100.25.55
Straight Coupler	GBWR	2107.25
Short Bend 112.5°	GBWR	2108.25.112
Branch 112.5°	GBWR	2109.25.112
Shoe	GBWR	2110.25
Head 250x140x179mm	GBWR	2111.25
Pipe Fitting Bracket	GBWR	2116.25
Access Pipe	GBWR	2137.25

2200 SQUARE 62X62MM RAINWATER DOWNPIPE

DESCRIPTION	COLOUR	MANUFACTURERS REF
Pipe 2.5m	GBWR	2200.23.25
Pipe 3m	GBWR	2200.23.30
Pipe 4m	GBWR	2200.23.40
Pipe 5.5m	GBWR	2200.23.55
Straight Coupler	GBWR	2207.23
Short Bend 112.5°	GBWR	2208.23.112
Bend 112.5°	GBWR	2208.23.112
Branch 112°	GBWR	2209.23.112
Shoe	GBWR	2210.23
Head 274x128x179mm	GBWR	2211.23
Pipe Fitting Bracket	GBWR	2213.23
Wall Offset	GBWR	2214.23
Adaptor 62mm Square to 68mm Round	GBWR	2215.23.25
Access Pipe	GBWR	2237.23

Greywater Management

Greywater Recycling

To help you meet the sustainable code requirements, **Ecoplay** from Polypipe is a unique water management system which re-cycles bath and shower water and re-uses it for toilet flushing.

Ecoplay dramatically reduces mains water consumption and drainage.

Intelligent system:

- Collects bath and shower water
- Replaces the greywater with fresh bath/shower water
- Purges the system regularly to avoid stagnation
- Can feed two toilets
- Is installed in the same void thickness as the standard in-wall frame

Re-using bath and shower water instead of drinking water to flush toilets will make a huge difference to the availability of water supplies throughout the UK, but particularly in the South East.



Rainwater Harvesting

The Polypipe Terrain 'Roof to River' concept is an exciting and comprehensive solution for rainwater management. Rainwater harvesting solutions collect water where it falls, rather than forcing it to drain.



Rainwater Harvesting

With over 50% of the UK's daily water requirement falling freely on roof areas, rainwater harvesting is the Environment Agency's preferred water recycling method. The totally integrated **TERRAIN** Water Harvesting System reduces the demand for treated mains water by collecting, filtering and storing rainwater for use in non-potable applications.

Rainwater can be used for:-

- Toilet and urinal flushing
- Laundry
- Wash down areas
- Irrigation systems

The **TERRAIN** solution features a range of tank technologies for above and below ground applications combined with a range of purpose built filtration and piping systems for commercial and public sector developments.

Pressure Pipe Systems

Polypipe's comprehensive range of pressure pipe systems include PVCu, ABS and HPPE pipe systems which are complemented by a full range of blue MDPE pipes and fittings. All of our pressure pipe systems have **WRAS** approval and conform to numerous British standards.

Effast PVCu

PVCu has high chemical resistance with good flow characteristics and is suitable for carrying potable water as well as food products.

- Sizes available
 - Imperial $\frac{3}{8}$ " to 8"
 - Metric 16mm to 315mm
- High abrasion resistance
- Operating temperature 0°C to +60°C subject to pressure requirements
- Installed with solvent cement or mechanical installation
- Comprehensive system includes a full range of pipes, fittings and valves
- Suitable for mains water in high rise applications



Effast ABS

A lightweight, rigid and easy to install system which is non toxic and combines chemical resistance with high impact strength. Applications vary from food and beverage processing to water and sewerage treatment and it is also suitable for potable water.

- Sizes available - Imperial $\frac{3}{8}$ " to 8"
- Operating temperature -40°C to +60°C subject to pressure requirements
- Suitable for chilled water
- Installed with solvent cement or mechanical installation



Pressure Pipe Systems

Terrain HPPE Pressure (PE100)

Terrain's PE100 high density polyethylene pressure pipe system is a fast and reliable solution to the challenges presented by the requirements of modern supply systems. Utilising the benefits of polyethylene jointing technologies and excellent chemical resistance, Terrain's PE100 pressure pipe system can be used across a wide range of applications including:

- Water supply and distribution
- Water treatment
- Cooling water
- Pressurised waste water systems
- Transportation of chemicals

Features and Benefits

Terrain's PE100 pressure pipe offers all of the benefits commonly associated with plastic systems in a wide range of sizes.

- Sizes available
 - SDR 17 (10 bar) 32mm to 1200mm
 - SDR 11 (16 bar) 20mm to 630mm
- Operating temperature -40°C to +80°C subject to pressure requirement
- Comprehensive system includes full range of pipes and fittings
- Prefabrication service is available
- Fusion weld or mechanical installation
- Excellent impact resistance
- Excellent chemical resistance



Plumbing and Heating Systems

Press-fit Plumbing System

Polypress integrates multilayer composite pipe with robust press fittings in a single system, ideally suited for hot and cold water supply and heating applications. By mechanically pressing the connection between pipe and fitting, a permanent joint is made.

- **WRAS** certificate no. 0506128
- Suitable for potable water, hot and cold plumbing and heating systems
- Available from 16mm to 63mm
- Lightweight and easy to install
- Equivalent performance but more economical than copper
- Combines rigid pipe with flexible pipe in one system
- Mechanically pressed joints
- Intelligent product so bends stay in place
- Inherently stable



Integrated Systems

A clever yet simple adaptor enables Polypipe's **Polyplumb** and **Polypress** systems to be integrated to allow the best of both worlds in one system. For example, use **Polypress** large diameter for mains, and connect through to **Polyplumb** for smaller diameter service areas.



Plumbing and Heating Systems

Underfloor Heating

Polypipe offers a comprehensive range of underfloor heating systems and pipe sizes to suit various construction methods.

Underfloor heating provides a more uniform distribution of heat, enhancing the use of space by eliminating radiators which has the added benefit of removing any high temperature surfaces.



For commercial applications, typically 18mm polybutylene pipe is used with a number of different methods available for installation to all floor types including:

- Clip Rail
- Staple
- Cable Ties
- Floor Panel

Push-fit Plumbing Systems

Polyplumb and **Polyfit** are fully integrated flexible plumbing systems which are quick and safe to install. They incorporate polybutylene pipes and complementary ranges of pushfit fittings for use in hot and cold water supply and heating systems.

- No scale build up or corrosion
- Completely lead free
- Quieter - minimal system creaking or water hammer
- No frost-burst pipes
- Electrically non-conductive - safer systems - minimal earthing requirements (Consult IEE safety guide)

Polyplumb

- Grey system
- Non-demountable
- Also used for underfloor heating



Polyfit

- White system
- Fully demountable

SOIL & WASTE

Soil & Vent

A cost saving range of PVCu Soil and Vent Systems are available from Polypipe, in diameters of 82mm, 110mm and 160mm to British Standard BS 4514.

Available in both quick and easy to apply ring seal push-fit, in Grey, Black, White and Brown and slimline Solvent weld system "2000" version in Solvent Grey, Black and Brown.



RING SEAL PVC-U SOIL & VENT (BS4514)

ORDER CODE	DESCRIPTION	MANUFACTURERS REF
82mm Grey		
68500010	Pipe 3m Plain End	P330G
68500020	Pipe 3m Single Socket	SP330G
68500030	Single Socket	SH33G
68500040	Double Socket	SH34G
68500042	Pipe Clip	SC33G
68500050	Pipe Socket Bracket	SC35G
68500070	Bend Single Socket 92.5°	SB309G
68500080	Bend Single Socket 135°	SB312G
68500090	Offset Bend Double Socket 135°	SB303G
68500092	Offset Bend Spigot / Socket 135°	SB304G
68500110	Single Equal Plain Branch 92.5°	ST301G
68500120	Single Equal Plain Branch 135°	ST304G
68500135	Access Pipe	SA343G
68500150	82x50mm Reducer	SD101G
68500262	Strap Boss Back Fixing Nut	SG30G
68500264	Vent Terminal	SV32G
68500350	Drain Connector	SD33G

SOIL & WASTE

RING SEAL PVC-U SOIL & VENT (BS4514) cont.

ORDER CODE	DESCRIPTION	MANUFACTURERS REF
110mm Grey		
68500370	Pipe 2.5m Plain End	P425G
68500380	Pipe 3m Plain End	P430G
68500390	Pipe 4m Plain End	P440G
68500400	Pipe 2m Single Socket	SP420G
68500410	Pipe 2.5m Single Socket	SP425G
68500420	Pipe 3m Single Socket	SP430G
68500430	Pipe 4m Single Socket	SP440G
68500440	Single Socket Coupler	SH43G
68500450	Double Socket Coupler	SH44G
68500452	Pipe Clip	SC43G
68500460	Pipe Clip	SC44G
68500462	Pipe Socket Bracket	SC45G
68500490	Bend Single Socket 92.5°	SB409G
68500500	Bend Single Socket 112.5°	SB411G
68500510	Bend Single Socket 135°	SB412G
68500520	Bend Double Socket 92.5°	SB417G
68500530	Offset Bend Double Socket 135°	SB403G
68500095	Offset Bend Socket Spigot 135°	SB404G
68500550	Access Bend Single Socket 92.5°	SB413G
68500560	Single Equal Plain Branch 92.5° (2 Boss)	ST401G
68500570	Single Equal Plain Branch 104°	ST402G
68500580	Single Equal Plain Branch 112.5°	ST403G
68500590	Single Equal Plain Branch 135°	ST404G
68500595	Single Equal Plain Branch 92.5° (4 Boss)	ST414G
68500600	Single Equal Access Branch 92.5° (4 Boss)	ST410G
68500610	Single Equal Access Branch 112.5°	ST412G
68500950	Double Branch 92.5°	SU420G
68500960	Double Branch 112.5°	SU422G
68500620	Boss Pipe	SH454G
68500630	Short Boss pipe Double Solvent Socket	SE60G
68500640	Strap Boss Back Fixing Nut	SG40G
68500650	Strap Boss Side Fixing Clip	SG70G
68500660	Access Pipe Single Socket - 3 Boss	SA43G
68500670	Socket Plug	SH46G
68500155	Reducer to Waste (requires Boss Adaptor)	SD65G
68500690	110x82mm Reducer Soil	SD34G
68500700	110x68mm Reducer Rainwater	SD46G
68500710	Vent Flashing Sleeve (Weathering Collar)	SV48G
68500720	Vent Terminal (Bulloon Grating)	SV42G
68500730	Adjustable Bend Ring Seal / Spigot 0-30°	SAB30G
68500740	Adjustable Bend Ring Seal / Spigot 0-90°	SAB90G
68500870	Vent Cowl	SCV40G
68500940	Drain Connector	SD43G
68500160	Access Cap Screwed / Spigot Tail	SA62G
68500165	Access Cap Screwed / Socket Tail	SA63G
68500210	32mm Straight Adaptor Solvent / Compression	SH63G
68500220	40mm Straight Adaptor Solvent / Compression	SH64G
68500230	50mm Straight Adaptor Solvent / Compression	SH65G
68500240	32mmx92.5° Angled Adaptor Solvent / Compression	SH66G
68500250	40mmx92.5° Angled Adaptor Solvent / Compression	SH67G
68500260	50mmx92.5° Angled Adaptor Solvent / Compression	SH68G
160mm Grey		
68500970	Pipe 3m Plain End	P630G
68500980	Pipe 4m Plain End	P640G
68500990	Pipe 3m Single Socket	SP630G
68501000	Pipe 4m Single Socket	SP640G
68501010	Single Socket Coupler	SH643G
68501020	Double Socket Coupler	SH644G
68501022	Pipe / Socket Clip Galv	SM649
68501025	Pipe / Socket Clip Plastic Ctd	SM650
68501050	Bend Single Socket 92.5°	SB609G
68501060	Bend Single Socket 135°	SB612G
68501070	Bend Double Socket 135°	SB603G
68501080	Single Equal Plain Branch 92.5° (2 Boss)	ST601G
68501090	160x110mm Single Unequal Plain Branch 92.5°	ST604G
68501100	160x110mm Single Unequal Plain Branch 135°	ST606G
68501110	Strap Boss Side Fixing Clip	SG166G
68501120	Access Pipe Single Socket	SA643G
68501130	Socket Plug	SH666G
68501140	160x110mm Reducer	SD664G

Call an experienced Ashworth Sales Advisor for more information on Polypipe Soil & Waste systems

SOIL & WASTE

'SYSTEM 2000' PVC-U SOLVENT SOIL & VENT (BS4514)

ORDER CODE	DESCRIPTION	MANUFACTURERS REF
82mm Solvent Grey		
68800010	Pipe 3m Plain End	P3305G
68800020	Bend Double Socket 92.5°	SWB715G
68800030	Bend Double Socket 135°	SWB485G
68800040	Single Equal Triple Socket branch 92.5°	SWT735G
68800050	Ring Seal Adaptor	SWE985G
68800060	Pipe Coupler Solvent Socket	SWH495G
68800352	Double Socket Coupler	SH345G
68800070	Socket Plug	SH365G
68800080	Weathering Apron	SV385G
68800090	Vent Terminal	SV325G
68800100	Strap Boss BackFixing Nut & Bolt	SG305G
68800422	Pipe Clip	SC345G
68800110	Pipe Clip for Socket	SC355G
68800112	Pipe Clip for Socket	SC375G
68800115	Pipe Clip	SC335G
68800120	Bend Single Socket 135°	SB3045G
68800130	Access Pipe Single Socket	SWA395G
68800135	Access Pipe Double Socket	SWA315G
68800140	Access Saddle	SA345G
68800145	Screwed Access Cap Spigot Tail	SA525G
68800150	Weathering Slate 457x457mm Angled Rubber & Aluminium	SV457
68800160	Weathering Slate 610x610mm Angled Rubber & Aluminium	SV610
68800165	Weathering Slate 610x457mm Angled Rubber & Aluminium	SV645
68800170	Weathering Slate 400x400mm Flat Rubber & Aluminium	SH400
68800180	Trapped Floor Gully c/w PVC Tile and Strainer 82/50mm outlet	PF6100
68800188	32mm Boss Adaptor B55255	SWB05G
68800200	40mm Boss Adaptor B55255	SWB15G
68800210	50mm Boss Adaptor B55255	SWB25G
68800220	32mm Boss Adaptor Rubber Push-fit Universal	SN32
68800230	40mm Boss Adaptor Rubber Push-fit Universal	SN40
68800240	50mm Boss Adaptor Rubber Push-fit Universal	SN50

110mm Solvent Grey		
68800250	Pipe 3m Plain End	P4305G
68800260	Pipe 4m Plain End	P4405G
68800270	Bend Double Socket 92.5°	SWB225G
68800280	Bend Double Socket 112.5°	SWB235G
68800290	Bend Double Socket 135°	SWB185G
68800301	Single Equal Triple Socket branch 92.5° (4 Boss)	SWT265G
68800310	Single Equal Triple Socket branch 104°	SWT355G
68800320	Single Equal Triple Socket branch 135°	SWT375G
68800325	Short Access Pipe Single Socket	SWA885G
68800330	Short Access Pipe Double Socket	SWA445G
68800340	Ring Seal Adaptor	SWE995G
68800350	Pipe Coupler Solvent Socket	SWH165G
68800354	Double Socket Coupler	SH445G
68800360	110x82mm Socket to Spigot Reducer	SWD965G
68800370	110x82mm Double Socket Reducer	SWD135G
68800380	Socket Plug	SH465G
68800390	Weathering Apron	SV485G
68800400	Vent Terminal	SV425G
68800410	Strap Boss BackFixing Nut & Bolt	SG405G
68800420	Strap Boss Side Fixing Clip	SG705G
68800424	Pipe Clip (Plastic)	SC445G
68800430	Pipe Clip (Plastic)	SC435G
68800432	Pipe Clip Pipe / Socket (Galv)	SM49
68800440	Pipe Clip for Socket (Plastic)	SC455G
68800450	Bend Single Socket 112.5°	SWB245G
68800452	Bend Single Socket 135°	SB4045G
68800470	Bend Single Socket 90° Close Couple	SWB475G
68800480	Single Equal Double Socket branch 92.5° (4 Boss)	SWT285G
68800490	Single Equal Triple Socket Access Branch 92.5°	SWA095G
68800500	Access Pipe Single Socket	SWA535G
68800510	Access Pipe Double Socket	SWA435G
68800513	Bossed Pipe 3 Way Single Socket	SWE595G
68800515	Bossed Pipe 3 Way Double Socket	SWE605G
68800520	Access Bend Double Socket 92.5°	SWA875G
68800540	Double Branch Triple Socket/Spigot 112.5° (Ring Seal)	SU4225G
68800548	Corner Branch Triple Socket/Spigot 92.5°	SCB1055G
68800550	Corner Branch Quadruple Socket/Spigot 92.5°	SCB1065G
68800560	Access Saddle	SA445G
68800570	Screwed Access Cap - Spigot tail	SA625G
68800580	Screwed Access Cap - Solvent Socket tail	SA635G
68800590	Vent Cowl	SCV405G
68800630	Reducer to Waste (Requires Boss adaptor)	SO655G
68800782	Single Boss Pipe Double Socket 32mm solvent waste	BP4205G

(Please contact your nearest Ashworth branch for full product listings)

SOIL & WASTE

'SYSTEM 2000' PVC-U SOLVENT SOIL & VENT (BS4514) cont.

ORDER CODE	DESCRIPTION	MANUFACTURERS REF
68800783	Single Boss Pipe Single Socket 32mm solvent waste	BP4215G
68800784	Single Boss Pipe Double Socket 40mm solvent waste	BP4225G
68800785	Single Boss Pipe Single Socket 40mm solvent waste	BP4235G
68800786	Single Boss Pipe Double Socket 50mm solvent waste	BP4245G
68800787	Single Boss Pipe Single Socket 50mm solvent waste	BP4255G
160mm Solvent Grey		
68800700	Pipe 3m Plain End	P6305G
68800710	Pipe 4m Plain End	P6405G
68800720	Bend Double Socket 92.5°	SWB925G
68800730	Bend Double Socket 135°	SWB935G
68800740	Single Equal Triple Socket branch 92.5°	SWT935G
68800750	Single Equal Triple Socket branch 135°	SWT915G
68800760	Single Unequal Triple Socket branch 92.5°	SWT945G
68800770	Single Unequal Triple Socket branch 135°	SWT975G
68800780	Short Access Pipe Double Socket	SWA635G
68800790	Ring Seal Adaptor	SWE615G
68800800	Pipe Coupler Solvent Socket	SWH645G
68800810	160X110mm Socket to Spigot Reducer	SWD695G
68800820	Socket Plug	SH6665G
68800830	Weathering Apron	SV685G
68800840	Vent Terminal	SV625G
68800850	Strap Boss Side Fixing Clip	SG165G
68800860	Pipe Clip Pipe / Socket (Galv)	SM649
68800870	Pipe Clip for Socket (Plastic)	SM650



POLYVALVES AIR ADMITTANCE VALVES AND ANTI-SYPHON UNITS

ORDER CODE	DESCRIPTION	MANUFACTURERS REF
68900130	82mm PVC-U Air Admittance Valve Grey Solvent Socket	SPV82G
68900140	110mm PVC-U Air Admittance Valve Grey Solvent Socket	SPV110G
68900142	110mm PVC-U Air Admittance Valve White Solvent Socket	SPV110W
68900144	110mm PVC-U Air Admittance Valve Black Solvent Socket	BLKSPV110
68900150	32mm ABS Anti-Siphon unit White Solvent Spigot to B55255	PVS32
68900160	40mm ABS Anti-Siphon unit White Solvent Spigot to B55255	PVS40
68900170	50mm ABS Anti-Siphon unit White Solvent Spigot to B55255	PVS50
68900180	32mm ABS Anti-Siphon unit White Push-fit Spigot to B55254	VWP32
68900190	40mm ABS Anti-Siphon unit White Push-fit Spigot to B55254	VWP40
68900200	50mm ABS Anti-Siphon unit White Push-fit Spigot to B55254	VWP50

Note: 82 & 110mm Polyvalves include Polystyrene Insulating Head Cover as per Building Regulations. 110mm converted to Ring Seal by using SWE99 Adaptor.

POLYPIPE SOIL MANIFOLDS

ORDER CODE	DESCRIPTION	MANUFACTURERS REF
68501210	MAN5 Soil Manifold Body	MAN 5
68501220	MAN7 Soil Manifold 50 Seal	MAN 7
68501230	MAN8 Soil Manifold Swivel Bend 92.5° Push-fit	MAN 8

Note: Accepts all Polypipe 32mm and 40mm Swivel Bends and Pipe for 50mm Pipe, enlarge hole, and fit Man 7 Rubber Seal plus 50mm Swivel Band

SOIL & WASTE

Fire Protection Sleeves

Designed to avoid the expenses of fireproof ducting, the sleeves are efficient and cost effective.

Two semi-circular metal shells are lined with intumescent material that when heated expands making a fire barrier.



FIRE PROTECTION SLEEVES (METAL) 4 HOUR

ORDER CODE	DESCRIPTION	MANUFACTURERS REF
68900010	55mm Fire Protection Sleeve (Metal Red) 4 hour rated	FPS55
68900020	82mm Fire Protection Sleeve (Metal Red) 4 hour rated	FPS82
68900030	110mm Fire Protection Sleeve (Metal Red) 4 hour rated	FPS110
68900040	160mm Fire Protection Sleeve (Metal Red) 4 hour rated	FPS160

Metal Shell contains intumescent material. New compact type, use where Plastic Pipes penetrate walls and floors.

ANCILLARY ITEMS

ORDER CODE	DESCRIPTION	MANUFACTURERS REF
68105810	Silicone Grease 100gm Screw Top Jar	SG100
68105820	Aerosol Lubricant 400ml	SG300
68105830	Cleaning Fluid 250ml Tin	CF250
68105840	Solvent Cement c/w Brush 125ml (BS6209)	SC125
68105850	Solvent Cement c/w Brush 250ml (BS6209)	SC250
68105860	Gap Filling Cement 140gm Tube Clear	GFC100

KWIKFIT wc pan connectors

An exceptionally wide range of WC pan connectors manufactured to British Standard BS 5627 in tough polypropylene copolymer with highly flexible elastomeric gaskets and seals.

KWICKFIT WC PAN CONNECTORS (BS5627)

ORDER CODE	DESCRIPTION	MANUFACTURERS REF
69104330	Kwickfit Straight	SK40
69104340	Kwickfit 90° 'S' (225mm Leg)	SK42
69104350	Kwickfit 104° 'P'	SK44
69104390	Kwickfit Offset - 12mm	SK46
69104412	Kwickfit Offset - 40mm	SK52
69104400	Kwickfit Extension Piece (200mm)	SK48
69104401	Kwickfit 90° Connector (110mm Leg)	SK49
69104410	Kwickfit Long 90° 'S' (390mm Leg)	SK50
69104415	Kwickfit Flexi-Con Connector (110dia x 580mm)	SK54

White Polypropylene - 110mm / 4". Do NOT Solvent Weld

PANCON WC PAN CONNECTORS (BS5627)

ORDER CODE	DESCRIPTION	MANUFACTURERS REF
69104300	Pancon Straight	SWC40
69104310	Pancon 90° 'S'	SWC42
69104320	Pancon 104° 'P'	SWC44

White Polypropylene - 110mm / 4". Do NOT Solvent Weld

TRAPS

NUFLO TRAPS (BS3943)

ORDER CODE	DESCRIPTION	MANUFACTURERS REF
32mm		
69103700	Tubular Trap - 38mm Seal With Cleaning Eye	WP49
69103710	Tubular Trap - 75mm Seal With Cleaning Eye	WP39
69103720	Bottle Trap - 38mm Seal	WP37
69103740	Bottle Trap - 75mm Seal	WP45
69103750	Bottle Trap - 75mm Seal Adjustable Telescopic	WPT47
69103760	Resealing Bottle Trap - 75mm Seal	WP41
69103770	Resealing Bottle Trap - 75mm Seal Adjustable Telescopic	WPT41
69103800	Straight Through Trap - 75mm Seal with 1 Cleaning Eye	WST1
69103810	Straight Through Trap - 75mm Seal with 2 Cleaning Eyes	WST2
69103820	Straight Through Trap - 75mm Seal 40mm Outlet 2 Cleaning Eyes	WST3
69103830	Bath Trap - 20mm Seal with Cleaning Eyes	WT60
69103840	Tubular Swivel 'P' Trap - 38mm Seal	WT50
69103850	Tubular Swivel 'P' Trap - 75mm Seal	WT52
69103860	Tubular Swivel 'P' Trap - 75mm Seal Adjustable Telescopic	WT64
69103870	Tubular Swivel 'S' Trap - 38mm Seal	WT54
69103880	Tubular Swivel 'S' Trap - 75mm Seal	WT56
69103890	Tubular Swivel Trap 'PQS' 75mm Seal Adjustable Telescopic	WT75
69103900	Running Trap - 38mm Seal	RT138
69103910	Running Trap - 75mm Seal	RT176
69103920	32x32 Waste to Trap Connector (Compression x BSP Male Iron Tail)	WTC1
69103930	32x40 Waste to Trap Connector (Compression x BSP Male Iron Tail)	WTC2
40mm		
69103940	Tubular Trap - 38mm Seal With Cleaning Eye	WP50
69103950	Tubular Trap - 75mm Seal With Cleaning Eye	WP40
69103960	Bottle Trap - 38mm Seal	WP38
69103970	Bottle Trap - 75mm Seal	WP46
69103980	Bottle Trap - 75mm Seal Adjustable Telescopic	WPT48
69103990	Resealing Bottle Trap - 75mm Seal	WP42
69104000	Resealing Bottle Trap - 75mm Seal Adjustable Telescopic	WP42T
69104010	Bath Trap - 20mm Seal with Cleaning Eye	WT58
69104020	Low Level Bath Trap - 38mm Seal (Trap only with access for Overflow)	WT67
69104030	Low Level Bath Trap - 38mm Seal (Trap only c/w Overflow Hose / CP Rose)	WT69
69104040	Low Level Bath Trap - 75mm Seal (Trap only with access for Overflow)	WT68
69104050	Low Level Bath Trap - 75mm Seal (Trap only c/w Overflow Hose / CP Rose)	WT71
69104060	Tubular Swivel 'P' Trap - 38mm Seal	WT51
69104070	Tubular Swivel 'P' Trap - 75mm Seal	WT53
69104080	Tubular Swivel 'P' Trap - 75mm Seal Adjustable Telescopic	WT63
69104090	Tubular Swivel 'P' Trap - 75mm Seal With Cleaning Eye	WT66
69104100	Tubular Swivel 'S' Trap - 38mm Seal	WT55
69104110	Tubular Swivel 'S' Trap - 75mm Seal	WT57
69104120	Tubular Swivel Trap 'PQS' 75mm Seal Adjustable Telescopic	WT76
69104130	Washing Machine Trap - 75mm Seal	WT59
69104140	Washing Machine Half Trap - 75mm Seal with Adaptor	PWM2
69104150	Washing Machine Trap Adaptor	WT61
69104160	Hose Pipe Connector (1" BSP Threaded Nut)	WT62
69104170	Hose Pipe Connector (40mm Spigot)	WT72
69104180	Running Trap - 38mm Seal	PRT25
69104190	Running Trap - 75mm Seal	PRT20
69104192	Shower Trap - 19mm Seal (70mm Plastic Grid - Removable Waste)	PST1
69104193	Shower Trap - 19mm Seal (70mm CP Grid - Removable Waste)	PST3
69104195	Shower Trap - 50mm Seal (70mm Plastic Grid - Removable Waste)	PST2
69104196	Shower Trap - 50mm Seal (70mm CP Grid - Removable Waste)	PST4
69104200	40x40 Waste to Trap Connector (Compression x BSP Male Iron Tail)	WTC4
69104210	40x32 Waste to Trap Connector (Compression x BSP Male Iron Tail)	WTC3



NUFLO ANTI-SYPHON TRAPS (BS3943)

ORDER CODE	DESCRIPTION	MANUFACTURERS REF
32mm		
69103745	32mm Anti-Syphon Bottle Trap - 75mm Seal	WP45PV
40mm		
69103985	40mm Anti-Syphon Bottle Trap - 75mm Seal Adjustable Telescopic	WPT48PV
69104022	Low Level Bath Trap - 38mm Seal (Trap only with access for Overflow)	WT67PV
69104075	Tubular Swivel 'P' Trap - 75mm Seal	WT53PV
69104142	Washing Machine Half Trap - 75mm Seal with Adaptor	PWM2PV

OVERFLOW & WASTE SYSTEMS

Waste systems

Waste systems to BS 5254 and 5255 in solvent weld MuPVC and ABS plus push fit and compression systems in polypropylene further complete the Polypipe Building Product's comprehensive Soil and Waste product range.

PUSH-FIT WASTE SYSTEM (BS5254)

ORDER CODE	DESCRIPTION	MANUFACTURERS REF
32mm White		
69103010	Pipe 3m	WP11W
69103020	Swept Bend 91.25°	WP13W
69103030	Knuckle Bend 90°	WP15W
69103040	Obtuse Bend 45°	WP17W
69103050	Soil Boss bend 157.5°	WP19W
69103060	Swept Tee 91.25°	WP21W
69103070	Swivel Bend 91.25°	WP23W
69103080	Straight Coupling	WP25W
69103100	Socket Plug	WP29W
69103110	Threaded Coupling BSP Female	WP31W
69103120	Pipe Clip	WP33W
69103130	Tank Connector	WP35W
69103135	Screwed Access Plug	WP43W
69103140	Universal Waste Coupler (fits BS5254 & BS5255 Plastic & Copper)	UWC32W
40mm White		
69103150	Pipe 3m	WP12W
69103160	Swept Bend 91.25°	WP14W
69103170	Knuckle Bend 90°	WP16W
69103180	Obtuse Bend 45°	WP18W
69103190	Soil Boss bend 157.5°	WP20W
69103200	Swept Tee 91.25°	WP22W
69103210	Swivel Bend 91.25°	WP24W
69103220	Straight Coupling	WP26W
69103230	40x32mm Reducer	WP27W
69103240	Socket Plug	WP30W
69103250	Threaded Coupling BSP Female	WP32W
69103260	Pipe Clip	WP34W
69103270	Tank Connector	WP36W
69103275	Screwed Access Plug	WP44W
69103280	Universal Waste Coupler (fits BS5254 & BS5255 Plastic & Copper)	UWC40W
50mm Grey		
69100290	Pipe 3m	WP51G
69100300	Swept Bend 91.25°	WP52G
69100310	Knuckle Bend 90°	WP64G
69100320	Obtuse Bend 45°	WP54G
69100330	Swept Tee 91.25°	WP56G
69100340	Swivel Bend 91.25°	MAN 8
69100350	Straight Coupling	WP58G
69100360	50x40mm Reducer	WP59G
69100370	Socket Plug	WP72G
69100380	Pipe Clip	WP65G
69100390	Vent Terminal	WP66G

UNIVERSAL COMPRESSION WASTE (WHITE)

ORDER CODE	DESCRIPTION	MANUFACTURERS REF
32mm		
69104500	Pipe 2m	PS50
69104520	Straight Connector	PS32
69104530	Knuckle Bend 90°	PS15
69104540	Obtuse Bend 45°	PS17
69104560	Adaptor to Solvent Socket (ABS)	WS67
69104570	Equal Tee 91.25°	PS21
69104580	Swivel Elbow 90°	SE1
69104590	Pipe Clip	WP33
40mm		
69104600	Pipe 2m	PS60
69104620	Straight Connector	PS40
69104630	Knuckle Bend 90°	PS16
69104640	Obtuse Bend 45°	PS18
69104660	Adaptor to Solvent Socket (ABS)	WS68
69104670	Equal Tee 91.25°	PS22
69104680	Swivel Elbow 90°	SE2
69104690	40x32mm Reducer	PS38
69104700	Pipe Clip	WP34
69104710	Coupler Adaptor (Remove Nut for Adaptor)	WT70

OVERFLOW & WASTE SYSTEMS

OVERFLOW SYSTEMS 21.5MM

ORDER CODE	DESCRIPTION	MANUFACTURERS REF
Polypropylene Push-fit - Grey		
69100500	Pipe 3m	VP43
69100510	Straight Connector	VP44
69100520	Knuckle Bend 90°	VP45
69100530	Bend 45°	VP55
69100540	Tee 90°	VP46
69100550	Straight Adaptor	VP47
69100560	Bent Adaptor	VP48
68403620	Straight Tank Connector (White only)	VP49
68403630	Bent Tank Connector (White only)	VP50
69100600	32mm x 21.5mm Reducer from Waste to BS5254 (Black Rubber)	WP73
69100610	40mm x 21.5mm Reducer from Waste to BS5254 (Black Rubber)	WP74
69100620	Pipe Clip	VP53
PVC-ABS Solvent / Push-fit - White		
68403550	Pipe 3m	NS43
68403560	Straight Connector	NS44
68403570	Knuckle Bend 90°	NS45W
68403580	Bend 45°	NS55W
68403590	Tee 90°	NS46W
68403600	Straight Adaptor	NS47W
68403610	Bent Adaptor	NS48W
68403620	Straight Tank Connector (White only)	VP49W
68403630	Bent Tank Connector (White only)	VP50W
68403640	Pipe Clip	VSS3
68403645	40mm x 21.5mm Reducer from Waste to BS5255	S416W
68403650	32mm x 21.5mm Reducer from Waste to BS5255	S415W
68403660	Tank Connector & Waste Reducer Adaptor for VP49 & VP50	V560

'SYSTEM 2000' MUPVC SOLVENT WELD WASTE (BS5255)

ORDER CODE	DESCRIPTION	MANUFACTURERS REF
32mm Solvent Grey		
68802000	Pipe 4m	MU1015G
68802010	Swept Bend 92.5°	MU1145G
68802020	Knuckle Bend 90°	MU1125G
68802030	Obtuse Bend 45°	MU1135G
68802040	Swept Tee 92.5°	MU1165G
68802050	Conversion Bend 90°	MU1215G
68802055	Spigot Bend - 45°	MU1055G
68802060	Straight Coupling	MU1105G
68802070	Expansion Coupling	MU1205G
68802080	Screwed Access Plug	MU1195G
68802090	Socket x Male Iron BSP Connector	MU1225G
68802100	Pipe Clip (Polypropylene)	MU1185G
68802110	Branch 45°	MU1175G
40mm Solvent Grey		
68802120	Pipe 4m	MU2015G
68802130	Swept Bend 92.5°	MU2145G
68802140	Knuckle Bend 90°	MU2125G
68802150	Obtuse Bend 45°	MU2135G
68802160	Swept Tee 92.5°	MU2165G
68802170	Conversion Bend 90°	MU2215G
68802175	Spigot Bend - 45°	MU2055G
68802180	Straight Coupling	MU2105G
68802190	Expansion Coupling	MU2205G
68802200	Screwed Access Plug	MU2195G
68802210	40x32mm Reducer	MU1115G
68802220	Socket x Male Iron BSP Connector	MU2225G
68802230	Pipe Clip (Polypropylene)	MU2185G
68802240	Branch 45°	MU2175G
50mm Solvent Grey		
68802250	Pipe 4m	MU3015G
68802260	Swept Bend 92.5°	MU3145G
68802270	Knuckle Bend 90°	MU3125G
68802280	Obtuse Bend 45°	MU3135G
68802290	Swept Tee 92.5°	MU3165G
68802295	Spigot Bend - 45°	MU3055G
68802300	Straight Coupling	MU3105G
68802310	Expansion Coupling	MU3205G
68802315	Conversion Bend 90°	MU3215G
68802320	Screwed Access Plug	MU3195G
68802330	50x32mm Reducer	MU2115G
68802340	50x40mm Reducer	MU3115G
68802350	Socket x Male Iron BSP Connector	MU3225G
68802360	Pipe Clip (Polypropylene)	MU3185G
68802370	Cross Tee 92.5°	MU3155G
68802380	Branch 45°	MU3175G

OVERFLOW & WASTE SYSTEMS

ABS WASTE - SOLVENT WELD (BSS255)

ORDER CODE	DESCRIPTION	MANUFACTURERS REF
32mm White		
68403010	Pipe 3m	WS11W
68403030	Swept Bend 92.5°	WS13W
68403040	Knuckle Bend 90°	WS15W
68403050	Obtuse Bend 45°	WS17W
68403060	Swept Tee 92.5°	WS21W
68403070	Swivel Bend 92.5°	WS23W
68403075	Spigot Bend - 45°	WS48W
68403080	Straight Coupling	WS25W
68403090	Expansion Coupling	WS61W
68403100	Screwed Access Plug	WS29W
68403110	Threaded Coupling BSP Female	WS31W
68403290	40x32mm Reducer	WS28W
68403130	Pipe Clip	WS33W
68403140	Tank Connector	WS35W
68403150	Junction 45°	WS39W
68403160	Socket Plug	WS44W
68403170	Adaptor - Male Iron	WS46W
40mm White		
68403180	Pipe 3m	WS12W
68403200	Swept Bend 92.5°	WS14W
68403210	Knuckle Bend 90°	WS16W
68403220	Obtuse Bend 45°	WS18W
68403230	Swept Tee 92.5°	WS22W
68403240	Swivel Bend 92.5°	WS24W
68403245	Spigot Bend - 45°	WS49W
68403250	Straight Coupling	WS26W
68403120	50x32mm Reducer	WS202W
68403260	Expansion Coupling	WS62W
68403270	Screwed Access Plug	WS30W
68403280	Threaded Coupling BSP Female	WS32W
68403300	Pipe Clip	WS34W
68403310	Tank Connector	WS36W
68403320	Cross Tee 92.5°	WS38W
68403330	Junction 45°	WS40W
68403340	Socket Plug	WS45W
68403350	Adaptor - Male Iron	WS47W
50mm White		
68403360	Pipe 3m	WS51W
68403380	Swept Bend 92.5°	WS52W
68403095	Swivel Bend 92.5°	WS60W
68403390	Knuckle Bend 90°	WS64W
68403400	Obtuse Bend 45°	WS54W
68403410	Swept Tee 92.5°	WS56W
68403415	Spigot Bend - 45°	WS66W
68403420	Straight Coupling	WS58W
68403430	Expansion Coupling	WS63W
68403440	Screwed Access Plug	WS72W
68403450	50x40mm Reducer	WS59W
68403460	Pipe Clip	WS65W
68403470	Cross Tee 92.5°	WS50W
68403480	Junction 45°	WS53W
68403490	Socket Plug	WS55W
68403500	Adaptor - Male Iron	WS57W

TUNDISH SYSTEM

ORDER CODE	DESCRIPTION	MANUFACTURERS REF
68900310	Tundish Bowl (PVC)	0A31
68900320	Tee for 35mm Flush Pipe	0A30
68900330	Tee for 32mm Flush Pipe	0A34
68900340	TUNPAC 1 Complete Kit Low Level Side Overflow	0F80
68900350	TUNPAC 2 Complete Kit High Level Side Overflow	0F81
68900360	TUNPAC 3 Complete Kit Close Couple Side Overflow	0F82
68900370	TUNPAC 4 Complete Kit Side Entry Concealed Cistern	0F83

BYE LAW 30/60 KITS COMPLETE

ORDER CODE	DESCRIPTION	MANUFACTURERS REF
68900210	Byelaw 30 Kit (England/Wales) 3/4" DIP Tube Bend (PP)	8YE30
68900220	Byelaw 60 Kit (Scotland) 1.5" DIP Tube Bend (PP)	8YE60

EXPANSION CISTERN

ORDER CODE	DESCRIPTION	MANUFACTURERS REF
68000010	Expansion Tank	EX104
68000110	Tank Lid (Polypropylene)	EX105

(Please contact your nearest Ashworth branch for full product listings)

RAINWATER SYSTEMS

HALF ROUND GUTTER PVC-U

ORDER CODE	DESCRIPTION	MANUFACTURERS REF
112mm Black		
68101010	Gutter 2m	RR100B
68101020	Gutter 4m	RR101B
68101030	Union Bracket (Screw to Fascia)	RR102B
68101040	Angle 90°	RR103B
68101050	Angle 135°	RR104B
68101060	Running Outlet	RR105B
68101065	Short Stop End Outlet	RR106B
68101070	Stop End External (Fix Fascia Brackets with 1 screw)	RR107B
68101080	Stop End Internal (Only use if Gutter length is less than 300mm)	RR108B
68101090	Fascia Bracket (Also fix close to both ends of Angles)	RR109B
68101100	Spacer Plate	RR39B
68100110	Galv Top Rafter Bracket	RR110
68100130	Galv Rise & Fall Bracket	RR111
68100120	Galv Side Rafter Bracket	RR112
150mm Black		
68101140	Gutter 2m	RL600B
68101150	Gutter 4m	RL601B
68101160	Union Bracket (Screw to Fascia)	RL602B
68101170	Angle 90°	RL603B
68101180	Running Outlet	RL605B
68101190	Stop End External (Fix Fascia Brackets with 1 screw)	RL607B
68101200	Stop End Internal (Only use if Gutter length is less than 300mm)	RL608B
68101210	Fascia Bracket (Also fix close to both ends of Angles)	RL609B
68100220	Galv Top Rafter Bracket	RL610
68100240	Galv Rise & Fall Bracket	RL611
68100230	Galv Side Rafter Bracket	RL612

ROUND DOWNPIPE PVC-U

ORDER CODE	DESCRIPTION	MANUFACTURERS REF
68mm Black		
68101250	Pipe 2.5m	RR121B
68101260	Pipe 4m	RR123B
68101270	Pipe 5.5m	RR124B
68101280	Pipe Connectors Std	RR125B
68101300	Pipe Bracket	RR126B
68101350	Offset Bend 112.5°	RR127B
68101380	Shoe	RR128B
68101390	Branch 112.5°	RR129B
68101410	Hopper Head Standard	RR130B
68101290	Pipe Connectors CI / AC	RR131B
68101360	Offset Bend 92.5°	RR132B
68101400	Access Pipe	RR135B
68101370	Joint Cover for Cleanline Offsets	RR136B
68101310	Pipe Socket Bracket	RR138B
68101420	Hopper Head Medium	RR140B
68101320	Pipe Clip Complete (Clip, Nut, Bolt & Backplate)	RR152B
68101330	Pipe Clip (Clip, Nut & Bolt)	RR153B
68101340	Pipe Clip (Backplate)	RR154B
110mm (for 150mm HR Gutter)		
68101385	Shoe	RL428B
68101425	Hopper Head Large	RL140B

Note - 110mm Soil Pipe & Fittings are used with 150mm Gutter.
Running Outlet Spigot accepts plain ended Pipe or Socket.

POLYFLOW DEEP CAPACITY GUTTER PVCU

ORDER CODE	DESCRIPTION	MANUFACTURERS REF
117 x 75mm Black		
68105200	Gutter 3m	RD500B
68105210	Gutter 4m	RD501B
68105220	Union Bracket (Fix to Fascia with 1 Screw)	RD502B
68105230	Angle 90° (Fix Fascia Brackets adjacent to both ends)	RD503B
68105240	Angle 135° (Fix Fascia Brackets adjacent to both ends)	RD504B
68105250	Running Outlet (Fix to Fascia with 2 Screws)	RD505B
68105260	Stop End External	RD507B
68105270	Stop End Internal (Only use if Gutter length is less than 300mm)	RD508B
68105280	Fascia Bracket (Also fix close to both ends of Angles)	RD509B
68105100	Galv Top Rafter Bracket	RD510
68105120	Galv Rise & Fall Bracket	RD511
68105110	Galv Side Rafter Bracket	RD512

(Please contact your nearest Ashworth branch for full product listings)

RAINWATER SYSTEMS

SQUARE GUTTER PVCU

ORDER CODE	DESCRIPTION	MANUFACTURERS REF
112mm Black		
68101450	Gutter 2m	RS2008
68101460	Gutter 4m	RS2018
68101470	Union Bracket (Fix to Fascia with 1 Screw)	RS2028
68101480	Angle 90° (Fix Fascia Brackets adjacent to both ends)	RS2038
68101490	Angle 135° (Fix Fascia Brackets adjacent to both ends)	RS2048
68101500	Angle 150° (Fix Fascia Brackets adjacent to both ends)	RS2158
68101510	Running Outlet (Fix to Fascia with 2 Screws)	RS2058
68101515	Short Stop End Outlet (Fix to Fascia with 1 Screw)	RS2068
68101520	Stop End External	RS2078
68101530	Stop End Internal (Only use if Gutter length is less than 300mm)	RS2088
68101540	Fascia Bracket (Also fix close to both ends of Angles)	RS2098
68100670	Galv Top Rafter Bracket	RS210
68100690	Galv Rise & Fall Bracket	RS211
68100680	Galv Side Rafter Bracket	RS212

SQUARE DOWNPIPE PVC-U

ORDER CODE	DESCRIPTION	MANUFACTURERS REF
65mm Black		
68101580	Pipe 2.5m	RS2218
68101590	Pipe 4m	RS2238
68101600	Pipe 5.5m	RS2248
68101610	Pipe Connectors Plain	RS2258
68101640	Pipe Bracket	RS2268
68101660	Offset Bend 112.5°	RS2278
68101690	Shoe	RS2288
68101700	Branch 112.5°	RS2298
68101710	Pipe Adaptor Square/Round	RS2318
68101670	Offset Bend 92.5°	RS2328
68101620	Pipe Connectors Offset Incl Bracket	RS2338
68101630	Pipe Connectors Flush Incl Bracket	RS2348
68100755	Access Pipe	RS2358
68101650	Pipe Bracket Flush	RS2368
68101680	Adjustable Offset (25-67mm)	RS2378

RAINSAVA RAINWATER DIVERTER (BS4576)

ORDER CODE	DESCRIPTION	MANUFACTURERS REF
68105800	Rainsava Diverter Kit - Fits Round and Square Pipes	RSR350

SOVEREIGN HIGH CAPACITY GUTTER PVCU

ORDER CODE	DESCRIPTION	MANUFACTURERS REF
68106000	Gutter 2m	RH7008
68106005	Gutter 4m	RH7018
68106010	Union Bracket (Fix to Fascia with 1 Screw)	RH7028
68106015	Angle 90° External	RH7038
68106035	Angle 135° External	RH7048
68106045	Running Outlet (Fix to Fascia with 2 Screws)	RH7058
68106025	Angle 120° External	RH7068
68106055	Stop End Left Hand External	RH7078
68106060	Stop End Left Hand Internal	RH7088
68106095	Fascia Bracket	RH7098
68106020	Angle 90° Internal	RH7138
68106040	Angle 135° Internal	RH7148
68106030	Angle 120° Internal	RH7168
68106065	Stop End Right Hand External	RH7178
68106070	Stop End Right Hand Internal	RH7188
68106085	Stop End Right Hand Profiled External	RH7198
68106050	Pipe Adaptor Square/Round	RH7208
68106075	Stop End Left Hand Profiled External	RH7218
68106090	Stop End Right Hand Profiled Internal	RH7298
68106080	Stop End Left Hand Profiled Internal	RH7318

RAINWATER SYSTEMS

OGEE EXTRA CAPACITY GUTTER PVCU

ORDER CODE	DESCRIPTION	MANUFACTURERS REF
68103300	Gutter 2m	ROG008
68103312	Gutter 4m	ROG018
68103320	Union Bracket (Fix to Fascia with 2 Screws)	ROG028
68103330	Angle 90° External	ROG038
68103370	Angle 135° External	ROG048
68103410	Running Outlet (Fix to Fascia with 2 Screws)	ROG058
68103350	Angle 120° External	ROG068
68103430	Stop End Left Hand External	ROG078
68103440	Stop End Left Hand Internal	ROG088
68103470	Fascia Bracket	ROG098
68103490	Galv Top Rafter Bracket	ROG10
68103510	Galv Rise & Fall Bracket	ROG11
68103500	Galv Side Rafter Bracket	ROG12
68103340	Angle 90° Internal	ROG138
68103380	Angle 135° Internal	ROG148
68103480	Connector to Cast Iron Ogee Left Hand	ROG158
68103360	Angle 120° Internal	ROG168
68103450	Stop End Right Hand External	ROG178
68103460	Stop End Right Hand Internal	ROG188
68103485	Connector to Cast Iron Ogee Right Hand	ROG198
68103400	Angle 150° External	ROG218

PLASTIC TO METAL GUTTER ADAPTORS

ORDER CODE	DESCRIPTION	MANUFACTURERS REF
68105900	Plastic to Metal Adaptor Half Round to Half Round	RR116
68105910	Plastic to Metal Adaptor Half Round to Ogee Left Hand	RR117
68105920	Plastic to Metal Adaptor Half Round to Ogee Right Hand	RR118
68105950	Plastic to Metal Adaptor Square to Half Round	RS216
68105930	Plastic to Metal Adaptor Square to Ogee Left Hand	RS217
68105940	Plastic to Metal Adaptor Square to Ogee Right Hand	RS218

GALVANISED UNIVERSAL RAFTER ARM & PIPE FITTINGS

ORDER CODE	DESCRIPTION	MANUFACTURERS REF
68100840	Top Rafter Arm (9° Metal Spar)	RB11
68100850	Side Rafter Arm (9° Metal Spar)	RB52
68100860	Downpipe Spacer	PA20



(Please contact your nearest Ashworth branch for full product listings)

VULCATHENE



Safe chemical
drainage

Vulcathene is a purpose-designed chemical resistant plumbing system that has been specified and installed in the laboratories of schools, universities, hospitals and research facilities worldwide for over 50 years.

Tried, tested and proven, Vulcathene is the only chemical drainage system to have withstood the test of time in the most demanding of laboratory applications.



Two easy jointing methods, Mechanical for demountable joints and Enfusion (Electrofusion) for welding joints, provide total versatility for your designers and installers of chemical waste systems.



Typical Applications

Laboratories in:

- Schools
- Universities & Colleges
- Hospitals & Clinics
- Pharmaceutical companies
- Research organisations

Key Product Information

- Size Range - 38mm to 152mm
- Temperature Rating -20°C to 100°C (Only intermittent at 100°C)
- Anti-siphon traps
- Swept fittings

Key Product Features

- Purpose designed for chemical drainage
- Mechanical or Electrofusion jointing methods
- Fully BBA Approved



VULCATHENE

VULCATHENE MECHANICAL CHEMICAL WASTE DRAINAGE

DESCRIPTION	MANUFACTURERS REF
38mm	
4m Pipe	W001
92.5 deg Bend	W181
92.5 deg Loose Nut Bend	W291
135 deg Bend	W191
135 deg Loose Nut Bend	W211
92.5 deg Swept Tee	W201
45 deg Single Wye	W371
45 deg Double Wye	W381
Coupler	W161
M.I. to Pipe Coupler	W141
F.I. to Pipe Coupler	W151
Glass Adaptor	W451
Thermal Stress Relief Unit	W801
Weathering Pipe	W921
Table D Flange (Undrilled)	W101T.D
Cutting Tool	W261
Spanner	W361
51mm	
4m Pipe	W001
92.5 deg Bend	W182
92.5 deg Loose Nut Bend	W292
135 deg Bend	W1921
135 deg Loose Nut Bend	W212
92.5 deg Swept Tee	W202
45 deg Single Wye	W372
45 deg Double Wye	W382
Coupler	W162
M.I. to Pipe Coupler	W142
F.I. to Pipe Coupler	W152
Glass Adaptor	W452
Thermal Stress Relief Unit	W802
Weathering Pipe	W922
Access Pipe	W502
Table D Flange (Undrilled)	W102T.D
Cutting Tool	W262
Spanner	W362
76mm	
4m Pipe	W001
92.5 deg Bend	W183
92.5 deg Loose Nut Bend	W293
135 deg Bend	W193
135 deg Loose Nut Bend	W213
92.5 deg Swept Tee	W203
45 deg Single Wye	W373
45 deg Double Wye	W383
Coupler	W163
Glass Adaptor	W453
Thermal Stress Relief Unit	W803
Weathering Pipe	W923
Access Pipe	W503
Table D Flange (Undrilled)	W103T.D
Cutting Tool	W263
Spanner	W363
102mm	
4m Pipe	W001
92.5 deg Bend	W184
92.5 deg Loose Nut Bend	W294
135 deg Bend	W194
135 deg Loose Nut Bend	W214
92.5 deg Swept Tee	W204
45 deg Single Wye	W374
45 deg Double Wye	W384
Coupler	W164
Glass Adaptor	W454
Thermal Stress Relief Unit	W804
Weathering Pipe	W924
Access Pipe	W504
Table D Flange (Undrilled)	W104T.D
Cutting Tool	W264
Spanner	W364
152mm	
4m Pipe	W001

For more information on Durapipe products call us free on **0800 783 7680**

VULCATHENE



VULCATHENE ENFUSION CHEMICAL WASTE DRAINAGE

DESCRIPTION	MANUFACTURERS REF
38mm	
92.5 deg Single Socket Bend	L281
92.5 deg Double Socket Bend	L171
45 deg Single Socket Bend	L211
45 deg Double Socket Bend	L191
92.5 Deg Swept Tee	L201
45 deg Single Wye	L371
45 deg Double Wye	L341
92.5 deg Double Branch	L351
U Bend	L1011
Coupler	L161
Male Iron Coupler	L141
Female Iron Coupler	L151
92.5 deg Swept Reducing Tee 51x38 (also available in 102x38 and 152x38)	L2021
45 deg Single Reducing Wye 51x38 (also available in 102x38 and 152x38)	L3721
45 deg Reducing Double Wye 51x38 (also available in 102x38 and 152x38)	L3421
Reducer 51x38 (also available in 102x38 and 152x38)	L3912
92.5 deg Swept Reducing Tee 76x38 (also available in 102x38 and 152x38)	L2031
45 deg Single Reducing Wye 76x38 (also available in 102x38 and 152x38)	L3731
Reducer 76x38 (also available in 102x38 and 152x38)	L3913
Thermal Stress Relief Unit	L801
Table D Flange	L361
Cleanout Plug	L241
Clamp	L261
51mm	
92.5 deg Single Socket Bend	L282
92.5 deg Double Socket Bend	L172
45 deg Single Socket Bend	L212
45 deg Double Socket Bend	L192
92.5 Deg Swept Tee	L202
45 deg Single Wye	L372
45 deg Double Wye	L342
92.5 deg Double Branch	L352
U Bend	L1012
Coupler	L162
Male Iron Coupler	L142
Female Iron Coupler	L152
Glass Adaptor	L452
92.5 deg Swept Reducing Tee 76x51 (also available in 102x51 and 152x51)	L2032
45 deg Single Reducing Wye 76x51 (also available in 102x51 and 152x51)	L3732
45 deg Reducing Double Wye 76x51 (also available in 102x51 and 152x51)	L3432
Reducer 76x51 (also available in 102x51 and 152x51)	L3923
Clamp Saddle	-
Thermal Stress Relief Unit	L802
Access Pipe	L902
Table D Flange	L362
Cleanout Plug	L242
Clamp	L262



VULCATHENE

VULCATHENE ENFUSION CHEMICAL WASTE DRAINAGE

DESCRIPTION	MANUFACTURERS REF
76mm	
92.5 deg Single Socket Bend	L283
92.5 deg Double Socket Bend	L173
45 deg Single Socket Bend	L213
45 deg Double Socket Bend	L193
92.5 Deg Swept Tee	L203
45 deg Single Wye	L373
92.5 deg Double Branch	L353
P Trap	LT13
Coupler	L163
92.5 deg Swept Reducing Tee 102x76 (also available in 152x76)	L2043
45 deg Single Reducing Wye 102x76 (also available in 152x76)	L3743
45 deg Reducing Double Wye 102x76 (also available in 152x76)	L3443
Reducer 102x76 (also available in 152x76)	L2934
Thermal Stress Relief Unit	L803
Access Pipe	L903
Table D Flange	L363
Cleanout Plug	L243
Clamp	L263
102mm	
92.5 deg Single Socket Bend	L284
92.5 deg Double Socket Bend	L174
45 deg Single Socket Bend	L214
45 deg Double Socket Bend	L194
92.5 Deg Swept Tee	L204
45 deg Single Wye	L374
92.5 deg Double Branch	L354
P Trap	-
Coupler	L166
45 deg Single Reducing Wye 152x102	L3764
Reducer 152x102	L3946
Thermal Stress Relief Unit	L804
Access Pipe	L904
Table D Flange	L364
Cleanout Plug	L244
Clamp	L264
152mm	
92.5 deg Single Socket Bend	L286
92.5 deg Double Socket Bend	L176
45 deg Single Socket Bend	L216
45 deg Double Socket Bend	L196
45 deg Single Wye	L376
92.5 deg Double Branch	LT16
P Trap	-
Coupler	L166
Thermal Stress Relief Unit	L806
Table D Flange	L366
Cleanout Plug	L246
Clamp	L266



FRIAPHON

Friaphon is the sound alternative to Cast Iron and Lagged Single Wall Plastic.

Friaphon sound attenuated drainage offers outstanding sound insulation properties compared with traditional Cast Iron or Lagged Single Wall Plastic Drainage Systems - making the perfect solution for meeting today's building acoustic requirements.

Friaphon is a purpose-designed, sound attenuating Soil and Rainwater Drainage System consisting of dual formed plastic pipes and moulded fittings in sizes 110mm and 160mm.

Pipe and fittings are rubber ring, push-fit jointed with boss pipes and branches in the range allowing standard, multiple waste pipe connections to the stack in sizes 32mm, 40mm and 50mm.

Friaphon offers superb insulation from noises emitted by sanitary installations in buildings and easily exceeds the requirements of world wide 'sound proofing' standards with recorded sound levels as low as 15dB(A).

Lower material costs coupled with speed of installation and no need for lagging means Friaphon offers significant cost savings over Cast Iron and Lagged, Single Wall Plastic Drainage Systems.

Friaphon Benefits

- Superb sound insulation
- Lower cost alternative to Cast Iron
- No lagging required
- Lower cost alternative to Lagged Plastic
- Lightweight, easy to install
- Easy push-fit assembly
- High impact and temperature resistant



Friaphon pipe is manufactured by dual forming two materials of different density. Friaphon Dual Technology guarantees the excellent sound insulation and airborne sound reduction properties of the system.



Sound waves are partially reflected along the boundary layers to be absorbed by the pipes mass.



With Friaphon fittings it is possible to achieve a high sound insulation level resulting from minor sound vibrations.



When using Friaphon double couplers as standard connectors, pipes can be connected to each other free of any structure-borne noises by way of a floating bearing of the pipe ends. At the same time this enables expansion to be accommodated.



Friaphon sound proofing, rubber lined support and sliding clips reduce the transmission of structure-borne noise.

(Please contact your nearest Ashworth branch for full product listing.)

FRIAPHON

FRIAPHON SOUND ATTENUATED DRAINAGE

ORDER CODE	DESCRIPTION	MANUFACTURERS REF
110mm		
FP121271	3m Sound Attenuated Pipe with smooth ends	FP 12 12 71
FP122270	Double Coupler (Standard Connector)	FP 12 22 70
FP121301	Support Clip with support ring and wall attachment	FP 12 13 01
FP121401	Intermediate Sliding Clip	FP 12 14 01
FP121501	Standpipe Bracket	FP 12 15 01
FP122307	Cushioning Section, Short, Height of fall up to 10m	FP 12 23 07
FP122301	Cushioning Section, Long, Height of fall exceeding 10m	FP 12 23 01
FP122019	Bend 15°	FP 12 20 19
FP122020	Bend 30°	FP 12 20 20
FP122021	Bend 45°	FP 12 20 21
FP122022	Bend 67°	FP 12 20 22
FP122024	Bend 87°	FP 12 20 24
FP122224	45° Branch	FP 12 22 24
FP122248	45° Double Branch	FP 12 22 48
FP123001	92.5° Four boss Double Branch	FP 12 30 01
FP122601	92.5° Five boss Single Branch	FP 12 26 01
FP123101	92.5° Corner Branch Two boss/access upstands	FP 12 31 01
FP122526	Access Pipe	FP 12 25 26
FP123201	Access Pipe Three boss upstands	FP 12 32 01
FP123301	Boss Pipe Four boss upstands, one open	FP 12 33 01
FP124301	Spigot Tail Waste Manifold	FP 12 43 01
FP122530	Sleeve	FP 12 25 30
FP122544	Bonded Sleeve	FP 12 25 44
FP123801	Reducer x 50mm Solvent socket, single boss upstand	FP 12 38 01
FP122540	Socket Plug	FP 12 25 40
FP123501	Strap-on Boss x 32mm	FP 12 35 01
FP123601	Strap-on Boss x 40mm	FP 12 36 01
FP123701	Strap-on Boss x 50mm	FP 12 37 01
FP124201	Screwed Access Cap	FP 12 42 01
160mm		
FP121273	3m Sound Attenuated Pipe with smooth ends	FP 12 12 73
FP122272	Double Coupler (Standard Connector)	FP 12 22 72
FP121303	Support Clip with support ring and wall attachment	FP 12 13 03
FP121403	Intermediate Sliding Clip	FP 12 14 03
FP121503	Standpipe Bracket	FP 12 15 03
FP122309	Cushioning Section, Short, Height of fall up to 10m	FP 12 23 09
FP122303	Cushioning Section, Long, Height of fall exceeding 10m	FP 12 23 03
FP122031	Bend 15°	FP 12 20 31
FP122032	Bend 30°	FP 12 20 32
FP122033	Bend 45°	FP 12 20 33
FP122036	Bend 87°	FP 12 20 36
FP122239	45° Branch x 100mm	FP 12 22 39
FP122245	45° Equal Branch	FP 12 22 45
FP122703	92.5° Single Branch	FP 12 27 03
FP122803	92.5° Branch x 100mm	FP 12 28 03
FP122528	Access Pipe	FP 12 25 28
FP123303	Boss Pipe Four boss upstands, one open	FP 12 33 03
FP122532	Sleeve	FP 12 25 32
FP122546	Bonded Sleeve	FP 12 25 46
FP122510	Reducer x 110mm	FP 12 25 10
FP123403	Strap-on Boss	FP 12 34 03
FT123901	Boss Connector x 32mm ring seal socket/spigot for solvent joint	FT 12 39 01
FT123902	Boss Connector x 40mm ring seal socket/spigot for solvent joint	FT 12 39 02
FT123903	Boss Connector x 50mm ring seal socket/spigot for solvent joint	FT 12 39 03
FT124001	Boss Adaptor (Rubber) x 32mm	FT 12 40 01
FT124002	Boss Adaptor (Rubber) x 40mm	FT 12 40 02
FT124101	Boss Adaptor (Rubber) x 50mm	FT 12 41 01
Accessories		
FP122970	Lubricant 125g tube	FP 12 29 70
FP122990	Primer 500ml tin	FP 12 29 90
FP122980	Adhesive 500ml tin	FP 12 29 80
FT800003	Pipe Cutter 30-125mm	FT 80 00 03
FT550510	Chamfering Tool	FT 55 05 10
FT550500	Reamer	FT 55 05 00
V468100	Unicollar Fire Protection	V 46 81 00

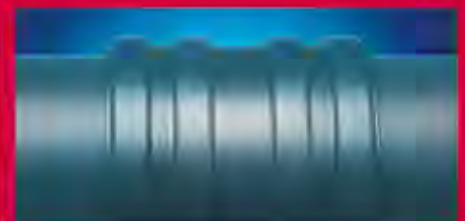

Other Durapipe Products



Impact resistant drainage



Akatherm HDPE is a plastic drainage system that is manufactured to meet high standards of durability and reliability

The combination of the excellent material properties of HDPE with homogeneous welded joints, give the Akatherm drainage system **high impact resistance properties** and a wide temperature range.

Akatherm HDPE is ideal for soil and rainwater drainage in many different building types.

Typical Applications

- Car parks
- Hotels
- Libraries
- Hospitals
- Public buildings
- Apartments

Key Product Information

- Size Range - 40mm to 315mm
- Electrofusion or butt weld

Key Product Features

- Impact resistant
- Lightweight
- Weather resistant
- Welded joints
- Pre-fabrication



Hot and cold water



Hot and cold pipework system

Friatherm provides quicker and easier installations for hot & cold water applications and is a cost effective alternative to copper.



Typical Applications

- Hospitals
- Schools
- Commercial buildings
- Hotels & Residential buildings
- Sports stadiums

Key Product Information

- Size Range - 16mm to 160mm
- Pressure Rating - (PN25 up to 63mm), & (PN10, 75mm to 160mm)
- Temperature Rating - 0° to 90°C

Key Product Features

- Lightweight
- Limescale & corrosion free
- Simple, one step jointing
- No power or hot works are required
- Fully WRAS approved
- Minimum 50 years service life

Speed of installation coupled with long-term performance benefits and no need for a power source or any 'hot works', means that Friatherm can offer **significant cost savings** over copper and other metal pipework systems. Furthermore, Friatherm offers a 50 year working life and due to the high grade of plastic material the system is completely limescale free and corrosion resistant.



Chilled and boosted cold water

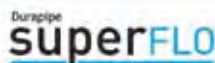

Chilled and cold water pipework

Durapipe superFLO offers tremendous advantages for chilled water/air conditioning and cold water services in buildings.

When considering environmental control systems or more specifically the pipework requirements for air conditioning, chilled or boosted cold water applications, Durapipe superFLO provides the perfect solution.

Durapipe superFLO is lightweight and remains extremely tough and durable even at temperatures as low as -40°C.

The complete system which incorporates pipes, fittings and valves offers a 50-year design life as well as numerous benefits that alternative pipework materials cannot provide. These include **reduced installation costs** via a fast solvent-weld jointing procedure, low maintenance costs due to its limescale and corrosion resistance properties as well as being extremely lightweight making the product much easier to handle on-site.

Durapipe superFLO is available in sizes ranging from 16mm - 315mm.

Typical Applications

- All building types for:
- Chilled Water/Air Conditioning
 - Boosted Cold Water

Key Product Information

- Size Range - 16mm to 315mm
- Pressure Rating - PN10
- Temperature Rating -40°C to 70°C

Key Product Features

- Lightweight
- Corrosion and limescale resistant
- Fast, simple jointing
- Ductile down to minus 40°C
- Reduced installation costs
- 50 year design life
- White solvent cement for visual indication



Heating pipework



A cost effective plastic water pipe system for low temperature hot water (LTHW) and hot & cold water services. Wefa offers a complete range of pipe, fittings & valves with excellent corrosion resistance properties making it the ideal alternative to copper tube and steel.

Wefa is a PP-R based socket fusion pipework system that is quick and easy to install making it ideal for a range of plumbing and heating applications.



Emergency Fuel Supply



Durapipe fuel systems is a complete range of dedicated secondary contained, fusion-welded pipework products for the safe and secure transfer of boiler and generator fuel oils.

The Durapipe fuel systems range represents a major innovation in below ground pipework technology and with the capacity for permanent interstitial monitoring offers the ultimate solution in environment protection.

Offering maximum protection against permeation and leak free jointing, Durapipe fuel systems conform to the E1 specification for underground fuel lines and satisfies the DEFRA requirements for the safe transfer of fuels and their vapours.



BLÜCHER® EUROPIPE

BLÜCHER EUROPIPE® is a lightweight, fast fit stainless steel drainage pipework system suitable for all types of sewage and rainwater drainage installations, e.g. in blocks of flats and high rise buildings, offices and industrial buildings and for sanitary discharge applications on ships in both vacuum and gravity systems.

- Unique and complete drainage pipework system OD 50 - 300 mm with pipe lengths 0.15m - 6m
- Corrosion resistant, non-combustible, light-weight
- Safe, simple and fast installation with push-fit socket joints, typically 40% faster to install than cast iron
- Hygienic, easy to clean, virtually no maintenance required
- Reliable, excellent whole life costs



BLÜCHER® EUROPIPE PIPE & FITTINGS

ORDER CODE	DESCRIPTION	MANUFACTURERS REF
50mm		
99362190	Stainless Steel Single Socket Pipe 1000mm lg	811.100.050
99362270	Stainless Steel Single Socket Pipe 2000mm lg	811.200.050
99362310	Stainless Steel Single Socket Pipe 3000mm lg	811.300.050
99362330	Stainless Steel Single Socket Pipe 4000mm lg	811.400.050
99362370	Stainless Steel Single Socket Pipe 6000mm lg	811.600.050
99362440	Bend 45°	820.045.050
99362480	Bend 87.5°	820.090.050
99362570	Single Equal Branch 87.5°	830.050.050
99362950	Single Equal Branch 45°	838.050.050
99363070	Double Ring Seal Socket	841.050.050
99363140	Socket Plug	844.100.050 S
99363280	Eccentric Increaser x 110mm	850.050.110
99361610	P Trap 87.5°	525.090.050 S
75mm		
99362200	Stainless Steel Single Socket Pipe 1000mm lg	811.100.075
99362280	Stainless Steel Single Socket Pipe 2000mm lg	811.200.075
99362340	Stainless Steel Single Socket Pipe 4000mm lg	811.400.075
99362380	Stainless Steel Single Socket Pipe 6000mm lg	811.600.075
99362450	Bend 45°	820.045.075
99362490	Bend 87.5°	820.090.075
99362590	Single Equal Branch 87.5°	830.075.075
99362970	Single Equal Branch 45°	838.075.075
99363080	Double Ring Seal Socket	841.075.075
99363150	Socket Plug	844.100.075 S
99363300	Eccentric Increaser x 110mm	850.075.110
99363290	Eccentric Reducer x 50mm	850.075.050 S
99361620	P Trap 87.5°	525.090.075 S
110mm		
99362210	Stainless Steel Single Socket Pipe 1000mm lg	811.100.110
99362290	Stainless Steel Single Socket Pipe 2000mm lg	811.200.110
99362320	Stainless Steel Single Socket Pipe 3000mm lg	811.300.110
99362350	Stainless Steel Single Socket Pipe 4000mm lg	811.400.110
99362390	Stainless Steel Single Socket Pipe 6000mm lg	811.600.110
99362460	Bend 45°	820.045.110
99362500	Bend 87.5°	820.090.110
99362550	Rear Access Bend 87.5°	822.090.110
99362610	Single Equal Branch 87.5°	830.110.110
99362990	Single Equal Branch 45°	838.110.110
99363020	Swept Branch 87.5°	839.110.110
99363030	Access Pipe	840.110.110
99363090	Double Ring Seal Socket	841.110.110
99363160	Socket Plug	844.100.110 S

(Please contact your nearest Ashworth branch for full product listing)

BLÜCHER® EUROPIPE

BLÜCHER® EUROPIPE PIPE & FITTINGS (cont.)

ORDER CODE	DESCRIPTION	MANUFACTURERS REF
99362530	Long Radius Bend 87.5°	821.090.110
99363330	Eccentric Increaser x 160mm	850.110.160
99363310	Eccentric Reducer x 50mm	850.110.050 S
99363320	Eccentric Reducer x 75mm	850.110.075 S
99361630	P Trap 87.5°	525.090.100 S
160mm		
99362220	Stainless Steel Single Socket Pipe 1000mm lg	811.100.160
99362300	Stainless Steel Single Socket Pipe 2000mm lg	811.200.160
99362360	Stainless Steel Single Socket Pipe 4000mm lg	811.400.160
99362400	Stainless Steel Single Socket Pipe 6000mm lg	811.600.160
99362470	Bend 45°	820.045.160
99362510	Bend 87.5°	820.090.160
99362560	Rear Access Bend 87.5°	822.090.160
99362620	Single Branch x100mm 87.5°	830.110.160
99363010	Single Equal Branch 45°	838.160.160
99363000	Single Branch 45° x100mm 45°	838.110.160
99363040	Access Pipe	840.160.160
99363100	Double Ring Seal Socket	841.160.160
99362540	Long Radius Bend 87.5°	821.090.160
99361640	P Trap 87.5°	525.090.160 S

BLÜCHER® FLOOR DRAINS

BLÜCHER Domestic stainless steel floor drains are ideal for installation in toilets, bathrooms and utility rooms in residential and commercial applications, sports centres, hotels, etc.

- Drains for all types of floorings
- Adjustable to fit into the finished flooring
- Removable water trap with excellent self-cleansing properties
- Flanges for liquid and sheet membrane
- Hygienic, easy to clean, virtually no maintenance required
- Reliable, long product life-time

OUTLET SHOWER DRAINS

ORDER CODE	DESCRIPTION	MANUFACTURERS REF
Horizontal Outlet		
99361110	Tiled Floors - 155mm Sq x 50mm spigot outlet	110.300.050
99361120	Tiled Floors - 155mm Sq x 75mm spigot outlet	110.300.075
99361310	Vinyl Floors - 155mm Dia x 50mm spigot outlet	210.300.050
99361320	Vinyl Floors - 155mm Dia x 75mm spigot outlet	210.300.075
99361130	Tiled Floors - 155mm Sq x 75mm spigot outlet (c/w 3 inlets)	111.303.075
99361325	Vinyl Floors - 155mm Dia x 75mm spigot outlet (c/w 3 inlets)	211.303.075
99361260	Tiled Floor - Mini Drain 155mm Sq x 42mm spigot outlet	181.300.042
99361430	Vinyl Floor - Mini Drain 155mm Sq x 42mm spigot outlet	281.300.042
Vertical Outlet		
99361210	Tiled Floors - 155mm Sq x 110mm spigot outlet	150.300.110
99361390	Vinyl Floors - 155mm Dia x 110mm spigot outlet	250.300.110
99361250	Tiled Floors - 155mm Sq x 110mm spigot outlet	160.300.110
99361370	Vinyl Floors - 155mm Dia x 110mm spigot outlet	260.300.110
99361220	Tiled Floors - 155mm Sq x 110mm spigot outlet (c/w 3 inlets)	151.303.110
99361400	Vinyl Floors - 155mm Dia x 110mm spigot outlet (c/w 3 inlets)	251.303.110

RODDING EYE POINTS

ORDER CODE	DESCRIPTION	MANUFACTURERS REF
99361150	Tiled Floor - Pull Nipple Cover 155mm Sq x 110mm outlet	144.155.110 S
99361170	Tiled Floor - Screw Faced Cover 155mm Sq x 110mm outlet	144.155.110 S
99361350	Vinyl Floor - Screw Faced Cover 155mm Dia x 110mm outlet	244.155.110 S

REMOVABLE WATER TRAP

ORDER CODE	DESCRIPTION	MANUFACTURERS REF
99361520	Internal Removable Water Trap Vertical Outlet	502.050.110 S*

* Compatible with most BLÜCHER Domestic Drains



INDUSTRIAL FLOOR DRAINS

BLÜCHER Industrial® are high-capacity stainless steel floor drains for all commercial and industrial applications, from food production and packaging halls to pharmaceutical manufacturing facilities.

- Drains for all types of flooring
- Gratings and frames for all industrial loading classes
- Removable water trap with excellent self-cleansing properties
- Filter buckets and sand baskets to collect larger particles
- Hygienic, easy to clean, no maintenance required
- Reliable, long product life-time



ONE PART INDUSTRIAL FLOOR DRAINS - BODIES ONLY

ORDER CODE	DESCRIPTION	MANUFACTURERS REF
Horizontal Outlet		
99361890	Tiled/Resin - 200mm sq x 110mm Spigot Outlet	763.402.110
99361910	Vinyl - 232mm dia x 110mm Spigot Outlet	763.602.110
99361900	Resin - 195mm dia x 110mm Spigot Outlet	763.502.110
Vertical Outlet		
99361810	Tiled/Resin - 200mm sq x 110mm Spigot Outlet	760.402.110
99361850	Vinyl - 232mm dia x 110mm Spigot Outlet	760.602.110
99361845	Resin - 195mm dia x 110mm Spigot Outlet	760.502.110
99361880	Tiled/Resin - 300mm sq x 110mm Spigot Outlet	760.403.110

ACCESSORIES FOR INDUSTRIAL FLOOR DRAINS

DESCRIPTION	MANUFACTURERS REF
Water Trap 2.7 to 3.4 l/s	562.002.000 S
Water Trap 6.0 to 7.3 l/s	562.003.000 S
Filter Basket 155mm dia 0.9l	780.002.000.05 S
Filter Basket 253mm dia 2.8l	780.003.000.05 S
Gratings	
Punched - 168mm sq. x 24mm Load class L 1500kg	790.168.000.03
Annular - 170mm sq. x 25mm Load class L 5000kg	790.168.000.10
Mesh - 168mm sq. x 25mm Load class L 1350kg	790.168.000.22
Ladder - 168mm sq. x 25mm Load class M 8400kg	790.168.000.25

For more information on our range of Blücher products call our experienced sales team

0800 783 7680

LINEAR DRAINAGE CHANNEL

BLÜCHER Channel is a stainless steel linear drainage system with a wide variety of applications including showers and swimming pools in leisure centres, wash down facilities for food production, abattoirs and kitchens, shower rooms, on ships, etc.

- Standard channels available ex stock
- Custom and bespoke channels available on short lead times
- Wide range of gratings for different load and flow requirements
- Removable water trap with excellent self-cleansing properties
- Filter bucket and sand basket to collect larger particles
- Hygienic, easy to clean, no maintenance required
- Reliable, long product life-time



ACCESS COVERS

ACCESS COVERS

DESCRIPTION	OUTLET	CODE
Tiled Floors	300x300mm	792.030.030
Tiled Floors	400x400mm	792.040.040
Tiled Floors	600x600mm	792.060.060
Tiled Floors	800x800mm	792.080.080
Tiled Floors	1000x1000mm	792.100.100

Completely water and gas tight covers for use with high specification floor finishes.

For installation in buildings where exceptionally high standards are required, e.g. Dairies, Swimming Pools & Hospitals where the hygienic properties of stainless steel are preferred.



GREASE SEPERATORS



- Manufactured from stainless steel
- Recessed inlet and outlet sockets
- Improved cleaning process
- Available for above or below ground
- Can be dosed manually or automatically

GREASE SEPERATORS

TYPE	NET VOLUME	CODE
Mini		
Standard	58 litres	970.070.110 A
Above Ground	114 litres	970.090.110 A
Below Ground	114 litres	970.090.110 B
Midi		
Above Ground	191 litres	970.135.110 A
Below Ground	191 litres	970.135.110 B
Maxi		
Above Ground	250 litres	970.180.110 A
Below Ground	250 litres	970.180.110 B

(Please contact your nearest Ashworth branch for full product listings)

ALUMASC RAINWATER

A complete range of engineered solutions to suit contemporary and traditional architecture from the UK's leading manufacturer of aluminium rainwater systems.



Alumasc Heritage cast aluminium gutters are manufactured in accordance with BS 2997:1958 (1980). All materials used meet and often exceed British Standard performance requirements. Standard products are approved by British Board of Agreement Certificate no 86/1671.



HARMER DRAINAGE

Alumasc's well established range of Harmer products provides a unique single source for innovative market leading solutions across the whole spectrum of rainwater handling and building drainage.



Harmer Floor

Harmer Roof

HERITAGE CAST ALUMINIUM RAINWATER

Features

- Wide range of profiles, sizes and colours available
- Highly durable with minimum maintenance
- Lightweight systems, easy to handle and fix
- BBA approved profiles and powder coated colours



HALF ROUND GUTTER - SOCKETED SYSTEM

ORDER CODE		DESCRIPTION	MANUFACTURERS REF	
Plain Mill Finish	PPC Black	100mm(4")	Plain Mill Finish	PPC Black
99300172	99300174	Gutters - 1.83M (6')	HR1/1	HR1/18L
99300180	99300190	Union Clips	HR1/11	HR1/118L
99300204	99300206	Stop Ends - External Left / Right Hand	HR1/13	HR1/138L
99300200	99300202	Stop Ends - Internal Left / Right Hand	HR1/12	HR1/128L
99300260	99300262	Running Outlets - Double Socket - 63dia Outlet	HR1/8	HR1/88L
99300242	99300246	90deg External Angle	HR1/5	HR1/58L
99300230	99300240	90deg Internal Angle	HR1/4	HR1/48L
99300252	99300254	135deg External Angle	HR1/7	HR1/78L
99300248	99300250	135deg Internal Angle	HR1/6	HR1/68L
99300208	99300210	Fascia Brackets	HR1/14	HR1/148L
Plain Mill Finish	PPC Black	113mm(4.5")	Plain Mill Finish	PPC Black
99300270	99300272	Gutters - 1.83M (6')	HR2/16	HR2/168L
99300322	99300326	Union Clips	HR2/26	HR2/268L
99300332	99300334	Stop Ends - External Left / Right Hand	HR2/28	HR2/288L
99300328	99300330	Stop Ends - Internal Left / Right Hand	HR2/27	HR2/278L
99300300	99300310	Running Outlets - Double Socket - 63dia Outlet	HR2/23	HR2/238L
99300284	99300286	90deg External Angle	HR2/20	HR2/208L
99300280	99300282	90deg Internal Angle	HR2/19	HR2/198L
99300292	99300294	135deg External Angle	HR2/22	HR2/228L
99300288	99300290	135deg Internal Angle	HR2/21	HR2/218L
99300336	99300338	Fascia Brackets	HR2/29	HR2/298L

(The above HALF ROUND range is also available in 125mm)

BEADED HALF ROUND GUTTER - SOCKETED SYSTEM

ORDER CODE		DESCRIPTION	MANUFACTURERS REF
Plain Mill Finish		125mm(5")	Plain Mill Finish
99300140		Gutters - 1.83M (6')	BHR6/325
99300146		Stop Ends - External Left / Right Hand	BHR6/331
99300144		Running Outlets Single Socket - 63dia Outlet	BHR6/330
99300152		Running Outlets Single Socket - 75dia Outlet	BHR6/333
99300156		90deg Internal Angle	BHR6/335
99300154		90deg Combined Angle	BHR6/334
99300158		90deg External Angle	BHR6/336
99300170		Fascia Brackets	BHR6/337

(The above BEADED HALF ROUND range is also available in 113mm)

BEADED DEEP RUN GUTTER - SOCKETED SYSTEM

ORDER CODE		DESCRIPTION	MANUFACTURERS REF
Plain Mill Finish		125mm(5")	Plain Mill Finish
99300392		Gutters - 1.83M (6')	HR4/243
99300400		Stop Ends - External Left / Right Hand	HR4/250
99300398		Stop Ends - Internal Left / Right Hand	HR4/249
99300396		Running Outlets Double Socket - 63dia Outlet	HR4/248
99300394		90deg Combined Angle	HR4/247
99300402		Fascia Brackets	HR4/251

HERITAGE CAST ALUMINIUM RAINWATER (cont.)

VICTORIAN OGEE GUTTER - SOCKETED SYSTEM

ORDER CODE	DESCRIPTION	MANUFACTURERS REF
Plain Mill Finish	PPC Black	113mm(4.5")
Plain Mill Finish	PPC Black	Plain Mill Finish
99300590	99300592	Gutters - 1.83M (6')
99300612	99300613	Union Clips
99300616	99300617	Stop-Ends External Right Hand
99300614	99300615	Stop-Ends Internal Left Hand
99300602	99300603	Running Outlets with Single Spigot/Socket - 63dia Outlet
99300580	99300582	Running Outlets with Single Spigot/Socket - 75dia Outlet
99300594	99300595	90deg External Angle
99300596	99300597	90deg Internal Angle
99300598	99300599	135deg External Angle
99300600	99300601	135deg Internal Angle
99300618	99300619	Fascia Brackets
Plain Mill Finish	PPC Black	125mm(5")
Plain Mill Finish	PPC Black	Plain Mill Finish
99300624		Gutters - 1.83M (6')
99300660		Union Clips
99300670		Stop-Ends External Right Hand
99300654		Stop-Ends Socket with 63mm Outlet
99300668		Stop-Ends Internal Left Hand
99300650		Running Outlets with Single Spigot/Socket - 63dia Outlet
99300634		90deg External Angle
99300636		90deg Internal Angle
99300638		135deg External Angle
99300640		135deg Internal Angle
99300674		Fascia Brackets

(The above VICTORIAN OGEE range is also available in 100mm)

MOULDED GUTTER - SPIGOTED SYSTEM

ORDER CODE	DESCRIPTION	MANUFACTURERS REF
Plain Mill Finish	PPC Black	125x100mm(5x4")
Plain Mill Finish	PPC Black	Plain Mill Finish
99300410	99300412	Gutters - 1.83M (6')
99300430	99300431	Union Clips
99300434	99300435	Stop-Ends External Left Hand
99300432	99300433	Stop-Ends Internal Right Hand
99300428	99300429	Running Outlets with Single Spigot/Socket - 63dia Outlet
99300416	99300418	90deg External Angle
99300420	99300421	90deg Internal Angle
99300422	99300423	135deg External Angle
99300424	99300425	135deg Internal Angle
99300436	99300437	Fascia Brackets
Plain Mill Finish	PPC Black	150x100mm(6x4")
Plain Mill Finish	PPC Black	Plain Mill Finish
99300490		Gutters - 1.83M (6')
99300508		Union Clips
99300512		Stop-Ends External Right Hand
99300510		Stop-Ends Internal Left Hand
99300504		Running Outlets with Single Spigot/Socket - 63dia Outlet
99300496		90deg External Angle
99300498		90deg Internal Angle
99300514		135deg External Angle
99300516		135deg Internal Angle
99300518		Support Brackets
99300506		Fascia Brackets

(The above MOULDED range is also available in 100x75mm)



FOR MORE INFORMATION CALL FREEPHONE

0800 783 7680

HERITAGE CAST ALUMINIUM DOWNPIPE

RAINWATER HEADS

ORDER CODE	DESCRIPTION	MANUFACTURERS REF
Plain Mill Finish	PPC Black	63mm dia Outlet
Plain Mill Finish	PPC Black	Plain Mill Finish
99300698	99300699	Rectangular 250 x 180 x 180mm
99300800	99300810	Flat Back Hopper
Plain Mill Finish	PPC Black	75mm dia Outlet
Plain Mill Finish	PPC Black	Plain Mill Finish
99300822	99300824	Rectangular 250 x 180 x 180mm
99300922	99300924	Flat Back Hopper
Plain Mill Finish	PPC Black	100mm dia Outlet
Plain Mill Finish	PPC Black	Plain Mill Finish
99300930		Rectangular 250 x 180 x 180mm
99300968		Flat Back Hopper



CIRCULAR PIPES & FITTINGS

ORDER CODE	DESCRIPTION	MANUFACTURERS REF
Plain Mill Finish	PPC Black	63mm
Plain Mill Finish	PPC Black	Plain Mill Finish
99300740	99300742	Pipe with Ears 63mm x 3m
99300708	99300710	Pipe with Ears 63mm x 2m
99300782	99300784	Shoes - with Ears
99300720	99300722	Sockets - with Ears
99300712	99300714	Pipe Clips - Standard
99300766	99300770	112.5deg Offset x 152mm projection
99300772	99300774	112.5deg Offset x 228mm projection
99300790	99300791	112.5deg Equal Branch
99300796	99300798	112.5deg Bend
Plain Mill Finish	PPC Black	75mm
Plain Mill Finish	PPC Black	Plain Mill Finish
99300852		Pipe with Ears 76.5mm x 3m
99300832	99300834	Pipe with Ears 76.5mm x 2m
99300902	99300904	Shoes - with Ears
99300846	99300848	Sockets - with Ears
99300838	99300842	Pipe Clips - Standard
99300884	99300886	112.5deg Offset x 152mm projection
99300888	99300892	112.5deg Offset x 228mm projection
99300910	99300912	112.5deg Equal Branch
99300918	99300920	112.5deg Bend

(Pipe & Fittings also available in 100mm & 150mm dia.)

SQUARE/RECTANGULAR

ORDER CODE	DESCRIPTION	MANUFACTURERS REF
Plain Mill Finish	75x75mm	Plain Mill Finish
99301018		Pipe with Ears - 3.0m
99301016		Pipe with Ears - 2.0m
99300996		112.5deg Bend - without Ears
99301000		112.5deg Offsets x 76 proj
99300992		112.5deg Two Part Offset x 305mm Projection
99300998		Pipe Clips - Standard
Plain Mill Finish	102x102mm	Plain Mill Finish
99301030		Pipe with Ears - 2.0m
99301028		Shoe - Front with Ears
99301026		112.5 degree Offsets x 76 proj
99301022		112.5deg Two Part Offset x 305mm Projection
99301024		Pipe Clips - Standard

(Pipe & Fittings also available in 100 x 75mm, 125x100mm & 150x100mm)

AQUALINE EXTRUDED ALUMINIUM GUTTER SYSTEM

Features:

- Unique dry joints, flush lines and concealed bracketry
- Fast flow outlets for enhanced performance
- Number of downpipes reduced
- Lightweight, durable and corrosion resistant
- Choice of colours and available in 3m lengths

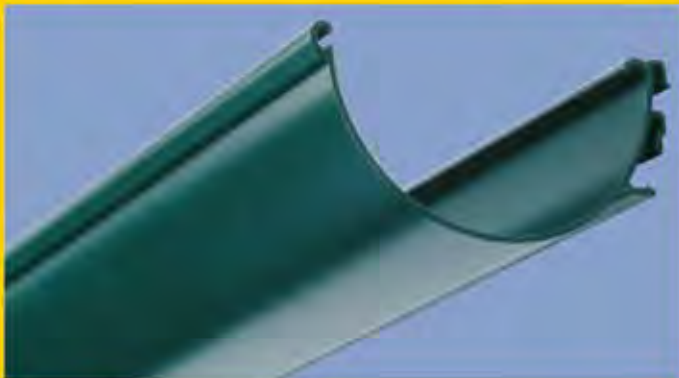

AQUALINE HALF ROUND GUTTER SYSTEM

DESCRIPTION	MANUFACTURERS REF
120x60mm HALF ROUND	
Gutter Assemblies - 3.0m (complete with Union Clips & Brackets)	EHR12/3MA
Gutters - 3.0m	EHR12/3M
Union Clips	EHR12/UCA
Brackets	EHR12/FB
90deg Angles - External	EHR12/EA90A
90deg Angles - Internal	EHR12/IA90A
135deg Angles - External	EHR12/EA13A
135deg Angles - Internal	EHR12/IA13A
Stop Ends - Left Hand	EHR12/SELHA
Stop Ends - Right Hand	EHR12/SERHA
Running Outlets - 63mm	EHR12/RO25A
Running Outlets - 75mm	EHR12/RO30A
Running Outlets - 75 x 75mm	EHR12/SO33A
Starter Pack (Includes Fixing Tool, Slide Locks, Seals and Lubricant)	EHR12/START

(Above also available in additional sizes 100x50mm and 150x75mm)

AQUALINE MODERN GUTTER SYSTEM

DESCRIPTION	MANUFACTURERS REF
150x120mm MODERN	
Gutter Assemblies - 3.0m (complete with Union Clips & Brackets)	EAQ15/3MA
Gutters - 3.0m	EAQ15/3M
Union Clips	EAQ15/UCA
Brackets	EAQ15/FBF
90deg Angles - External	EAQ15/EA90A
90deg Angles - Internal	EAQ15/IA90A
135deg Angles - External	EAQ15/EA13A
135deg Angles - Internal	EAQ15/IA13A
Stop Ends - Left Hand	EAQ15/SELHA
Stop Ends - Right Hand	EAQ15/SERHA
Running Outlets - 63mm	EAQ15/RO25A
Running Outlets - 75mm	EAQ15/RO30A
Running Outlets - 75 x 75mm	EAQ15/SO33A
Starter Pack (Includes Fixing Tool, Slide Locks, Seals and Lubricant	EAQ15/START

(Above also available in additional size 100x85mm)

(Please contact your nearest Ashworth branch for full product listings)

AQUALINE EXTRUDED ALUMINIUM GUTTER SYSTEM

AQUALINE DEEP RUN GUTTER SYSTEM

DESCRIPTION	MANUFACTURERS REF
110x85mm DEEP RUN	
Gutter Assemblies - 3.0m (complete with Union Clips & Brackets)	EDR11/3MA
Gutters - 3.0m	EDR11/3M
Union Clips	EHR11/UCA
Brackets	EHR11/FB
90deg Angles - External	EHR11/EA90A
90deg Angles - Internal	EHR11/IA90A
135deg Angles - External	EHR11/EA13A
135deg Angles - Internal	EHR11/IA13A
Stop Ends - Left Hand	EHR11/SELHA
Stop Ends - Right Hand	EHR11/SERHA
Running Outlets - 63mm	EHR11/RO25A
Running Outlets - 75mm	EHR11/RO30A
Running Outlets - 75 x 75mm	EHR11/SO33A
Starter Pack (Includes Fixing Tool, Slide Locks, Seals and Lubricant)	EHR11/START

(Moulded and Box profiles available)

GX PRESSED ALUMINIUM GUTTER SYSTEM

Features:

- The new GX Box Gutter comprises an internal joggle joint removing the need for a loose union clip joint. The gutter simply slots into place, resulting in a clean and tidy junction and 30% quicker installation time.
- GX Moulded and GX Smoothgutters are also available, for traditional wet jointing.



GX GUTTER SYSTEM

DESCRIPTION	MANUFACTURERS REF
127x102mm GX REGULAR	
Gutter Assemblies - 3.0m	GXJ2/3MA
Stop Ends - Left Hand	GXJ2/SELA
Stop Ends - Right Hand	GXJ2/SERA
90deg Angles - External	GXJ2/EA90A
90deg Angles - Internal	GXJ2/IA90A
Running Outlets - 75mm	GXJ2/RO30A
(Above also available in additional sizes 102x76mm, 152x102mm, 152x152mm & 204x152mm)	
140x98mm GX SMOOTH	
Gutter Assemblies - 3.0m (complete with Union Clips)	GXS2/3MA
Brackets / Stops	GXS2/BRKA
Stop Ends - Left Hand	GXS2/SELA
Stop Ends - Right Hand	GXS2/SERA
90deg Angles - External	GXS2/EA90A
90deg Angles - Internal	GXS2/IA90A
Running Outlets - 75mm	GXS2/RO30A
(Above also available in additional sizes 121x75mm, 170x125mm, 176x150mm & 224x150mm)	
139x102mm GX MOULDED	
Gutter Assemblies - 3.0m (complete with Union Clips)	GXM2/3MA
Stop Ends - Left Hand	GXM2/SELA
Stop Ends - Right Hand	GXM2/SERA
90deg Angles - External	GXM2/EA90A
90deg Angles - Internal	GXM2/IA90A
Running Outlets - 75mm	GXM2/RO30A

(Above also available in additional sizes 113x76mm, 162x102mm, 175x152mm & 207x152mm)

HARMER ROOF, FLOOR & SHOWER DRAINS

Harmer Roof Outlets provide drainage solutions for all types of flat roof low pitch industrial roofing.

Harmer Floor Drains suit virtually any interior drainage application, trapped or untrapped, and are for installation in all types of flooring.

Harmer Shower Drains are suitable for installation in either solid concrete or timber joisted floors.

HARMER ROOF DRAINS



HARMER AV OUTLET - VERTICAL

ORDER CODE	DESCRIPTION	MANUFACTURERS REF
50mm		
99260830	Vertical Spigot - Dome Grate	AV200
99260840	Vertical Spigot - Flat Grate	AV200/F
99260850	Vertical Screw - Dome Grate	AV200T
99260860	Vertical Screw - Flat Grate	AV200T/F
75mm		
99261050	Vertical Spigot - Dome Grate	AV300
99261060	Vertical Spigot - Flat Grate	AV300/F
99261070	Vertical Screw - Dome Grate	AV300T
99261080	Vertical Screw - Flat Grate	AV300T/F
100mm		
99261230	Vertical Spigot - Dome Grate	AV400
99261240	Vertical Spigot - Flat Grate	AV400/F
99261250	Vertical Screw - Dome Grate	AV400T
99261270	Vertical Screw - Flat Grate	AV400T/F

HARMER DETAIL OUTLETS

ORDER CODE	DESCRIPTION	MANUFACTURERS REF
50mm		
99260800	Balcony Outlet - Flat Grate	2B0
99260810	Two Way Outlet - Flat Grate	2TW
99260820	Mini Two Way Outlet - Flat Grate	2TW/M
75mm		
99261020	Balcony Outlet - Flat Grate	3B0
99261030	Gully Outlet - Dome Grate	3G0
99261040	Two Way Outlet - Flat Grate	3TW
100mm		
99261180	Balcony Outlet - Flat Grate	4B0
99261210	Gully Outlet - Dome Grate	4G0
99261220	Two Way Outlet - Flat Grate	4TW

HARMER ROOF ACCESSORIES

ORDER CODE	DESCRIPTION	MANUFACTURERS REF
99260890	AV Detail Grate Extension Pieces	23EP
99261330	AV Detail Grate Extension Pieces	46EP
99260280	Balcony Grate Extension Pieces	BO/EP
99260790	50X305mm Threaded Spigot Adaptors	2ADP
99261010	75X305mm Threaded Spigot Adaptors	3ADP
99261170	100X305mm Threaded Spigot Adaptors	4ADP
99261430	150X305mm Threaded Spigot Adaptors	6ADP

HARMER FLOOR DRAINS

- Flexibility of application
- Durable and long lasting
- High flow performance
- Fully adjustable
- Direct connection to drainage system
- Ease of maintenance
- Design options



HARMER FLOOR DRAIN ASSEMBLIES

ORDER CODE	DESCRIPTION	MANUFACTURERS REF
100mm		
99260210	Vertical Spigot Drain Body Outlet	BVS100
99260220	Vertical Spigot Drain Body Outlet with Inlet	BVS100/A
99260230	Horizontal Spigot Drain Body Outlet	BHS100
99260240	Horizontal Spigot Drain Body Outlet with Inlet	BHS100/A
150mm		
99260135	Untrapped Regular Circular Grate/Bezel Assembly	BC150MM
99260145	Trapped Regular Circular Grate/Bezel Assembly	BC150MM/T
99260165	Untrapped Regular Square Grate/Bezel Assembly	BS150MM
99260175	Trapped Regular Square Grate/Bezel Assembly	BS150MM/T
200mm		
99260115	Untrapped Regular Circular Vinyl Grate/Bezel Assembly	BCF200MM
99260125	Trapped Regular Circular Vinyl Grate/Bezel Assembly	BCF200MM/T

HARMER SHOWER DRAINS



HARMER SHOWER DRAIN ASSEMBLIES

ORDER CODE	DESCRIPTION	MANUFACTURERS REF
38mm Shower Body Assembly		
99260460	Shower Body Assembly - Horizontal Spigot	DHS38
99260440	Shower Body Assembly - Vertical Spigot	DVS38
99260690	Swift Pipe Connector	HS38/50
Clamp and Bell		
99260370	Clamp and Bell - White	CB38
99260440	Clamp and Bell - White / Ultra Safety Floor Insert	CB38A
(Locking Cover versions available add /LC, e.g. CB38/LC or CB38A/LC)		
Tile Grate Kit		
99260600	150mm Aluminium Star Pattern - White	DS150
99260580	150mm Nickel Bronze Star Pattern	DS150/NB
99260620	200mm Aluminium Star Pattern	DS200
(Note:- CB38, CB38A, DS150, DS200 Available in various standard colours)		

BLM 100% RECYCLED LEAD

BLM is the only British Lead Manufacturer exclusively delivering a 100% recycled product.

As part of Eco-Bat Technologies, the World's largest lead recycling company, BLM are assured of 100% recycled raw materials supplies. From there, using stringent environmental controls and state of the art manufacturing plant BLM produce the only range of quality lead products that has a truly green pedigree.

BLM – a commitment to lead that provides a twenty-first century service for a product as old as the hills.

Guide to Standard Lead Flashing Roll Weights

Weight per m ² Nominal Thickness	CODE 3		CODE 4		CODE 6		
	15.0kg 1.32mm		20.4kg 1.60mm		25.40kg 2.24mm		
Standard Widths:							
mm	Nearest Imperial	3m kg	6m kg	3m kg	6m kg	3m kg	6m kg
150	6"	7	13	9	18	11	23
240	9"	11	22	15	29	18	37
300	12"	13	27	18	37	23	46
390	15"	18	35	24	48	30	59
450	18"	20	40	28	55	34	68
600	24"	27	54	37	73	46	91

Lead sheet should be fitted in accordance with BS6915 as detailed in the LSA's Lead Sheet Manuals; further details and advice can be obtained from the LSA on 01892 822773.

BS:EN 12588 (1999) Rolled Lead Sheet Range

CODE	3	4	5	6	7	8
Thickness (mm)	1.32	1.80	2.24	2.65	3.15	3.55
Colour Code	GREEN	BLUE	RED	BLACK	WHITE	ORANGE
Weight (kg/m ²)	15.0	20.4	25.4	30.1	35.7	40.3

SIZING GUIDELINES FOR GOOD PRACTICE

Recommended approximate MAXIMUM SIZES of individual pieces of lead sheet

Code	L mm	W mm	APPLICATIONS						
			Soakers	Flashings	Pitched Gutters	Cladding	Weatherings	Parapet Ducts	Roofing
3	1000	-	P	O	O	O	O	O	O
4	1500	500	P	P	P	P	P	O	O
5	1500	600	O	P	P	P	P	P	P
6	2250	675	O	O	O	O	P	P	P
7	2500	675	O	O	O	O	O	P	P
8	3000	700	O	O	O	O	O	P	P



BLM LEAD ACCESSORIES

LEAD SLATES FOR PITCHED ROOFS

PRODUCT	PART	DESCRIPTION	UNIT
Std Lead Slate			
3"	0315	3" Dia 450mm base	Each
4"	0307	4" Dia 450mm base	Each
5"	0308	5" Dia 450mm base	Each
6"	0322	6" Dia 600mm base	Each

LEAD SLATES FOR FLAT ROOFS

PRODUCT	PART	DESCRIPTION	UNIT
Std Lead Slate			
3"	0303	3" Dia 450mm base	Each
4"	0306	4" Dia 450mm base	Each
5"	0311	5" Dia 450mm base	Each
6"	0314	6" Dia 600mm base	Each

QUICK SLATE

PRODUCT	PART	DESCRIPTION	UNIT
Quick Slate			
	0367	Flat 0 - 30 degree	Each
	0369	Pitch 20 - 40 degree	Each

T-PREN

PRODUCT	PART	DESCRIPTION	UNIT
T-Pren			
Exp joint	0344	3mx400mm	Roll
Plus	0339	1.5mx400mm	Roll

FIXINGS

PRODUCT	PART	DESCRIPTION	UNIT
Copper nails	0350	25mm Anular clout	1kg box
Copper nails	0353	25mm Anular clout	10kg box
Lead dot set	0333	4 part set + tool	Pk of 20
Permastrip	0338	20m x 50mm	Each
Permaclip	0345	375mm x 50mm	Pk of 10
Copper strip	0355	20m x 50mm	Each

POINTING

PRODUCT	PART	DESCRIPTION	UNIT
Pointing sealant	0381	310ml tubes	Box of 12

UNDERLAY

PRODUCT	PART	DESCRIPTION	UNIT
Ledtrak u/lay	0401	25m x 1.1m	Roll
Standard u/lay	0404	25m x 1.0m	Roll

COATINGS

PRODUCT	PART	DESCRIPTION	UNIT
Paintation Oil			
	0328	0.5L can	Each
	0326	1.0L can	Each
	0325	2.5L can	Each

LEADCOAT

PRODUCT	PART	DESCRIPTION	UNIT
Leadcoat	0410	500ml spray	Box of 12

CONTACT ASHWORTH

FREEPHONE 0800 783 7680

(Please contact your nearest Ashworth branch for full product listing.)

LEAD WORKER TIPS FROM BLM

LEAD-COTE

Prevents white staining on new lead

- Easy to apply solvent free formula
- Can be applied up to a week after fitting lead
- Works on damp lead
- Works up to a year after opening



Prevent this



Easy application



Traditional finish



THE SMART LEAD WORKER TIP No.1

NEW PRODUCT



A Lifetime in Lead

LEAD-COTE - prevents white staining on new lead

Easy to apply solvent free formula, can be applied up to a week after fitting lead, works on damp lead, works up to a year after opening

LEAD SLATES

The traditional lead weathering slate

- Craftsmen made for peace of mind
- Saves fabrication and welding time
- Flexibility of lead makes fitting easier



Saves you welding



Craftsmen made



Lasts a lifetime



THE SMART LEAD WORKER TIP No.5

NEW PRODUCT



A Lifetime in Lead

LEAD SLATES - the traditional lead weathering slate

Craftsmen made for peace of mind, saves fabrication and welding time, flexibility of lead makes fitting easier

QUICKSLATES

Suits up to 5" pipe sizes

- 2 types to fit flat or pitched roofs
- Can be cut to suit most pipe diameters up to 5"
- Easier to dress than aluminium



Cut to suit pipe



Easy to fit



Easy to dress



THE SMART LEAD WORKER TIP No.2

NEW PRODUCT



A Lifetime in Lead

QUICKSLATES - suits up to 5" pipe sizes

2 types to fit flat or pitched roofs, can be cut to suit most pipe diameters up to 5", easier to dress than aluminium

POINTING SEALANT

Waterproof pointing in a tube

- Saves making mortar on site
- Improves weatherproofing of flashing
- Special formula adheres to lead and masonry



Avoid this



Easy to apply



Professional finish



THE SMART LEAD WORKER TIP No.3

NEW PRODUCT



A Lifetime in Lead

POINTING SEALANT - waterproof pointing in a tube

Saves making mortar on site, improves weatherproofing of flashing, special formula adheres to lead and masonry

LEAD UNDERLAY

Extends the lifespan of lead roofing

- Essential for any lead sheet over 600mm wide
- Allows free thermal movement to prevent fatigue failure
- Conforms to LSA recommendations



Tough construction



A must for roofing



Extends lifespan



THE SMART LEAD WORKER TIP No.7

NEW PRODUCT



A Lifetime in Lead

LEAD UNDERLAY - extends the lifespan of lead roofing

Essential for any lead sheet over 600mm wide, allows for free thermal movement to prevent fatigue failure, conforms to LSA recommendations

HALL CLIPS

Secures flashing in a flash

- Up to 20 times faster than wedges
- Easy to fit
- Enables flashing to be dressed before pointing



Saves time



Easy to use



Professional finish



THE SMART LEAD WORKER TIP No.4

NEW PRODUCT



A Lifetime in Lead

HALL CLIPS - secures flashing in a flash

Up to 20 times faster than wedges, easy to fit, enables flashing to be dressed before pointing

LEAD VALLEY GUTTERS

For peace of mind, fit and forget them

- More flexible than brittle GRP
- Easily fitted whatever the valley angles
- 10 times the life of substitutes, fit and forget



Easy to lay



Suits any roof



Peace of mind



THE SMART LEAD WORKER TIP No.8

NEW PRODUCT



A Lifetime in Lead

LEAD VALLEY GUTTERS - for peace at mind, fit and forget them

More flexible than brittle GRP, easily fitted whatever the valley angles, 10 times the life of substitutes, fit and forget

BRANCHES

Bellshill

Marion Street, Off Main Street, Mossend,
Bellshill ML4 1EB

Main Tel No: 01698 742839

Fax No: 01698 745820

Bristol

Unit 9, Oak Lane,
Fishponds Trading Estate,
Bristol BS5 7UY

Main Tel No: 0117 961 7000

Fax No: 0117 961 7001

Leeds

Jawbone Industrial Estate, Wood Lane,
Rothwell, Leeds LS26 0RS

Main Tel No: 0113 282 0002

Fax No: 0113 282 5572

Radcliffe

Higher Ainsworth Road,
Radcliffe, Manchester M26 4AF

Main Tel No: 0161 723 3468

Fax No: 0161 724 6800

Rochester

Neptune Way, Medway City Estate,
Rochester, Kent ME2 4NA

Main Tel No: 01634 290731

Fax No: 01634 290778

Wednesfield

Neachells Lane, Wednesfield,
Wolverhampton WV11 3QF

Main Tel No: 01902 867400

Fax No: 01902 867499

White City

3/5 Silver Road, Off Ariel Way,
White City, London W12 7SG

Main Tel No: 0208 600 3210

Fax No: 0208 600 3232

