

Section 1

Section 2

Section 3

Section 4

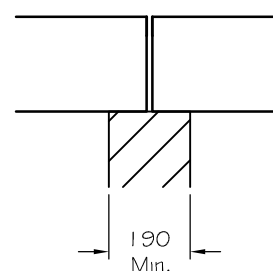
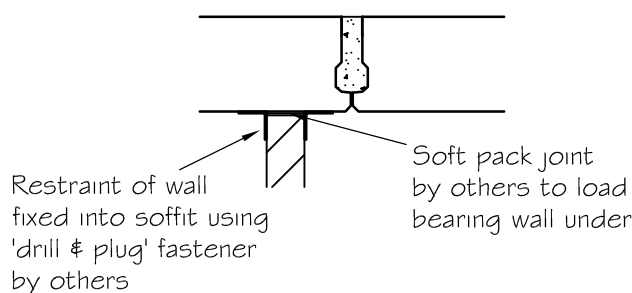
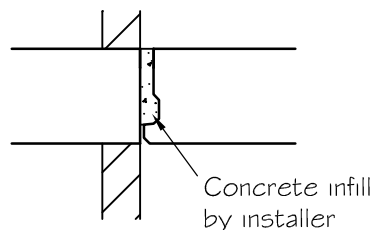
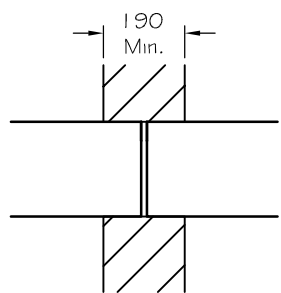

Section 5

Section 6

Section 7

Section 8

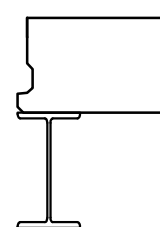
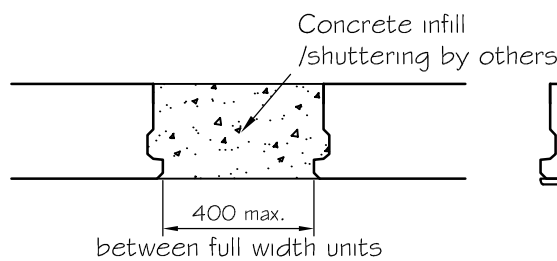
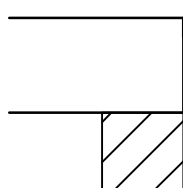
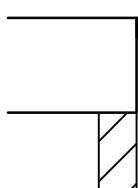
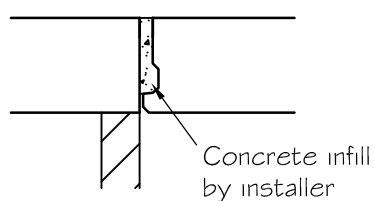

Section 9

Section 10

Section 11

Section 12

Section A

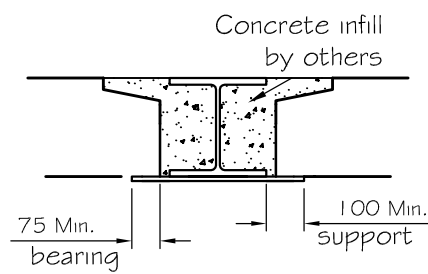
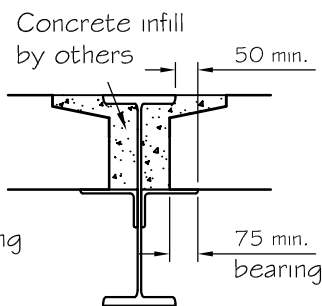
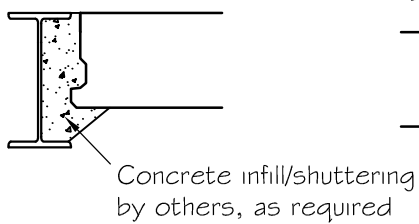
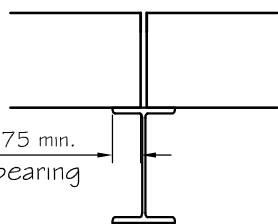
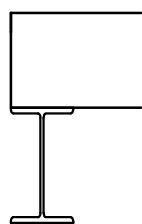

Section B

Section C

Section D

Section E

Section F

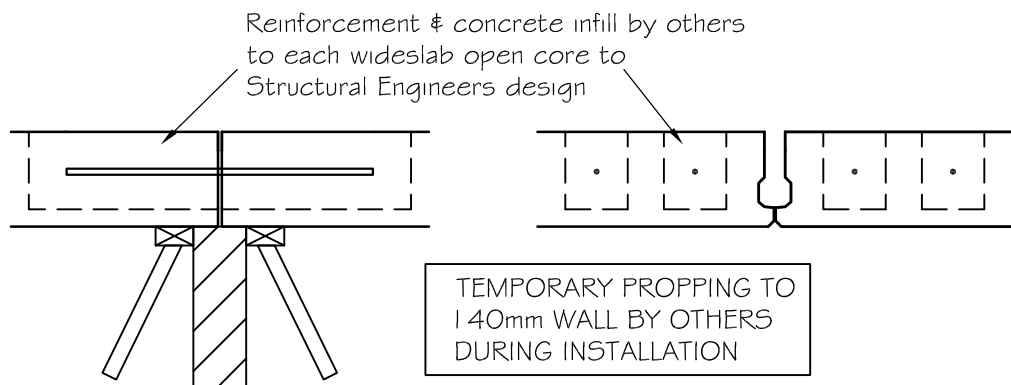

140mm SHARED BEARING WALL DETAIL

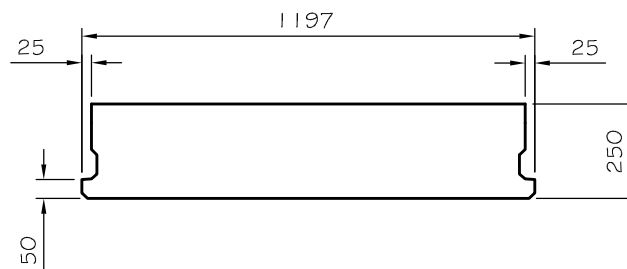

250mm DEEP WIDESLAB DIMENSIONS

TITLE
WIDESLAB STANDARD SECTIONS
250mm DEEP FLOORING - SOLID UNITS



dra by: _____
chkd by: _____

DRAWING NO.
CSD/WS/34