

Standard Component Details

Where no production information has been provided, Cumbrian Stone has allowed to manufacture the stone components shown on your quotation to the below details. Any variation to the below details must be confirmed prior to your order entering production, and Cumbrian Stone accepts no liability for any costs arising as a result of details not being checked and confirmed prior to manufacturing.

Cills

Square Cill - No Weathering
Stone Reference: C...

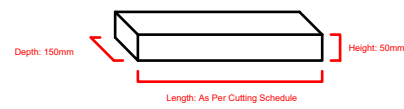

Drip Required - No

Slip Cill
Stone Reference: C...

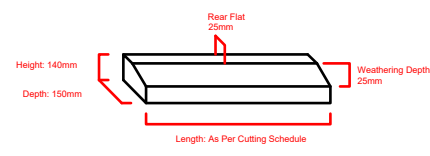

Drip Required - No

Stooled Cill
Stone Reference: C...

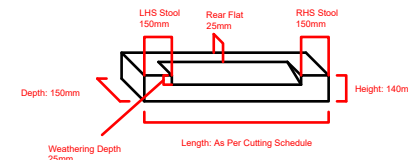

Drip Required - No

Stooled Cill - Mullion Window
Stone Reference: C...

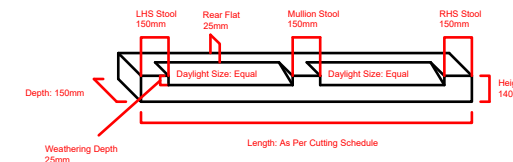

Drip Required - No

Heads / Lintels

Plain Head - Square Section
Stone Reference: L...

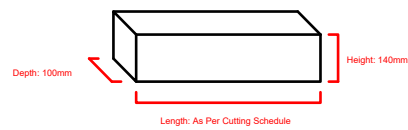

Rebate Required - No

Chamfered Head
Stone Reference: L...

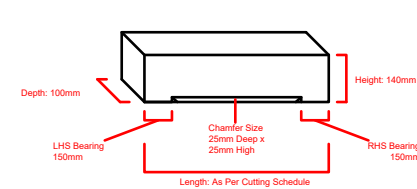

Rebate Required - No

Chamfered Head - Two Light Window
Stone Reference: L...

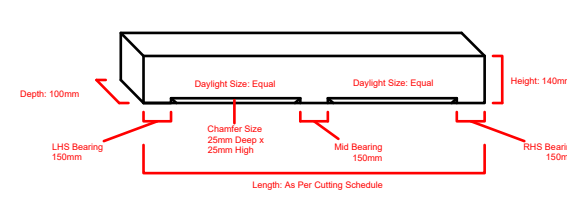

Rebate Required - No

Jambs and Mullions

Plain Jamb/Mullion - Square Section
Stone Reference: Jamb - J... Mullion - M...

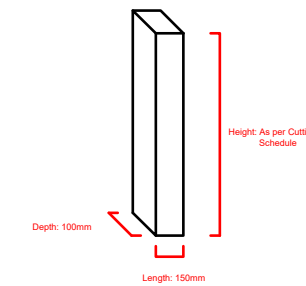

Rebate Required - No

Chamfered Jamb
Stone Reference: J...

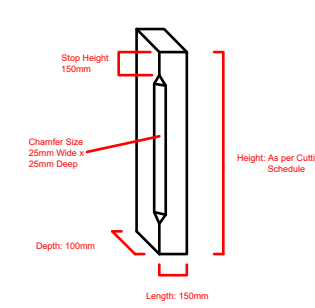

Rebate Required - No

Chamfered Mullion
Stone Reference: M...

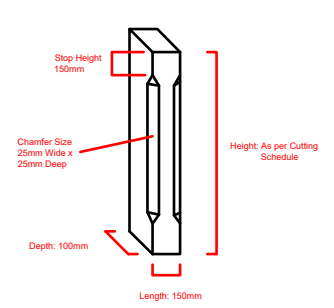

Rebate Required - No

Quoins

Plain Quoin - Square Section
Stone Reference: Q...

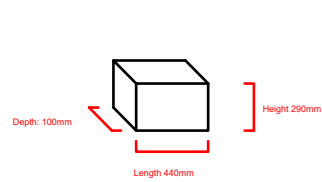

L Shaped Quoin - Square Section
Stone Reference: Q...

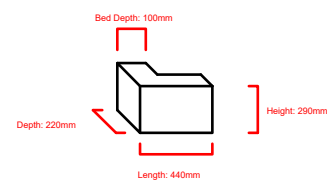

Copings

Flat Coping - Square Section
Stone Reference: CO...

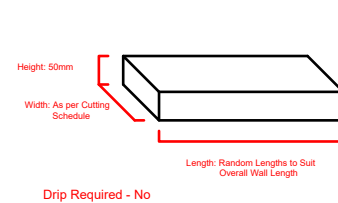

Drip Required - No

Once Weathered Coping - Straight
Stone Reference: CO...

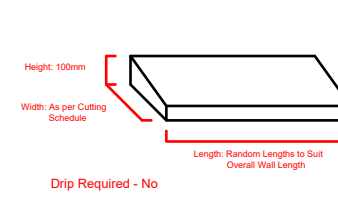

Drip Required - No

Twice Weathered Coping - Straight
Stone Reference: CO...

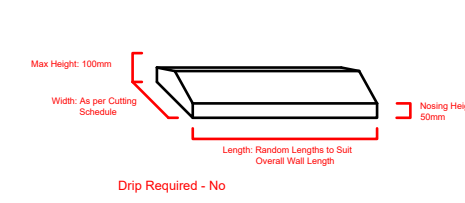

Drip Required - No

Chamfered Coping - Straight
Stone Reference: CO...

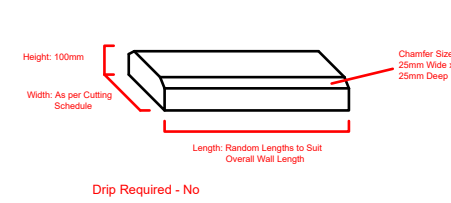

Drip Required - No

Plinth Stones

Plain Plinth - Square Section
Stone Reference: P...

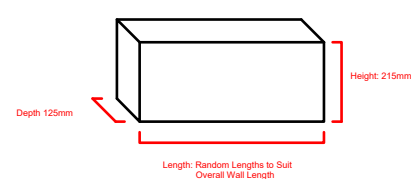

Chamfered Plinth - Straight
Stone Reference: P...

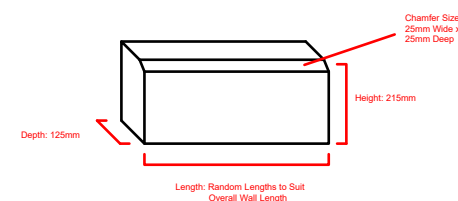

Paving

Plain Paving
Stone Reference: PA...

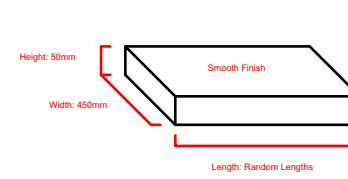

Ridge Stones

Angled Ridge
Stone Reference: R...

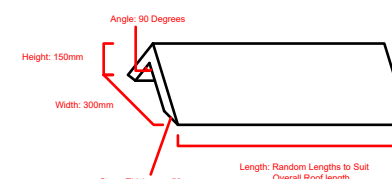

 <p style="text-align: right;">Natural Stone Specialists</p>	
CONTRACT TITLE	
Standard Component Details	
QUOTE / DWG REF:	STANDARD 2018
DRAWN BY:	Sam Morris
DATE:	30/05/2018