



**G4121 AMBIENCE  
FLUELESS GAS APPLIANCE  
INSTALLATION, SERVICING  
& USER INSTRUCTIONS**

FOR USE IN THE COUNTRIES STATED ON THE DATA PLATE AND CARTON  
WITH NATURAL GAS G20  
OR PROPANE GAS G31  
(REFER TO RATING LABEL)

**For the following countries: GB, IE**

**EVEN IF YOU HAVE FITTED THESE FIRES BEFORE,  
PLEASE FOLLOW THESE INSTRUCTIONS STEP BY STEP.**

***Legislation and regulations do change over time!***

**This product is not suitable for primary heating purposes.**

**LEAVE THESE INSTRUCTIONS WITH THE USER**

THE INSTALLER AND CUSTOMER MUST FILL IN THE SEPARATE GUARANTEE  
AND RETURN IT TO BURLEY WITHIN 7 DAYS OF FITTING.

A FREE SECOND YEAR GUARANTEE IS OFFERED SUBJECT TO THE FIRE BEING SERVICED  
BY A GAS SAFE™ REGISTERED ENGINEER (FORMERLY CORGI) DURING THE FIRST YEAR OF OWNERSHIP.  
PROOF OF SERVICING MUST BE RETAINED

**FAILURE TO HAVE THIS APPLIANCE FITTED BY A GAS SAFE™ REGISTERED  
INSTALLER (FORMERLY CORGI) INVALIDATES THE WARRANTY**

**Burley Appliances Ltd,**

Lands End Way, Oakham, Rutland, LE15 6RB

Telephone: +44 (0)1572 756956 Fax: +44 (0)1572 724390

e-mail: [info@burley.co.uk](mailto:info@burley.co.uk) web: [www.burley.co.uk](http://www.burley.co.uk)

**G4121InstUser  
G20/31  
March 2018**

## **INTRODUCTION**

Thank you for choosing this burley product. All of our products carry a CE mark which is awarded by an independent test house (notified body) and shows the fires have been type tested to meet the essential requirements of the European Gas Appliance Directive and the appropriate British Standards.

This is a highly efficient Flueless Live Fuel Effect Appliance. The burner system is very clean burning and a catalyst cleans the combustion products even further.

A thermostat in the burner control system adjusts heat output to maintain a room temperature, which can easily be set by the user. There is also a separate control to adjust the flame effect as required. Please demonstrate its operation to the customer before leaving.

An oxygen depletion sensing pilot light is also fitted and will sense any significant oxygen depletion in the room and shut the fire down safely.

**DUE TO THE SENSITIVE NATURE OF THE OXY PILOT, IT IS NOT UNUSUAL FOR THE PILOT TO EXTINGUISH UP TO/AFTER 1 MINUTE WHEN FIRST LIT. RELIGHT AND THE PILOT WILL STAY ALIGHT. THIS IS DUE TO THE MOIST GASES FORMED BY THE GAS, DROPPING DOWN ONTO THE PILOT SNUFFING IT OUT, ALONG WITH THE COLD METAL WORK. IT IS SAFE TO LEAVE THE PILOT ON 24 HOURS A DAY TO MAKE LIGHTING EASIER.**

BURLEY APPLIANCES IS THE ONLY COMPANY TO BENCH RUN AND THOROUGHLY TEST EVERY SINGLE GAS FIRE IT PRODUCES. BURLEY IS IN THE UNIQUE POSITION OF KNOWING THAT EVERY APPLIANCE LEAVES THE FACTORY IN PERFECT WORKING ORDER.

### **Fireguards.**

A fireguard is not supplied with this appliance; however it is recommended that a fireguard to BS6539 or BS6778 is fitted if the fire is to be used in the presence of young children, the elderly and the infirm.

Gas appliances must be installed in accordance with the rules in force. In the UK it is the law that all gas appliances must be installed by a Gas Safe™ registered installer (formerly CORGI), in accordance with the Gas Safety (Installation and Use) regulations (as amended). The installation must also be in accordance with the relevant parts of local and national building regulations and in accordance with BS5871 pt4 except where Burley instructions state differently. For the Republic of Ireland, reference should be made to IS813 and ICP3 and any guidance notes from Bord Gais. Failure to have the fire fitted by a qualified person nullifies ALL guarantees.

### **Declaration of Conformity**

Burley Magiglo Ltd. declares that the appliance described in "Technical data" conforms to the following standard(s) BS EN 14829: 2007

### **Efficiency Declaration**

This appliance has a thermal efficiency of 100% giving an Energy Efficiency Index of 91%. This is

**A** rated on all variants/options & emits less than 130mg/kWh NOx

**1 LIGHTING PROCEDURE.** Identify the control valve fitted to the appliance and follow the appropriate instructions.

**1.1 Total Control**

Ensure that the ON/OFF switch is in the ON position (-) & that the manual knob is also pointing downwards towards its ON position (see below).

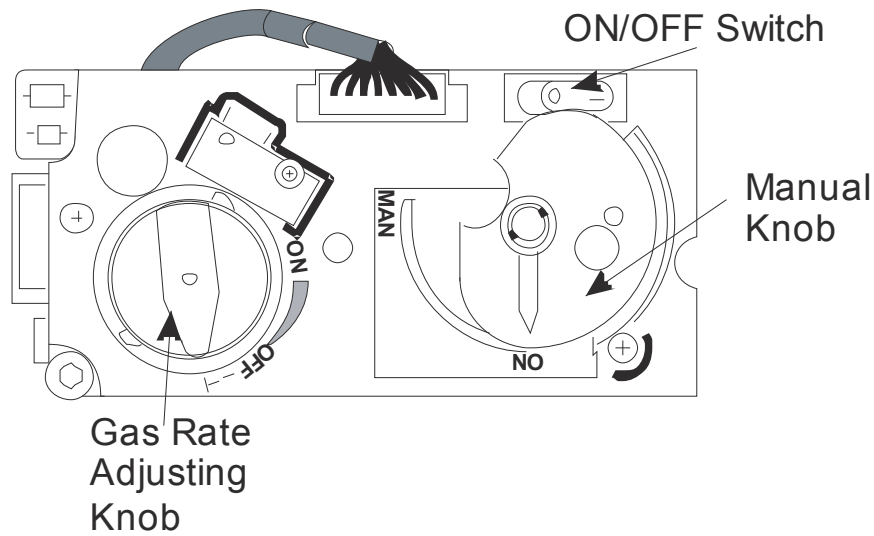

**1.2** Simultaneously press and hold the ● (red circle) and 🔥 (large flame) buttons until an acoustic signal confirms the start sequence has begun, then release the buttons.

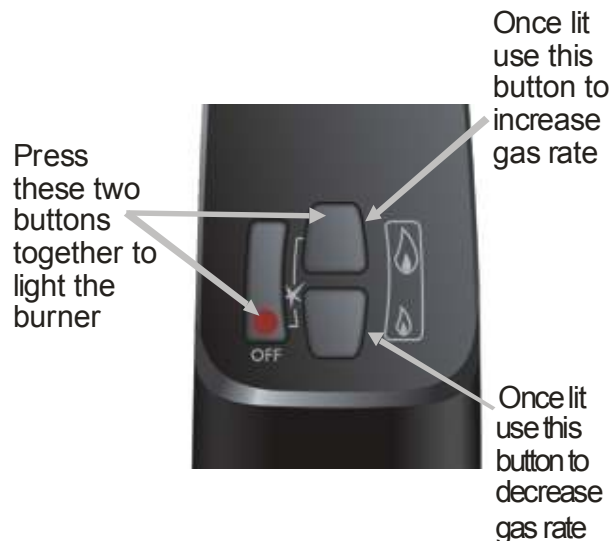

**1.3** The acoustic signal should cease and be replaced with the ticking sound of the spark igniter. When the pilot flame is lit the igniter will stop & another acoustic signal will confirm the pilot has been established (if the pilot fails to establish repeat the process. Due to the safe & efficient nature of the fire it is not unusual for this to take two or even three attempts). The acoustic signal will now cease & the gas rate adjusting knob will automatically turn to its high setting.

**1.4** To adjust the gas rate to desired setting press the 🔥 (large flame) to increase the flame height or 🔥 (small flame) to decrease the flame height on the handset.

**1.5** To leave the fire in **standby mode** press the 🔥 (small flame) until the main burner goes out. The pilot should remain on in this mode & help to reduce condensation.

**1.6** To turn the fire off completely (including the pilot) press the ● red OFF button on the handset.

## Battery Replacement

### **Handset**

- 1.7 On the back of the handset remove the battery cover by pressing down the top of the cover & sliding it down. Remove & unclip the old battery & replace with a new PP3 9 volt battery.

### **Receiver Unit (located under burner)**

Remove the heat shield surrounding the unit. Pull the receiver unit out from underneath the burner & remove the top cover. Remove old batteries & replace with four new AA batteries ensuring the polarities are correct. Replace the battery cover & return the receiver unit to its original position. REPLACE THE HEATSHIELD over the unit.



**CAUTION:** With the exception of battery replacement, the battery holder must be located within the heat shield **at all times**.

## Programming Handset to Receiver

If for some reason the remote handset requires re-programming to operate the receiver follow the procedure below:

1. Press and hold using a pointed object the receiver's reset button until you hear two acoustic signals.
2. After the second longer acoustic signal, release the reset button and within the subsequent 20 seconds, press the  (small flame) on the remote handset until you hear an additional long acoustic signal confirming the new code is set.

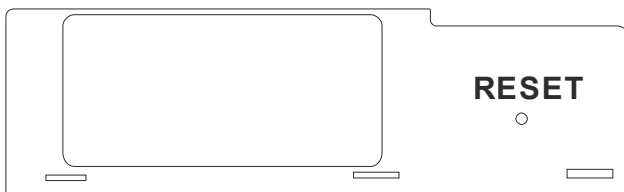

## **MANUAL CONTROL**

- 1.8** There are 2 control knobs on the appliance. The right hand one controls On/Off and pilot/main burner. The left hand one is the comfort level thermostat which turns the fire down once the indicated temperature is reached. If during use the pilot is alight but the main burner is not lit, check the thermostat position and if necessary select a warmer setting. The range of the thermostat is around 13°C – 45°C.

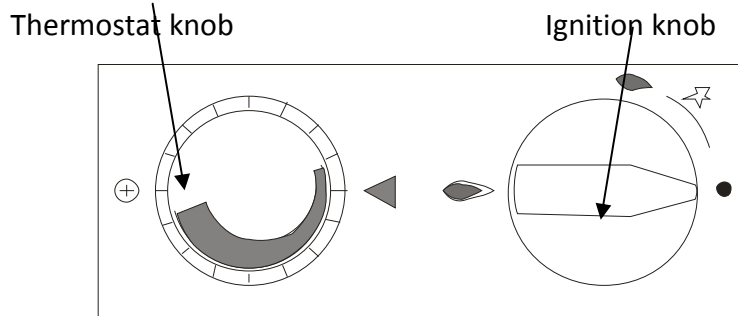

- 1.9** To light the fire, first ensure the right hand control (Ignition) knob is turned clockwise to OFF, and then press the knob for several seconds then turn slowly anticlockwise to the ignition position. A click will be heard and the pilot (under right side of fuel bed) should light. If it does not, repeat the operation a few times to purge any air in the pipe. Continue to hold knob for 15 – 20 seconds to establish the pilot and then release. If the pilot fails to establish, turn off, wait 1 minute then repeat lighting procedure. Once the pilot has been established rotate the knob counter clockwise towards the larger flame symbol to light the main burner. If no gas comes through to the main burner, rotate the left hand knob (thermostat) to a hotter room setting and the fire will light.

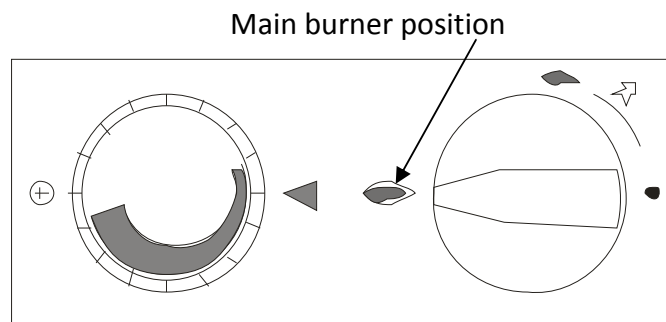
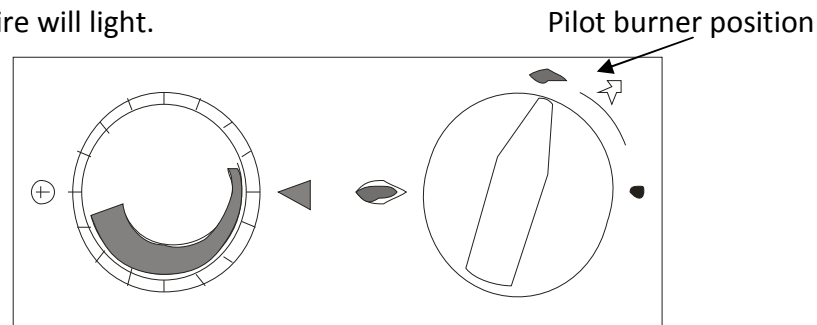

Main burner operational & thermostatically controlled

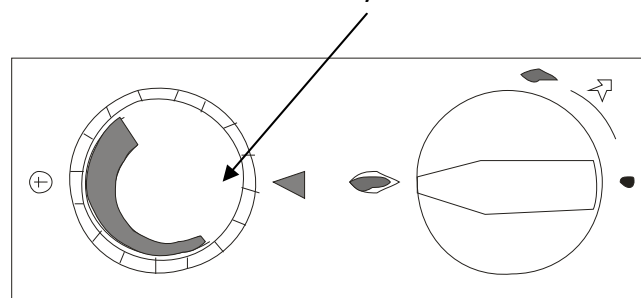

- 1.10** To turn the fire off, rotate the right-hand knob fully clockwise back to its OFF position.

## 1.11 SLIDE CONTROL

1. Slide the control lever firmly to the right of its travel and listen for the spark generator clicking which should light the pilot.
2. Continue to hold for a further 10 seconds.
3. If the pilot fails to stay alight, slide the control lever to the left of its travel (off) & wait for 3 minutes & repeat the process.
4. Once the pilot is alight, slide the control lever to the desired position.
5. To turn the fire off slide the control lever to the left of its travel.
6. The off position on the bezel may not correspond exactly with the control lever. This is only intended as an indication.

## 1.12 Battery Replacement

Behind the ash pan cover, located towards the right of the burner is the spark generator which is fitted with the battery facing you. Flick out the battery from the right hand end of the battery holder and remove battery. Replace with a good quality 1.5v AA battery ensuring the polarity markings on the battery correspond with the markings on the battery holder. Check the spark generator clicks when the control linkage is operated.

## 1. TECHNICAL DATA

Refer to the appliance data badge (affixed behind control door)

**ENSURE THAT THE LOCAL CONDITIONS OF USE CORRESPOND TO THE INFORMATION ON THE DATA BADGE.**  
**- THIS PRODUCT CAN NOT BE CONVERTED -**

	<b>Natural Gas G20</b>	<b>LPG (Propane) G31</b>
<b>Category</b>	I2H	I3P
<b>Supply Pressure</b>	20mBar	37mBar
<b>Inlet Pressure</b>	20mBar*	37mBar*
<b>Heat Input (Net)</b>	<b>(High)</b> 3.5kW <b>(Low)</b> 1.7kW	3.5kW (250g/h) 1.7kW (120g/h)
<b>Inlet Connection</b>	8mm Compression	8mm Compression
<b>Injector</b>	stereo 300	stereo 120

\*The inlet pressure must be **within +/- 1mBar** of specification with **all** gas appliances in the house switched on **and also** with just the appliance operating. If outside of this tolerance the fault is most likely to be in the installation pipe work or service governor at the meter. If the problem is the meter governor, this is the property of the gas service provider (such as Transco / National Grid 0800 111999 or Bord Gais) and they should be called to rectify this. The fire will not operate correctly if the pressures are incorrect.

## 2. UNPACKING THE APPLIANCE

- 2.1 Carefully examine the carton for damage before unpacking. If it is obviously damaged, consult the supplier as to whether to proceed with the installation.
- 2.2 Make sure the carton is stood upright and open the top. Remove the cardboard top fitting and place to one side; this box can be used as a hearth protector when installing the fire.
- 2.3 Remove the fittings boxes contained within and open them and check the condition of the contents. Remove the fire and examine its general condition.
- 2.4 If satisfied by the general condition proceed with the installation. If in any doubt, seek advice from the supplier in the first instance. **Please read these instructions fully before proceeding even if you have fitted this model before.**

### **3. GENERAL REQUIREMENTS**

- 3.1 Gas appliances must be installed in accordance with the rules in force. In the UK it is the law that all gas appliances must be installed by a Gas Safe™ registered installer (formerly CORGI), in accordance with the Gas Safety (Installation and Use) regulations (as amended). The installation must also be in accordance with the relevant parts of local and national building regulations and in accordance with BS5871 pt4 except where Burley instructions state differently. For the Republic of Ireland, reference should be made to IS813 and ICP3 and any guidance notes from Bord Gais. Failure to have the fire fitted by a qualified person nullifies **ALL** guarantees.
- 3.2 The space to be heated must have a wall vent of at least 100cm<sup>2</sup> of ventilation and an openable window or patio door. The vent must be positioned at least 1 metre away from the appliance. A vent may have been supplied with the appliance and this is the preferred type although it is possible to use alternatives.
- 3.3 In the Republic of Ireland two vents of not less than 60cm<sup>2</sup> each, one not less than 1.6m above the other, must be installed in the room.
- 3.4 When providing ventilator openings consideration must be given to the avoidance of locations where discomfort from draughts may cause the user to block the openings. Similarly the possibility of curtains or furniture blocking ventilation openings must be considered. Floor vents, closable window vents or chimneys are not suitable means of ventilation.
- 3.5 Working surfaces include the air outlet grille.
- 3.6 The appliance must not be used in a room area of less than 40m<sup>3</sup> in volume. To convert cubic feet (ft<sup>3</sup>) to cubic metre (m<sup>3</sup>) divide the room volume in cubic feet by 35.3. Adjoining spaces, not separated by a door may be combined.
- 3.7 The appliance must not be used on or against a combustible surface.
- 3.8 No furniture, soft furnishings, decorations, wall coverings or curtains must be within 1 metre of the appliance and its convection outlets.
- 3.9 The appliance must not be installed in high rise flats or basements.
- 3.10 Do not install this appliance in:
  - a) A bathroom, shower room or in a room used or intended to be used as sleeping accommodation. Sleeping areas must be separated from the appliance by a door.
  - b) In a cupboard or compartment within such a room; or
  - c) In a cupboard, compartment or space adjacent to such a room if there is an air vent from the cupboard, compartment or space into such a room.
- 3.11 When the appliance is not to be used for a time, ensure the gas control or adjacent isolators are turned off.
- 3.12 Using this appliance as a sole heat source can lead to condensation problems in periods of cold weather and heavy use. Always ensure that the room has a background heat source such as central heating or storage heaters.
- 3.13 The fire must not be run with its door open or with cracked, incorrectly fitted or missing glass.
- 3.14 The glass door acts as a guard on the appliance to prevent risk of fire or injury from burns and no part of it may be permanently removed. It does not give full protection for young children, the elderly or infirm. Parts of the appliance get hot, an additional guard to BS6539 or BS6778 must be used in the presence of children, the elderly and infirm.
- 3.15 This is not a drying appliance. Do not place clothing or other articles, on or against it.
- 3.16 Do not store or use flammable substances on or near the appliance.
- 3.17 Do not spray aerosols on or near the appliance when it is working.
- 3.18 Do not use whilst painting & decorating, or in newly decorated rooms as the residues can lead to unpleasant smells from the appliance. Always cover or have the appliance removed when decorating.
- 3.19 The appliance must not be used in rooms where the atmosphere is likely to contain water or chemical vapours which may adversely affect the appliance or its finish.

3.20 If any material such as plastic melts onto the surface of the glass, turn the appliance **off** and **allow it to cool. Do not remove the material when hot.** A proprietary ceramic hob cleaner such as 'hob brite' can be used to clean the glass. Only clean the appliance when cold.

**3.20.1 On no account must the air inlets under the stove or outlet grills (see diagram below) be obstructed.**

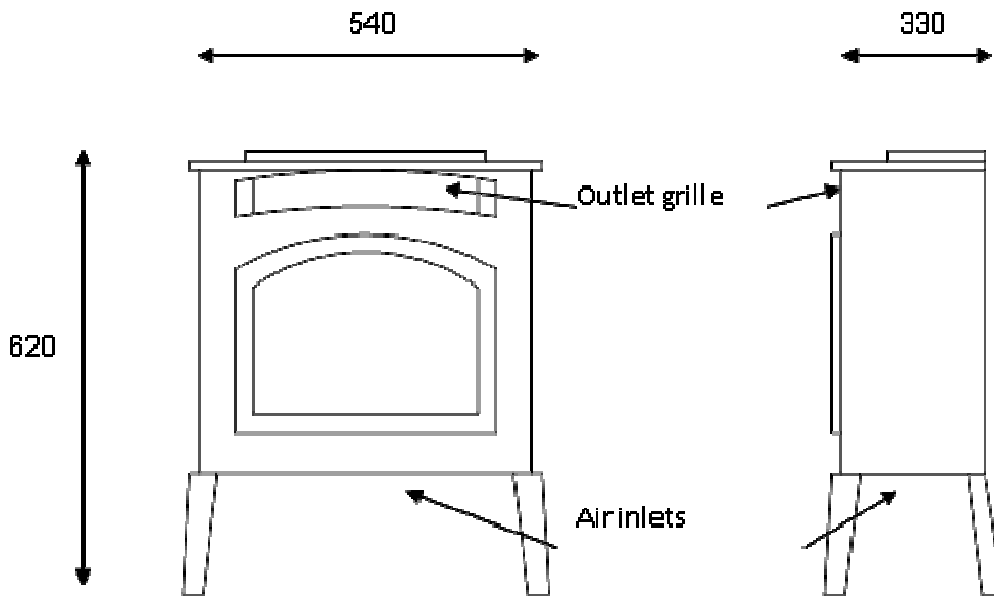

#### 4. **WARNINGS**

- 4.1 Read the instructions before using this appliance.
- 4.2 This appliance requires installation by a competent qualified person.
- 4.3 Use only in a correctly sized and ventilated area.
- 4.4 Once the ceramics have been positioned in accordance with the installation instructions, they must not be moved except for servicing.
- 4.5 The surfaces of the appliance become very hot during use.
- 4.6 Before cleaning or maintenance switch fire OFF and allow to cool.
- 4.7 Any purpose provided ventilation should be checked regularly to ensure it is free from obstruction.

#### 5. **Hearths, floor protection and carpets**

- 5.1 This appliance does not need a hearth and can be used on wooden, laminate floors and non-combustible surfaces. It must not be placed directly onto carpets or rugs. Where the floor is carpeted, the carpet must finish 100mm clear of the appliance legs and be fully removed underneath. Loose rugs should be kept well away from the appliance (warn the customer of this).
- 5.2 Standing the appliance directly on a floor can lead to discolouration and / or drying out.
- 5.3 When a hearth is used, the top surface can be wood but be aware that heat can discolour certain finishes over a period of time and can dry out poorly seasoned wood causing splitting. The hearth should be 100mm larger than the appliance all round and minimum 12mm thick. Carpets can come to the edge of the hearth.



## 6. Clearance to Walls

**Rear Clearance** - The rear of the appliance can be installed directly against a non combustible wall. A distance of 50mm should be allowed to walls with wooden cladding, wallpaper, or finishes likely to be affected by heat.

**Side Clearance** - The sides of the appliance can be installed with 25mm of side clearance to non combustible materials. Combustible material such as wood may be fitted to within 100mm of the sides of the firebox provided it protrudes no further forward than 100mm.

**Top Clearance** - The heat from the appliance is concentrated towards the front edge directly above the combustion products outlet. The clearances stated relate to a distance from the back edge of the stove.

A non combustible shelf may be fitted to within 50mm of the top edge of the fire.

Maximum depth of shelf	100mm	150mm	200mm
Minimum distance from	200mm	250mm	300mm
Top of fire to underside of shelf			

**These distances should be doubled if the shelf is above the outlet grille.**

**The fireplace and ALL materials including paints or lacquers must be rated for a minimum constant temperature of 150°C. Any hearth or back panel not meeting the above clearance dimensions must be made from a non-combustible material such as marble or slate, although 'lightweight' and tiled surrounds can be used provided they have a minimum heat rating of 150°C.**

## 7. Gas Supply

The gas supply should be installed in accordance with all regulations in force. Consideration should be given to the routing to conceal from view and avoid potential damage. Pipes through walls should be sleeved. The gas connection is 8mm compression and should be made in semi-rigid tubing such as copper pipe. Before working on pipework plug open ends. A servicing isolator is supplied with the appliance and this should be used to permit disconnection for servicing etc.

All gas work should be undertaken by a competent person, see General Requirements.

## 8. Siting the Appliance

- 8.1 If the appliance is to be in or in front of an open fireplace, the chimney or flue **MUST** be blocked off to prevent the draw from disrupting the flame pattern of the fire, which can lead to poor combustion, or sooting. Extractor fans must be sited at least 2m from the appliance.
- 8.2 Check the room has sufficient volume and ventilation; if these requirements cannot be met then the appliance should not be installed. Consideration should be given to the requirements of other appliances working in the same room space. If other Flueless appliances such as cookers are in the same room then consideration should be given to the combined room size requirement.
- 8.3 Check the room has a background heat source such as central heating radiators, storage heaters etc.
- 8.4 Check the appliance data plate details are correct for the kind of gas used and the country of installation.
- 8.5 Carry out any building works such as in-gle-nooks, hearths and recesses. If no hearth is being used, remove any carpets to required clearance. Lay in the gas supply and leave a tail to connect to.
- 8.6 Position the appliance and ensure it is stable and unlikely to move in normal use. Some hearths can be slippery and it is best to fix the appliance by removing the plastic plugs in the feet and screwing down. Care should be taken to ensure correct clearances around the stove.
- 8.7 **Before** connecting any pipes to the appliance, fully purge pipes of any debris or swarf etc.
- 8.8 Attach the gas connection to the stove and carry out a leak test in an approved manner.

## 9. Laying the Logs

Open the hinged door on the appliance. This is secured by a 10mm nut to gain access to the logs. On no account should the appliance be operated whilst the door is open except for brief periods during maintenance. Do not lay the log matrix in any way other than that shown. Check the log layout as they may have been damaged during transit.

### **LOG LAYOUT (NATURAL GAS)**



The rear matrix and front log should only need removing for servicing. The rear matrix locates onto the burner and the front log is pushed to the extreme left hand side. Take care to locate them correctly to ensure clean combustion. No additional logs should be added to the fire.

Note the pilot position on the right hand side of the burner.

### **LOG LAYOUT (LPG)**

The rear matrix and front log are fitted similar to the Natural Gas fire. The base log locates onto the burner and the front log is pushed to the extreme left hand side as shown. Take care to locate them correctly to ensure clean combustion. No additional logs should be added to the fire.

Note the pilot position on the right hand side of the burner.



**\*Note – The 2 top logs will be supplied glued**

**in position and should not be removed or repositioned. If they become detached then they can be fitted as per the diagram but must on no account be discarded or fitted in any other way.**

**Front Log - IMPORTANT - the log must be this way up! Placed fully to the left NG & PR**

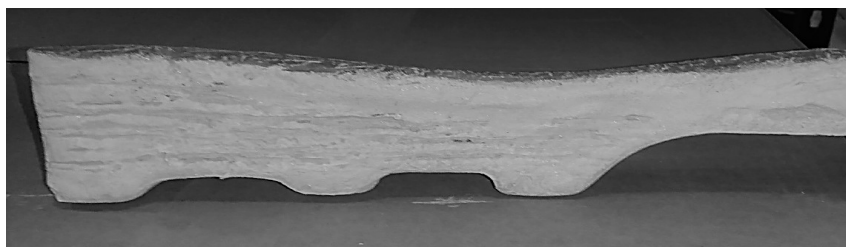

*Pilot side*

- Always secure the door closed after laying the fuel effects.
- Do not attempt to use any unit with broken or damaged glass.
- Do not use the fire with broken logs.
- Do not add any additional fuel elements to the fire.
- Do not use similar looking parts from other appliances, use only genuine spare parts.
- Do not use the appliance for burning waste.

## 10. Commissioning the Appliance

**If the pipes have not been purged of debris do it before lighting the appliance. Failure to do so will result in blockages within the burner and pilot.**

**Burley Appliances is the only company to bench run and thoroughly test every single gas fire it produces. Burley is in the unique position of knowing that every appliance that leaves the factory is in perfect working order.**

The installer should measure the inlet pressure with the appliance running on high and ensure it is to specification.

Attach a manometer to the inlet test point and ensure there is a pressure of 20mb (+/- 1mb) for natural gas appliances or 37mB for propane appliances.

Now turn on every other gas appliance in the house and re-check the pressure. The pressure must still be within the tolerance of +/- 1mb.

Turn off all other gas appliances and turn the fire down to pilot only, the pressure must still be within the tolerance of +/- 1mb.

If it is not TRANSCO or BORD GAIS must be called to adjust the regulator to the house before the fire can be commissioned further.

Any large pressure fluctuation indicates pipework or governor problems and should be rectified. Instruct the customer on the operation of the appliance and leave all instructions with them.

The fires are factory set and no adjustments should be made in the field.

## 11. Spark Failure

The gap between the pilot electrode and the pilot should be 3.5 – 4.5mm and normally adjustment is not necessary. Check the fire lights at least 3 times out of 5 attempts. Visually check that the spark arcs across to the gas port on the pilot. The electrode is delicate but if necessary can be adjusted to set the spark. If the igniter fails a lighted taper can be inserted into the pilot area when attempting to light the pilot and this should help the fire to light.

## 12. Fireguards

The glass front on the appliance acts as a dress guard but does not provide full protection. An additional guard should always be fitted in the presence of young children, the elderly or the infirm.

## 13. Oxygen Depletion Pilot System

There is a highly sensitive oxygen depletion sensor designed into the pilot light. If any part is damaged the entire unit **must** be replaced using only genuine spare parts as similar looking parts from other appliances may well give inferior performance. If the fire repeatedly trips off in operation the oxygen depletion system may be operating and a qualified engineer should investigate this.

## 14. Instructing the Customer

The installer should instruct the customer on the operation of the appliance and hand over all instruction leaflets.

**The customer must be made aware of the need for regular servicing of the appliance; this will normally be once a year.**

The customer should also be made aware that no rubbish should be thrown into the fire bed and that purpose provided ventilation should be checked regularly.

## 15. Servicing Instructions

**Before commencing any servicing, ensure that the gas is isolated and the appliance is cool.**

Cleaning – The casing should be wiped with a cloth dampened in soapy water. The glass may be cleaned with any non-abrasive cleaner such as ‘hob brite’.

The coals contain refractory fibre (RCF). Excessive exposure to these materials may cause temporary irritation to the eyes, skin and respiratory tract; consequently, it makes sense to take care when handling these parts to ensure that the release of dust is kept to a minimum. We recommend the use of a HEPA filtered vacuum to remove any dust and soot accumulated in the appliance before and after working on it. When replacing these articles, they should not be broken up, but sealed in heavy duty polythene bags labelled RCF Waste’, which may be disposed of at a tipping site licensed for industrial waste. Protective clothing is not required, but normal hygiene rules of no smoking, eating or drinking in the work area should be followed.

Controls – The system for monitoring the oxygen supply to the burner is not adjustable and must not be put out of operation. Should the oxy-pilot system need to be replaced, the original manufacturer’s parts must be used.

Injectors – Only **original** manufacturer’s injectors must be used.

The unit **must** be serviced at least once per year, preferably at the beginning of the heating season. All servicing must be carried out by a qualified service person. A combustion analysis check should be carried out using an analyser to BS7967 and sampling the entire width of the combustion product outlet. Ratio of CO/CO<sub>2</sub> should be less than 0.002 within 30 minutes. (20ppm CO per 1% CO<sub>2</sub>) A reading of CO in the room centre should give a rise of less than 9ppm over ambient, peak reading.

Light the fire using the method in the instructions and ensure that the pilot lights consistently and the pilot flame envelopes the thermocouple evenly, it is located at the front on the right-hand side.

The pilot should hold in 6-10 seconds. Turn control to main burner, this should light smoothly. Ensure the valve gives adequate turn down and the thermostat bulb reduces the burner rate to low when heated.

Locate thermostat bulb in a cool place off the appliance and preferably outside of any inglenooks, to ensure it is sensing room air temperature.

Run the appliance for 10 minutes, ensuring burner flames settle evenly.

The gas manifold pressures are factory pre-set using highly accurate equipment, and **must** not be altered.

The catalyst is unlikely to need replacement during the life of the appliance. The appliance should be inspected before use and at least annually by an authorised service person. More frequent cleaning may be required due to accumulation of lint and dust from carpeting etc. Hoover under fire regularly paying attention to the area around pilot.

It is imperative that the control compartments, burners and circulating air passageways of the appliance be kept clean. Replacement parts are available from your local dealer.

**BURLEY APPLIANCES ARE THE ONLY COMPANY TO BENCH RUN AND THOROUGHLY TEST EVERY SINGLE GAS FIRE IT PRODUCES. BURLEY IS IN THE UNIQUE POSITION OF KNOWING THAT EVERY APPLIANCE LEAVES THE FACTORY IN PERFECT WORKING ORDER.**

**Due to our policy of continual improvement and development the exact accuracy of descriptions and illustrations cannot be guaranteed.**

## GENERAL REQUIREMENTS

1. The appliance is intended as a secondary heat source. Check that a primary source of heat (such as radiators) is present in the room. If insufficient primary heat is being used there may be a build up of condensation.
2. The appliance must not be used on or against a combustible surface. No furniture or curtains must be close to the appliance (or at risk of being blown close)
3. In the event of gas leakage, the gas supply must be turned off and advice sought.
4. The guard on the appliance is to prevent risk of fire or injury from burns and no part of it may be permanently removed. It does not give full protection for young children, the elderly or infirm. Parts of the appliance get hot, it is strongly recommended that an additional guard to BS6539 or BS6778 is used in the presence of children the elderly or infirm.
5. This is not a drying appliance. Do not place clothing or other articles, on or against it.
6. Do not store or use flammable substances on or near the appliance.
7. Do not spray aerosols on or near the appliance.
8. If any material, such as plastic, melts on the surface of the glass, turn the appliance off and allow it cool. Do not remove the material when hot. A propriety non-abrasive ceramic hob cleaner such as 'hob brite' can be used to clean the glass.
9. When the appliance is not used for some time, ensure the gas control or adjacent isolator is turned off.
10. The appliance must not be used in rooms where the atmosphere is likely to contain water or chemical vapours, which may adversely affect the appliance or its finish.
11. Do not use whilst painting & decorating, or in newly decorated rooms as the paint residue can lead to unpleasant smells from the appliance. Always cover or have the appliance removed when decorating.
12. This appliance must be serviced annually.

## BEFORE USE

- 1 The first time that the appliance is used, there will be some odour produced due to the newness of the materials. It is recommended that the unit is fired at maximum setting for several (5) hours and the room is kept ventilated during this period. It is usual for flueless appliances to produce an initial odour after start up. (see section on smells)
- 2 When the pilot flame is alight, the unit may be controlled by turning the control knob. If the pilot flame should ever extinguish of its own accord, ventilate the room and allow a minimum of 5 minutes before relighting.
- 3 Never attempt to relight the unit if there is a strong smell of gas
- 4 If the unit continues to extinguish after a period of use, do not use it and seek the advice of your installer.
- 5 Make sure that your installer has filled out your extended guarantee card and shown you how the fire operates.

**Do not use the fire with broken logs.**

**Do not add any additional fuel elements to the fire.**

**Do not use similar looking parts from other appliances, use only genuine spare parts.**

**Do not use the appliance for burning waste.**

**The fire must not be run with the door open or with cracked incorrectly fitted or missing glass.**

## 16. Flue Gas Analysers – Installation & Servicing Facts

- Please read this sheet even if you have fitted our fires before.
- Please leave this sheet with the customer as reference for future servicing of the appliance.
- Please explain to the customer how the fire works and the details and facts listed on this sheet, particularly what the catalyst does and doesn't do.
- If you have any doubts about the test procedure please visit our website or call our technical help line

### Testing – Points to note...

- Before testing ensure that the room size is correct for the heat output of the fire. 30cu<sup>3</sup> for 2.5kw output, 40cu<sup>3</sup> for 3.5kw and 50cu<sup>3</sup> for 4.5kw.
- In all installations regardless of room size there must be an air vent positioned at least one metre from the fire at either high or low level through an outside wall providing 100cm<sup>2</sup> of free air. (For the Republic of Ireland 2 vents of not less than 60cm<sup>2</sup> must be provided at high and low level, with minimum vertical separation of 1.6m).
- The analyser used must be manufactured to BS7967 and the test must be carried out in accordance with BS5871 Pt 4
- The catalytic converter needs heat to work, therefore before you start testing; the fire must have been lit and burning on full for at least 15 mins.

There are two tests to carry out. A Co / CO<sup>2</sup> ratio test and a room centre CO test.

1. The first test is the CO / CO<sup>2</sup> ratio test and should be carried out at the fire exhaust vent, do not stick the probe of the analyser in through the grill but move the probe back and forth 1 inch in front of the outlet grill. (We use a piece of perforated 8mm pipe attached to the analyser with flexible rubber tube). You should record a ratio of no more than 0.002 % (20ppm CO to 1% Co<sup>2</sup>). It is advisable to have a high sample of CO as this will improve the test
2. The second test is the room centre CO test. You should stand in the room centre with the probe at waist height and read the level of CO; this should be no more than 9ppm over ambient peak. Please record these readings on the customers guarantee card.

Our Flueless fires also contain the following safety devices (an ODS (Oxygen Depletion Sensor) and FSD (Flame Supervision Device). Point out to the customer that unfortunately these are not found on all gas hobs; which are also flueless devices)

## 17. **Points to Note Regarding the Catalytic Convertor!**

- If the customer smokes tobacco products, lives on a busy road or is cooking with a gas oven/hob at the time of testing you must ensure that an ambient CO reading is taken before lighting the fire and attempting a reading.
- *Does the catalytic convertor need replacing?* The catalytic convertor does not need replacing unless it has become physically broken or the combustion test shows deterioration in performance over time. To constantly test the performance of the catalytic converter, our laboratory has been running appliances eight hours per day, five days per week, for up to seven years. Periodically we send catalytic converters back to the manufacturer for testing. After the equivalent of 30 years of use, the catalytic converter is as efficient as it was when brand new. Burley manages to achieve this by designing the fire to ensure that the catalytic converter is in exactly the right position for long life and maximum efficiency. (For other makes of fire please consult the relevant manufacturer). Only use replacement catalyst supplied by Burley.
- If you or the customer detects any odours from the fire please remember that the catalytic convertor is not an air filter and does not remove smells. The ceramics in the fire can absorb household smells and in turn these smells get emitted when the fire is lit, especially if the fire is used in an enclosed space for a period of time. If this is the case we recommend that the fire is run on maximum for at least 5 hours with the doors and windows open. This should be done at least twice a year, preferably in the spring and autumn or at any time they notice a smell.
- We do not advise the burning of wax candles within 1 metre of the fire. Wax particles can become airborne and deposit and solidify in the fire causing potential combustion problems.
- The catalyst can also be affected by airborne paint smells and vapours from some plug in air fresheners. The fire must be removed or sealed if you plan to decorate anywhere in the house. If you can detect smells from the fire carry out the burning off procedure as above.

**Further information regarding the catalytic convertor and Flueless fires in general can be found on our website [www.burley.co.uk](http://www.burley.co.uk)**

## 18. Gas rating of Burley Flueless Appliances

Burley's Flueless Gas Appliances are all gas input rated in the factory and undergo further line tests for combustion, sooting and visual performance. For Installers who wish to gas input rate appliances we need to establish tolerances for pass and fail.

### Manufacturers Tolerances

The Heat Input on appliances can be expressed as either a Nett or a Gross figure. When the installer is gas rating from the meter they will be using gross heat input which is 10% higher than Nett. This conversion has to be taken into account if the manufacturer has quoted a nett figure.

The manufacturer also has to account for production tolerances on pipes, injectors, valves etc and is allowed a further +/-5% tolerance on the maximum rate.

### Burn Down

Cold appliances generally allow a greater rate of gas to pass through them and once the appliance warms the gas density alters and causes the rate to reduce to the figure stated. This is known as Burn Down.

Manufacturers carrying out their technical tests allow appliances to be fully warm and 'burn down' before taking readings and this is typically after 1 hour. Some appliance manufacturers quote a 'cold' figure for the gas rate so that installers can measure this immediately.

### Installer Tolerances

It is important to take a gas rate test over a reasonable period of time so that the capacity of the meter is used. On low Input appliances such as our flueless this is even more critical because uncertainties can creep in. It is worth measuring over a 5 minute period to make sure.

It is also important to get your inlet pressure to 20mBar NG or 37mbar PR

In a gas appliance factory compensation is also made for variations in

- % Saturation of Gas
- Variation in Calorific Value
- Variation in Gas Density
- Gas Temperature
- Gas Pressure
- Atmospheric Pressure
- Meter Calibration
- Stopwatch Calibration.

In the home it is not possible to correct for these therefore an uncertainty factor needs to be built into all measurements.

Currently Gas Safe™ (formerly CORGI) does not quote a figure on this uncertainty but the measured gas rate could vary by +/-5%.

### Conclusion

In adding all the variables together,

- an appliance quoting Gross Heat Input could be anything from +/-10% of the quoted heat input
- an appliance quoting Nett Heat Input could be anything from 0% to +20% of the quoted figure when measured as a Gross figure.
- If the appliance is cold anything up to a further 10% error could be expected and we don't quote these figures because they change rapidly. The figures shown below are hot figures.

Model	Heat Input Quoted	Minimum (Gross)	Maximum (Gross)	Cu Ft Per Hour	Cu Mt Per Hour
Environ, Esteem	2.5kW Nett	2.5kW Gross	3.0kW Gross	8.49	0.2404
Ambience 4121	3.5kW Nett	3.5kW Gross	4.2kW Gross	11.67	0.3304
Acumen / Elan 4111	4.2kW Nett	4.2kW Gross	5.4kW Gross	14.85	0.4205



## **19. Burley Appliances Ltd - Domestic Guarantee Conditions**

We pride ourselves on the quality of service we deliver to our customers and all Burley Appliances' products carry a fully inclusive 12-month parts and labour guarantee. This guarantee is extended by another 12 months free of charge when it is serviced by Gas Safe™ registered installer (formerly CORGI) at the end of the first year. What the guarantee cannot cover is problems caused by incorrect installation or servicing, or any work carried out by non-Gas Safe™ registered installer (formerly CORGI).

We undertake that if within 12 months of the date of purchase, your fire or any part thereof is proved to be defective by reason of faulty workmanship or materials, we will at our discretion repair or replace the same free of any charge for labour, materials or carriage subject to condition that:

- All gas appliances are installed to the latest Gas Installation regulations by a qualified Gas Safe™ registered installer (formerly CORGI) and connected to the correct gas type and pressure as stated on the rating plate attached to the equipment.
- The fire is fitted in a room with the following minimum dimensions 2.5Kw = 30m<sup>3</sup> / 3.5Kw = 40m<sup>3</sup> / 4.2Kw = 50m<sup>3</sup>
- A wall vent is installed not less than 1 meter away from the fire allowing 100cm<sup>2</sup> of free air.
- You have the fire serviced by **Gas Safe™** registered installer (formerly CORGI) within the first year (as with all gas products, every gas appliances must be serviced every year).
- The appliance has not been subject to misuse, accident, or repaired or fitted by anyone other than Gas Safe™ registered installer (formerly CORGI) or our own engineer.
- The appliance has been used solely for domestic purposes and is on domestic premises i.e. not for commercial or trade use.
- The appliance has been used solely in accordance with the instruction book.

Any in guarantee work carried out by Burley Appliances will be charged for if the fault is caused by incorrect pressure or gas, incorrect installation, operator error, neglect or abuse.

**All guarantee cover is instantly and permanently cancelled if a non-Gas Safe™ registered installer (formerly CORGI) carries out any installation or servicing.**

### **Exclusions**

This guarantee **does not** cover:

- Damage resulting from external transportation, improper use or neglect, the replacement of any light bulbs or removable parts of glass or plastic.
- Costs incurred for calls to put right an appliance, which is improperly installed.
- Appliances that are the subject of rental agreements.
- EC Countries - the standard guarantee is applicable but is subject to the owner's responsibility and cost, to ensure the appliance meets the standards set by the country to which the product is taken.

**Any appliance or defective part replaced shall become the Company's property**

**Service Calls are made between 09.30 am and 04.30 pm Monday - Friday.**

**This guarantee is in addition to your statutory and other legal rights.**

**Proof of purchase will be required as will be a copy of the Gas Safe™ registered installer (formerly CORGI) notice.**

## Disposal



### **Recycling Information:**

The metallic & glass parts of the appliance & its packaging should be sorted for environmental-friendly recycling.



**WEEE:** Dispose of electrical equipment in an environmentally correct manner.



When disposing components containing Refractory Ceramic Fibres (RCF), we recommend that the items are not broken up, but are sealed within heavy duty polythene bags, and clearly labelled as RCF waste. RCF waste may be disposed of in suitably licensed landfill sites.





Burley Magiglo fires are protected by  
UK patents 2193802, 2240620 and 2256920  
Other Patents Pending



Burley Appliances Ltd, Lands' End Way,  
Oakham, Rutland, LE15 6RB

Tel: 01572 725570 Fax: 01572 724390  
[www.burley.co.uk](http://www.burley.co.uk) Email: [info@burley.co.uk](mailto:info@burley.co.uk)