

The background features a collage of images related to school dining spaces. The top left shows a wide view of a school cafeteria with several long wooden tables and benches. The bottom right shows a close-up of two young men sitting at a table, smiling and talking. On the table in front of them are some snacks, including a banana and a green apple. The entire image is overlaid with large, semi-transparent green geometric shapes, primarily triangles and diamonds, creating a modern, dynamic feel.

VERSÖ:

OPTIMISED DINING SPACES



WESTCOUNTRY
GROUP

Wall Pocket



04

Benchmark



08

Espresso



12

Hallmark



14

ConverTables

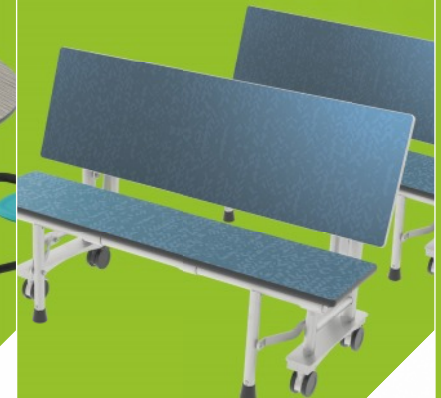

18

Colours

Rio Red

Bright Red

Burgundy

Navy Blue

20

Maintenance & warranty

22

WELCOME TO VERSA

THE HOME OF VERSATILE, FLEXIBLE AND SPACE-EFFICIENT FURNITURE FOR MULTI-USE ENVIRONMENTS.

Whether you're looking to **solve space problems** to increase capacity, or you have furniture storage issues, we have the ideal solution for you.

The Versa range of **mobile folding tables** is perfect for primary and secondary schools, colleges and universities, and any other environments where space is at a premium. In short, we help to create the most **optimised space** to suit your own particular requirements.

We at Westcountry Group understand the needs of schools and colleges and know that the right environment is crucial for delivering an **effective and compelling dining and learning experience**. Our versatile fixed and mobile tables help to maximise space and deliver flexibility without the need for expensive construction or bulky unmanageable furniture.

We offer a full space-planning and design service and can even **customise** the tables with graphics to match your school or college branding. Let us take your vision through from concept to completion.



Wall Pocket

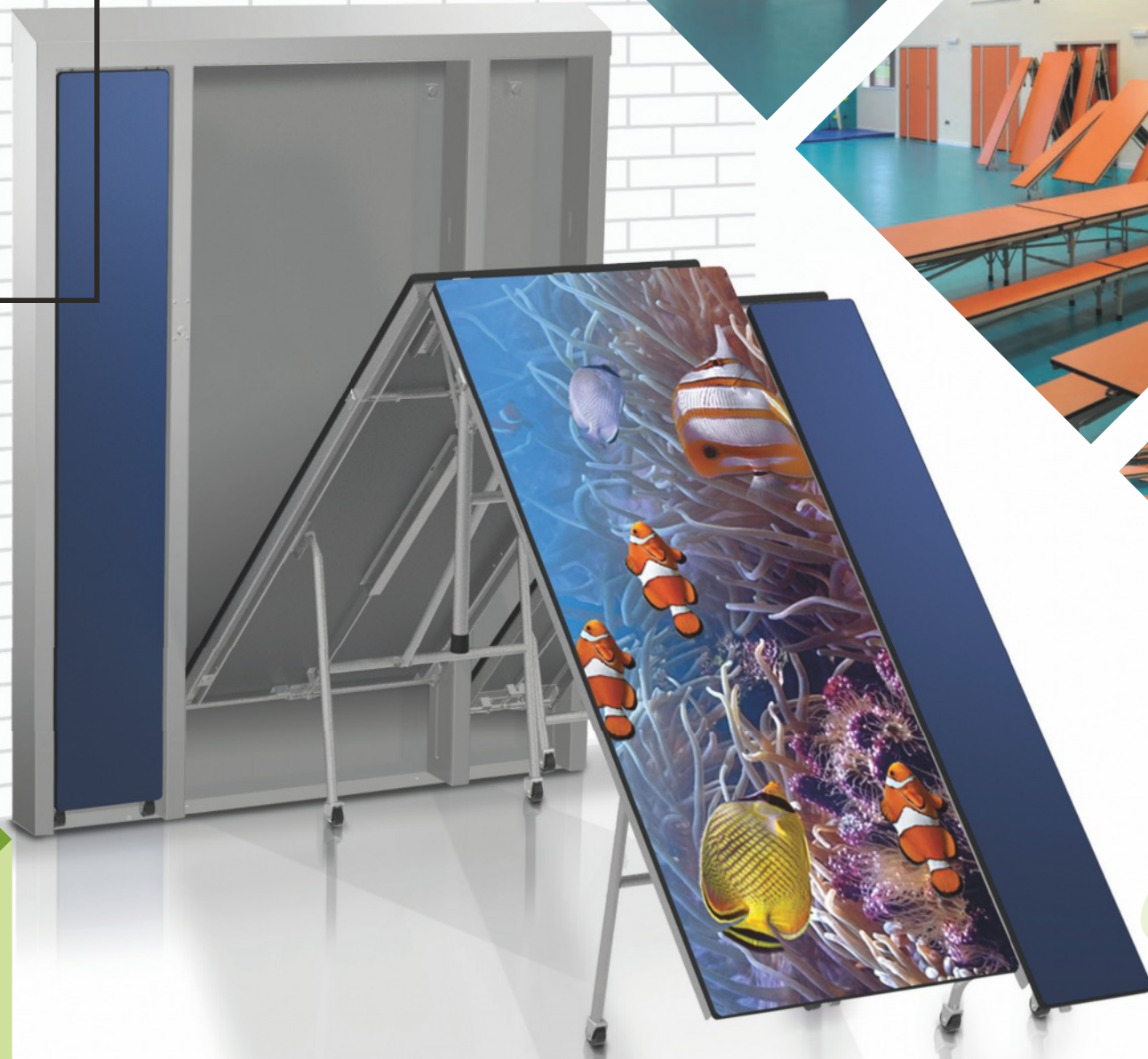

OUR LEGENDARY SPACE SAVER

The world's most space-efficient dining table system

It takes just 8 minutes for one person to set out our Wall Pockets for lunch, that's seating for 240 pupils

THE WALL POCKET SYSTEM IS THE PERFECT ANSWER FOR DINING IN MULTI-USE HALLS. WHEN THE TABLES ARE STORED, YOU HAVE A USEFUL MULTIPURPOSE ROOM, BUT WHEN NEEDED, THEY CAN BE UNLATCHED FROM THE WALL POCKET AND EASILY SET UP FOR USE IN SECONDS.

Such flexibility is invaluable for facilities where floor space and storage are at a premium. Think of the Wall Pocket as the chance to add an extra room to your school. It's like an extension without the need for planning permission! The store room that has always held your dining tables is now empty to be used for PE equipment or a new learning space. Best of all, you can fit more students in without cluttering up your hall with extra furniture.

The Wall Pocket is available as either a recessed version that sits flush with the hall wall or a surface-mounted version that is quickly fixed to an existing wall. The tables can also be customised with images or logos of your choice to add art to your hall and the whole dining experience.

FEATURES & BENEFITS

Multi-use Flexibility - Wall Pocket's ease of use enables your hall to be used for other activities for longer every day.

More Dining Space - the dining capacity of your hall is increased whilst using less space and Wall Pocket frees up the existing table storage facility for other uses.

Quick Set-Up - Canteen staff love Wall Pocket - it cuts room set-up time and saves effort on heavy manual handling.

Quieter and Safer Environment - Wall Pocket removes the noise and safety risks associated with loose chairs, improving the safety in your dining hall. Supervision and monitoring is easier too.

Versatile Configurations - Wall Pocket allows your hall to be easily reconfigured as a lecture theatre and learning zone in a matter of minutes.

Tables and benches can be removed individually from their pocket; use as many or as few as you want.

Cost Effective - Initial building project costs are reduced – there's no need to allow for table storage space.



SAFE OPERATION

Tables and benches both feature the Lift Assist System for safe, controlled handling.

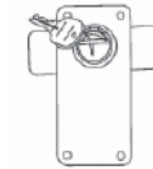

LIMITED ACCESS

New mulion lock secures tables/benches in stored position preventing unauthorised use.

- Surface mounted and wall-recessed options available
- Ultra-durable and hygienic table and bench surfaces
- Tamper-proof and moisture resistant polyurea edging ensures longevity

- Available in a wide range of frame and table/bench colours – see availability chart on p20
- Custom-print the tables for your own piece of wall art – image or logo of your choice

- 15-year manufacturer's warranty
- Shorter 3.6mtr Wall Pocket system also available, please enquire

POCKET DEPTH

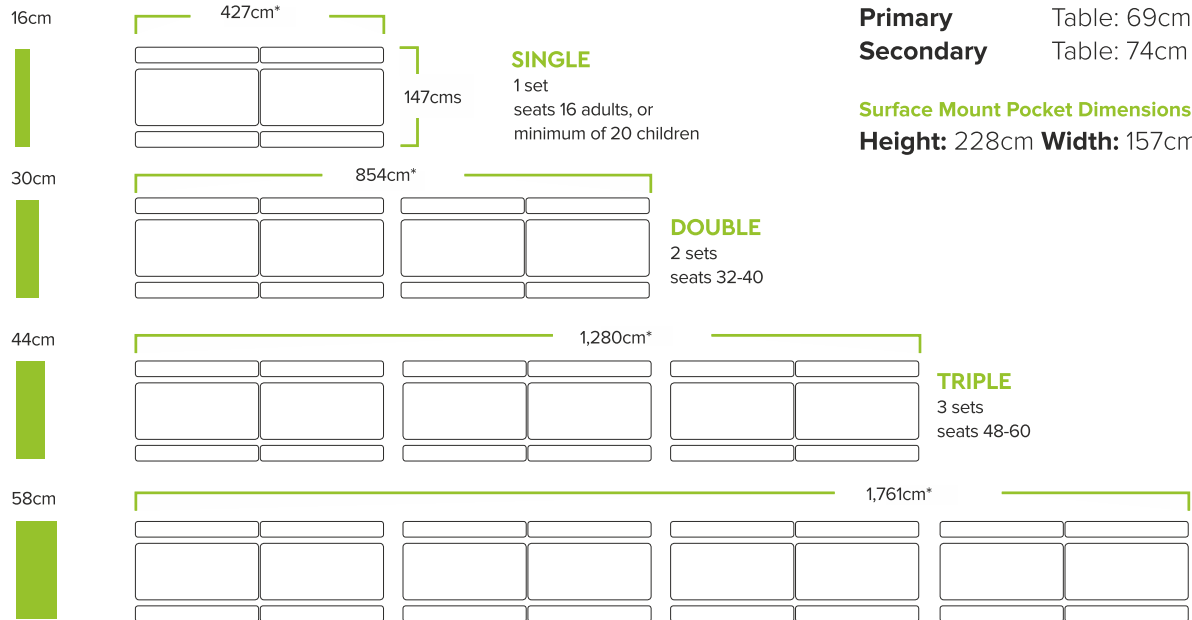

Table & Bench Height Options

Primary	Table: 69cm (27")	Bench: 38cm (15")
Secondary	Table: 74cm (29")	Bench: 43cm (17")

Surface Mount Pocket Dimensions

Height: 228cm Width: 157cm

SEE PAGE 06
to read how Wall Pocket can transform a sports hall to a dining hall

*Excluding gaps between tables. All dimensions given are approximate.

Wall Pocket PROJECTS

NEW COMBINED SPORTS AND DINING HALL - AYLESBURY, BUCKS

This project was a prime candidate for Versa's Wall Pocket dining tables. During the school day the area needs to transform from sports hall to dining hall and back again with the minimum amount of time and effort. We installed six recessed Wall Pockets each containing two tables and four benches which give a maximum dining capacity of 240 students. The flush-fitting pockets make for a neat straight wall that is ideal for an active sports environment.

“We're very pleased with this installation of Wall Pocket dining tables. They enable the sports hall to be ready as a dining hall in less than ten minutes which is good for everyone. The tables store compactly in their pockets and are robust and easy to use.”

Project Manager



INCREASED PUPIL NUMBERS

– PLYMOUTH, DEVON

How do you fit more people into the same space? A new intake of pupils meant this school had to provide more dining capacity, and quickly. Versa's Wall Pockets proved the ideal solution giving instant extra capacity and saving canteen staff time and effort. An added benefit was the freeing-up of the existing table storage cupboard which was quickly put to use as a PE store.

“The Wall Pocket and Benchmark tables have been a big asset for us. They've increased the percentage of time that we can use the hall for other activities during the day as we don't have to spend time setting up for lunch. The other big plus is that no staff are having to carry or set up heavy tables, which has increased staff morale and reduced the risk of injury, which had been an issue in the past.”

Head Teacher



Benchmark

SEATS
UP TO
20

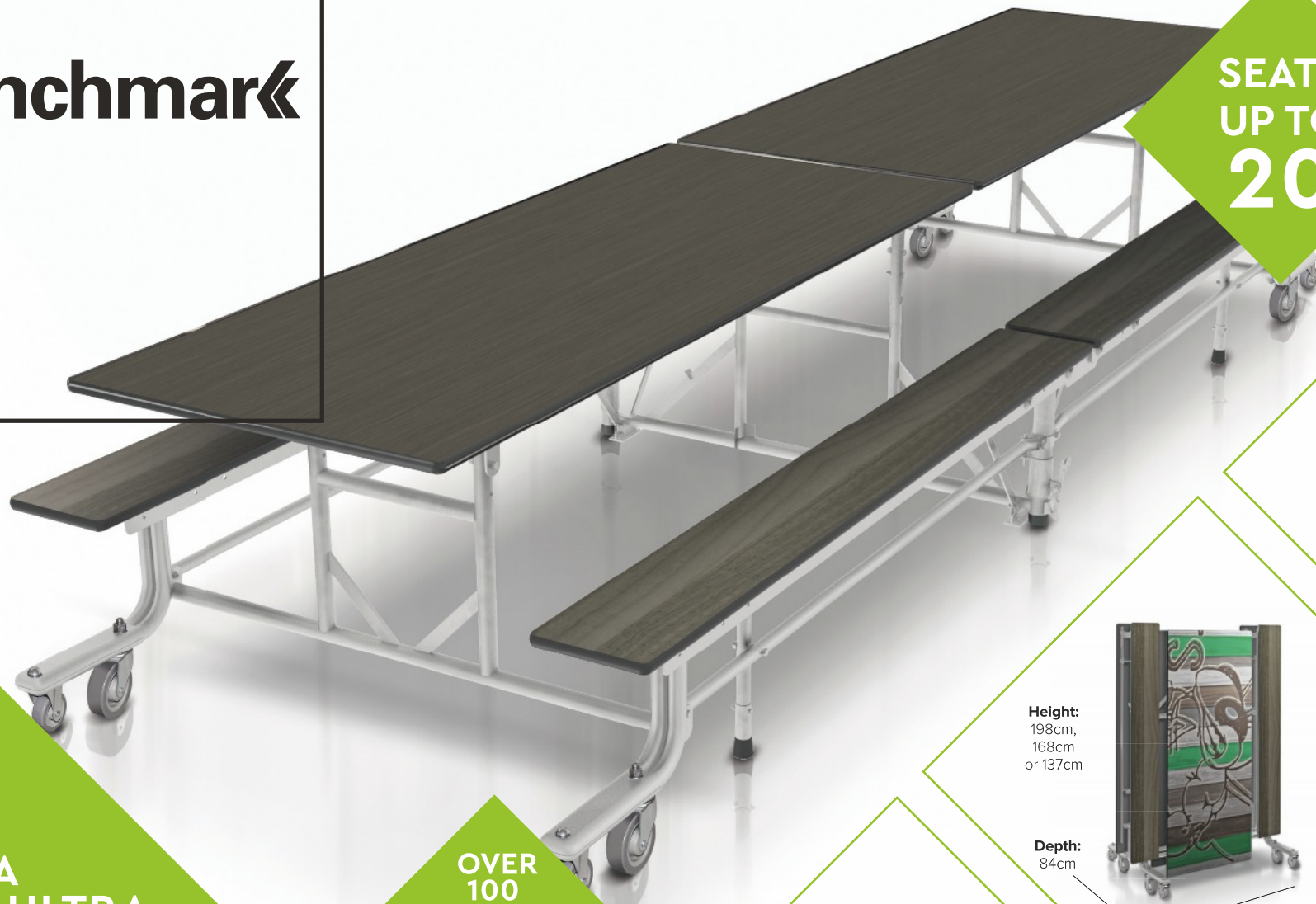

6 tables nest together in a stack just 229 x 150cm

Height:
198cm,
168cm
or 137cm

Depth:
84cm



Width:
132cm

**OVER
100
STANDARD
COLOUR OPTIONS**

mix and match
table-top and
bench colours



**ULTRA
SLIM, ULTRA
COMPACT**

Stores in 44% less space
than standard folding
dining tables

THE BENCHMARK TABLE IS QUITE SIMPLY THE MOST SPACE-EFFICIENT MOBILE TABLE IN THE WORLD.

The ultra slim and ultra compact design offers adjustable table heights - a Versa exclusive - accommodating your everyday cafeteria needs for primary schools, secondary schools and colleges.

The Benchmark is an industry leader in compact storage - six tables require less than a 5ft x 8ft footprint, whilst each additional table adds just 11-inches to the nested depth. With the Benchmark, space optimisation comes as standard.

The extended tabletops offer extra room per student and end-to-end positioning with no gaps between tabletops. When you experience Benchmark for the first time, you too will understand why it's the world's most space efficient table.

To discover how Benchmark could transform your school dining room or for a no-obligation quote call us today on

0330 030 0330

FEATURES & BENEFITS

Compact Storage - six Benchmark tables require a footprint of less than 1.5m x 2.4m (5ft x 8ft) with each additional table adding just 28cm (11in).

Increased Dining Capacity - you'll fit more Benchmark tables in your storage area - that means more capacity in your hall without taking up more room.

Easy Action - Lift Assist System provides smooth, controlled operation - the easiest lifting tables in the UK.

- Ultra-durable and hygienic table and bench surfaces
- Practical - Three different table lengths to choose from and each table extends beyond the bench for comfort on the end seat

Safer Dining - stable in both the down and upright positions, thanks to locking latches, anti-glide legs and DoubleGuard anti-tipping feet.

Customisable - each table can be customised with a graphic of your choice. Break free from the ordinary cafeteria look and display your school's personality!

- Tamper-proof and moisture-resistant polyurea edging ensures longevity
- Available in a wide range of frame and table/bench colours
- 15-year manufacturer's warranty

ANTI-GLIDE LEGS

Patented legs prevent table movement and protect the floor

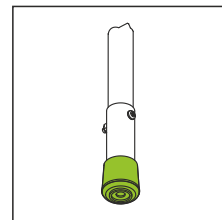

COMPACT STORAGE

Benchmark takes up 44% less storage space than other table brands

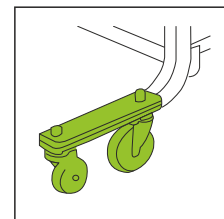
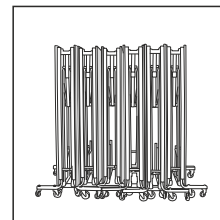

DOUBLEGUARD®

prevents tip-over when tables are upright - stays flush with table when lowered

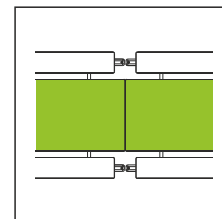

EXTENDED TABLETOPS

Provide extra room per student and end-to-end positioning

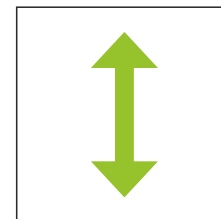

HEIGHT

Industry exclusive! Table top can be height adjusted to either 69cm or 74cm



MODELS

Model Number	Seating Capacity Children/Adults	Seat Height	Table Height	Approx. Storage Height
V19F273008	12/8	43cm	69cm	137cm
V19F293008	12/8	43cm	74cm	137cm

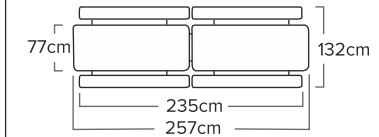

Model Number	Seating Capacity Children/Adults	Seat Height	Table Height	Approx. Storage Height
V19F273010	14/10	43cm	69cm	168cm
V19F293010	14/10	43cm	74cm	168cm

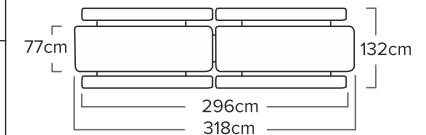

Model Number	Seating Capacity Children/Adults	Seat Height	Table Height	Approx. Storage Height
V19F273012	16-20/12	43cm	69cm	198cm
V19F293012	16-20/12	43cm	74cm	198cm

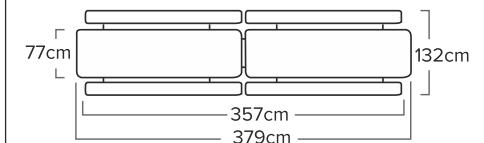

“We love our Benchmarks; at last we can get all of our dining furniture into our store”

Benchmark PROJECTS

INCREASED SPACE AND CAPACITY

– SALTASH, CORNWALL

Like many schools, the staff at St Stephens struggled with space and storage issues in their multi-use hall, meaning they were having problems storing all their dining furniture with their increased pupil numbers. Versa's Benchmark tables proved to be the perfect solution, meaning the school can now store their furniture in half the storage space of other folding dining tables!

“We're delighted with our Benchmark tables. Beforehand we could only seat about 70 students, but with these tables we can seat another third again. We're absolutely delighted with how they work, easy to pull out, easy to put down and easy to clean!”

Caretaker



A MORE REFINED DINING EXPERIENCE

– PENAIR, CORNWALL

How do you create a socially-inclusive dining environment that's practical, easy to look after and efficient on storage space? Thankfully Versa's innovative Benchmark tables solved this question and provided a flexible, practical yet aesthetically pleasing solution for the staff and students at Penair School. The Benchmark tables can be stored at the side of the hall to make way for other activities during the day and unfold quickly and easily when it comes to lunchtime.

“The kids really love the Benchmark tables - they sit together better than they did before. The staff like them because they're easy to clean and they're easy to put away at the end of lunch. The dining hall works so much better, it works a lot easier for us and everyone's happy with it.”

Head of Catering

Espresso



MOBILE CAFETERIA TABLES

Stylish, durable and
lightweight - adding a
touch of café culture
to your school

STYLISH, DURABLE AND LIGHTWEIGHT – OUR ESPRESSO MOBILE CAFETERIA TABLES ADD MORE THAN A TOUCH OF CAFE CULTURE TO YOUR CAMPUS DINING AREA.

Until now the only way to enjoy round ‘café style’ tables in a multi-use hall was to buy cheap, flimsy tables which were decidedly lacking in aesthetics! Turning these tables over to fold them up every day is both difficult and unwieldy, taking time and resulting in potential health implications. That’s all changed with the arrival of Espresso.

You want portability and versatility? Espresso will allow you to quickly change your school hall’s identity. From indoor tennis court to food court in about the time it takes a barista to make a fresh cup of Italian coffee!

The Espresso cart holds up to 20 tabletops, 20 bases and 40 columns which can be set up in your hall in no time at all. And when you’re done, they can be effortlessly stored away on the compact cart taking up just 82 x 144cm of space.

To find out more about the Espresso tables call us today on **0330 030 0330**

FEATURES & BENEFITS

Lightweight - Espresso tabletops are effortless to lift and manoeuvre - up to 50% lighter than standard tabletops.

Portable - Espresso tables can be easily moved from location to location; each cart holds up to 20 tables and can be wheeled wherever you want.

Requires no tools - each Espresso component simply twists and locks into place.

Versatile - two column heights are available which means you can quickly change from café to poseur-height and back in no time at all.

SmartEdge - ultra-durable urethane edging provides a perfectly sealed seamless surface with antibacterial and antifungal properties.

Customisable - each table can be customised with a graphic of your choice. Break free from the ordinary cafeteria look and display your school’s personality!

- Super-tough durable and hygienic table surface
- Three different diameters to suit every need

- Available in a wide range of base colours, standard and custom table finishes and edging colours

MODELS

	Diameter
VESPD24RD	61cm
VESPD30RD	76cm
VESPD36RD	92cm

	Diameter
VESPD24RDP	61cm
VESPD30RDP	76cm
VESPD36RDP	92cm

- **Lightweight tabletop**
- **Uv resistant**
- **No tools required**
- **Seamless smartedge (antibacterial/antifungal)**
- **Tough and durable**
- **Locking heavy-duty castors**
- **Up to 20 tabletops and bases on one cart**
- **Multiple column heights available**
- **Choice of base design**



Ask about our range of Espresso-compatible chairs – they store neatly on their own trolley for maximum space efficiency and ease of use.

Hallmark

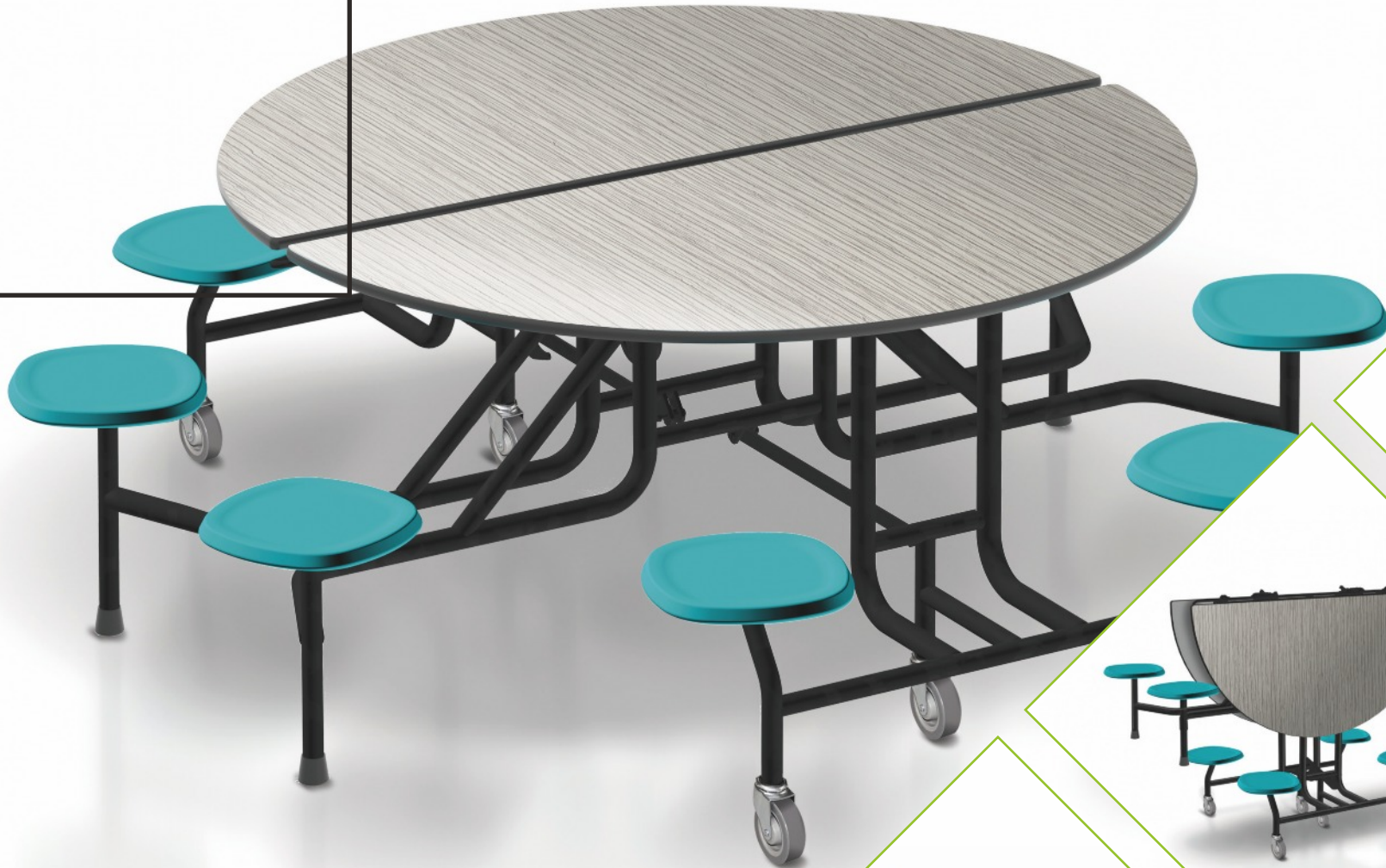

CUSTOM
GRAPHICS
AVAILABLE



HALLMARK TABLES ARE THE ULTIMATE IN FLEXIBILITY FOR SPACE-EFFICIENT DINING.

Choose from square, rectangular, round, octagonal or elliptical tables for a varied and stimulating dining environment that's durable but fun.

With options of stools and/or mini-benches or wheelchair-accessible models, two height options and hundreds of frame/table/stool finishes, school dining need never be the same again. And if you're feeling really creative, you can customise your tables with your own images or logo!

Hallmark tables fold up neatly and securely, assisted by a durable dual-spring mechanism and manoeuvre easily on large wheels for effortless set-up and put-away. They're ideal for every educational establishment from primary and secondary through to colleges and universities.

To find out more about the Hallmark range of mobile tables call us today on

0330 030 0330

FEATURES & BENEFITS

Flexibility - mix and match from the huge range of options for the best use of your dining space. Options on table shape, height and colour, seat configuration and colour, and frame finish.

Easy Action - dual-spring mechanism and easy-glide castors make Hallmark tables the easiest lifting and moving cafeteria tables.

Safer Dining - stable in both down and upright positions, thanks to dual locking latches and anti-glide legs. Stools are mounted on steel plates (not upright poles) for maximum safety and durability.

Wheelchair-accessible - choice of tables with combination of access for wheelchair users and standard seating.

Customisable - each table can be customised with a graphic of your choice; break free from the ordinary cafeteria look and display your school's personality!

- Ultra-durable and hygienic table and bench surfaces
- Practical - two different table heights to choose from and dozens of size, shape and seating configurations
- Tamper-proof and moisture resistant polyurea edging ensures longevity and hygiene
- Available in a wide range of frame and table/bench/stool colours – see availability chart on p20
- 15-year manufacturer's warranty

ANTI-GLIDE LEGS

Patented legs prevent table movement and protect the floor

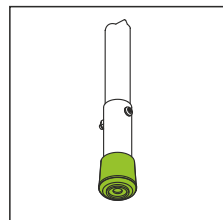

SAFE OPERATION

Tables and benches both feature the Lift Assist System for safe, controlled handling.

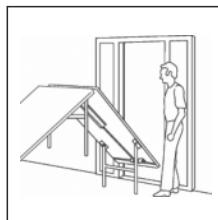

SECURE STOOL PLATES ACCESSIBLE

Heavy gauge steel plates secure stools at four points. No more broken stools!

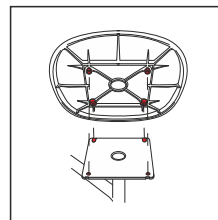

Wheelchair accessible DDA-compliant models available

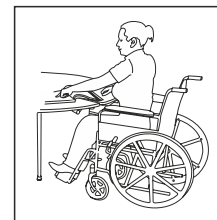

For Hallmark table and seat configurations see overleaf...

See stool, table and frame colour options on page 20

Hallmark

MODEL NUMBER	SEATS	TABLE & SEAT HEIGHT
V59T2760RD-S8	8	69/38cm
V59T2960RD-S8	8	74/43cm

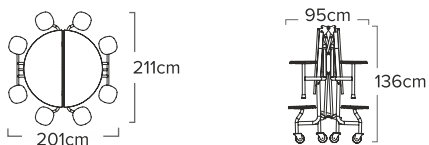

MODEL NUMBER	SEATS	TABLE & SEAT HEIGHT
V59T2760OC-S8	8	69/38cm
V59T2960OC-S8	8	74/43cm

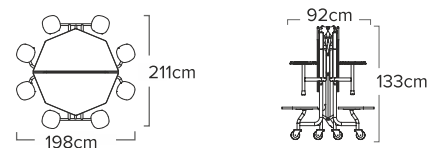

Model Number	Seats	Table & Seat Height

MODEL NUMBER	SEATS	TABLE & SEAT HEIGHT
V59T2760RDB2S4	8	69/38cm
V59T2960RDB2S4	8	74/43cm

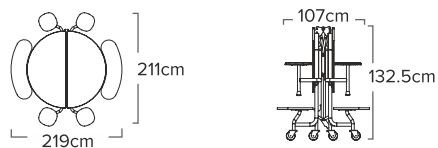

MODEL NUMBER	SEATS	TABLE & SEAT HEIGHT
V59T275263-B2S4	8	69/38cm
V59T295263-B2S4	8	74/43cm

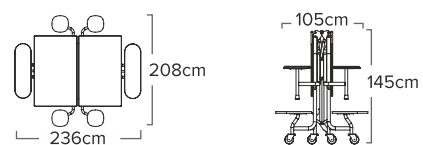

MODEL NUMBER	SEATS	TABLE & SEAT HEIGHT
V59T3260RDB2S2*WC	6 + 2WC	81/51cm

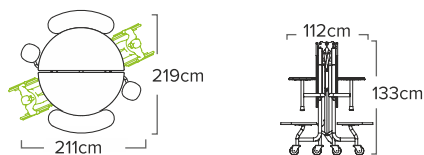

MODEL NUMBER	SEATS	TABLE & SEAT HEIGHT
V59T2760RD-B4	8	69/38cm
V59T2960RD-B4	8	74/43cm

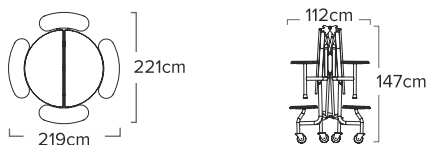

MODEL NUMBER	SEATS	TABLE & SEAT HEIGHT
V59T275263-S8	8	69/38cm
V59T295263-S8	8	74/43cm

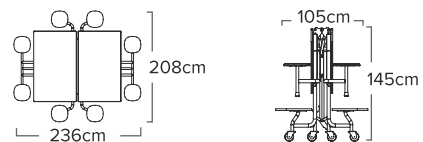

MODEL NUMBER	SEATS	TABLE & SEAT HEIGHT
V59T3260RD-S6*WC	6 + 2WC	81/51cm

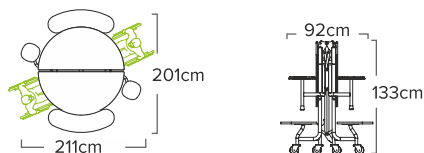

All dimensions given are approximate.

MODEL NUMBER	SEATS	TABLE & SEAT HEIGHT
V59T2760EL-S8	8	69/38cm
V59T2760EL-B2S4	8	69/38cm

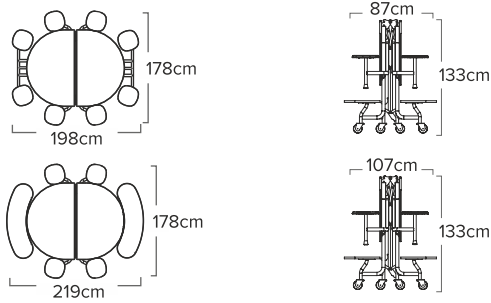

MODEL NUMBER	SEATS	TABLE & SEAT HEIGHT
V59T27120ELS12	12	69/38cm
V59T29120ELS12	12	74/43cm
V59T29120ELS10*WC	10 + WC	74/43cm

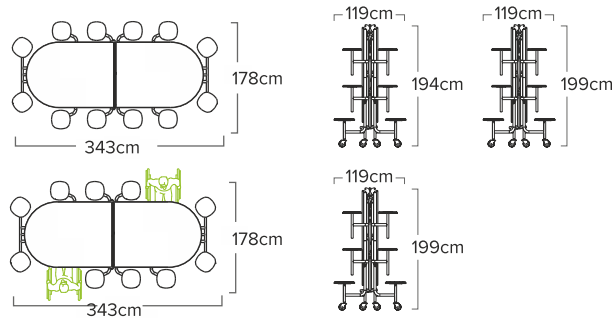

MODEL NUMBER	SEATS	TABLE & SEAT HEIGHT
V60T273008-S08	8	69/38cm
V60T293008-S08	8	74/43cm

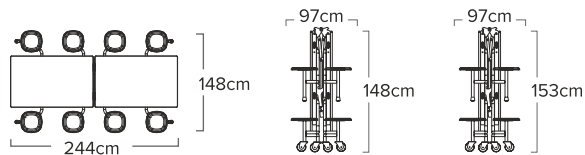

MODEL NUMBER	SEATS	TABLE & SEAT HEIGHT
V60T253010-S12	12	64/38cm
V60T273010-S12	12	69/38cm
V60T293010-S12	12	74/43cm

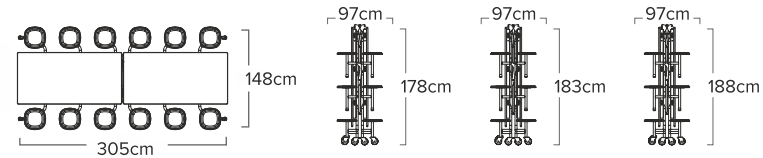

MODEL NUMBER	SEATS	TABLE & SEAT HEIGHT
V60T273012-S12	12	69/38cm
V60T293012-S12	12	74/43cm
V60T303012-S08*WC	8 + 2WC	76/46cm

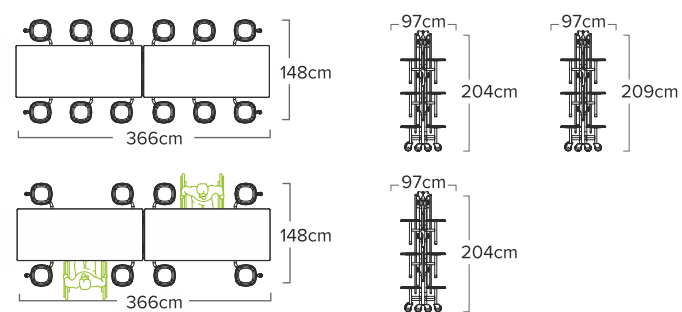

MODEL NUMBER	SEATS	TABLE & SEAT HEIGHT
V60T253012-S16	16	64/38cm
V60T273012-S16	16	69/38cm
V60T293012-S16	16	74/43cm

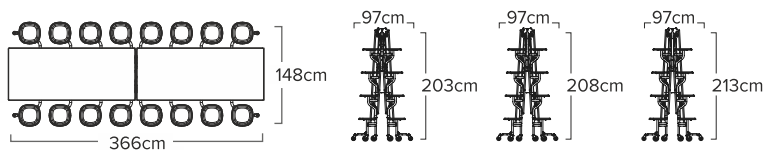

All dimensions given are approximate.

ConverTables

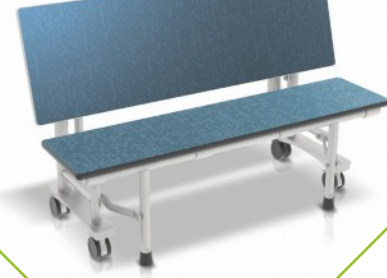
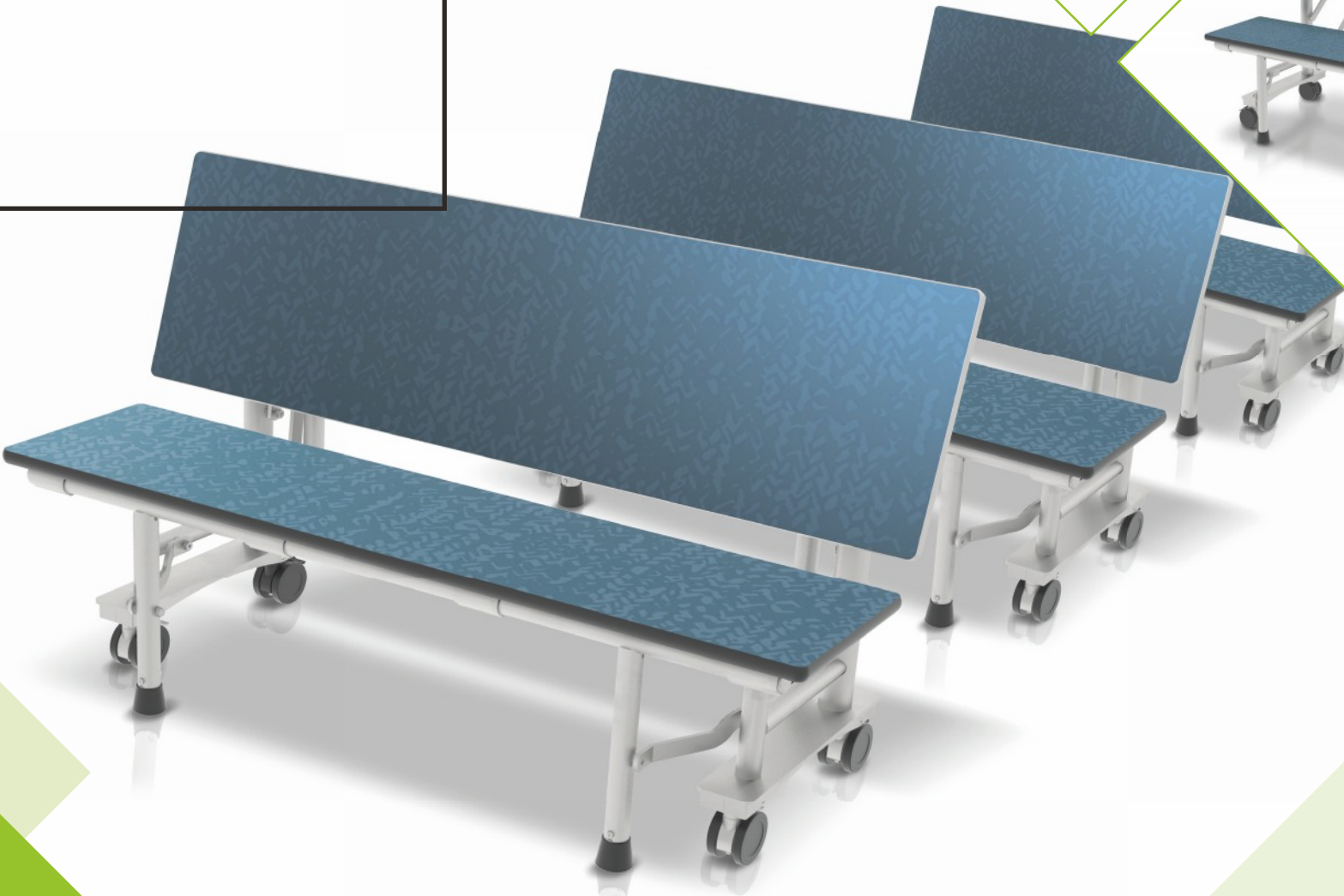

CONVERTABLES ARE THE MOST VERSATILE SCHOOL TABLES; THE ULTIMATE 'DO ANYTHING' TABLE.

Whether you want your hall to be a dining hall, a lecture room, or an auditorium, ConverTables can do it all.

These mobile tables easily transform from a single-sided lecture table, to a useful bench to a full-sized cafeteria table with little effort, in just a few moments. They move quietly on easy-glide castors and nest neatly for easy storage in a minimum of space. Their robust design ensures they'll stand up to the rigours of education use and the 15-year warranty gives complete peace of mind.

To find out more about the ConverTables range of mobile tables call us today on

0330 030 0330

FEATURES & BENEFITS

Versatile - transform from a single-sided table to a useful bench table to a full-size cafeteria table.

Cost-effective - one table does three jobs and takes up a minimum of storage space.

Safe and Stable - eight points of floor contact including four seat-support legs.

Lightweight - non-marking castor wheels are quiet and ensure the tables move with minimal effort.

Secure - the safety latch is discreetly located under the tabletop - out of the sight of students.

Customisable - ConverTables can be customised with a graphic of your choice; liven up your hall and give your table an identity!

- Ultra-durable and hygienic table and bench surfaces
- Practical - three different table heights and an extended version to suit all ages; four length options for the best use of your space

- Tamper-proof and moisture-resistant polyurea edging ensures longevity
- Available in a wide range of frame and table/bench colours – see availability chart on p18
- 15-year manufacturer's warranty

COMPACT STORAGE

Three tables store in just 2.6 x 1.2m of space with each additional table adding only 21cm in depth

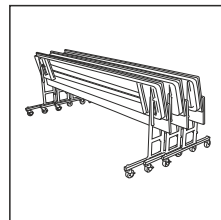

CAFETERIA SEATING

Two tables placed back-to-back become a traditional cafeteria -sized table

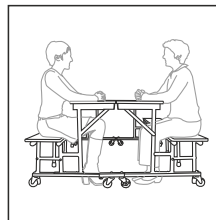

CLASSROOM SEATING

Reconfigure tables in rows for lectures, study or testing

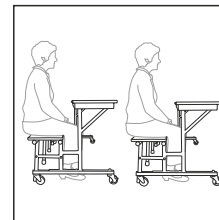

AUDITORIUM SEATING

Arranged in rows, these units convert any room into a useful auditorium

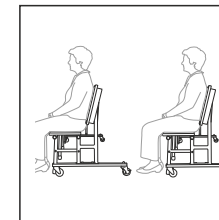

MODELS

Model Number	Seating Capacity Children/Adults	Table & Bench Height
V32M251504	3/2	64cm/38cm
V32M271504	3/2	69cm/38cm
V32M291504	3/2	74cm/43cm

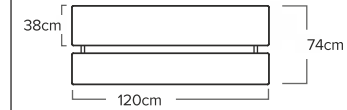

Model Number	Seating Capacity Children/Adults	Table & Bench Height
V32M251506	4/3	64cm/38cm
V32M271506	4/3	69cm/38cm
V32M291506	4/3	74cm/43cm

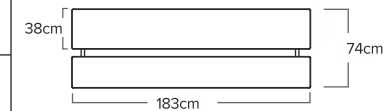

Model Number	Seating Capacity Children/Adults	Table & Bench Height
V32M251508	6/4	64cm/38cm
V32M271508	6/4	69cm/38cm
V32M291508	6/4	74cm/43cm

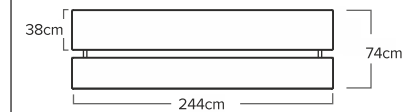

COLOUR OPTIONS

STOOLS

Versa's durable table stools come in a wide range of colours as standard:

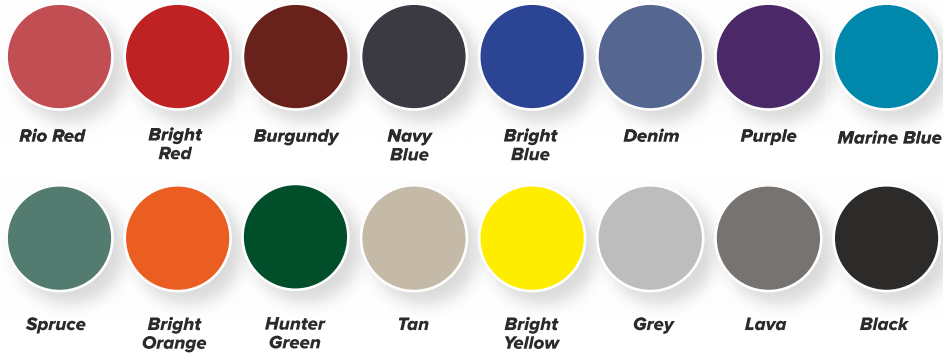

FRAMES

Choose the colour of your table frames; we offer three standard finishes.



TABLES, BENCHES & MINI-BENCHES

Versa tables are manufactured as standard using Wilsonart laminates – one of the largest ranges available today. Other laminate options are available including Formica, Polyrey and Duropal.

Our most popular laminate colours are as follows:

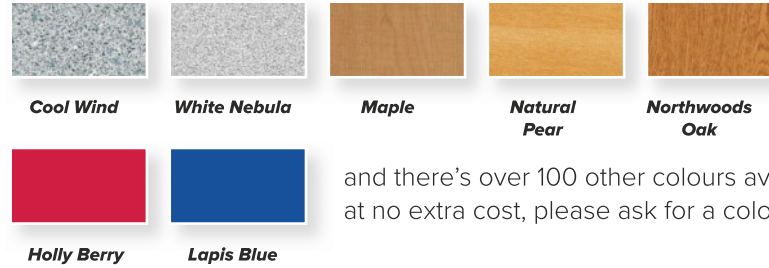

and there's over 100 other colours available at no extra cost, please ask for a colour chart.

Other laminate colours available include:



Colours shown are indicative only

CUSTOMISED TABLES/BENCHES

Why not add your establishment's logo or any other image to your dining tables? It brings life to your dining hall or cafeteria, promotes interest and pride, and is proven to be more popular with students.

Your design is incorporated into the laminate so is extremely durable and will easily withstand the rigours of school life. Simply send Versa your logo or image and we'll create a sample layout design for your approval – no set-up charge and no minimum order quantity.



MAINTENANCE & WARRANTY

All Versa tables are covered by a full manufacturer's warranty. Tables are guaranteed to be free from defects in original material and workmanship for the number of years specified.

Keep your tables and Wall Pockets in full working order with our annual maintenance plan. We'll visit you and carry out essential safety checks and thorough inspections to give complete peace of mind.

Our technicians will lubricate all moving parts, make any necessary adjustments and check complete functionality to make sure you get the full use and life from your tables.

We'll tailor a maintenance plan to suit your particular installation; speak to us today for more information.





**READY TO
TRANSFORM YOUR
ENVIRONMENT?**

Give us a call on
0330 030 0330
to get started!



VERSÖ.

OPTIMISED DINING SPACES

Head Office
Cranmere House
Darklake View
Plymouth
PL6 7TW

South East Office
Warne House
Central Way
Walworth Industrial Estate
Andover
SP10 5AN

T: 0330 030 0330
E: ideas@versadesign.co.uk
W: www.versadesign.co.uk

Part of  WESTCOUNTRY
GROUP