

# MONDEL BRAKE PRODUCTS

General Purpose Industrial Brakes

AIST Mill Duty Brakes

Heavy-Duty Disc Brakes

Special Application & Custom Engineered Brakes

Brake Accessories

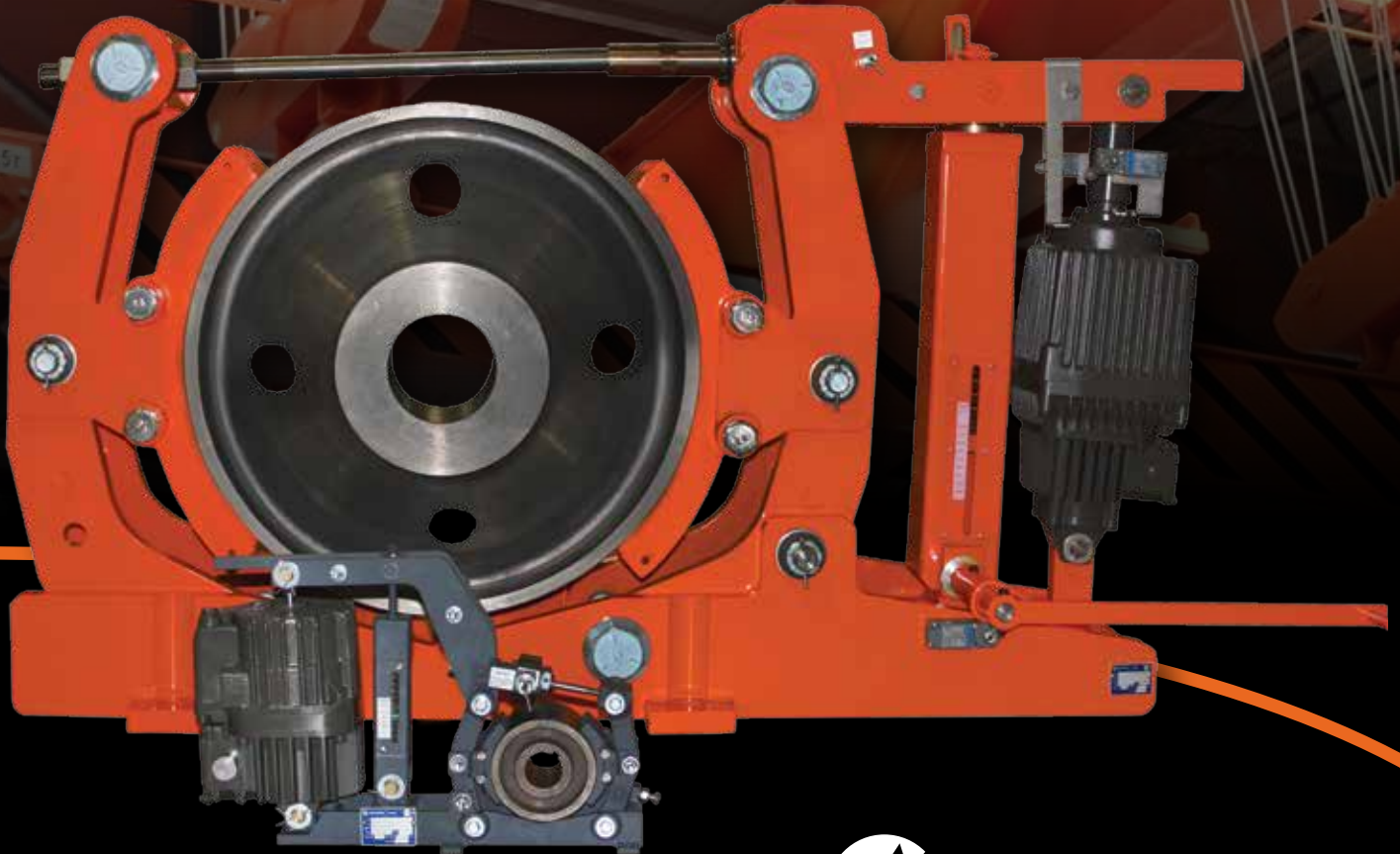

**MAGNETEK**  
MATERIAL HANDLING



# 200S GENERAL PURPOSE INDUSTRIAL BRAKES

Magnetek's heavy-duty, cost-effective Mondel Industrial Duty/General Purpose Shoe Brakes are designed for a wide variety of industrial applications. A minimum of moving parts provides an extremely reliable range of brakes that are easy to install, adjust and maintain. The 200S Range has a compact size with low shaft height, making it easy to retrofit into existing installations where space is tight. Typical industrial applications include overhead cranes, conveyors, hoists, bridges, turntables, fans and winches. Other applications include moveable bridges, lock gates and other types of rotating machinery.

## TYPE MSA — DC MAGNET

- Spring-applied, electromagnetic release
- Magnet coils encapsulated in epoxy resin
- Class F insulation
- Shunt: 12V through 500V DC
- Series: 5A through 300A

### OPTIONS

- Forcing rectifiers (fast response for AC crane hoists, etc.)
- Constant potential rectifiers (for AC crane bridges, trolleys, etc.)
- Terminal box rectifiers (special applications — consult factory)
- Class H Insulation
- Hand release



8" MSA

13" MSTE

## 200S RANGE

- 4" – 19" DIAMETER
- 6 – 2,250 LB. FT. TORQUE
- AC, DC, HYDRAULIC
- EXPLOSION PROOF
- COMPACT DESIGN

## TYPE MSH — HYDRAULIC

- Hydraulically applied by short stroke cylinder, spring release
- Pedal operation — one (1) or two (2) brakes

### OPTIONS

- Remote bleeding

## TYPE MST — 3 PH. AC

- Fast response — standard units 2,000 cycles per hour
- Spring-applied and electrically released
- Continuously rated service < 40°C
- Class F insulation
- AC supplies: 208, 230, 460, 575/3Ph/60 Hz

### OPTIONS

- Automatic Adjustment (AA)— Automatically compensates for lining wear; eliminates time required to manually adjust linkages for brake shoe lining wear
- Automatic Equalization (AE)— Automatically equalizes and maintains running shoe clearance and maintains proper running, which provides balanced braking and equal brake pad wear
- External torque spring with calibrated indicator
- Externally adjustable, stepless time delays in both directions; set and release
- Braketronic™ Controller
- Nitride Corrosion Protection
- Latching hand release
- Stainless steel pivot pins available
- Up to 3 limit switches to indicate brake position
- DC supplies: 250V
- 50 Hz Actuators

# 300M AIST MILL DUTY BRAKES

Magnetek's AIST rated Mondel Mill Duty Brakes are designed for heavy-duty steel mill and other harsh environments and applications. Our advanced design features, combined with fabricated steel construction, make this range of brakes suitable for applications requiring reliable braking with minimal maintenance and downtime. Applications include steel mills, stacker reclaimers, shiploaders, port cranes, shipyard cranes, offshore drilling rigs, missile assembly cranes, incinerator cranes, and large gantry cranes.

## TYPE MBE — DC MAGNET

- Spring-applied, electromagnetic release
- Replaceable magnet coils
- Class F insulation
- Shunt: 12V through 350V DC
- Series: 5A through 1400A

### OPTIONS

- Auto-adjuster for lining wear
- Forcing rectifier (fast response for AC crane hoists, etc.)
- Constant potential rectifiers (for AC crane bridges/trolleys)
- Terminal box rectifiers (special applications — consult factory)
- Class H insulation
- Nitride Corrosion Protection

## TYPE MBM — HYDRAULIC

- Hydraulically-applied and spring released
- Pedal operation — one (1) or two (2) brakes

### OPTIONS

- Remote bleeding
- Nitride Corrosion Protection



30" MBE

## 300M RANGE

5" – 30" DIAMETER

10 – 11,000 LB. FT. TORQUE

AC, DC, HYDRAULIC

EXPLOSION PROOF

## TYPE MBT — 3 PH. AC & DC

- Fast response — standard units 2,000 cycles per hour
- Spring applied and electrically released
- Continuously rated service < 40°C
- Class F insulation
- AC supplies: 208, 230, 460, 575/3Ph/60 Hz

### OPTIONS

- Auto-adjuster for lining wear
- Adjustable external torque spring with calibrated indicator
- Externally adjustable, stepless time delays in both directions; set and release
- Braketronic Controller
- Nitride Corrosion Protection
- Latching hand release
- Up to 3 limit switches to indicate brake position
- DC supplies: 250V
- 50 Hz Actuators

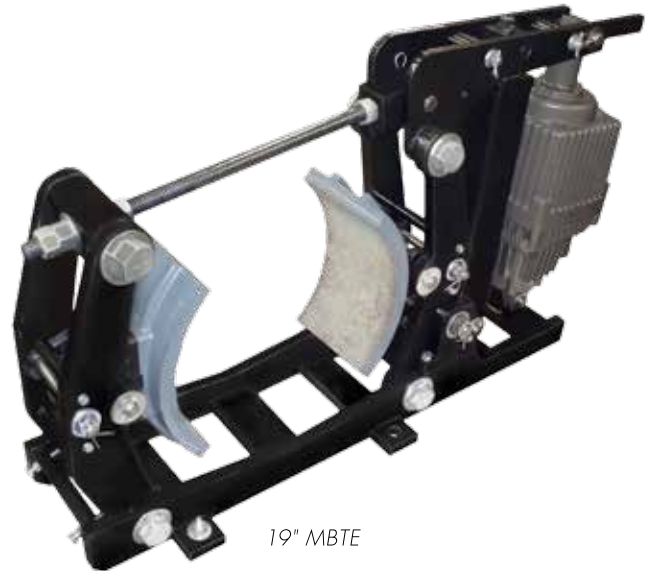

19" MBTE



## 400D HEAVY-DUTY DISC BRAKES

Magnetek 400D Mondel Heavy-Duty Disc Brakes are specifically designed for high speed, high performance applications. They are manufactured from materials selected to optimize performance and serviceability for the most demanding applications.

Two types are available:

**Type SDT** — conform to container industry ratings and dimensions

**Type ADT** — conform to AIST ratings and dimensions

### TYPE DT – 3 PH.AC

- Spring-applied, electrically released
- Continuously rated < 40°C
- Quick replacement friction pads
- Stainless steel pivot pins running in self-lubricating bushings
- AC supplies: 208, 230, 460, 575/3Ph/60 Hz

### ACCESSORIES

- Discs — standard/ventilated
- Discs/hubs (rigid)
- Disc/couplings (flexible)

### OPTIONS

- Adjustable external torque spring with calibrated indicator
- Externally adjustable, stepless time delays in both directions; set and release
- Latching manual release
- Limit switches for proving brake release
- Balanced torque to minimize shaft stresses (two brakes on a common disc)
- Braketronic Controller
- Nitride Corrosion Protection
- DC supplies: 250V
- 50 Hz Actuators

### 400D RANGE

- 8" – 50" DIAMETER
- 50 – 30,000 LB. FT. TORQUE
- AC, DC, HYDRAULIC
- EXPLOSION PROOF
- FLEXIBLE MOUNTING CONFIGURATIONS
- LOW INERTIA
- FAST RESPONSE
- AUTOMATIC WEAR COMPENSATION
- AUTOMATIC PAD CLEARANCE EQUALIZATION



SDT5

# MOTOR MOUNTED BRAKES

Many of Magnetek's industry-leading brakes are available as motor mounted brakes, offering an easy alternative for brake integration. Motor mounted brakes feature the brake already mounted on the Opposite Drive End (ODE) of the motor, which saves time and eliminates brake mounting labor.

Crane builders often buy shoe brakes, brake wheels and motors as separate items, then integrate them into their designs by building separate mounting bases for the motor and the brake. The motor and brake then need to be carefully aligned (usually with shims) to work properly.

Obtaining the motor with a brake package factory mounted simplifies crane design and saves shop time. With the brake mounted, the motor simply needs to be bolted in place and its shaft coupled to the gearbox input shaft. To use this approach, motors with a C-Face and tapered shaft on the ODE are supplied. This allows the brake support to be bolted to the motor's machined flange, ensuring precise location of the brake. Normally, brakes mounted to the motor will be in the 4- to 16-inch wheel diameter size range.

## ADVANTAGES

- Eliminates brake pedestal
- Eliminates alignment issues
- Purchased as a pre-assembled "package"
- Installs as a complete assembly
- Saves time and labor costs

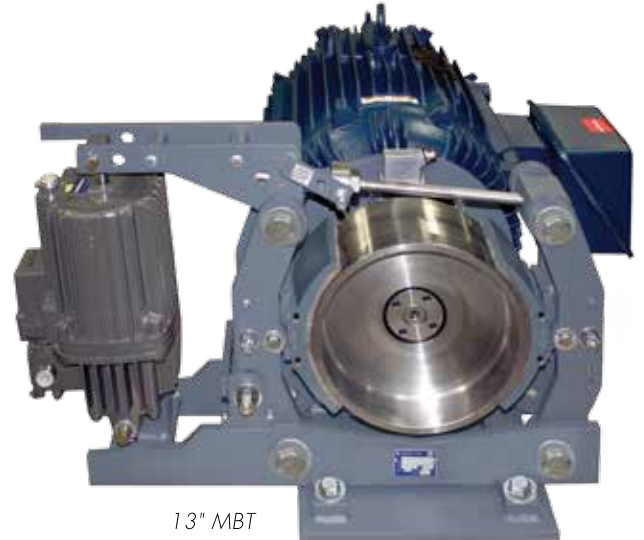

13" MBT

# VERTICAL BRAKES

Magnetek offers a vertical design of its AIST 300M Mill Duty Shoe Brake. The vertical MBT brake is a great fit when space is restricted by related machinery, structural components, or worker access requirements where a standard horizontal brake does not fit. The thruster is mounted above the brakewheel rather than on one side. The vertically mounted brake meets the same requirements as our horizontal MBT brakes and delivers the same rated torque with minimal maintenance and downtime.

Like all of our mill duty shoe brakes, the vertical MBT brake features fabricated steel construction and is designed for use in heavy-duty environments. Applications for mill duty shoe brakes include steel mills, stacker reclaimers, shiploaders, port cranes, shipyard cranes, offshore drilling rigs, missile assembly cranes, incinerator cranes, and large gantry cranes.

## TYPE MBTV — 3 PH. AC

- Fast response — standard units 2,000 cycles per hour
- Spring applied and electrically released
- Continuously rated service < 40°C
- Class F insulation
- AC supplies: 208, 230, 460, 575/3Ph/60 Hz

## OPTIONS

- Auto-adjuster for lining wear
- Adjustable external torque spring with calibrated indicator
- Externally adjustable, stepless time delays in both directions; set and release
- Braketronic Controller
- Nitride Corrosion Protection
- Latching hand release
- Up to 3 limit switches to indicate brake position
- DC supplies: 250V
- 50 Hz Actuators

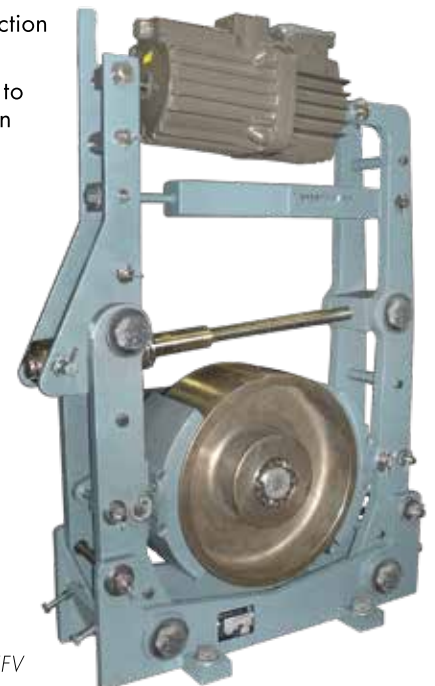

13" MBTEFV



## CUSTOM ENGINEERED BRAKES

Magnetek can furnish custom engineered brakes to meet the unique requirements of your application. Our engineers can custom design brakes with simple manual brake and release designs, unique torque or dimensional requirements, and brakes that meet specific environmental considerations. Magnetek offers an extensive library of brake designs developed to meet the dimensional and performance characteristics of other brake manufacturers' designs. We also provide drop-in replacement brakes that can easily make Magnetek's line of Mondel brakes one of the most comprehensive in the industry — your single source for industrial braking technology. Whatever your braking needs, Magnetek brakes are the solution.

### CAPABILITIES

- Industrial cable reels
- Railroad dumper cars
- Coke oven cars
- Bridges/heavy moveable structures
- Conveyors
- Turntables
- Selector/lock dam gates
- Any industrial braking application

### CUSTOM OPTIONS

- Stainless steel frame hardware and links
- Nitride heat treat corrosion protection
- Special mountings
- Manual brakes
- Manual release brakes
- Special coatings and finishes
- Unique torque and dimensional requirements

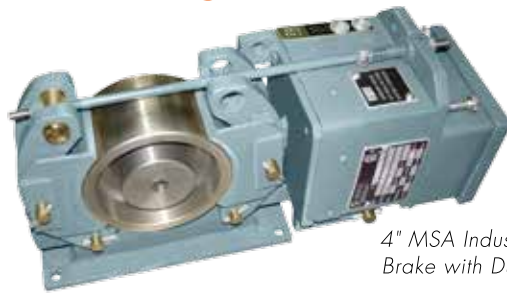

*4" MSA Industrial Duty Magnet Brake with Dupar Drop-in Base*

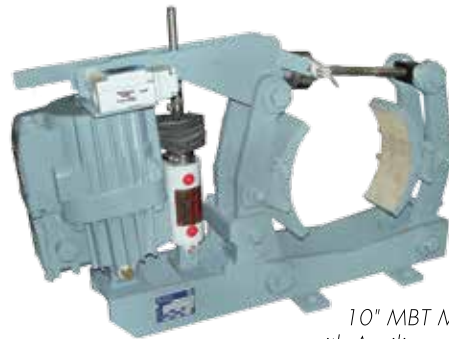

*10" MBT Mill Duty Hoist Brake with Auxiliary Air Cylinder Release*

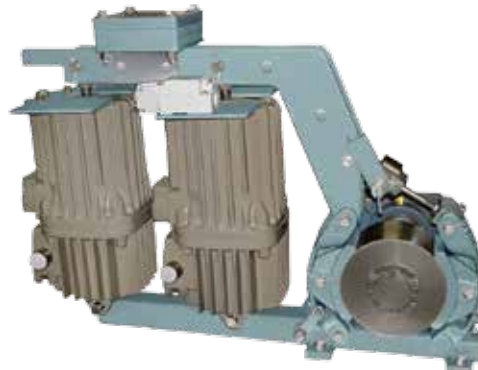

*6" Dual Thruster MST Dam Gate Hoist Brake with Weight Actuation*

# BRAKE ACCESSORIES

## BRAKETRONIC® SYSTEMS – “BRAKE BY WIRE”

Hydraulic brake systems tend to leak and create maintenance and environmental issues. Magnetek’s Braketronic system is the solution! Used on the traverse motions of your overhead crane, the Braketronic package allows for the removal of the entire hydraulic brake system and replaces it with state-of-the-art “brake by wire” technology.

The Braketronic Controller provides variable torque control to thruster operated shoe or disc brakes. By means of a Braketronic unit, single or multiple brakes can be proportionally controlled by foot pedal, master switch, radio control, or selectively from either one. The controller can also be configured to gradually apply the brakes by pre-programmed ramping, initiated by the use of single-step control devices.

Braketronic can replace existing hydraulic systems and provide fail-safe emergency braking. It can be used on all types of cranes, moveable lift bridges and similar applications. The Braketronic system is ideal for new installations or replacement of existing hydraulic brake systems.

## INCLUDES

- Braketronic Controller
- Standard pre-engineered panel
- Mill Duty foot pedal (optional)

## KEY FEATURES

- Variable torque brake performance, controlled from foot pedal or radio control
- Pre-programmed ramping controlled by pushbutton
- Drift point compatible
- Input voltages: 250V DC, 230/460/575V AC–3Ph, 115/230–single Ph
- Control single or multiple brakes
- Industrial or Mill Duty options
- All components are UL listed and include factory testing
- Enclosure heaters for low ambient temperature applications
- Drop-in brake designs available
- Custom application engineering available



## RECTIFIERS/CONTROLLERS

Magnetek’s brake rectifiers/controllers convert AC power to DC power for use with certain types of 200S General Purpose Industrial Brakes and 300M AIST Mill Duty Brakes. They can be provided in enclosures or on backing plates for panel mounting.



## BRAKE WHEELS

Brake wheels are available for 200S General Purpose Industrial Brakes and 300M AIST Mill Duty Brakes.

## FEATURES

- Manufactured from ductile-iron alloy
- Completely machined to provide proper balance at normal operating speeds
- Resistant to scoring
- Wears smoothly and evenly
- Good compatibility with friction materials

## COUPLINGS

Brake wheel couplings for 200S General Purpose Industrial Brakes and 300M AIST Mill Duty Brakes are useful in situations where space is limited. They eliminate the need for expensive double shaft extensions on motors and gear boxes.

## ENCLOSURES

Protective brake enclosures guard against damage from dust and moisture, and also serve to retain heat.



**MAGNETEK**  
MATERIAL HANDLING

[WWW.MAGNETEKMH.COM](http://WWW.MAGNETEKMH.COM)

[SALES@MAGNETEK.COM](mailto:SALES@MAGNETEK.COM)

N49 W13650 Campbell Drive  
Menomonee Falls, WI 53051  
Toll-Free Phone 800.288.8178  
Toll-Free Fax 800.298.3503  
Phone 262.783.3500  
Fax 262.783.3510

4090B Sladeview Crescent  
Mississauga, Ontario, Canada L5L 5Y5  
Toll-Free Phone 800.792.7253  
Phone 905.828.1526  
Fax 905.828.5707

Pub No. Mondel Family Brochure  
© Magnetek, Inc. 6/2013