

TRADITIONAL SIGN & FINGER POST COMPONENTS

The following pages illustrate some of the column and finial casting designs we've built up over the last 139 years.

Also illustrated are some of the 80 patterns we have for signpost **fingers** to designs ranging from the 1920s to 2013. Please contact us if you are trying to match any existing cast finger, column or finial design - we may already have a pattern!



CAST FINGERPOSTS & SIGNPOSTS

Leander Architectural - 139 years of quality and service

(1 to 15 scale)

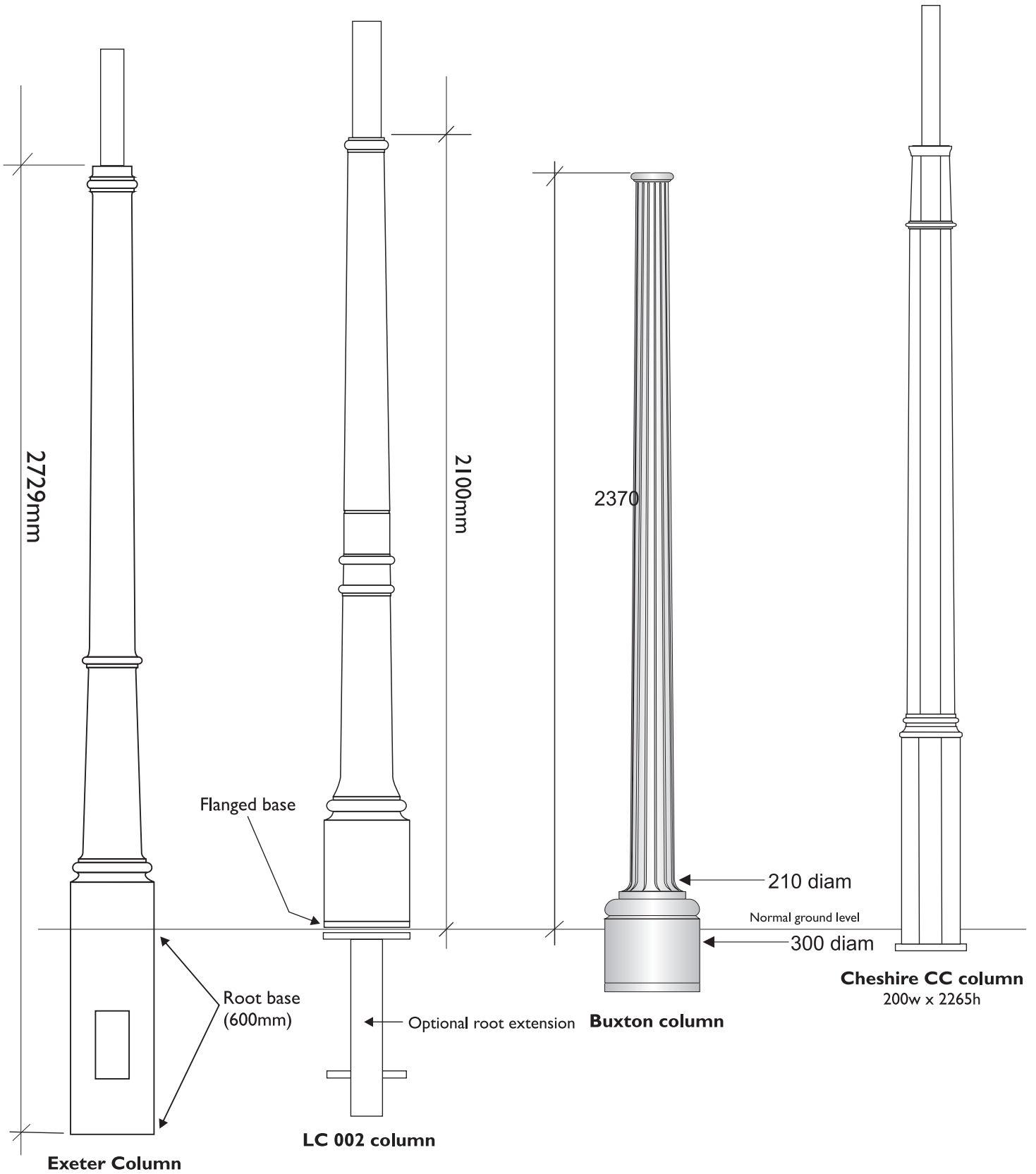

COLUMN BASES

for 89mm diameter tubes (page 1 of 2)

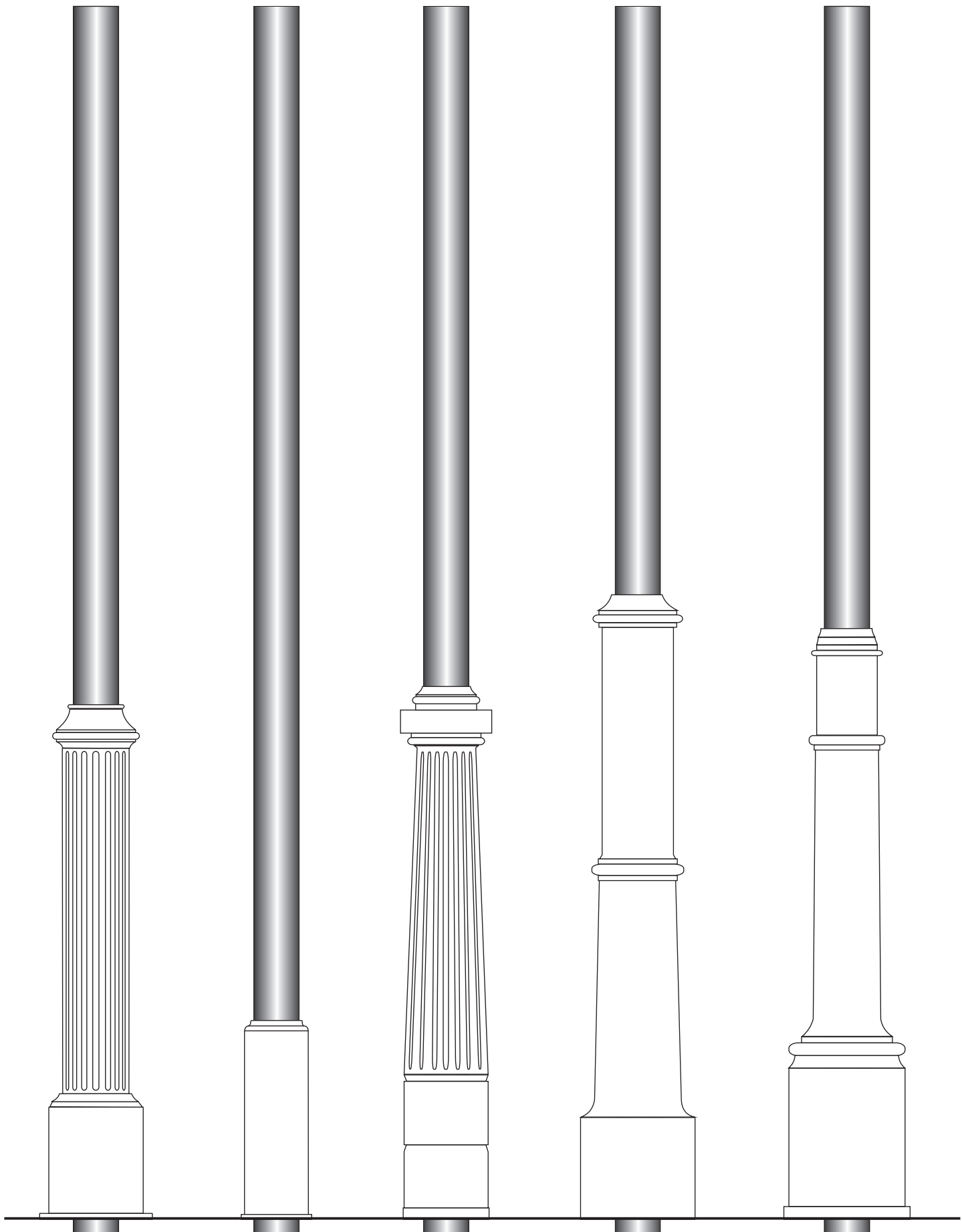

LC NT
185w x 160h

LC 108/89
185w x 1

LC 109/89
185w x 1

LC 106
185w x 1

LC 111
185w x 1

COLUMN BASES

for 89mm diameter tubes (page 2 of 2)

Shorter version
300 high

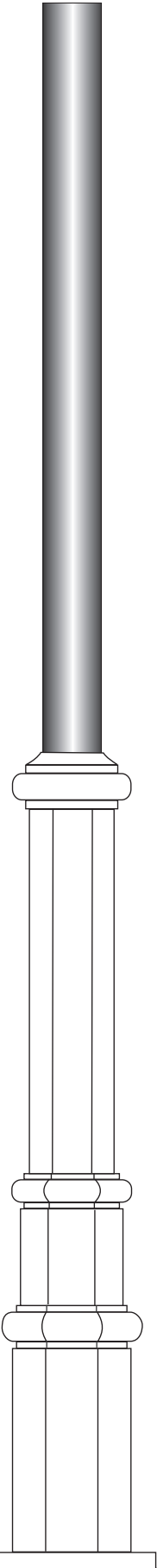

LC 104
185w x 160h

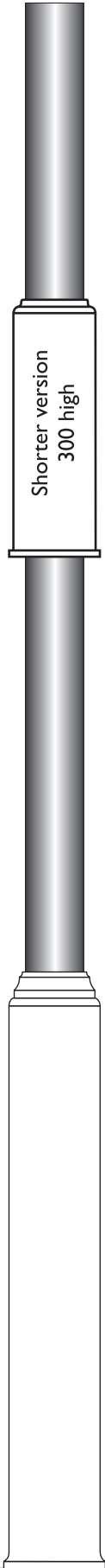

LC 108A/89
156w x 910h

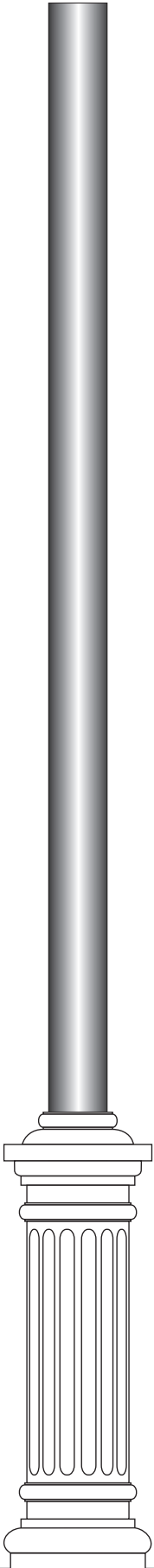

LC 118/89
226w x 700h

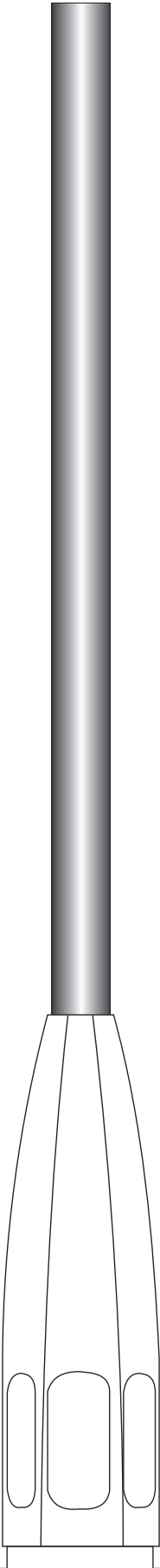

LC 106
240w x 848h

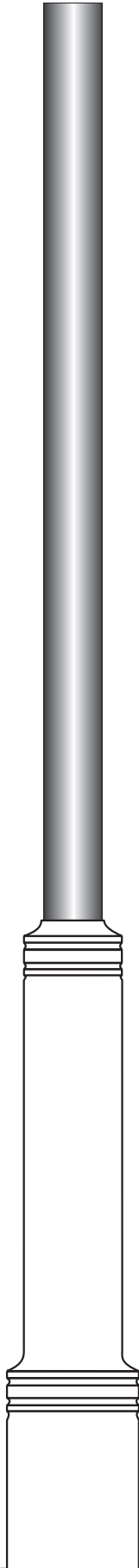

LC 111
202w x 992h

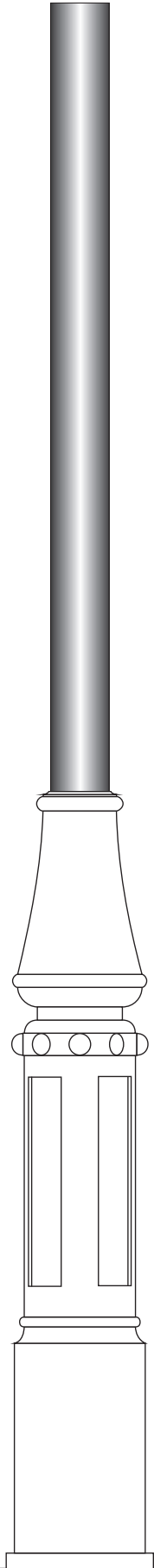

LC 127/89
140w x 392h

COLUMN BASES

for 76mm diameter tubes (page 1 of 2)

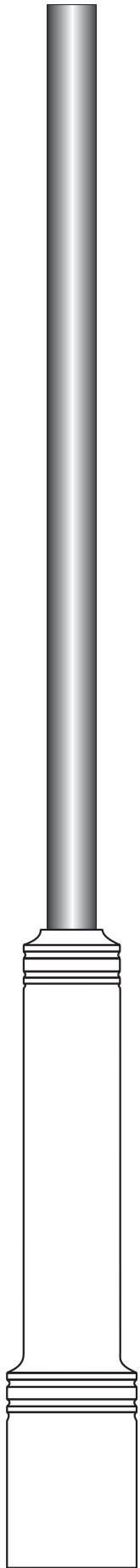

LC 109/76
180w x 1050h

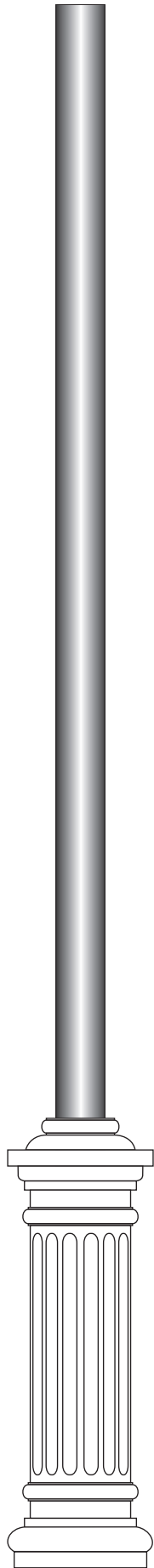

LC 115/76
202w x 1000h



COLUMN BASES

for 76mm tubes

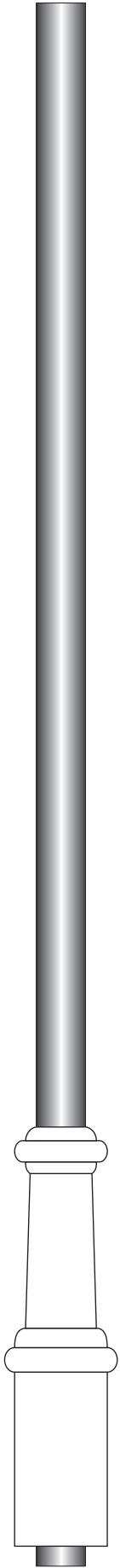

LC 121
650h x 175w

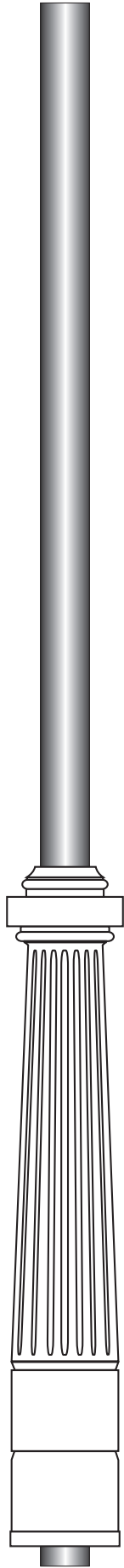

LC 109/76
185w x 1

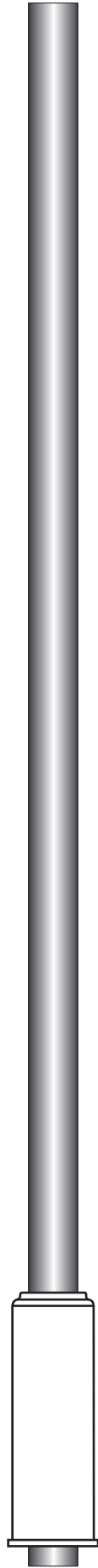

LC 108/76
185w x 1

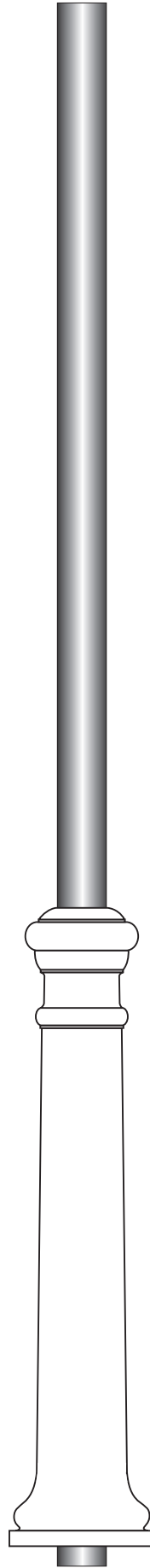

LC 106
185w x 1

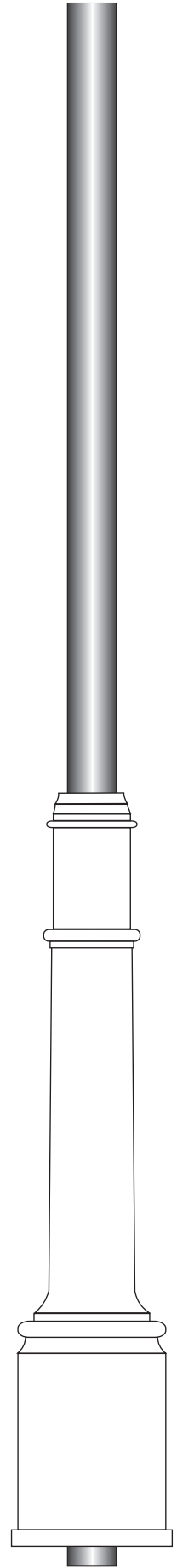

LC 111/76
185w x 1

COLUMN BASES

for sundry tube diameters

100mm

114mm

114mm

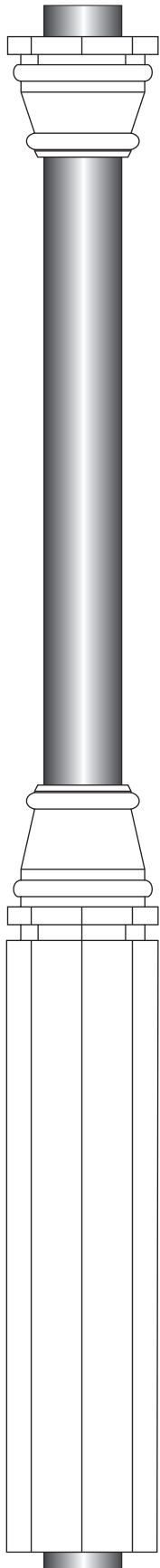
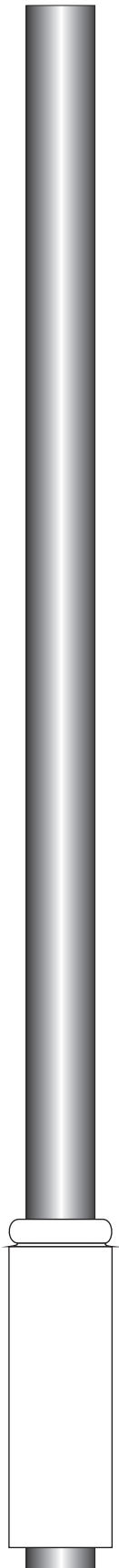

Column capital

60mm

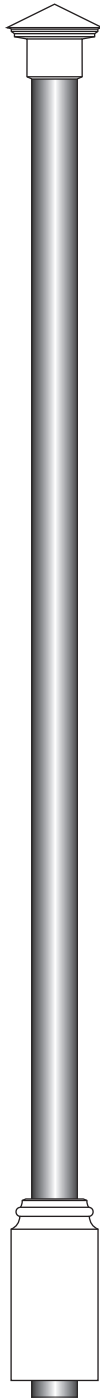

60mm

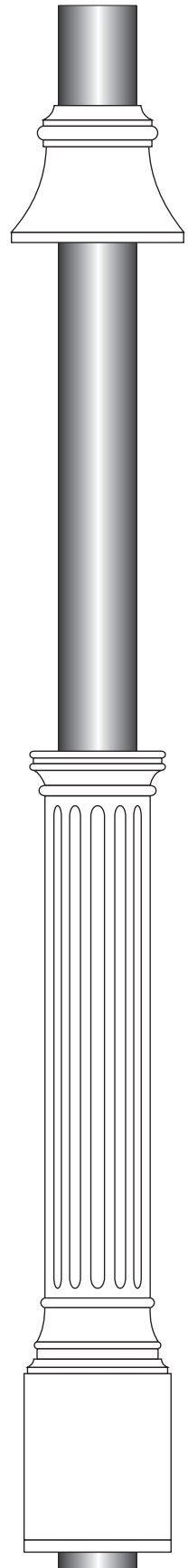
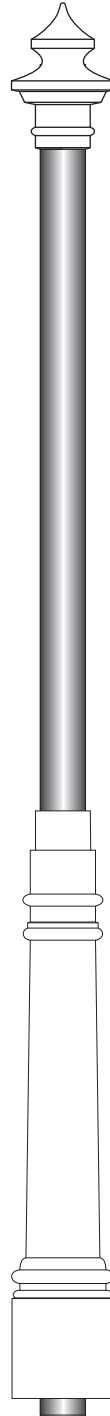

LC 121
650h x 175w

LC 2228
1680h x 330w

LC 2070
360h x 172w

LC 2082
1165h x 202w

LC 111
185w x 1

COLUMN COLLARS & EMBELLISHMENTS

Build your own column!

89mm diam tubes

76mm diam

139mm diam

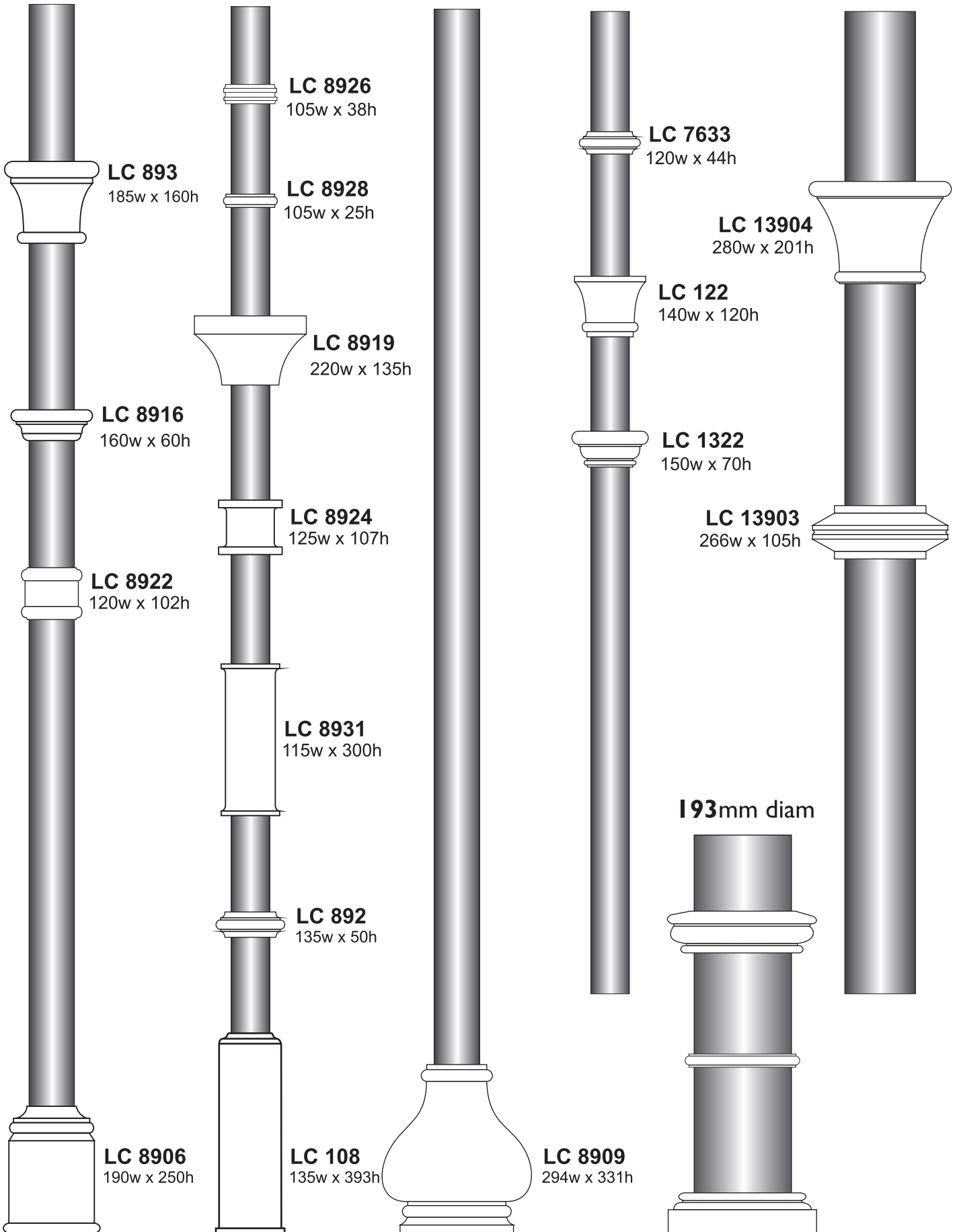

TRANSITION COLLARS

Leander Architectural - 139 years of quality and service

to link tubes of different diameters

89 to 139mm

76 to 139mm

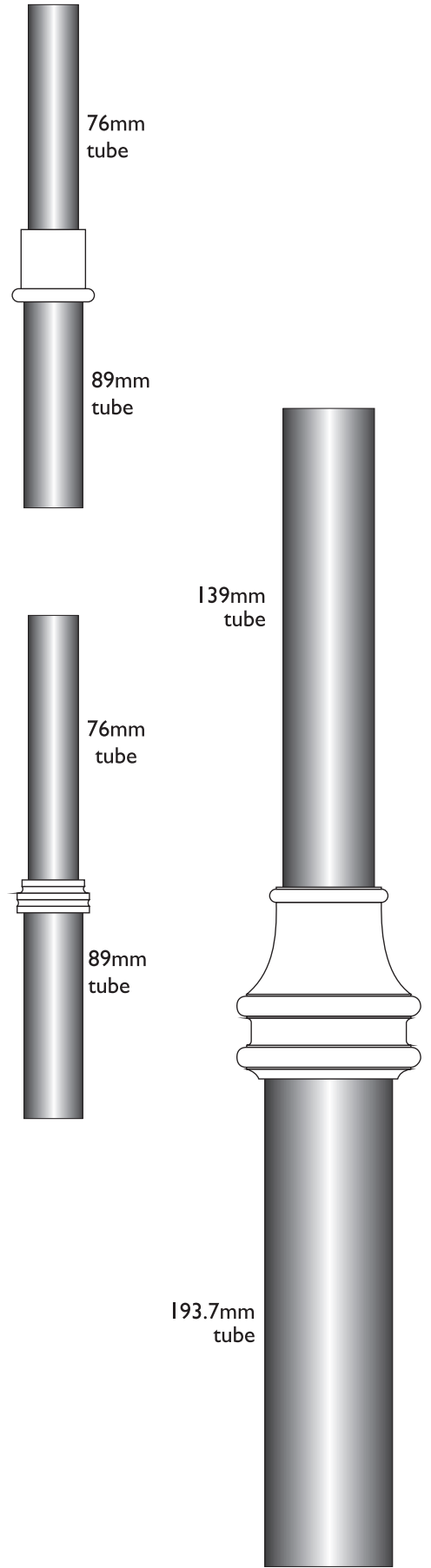
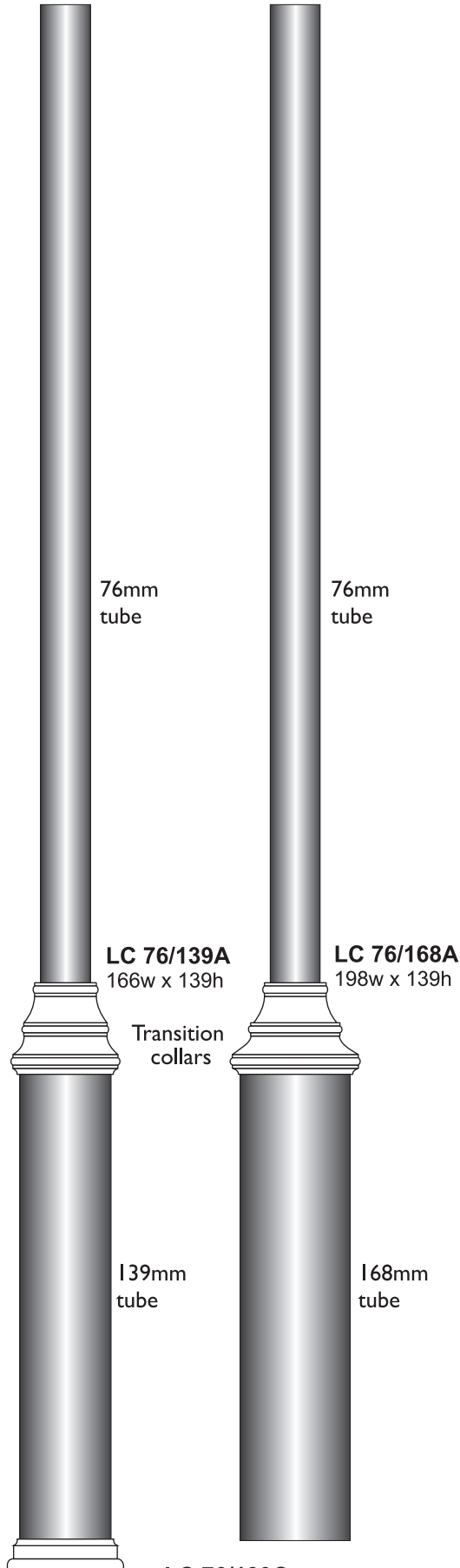
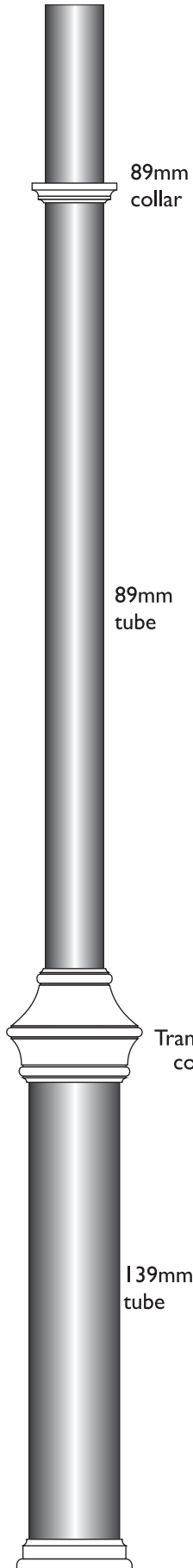

LC 76/139C
177w x 50h

COLUMN FINIALS

Leander Architectural - 139 years of quality and service

for 76mm diameter tubes

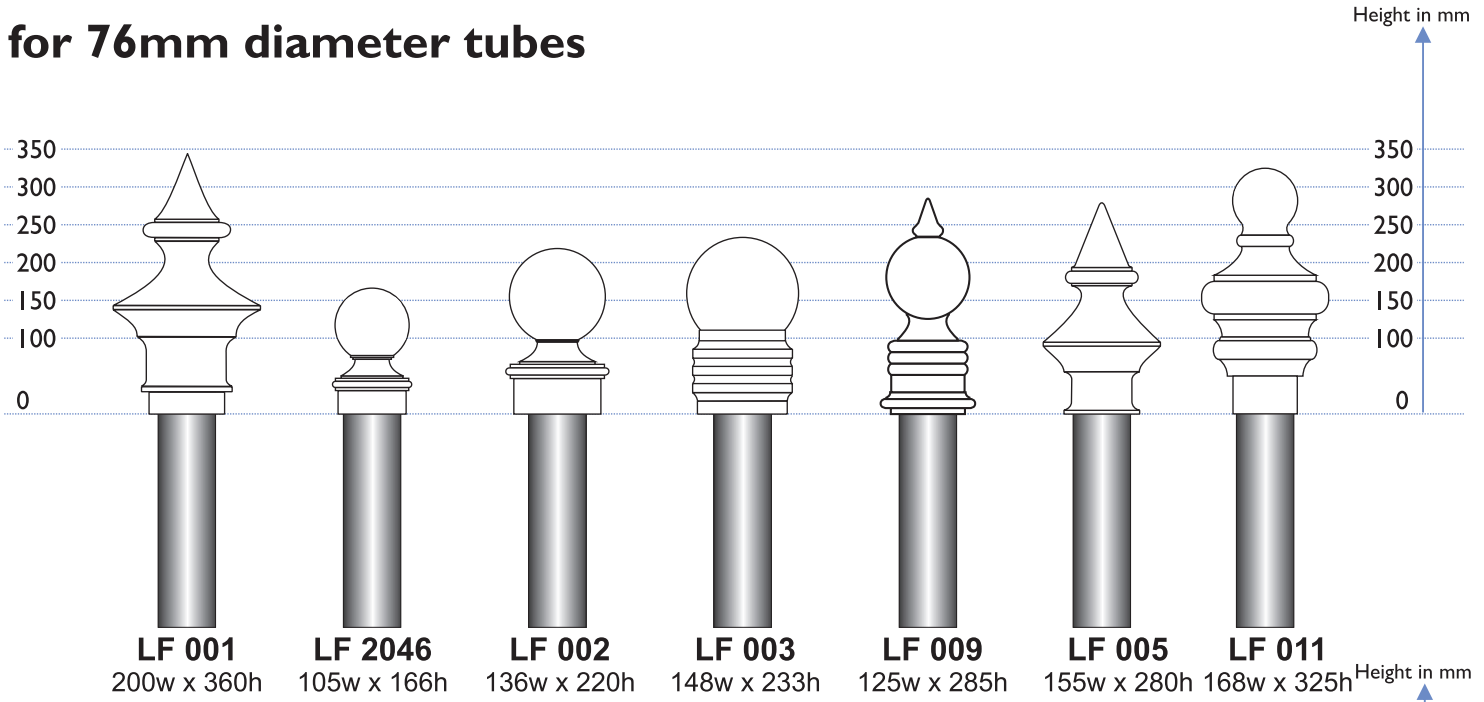

for 76mm diameter tubes

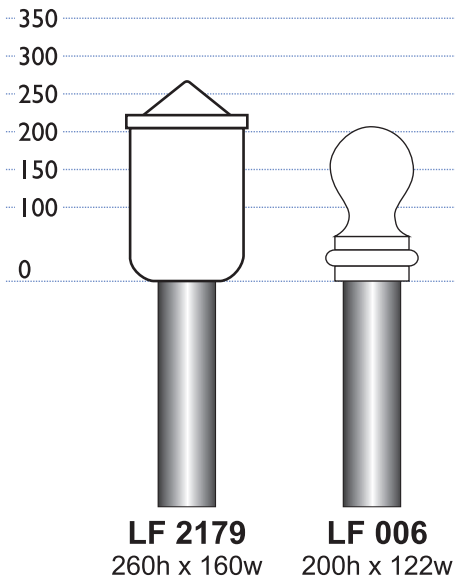

for 60mm diameter tubes

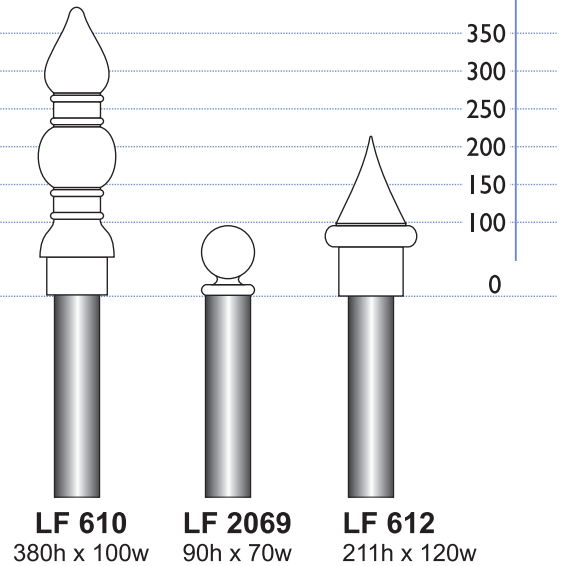

for 89mm diameter tubes

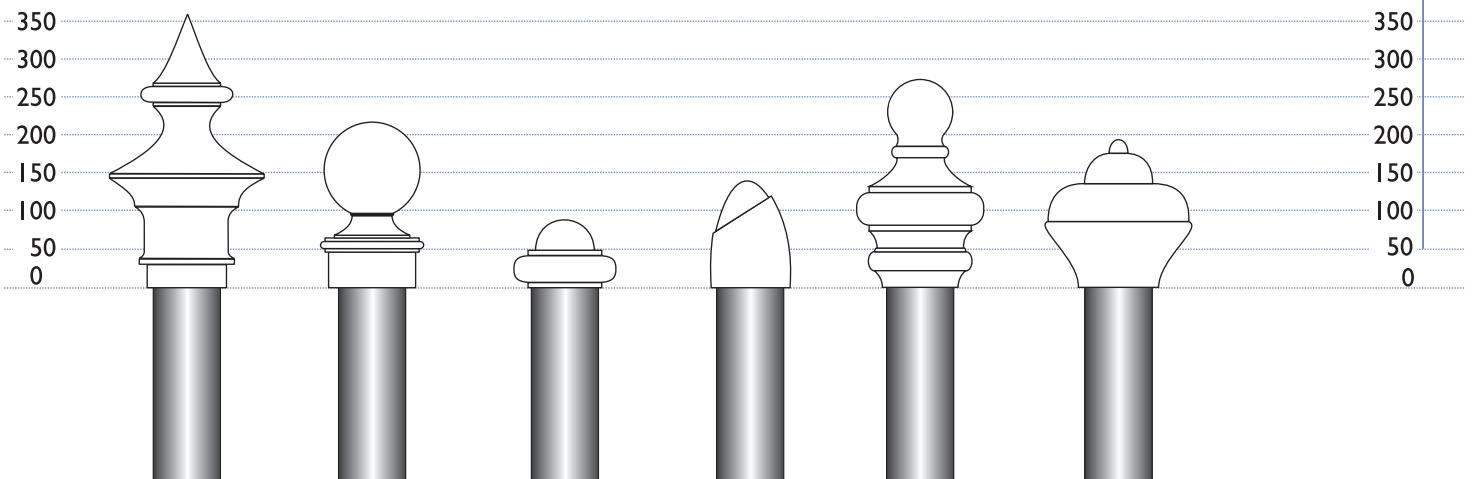

RING FINIALS

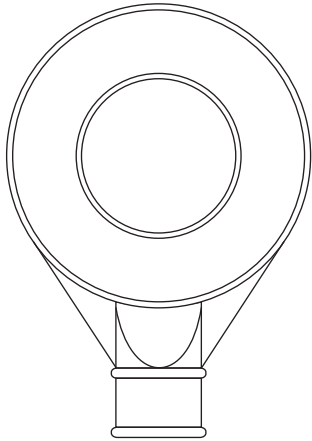

LFR 400

400w x 575h
(solid or hollow centre)



LFR 420

420w x 518h
(solid or hollow centre)
also available at 300 diam

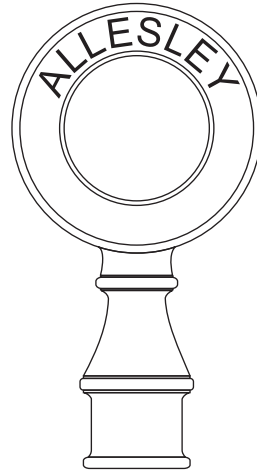

LFR Cheshire CC

330w x 615h
(solid or hollow centre)

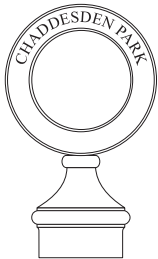

LFR York

200w x 335h
(solid or hollow centre)

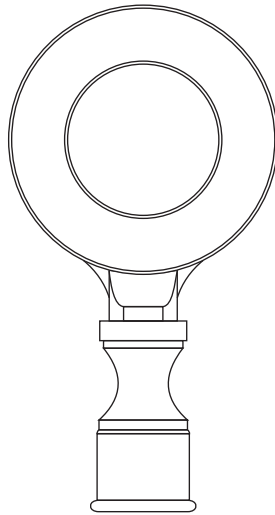

LFR Hampshire CC

356w x 670h
(solid or hollow centre)



LFR Ridings

468w x 468h
(solid or hollow centre)



LFR Oxfordshire CC

445w x 675h
(solid centre)

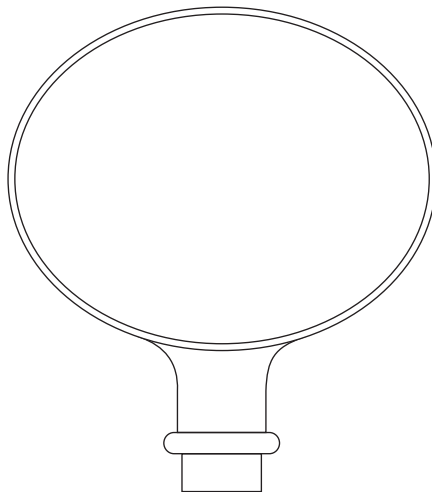

LFR Salter

566w x 640h
(solid centre)

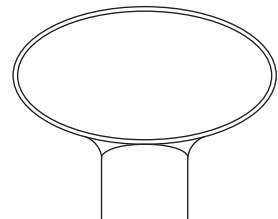

LFR 2226

348w x 283h
(solid centre)

FINGERS & POINTERS

We have **many more** finger and pointer patterns ranging from pre-war village signposts to contemporary designs from the last twenty years. If you need a design that's not illustrated, just let us know.

Approximate scale 1:10

Sheet 1 of 2

“Revival” era fingers (late 1970s to date)

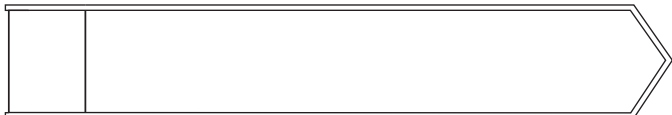

Available at 90, 150 & 210mm deep

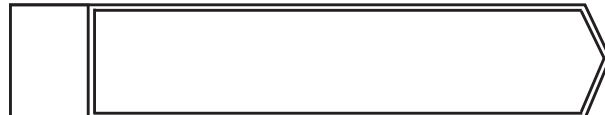

Available at 100, 150, 210 & 290mm deep



Design specifically for Saffron Walden

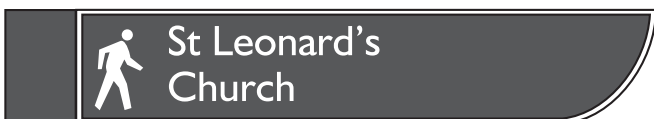

Designed specifically for Llandudno



Design for Shropshire alleyways or “jitties”

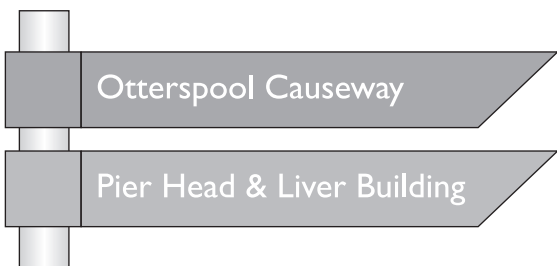

Lightweight cast fingers for Leander polished stainless posts



Royal Label Factory geared fingers (1950s- to date) various lengths and depths available

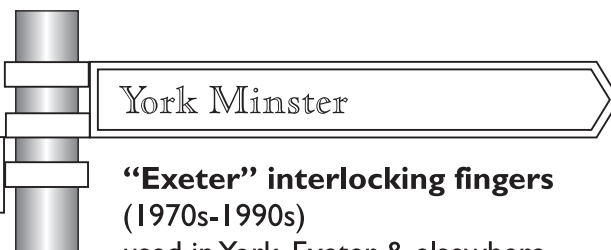

“Exeter” interlocking fingers (1970s-1990s) used in York, Exeter & elsewhere



FINGERS & POINTERS

We have **many more** finger and pointer patterns ranging from pre-war village signposts to contemporary designs from the last twenty years. If you need a design that's not illustrated, just let us know.

Approximate scale 1:10

Sheet 2 of 2

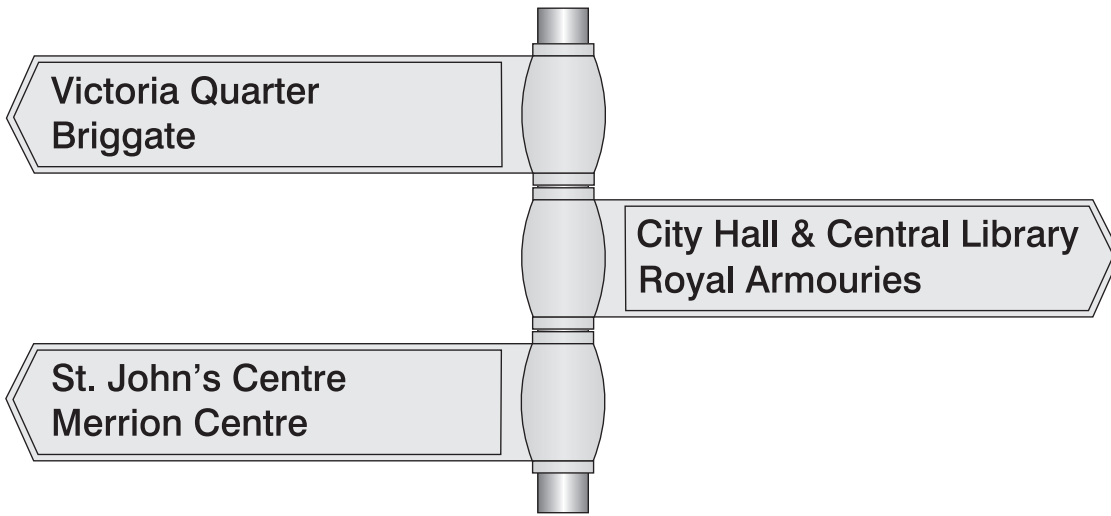

“Bulb” fingers - available to suit posts of 76, 89 and 114mm diam



Cast collars for wooden fingers (lettering printed or as individual screwed letters/numbers) Used in Notts & elsewhere.
Finger depth 190mm / any lengths : collar i.d. 82mm approx



Large village signpost fingers (widely used in Britain, many in Cheshire)



Finger depth 195mm / various lengths : Collar i.d. 102mm approx

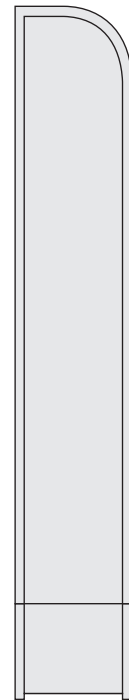

Thanet fingers
915w x 154h
Also at 915w x 101h

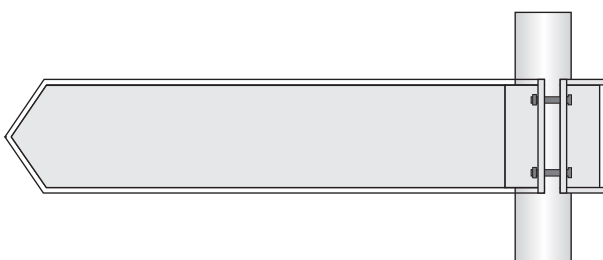

Split collar fingers - to suit many standard column diameters
(ideal where access via top of column is not feasible)