

Manual

Shutter Garage Door Operation Guide and Information



Our other products include interior blinds and awnings

1 Ensure the opening is clear of any obstructions and that the operator is in full view of the door.

2

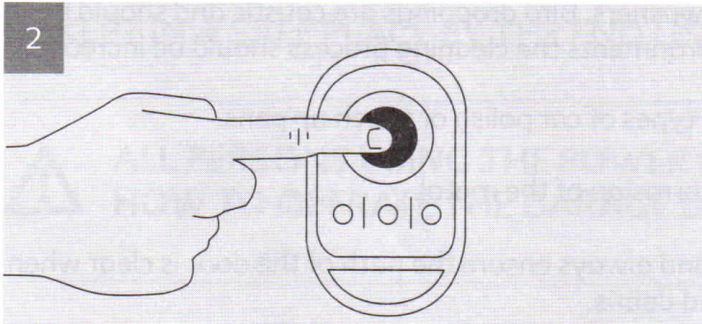

Press the large black button in the centre of the hand held transmitter (key-fob) for 1 second and the door will start to move to the fully open or closed position and stop. By pressing the black button again the door will perform the opposite sequence and stop.

3

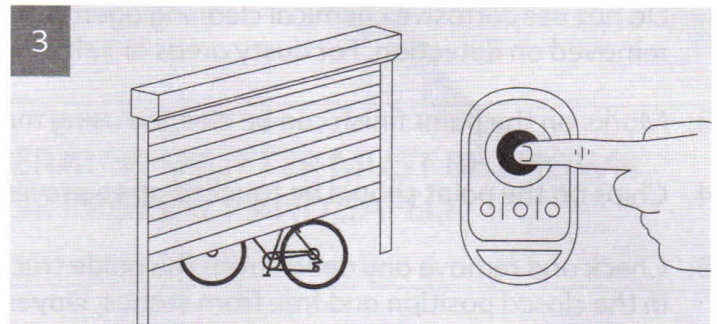

During the closing cycle if the door detects an obstruction it partially reverses and stops. The remote control receiver will emit a warning light flashing rapidly to confirm it has hit an obstacle. Remove the obstacle and press the black button again to close the door.

4

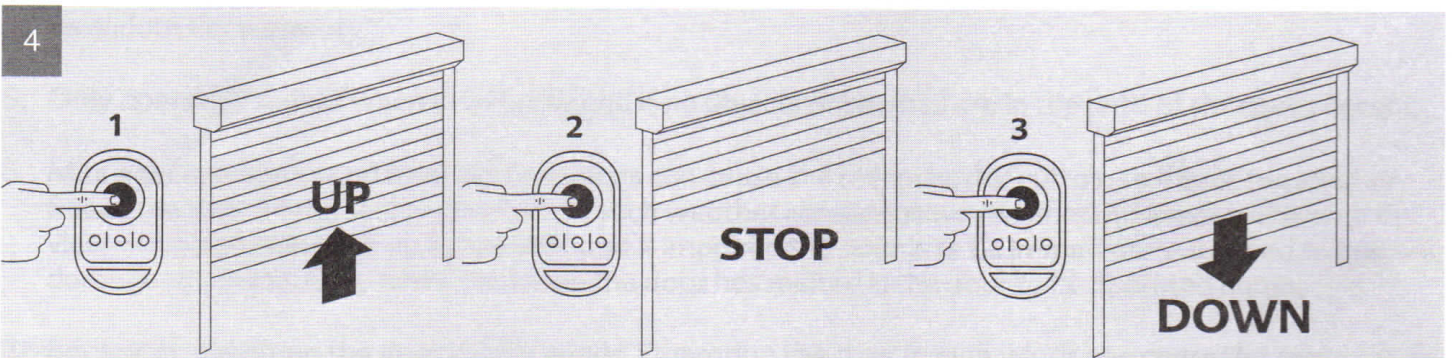

During the up or down cycle you can stop the door by simply pressing the black button on the key-fob. The next press of the black button on the key-fob will send the door in the opposite direction from which it was moving.

5

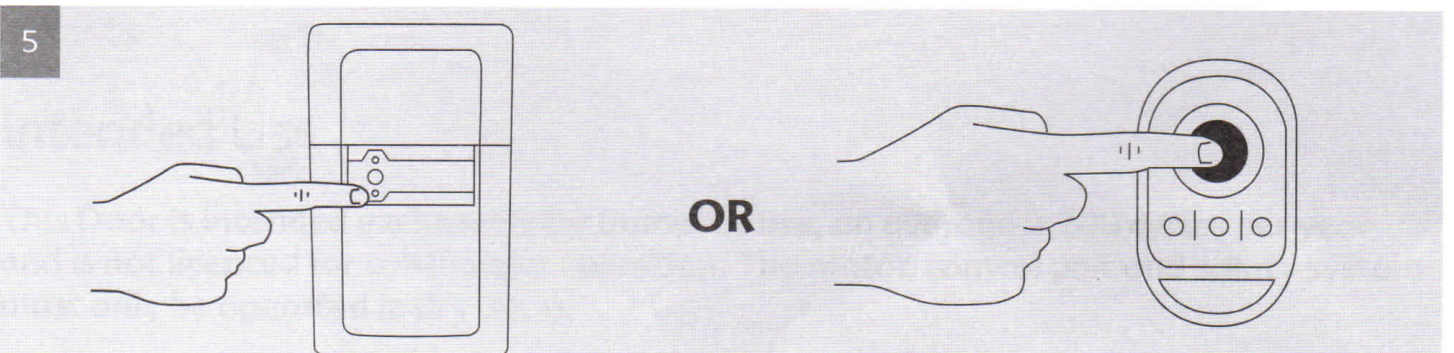

OR

If the OSE safety system has a fault or fails to operate the door can be brought down by pressing and holding the down button on the control receiver board or by keeping the black button held down on the downward cycle of the operator key-fob.

6

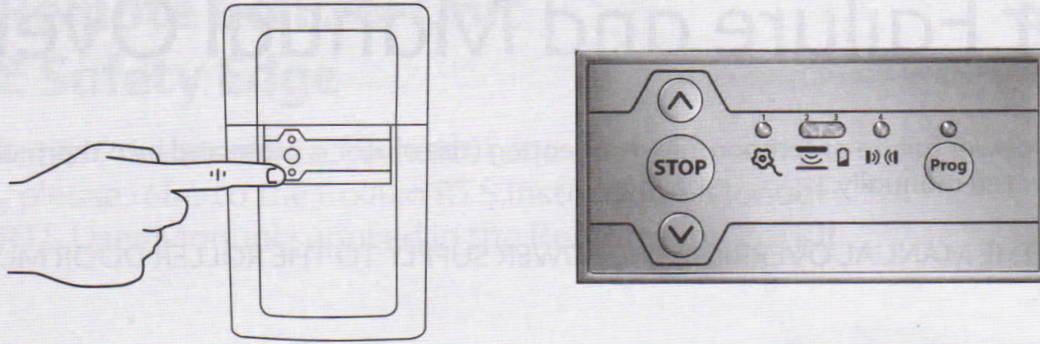

The door can also be operated from the Rollix control unit via the UP - STOP - DOWN buttons.

7

ALARM MODULE: The Rollix control unit is fitted with an alarm module. If an attempt is made to lift the door when fully closed the alarm will activate and sound for two minutes. The alarm can only be turned off with the hand held transmitter by pressing the big central button. The door cannot be operated while the alarm is sounding.

8

SMOOVE WIRELESS SWITCH: To operate the Smoove wireless switch simply touch the up arrow to take the door up, or the down arrow to take the door down. To stop the door at any intermediate point, press the MY button.

8

RTS WIRELESS KEYPAD: To operate the RTS keypad press in your code number (normally 4 digits) then press the top left hand button for one second. The door will move in the desired direction and stop. To stop the door during its travel, press the button again. After twenty seconds the unit requires the code number re-entering in the same way to operate the door.

Safety Check

At least every six months, check the OSE safety beam in the bottom of the rubber seal by lowering the door half way down and obstructing the path of the door to land on your hand (handshake position). The rubbers will crush together and stop/reverse the door. Simply press the key fob button again and the door will operate normally.

Fault Finding (operating diagnostics)

Fault finding diagnostics can be found in the Rollix RTS User Manual, English section, page 5, supplied with the door control unit.

Maintenance

Key fob batteries	1 x CR2430
OSE safety batteries	1 x AA3V6 lithium battery (AAIV5 NOT Compatible)
Rollix receiver light bulb	1 x E-14-25w

Power Failure and Manual Override

In the event of a power failure or temporarily overheating (the motor is protected by a thermal cut out), the door can be operated manually.

BEFORE USING THE MANUAL OVERRIDE, THE POWER SUPPLY TO THE ROLLER DOOR MUST BE SWITCHED OFF.

To operate:

Hold the manual override handle in line with the eye and rotate the handle in the desired direction to either open or close the door. **DO NOT OVERWIND.**

WHEN RAISING THE DOOR, ALWAYS LEAVE THE CURTAIN HANGING INTO ITS TRACKS.

WHEN LOWERING THE DOOR, NEVER WIND DOWN TOO FAR, JUST ENOUGH TO LAND ON THE FLOOR.

Drop Eye Manual Override

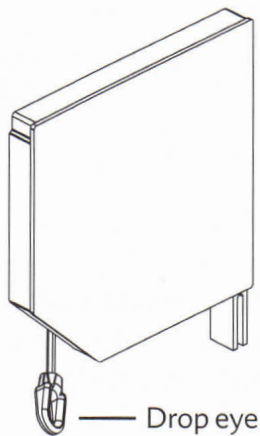

Locate the Crook Hook into the drop eye and hold handle at 45 degrees then rotate to wind up, or down as required.

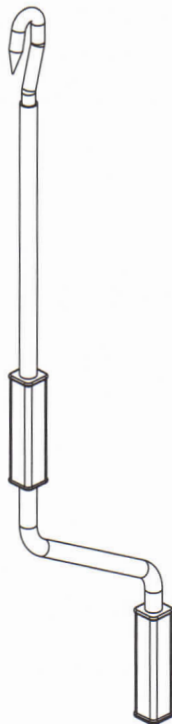

Fixed Eye Manual Override

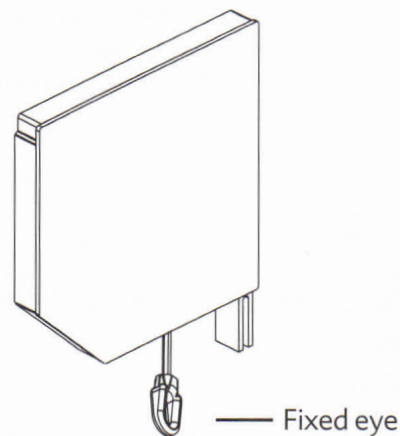

Locate the Crook Hook into the fixed eye and hold handle straight then rotate to wind up, or down as required.

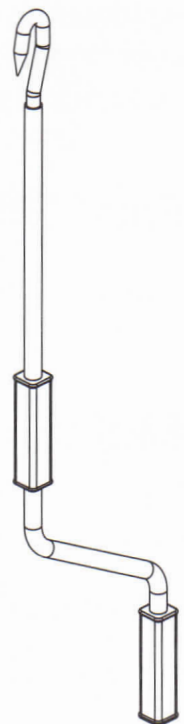



CAUTION

All persons using the power operated shutter must be shown how to operate the garage door properly and safely.

1. When operating the door the user must be in sight of the door at all times.
2. When operating the door do not place fingers near or in the shutter guide tracks at any time, or within any moving part of the door.
3. Do not allow children to operate/play with the door or any electrical switching equipment.
4. Do not attach objects or make alterations to the door as this may cause damage, personal injury and invalidate the warranty.
5. Only operate the door when in full view and if no objects or persons are in the path of the door descent.
6. Minus temperatures and freezing conditions can cause the roller shutter curtain to freeze together or freeze the bottom rail seal to the floor. In such weather we recommend keeping the door in view when operating the up movement and if impaired the door is to be immediately stopped to prevent damage occurring. Only when the ice on the door has melted is the door to be operated again.
7. Beware of operating the door in high winds, operating the door in high winds can cause the centre of the shutter curtain to bow activating the safety device in the bottom rubber seal.
8. In the event of a malfunction the operator/end user should follow the advice given in the operation and maintenance manuals and if applicable contact drathmore. Repairs and adjustments should be undertaken by qualified personnel.

Intended Use

This door is intended exclusively for domestic use, on average 2200 cycles per year and is not licensed for continuous operation. The motor, control unit and safety systems must only be operated in dry areas.

Cleaning

1. Power to the garage door should be isolated before washing.
2. Periodically clean the door (At least four times a year) with soapy water, rinse and allow to dry naturally. Do not use corrosive chemical cleaning agents or jet washers. Bird droppings are caustic and should be removed on detection. For dusty areas or salt air environments the cleaning process should be increased.
3. Marks on the paint finish can be cleaned using many types of car polish or touch up pens.
4. Chips on the paint should be touched up to prevent corrosion of the metal.
5. Check and remove any debris from the guides tracks and always ensure the path of the door is clear when in the closed position and free from stones, leaves and debris.