

# INSTRUCTION MANUAL

1/10 Scale Electric Crawler



□ NO.RH1050 MC31



# VRX Racing RTR Brushed 2.4GHz Crawler

Congratulations on your purchase of the VRX Racing 4WD electric cars.

These 1/10th scale model are almost fully assembled, but still need consumer to finish the body and wheels before using.



**MC31**



**MC31**



**MC31**

**WARNING:** Read the ENTIRE instruction manual to become familiar with the features of the product before operating. Failure to operate the product correctly can result in damage to the product, personal property and serious injury. This is not a toy and must be operated with caution and common sense. Failure to operate this product in a safe and responsible manner could result in damage, injury or damage to other property. This product is not intended for use by children without direct adult supervision. It is essential to read and follow all the instructions and warnings in the manual, prior to assembly, set-up or use, in order to operate correctly and avoid damage and serious injury.

## Safety Precautions and Warnings

You are responsible for operating this model such that it does not endanger yourself and others, or result in damage to the product or the property of others. This model is controlled by a radio which is possibly subject to interference which can cause momentary loss of control so it is advisable to always keep a safe distance to avoid collisions and injury. Age Recommendation: 14 years or over. This is not a toy. This product is not intended for use by children without direct adult supervision.

Carefully follow these directions and warnings, plus those any additional equipment associated with the use of this model, chargers, ESC and motors, radio etc.

- Never operate your model with low transmitter batteries.
- Always operate your model in an open area away from cars, traffic or people.
- Never operate the model in the street or in populated areas.
- Always keep the vehicles in direct line of sight, you cannot control what you cannot see!
- Keep all chemicals, small parts and anything electrical out of the reach of the children.
- Avoid water exposure, moisture causes damage to electronics and may result in the loss of control or permanent damage.
- Avoid injury from high speed rotating parts, gears and axles etc.
- Novices should seek advice from more experienced people to operate the model correctly and meets its performance potential.
- Exercise caution when using tools and sharp instruments.
- Do not put fingers or any objects inside rotating or moving parts.
- Take care when carrying out repairs or maintenance as some parts may be sharp.
- Do NOT touch equipment such as motor electronic speed control and battery, immediately after using your model because they can generate high temperatures.
- Always turn on your transmitter before you turn on the receiver in the car. Always turn off the receiver before turning your transmitter off.
- Keep the wheels of the model off the ground, keep your hands away from the wheels when checking the operation of the radio equipment.
- Prolong motor life by preventing overheat conditions. Undue motor wear can result from frequent turns, rapid change of direction forwards/backwards, continuous stop/starts, pushing/pulling objects, driving in deep sand and tall grass, or driving continuously up hill.



# Required equipment for operation

## 1. Tools required for building and maintenance:

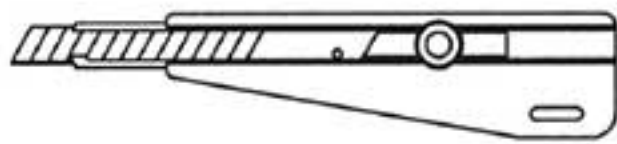

● Hobby knife



● Precision ruler

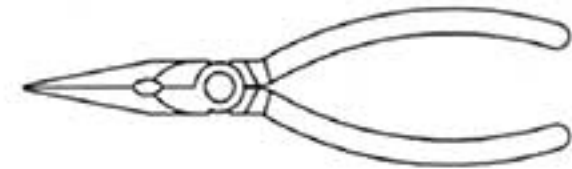

● Needle nose pliers

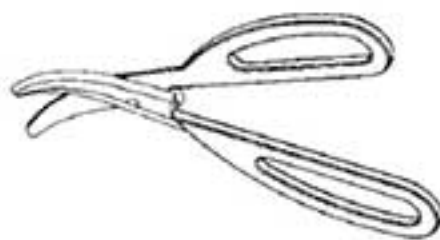

● Lexan scissors

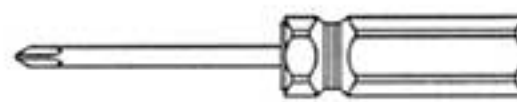
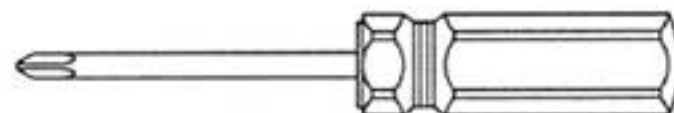

● Flat and Philips screwdriver

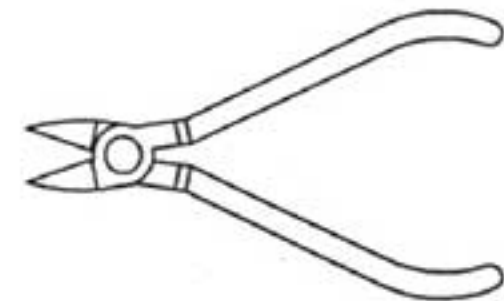

● Wire cutters

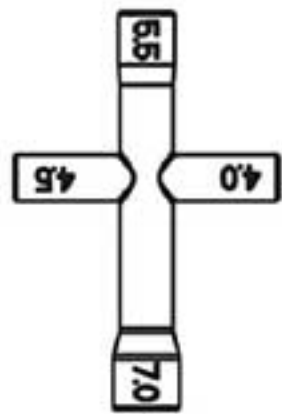

● Cross wrench

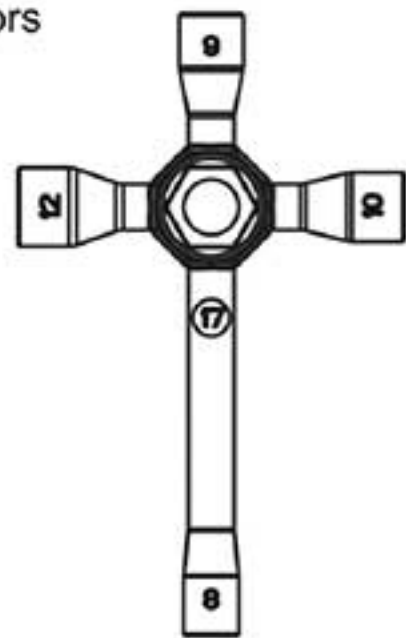

● Cross wrench



● CA glue&rubber cement



● Thread locking compound



1. 5mm



2. 0mm



2. 5mm

● Hex wrench

## WARNING!

Do not use a power screw driver to install screws into nylon or plastic materials. The fast locking may heat up the screws being installed that may break the molded parts or strip the threads during installation.

## 2. Additional items needed for operation:

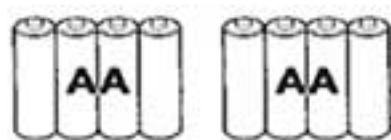

8 pcs AA Alkaline batteries for transmitter

## IMPORTANT!

Check that all screws and nuts are tight before each use.

# Assembly Needed Before Using

## 1、What 's Included in Box MC31 RH1049



## 2、Finish Assembly of MC31

Assemble the Body Mounts  
车身支柱组装

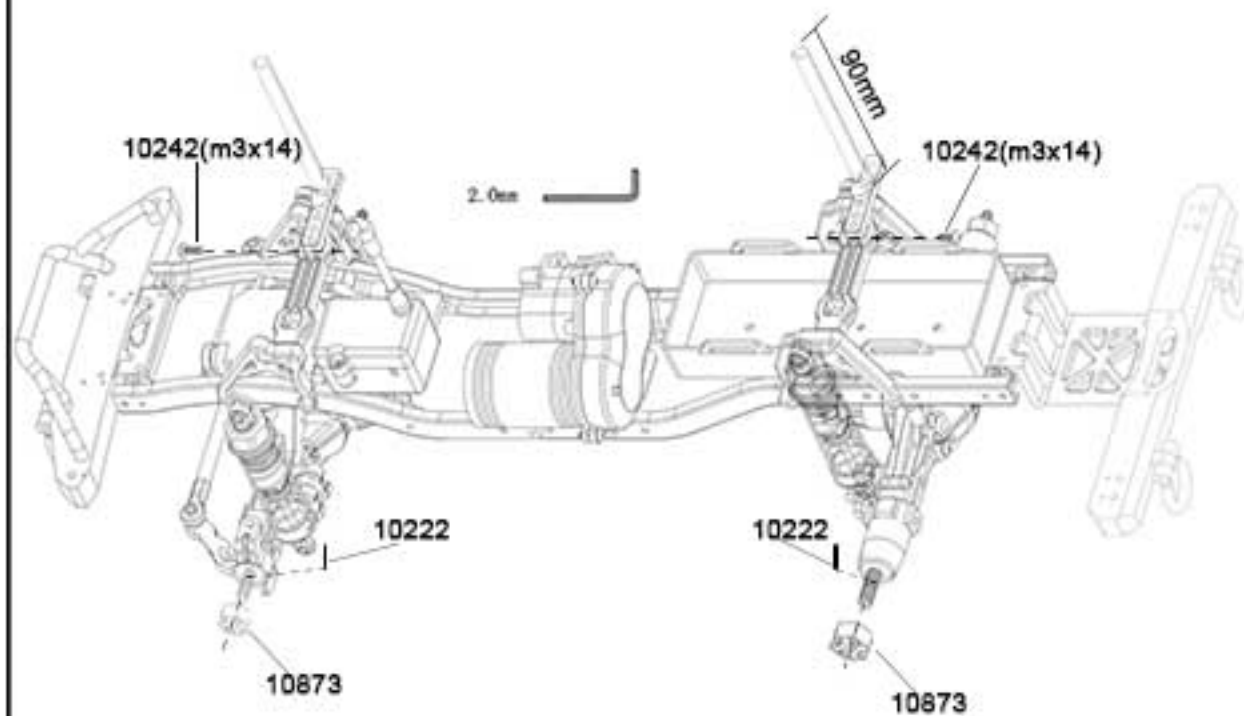

Wheels Assembly  
轮胎组装

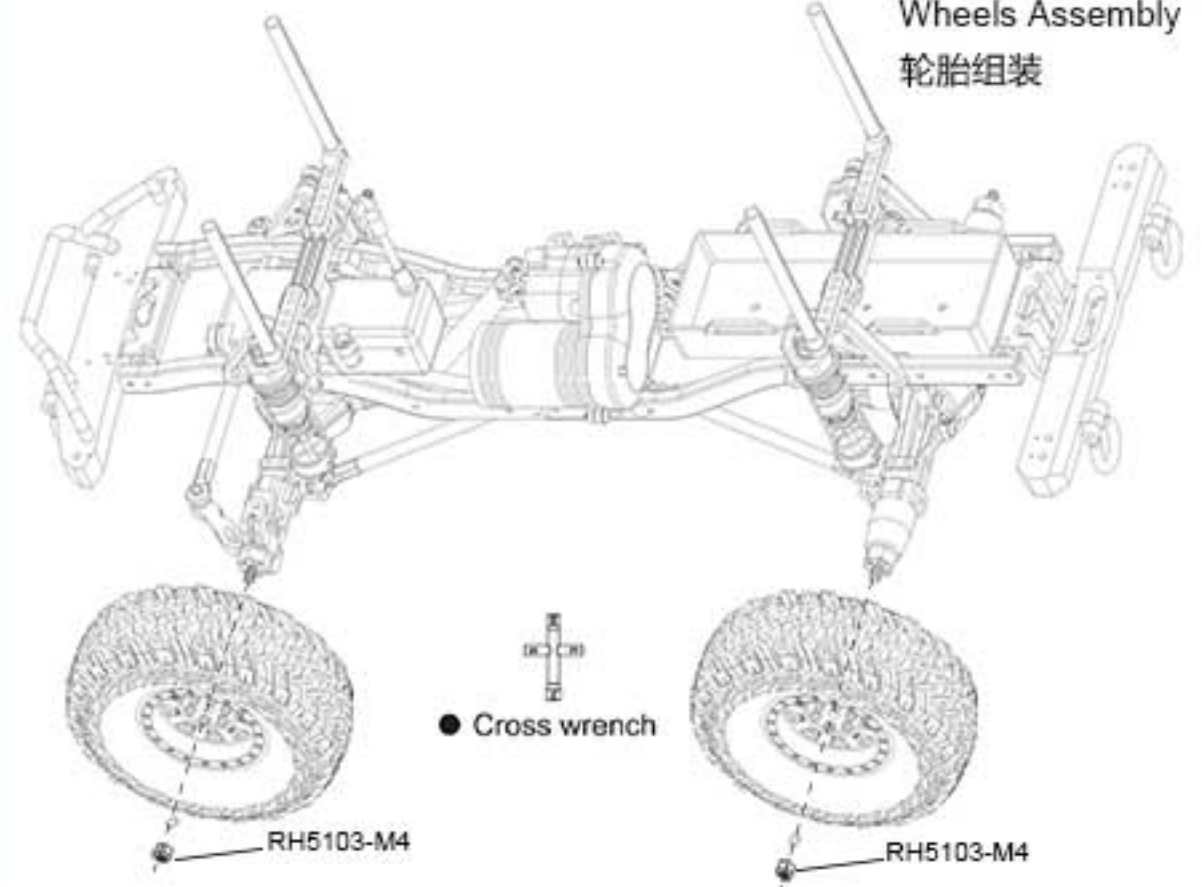

Assemble the body to chassis, adjusting its height with adjusting plates.  
安装车壳 (RH1049)

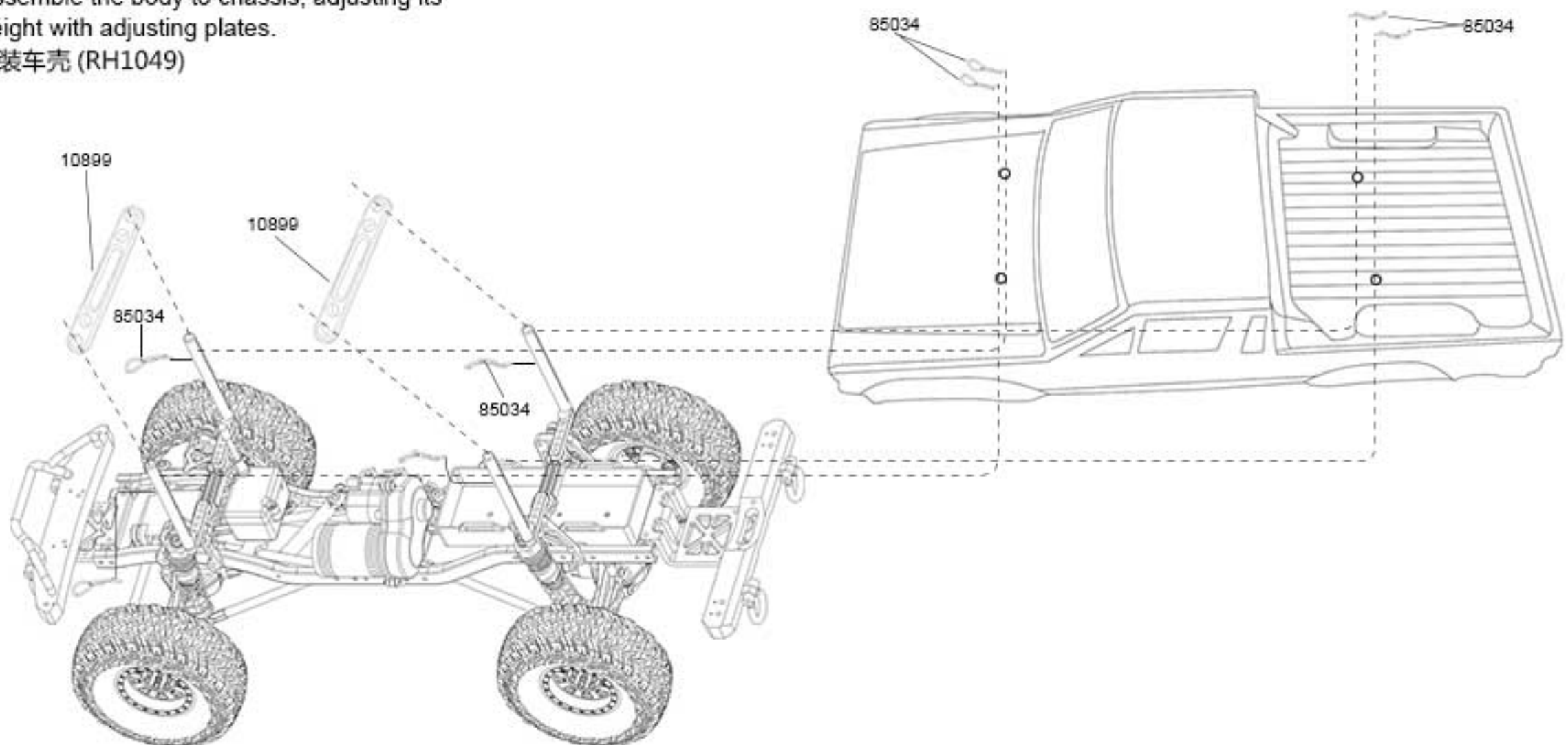



## Aerial Assembly

As the aerial wire on 2.4GHz system is so short you do not need to protrude through the body shell and it can be left to stand directly from the receiver. If you want the security of an aerial tube away simply cut it short, and insert in the usual way but do NOT bend over the last 5mm of aerial wire to retain it under the rubber cap, last two inches of aerial wire need to be straight with no kinks for maximum range and control with 2.4GHz system.

First be sure to insert the wire up through the receiver cover hole as below. Push the wire all the way through the aerial tube until the first 5mm of wire shows out of the other end. Finally make aerial tube firmly seated

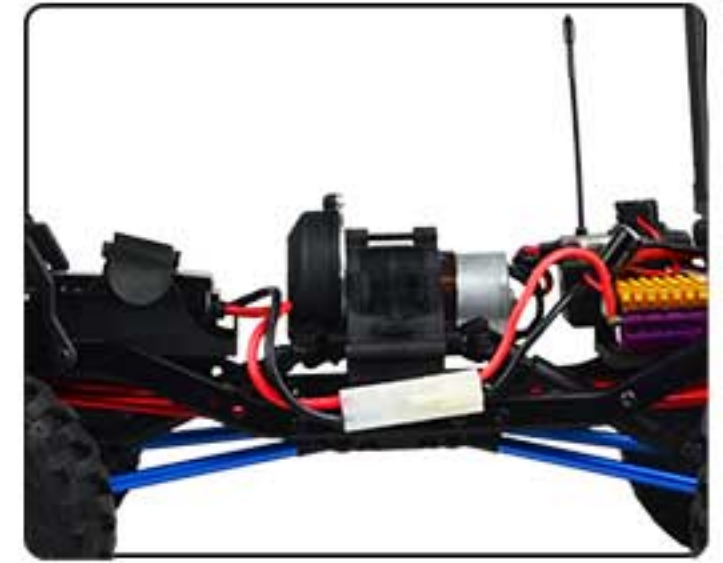
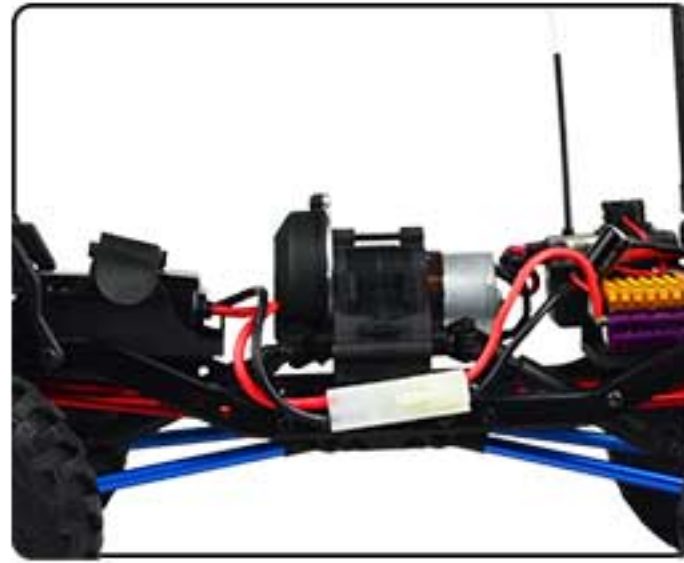
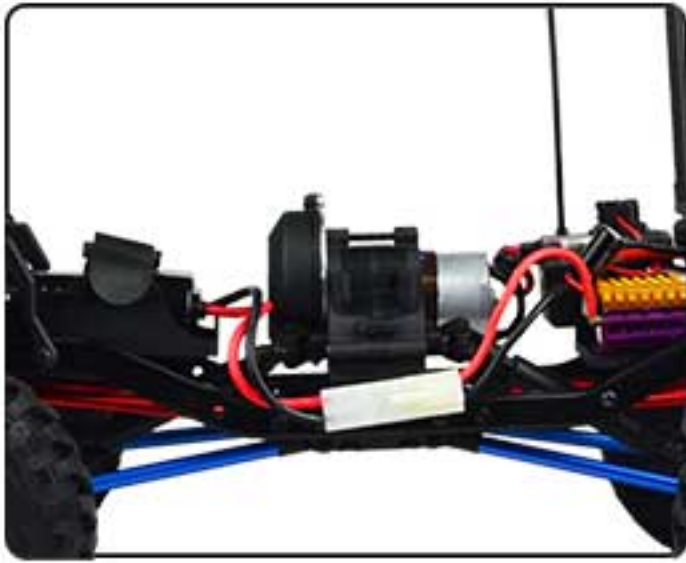

---

## Charging/Installing the Battery.

Always store your model with the battery pack unplugged and removed. Always charge your battery away from the vehicle. The included 300mAh mains charger will take approx 6 hours to charge a fully discharged battery, but always remove it from the charger if it becomes warm to the touch. Always disconnect the charger from the mains supply and the battery pack when not in use. Keep children away from charger and battery during the charging process.

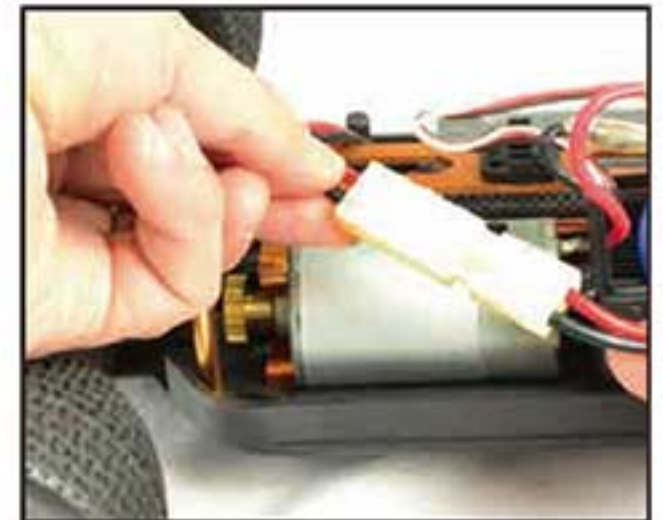
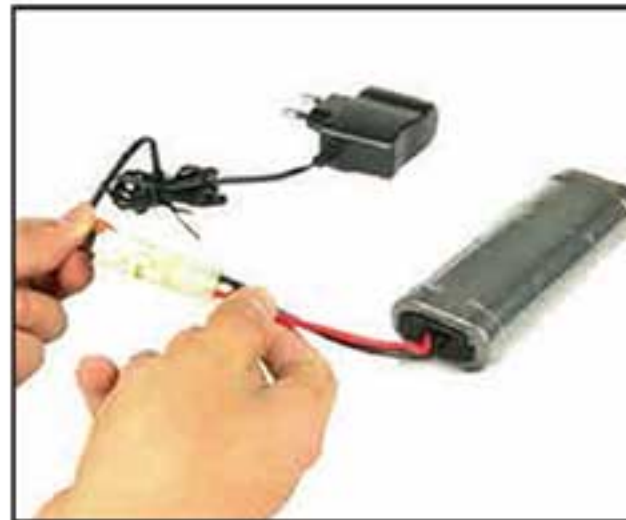

To install a charge battery, firstly remove the body shell and insert the battery into the fasten the two Velcro straps to fix the battery stably. When connecting battery and turning car on, ensure it is off ground with wheels away from objects away from objects

---

### Notes on Battery use:

Always allow the battery cool after use, before recharging.

Always inspect the battery before charging.

Any bare wires, split heat shrink or leakage is a sure sign of abuse.

Never attempt to charge dead or damaged batteries.

Do not disassemble the battery or cut the connector wires.

If the battery connector, battery case or cable insulation get hot enough to melt or split there is most likely a serious problem with your model, battery wires or speed controller. Find and correct the problem before installing another charged battery pack.

NEVER charge the battery unattended in case of overcharging, you need to be able to monitor the battery during charging.

Charge away from flammable objects and on a non-flammable surface in case the battery becomes too hot.

---

## Getting Started

Refer to 2.4ghz binding manual for radio set-up.

Switch on transmitter

Hold vehicle clear of the ground, connect battery pack and switch on receiver.

Test the transmitter to check control of the vehicle with wheels off the ground.

Start driving slowly and if the vehicle does not go straight, adjust steering trim dial on Transmitter.

For the very first run use the throttle gently, to help the driver become accustomed to the vehicles behaviour and controls.

Although this vehicle features waterproof electronics they are not designed to be submerged in water. Potential damage can still occur to vehicles components if you do so.



## After Run.

Switch off the receiver power, switch off the transmitter. Disconnect the battery and remove it from the vehicle, allow it to cool before recharging. If you have a second charged battery all ready to use, still allow the vehicle to cool slightly before continuing.

## Regular maintenance.

**Frequently check the whole vehicle for loose or missing fixings. Use thread lock on any replacement screws into metal threads.**

Frequently check rotating parts are free from grass, string etc. that might bind their motion and over stress the motor or speed controller. Remove the wheels occasionally and check behind the mounting hex for obstructions or anything that might have been wrapped around the axle and caused extra drag.

Check the gear mesh frequently and remove any stones or grit from gear teeth to prevent premature wear and damage.

If the motor moves, or is removed for maintenance/exchange, the gear mesh will need to be set. Simply slacken the motor retaining screws and adjust the motor until there is just discernable backlash between pinion and spur teeth. If the gear is too tight or too loose the gears will be noisy and could be damaged.

Shock absorbers will wear prematurely if used in dirty dusty conditions. Replace oil and seals as required to keep a smooth dampening action.



## Trouble shooting guide.

Short Runtime: Battery damaged/not charged. Motor dirty or brushes worn. Drivetrain binding.	Sluggish Action: Motor damaged. Bind in drive train. Battery running low on power.	Motor/ESC overheat: Over-gearred Binding transmission. Seized axle bearing. Motor binding.	Motor spins but vehicle refuses to move: Gears damaged. Gears loose on shaft. Magnets debonded from motor armature. Slipper clutch too loose. Drive shaft broken or missing.	Poor Range or fails to operate: Transmitter batteries low. Vehicle Battery Low. Transmitter switched off. Transmitter/receiver aerial not extended. ESC switched off or battery not connected. Loose connectors/wires. 2.4ghz binding with -receiver lost
---	---	--	---	--

## LIPO BATTERY-USER SAFETY AND HANDLING INSTRUCTIONS.

Read all safety instructions before charging or using your batteries for the first time.

Lipo batteries require completely different charging and care than Nicd and NIMH batteries. Misuse can result in fire, personal injury and/or damage to property. The buyer assumes all Liability and risk associated with the use of Lithium-Polymer (Li-Po) batteries. Immediately return the battery, unused, if you do not agree with these terms.



## **General guidelines and warnings:**

1. Use a Lithium Polymer specific chargers only! Do not use a NiCd or NiMH charger.
2. NEVER charge unattended. Always charge in safety sack or metal tin with lid and away from other flammable materials.
3. During the charge process watch for swollen or ballooning cells. If this happens immediately disconnect the charger and move the battery to a fire proof place for 15 minutes. Do not attempt to charge again.
4. A short circuit can cause a rapid discharge of high currents. Avoid short circuits, and be aware of short circuits on jewelery.
5. Any Lithium Polymer battery involved in a crash should be removed and observed in a fireproof space for 15 minutes before continuing to use or charge the battery.
6. If rewiring the battery pack, rewire the leads one at a time .Do not cut both leads. Do not short circuit on tools.
7. Do not expose battery packs to direct sunlight for extended periods.
8. Do not attempt to tamper with or open the LiPo Hardcase. The case is protection against possible battery swelling.

Before charging:

Visually inspect the pack checking for damaged leads, connectors, cracked heat shrink covering, swelling or other abnormalities. Do not charge if the pack is damaged.

## **Charging process:**

1. NEVER charge unattended.
2. Charge away from flammable materials and inside a Lipo safe sack or metal tin with lid.
3. Allow battery to cool before charging.
4. Use the battery label for setting charger cell count and voltage.
5. Do not exceed 5C MAX charge rate. (Example, charge a 1000mAH pack at 5A MAX)

If disposing of a Lipo battery proceed as follows:

Submerge the battery into a container filled with about 10 litres of salt water (one cup of salt in 10L). Leave the battery submerged for 2 weeks, this will slowly and safely discharge the battery until the voltage has dropped to zero volts which eliminates the risk of any chemical reaction. It can then be disposed off in the general waste collection.



# Oil Shocks (Bag A)

避震器

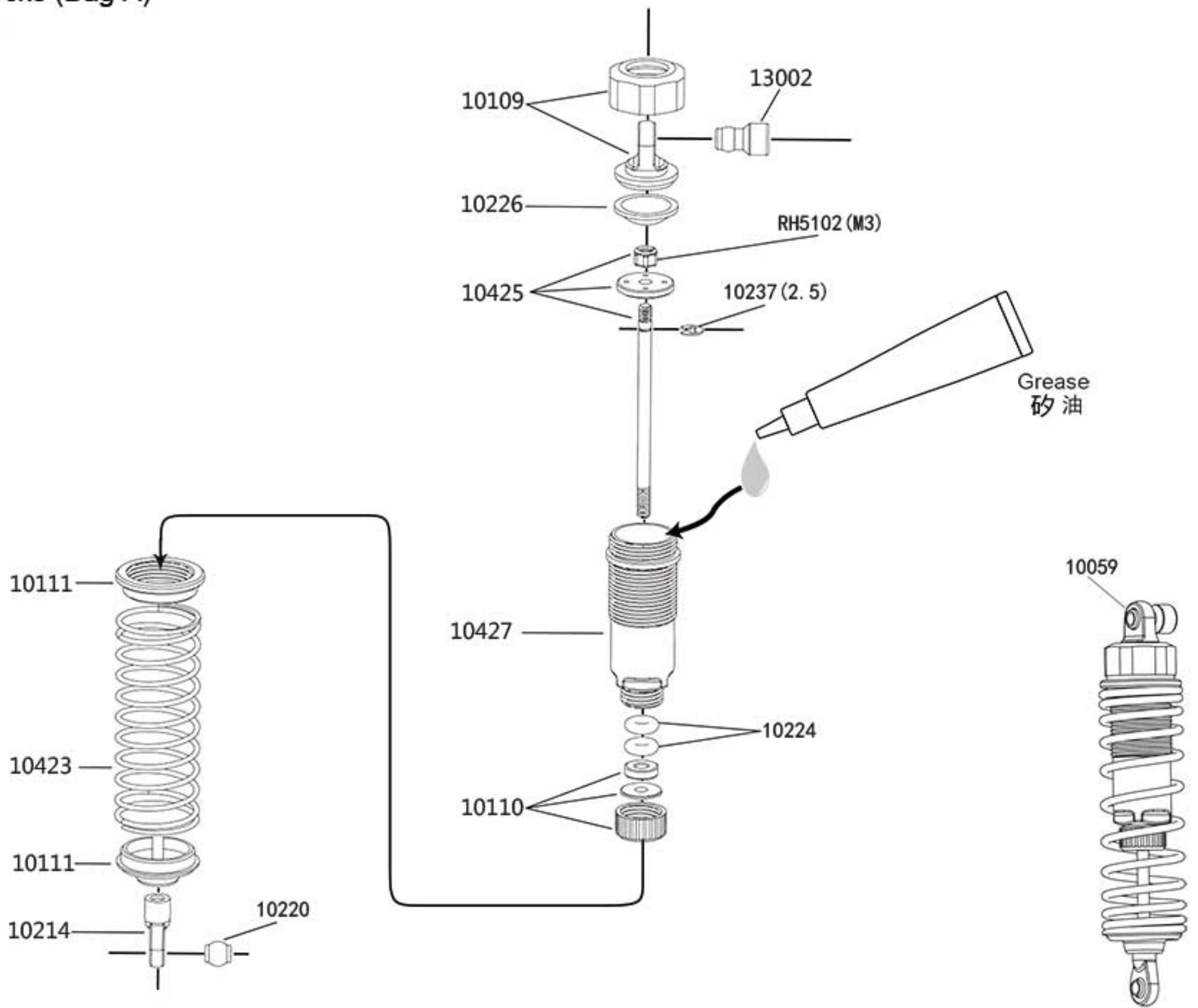

# Front/Rear Gearbox (Bag B)

锁定前后差速

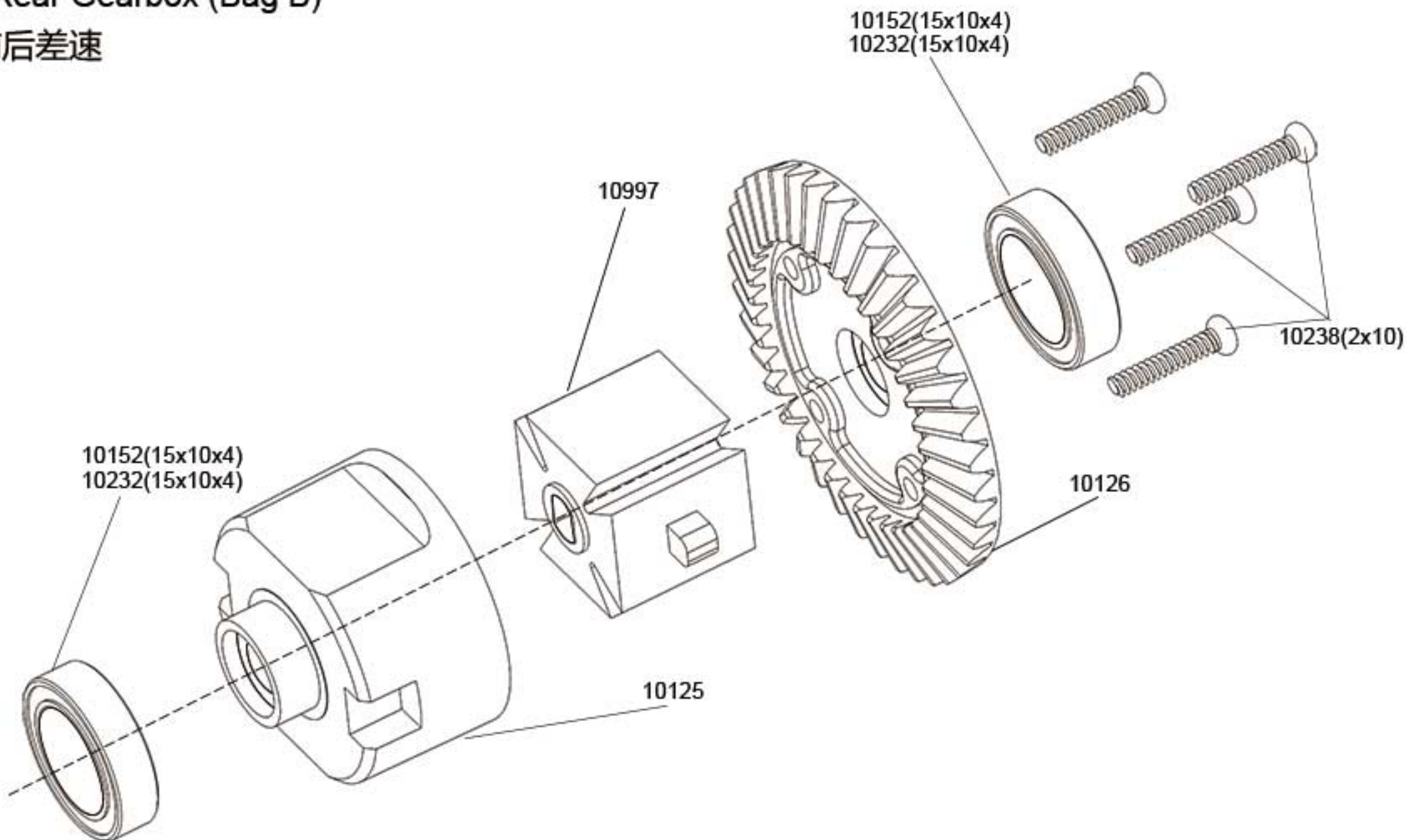



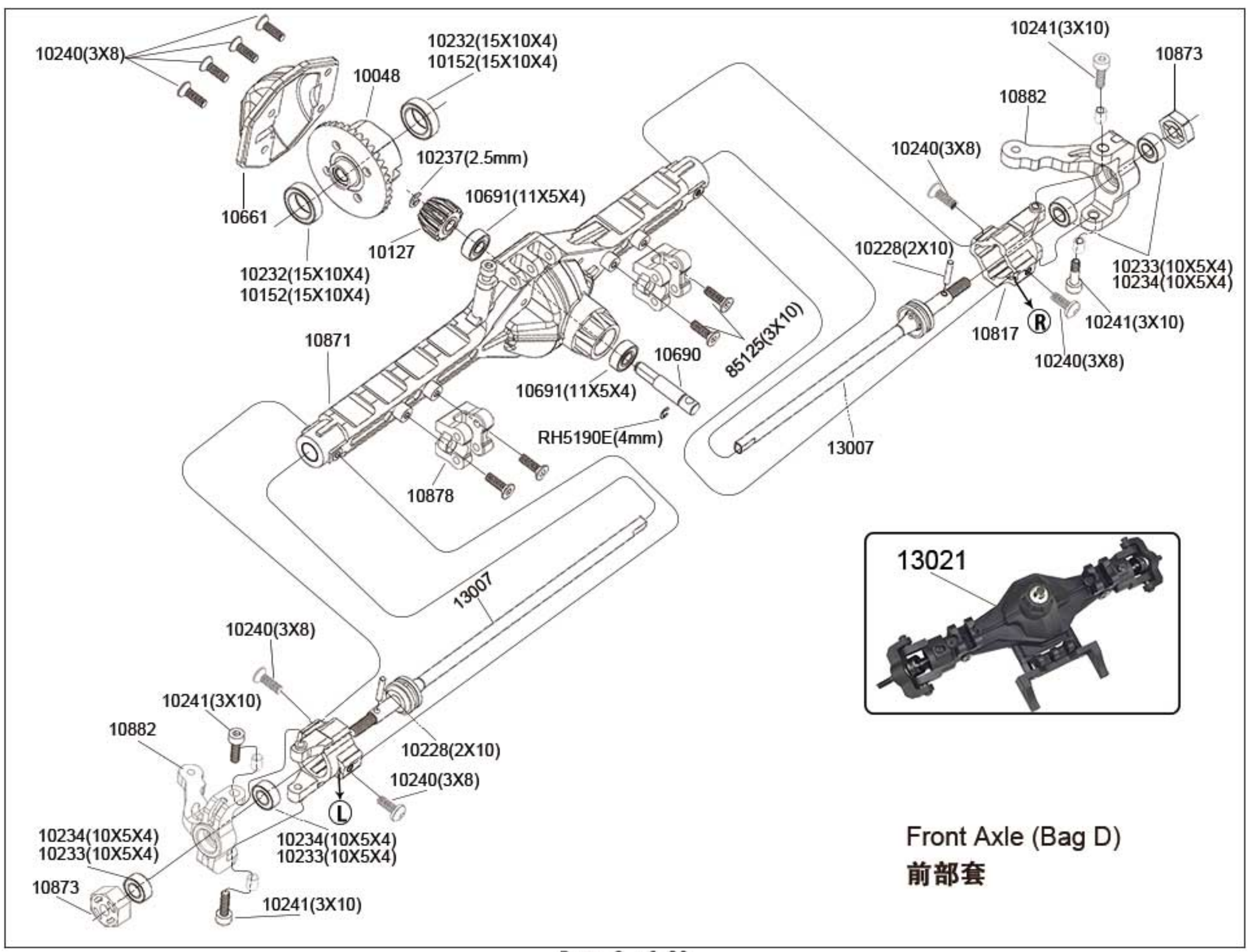
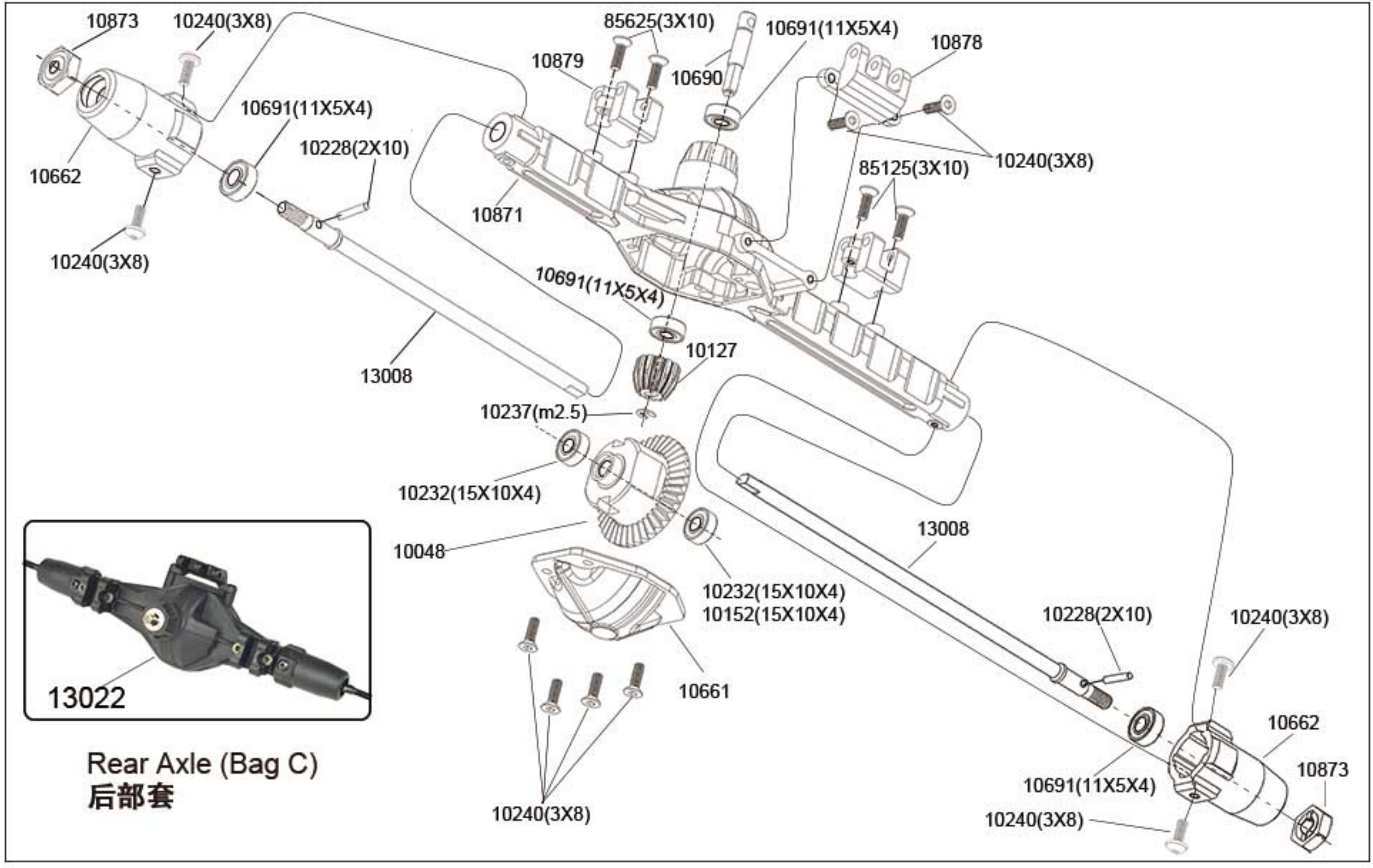



Linkages (Bag E)  
拉杆球头组装

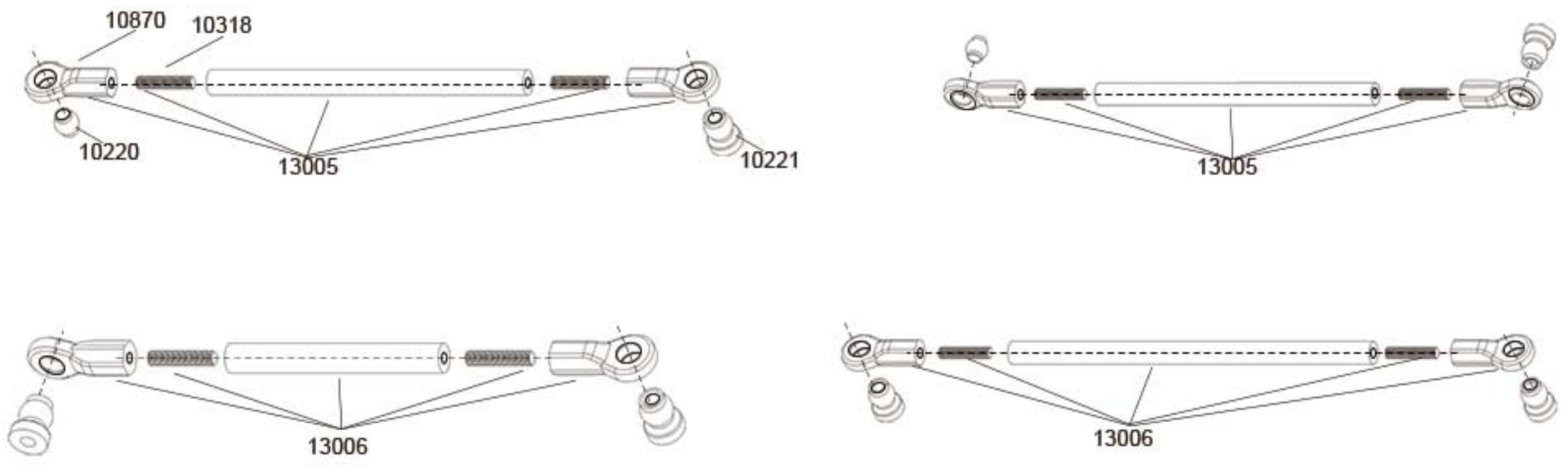

Steering Servo(Bag F)  
伺服器组装

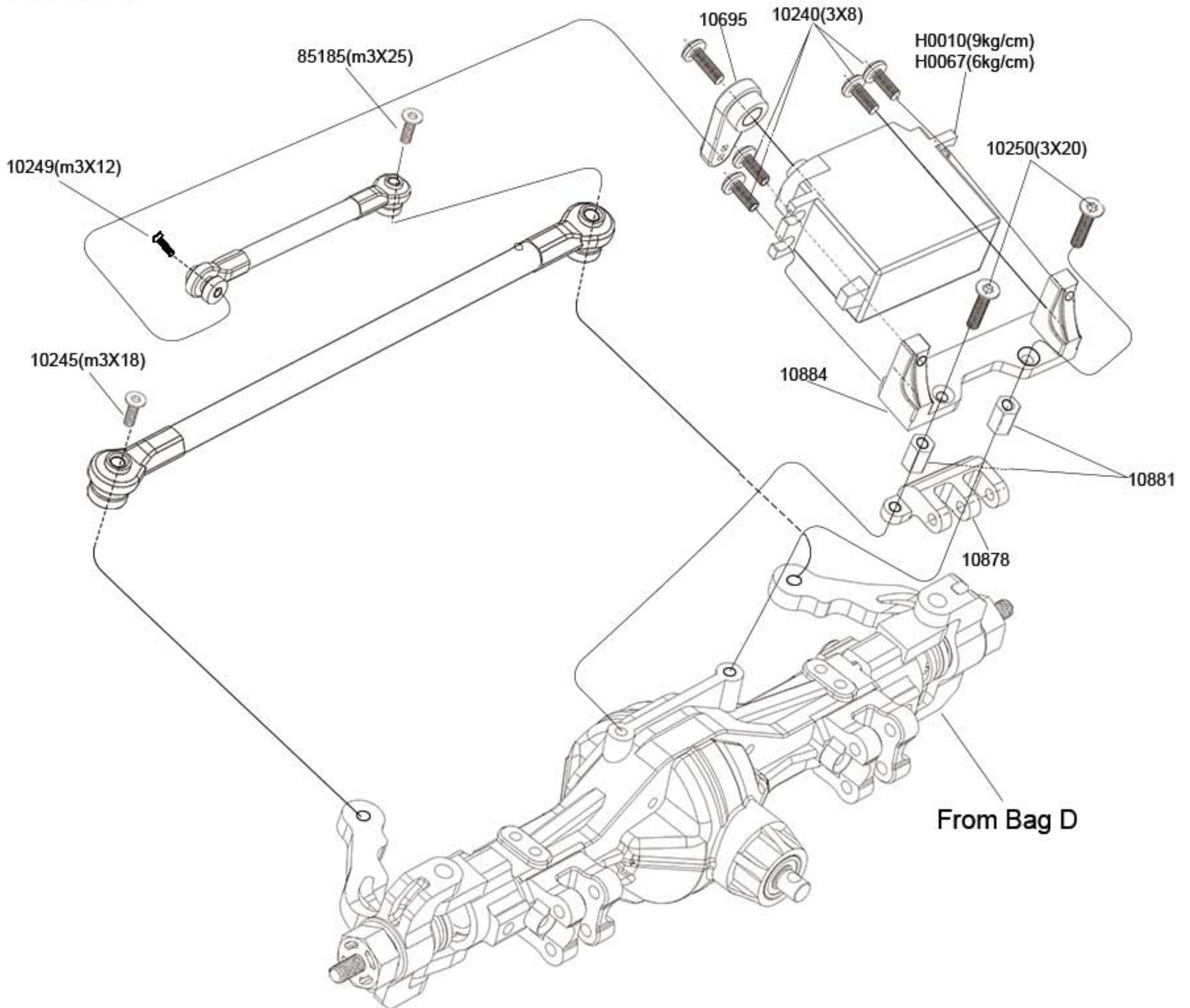



Chassis/Bumpers Assembly  
(Bag G)

车大梁/防撞板组装

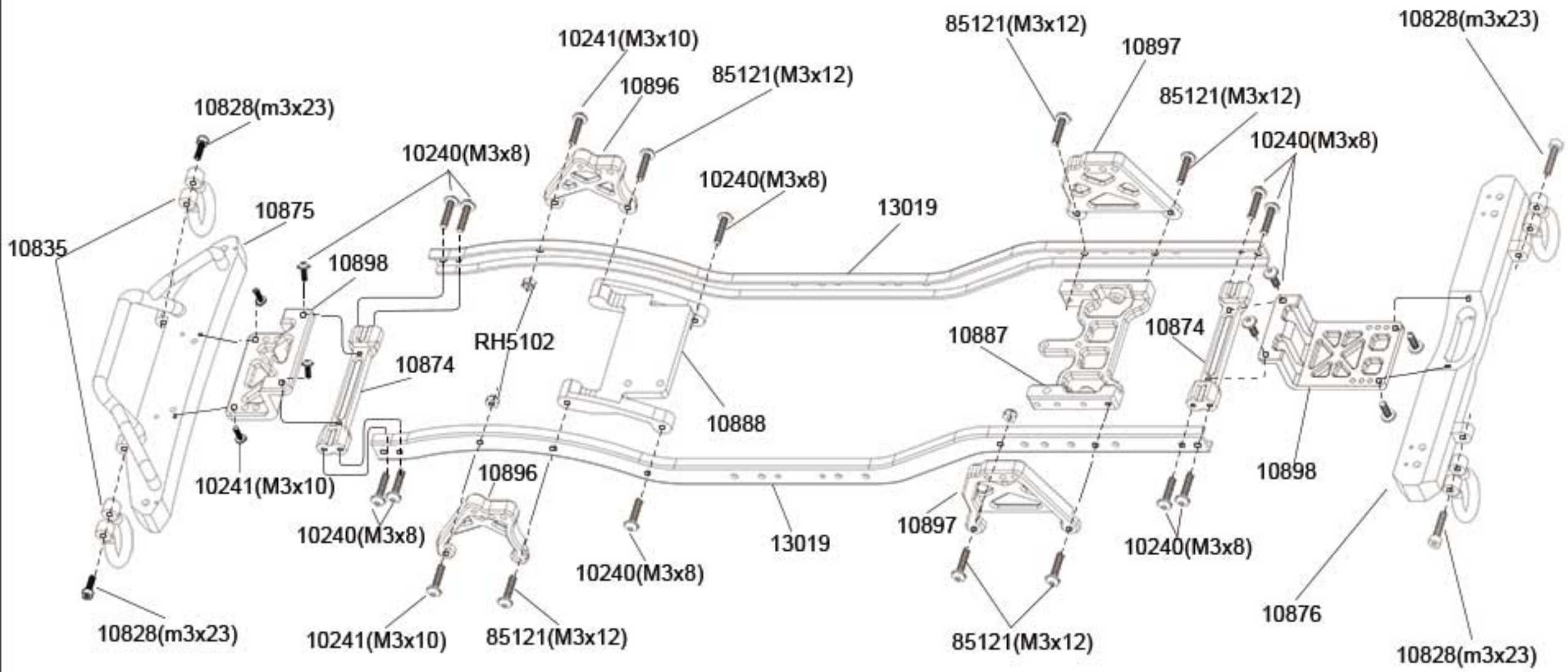

Central Diff Lock (Bag H)

锁定中差差速

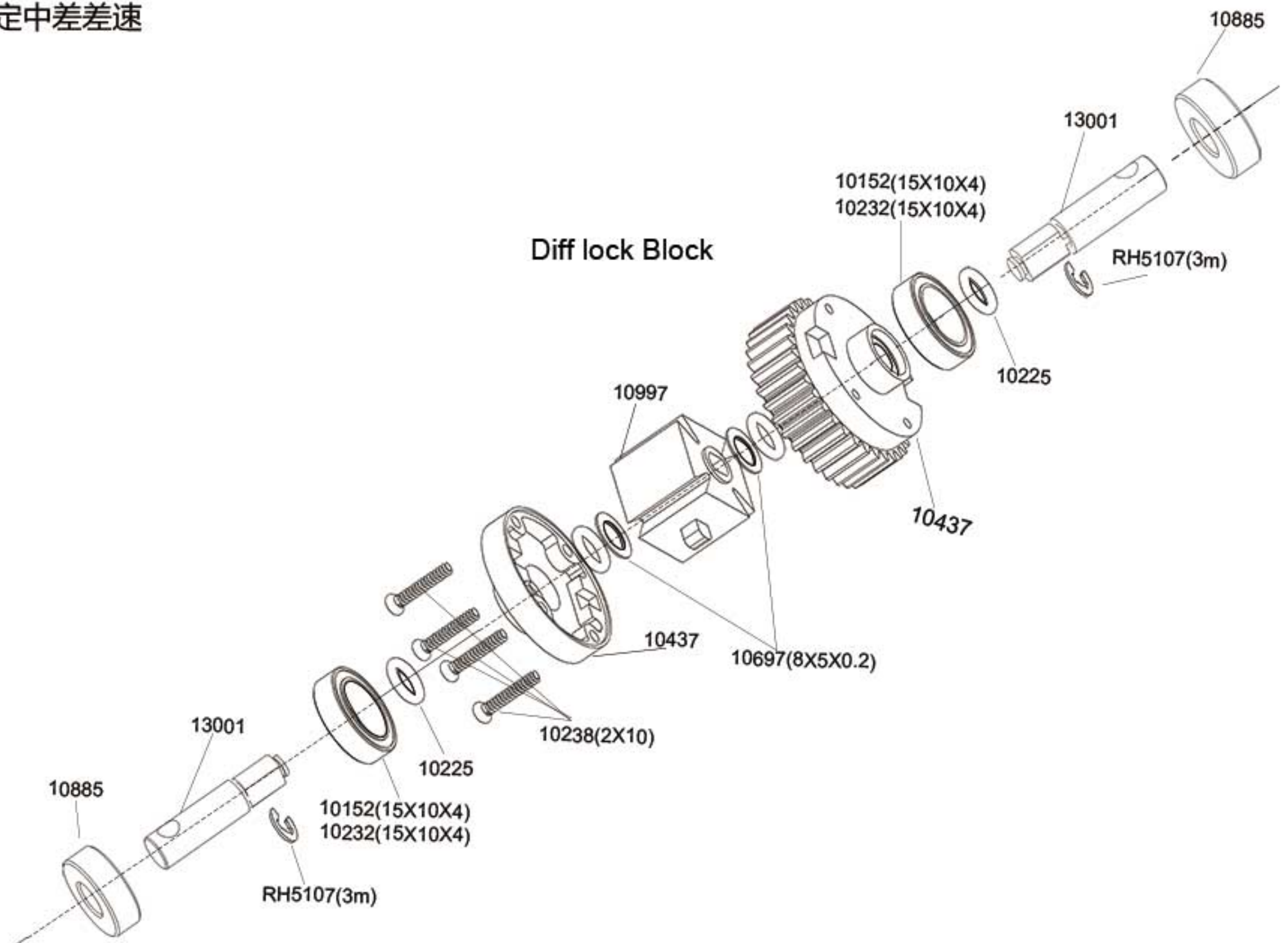



Centra Transmission I (Bag I)

中间齿轮箱组装

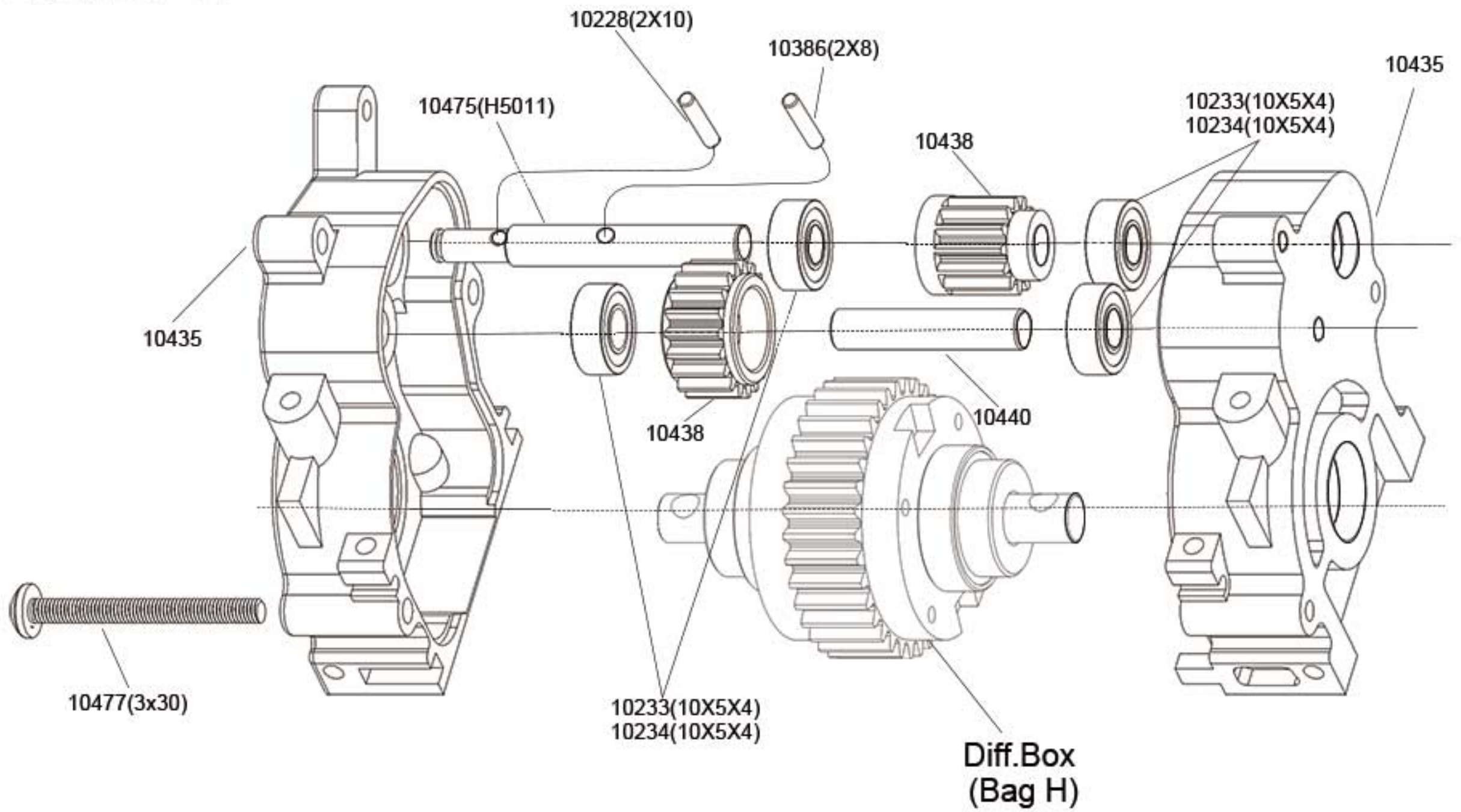

Motor Assembly (Bag J)

马达组装

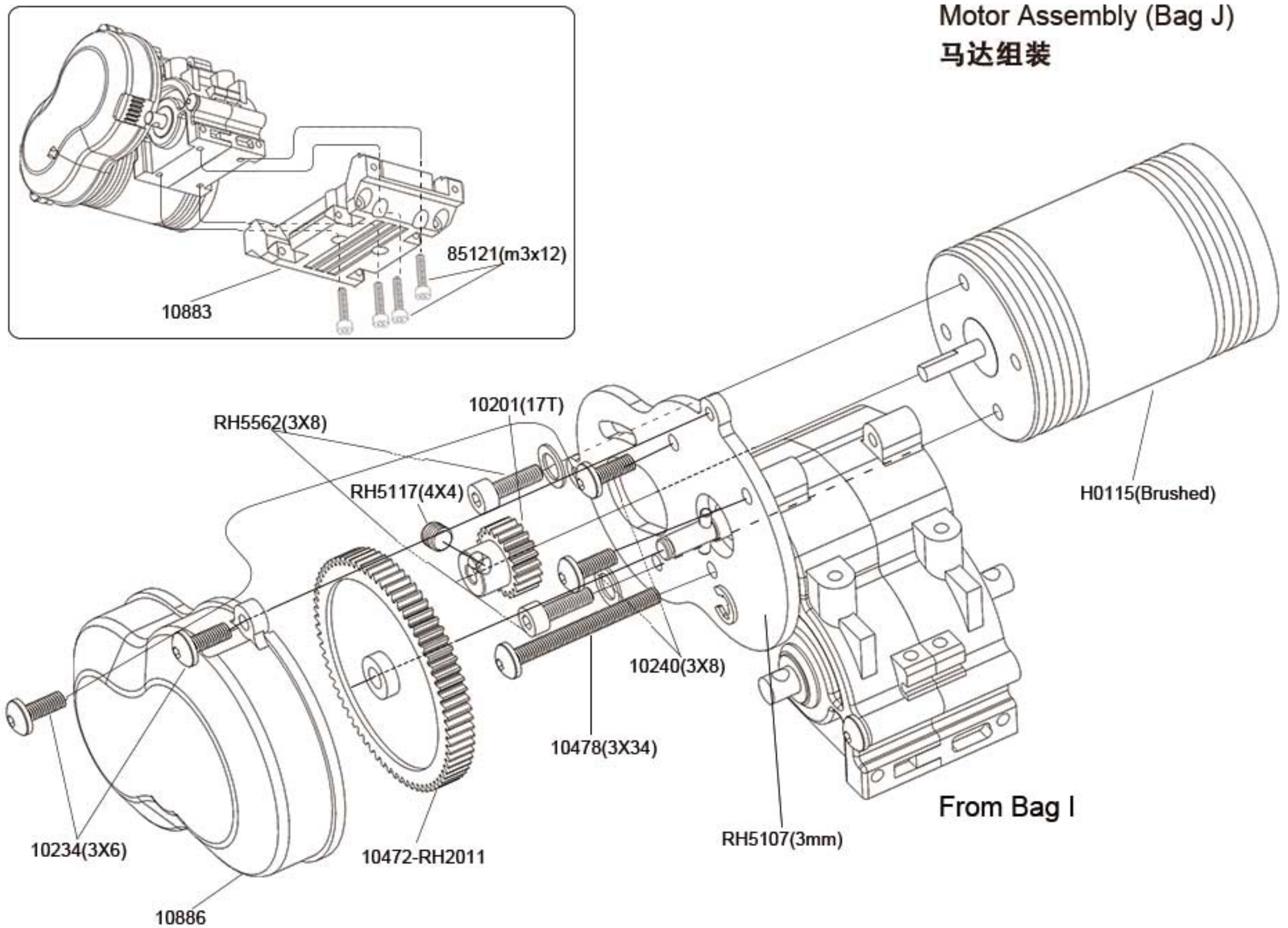



Battery Case, RX, Body Posts Assembly  
(Bag K)

电池盒、接收盒、车身支柱组装

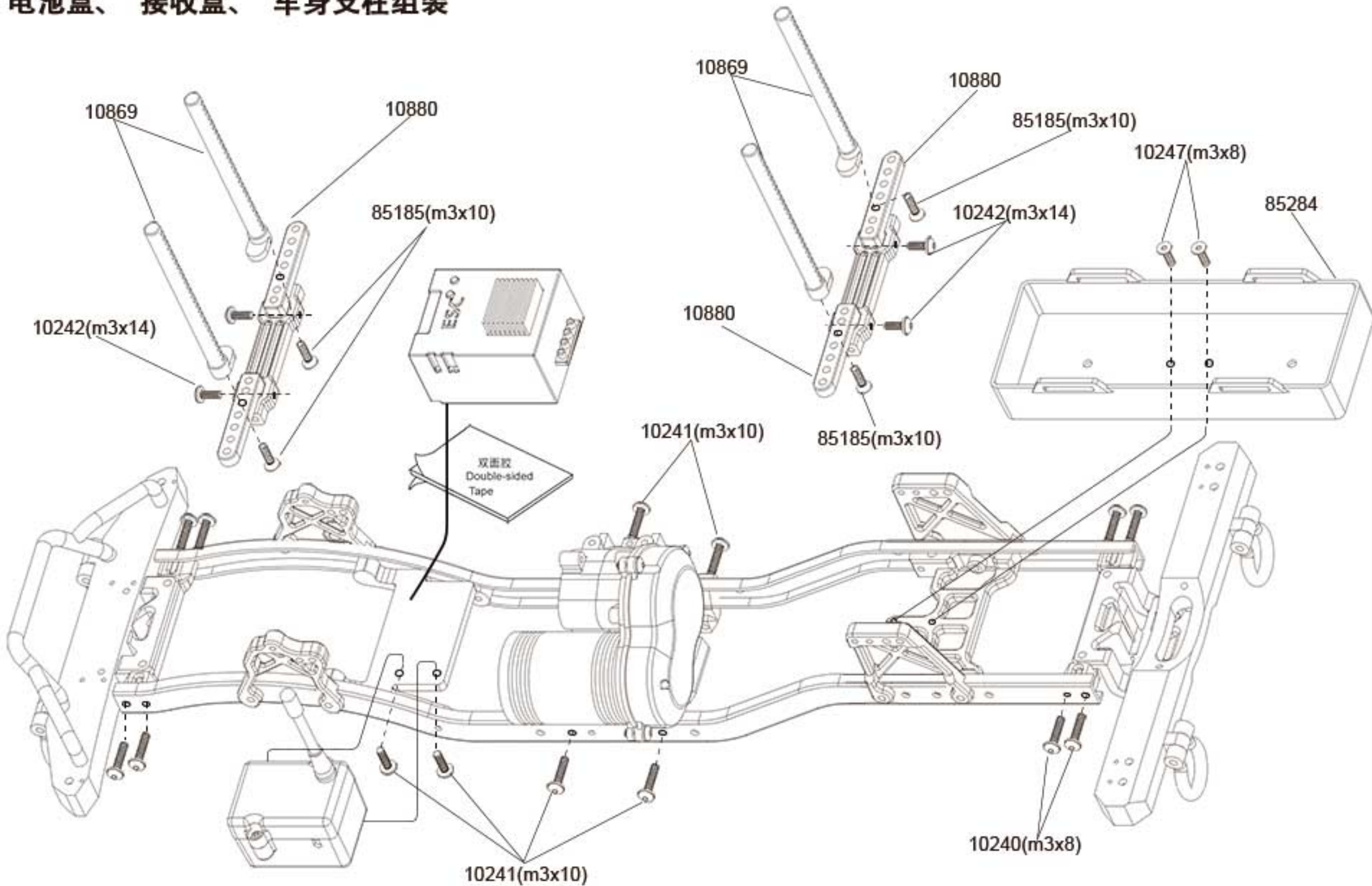

Oil Shocks Assembly  
避震器组装

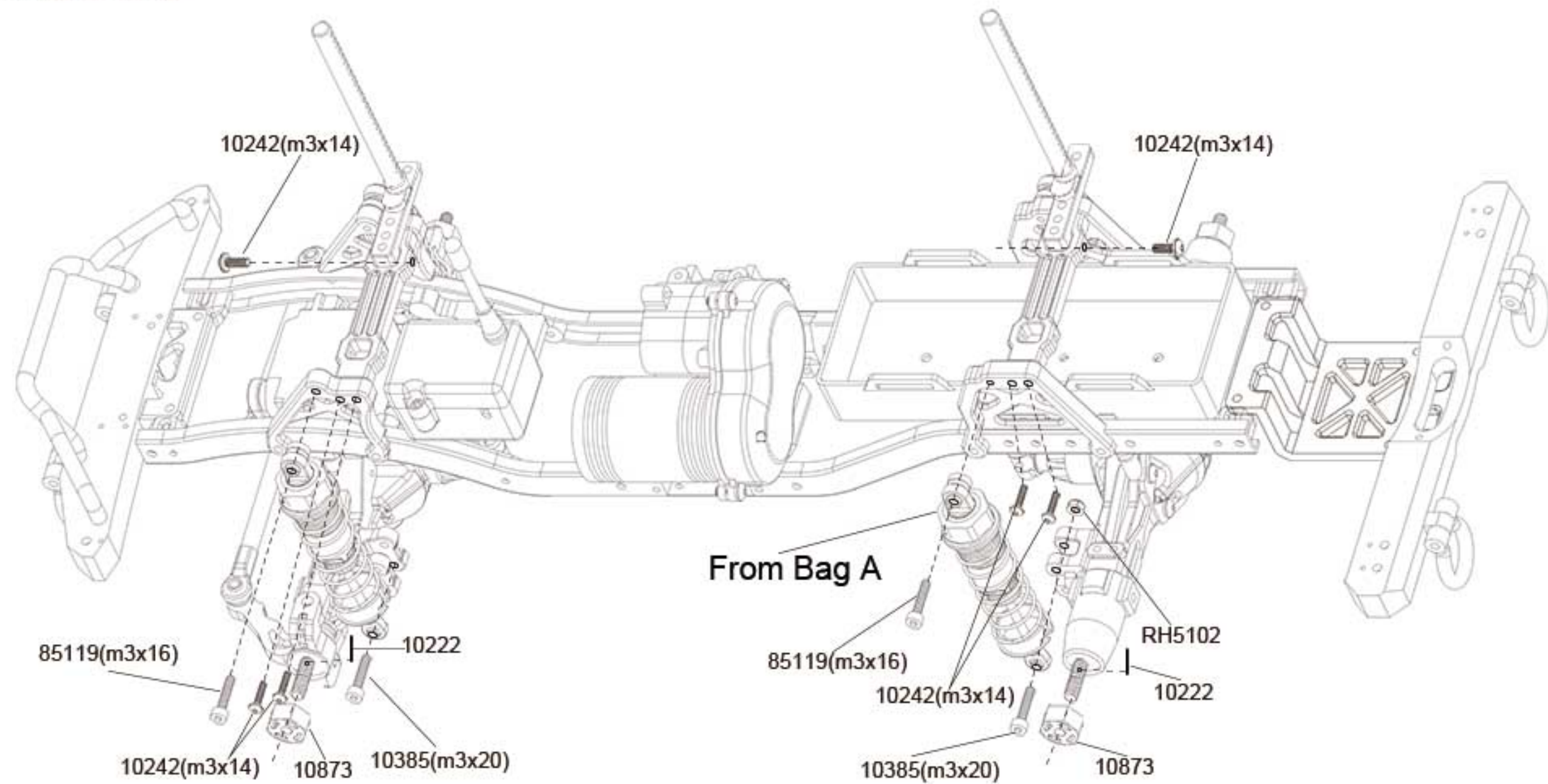



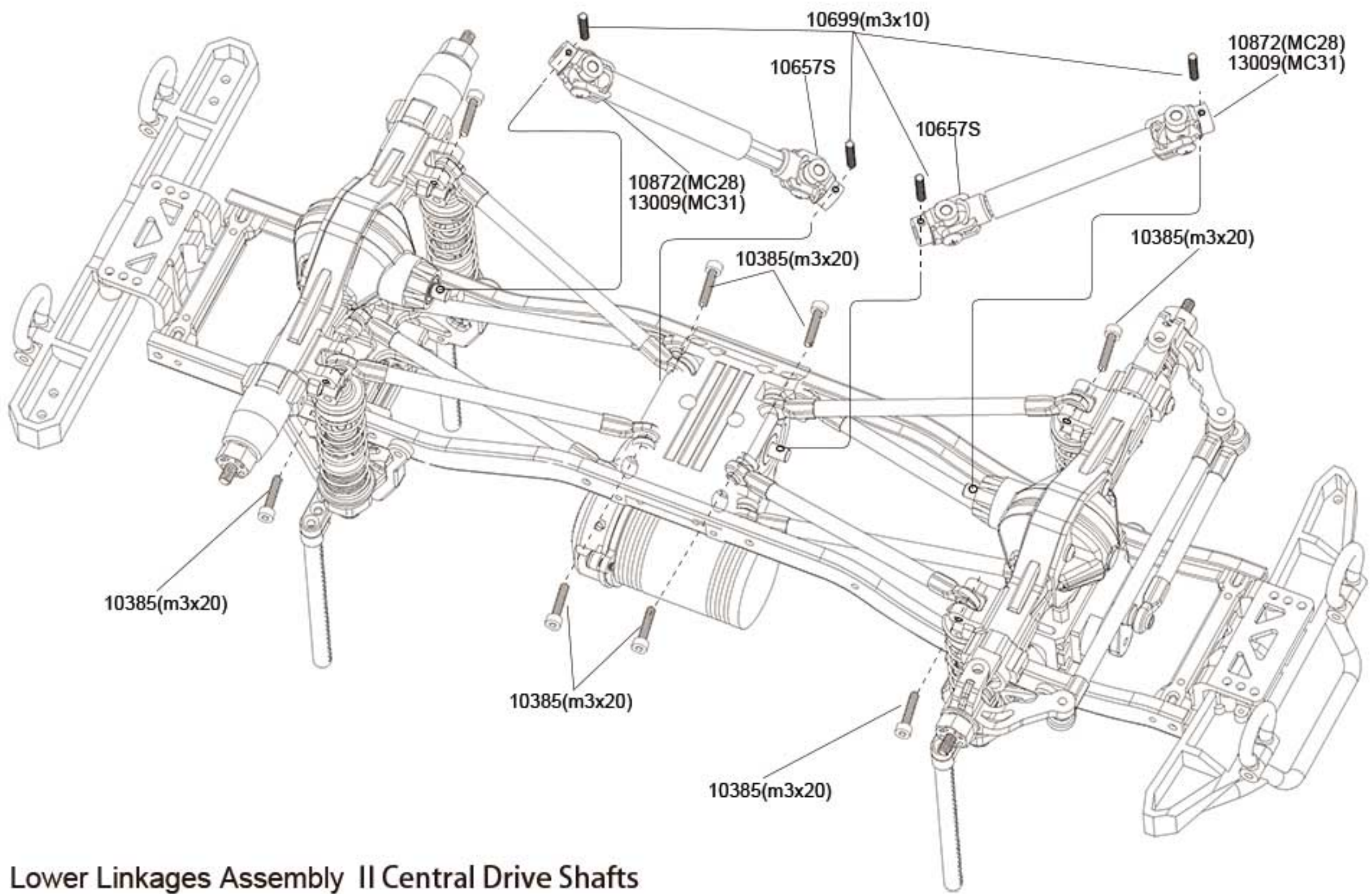

Lower Linkages Assembly II Central Drive Shafts  
(Bag L)

下拉杆组装

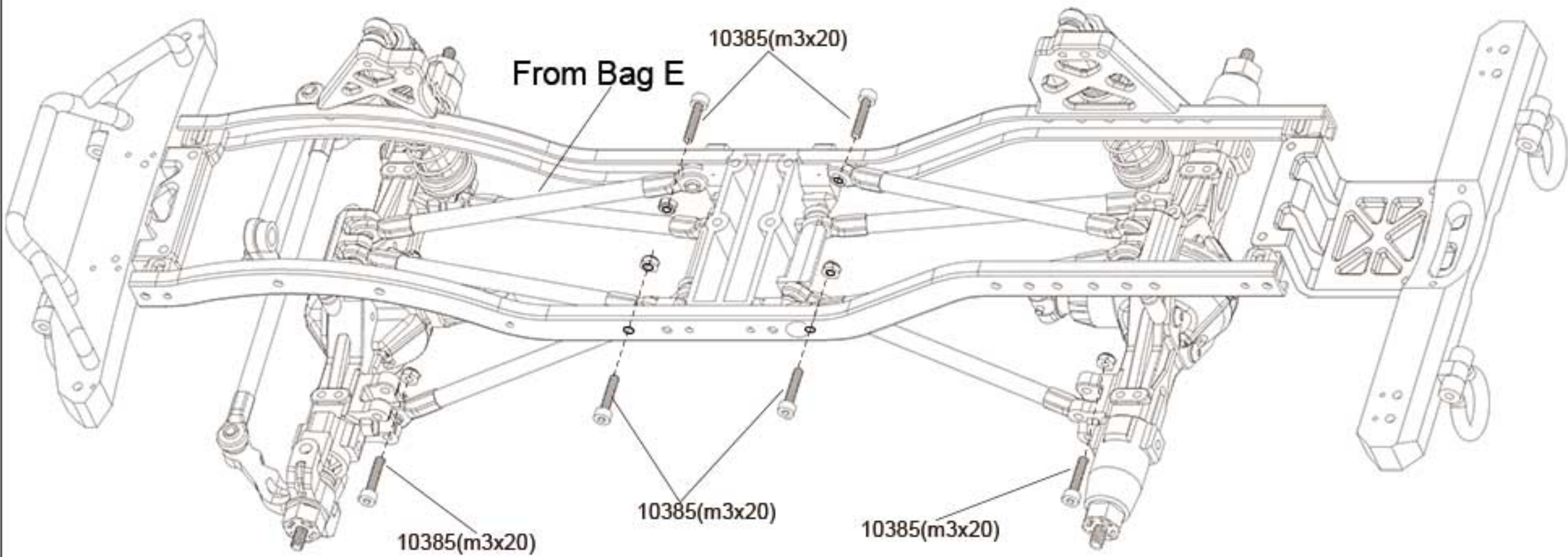

Upper Linkages Assembly  
上拉杆组装





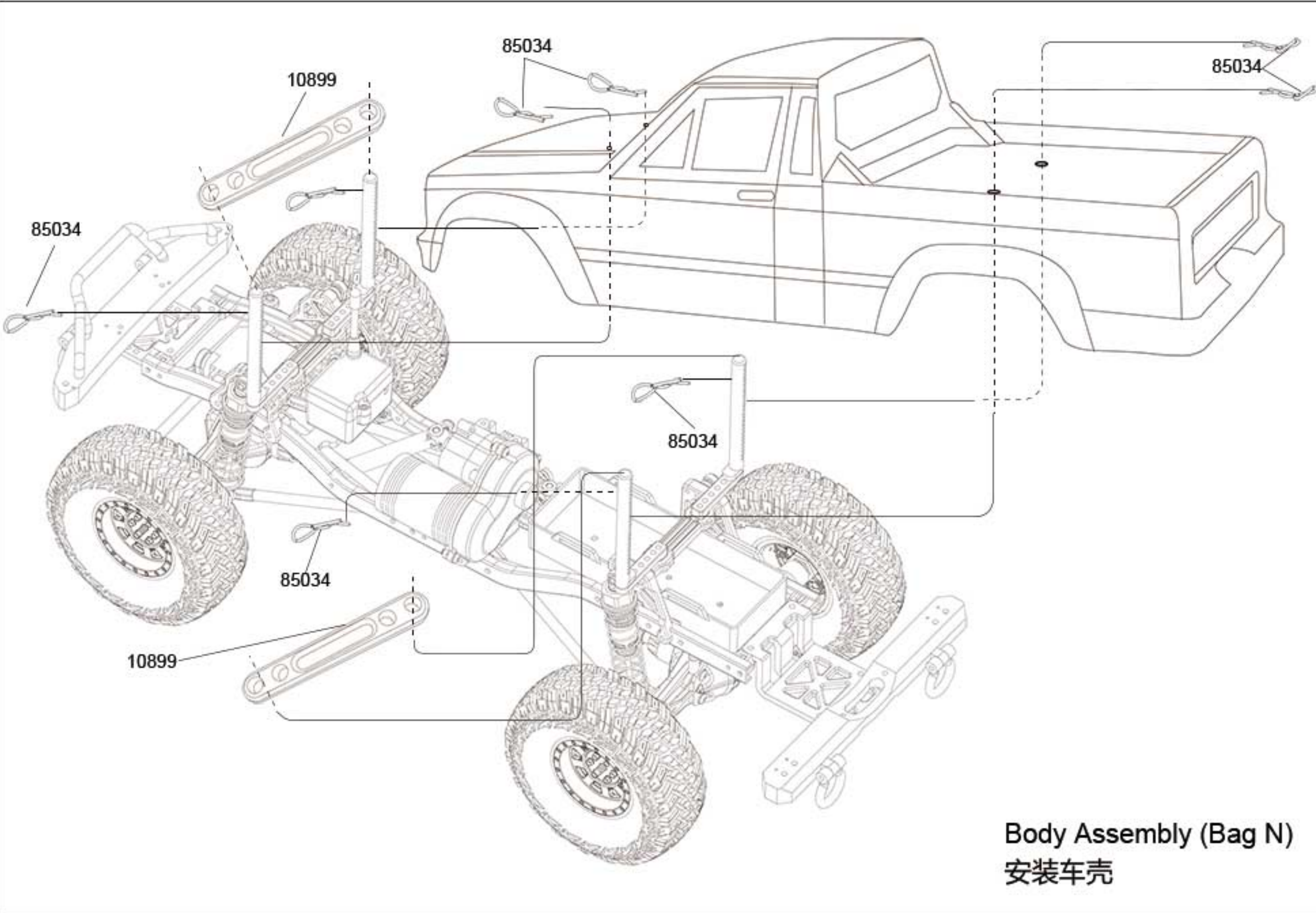
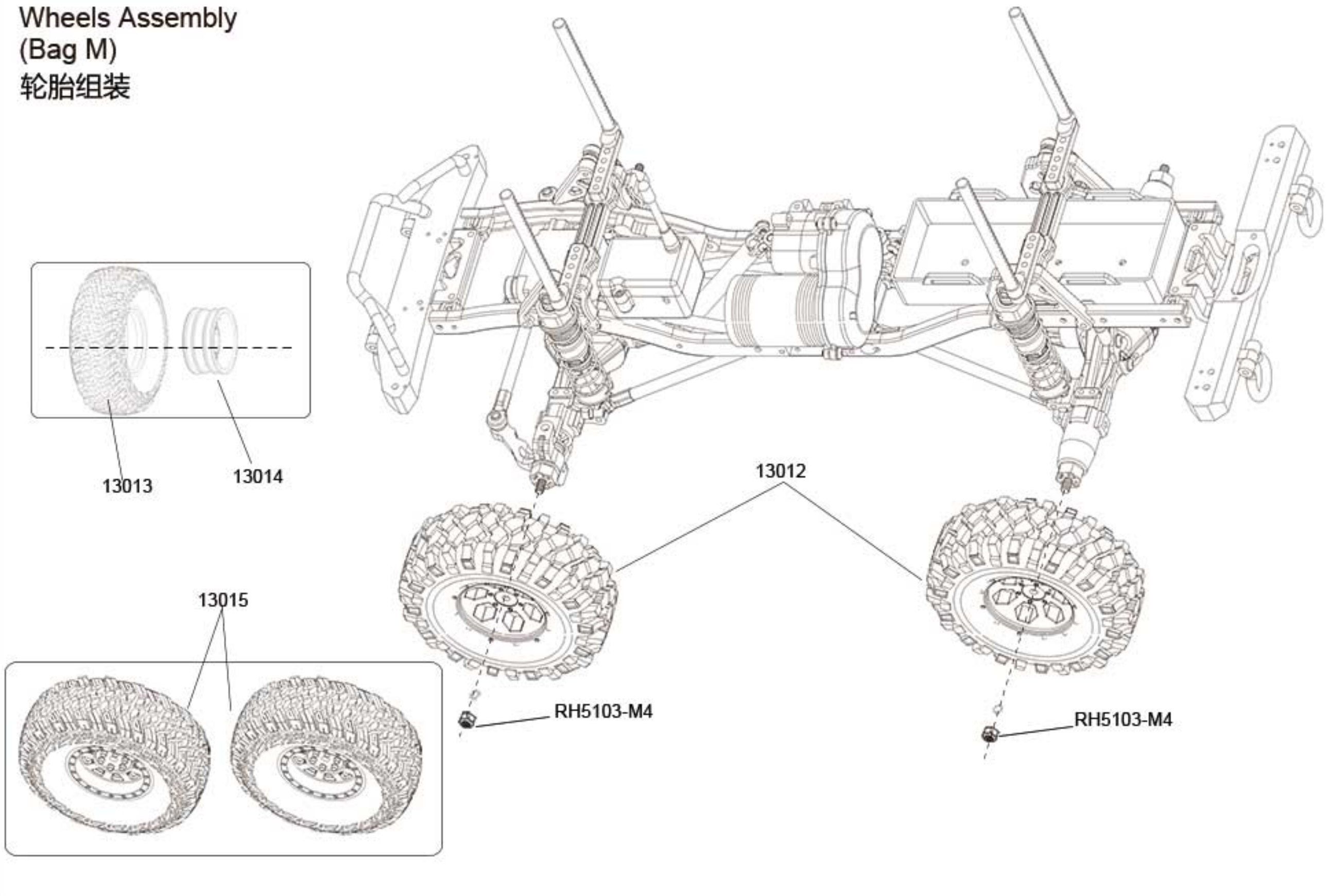













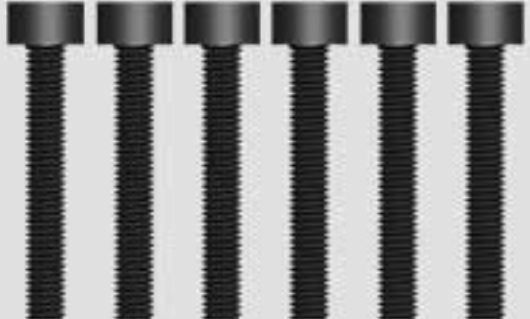



Wheels Assembly  
(Bag M)  
轮胎组装

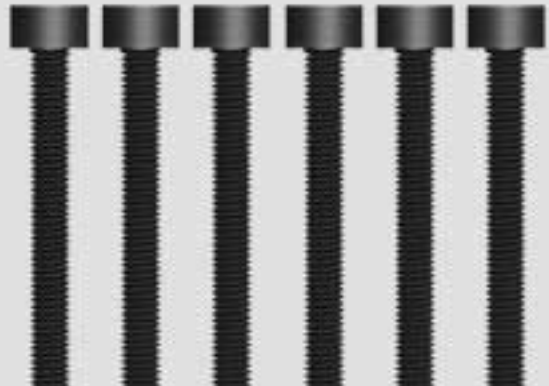
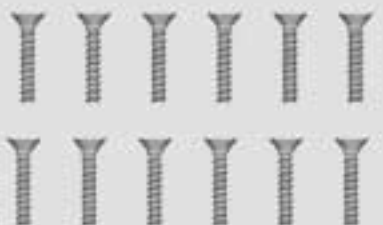

Body Assembly (Bag N)  
安装车壳

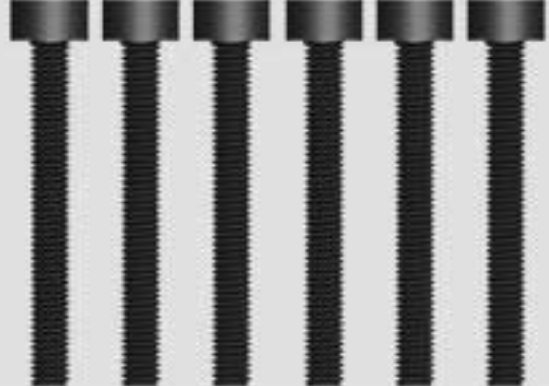















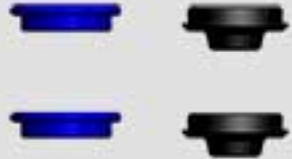



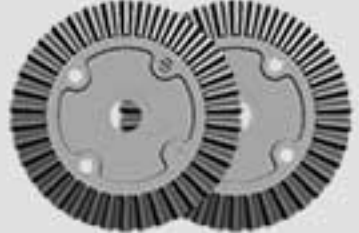



# Part List

<p>10238-Round Head Self Tapping Hex Screw 2*10 6pc</p> 	<p>85125-Flat Head Hex Screw M3*10 8pc</p> 	<p>10240-Button Head Hex Screw M3*8 6pc</p> 	<p>10241-Button Head Hex Screw M3*10 6pc</p> 
<p>10242-Button Head Hex Screw M3*14 6pc</p> 	<p>10699-Set Screw M3*10 6pc</p> 	<p>10244-Cap Head Hex Screw M3*14 6pc</p> 	<p>10245-Cap Head Hex Screw M3*18 6pc</p> 
<p>10247-Flat Head Hex M3*8 6pc</p> 	<p>10248-Flat Head Hex Screw M3*12 6pc</p> 	<p>10249-Flat Head Hex Screw M3*14 6pc</p> 	<p>10250-Flat Head Hex Screw M3*20 6pc</p> 
<p>10385-Cap Head Hex Screw M3*14 6pc</p> 	<p>10477-Button Head Hex Screw M3*30 6pcs</p> 	<p>10478-Button Head Hex Screw M3*34 6pcs</p> 	<p>85185-Cap Head Hex Screw M3*25 6pc</p> 
<p>85137-Flat Head Self Tapping Screw Set 3*10mm 12pc</p> 	<p>85182-Cap Head Hex Screw M3*10 6pc</p> 	<p>85184-Button Head Hex Screw M3*12 6pc</p> 	<p>10246-Cap Head Hex Screw M3*28 6pc</p> 
<p>10698-Flat Head Hex M3*6 6pc</p> 	<p>RH5562-Cap Head Hex Screw M3*8 6pc</p> 	<p>RH5117-Set Screw M4*4 6pc</p> 	<p>10828-Cap Head Hex Screw M3*23 6pc</p> 

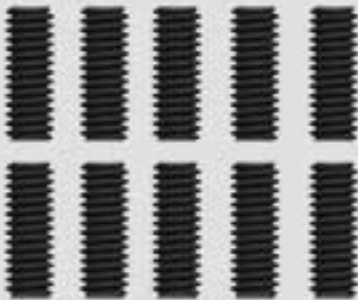

# Part List

<p>10657S-Central CVD Inner half With steel coupler 1set</p> 	<p>10871-Rear axle housing</p> 	<p>10661-Rear axle cover</p> 	<p>10662-Axle adaptor 2pcs</p> 
<p>85034-Body Clip (Medium Size) 6pcs</p> 	<p>10870-Ball end 10pcs</p> 	<p>10690-Rear diff shaft 1pc</p> 	<p>10111-Shock Lower holder &amp; Adjust Ring 2sets</p> 
<p>10109-Shock Upper Cap 2sets</p> 	<p>10110-Shock Lower Caps 2sets</p> 	<p>10125-Diff Case 2pcs</p> 	<p>10126-Diff Drive Spur Gear 2pcs</p> 
<p>10127-Diff Drive Gear 2pcs</p> 	<p>10835-Recue rings 4pcs</p> 	<p>RH5107-E clip-3mm 6pcs</p> 	<p>10472-70T Spur Gear 1pc (Brushed)</p> 
<p>10131-Washer 6pcs</p> 	<p>10881-Servo mount 2pcs</p> 	<p>10146-Antenna Pipe Set 2sets</p> 	<p>10475-Sliper shaft 1pc</p> 
<p>13018-Set screw M3*14mm 10pcs</p> 	<p>85119-Cap head scre set 3*16mm 6P</p> 	<p>10997-Upgrade Diff locker 1pc</p> 	<p>10691 Ball bearing (11*5*4mm) 6pc</p> 

















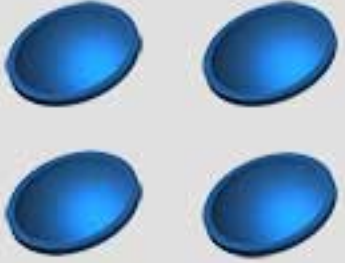





# Part List

<p>10152-Metal Bushing 15*10*4 6pc</p> 	<p>10161-Servo Horns</p> 	<p>10201-Pinion gear 17T 1pc</p> 	<p>10214-Shock Ball End 6pcs</p> 
<p>10416-Pinion gear 30T 1pc</p> 	<p>10435-Gearbox housing set 2pcs</p> 	<p>10437-Diff Case 2pcs</p> 	<p>10438-19T Gear 1pc</p>  <p>19T</p>
<p>10439-13T Gear 1pc</p>  <p>13T</p>	<p>10440-Gear shaft 1pc</p> 	<p>10442-Motor Mount 1pc</p> 	<p>RH5102-Nylon Lock Nut M3 6pc</p> 
<p>RH5103-Nylon Lock Nut-M4 6pc</p> 	<p>85284 Battery case</p> 	<p>85286 Velco Tape 2pcs</p> 	<p>10694-Pin <math>\phi</math> 2*13 6pcs</p> 
<p>13001-Central diff shaft 2pcs</p> 	<p>13002-Ball E 6pcs</p> 	<p>13006-Steering linkage rod L/S</p> 	<p>13007-Front CVD shaft 2pcs</p> 
<p>13008-Rear drive shaft 2pcs</p> 	<p>13019-Chassis steel frame rail set L/R</p> 	<p>H0104 - 540 Brushed Motor 1pc</p>  <p>60T</p>	<p>H0115-550 Brushed Motor 1pc</p>  <p>36T</p>



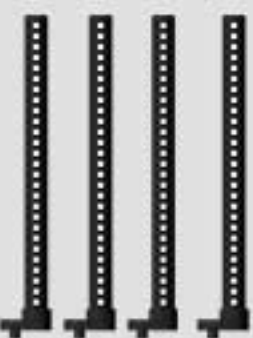
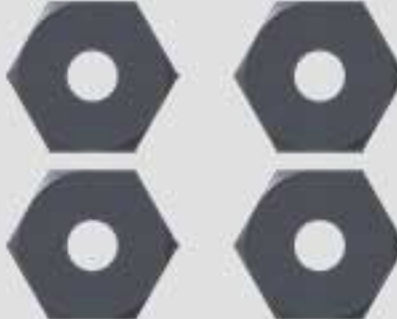





# Part List

<p>RH5190-E clip-4mm 6pc</p> 	<p>10237-E clip-2.5mm 6pc</p> 	<p>10220-Ball A 6pcs</p> 	<p>10221-Ball B 6pcs</p> 
<p>10222-Ball C 6pcs</p> 	<p>10224-Shock O-ring(Lower) 6pcs</p> 	<p>10225-Diff O-ring Seal 6pcs</p> 	<p>10226-Shock seal cover 4pcs</p> 
<p>10228-Pin <math>\phi</math>2*10 6pcs</p> 	<p>10232-Ball Bearing 15*10*4 6pcs</p> 	<p>10233-Ball Bearing 10*5*4 6pcs</p> 	<p>10234-Metal Bushing 10*5*4 6pcs</p> 
<p>10253 - 1/10 Charger CE 1pc 10254 - 1/10 Charger UL 1pc 10255 - 1/10 Charger BS 1pc</p> 	<p>85175-Button Head Hex. Tapping Screws 3*10 8pcs</p> 	<p>85285-RX case 1set</p> 	<p>H0010 - 9kg/cm Servo 1pc</p> 
<p>H0030-Ni-MH 7.2V 1800mAh 1pc H0031-Ni-MH 7.2V 3000mAh 1pc</p> 	<p>H0050-400A ESC 1pc</p> 	<p>H0067 - 6kg/cm Servo 1pc</p> 	<p>10817-Steering knuckle 2pcs</p> 
<p>10869-Body post 4pcs</p> 	<p>10873-Wheel Hub 4pcs</p> 	<p>10874-Steel frame rail link</p> 	<p>10875-Front bumper 1pc</p> 





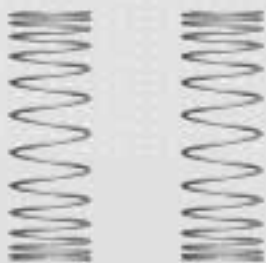

# Part List

<p>10876-Rear bumper 1pc</p> 	<p>10877-Body mount 2pcs</p> 	<p>10878-Upper linkage holder 2pcs</p> 	<p>10879-Lower linkage holder 2pcs</p> 
<p>10880-Body post adjusting plate 4pcs</p> 	<p>10882-Steering arm 2pcs</p> 	<p>10883-Central transmission bracket</p> 	<p>10884-Servo mount 1pc</p> 
<p>10885-Plastic ring 2pcs</p> 	<p>10886-Gear cover 1pc</p> 	<p>10887-Battery case support 1pc</p> 	<p>10888-RX box/ESC support 1pc</p> 
<p>10896-front shock mount L/R</p> 	<p>10897-rear shock mount L/R</p> 	<p>10898-bumper bracket F/R</p> 	<p>10899-body post fixplate 2pcs</p> 
<p>13005-lower linkage rod 2pcs</p> 	<p>13013-Soft crawlertyre/foam 2pcs</p> 	<p>13014-Crawler rim 2pcs</p> 	<p>13015-Complete wheel 2pcs</p> 
<p>13009-Central CVD outer half set</p> 			
<p>10059-Rear Shock Tower 2pc (Al)</p> 	<p>10423-Rear Shock Spring 2pcs</p> 	<p>10425-Rear Shock Shaft &amp; Piston Set 2sets</p> 	<p>10427-Rear Shock body 2pc (Al)</p> 

























# Part List

<p>13021-Front Axle set</p> 	<p>13022-Rear Axle Set</p> 	<p>R0280-Rambler Painted body 1pc (Red)</p> 	<p>R0281-Rambler Painted body 1pc (Orange)</p> 
<p>R0282-Rambler Painted body 1pc (Blue)</p> 	<p>R0286-Varanus clear body 1pc</p> 		







# Upgrade Part List

<p>10850-Bungee Cord 2pcs</p> 	<p>10986-Axle adaptor (Al)</p> 	<p>10989-Alum rear Axle</p> 	<p>11009-Steering knuckles Al. 2pcs</p> 
<p>11016-Central CVD coupler 2pcs (steel)</p> 	<p>11029-Rear Axle housing (Al) 1pc</p> 	<p>11030-Rear Link holder (Al) 1pc</p> 	<p>11031-Rear holder for rear shock support (Al)</p> 
<p>11032-Alum steering arm 2pcs</p>  <p>RH1001/RH1002/RH1011/RH1013</p>	<p>11033-Servo mount Alum. 1pc</p> 	<p>11034-MC28 Alum Shock 2pcs</p> 	<p>11035-MC31 Alum Shock 2pcs</p> 
<p>11040-Alum Battery Case Support 1pc</p> 	<p>11037-Alum Rear Bumper</p> 	<p>11038-Alum Gearbox Housing Set 2pcs</p> 	<p>11039-Alum RX Box/ESC Support 1pc</p> 
<p>11041-Alum Centra Transmission Bracket 1pc</p> 	<p>11042-Alum Steel Frame Rail Link 2pcs</p> 	<p>11043-Alum Body post 4pcs</p> 	
<p>11044-Alum Servo mount 2pcs</p> 	<p>11048-MC31 Alum front shock mount L/R</p> 	<p>11049-MC31 Alum rear shock mount F/R</p> 	<p>11050-MC31 Alum bumper bracket F/R</p> 



# Upgrade Part List

<p>11052-Alum Steel frame rail link</p> 	<p>11053-Alum Chassis steel frame rail set L/R</p> 	<p>13016-Crawler rim 2pcs</p> 	<p>13017-Complete wheel 2pcs</p> 
<p>H0108-Winches 1set</p> 