



Terminal Technologies (I) Pvt. Ltd



Making the right connections

CATALOGUE

PRODUCT FINDER

Connectors

Sr. No.	Part No.	Page No.	Sr. No.	Part No.	Page No.
1	TTP-010FN	25	70	TTP-22FH	30
2	TTP-010MN	25	71	TTP-22FN	30
3	TTP-012FN	25	72	TTP-22FNA	42
4	TTP-012MN	25	73	TTP-22MN	30
5	TTP-018FN	25	74	TTP-22MNA	42
6	TTP-018MN	25	75	TTP-22MNB	42
7	TTP-01SL	41	76	TTP-22MNC	42
8	TTP-020FN	26	77	TTP-22MND	42
9	TTP-020MN	26	78	TTP-22MNE	42
10	TTP-02FN	24	79	TTP-22MNF	42
11	TTP-02FN(WS)	26	80	TTP-22MNG	42
12	TTP-02MFB	38	81	TTP-22MNR	42
13	TTP-02MN	24	82	TTP-22RFN	32
14	TTP-02MN(WS)	26	83	TTP-22RMN	32
15	TTP-02SL	41	84	TTP-23CP	38
16	TTP-03SL	41	85	TTP-23FB	37
17	TTP-04FN(WS)	26	86	TTP-23FC	38
18	TTP-04MN(WS)	26	87	TTP-23FN	30
19	TTP-04SL	41	88	TTP-23FNH	32
20	TTP-05SL	41	89	TTP-23MN	30
21	TTP-06FB-MB	36	90	TTP-24FN	30
22	TTP-06FN	24	91	TTP-24MN	30
23	TTP-06FN(WS)	26	92	TTP-24MNA	43
24	TTP-06MFB	38	93	TTP-24MNB	43
25	TTP-06MN	24	94	TTP-24MNC	43
26	TTP-06MN(WS)	26	95	TTP-24MND	43
27	TTP-073MN	24	96	TTP-24MNF	43
28	TTP-078FN	24	97	TTP-24MNG	43
29	TTP-078MN	24	98	TTP-2625	40
30	TTP-07HFN	54	99	TTP-2676	40
31	TTP-07HMN	54	100	TTP-26FN	31
32	TTP-08FN	25	101	TTP-26MN	31
33	TTP-08MFB	38	102	TTP-26MNA	43
34	TTP-08MFC	38	103	TTP-2827	40
35	TTP-08MN	25	104	TTP-2860	56
36	TTP-08TL	40	105	TTP-2861	56
37	TTP-12FN	27	106	TTP-2868	37
38	TTP-12MN	27	107	TTP-28FN	31
39	TTP-12MN-RIB	27	108	TTP-28MN	31
40	TTP-12MNS	27	109	TTP-28MNA	43
41	TTP-13FN	27	110	TTP-28MNB	43
42	TTP-13MN	27	111	TTP-2904	31
43	TTP-13MN-RIB	27	112	TTP-2910	56
44	TTP-14FB	36	113	TTP-2931	56
45	TTP-14FC	36	114	TTP-2959	56
46	TTP-14FN	27	115	TTP-2SSC	54
47	TTP-14MN	27	116	TTP-31FN	32
48	TTP-14MN-RIB	28	117	TTP-31FN(CL)	33
49	TTP-1638A	37	118	TTP-31MN	32
50	TTP-1638B	37	119	TTP-31MN(CL)	33
51	TTP-1638C	37	120	TTP-32FN	33
52	TTP-1657	31	121	TTP-32FN(RIB)	33
53	TTP-16FN	28	122	TTP-32MAX	37
54	TTP-16MN	28	123	TTP-32MN	33
55	TTP-16MN-RIB	28	124	TTP-32MN(RIB)	33
56	TTP-1818	37	125	TTP-38FN	31
57	TTP-1820	56	126	TTP-38FN-L	31
58	TTP-1832	56	127	TTP-3904	32
59	TTP-1855A	50	128	TTP-4638	37
60	TTP-1868P	36	129	TTP-4868	37
61	TTP-1903	36	130	TTP-4868H	37
62	TTP-1903A	36	131	TTP-4902	40
63	TTP-1904	31	132	TTP-6FB	36
64	TTP-1960	32	133	TTP-6FC	36
65	TTP-19FN	28	134	TTP-8902	40
66	TTP-19MN	28	135	TTP-9902	41
67	TTP-19MN-RIB	28	136	TTP-BASE	54
68	TTP-21FN	30	137	TTP-C07	58
69	TTP-21MN	30	138	TTP-C08	59

PRODUCT FINDER

Connectors

Sr. No.	Part No.	Page No.	Sr. No.	Part No.	Page No.
139	TTP-C09	59	172	TTP-RB2	46
140	TTP-C10	58	173	TTP-RB21	47
141	TTP-C13	58	174	TTP-RB3	46
142	TTP-C15	58	175	TTP-RB4(s)	46
143	TTP-C19	58	176	TTP-RB5	46
144	TTP-C22	58	177	TTP-RB6	46
145	TTP-C28	59	178	TTP-RB7	46
146	TTP-CC 3/8 RBC	59	179	TTP-RB8	46
147	TTP-CH2P	54	180	TTP-RBH	48
148	TTP-CHG2P	55	181	TTP-RBH3	48
149	TTP-CLO6FB	36	182	TTP-SL2W	38
150	TTP-DC	55	183	TTP-SL3W	38
151	TTP-FRA16	48	184	TTP-SP1	55
152	TTP-FRA6	48	185	TTP-SP2	55
153	TTP-FRA6C	48	186	TTP-SP3	55
154	TTP-FRA6K	48	187	TTP-SP4	55
155	TTP-HL2	50	188	TTP-SP5	55
156	TTP-HL2L	50	189	TTP-SP6	55
157	TTP-HL2R	50	190	TTP-SP7	38
158	TTP-HL3	50	191	TTP-SP8	56
159	TTP-INCAP	50	192	TTP-SP9	56
160	TTP-INCLINED CLIP	55	193	TTP-SS2FN	52
161	TTP-L2FN	32	194	TTP-SS2MN	52
162	TTP-RB1	46	195	TTP-SS3FN	52
163	TTP-RB10	46	196	TTP-SS3MN	52
164	TTP-RB11	47	197	TTP-SS4FN	52
165	TTP-RB12	47	198	TTP-SS4MN	52
166	TTP-RB14	47	199	TTP-SS5FN	52
167	TTP-RB15	47	200	TTP-SS5MN	52
168	TTP-RB16	47	201	TTP-SS6FN	52
169	TTP-RB17	47	202	TTP-SS6MN	52
170	TTP-RB18	47	203	TTP-STRIP	54
171	TTP-RB19	47	204	TTP-TMCP	54

Terminals

Sr. No.	Part No.	Page No.	Sr. No.	Part No.	Page No.
1	TT-1U	105	28	TT-1365	112
2	TT-1004	86	29	TT-1378	62
3	TT-1009	86	30	TT-1389	66
4	TT-1011	70	31	TT-1391	62
5	TT-1012	70	32	TT-1406	80
6	TT-1013	70	33	TT-1410	89
7	TT-1128	64	34	TT-1416	89
8	TT-1211	75	35	TT-1423	87
9	TT-1242	84	36	TT-1425	73
10	TT-1260	68	37	TT-1427	82
11	TT-1263	71	38	TT-1428	64
12	TT-1283	67	39	TT-1429	64
13	TT-1311	75	40	TT-1429S	64
14	TT-1312	76	41	TT-1435	98
15	TT-1313	70	42	TT-1442	85
16	TT-1317	110	43	TT-1446	91
17	TT-1321	98	44	TT-1447	91
18	TT-1322	110	45	TT-1448	99
19	TT-1326	84	46	TT-1460	68
20	TT-1337	98	47	TT-1476	99
21	TT-1342	85	48	TT-1478	62
22	TT-1345	67	49	TT-1488	65
23	TT-1348	67	50	TT-1491	64
24	TT-1355	80	51	TT-1493	92
25	TT-1360	67	52	TT-1501	108
26	TT-1362	95	53	TT-1503	89
27	TT-1363	72	54	TT-1505	80

PRODUCT FINDER

Terminals

Sr. No.	Part No.	Page No.	Sr. No.	Part No.	Page No.
55	TT-1506	80	124	TT-1721	94
56	TT-1508	86	125	TT-1725	91
57	TT-1509	80	126	TT-1727	82
58	TT-1510	89	127	TT-1738	95
59	TT-1511	62	128	TT-1745	111
60	TT-1516	88	129	TT-1746	87
61	TT-1518	99	130	TT-1755	80
62	TT-1519	99	131	TT-1770	73
63	TT-1520	98	132	TT-1771	72
64	TT-1521	98	133	TT-1774	75
65	TT-1522	99	134	TT-1775	90
66	TT-1523	88	135	TT-1779	81
67	TT-1524	62	136	TT-1782	90
68	TT-1525	62	137	TT-1783	66
69	TT-1526	62	138	TT-1791	76
70	TT-1533	88	139	TT-1793	92
71	TT-1533L	88	140	TT-1805	86
72	TT-1554	90	141	TT-1806	92
73	TT-1555	80	142	TT-1807	73
74	TT-1556	94	143	TT-1807K	73
75	TT-1556U	94	144	TT-1808	91
76	TT-1557	71	145	TT-1809	92
77	TT-1562	95	146	TT-1810K	73
78	TT-1563	71	147	TT-1811	74
79	TT-1564	68	148	TT-1811(U)	74
80	TT-1566	90	149	TT-1812	74
81	TT-1567	91	150	TT-1812(U)	74
82	TT-1570	71	151	TT-1813	74
83	TT-1573	95	152	TT-1816	114
84	TT-1578	71	153	TT-1818	78
85	TT-1579	71	154	TT-1822	85
86	TT-1591	66	155	TT-1823	74
87	TT-1592	82	156	TT-1824	74
88	TT-1593	92	157	TT-1825	91
89	TT-1594	67	158	TT-1828	64
90	TT-1598	66	159	TT-1829	64
91	TT-1601	66	160	TT-1833	99
92	TT-1602	71	161	TT-1834	99
93	TT-1603	94	162	TT-1835	98
94	TT-1603U	94	163	TT-1840	73
95	TT-1604	72	164	TT-1841	84
96	TT-1605	72	165	TT-1846	87
97	TT-1606	72	166	TT-1847	85
98	TT-1609	88	167	TT-1849	88
99	TT-1610	95	168	TT-1850	65
100	TT-1611	78	169	TT-1851	87
101	TT-1613	62	170	TT-1852	108
102	TT-1616	114	171	TT-1853	94
103	TT-1617	78	172	TT-1854	90
104	TT-1620	82	173	TT-1855	80
105	TT-1621	82	174	TT-1856	65
106	TT-1622	110	175	TT-1860	68
107	TT-1628	64	176	TT-1863	81
108	TT-1629	64	177	TT-1864	68
109	TT-1632	65	178	TT-1865	73
110	TT-1636	65	179	TT-1866	73
111	TT-1638	95	180	TT-1867	84
112	TT-1646	66	181	TT-1868S	94
113	TT-1648	68	182	TT-1870	84
114	TT-1657	72	183	TT-1871	85
115	TT-1670	72	184	TT-1872	86
116	TT-1681	72	185	TT-1873	87
117	TT-1682	90	186	TT-1874	81
118	TT-1695	65	187	TT-1876	99
119	TT-1696	65	188	TT-1879	81
120	TT-1698	65	189	TT-1881	75
121	TT-1704	72	190	TT-1882	90
122	TT-1708	91	191	TT-1883	67
123	TT-1716	81	192	TT-1884	81

PRODUCT FINDER

Terminals

Sr. No.	Part No.	Page No.	Sr. No.	Part No.	Page No.
193	TT-1885	91	262	TT-2827	108
194	TT-1891	62	263	TT-2839	108
195	TT-1892	62	264	TT-2840	77
196	TT-1893	92	265	TT-2843	111
197	TT-1898	88	266	TT-2852	108
198	TT-1900	98	267	TT-2855	80
199	TT-1901	111	268	TT-2860	111
200	TT-1902	110	269	TT-2863	82
201	TT-1903	94	270	TT-2866	74
202	TT-1903U	94	271	TT-2872	86
203	TT-1906	87	272	TT-2874	81
204	TT-1907	89	273	TT-2888	114
205	TT-1909	75	274	TT-2889	114
206	TT-1911	75	275	TT-2890	114
207	TT-1912	68	276	TT-2892	114
208	TT-1916	81	277	TT-2898	89
209	TT-1917	92	278	TT-2906	87
210	TT-1918	71	279	TT-2907	89
211	TT-1923	98	280	TT-2910	111
212	TT-1925	73	281	TT-2916	81
213	TT-1927	82	282	TT-2932	111
214	TT-1938	98	283	TT-2935	77
215	TT-1939	110	284	TT-2936	114
216	TT-1941	84	285	TT-2941	114
217	TT-1945	87	286	TT-2958	95
218	TT-1946	84	287	TT-2959	111
219	TT-1947	85	288	TT-2960	70
220	TT-1948	68	289	TT-2961	70
221	TT-1949	86	290	TT-2967	77
222	TT-1955	67	291	TT-2970	77
223	TT-1958	95	292	TT-2971	77
224	TT-1960	70	293	TT-2972	77
225	TT-1961	70	294	TT-3U	105
226	TT-1963	75	295	TT-5003U	102
227	TT-1965	67	296	TT-5004U	102
228	TT-1967	75	297	TT-5005U	102
229	TT-1968	68	298	TT-5007U	103
230	TT-1969	75	299	TT-5009U	102
231	TT-1970	76	300	TT-5010U	102
232	TT-1972	76	301	TT-5011U	103
233	TT-1977	62	302	TT-5017U	103
234	TT-1980	76	303	TT-5018U	103
235	TT-1982	76	304	TT-5029	104
236	TT-1983	67	305	TT-5050U	103
237	TT-1986	65	306	TT-5104U	102
238	TT-1989	66	307	TT-5108U	102
239	TT-1992	92	308	TT-5109U	102
240	TT-1993	92	309	TT-5113U	103
241	TT-1994	85	310	TT-5120U	103
242	TT-1996	66	311	TT-5125	104
243	TT-2011	70	312	TT-5152U	105
244	TT-2012	76	313	TT-5155U	103
245	TT-2313	71	314	TT-5251U	105
246	TT-2324	112	315	TT-5549U	104
247	TT-2352	108	316	TT-5913	104
248	TT-2538	76	317	TT-5914	104
249	TT-2549	77	318	TT-5915	104
250	TT-2560	112	319	TT-9U	105
251	TT-2614	110			
252	TT-2625	108			
253	TT-2675	90			
254	TT-2681	112			
255	TT-2689	112			
256	TT-2732	110			
257	TT-2737	112			
258	TT-2808	91			
259	TT-2810K	74			
260	TT-2823	77			
261	TT-2826	108			

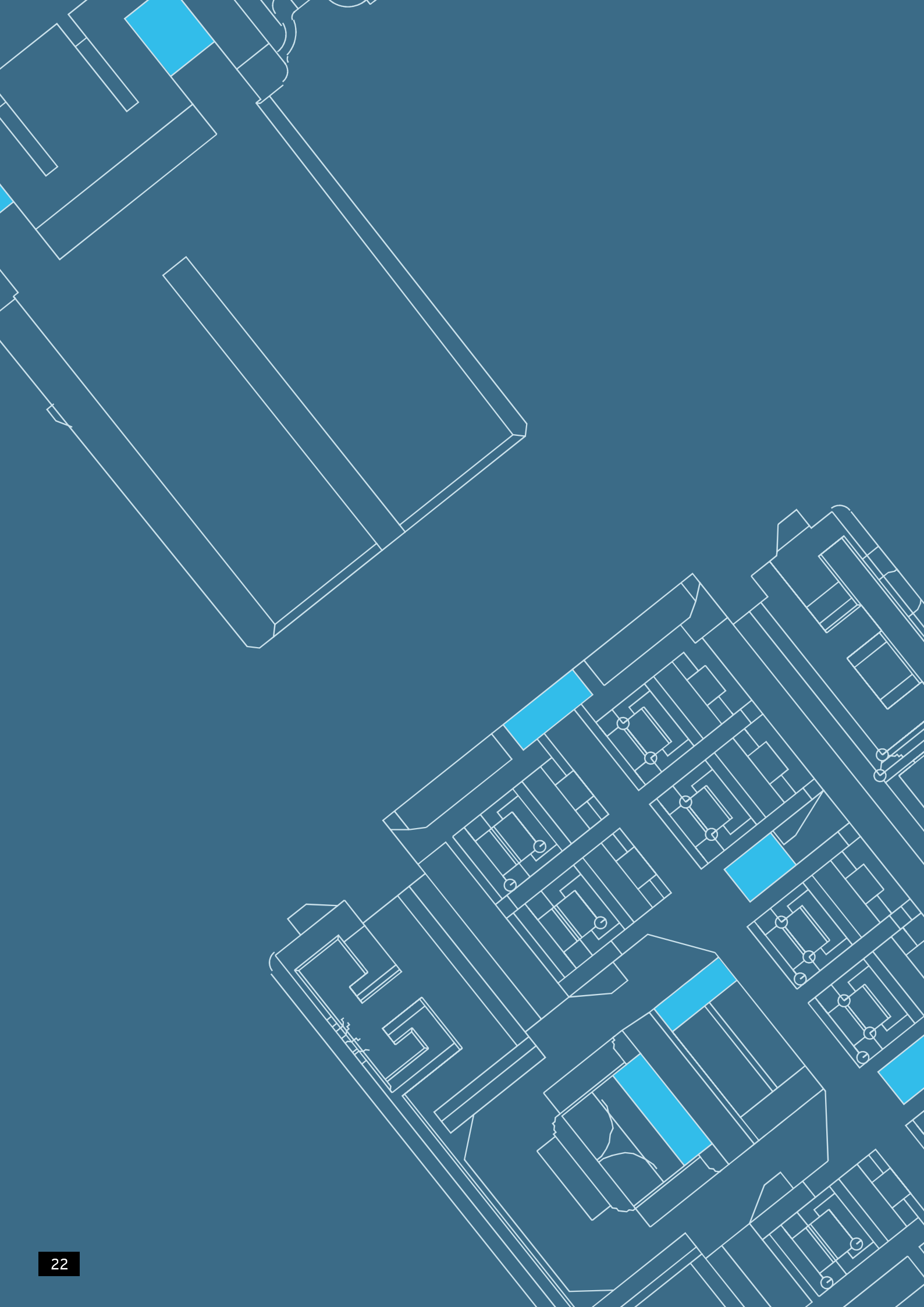

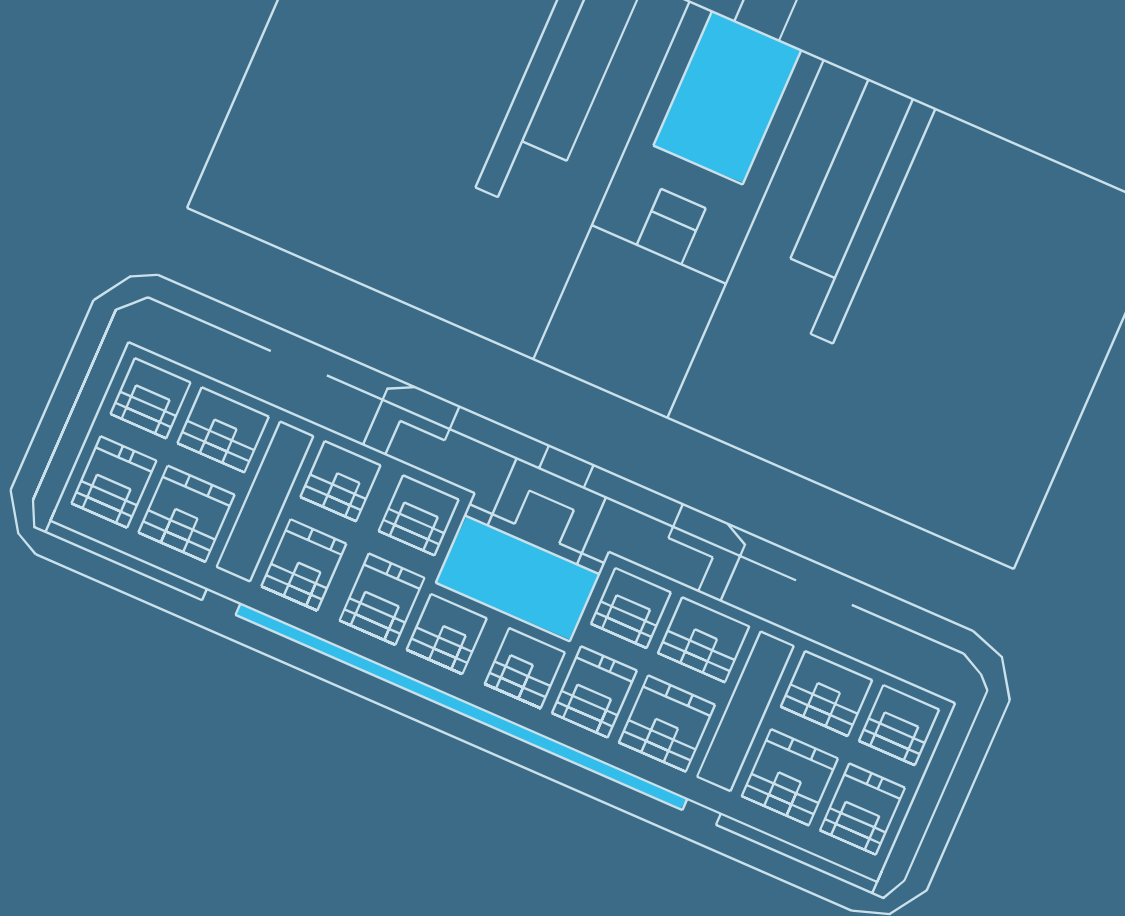

CONNECTORS

070 | 090 | 110
Series Connectors

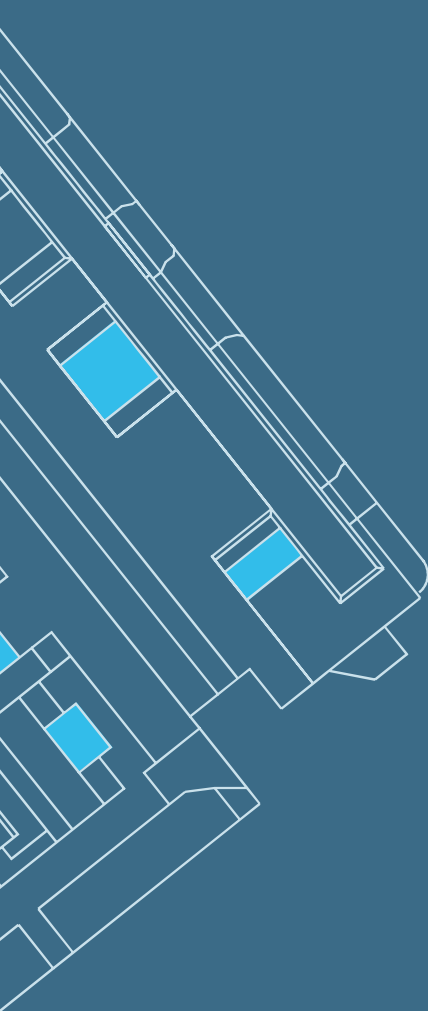

070 series Connectors



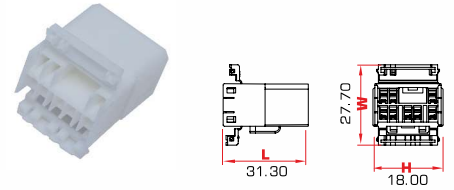
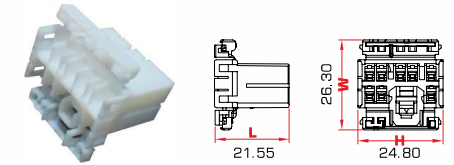
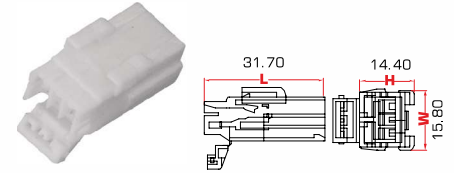





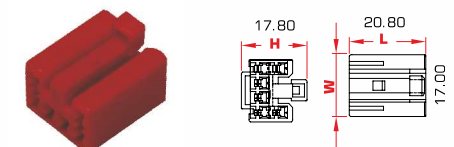
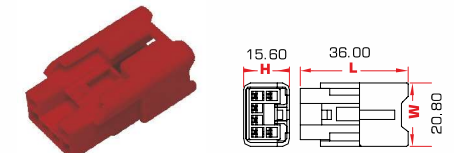
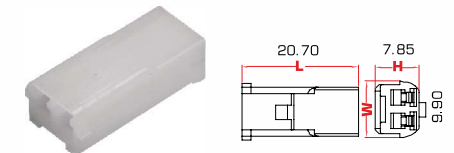
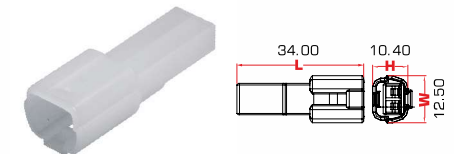

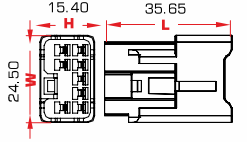

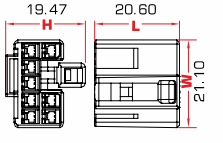
CATEGORY NO.	DESCRIPTION	APPLICABLE TERMINAL	APPLICABLE MATING CONNECTOR	MATERIAL	STANDARD PACKING QTY. [NOS.]
TTP-073MN	3 Pole Male Connector	TT-1613	NA	PBT	500
TTP-078FN	8 Pole Female Connector	-	NA	PBT	500
TTP-078MN	8 Pole Male Connector	TT-1613	NA	PBT	500

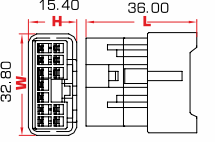

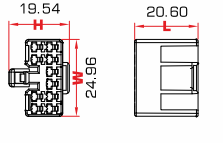
090 series Unsealed Connectors

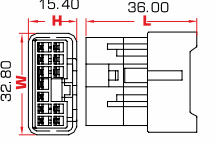
CATEGORY NO	DESCRIPTION	APPLICABLE TERMINAL	APPLICABLE MATING CONNECTOR	MATERIAL	STANDARD PACKING QTY. [NOS.]
TTP-02MN	2 Pole Male Connector	TT-1511 TT-1526	TTP-02FN	Nylon 6/66	1000
TTP-02FN	2 Pole Female Connector	TT-1524 TT-1525	TTP-02MN	Nylon 6/66	2000
TTP-06MN	6 Pole Male Connector	TT-1511 TT-1526	TTP-06FN	Nylon 6/66	250
TTP-06MNFR WITH SECONDARY LOCK					
TTP-06FN	6 Pole Female Connector	TT-1524 TT-1525	TTP-06MN	Nylon 6/66	500

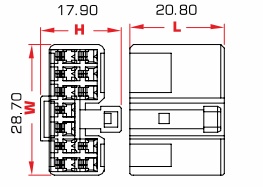
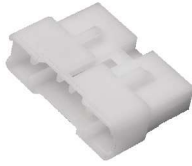
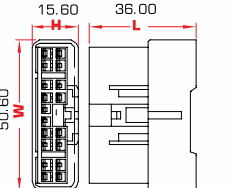

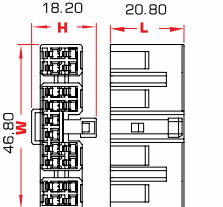
CATEGORY NO.	DESCRIPTION	APPLICABLE TERMINAL	APPLICABLE MATING CONNECTOR	MATERIAL	STANDARD PACKING QTY. [NOS.]	
TTP-08MN	8 Pole Male Connector	TT-1511 TT-1526	TTP-08FN	Nylon 6/66	500	 
TTP-08FN	8 Pole Female Connector	TT-1524 TT-1525	TTP-08MN	Nylon 6/66	500	 
TTP-010MN	10 Pole Male Connector	TT-1511 TT-1526	TTP-010FN	Nylon 6/66	500	 
TTP-010FN	10 Pole Female Connector	TT-1524 TT-1525	TTP-010MN	Nylon 6/66	500	 
TTP-012MN	12 Pole Male Connector	TT-1511 TT-1526	TTP-012FN	Nylon 6/66	250	 
TTP-012FN	12 Pole Female Connector	TT-1524 TT-1525	TTP-012MN	Nylon 6/66	250	 
TTP-018MN	18 Pole Male Connector	TT-1511 TT-1526	TTP-018FN	Nylon 6/66	150	 
TTP-018FN	18 Pole Female Connector	TT-1524 TT-1525	TTP-018MN	Nylon 6/66	150	 

090 series Unsealed Connectors

CATEGORY NO.	DESCRIPTION	APPLICABLE TERMINAL	APPLICABLE MATING CONNECTOR	MATERIAL	STANDARD PACKING QTY. [NOS.]
TTP-020MN	20 Pole Male Connector	TT-1511 TT-1526	TTP-020FN	Nylon 6/66	100
TTP-020FN	20 Pole Female Connector	TT-1524 TT-1525	TTP-020MN	Nylon 6/66	100

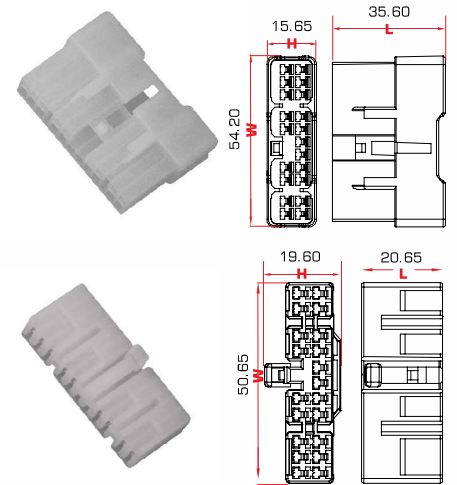

090 series Sealed Connectors

TTP-02MN (WS)	2 Pole Male Connector	TT-1478	TTP-02FN (WS)	PBT	500
TTP-02FN (WS)	2 Pole Female Connector	TT-1891	TTP-02M N(WS)	PBT	1000
TTP-04MN (WS)	4 Pole Male Connector	TT-1478	TTP-04FN (WS)	Nylon6/66	500
TTP-04FN (WS)	4 Pole Female Connector	TT-1891	TTP-04MN (WS)	Nylon6/66	500
TTP-06MN (WS)	6 Pole Male Connector	TT-1478	TTP-06FN (WS)	Nylon6/66	500
TTP-06FN (WS)	6 Pole Female Connector	TT-1891	TTP-06MN (WS)	Nylon6/66	500

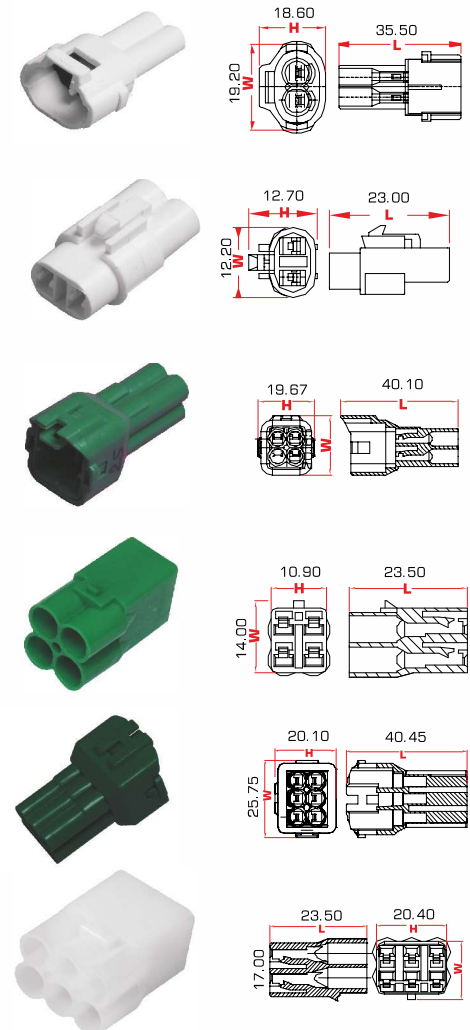

110 series Connectors

CATEGORY NO.	DESCRIPTION	APPLICABLE TERMINAL	APPLICABLE MATING CONNECTOR	MATERIAL	STANDARD PACKING QTY. [NOS.]	
TTP-12MN	2 pole male Connector	TT-1429 TT-1829 TT-1491	TTP-12FN	Nylon6/66	1000	
TTP-12FN	2 pole female Connector	TT-1628 TT-1828 TT-1128	TTP-12MN	Nylon6/66	500	
TTP-12MN RIB	2 pole male Connector With rib	TT-1856 TT-1986	TTP-12FN	Nylon6/66	1000	
TTP-12MNS	2 pole male Connector Short	TT-1979	TTP-12FN	Nylon 6/66	1000	
TTP-13MN	3 pole male Connector	TT-1429 TT-1829 TT-1491	TTP-13FN	Nylon 6/66	750	
TTP-13FN	3 pole female Connector	TT-1628 TT-1828 TT-1128	TTP-13MN	Nylon 6/66	400	
TTP-13MN RIB	3 pole male Connector With rib	TT-1856 TT-1986	TTP-13FN	Nylon 6/66	750	
TTP-14MN	4 pole male Connector	TT-1429 TT-1829 TT-1491	TTP-14FN	Nylon 6/66	750	
TTP-14FN	4 pole female Connector	TT-1628 TT-1828 TT-1128	TTP-14MN	Nylon 6/66	1500	

110 series Connectors

CATEGORY NO.	DESCRIPTION	APPLICABLE TERMINAL	APPLICABLE MATING CONNECTOR	MATERIAL	STANDARD PACKING QTY. [NOS.]	
TTP-14MN RIB	4 Pole Male Connector With Rib	TT-1856 TT-1986	TTP-14FN	Nylon6/66	750	
TTP-16MN	6 Pole Male Connector	TT-1429 TT-1829 TT-1491	TTP-16FN	Nylon6/66	500	
TTP-16FN	6 Pole Female Connector	TT-1628 TT-1828 TT-1128	TTP-16MN	Nylon6/66	1000	
TTP-16MN RIB	6 Pole Male Connector With Rib	TT-1856 TT-1986	TTP-16FN	Nylon6/66	500	
TTP-19MN	9 Pole Male Connector	TT-1429 TT-1829 TT-1491	TTP-19FN	Nylon6/66	250	
TTP-19FN	9 Pole Female Connector	TT-1628 TT-1828 TT-1128	TTP-19MN	Nylon6/66	750	
TTP-19MN RIB	9 Pole Male Connector With Rib	TT-1856 TT-1986	TTP-19FN	Nylon6/66	250	

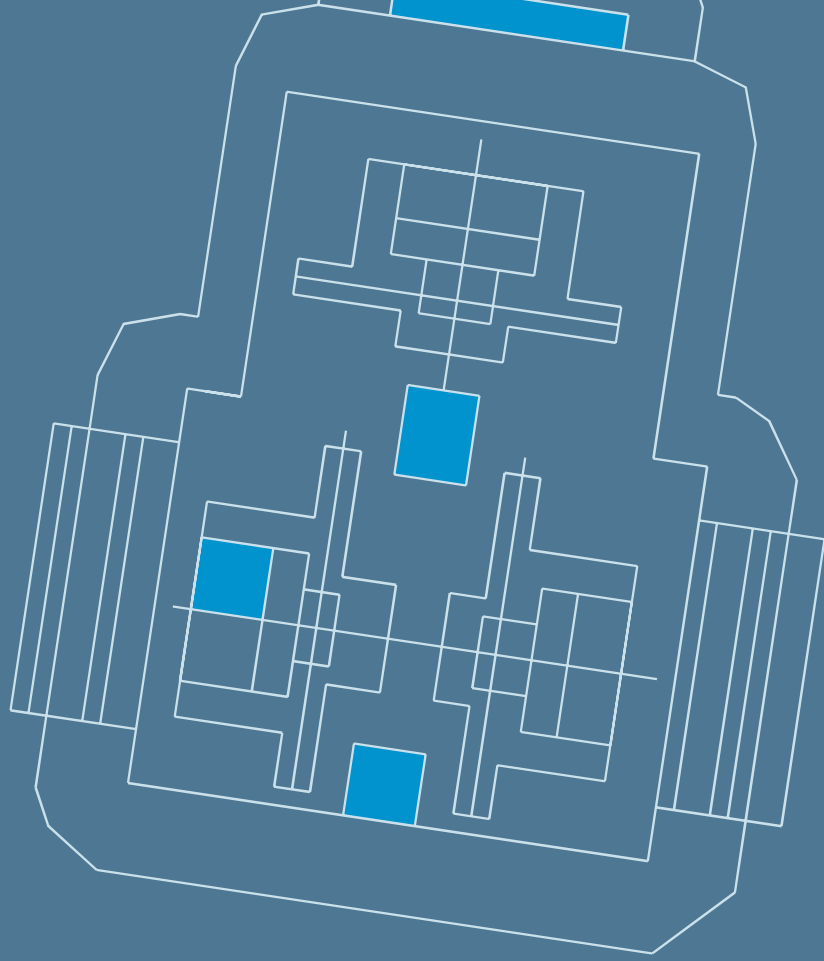

250 | 312 Series Connectors

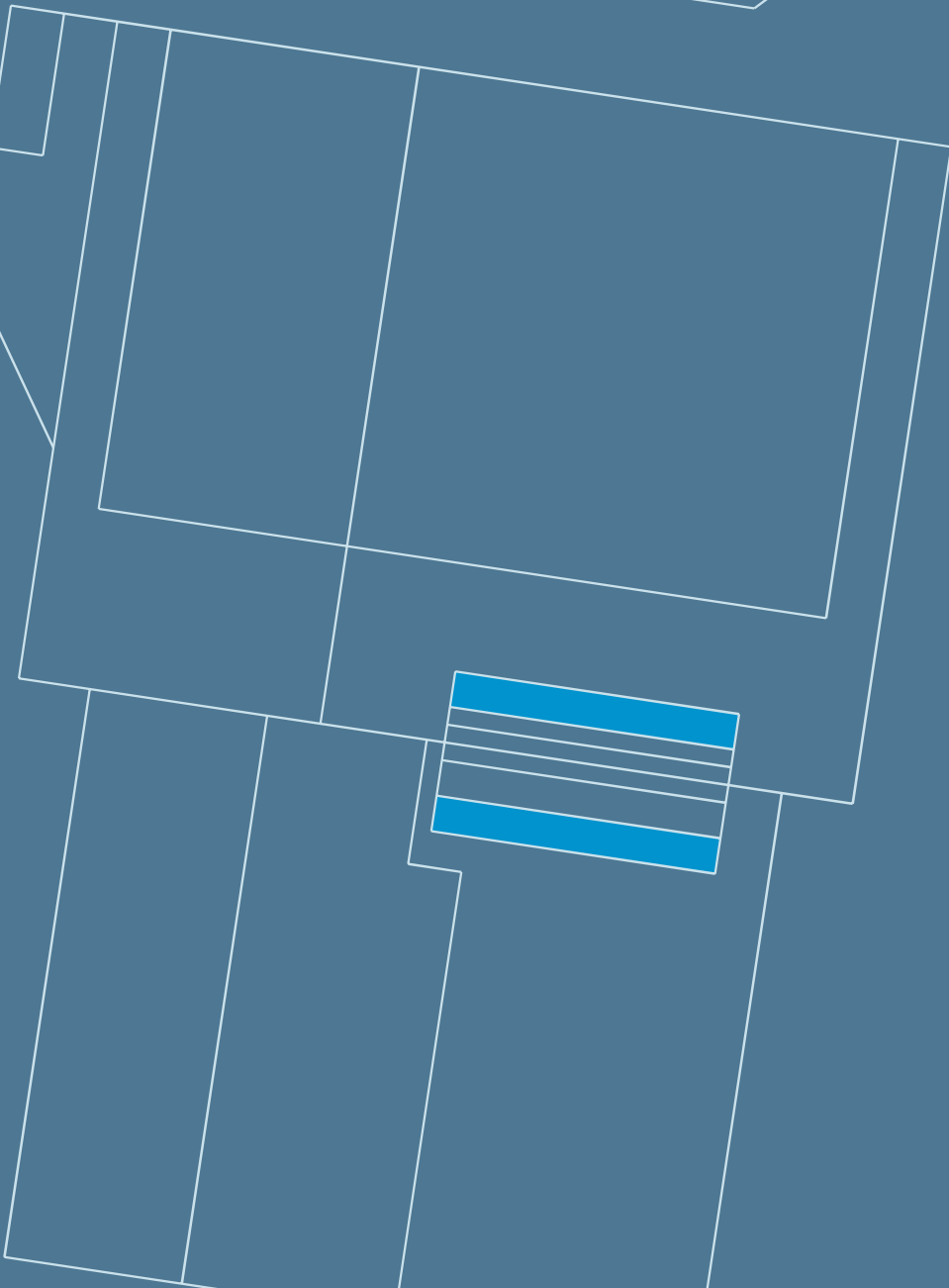

250 series Connectors

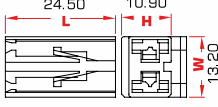
CATEGORY NO.	DESCRIPTION	APPLICABLE TERMINAL	APPLICABLE MATING CONNECTOR	MATERIAL	STANDARD PACKING QTY. [NOS.]		
TTP-21MN	1 Pole Male Connector	TT-1810K TT-1425 TT-1925	TTP-21FN	Nylon6/66 /FR	1000		
TTP-21FN	1 Pole Female Connector	TT-1967 TT-1012 TT-1909 TT-1579	TTP-21MN	Nylon6/66/ FR	1000		
TTP-22FH	2 Pole Female Connector	TT-1967	NA	Nylon6/66	500		
TTP-22MN	2 Pole Male Connector	TT-1810K TT-1425 TT-1925	TTP-22FN	Nylon6/66/ FR	750		
TTP-22FN	2 Pole Female Connector	TT-1967 TT-1012 TT-1909 TT-1579	TTP-22MN	Nylon6/66/ FR	1000		
TTP-23MN	3 Pole Male Connector	TT-1810K TT-1425 TT-1925	TTP-23FN	Nylon6/66/ FR	500		
TTP-23FN	3 Pole Female Connector	TT-1967 TT-1012 TT-1909 TT-1579	TTP-23MN	Nylon6/66/ FR	500		
TTP-24MN	4 Pole Male Connector	TT-1810K TT-1425 TT-1925	TTP-24FN	Nylon6/66/ FR	500		
TTP-24FN	4 Pole Female Connector	TT-1967 TT-1012 TT-1909 TT-1579	TTP-24MN	Nylon6/66/ FR	500		

CATEGORY NO.	DESCRIPTION	APPLICABLE TERMINAL	APPLICABLE MATING CONNECTOR	MATERIAL	STANDARD PACKING QTY. [NOS.]	
TTP-26MN	6 Pole Male Connector	TT-1810K TT-1425 TT-1925	TTP-26FN	Nylon6/66/ FR	250	
TTP-26FN	6 Pole Female Connector	TT-1967 TT-1012 TT-1909 TT-1579	TTP-26MN	Nylon6/66/ FR	250	
TTP-28MN	8 Pole Male Connector	TT-1810K TT-1425 TT-1925	TTP-28FN	Nylon6/66/ FR	250	
TTP-28FN	8 Pole Female Connector	TT-1967 TT-1012 TT-1909 TT-1579	TTP-28MN	Nylon6/66/ FR	250	
TTP-38FN	8 Pole Female Connector	TT-1970	Hazard warning switch/other switches	Nylon6/66/ FR	250	
TTP-38FN-L	8 Pole Female Connector With Secondary Lock	TT-1970	Hazard warning switch/other switches	Nylon6/66	250	
TTP-1904	1 Pole Positive Lock Connector	TT-1704 TT-1771	NA	Nylon66 +GF/FR	2000	
TTP-1657	1 Pole Positive Lock Connector	TT-1657	NA	Nylon66/FR	2000	
TTP-2904	2 Pole Positive Lock Connector	TT-1704 TT-1771	NA	Nylon66 +GF	1000	

250 series Connectors

CATEGORY NO.	DESCRIPTION	APPLICABLE TERMINAL	APPLICABLE MATING CONNECTOR	MATERIAL	STANDARD PACKING QTY. [NOS.]	
TTP-23FNH	3 Pole Positive Lock Connector	TT-1704 TT-1771	NA	Nylon66 +GF	500	
TTP-3904	3 Pole Positive Lock Connector	TT-1704 TT-1771	NA	Nylon66	500	
TTP-1960	1 Pole Locking Boot	TT-1960 TT-1961	NA	PP/Nylon6	2000	
TTP-22RMN	2 Pole Round Male Connector	TT-1807K	TTP-02RFN	Nylon6/66	250	
TTP-22RFN	2 Pole Round Female Connector	TT-1970	TTP-02RMN	Nylon6/66	250	
TTP-L2FN	2 Pole Female Connector L Shape	TT-1970	NA	Nylon6/66 /FR	1000	

312 series Connectors

TTP-31MN	1 Pole Male Connector	TT-1874	TTP-31FN	Nylon6/66	500	
TTP-31FN	1 Pole Female Connector	TT-1863	TTP-31MN	Nylon6/66	1000	

312 series Connectors

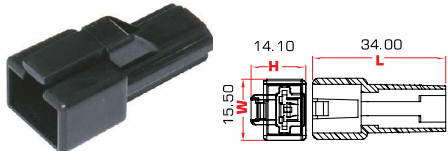
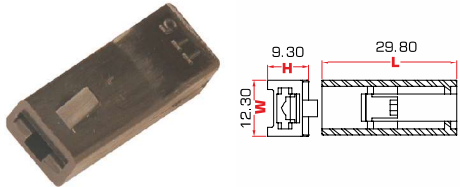
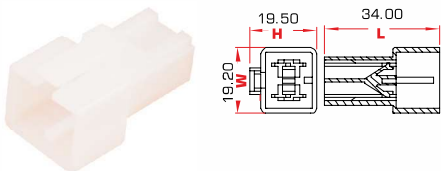
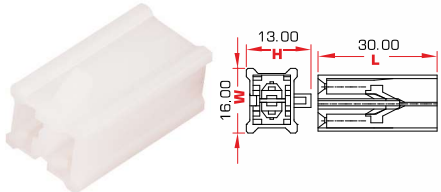
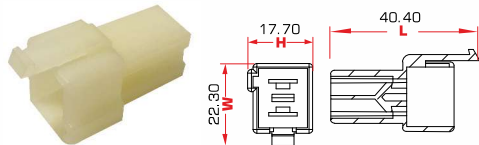
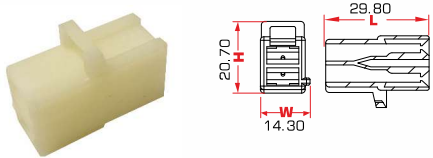
CATEGORY NO.	DESCRIPTION	APPLICABLE TERMINAL	APPLICABLE MATING CONNECTOR	MATERIAL	STANDARD PACKING QTY. [NOS.]	
TTP-31MN(CL)	1 Pole Female Connector With Cantilever	TT-1509	TTP-31FN (CL)	Nylon6/66	500	
TTP-31FN(CL)	1 Pole Female Connector With Cantilever	TT-1927	TTP-31MN (CL)	Nylon6/66	500	
TTP-32MN	2 Pole Male Connector	TT-1916 TT-1509	TTP-32FN	Nylon6/66	400	
TTP-32FN	2 Pole Female Connector	TT-1506	TTP-32MN	Nylon6/66	500	
TTP-32MN (Rib)	2 Pole Female Connector With Rib	TT-1916 TT-1509	TTP-32FN (Rib)	Nylon6/66	500	
TTP-32FN (Rib)	2 Pole Female Connector With Rib	TT-1506	TTP-32MN (Rib)	Nylon6/66	500	

BULB HOLDER ASSEMBLIES

We work with various Tier 1 manufacturers for new product development. TT designs terminals and molds required for Bulb Holder Assembly while completing the necessary inspection requirements.



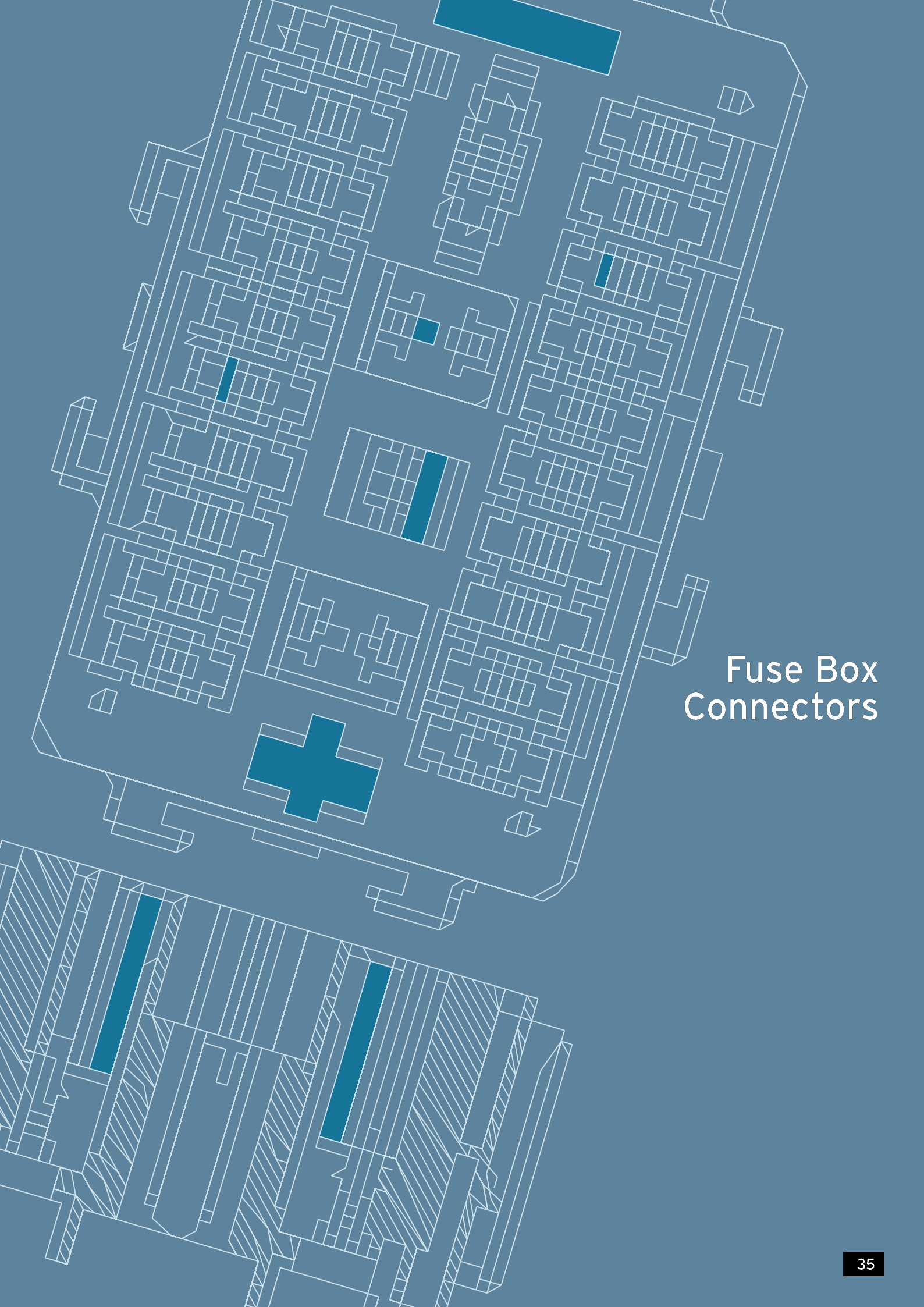





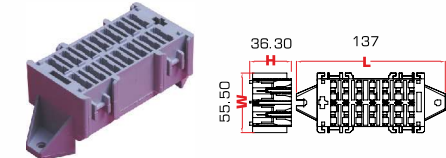
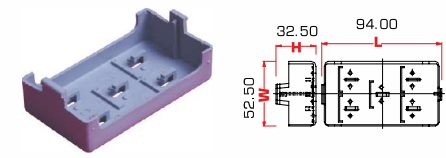
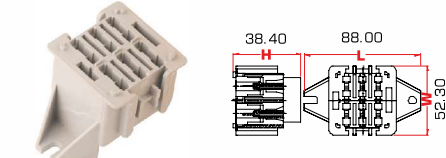
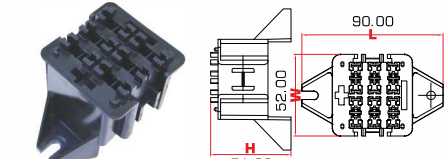
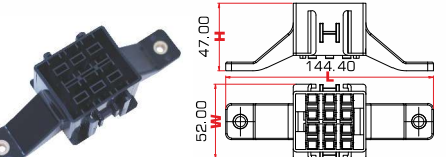
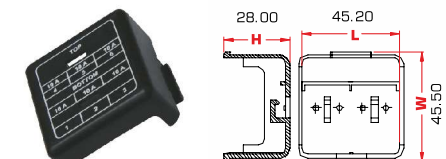
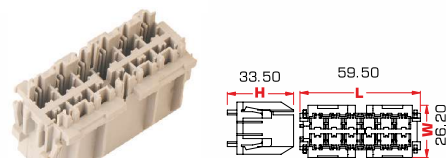
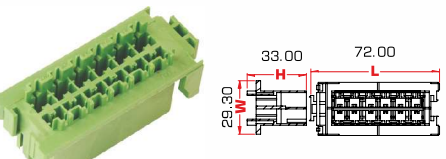
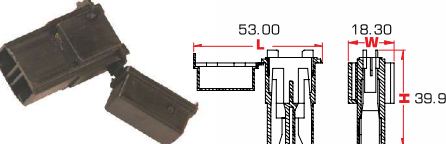

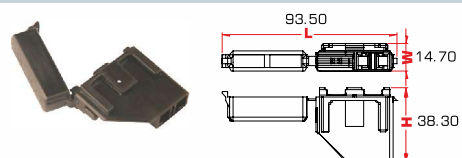
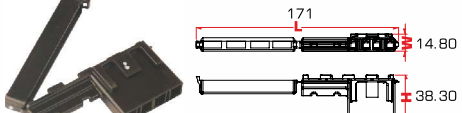

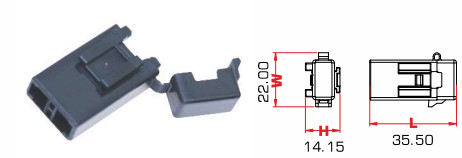
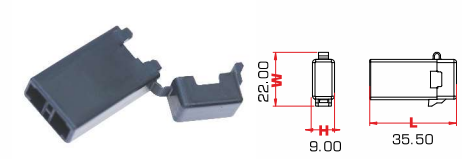
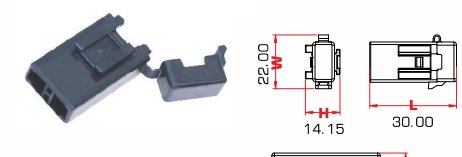
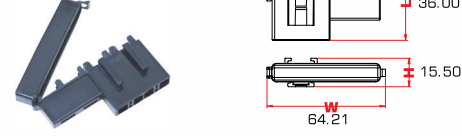
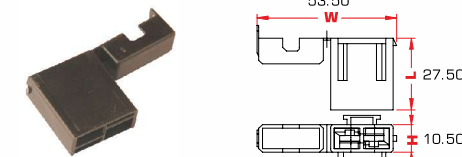
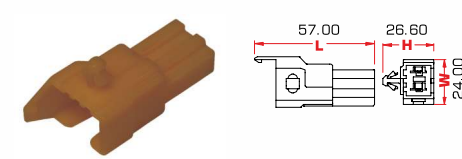
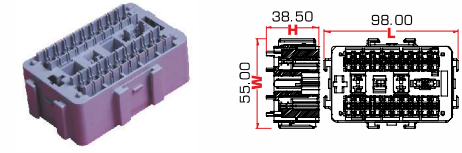





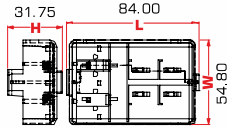

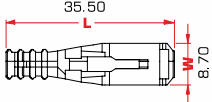
Fuse Box Connectors

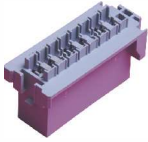
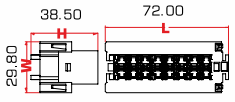
Fuse Box Connectors

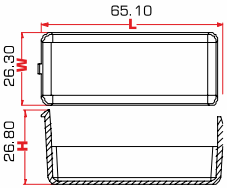
CATEGORY NO.	DESCRIPTION	APPLICABLE TERMINAL	APPLICABLE MATING CONNECTOR	MATERIAL	STANDARD PACKING QTY. [NOS.]	
TTP-14FB	14 Fuse Base Connector	TT-1868 TT-1853 TT-1721	TTP-14FC	Nylon6/66/ FR	10	
TTP-14FC	Cover For 14 Fuse Base (5 Spare)	NA	TTP-14FB	Nylon6/66/ FR	50	
TTP-6FB	6 Fuse Base Connector	TT-1868 TT-1853 TT-1721	TTP-6FC	Nylon6/66/ FR	25	
TTP-CL06FB	6 Fuse Base Connector With Cantilever	TT-1958	TTP-6FC	Nylon6/66/ FR	25	
TTP-06FB-MB	6 Fuse Base Connector With Mounting Bracket	TT-1868 TT-1853 TT-1721	TTP-6FC	Nylon6/66/ FR	25	
TTP-6FC	Cover For 6 Fuse Base	NA	TTP-6FB	Nylon6/66/ FR	100	
TTP-1903	6 Fuse Base Connector	TT-1903 TT-1603 TT-1556	NA	Nylon6/66/ FR	150	
TTP-1903A	6 Fuse Base Connector	TT-1903 TT-1603 TT-1556	NA	Nylon6/66/ FR	75	
TTP-1868P	1 Fuse Base Connector	TT-1868 TT-1853 TT-1721	NA	Nylon6/66/ FR	250	

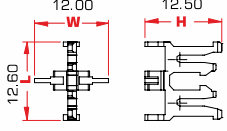
CATEGORY NO.	DESCRIPTION	APPLICABLE TERMINAL	APPLICABLE MATING CONNECTOR	MATERIAL	STANDARD PACKING QTY. [NOS.]	
TTP-2868	Fuse Connector (1+1)	TT-1868 TT-1853 TT-1721	NA	Nylon6/66/ FR	200	
TTP-4868	Fuse Connector (2+2)	TT-1868 TT-1853 TT-1721	NA	Nylon6/66/ FR	100	
TTP-4868H	Fuse Connector (2+2)	TT-1868 TT-1853 TT-1721	NA	Nylon6/66/ FR	100	
TTP-1638A	Single Pole Mini Fuse Connector With Secondary Lock	TT-1638 TT-1738 TT-1458	NA	Nylon6/66/ FR	500	
TTP-1638B	Single Pole Mini Fuse Connector Without Stacking With Secondary Lock	TT-1638 TT-1738 TT-1458	NA	Nylon6/66/ FR	500	
TTP-1638C	Single Pole Mini Fuse Connector With Secondary Lock	TT-1638 TT-1738 TT-1458	NA	Nylon6/66/ FR	500	
TTP-4638	(2+2) Mini Fuse Connector	TT-1638 TT-1738 TT-1458	NA	Nylon6/66/ FR	100	
TTP-1818	Single Fuse Base Connector	TT-1818	NA	Nylon6/66/ FR	500	
TTP-32MAX	2 Pole Maxi Fuse Base	TT-1509	Maxi Fuse	Nylon6/66/ FR	200	
TTP-23FB	23 Mini Fuse Base Connector	TT-1638 TT-1738 TT-1458	TTP-23FC	Nylon6/66/ FR	12	

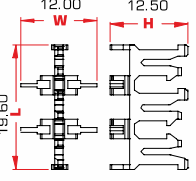
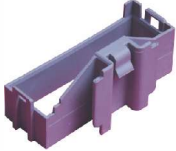
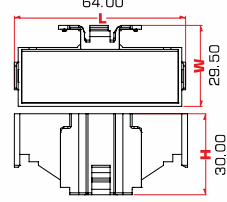
Fuse Box Connectors

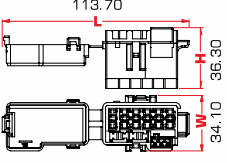
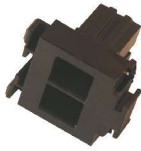
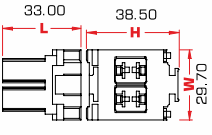
CATEGORY NO.	DESCRIPTION	APPLICABLE TERMINAL	APPLICABLE MATING CONNECTOR	MATERIAL	STANDARD PACKING QTY. [NOS.]		
TTP-23FC	Cover For 23 Mini Fuse Base Connector	NA	TTP-23FB	Nylon6/66/FR	12		
TTP-23CP	Fuse Puller	NA	TTP-23FB	Nylon6/66/FR	12		 
TTP-08MFB	8 Mini Fuse Base Connector	TT-1638 TT-1738 TT-1458	TTP-08MFC	Nylon6/66/FR	75		
TTP-08MFC	Cover For 8 Mini Fuse Base Connector	NA	TTP-08MFB	Nylon6/66/FR	150		
TTP-SL2W	Secondary Lock 2 Way For Mini Fuse Base Connector	NA	TTP-08MFB TTP-23FB	Nylon6/66/FR	1000		
TTP-SL3W	Secondary Lock 3 Way For Mini Fuse Base Connector	NA	TTP-08MFB TTP-23FB	Nylon6/66/FR	1000		
TTP-SP7	Adaptor For Ttp-08mfb	NA	TTP-08MFB TTP-23FB	Nylon6/66/FR	150		
TTP-06MFB	6 Mini Fuse Base Connector	TT-1638 TT-1738 TT-1458	NA	Nylon6/66/FR	250		
TTP-02MFB	2 Maxi Fuse Base Connector	TT-1810K TT-1425	Midi Fuse	Nylon6/66/FR	250		

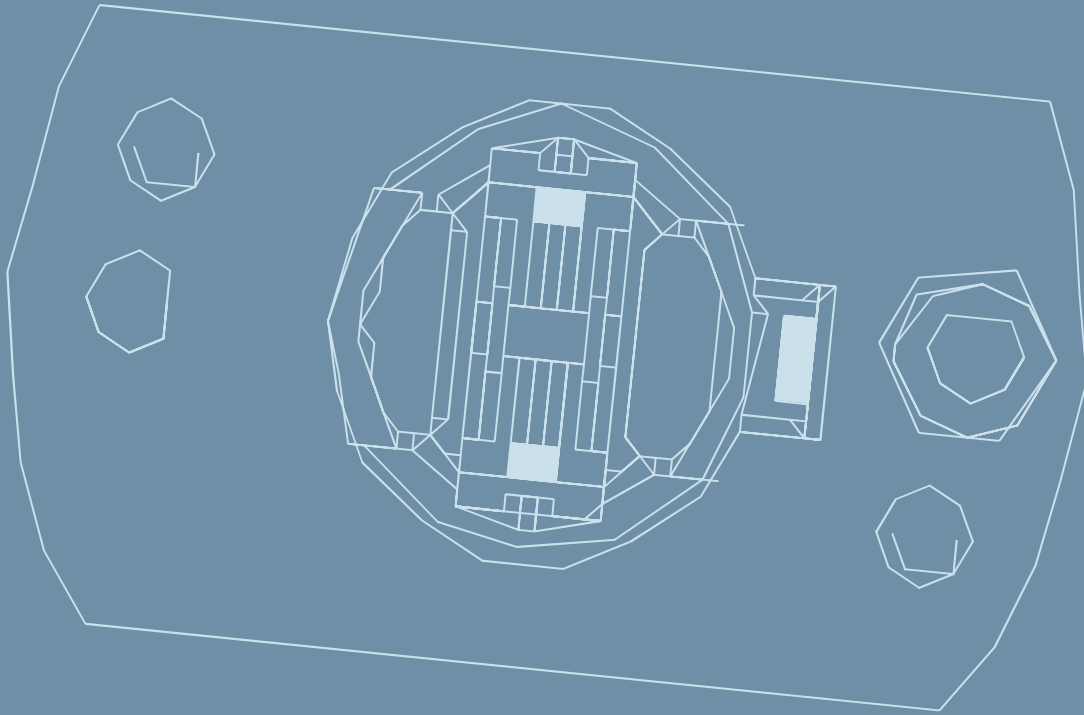

Bulb Holders | Combination Connectors | Diode Assemblies

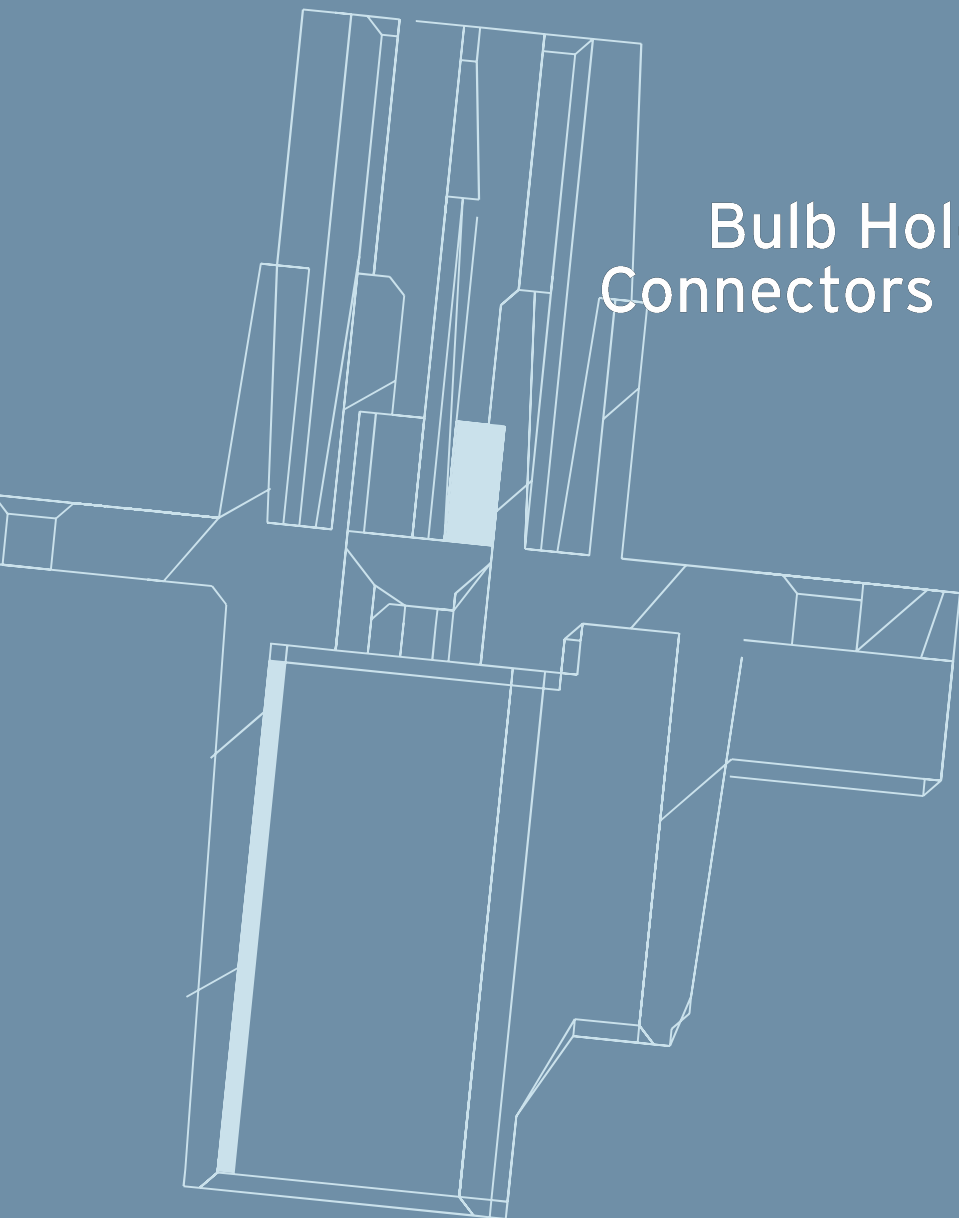

Bulb Holders

CATEGORY NO.	DESCRIPTION	APPLICABLE TERMINAL	APPLICABLE MATING CONNECTOR	MATERIAL	STANDARD PACKING QTY. [NOS.]	
TTP-2827	Bulb Holder Connector	TT-2827	-	Nylon66+ 33%GF	500	
TTP-2625	Bulb Holder Connector	TT-2625	-	PBT	500	
TTP-2676	Bulb Holder Connector	TT-2676	-	PBT	500	
TTP-08TL	Bulb Holder For Punto Break Light	TT-1640 TT-1641	-	PC+ABS C1200HF	100	





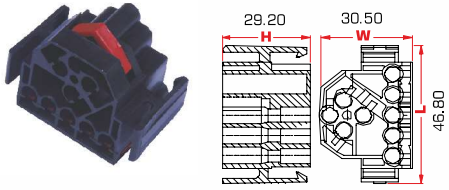
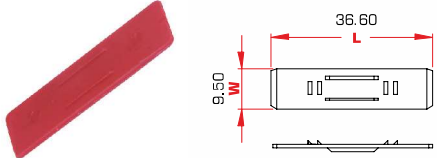
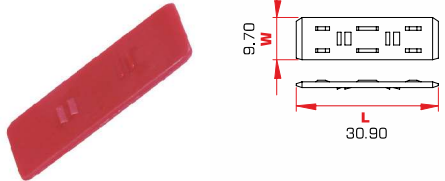
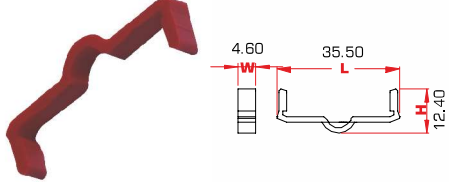
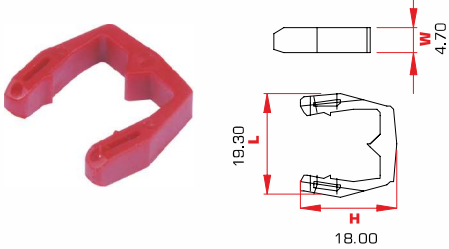
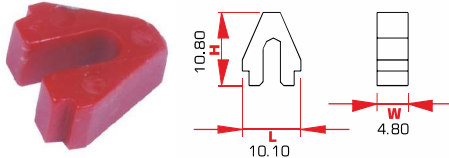





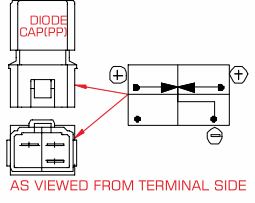

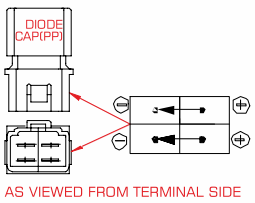

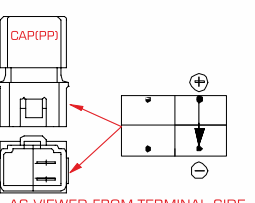

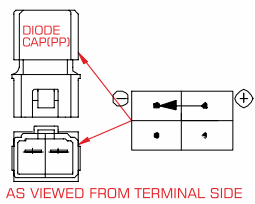
Combination Connectors

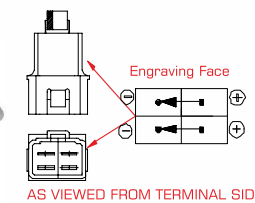
TTP-4902	4 Pole Combination Connector	TT-1902 TT-1939	Combination Switch	Nylon6/66	250	
TTP-8902	8 Pole Combination Connector	TT-1902 TT-1939	Combination Switch	Nylon6/66	150	

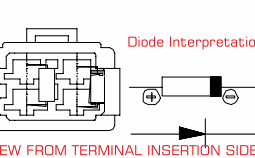
CATEGORY NO.	DESCRIPTION	APPLICABLE TERMINAL	APPLICABLE MATING CONNECTOR	MATERIAL	STANDARD PACKING QTY. [NOS.]	
TTP-9902	9 Pole Combination Connector	TT-1902 TT-1939	Combination Switch	Nylon6/66	100	
TTP-01SL	Secondary Lock For Ttp-9902	NA	TTP-9902	Nylon6/66	1000	
TTP-02SL	Secondary Lock For Ttp-4902	NA	TTP-4902	Nylon6/66	1000	
TTP-03SL	Secondary Lock For Ttp-8902	NA	TTP-8902	Nylon6/66	1000	
TTP-04SL	Secondary Lock For Ttp-9902	NA	TTP-9902	Nylon6/66	1000	
TTP-05SL	Secondary Lock For Ttp-8902	NA	TTP-8902	Nylon6/66	1000	

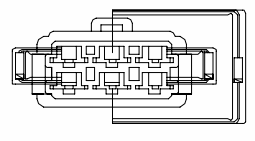
Diode Assemblies

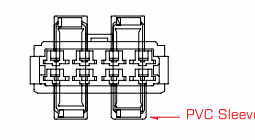
CATEGORY NO.	DESCRIPTION	APPLICABLE TERMINAL	APPLICABLE MATING CONNECTOR	MATERIAL	STANDARD PACKING QTY. [NOS.]	
TTP-22MNA	2 Pole Diode Assy. With IN5408 (3 Amp)	TT-1925	TTP-22FN	Nylon6+PP	500	 
TTP-22FNA	2 Pole Diode Assy. With IN4007 (1 Amp)	TT-1579	TTP-22MN	Nylon6+PP	500	 
TTP-22MNB	2 Pole Diode Assy. With IN4007 (1 Amp)	TT-1925	TTP-22FN	Nylon6+PP	500	 
TTP-22MNC	2 Pole Diode Assy. With IN4007 (1 Amp)	TT-1925	TTP-22FN	Nylon6+PP	500	 
TTP-22MND	2 Pole Capacitor Assy. With 0.47µf (100 V)	TT-1925	TTP-22FN	Nylon6+PP	500	 
TTP-22MNE	2 Pole Diode Assy. With 6A4 (6 Amp)	TT-1925	TTP-22FN	Nylon6+PP	500	 
TTP-22MNF	2 Pole Resistor Assy. With 120W/1W CR	TT-1925	TTP-22FN	Nylon6+PP	500	 
TTP-22MNG	2 Pole Diode Assy. With IN5408 (3 Amp)	TT-1925	TTP-22FN	Nylon6+PP	500	 
TTP-22MNR	2 Pole Resistor Assy. With Mfr 120W /1/4W	TT-1925	TTP-22FN	Nylon6+PP	250	 

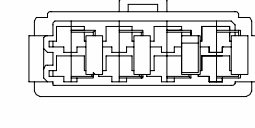
CATEGORY NO.	DESCRIPTION	APPLICABLE TERMINAL	APPLICABLE MATING CONNECTOR	MATERIAL	STANDARD PACKING QTY. [NOS.]	
TTP-24MNA	4 Pole Diode Assy. With IN4007 (1 Amp)	TT-1925	TTP-24FN	Nylon6+PP	250	  <p>DIODE CAP(PP)</p> <p>AS VIEWED FROM TERMINAL SIDE</p>
TTP-24MNB	4 Pole Diode Assy. With IN4007 (1 Amp)	TT-1925	TTP-24FN	Nylon6+PP	250	  <p>DIODE CAP(PP)</p> <p>AS VIEWED FROM TERMINAL SIDE</p>
TTP-24MNC	4 Pole Diode Assy. With IN4007 (1 Amp)	TT-1925	TTP-24FN	Nylon6+PP	250	  <p>CAP(PP)</p> <p>AS VIEWED FROM TERMINAL SIDE</p>
TTP-24MND	4 Pole Diode Assy. With IN4007 (1 Amp)	TT-1925	TTP-24FN	Nylon6+PP	250	  <p>DIODE CAP(PP)</p> <p>AS VIEWED FROM TERMINAL SIDE</p>
TTP-24MNF	4 Pole Diode Assy. With 6A4 (6 Amp)	TT-1925	TTP-24FN	Nylon6+PP	250	  <p>Engraving Face</p> <p>AS VIEWED FROM TERMINAL SIDE</p>
TTP-24MNG	4 Pole Diode Assy. With IN5408 (3 Amp)	TT-1925	TTP-24FN	Nylon6+PP	250	  <p>Diode Interpretation</p> <p>VIEW FROM TERMINAL INSERTION SIDE</p>
TTP-26MNA	6 Pole Diode Assy. With IN5404 (3 Amp)	TT-1925	TTP-26FN	Nylon6+PP	200	 
TTP-28MNA	8 Pole Diode Assy. With 6A4 (6 Amp)	TT-1925	TTP-28FN	Nylon6+PP	200	  <p>PVC Sleeve</p>
TTP-28MNB	8 Pole Diode Assy. With IN5408 (3 Amp)	TT-1925	TTP-28FN	Nylon6+PP	200	 

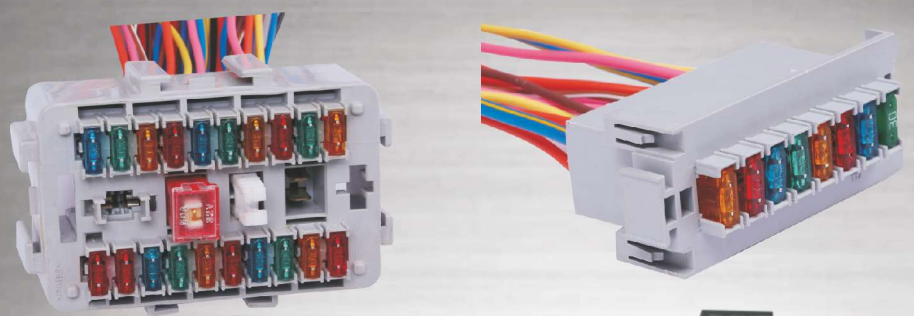
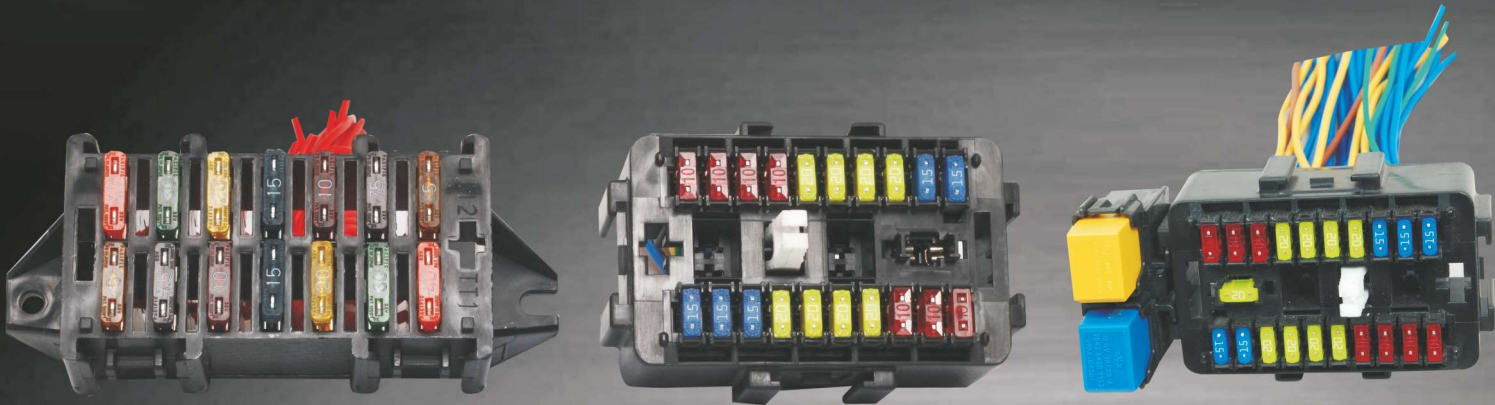

ELECTRICAL JUNCTION BOXES

TT has developed a series of Fuse boxes, Relay Bases and Frames which offers flexibility in designing any circuits. The flexi options offers to play around with a number of fuses (Mini / Blade / Midi), Relays (Micro / Mini / ISO) to accommodate additional equipment requirements of automobile harnesses. We also offer to design fresh assembly solutions for our customer's specific requirements.

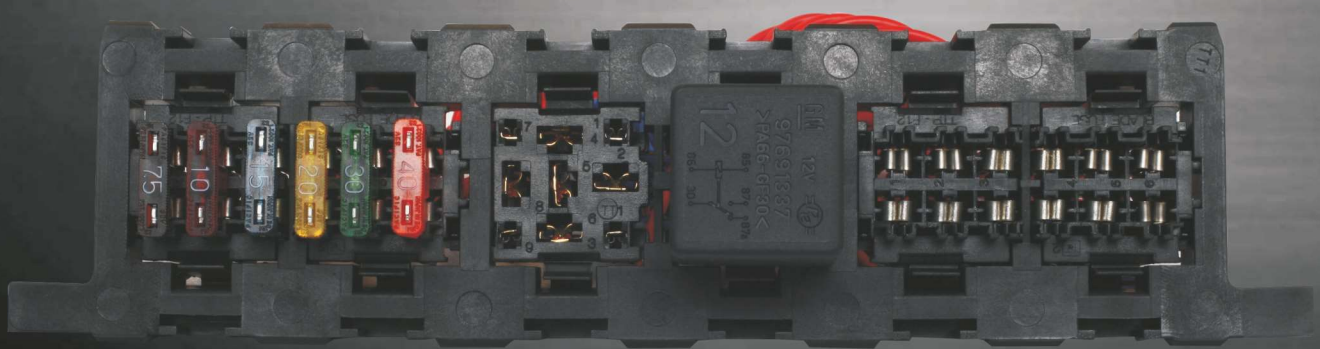
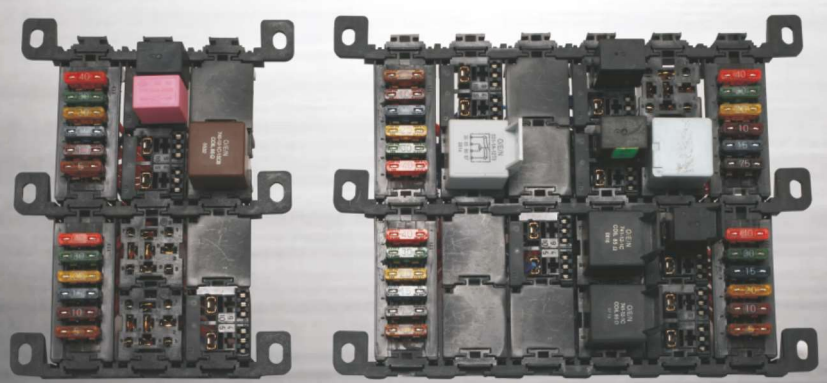
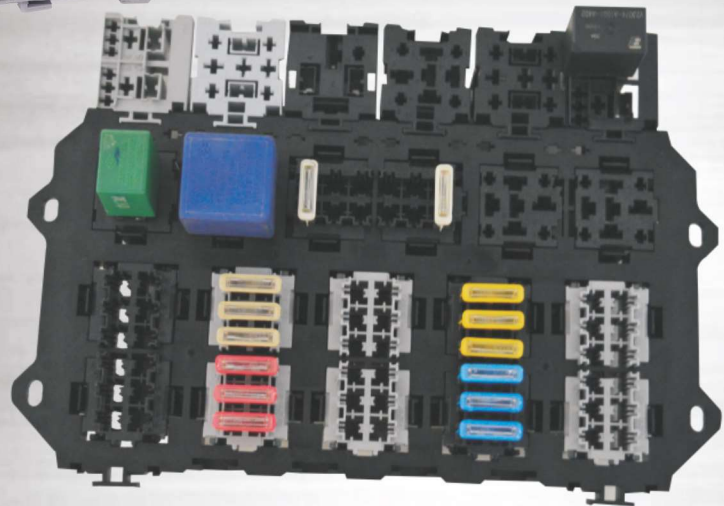



Relay Base Connectors

Relay Base Connectors

CATEGORY NO.	DESCRIPTION	APPLICABLE TERMINAL	APPLICABLE MATING CONNECTOR	MATERIAL	STANDARD PACKING QTY. [NOS.]		
TTP-RB1	9 Pole Relay Base	TT-1967 TT-1989 TT-1791 TT-1312	Relay	Nylon66+ 10%GF/FR	250		
TTP-RB2	9 Pole Relay Base	TT-1967 TT-1989 TT-1791 TT-1312	Relay	Nylon66+ 10%GF/FR	200		
TTP-RB3	5 Pole Relay Base	TT-1967 TT-1648	Relay	Nylon6/66/ FR	200		
TTP-RB4 (s)	4 Pole Relay Base	TT-1970 TT-1864 TT-1013	Relay	Nylon6/66/ FR	500		
TTP-RB5	Flasher Base	TT-1970	Flasher	Nylon6/66/ FR	250		
TTP-RB6	9 Pole Relay Base	TT-1967 TT-1989 TT-1791 TT-1312	Relay (stackable)	Nylon6/66/ FR	250		
TTP-RB7	Meter Socket	TT-1970	Meter socket	Nylon6/66/ FR	500		
TTP-RB8	5 Pole Relay Base	TT-1967	Relay	Nylon6/66/ FR	400		
TTP-RB10	Dual Microrelay Base	TT-1704 TT-2560 TT-2689 TT-2324	Relay	Nylon6/66/ FR	150		

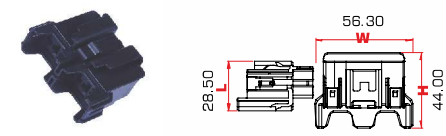
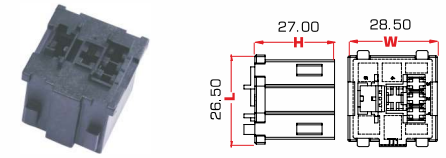
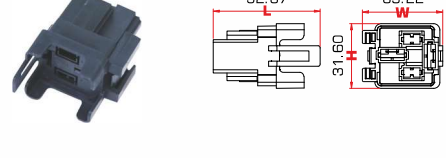
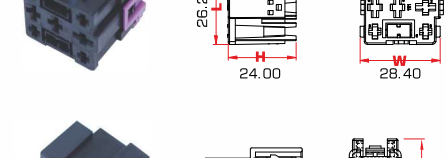
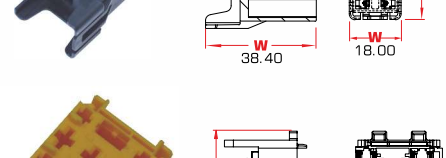
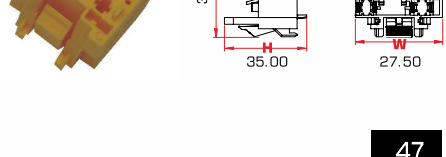
CATEGORY NO.	DESCRIPTION	APPLICABLE TERMINAL	APPLICABLE MATING CONNECTOR	MATERIAL	STANDARD PACKING QTY. [NOS.]	
TTP-RB11	Duel Microrelay Base	TT-2538 TT-1860	Relay	PBT	100	
TTP-RB12	5 Pole Relay Base	TT-1620 TT-1704 TT-1989	Relay	Nylon66+ 15% GF/FR	200	
TTP-RB14	9 Pole Relay Base	TT-1704 TT-2689	Relay	Nylon66+ 10 GF/FR	200	
TTP-RB15	Single Microrelay Base	TT-1704 TT-2560 TT-2689	Relay	Nylon66+ 13 GF/FR	250	
TTP-RB16	Starter Relay Base	TT-1704 TT-1620	Relay	Nylon66+ FRVO	100	
TTP-RB17	5+5 Relay Base	TT-1860	Relay	Nylon66	200	
TTP-RB18	Inner Edge Relay Base	TT-1704 TT-2560 TT-2689	Relay	Nylon66+ 15% GF	200	
TTP-RB19	75 Series Relay Base	TT-1967 TT-1389	Relay	Nylon66	200	
TTP-RB21	9 Pole Relay Base Assembly	TT-1704 TT-2560 TT-2324	Relay	Nylon66	200	

Relay Base Connectors

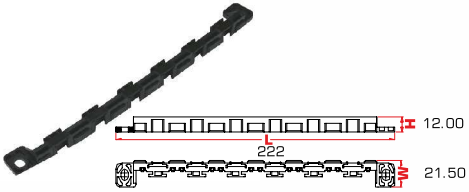
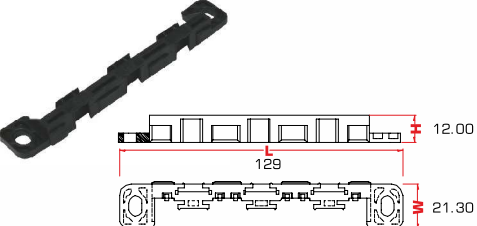
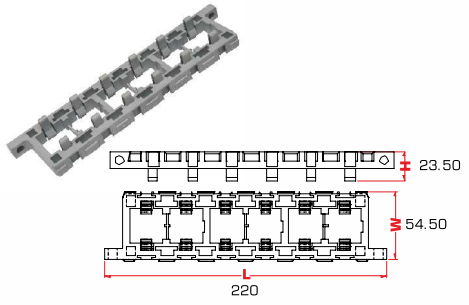
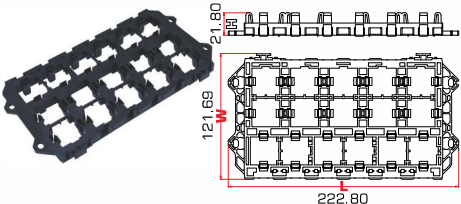
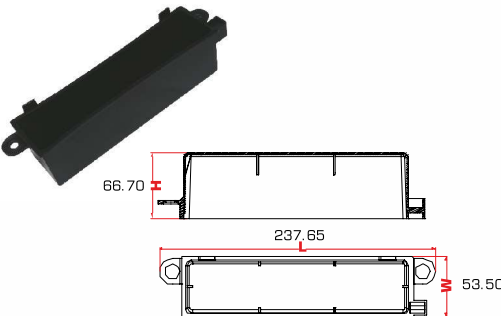
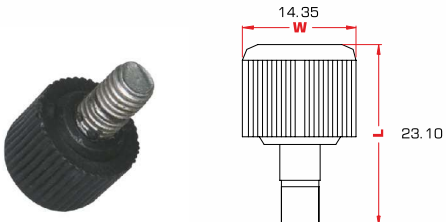
CATEGORY NO.	DESCRIPTION	APPLICABLE TERMINAL	APPLICABLE MATING CONNECTOR	MATERIAL	STANDARD PACKING QTY. [NOS.]	
TTP-RBH	Relay Base Holder 6 Strip Positions	NA	Relay & Fuse Bases	Nylon66+ 33% GF / Nylon6/FR	100	
TTP-RBH3	Relay Base Holder 3 Strip Positions	NA	Relay & Fuse Bases	Nylon66+ 33% GF / Nylon6/FR	100	
TTP-FRA6	Fuse & Relay Adaptor	NA	Relay & Fuse Bases	Nylon66+ 33% GF / Nylon6/FR	20	
TTP-FRA16	Fuse & Relay Adaptor Frame	NA	Relay & Fuse Bases	Nylon66+ 33% GF / Nylon6/FR	8	
TTP-FRA6C	Cover For Fuse & Relay Adaptor	NA	TTP-FRA6	PP	20	
TTP-FRA6K	Knob For Fuse & Relay Adaptor	NA	TTP-FRA6	PP	20	

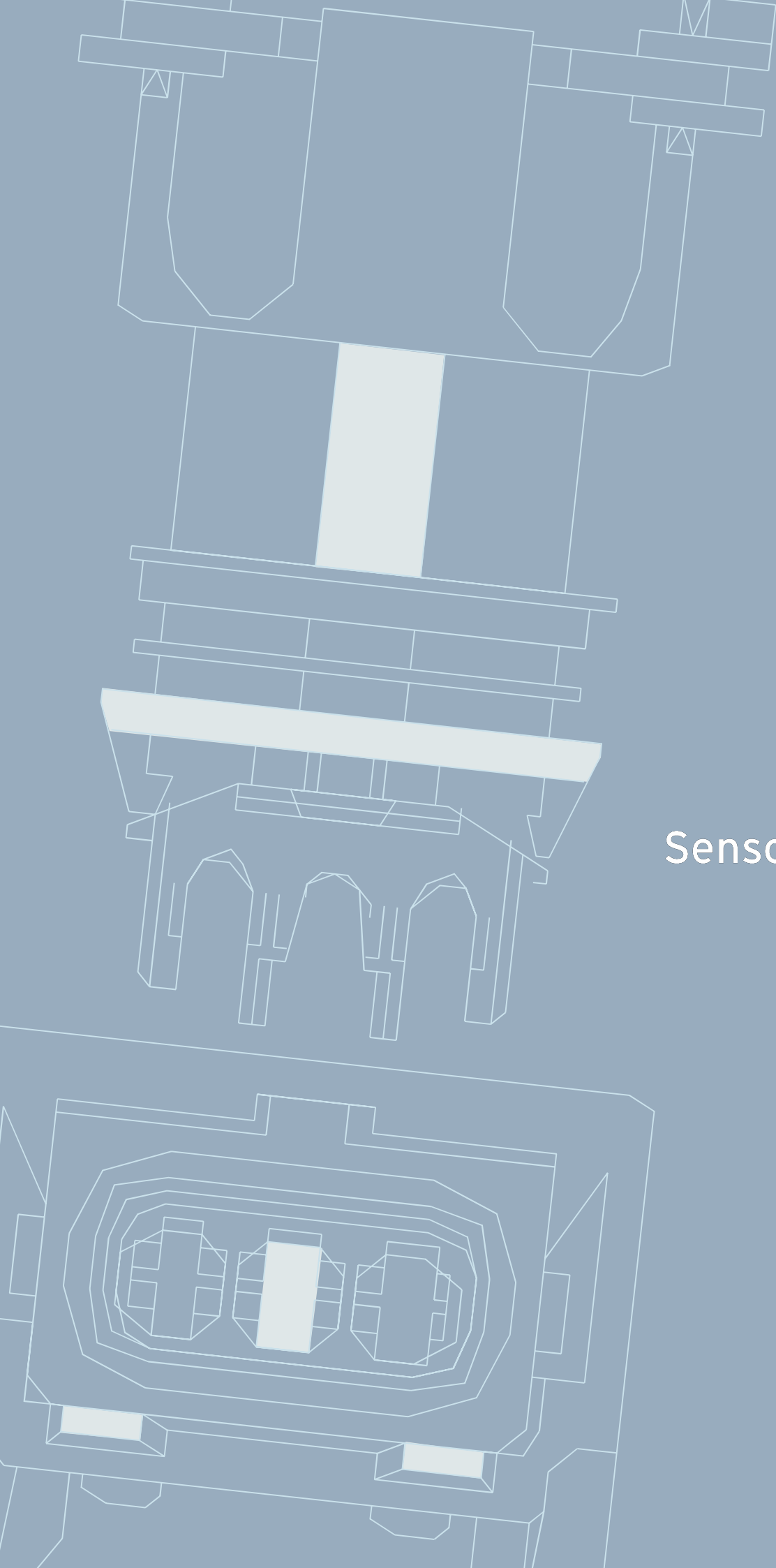

Headlamp & Sensor Connectors

Headlamp & Sensor Connectors

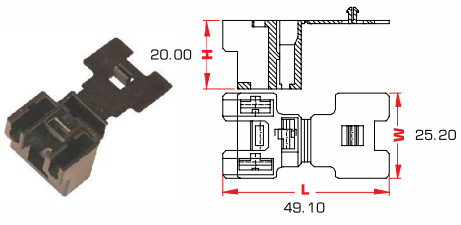
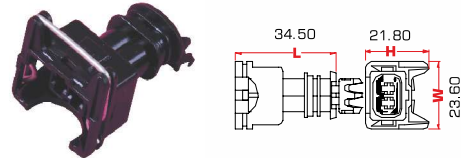
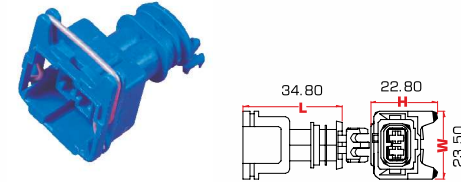
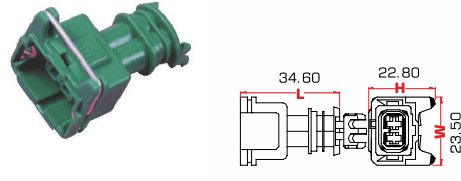
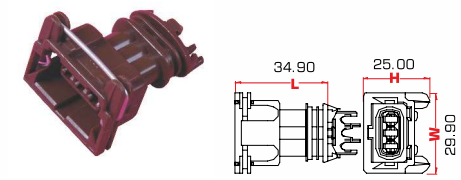
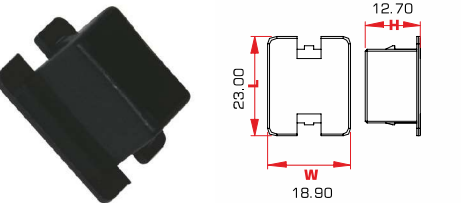

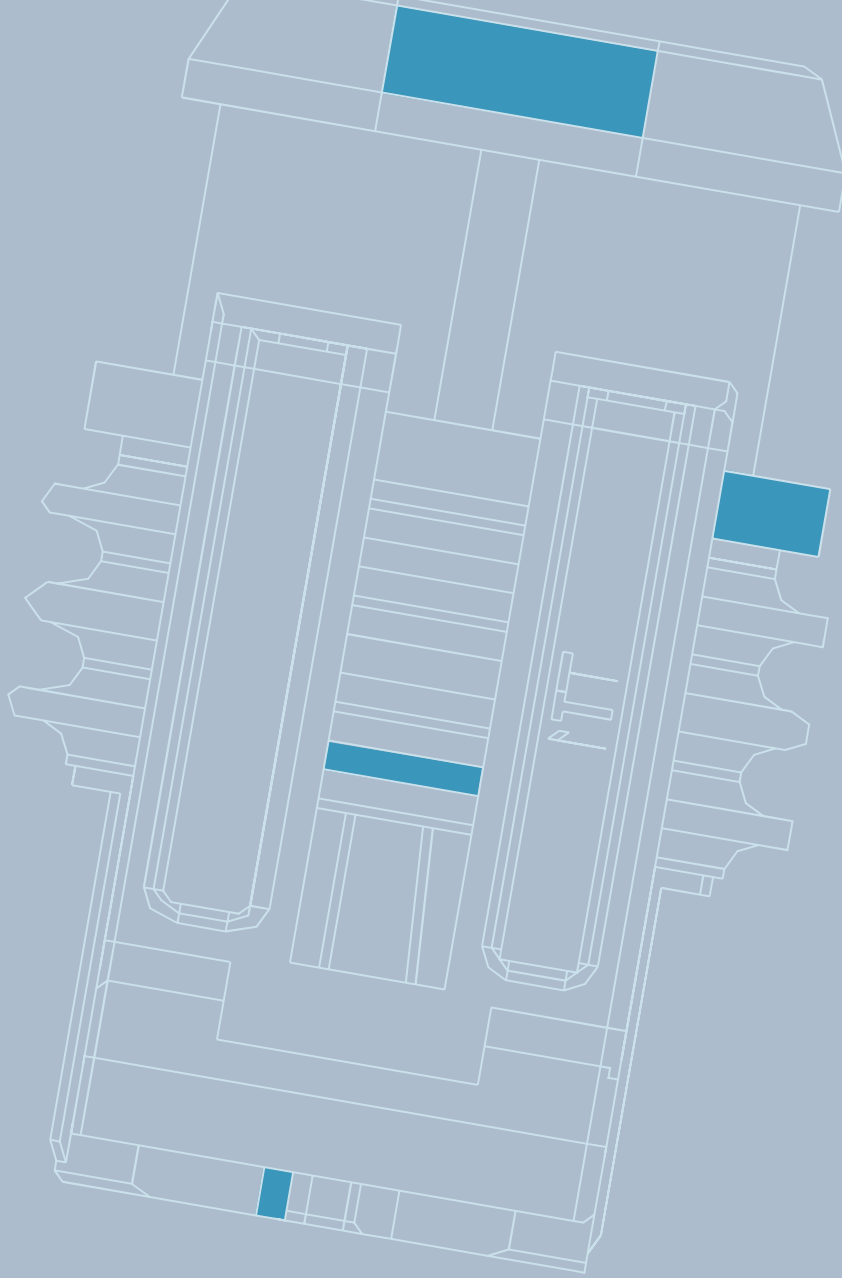



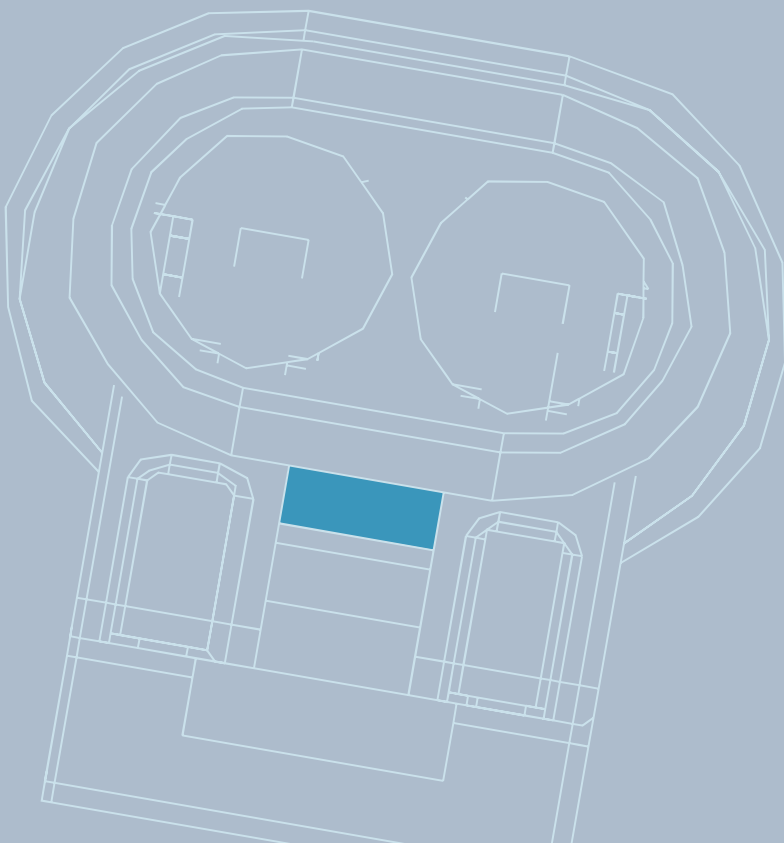



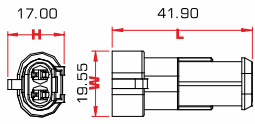

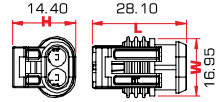

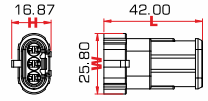

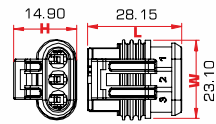

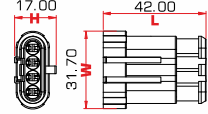
CATEGORY NO.	DESCRIPTION	APPLICABLE TERMINAL	APPLICABLE MATING CONNECTOR	MATERIAL	STANDARD PACKING QTY. [NOS.]	
TTP-1855A	Flasher Connector	TT-1755 TT-1855	Flasher	Nylon6/66/ FR	250	
TTP-HL2	2 Pole Sensor Connector	TT-2560	Sensor	Nylon66	250	
TTP-HL2R	2 Pole Sensor Connector With Right Rib	TT-2560	Sensor	Nylon66	250	
TTP-HL2L	2 Pole Sensor Connector With Left Rib	TT-2560	Sensor	Nylon66	250	
TTP-HL3	3 Pole Headlamp Connector	TT-2560	Headlamp motor	Nylon66	200	
TTP-INCAP	Cap For 2 Pole Sensor Connector	NA	Sensor Connector	PP	500	

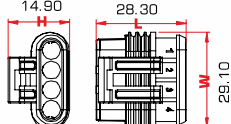

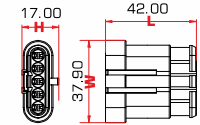
Super Seal Connectors

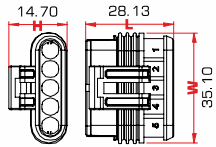

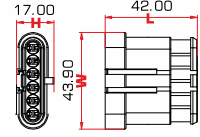

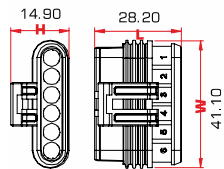
Super Sealed Connectors

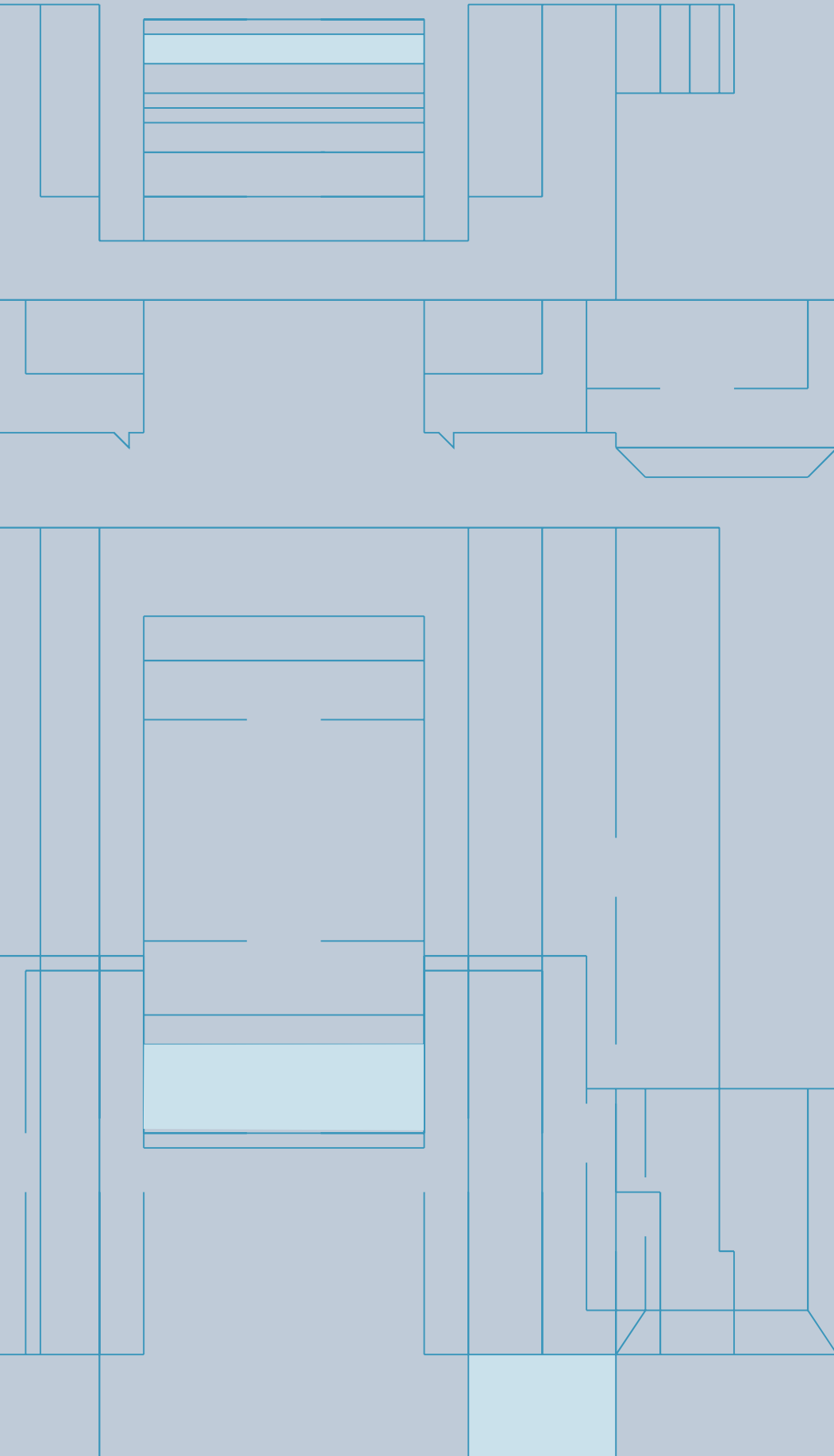
CATEGORY NO.	DESCRIPTION	APPLICABLE TERMINAL	APPLICABLE MATING CONNECTOR	MATERIAL	STANDARD PACKING QTY. [NOS.]	
TTP-SS2MN	2 Pole Super Sealed Male Connector	TT-2737	TTP-SS2FN	Nylon66 + 20%GF	500	 
TTP-SS2FN	2 Pole Super Sealed Female Connector	TT-2681 TT-1365	TTP-SS2MN	Nylon66 + 20%GF	500	 
TTP-SS3MN	3 Pole Super Sealed Male Connector	TT-2737	TTP-SS3FN	Nylon66 + 20%GF	500	 
TTP-SS3FN	3 Pole Super Sealed Female Connector	TT-2681 TT-1365	TTP-SS3MN	Nylon66 + 20%GF	500	 
TTP-SS4MN	4 Pole Super Sealed Male Connector	TT-2737	TTP-SS4FN	Nylon66 + 20%GF	300	 
TTP-SS4FN	4 Pole Super Sealed Female Connector	TT-2681 TT-1365	TTP-SS4MN	Nylon66 + 20%GF	500	 
TTP-SS5MN	5 Pole Super Sealed Male Connector	TT-2737	TTP-SS5FN	Nylon66 + 20%GF	300	 
TTP-SS5FN	5 Pole Super Sealed Female Connector	TT-2681 TT-1365	TTP-SS5MN	Nylon66 + 20%GF	500	 
TTP-SS6MN	6 Pole Super Sealed Male Connector	TT-2737	TTP-SS6FN	Nylon66 + 20%GF	300	 
TTP-SS6FN	6 Pole Super Sealed Female Connector	TT-2681 TT-1365	TTP-SS6MN	Nylon66 + 20%GF	300	 

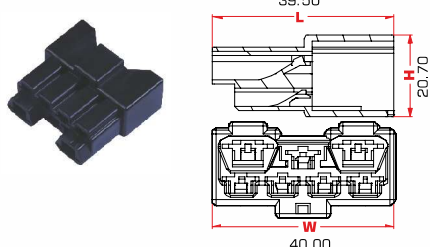
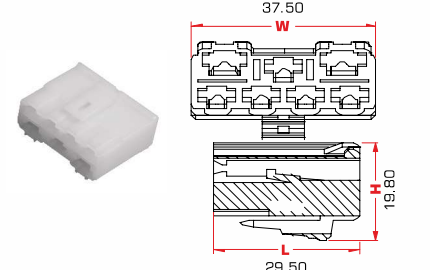
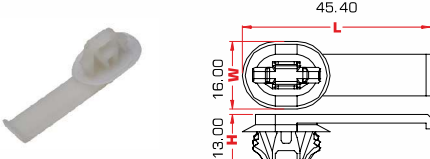
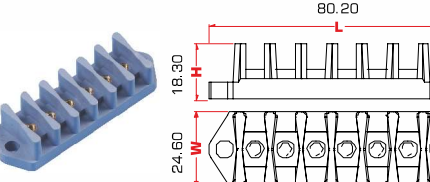
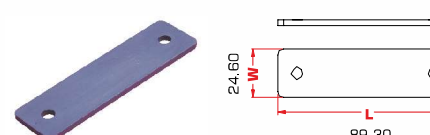
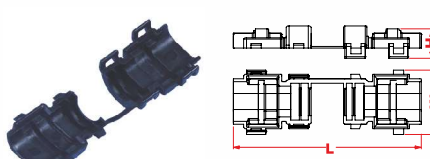

Miscellaneous Connectors

Miscellaneous Connectors

CATEGORY NO.	DESCRIPTION	APPLICABLE TERMINAL	APPLICABLE MATING CONNECTOR	MATERIAL	STANDARD PACKING QTY. [NOS.]	
TTP-07HMN	7 Pole (5+2) Hybrid Male Connector	TT-1810K TT-1509	TTP-07HFN	Nylon6/66	150	
TTP-07HFN	7 Pole (5+2) Hybrid Female Connector	TT-1967 TT-1927	TTP-07HMN	Nylon6/66	150	
TTP-TMCP	Clip	NA	-	Nylon6/66	200	
TTP-STRIP	Strip 6 Way With Nut	NA	TTP-Base	Nylon6+ 30% GF/PP- 20/PP FR	100	
TTP-BASE	Strip Base	NA	TTP-Strip	PP/HDPE FR/PP 20	100	
TTP-CH2P	Cover Housing 2 Pole Seal Sensor Connector	NA	TTP-2SSC	Nylon6/66	1000	
	2 Pole seal sensor Connector Assembly					
TTP-2SSC	2 Pole Seal Sensor Connector	-	TTP-CH2P	Nylon66+ 15% GF	1000	

Miscellaneous Connectors

CATEGORY NO.	DESCRIPTION	APPLICABLE TERMINAL	APPLICABLE MATING CONNECTOR	MATERIAL	STANDARD PACKING QTY. [NOS.]	
TTP-DC	Dignostic Cover	NA	-	PP	1000	
TTP-CHG2P	Contact Housing	TT-1478	-	Nylon66+40% GF	1000	
TTP-INCLINED CLIP	Inclined Clip	NA	-	Nylon6/66	300	
TTP-SP1	Spacer 1	NA	Fuse Bases	Nylon6/66/FR	1000	
TTP-SP2	Spacer 2	NA	TTP-RB6	Nylon6/66/FR	1000	
TTP-SP3	Spacer 3	NA	Fuse & Relay	Nylon66+10% GF /FR	1000	
TTP-SP4	Spacer 4	NA	TTP-14FB	Nylon66/FR	500	
TTP-SP5	Spacer 5	NA	TTP-23FB	Nylon66/FR	1000	
TTP-SP6	Spacer 6	NA	TTP-06MN	Nylon6/66/FR	1000	

Miscellaneous Connectors

CATEGORY NO.	DESCRIPTION	APPLICABLE TERMINAL	APPLICABLE MATING CONNECTOR	MATERIAL	STANDARD PACKING QTY. [NOS.]
TTP-SP8	Adaptor For Ttp-32max	NA	TTP-32MAX	Nylon 66	1000
TTP-SP9	Adaptor For Ttp-2868	NA	TTP-2868	Nylon 66	1000

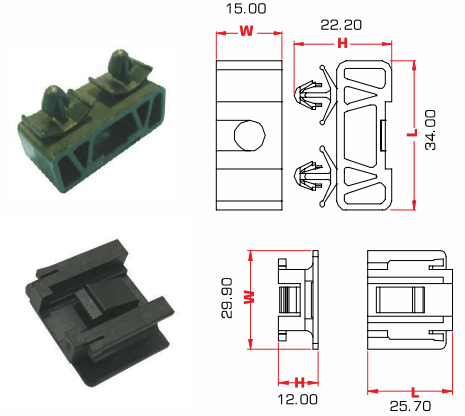

Compressor Connectors

TTP-2910	Compressor Connector	TT-2910	Fusite Pin	PBT	400
TTP-1832	Compressor Connector	TT-1832	Fusite Pin	PBT	400
TTP-2959	Compressor Connector	TT-2959	Fusite Pin	PBT	1000
TTP-2860	Compressor Connector	TT-2860	Fusite Pin	PBT	400
TTP-2861	Compressor Connector	TT-2860	Fusite Pin	PBT	400
TTP-1820	Compressor Connector	TT-2959	Fusite Pin	PBT	400
TTP-2932	Compressor Connector	TT-2932	Fusite Pin	PBT	400

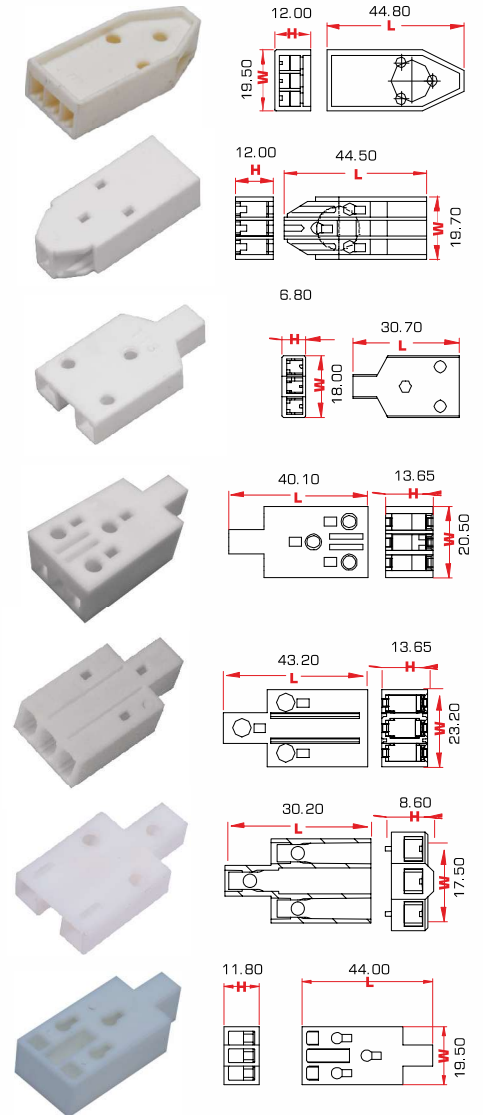

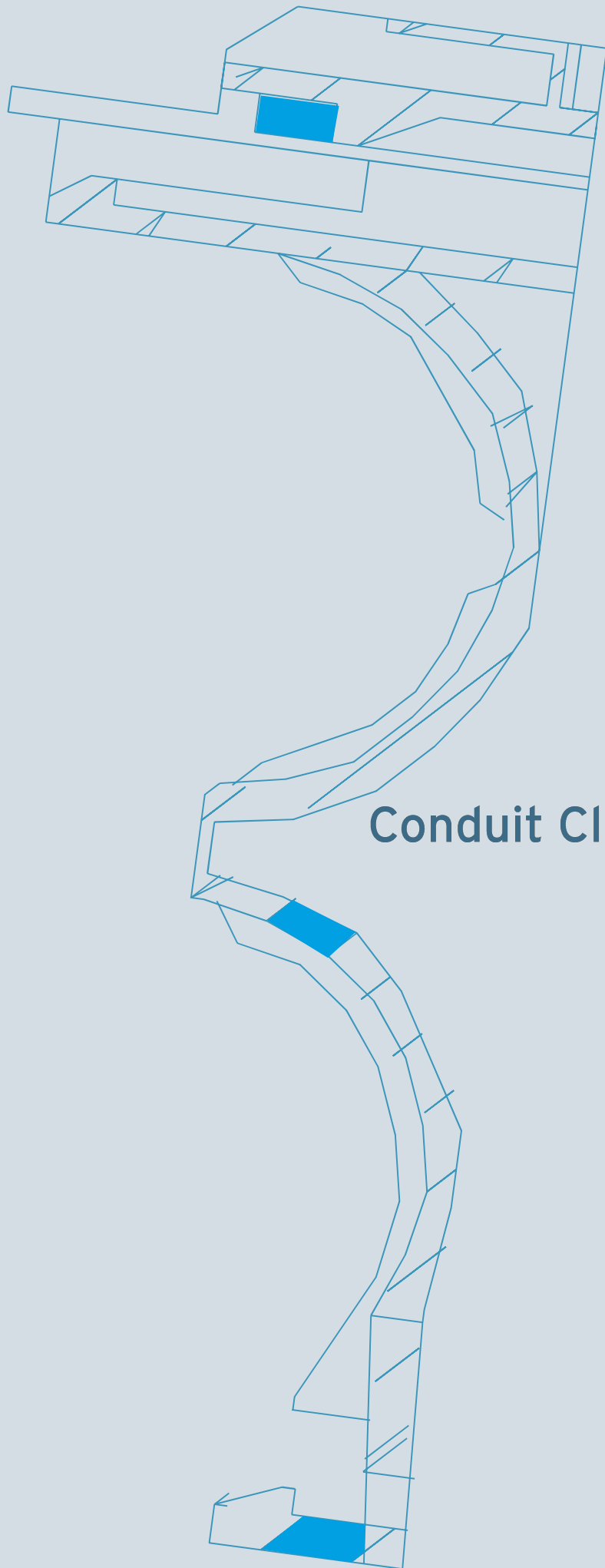
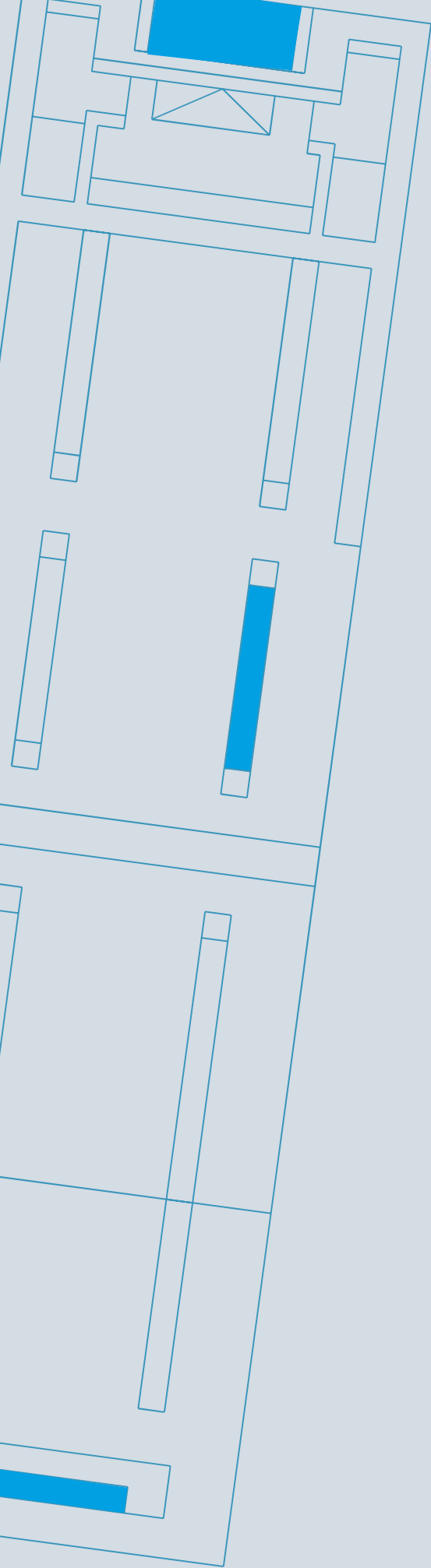

Conduit Clamps

Conduit Clamps

CATEGORY NO.	DESCRIPTION	APPLICABLE TERMINAL	APPLICABLE MATING CONNECTOR	MATERIAL	STANDARD PACKING QTY. [NOS.]	
TTP-C07	Clamp Dia 7	NA	Cot Tube	PP	400	
TTP-C10	Clamp Dia 10	NA	Cot Tube	PP	300	
TTP-C13	Clamp Dia 13	NA	Cot Tube	PP	200	
TTP-C15	Clamp Dia 15	NA	Cot Tube	PP	200	
TTP-C19	Clamp Dia 19	NA	Cot Tube	PP	200	
TTP-C22	Clamp Dia 22	NA	Cot Tube	PP	150	

CATEGORY NO.	DESCRIPTION	APPLICABLE MATING TERMINAL	APPLICABLE MATING CONNECTOR	MATERIAL	STANDARD PACKING QTY. [NOS.]	
TTP-C28	Clamp Dia 28	NA	Cot Tube	PP	100	
TTP-C08	Crocodile Clamp	NA	Cot Tube	Nylon6/66	500	
TTP-C09	Crocodile Clamp	NA	Cot Tube	Nylon6/66	250	
TTP-CC 3/8 RBC	CC 3/8 RBC	NA	-	PPCP-PHI BHF	500	