

smiths detection

A woman with long dark hair, wearing a red quilted jacket and blue jeans, is talking on a white mobile phone. She is holding a black suitcase handle in her left hand. The background is a blurred airport or travel setting. A semi-transparent red rectangle is overlaid on the image, containing the main title text.

# THE SMART CHECKPOINT SOLUTION

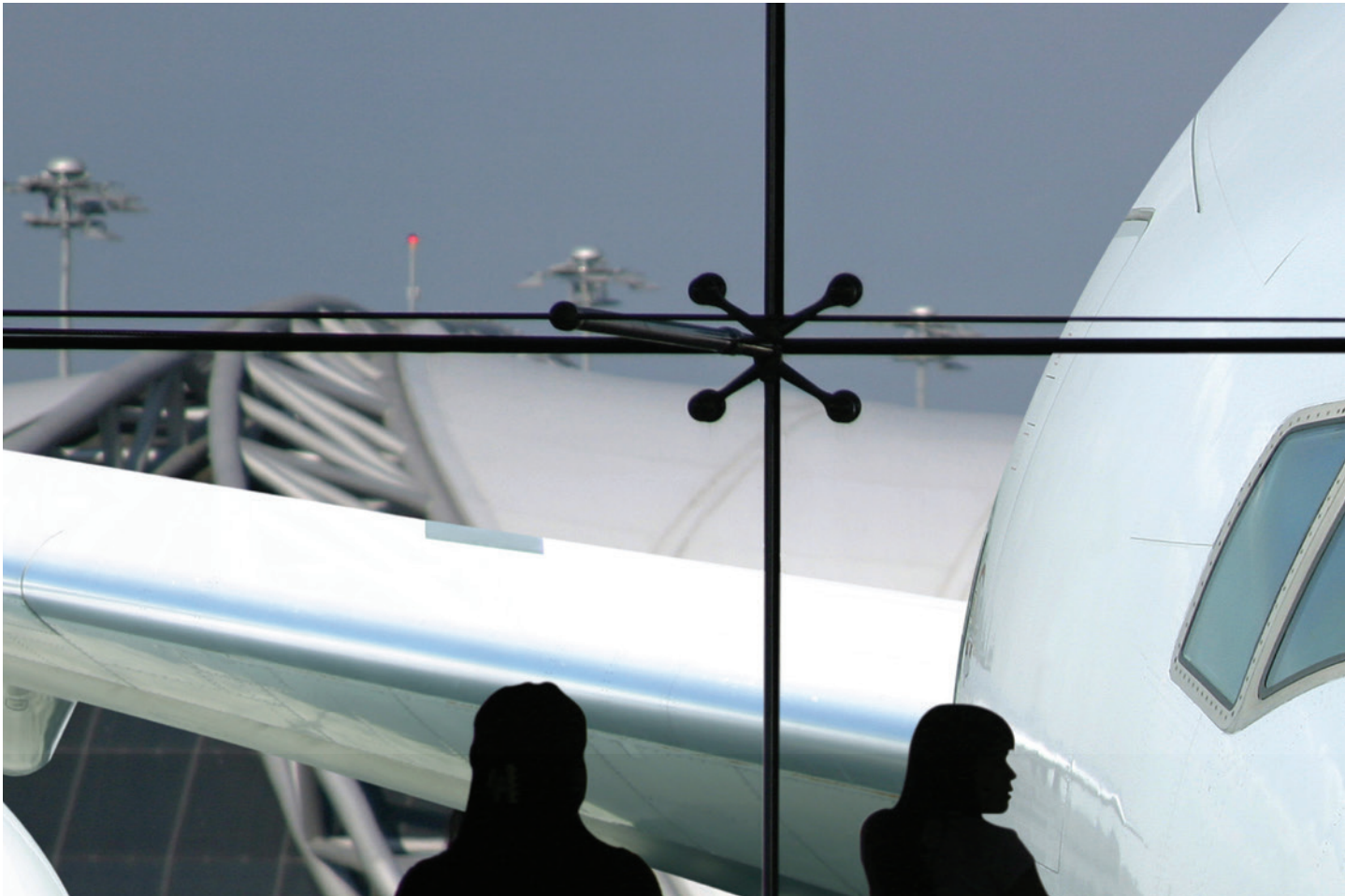



ONE SOURCE –  
ONE COMPLETE  
SOLUTION

New regulations, increasing passenger numbers and exacting business goals all present escalating challenges that demand more complex checkpoint security solutions.

Increasingly, these solutions must be both flexible and future-proof, with reliable and effective interfaces and a network to drive and monitor productivity. Smiths Detection's integrated checkpoints have been developed to support you in achieving both security and operational objectives. We provide complete solutions and support; from planning and design to commissioning, to the integration and service of the equipment during its lifespan, providing all equipment, technologies, software and support from one source.

Our strategy for development and design focuses on the checkpoint as a whole (rather than individual components) and how it affects the broader operation. To understand and manage the flow and screening of passengers properly, we consider not only how the complete system can function smoothly and efficiently, but also how it integrates with the full kerb to gate experience.

We create solutions tailored to meet your specific business and regulatory requirements, delivering a cost-effective process, increased passenger satisfaction, and sustainable commercial growth. We make it our business to understand your business: we offer current performance analysis to identify efficiencies at task level, and future performance modelling to assess the effect of changes to staffing processes and technology.

The needs of each airport are considered in developing an integrated technical solution which is supported with a clear business case. Although the building blocks may be the same, the configuration is customised to each specific location and based on open technical standards to allow incorporation of the best available technologies.

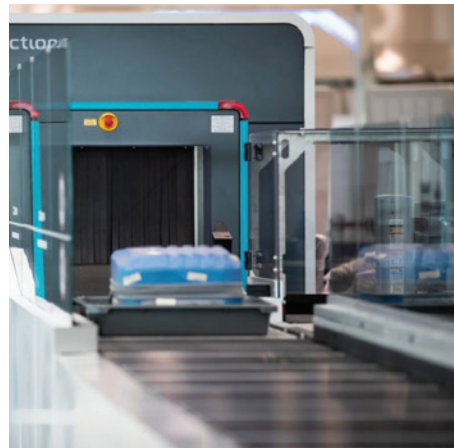

All of our checkpoint solutions are upgradeable to accommodate escalating threats and, through sustained investment in research and development, we continue to innovate to further improve performance.





# CHECKPOINTS ON WHICH TO BUILD A FUTURE



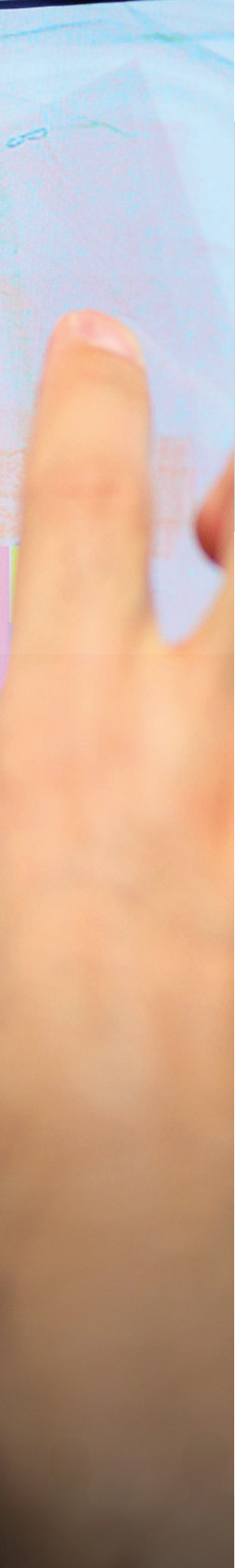

Today's airport operations are highly complex. As travel and tourism continues to grow, so do the difficulties faced by both domestic and international airports. Increasing passenger numbers, demands for service excellence, exacting business goals, as well as shifting threats and regulations are all major challenges facing the aviation industry.

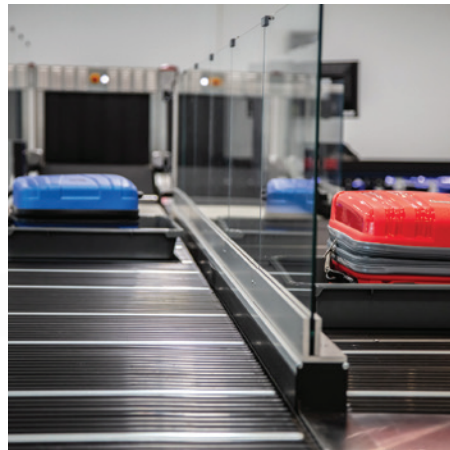

Emerging technologies, artificial intelligence, the proliferation of biometrics and new processes offer airports a world of possibilities. Tapping into these areas will go a long way in helping meet security, operational efficiency and compliance needs for many years to come. At the same time, airports also need to embrace a future that is automated and passenger-centric for their security standards and procedures to truly evolve.

As a leading supplier of security solutions for the aviation sector, Smiths Detection works closely with our customers and technology partners to help navigate constant shifts — be it catering to passenger and operational expectations, or finding new approaches to stay ahead of travel trends. Because every checkpoint is unique, we utilise modelling and simulation to customise solutions that bring out the best in our products.



We rely on our own expertise and advancements in technology to transform the movement of people and goods, with the aim of making the world a safer place.

# SMARTER CHECKPOINT SOLUTIONS

## ADVANCED X-RAY SCREENING

[➔ MORE ON PAGE 08](#)

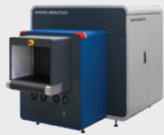

HI-SCAN 6040 CTiX

Next-generation checkpoint scanner featuring Computed Tomography (CT).



HI-SCAN 7555aTiX

Multi-view X-ray system for oversized cabin baggage.



HI-SCAN 6040aTiX

Advanced multi-view X-ray system for cabin baggage.



HI-SCAN 6040-2is HR

Dual-view X-ray inspection for cabin baggage.

Smiths Detection offers everything from standard, off-the-shelf products to complete, individually-tailored solutions. We have all the proven expertise, experience and backup you need – all from one source. Put your trust in us for high quality equipment, reliability and a global service footprint.

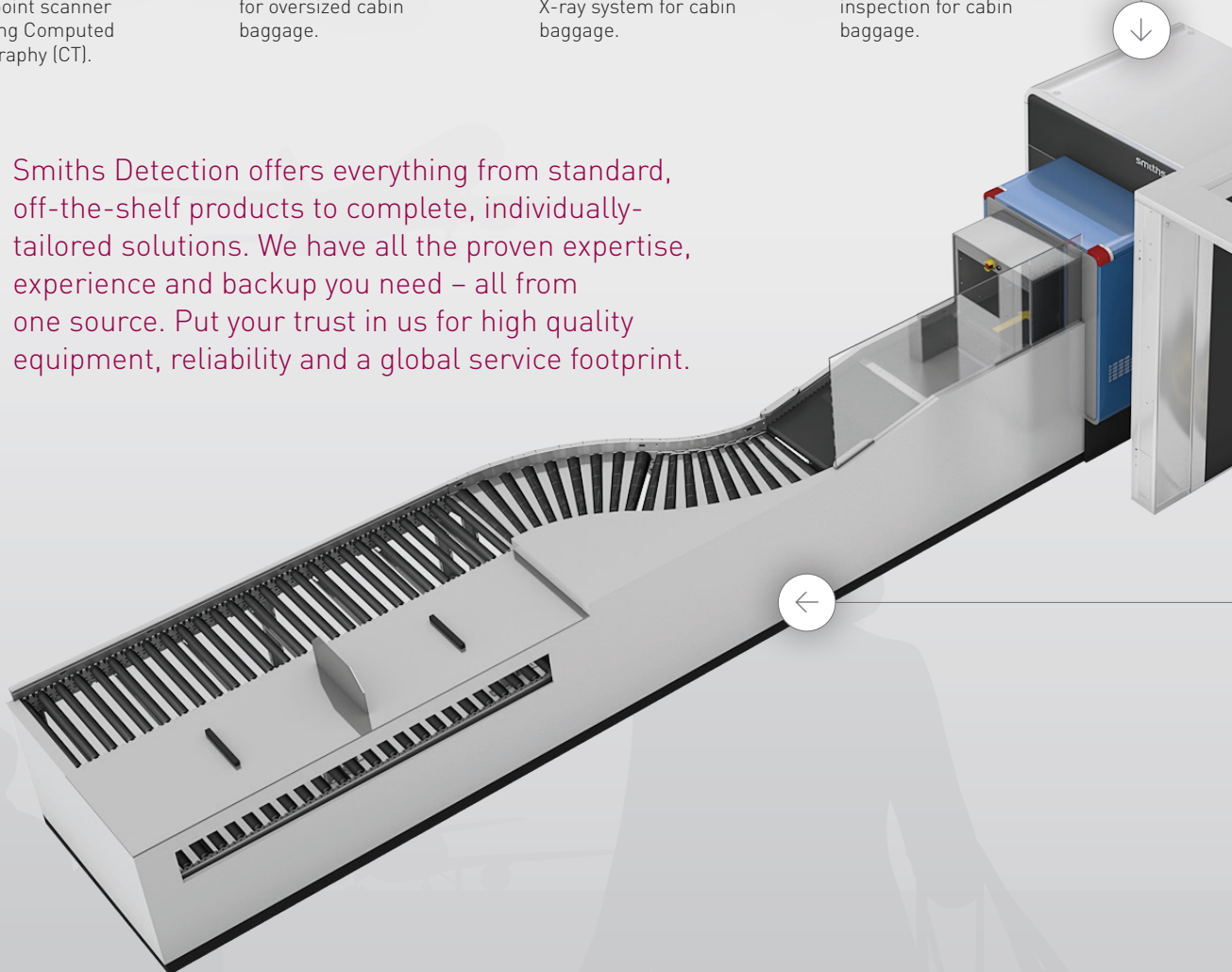



ADVANCED SCREENING & MANAGEMENT PLATFORM



Checkpoint.Evo<sup>plus</sup>

Checkpoint management software for remote screening, analysis and reporting.

➔ MORE ON PAGE 14

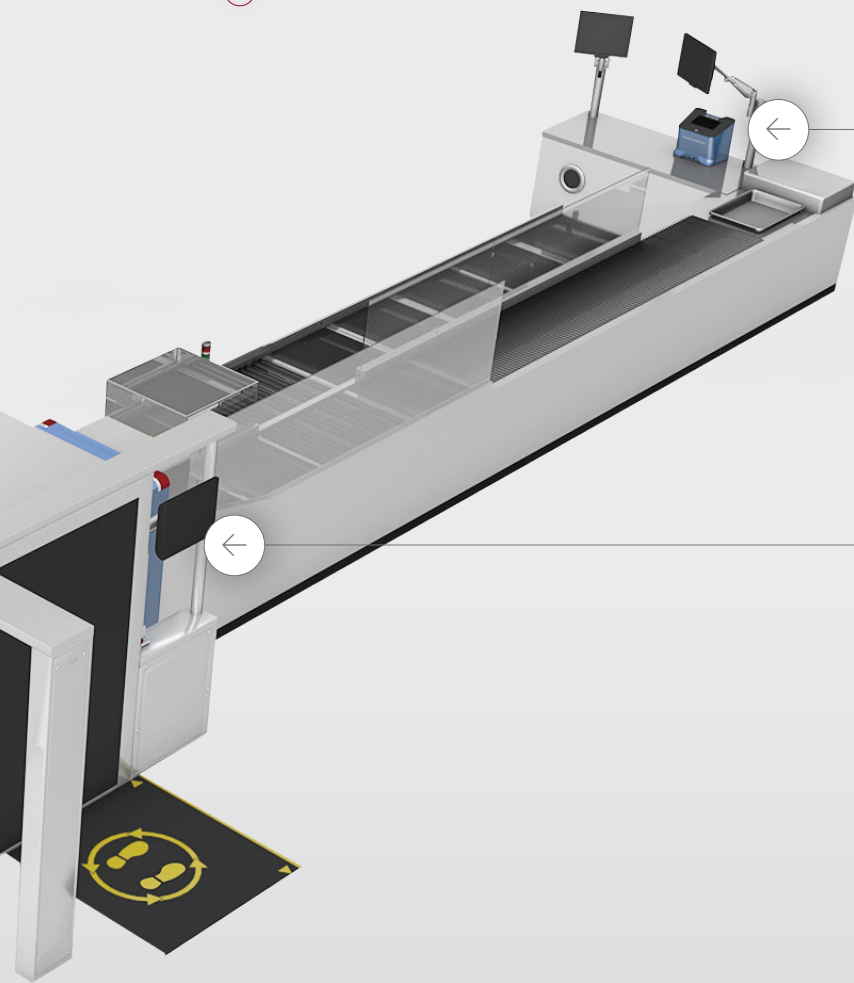
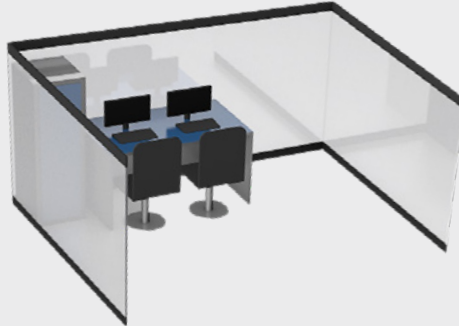

EXPLOSIVE TRACE DETECTION (ETD)

IONSCAN 600

Desktop ETD system detects traces of explosives and narcotics.

➔ MORE ON PAGE 11



PEOPLE SCREENING

eqo

Open plan people screening system based on millimetre wave technology.

➔ MORE ON PAGE 10

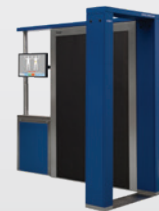

LANE DESIGN

iLane.pro

Modular tray return system for customised checkpoints.



➔ MORE ON PAGE 12

iLane.evo

Advanced and highly automated checkpoint conveyor system.

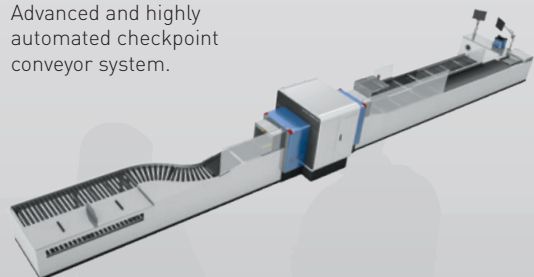

➔ MORE ON PAGE 12

# SCREENING

Screening equipment is at the heart of every checkpoint solution. Changes in regulations, increasing passenger numbers and exacting business goals are driving the reassessment of screening processes at airport security checkpoints. Regulators are looking towards the next generation of detection technology to handle ever evolving threats.

When deciding which scanner is most appropriate, it is important for each airport to examine not only the different ways in which they can comply with regulations, but also other daily challenges; current and predicted passenger traffic, operational efficiency and passenger experience are all considerations. This allows for a clear evaluation of the benefits offered by equipment operating at different certification levels.

01

## X-ray screening

Smiths Detection offers the most comprehensive portfolio of screening systems in the industry, covering the complete range of EDS CB approvals. Whether you require a single, dual, or multiview scanner or are looking for even more automation with an advanced computed tomography system, we have the technology and products to meet your needs. With over 40 years' experience and more than 75,000 X-ray systems delivered worldwide in more than 180 countries, we are here to help you understand how the benefits of each option will affect your operation.



## HI-SCAN 6040 CTiX



NEXT-GENERATION CHECKPOINT SCANNER FEATURING COMPUTED TOMOGRAPHY (CT)

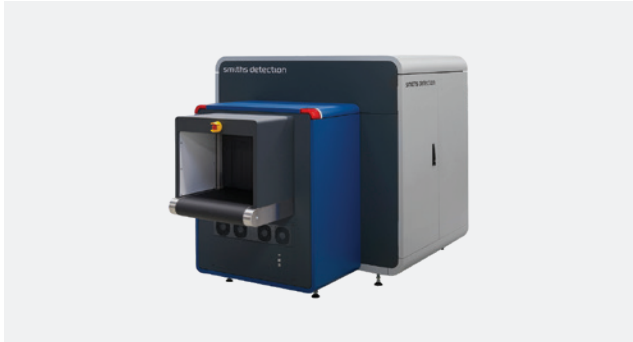

- ECAC EDS CB C2/C3 & TSA APSS
- Screen liquids and large electronics in bags
- Computed Tomography
- 620 x 420 mm
- 0.2 m/s

## HI-SCAN 7555aTiX

MULTI-VIEW X-RAY SYSTEM FOR OVERSIZED CABIN BAGGAGE



- ECAC EDS CB C1/C2 & TSA AT-2
- Screen large electronics in bags
- Multi-View
- 755 x 555 mm
- 0.2 m/s

## HI-SCAN 6040aTiX



ADVANCED MULTI-VIEW X-RAY SYSTEM FOR CABIN BAGGAGE



- ECAC EDS CB C1/C2 & TSA AT-2
- Screen large electronics in bags
- Multi-View
- 620 x 418 mm
- 0.2 m/s

## HI-SCAN 6040-2is HR



DUAL-VIEW X-RAY INSPECTION FOR CABIN BAGGAGE



- ECAC EDS CB C1
- No random checks - remove liquids and electronics
- Dual-View
- 620 x 420 mm
- 0.2 m/s

02

## People screening

With state of the art people-screening systems with automatic detection capability, we can improve security and provide a better experience for both passengers and staff. Smiths Detection's eqo features an open, user-friendly design, minimal footprint allowing easy integration into checkpoints, and instant presentation of results for high throughput. The unique, flat-panel, millimetre-wave technology enables the automatic multi-material detection of any concealed objects such as metals, ceramics, plastics, liquids and narcotics.

### eqo

#### PEOPLE SCREENING WITH AUTOMATIC DETECTION

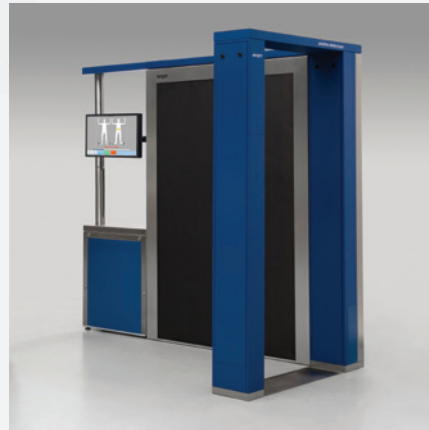

#### FEATURE HIGHLIGHTS

- ECAC Standard 2 certified people screening system
- Automatic detection for full privacy
- Multi-material detection – including metals, ceramics, plastics, liquids etc.
- Minimal footprint - allows for easy checkpoint integration
- Operational cost savings – less staffing, infrastructure, training



03

## Explosive Trace Detection

The increasing variety of explosive threats requires new and improved trace explosives detection capabilities for secondary screening at aviation checkpoints. The IONSCAN 600 is a highly-sensitive trace detector, in a lightweight, portable desktop configuration. It can be used to accurately detect and identify a wide range of military, commercial and homemade explosives threats and common, illegal/controlled narcotics in less than 8 seconds for improved operational efficiency.

### IONSCAN 600

PORTABLE EXPLOSIVES AND NARCOTICS TRACE DETECTOR



#### FEATURE HIGHLIGHTS

- Detection and identification in less than 8 seconds
- Simultaneously detects and identifies explosives and narcotics
- Non-radioactive IMS source
- Small, lightweight and portable
- Optional integrated printer
- Single use, disposable sampling swabs
- Approved/certified by ECAC, CAAC and TSA (Air Cargo)

# LANE DESIGN

**An effective lane with a tray handling system is a primary checkpoint component. By delivering a steady flow of trays, it plays a critical role in streamlining the screening process. It also delivers the subsequent benefits of increased throughput, lower per capita costs and an improved passenger experience.**

Innovations in lane design and function can help take the overall checkpoint solution to the next level by removing bottlenecks and literally keeping the process moving. The iLane from Smiths Detection features the latest developments and addresses the key issues of passenger divestment, tray loading and return, and the re-routing of suspicious items.



## CASE STUDY: AALBORG AIRPORT

With passenger numbers rising year-on-year, Denmark's Aalborg Airport is continuing to leverage the latest technology to increase the speed and efficiency of its security checkpoints. The latest phase in this impressive transformation was the introduction of intelligent lanes which has improved throughput by a further 80% and made an equally positive impact on the passenger experience.

## iLane.evo

---

### SMART LANE DESIGN

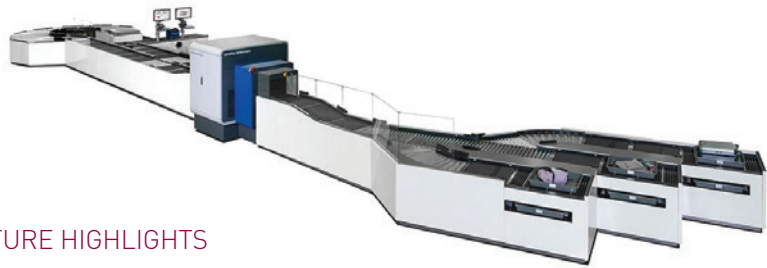

#### FEATURE HIGHLIGHTS

- Modular design
- Motorised automatic tray return
- Various parallel divest options
- Automatic bag diverter
- Defined interfaces for remote screening integration

## iLane.pro

---

### MODULAR CHECKPOINT



#### FEATURE HIGHLIGHTS

- Huge variety of modules
- Modular passive and motorized conveyors
- Gravity-driven manual tray-return system
- Ready for remote-screening integration
- Ideal for compact checkpoints or low- to medium-throughput checkpoints





# ADVANCED SCREENING & MANAGEMENT PLATFORM

Checkpoint.Evo<sup>plus</sup> is a digital-led solution that helps checkpoints achieve the highest level of security and improved operations by delivering critical insights and enabling remote screening.

The Checkpoint.Evo<sup>plus</sup> intelligence software analyses data from various systems, sensors and components from across an entire screening area to generate a full range of invaluable insights. This data makes it easy to monitor performance metrics in real-time for faster and better decision-making.

Consolidated KPIs provide an overall view of the system status with clear audio and visual notifications drawing attention to any changes in the customised performance thresholds. It also generates historical data and reports required for resource planning and general administration. KPIs can be monitored and shared via a central

dashboard which can also be accessed from mobile devices.

Networked images can be collected from all security lanes and delivered to a team of operators based at a remote location, away from the distractions of the busy checkpoint. Suspicious areas are marked and classified on the images, so staff at the checkpoint know exactly where to focus secondary inspections.

Checkpoint.Evo<sup>plus</sup> is compatible with both 2D and 3D screening, allowing for the benefits of the software to continue when upgrading to a 3D system, such as the HISCAN 6040 CTiX.

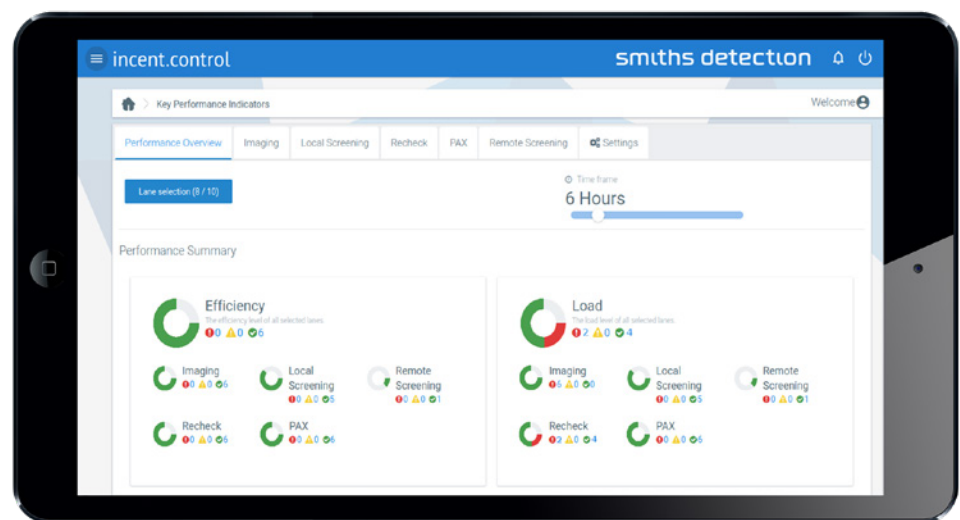

#### FEATURE HIGHLIGHTS

- Central screening and directed search
- Real-time and historical data
- Optimised resource planning
- Faster decision-making
- Customised performance thresholds
- Clear audio visual notifications

Checkpoint.Evo<sup>plus</sup> is an indispensable part of your future security operations.





## iCMORE

Our family of smart AI-based object recognition algorithms for the automatic detection of an expanding list of dangerous and prohibited items has the potential to enable further automation at the checkpoint.

# INNOVATION

We are exploiting the progress in biometrics, artificial intelligence (AI) and integrated screening technologies to develop solutions which can support risk-based screening (RBS), enhanced detection capabilities and operational improvements.



Increasing passenger numbers, the need for ever-greater efficiency, emerging threats, digital transformation at airport level and advances in technology are all driving innovation to help address these challenges.

### TRANSFORMING THE CHECKPOINT WITH BIOMETRICS

Integrating biometrics into the checkpoint can deliver a host of benefits including improved security, operational efficiency and a seamless passenger experience.

Matching passengers with their trays is a key enabler for risk based screening (RBS). It allows for differentiated levels of screening to be applied to individual passengers and their belongings based on criteria such as flight or destination. Screening resources can be used more efficiently and the overall security outcome is improved.

It enables the sharing of screening results between departure and transit or arrival airports. As the information can be used multiple times across the network, this approach delivers significant benefits to airlines, airports, regulators and controlling authorities. Additionally, for the first time, insights gathered during the screening process can be analysed on airline, destination or flight level.

### OPEN ARCHITECTURE

We are developing an open architecture approach and already offer integration with third party equipment via a universal interface. To support the exchange of scanned images between suppliers and hardware without affecting regulatory certification, we are actively engaged in policy discussions around the adoption of DICOS as an open data format.

### CYBER SECURITY

With security screening becoming ever more data-driven and networked, cyber security is increasingly important and we always aim to maintain the highest possible standards throughout the lifecycle of our products – from concept to manufacture, to installation, operation and finally, their decommissioning.



Our solutions are constantly evolving to keep up with the demands of both today and tomorrow, and to bring you the very latest in security screening technology.

# PROCESS, PEOPLE & TOOLS

**Creating the optimum passenger checkpoint requires specialist input and guidance throughout the complex process of consultation, planning, design and implementation.**

The Smiths Detection Checkpoint Solutions Team has the experience, knowledge and tools to create and deploy the best solutions to meet your specific operational, business and regulatory demands.

Extensive research into space and location within the airport, passenger culture and behavioural patterns, and the various objectives and goals for your business provide the information we need to create the right checkpoint, with performance prediction using dedicated software.

We understand the challenges and requirements of the checkpoint and will work with you every step of the way to meet your expectations.





## CHECKPOINT SOLUTIONS TEAM

### ACCOUNT MANAGER

Your central point of contact at Smiths Detection. There to support you throughout the checkpoint process and beyond.

### SOLUTION ARCHITECT

Key to the critical planning stage. Consults with you to understand and analyse your requirements and then develops and validates a design using modelling and simulation tools.

### PROGRAMS MANAGER

Keeps the project moving to ensure you get what you need to schedule. Ensures each stage is executed correctly and at the right time. Co-ordinates between you, Smiths Detection and any third parties.

### FIELD SERVICE ENGINEER

Experienced technicians install and commission your checkpoint and ensure your solution operates in peak condition throughout the lifecycle of your investment. Smiths Detection engineers have a proven track record of excellent service and customer satisfaction.

## OUR PROCESS - THE 5 STEPS TO SUCCESS

01

UNDERSTANDING YOUR REQUIREMENTS

02

ONSITE DATA COLLECTION, PASSENGER SURVEYS

03

PERFORMANCE SIMULATION &amp; SOLUTION MODELLING

04

IMPLEMENTATION

05

ONGOING SUPPORT





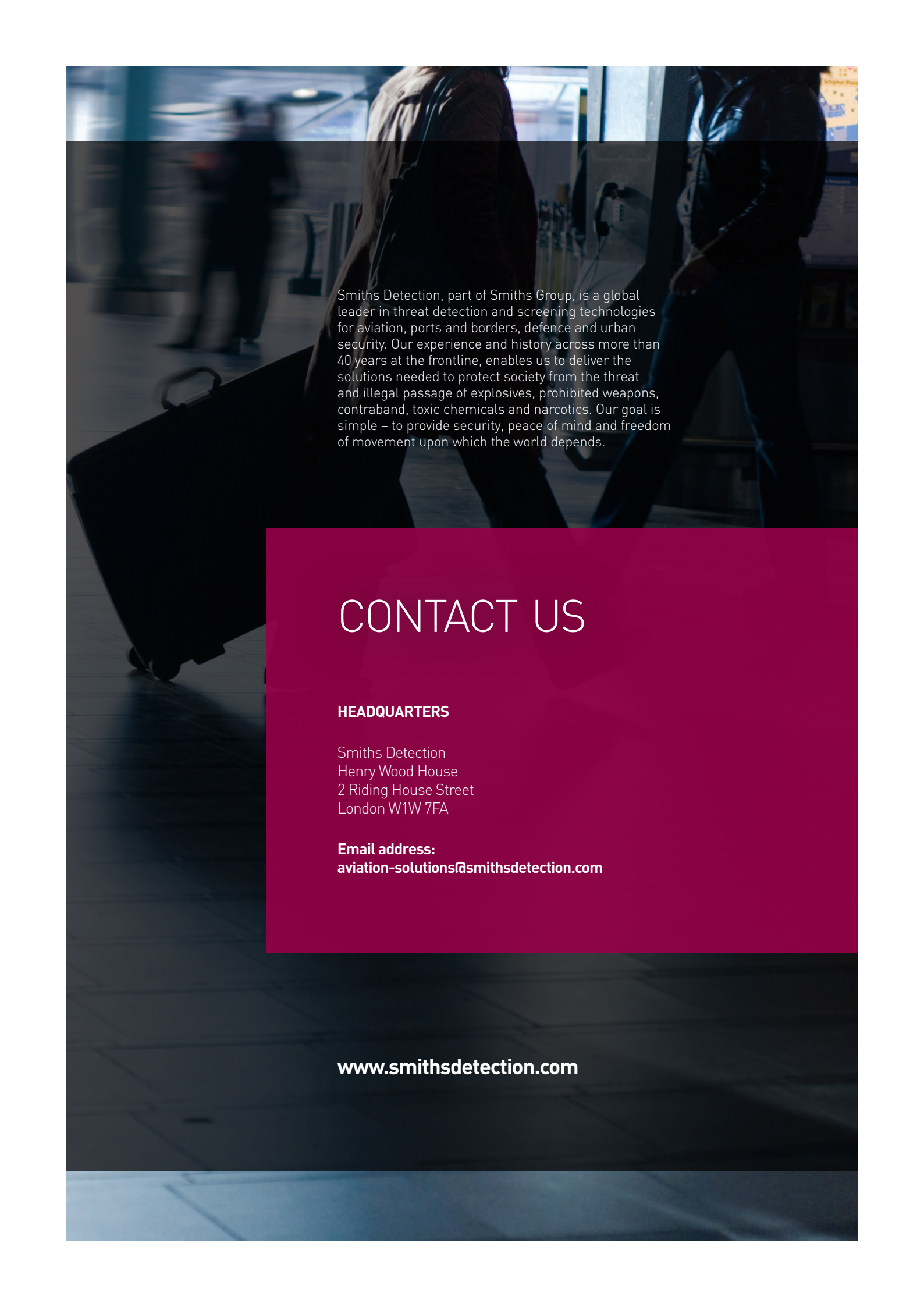

Smiths Detection, part of Smiths Group, is a global leader in threat detection and screening technologies for aviation, ports and borders, defence and urban security. Our experience and history across more than 40 years at the frontline, enables us to deliver the solutions needed to protect society from the threat and illegal passage of explosives, prohibited weapons, contraband, toxic chemicals and narcotics. Our goal is simple – to provide security, peace of mind and freedom of movement upon which the world depends.

## CONTACT US

### HEADQUARTERS

Smiths Detection  
Henry Wood House  
2 Riding House Street  
London W1W 7FA

**Email address:**

**[aviation-solutions@smithsdetection.com](mailto:aviation-solutions@smithsdetection.com)**

**[www.smithsdetection.com](http://www.smithsdetection.com)**