



The Discrete DAC

User Guide

Check our website for the most recent user guides, firmware, and drivers:
www.msbtechnology.com

Technical support email is:
techsupport@msbtech.com

01.22.2020

Technical specifications

Supported Formats (Input dependent)	44.1kHz to 3,072kHz PCM up to 32 bits 1xDSD, 2xDSD, 4xDSD, 8xDSD Supports DSD via DoP on all inputs
Digital Inputs	1x XLR 1x Coaxial RCA 2x Toslink 1x Word-Sync Output (BNC) 2x Advanced isolated input module slots
XLR Analog Outputs	3.57Vrms Maximum (Digital Input) 12Vrms Maximum (Analog Input) Galvanically isolated
Base XLR Output	300 Ohm Balanced (High Gain) 150 Ohm Balanced (Low Gain)
Base RCA Output	120 Ohm
Volume Control	1dB steps (Range 0 - 106). Volume Control can be disabled in the menu.
Display	Custom discrete LED audio clock synchronous display Adjustable brightness and auto-off feature
Controls	Isolated RS-232 IR Remote Knob + 3 Buttons
Chassis Dimensions	Width: 17 in (432 mm) Depth: 12 in (305 mm) Height without feet: 2 in (51 mm) Stack height: 2.65 in (68 mm) Weight: 18 lbs (8.2 kg) Product Feet: M6X1 Thread
Shipping Dimensions	Width: 22 in (559 mm) Depth: 18 in (457 mm) Height: 7 in (177 mm) Weight: 27 lbs (12.3 kg)
Included Accessories	User Manual MSB Remote Micro USB charging cable 4x Rubber Feet 4x Plastic inserts for feet

Setup and Quick Start

The interface is quite simple with few user controls. Input source defaults to auto switching. The display will let you know if you have an active input. On power up, the volume is reset to the programmed startup level. Shipping default is 70. Turn the volume knob up until you hear music.

Power	The DAC comes with a high performance Power Supply. The power supply can be switched between 240V and 120V. This is not a switching supply that works at any voltage. The power supply is switched on and off with a button on the back. The LED in the back of the power supply indicates green when ON. Always allow three to five hours for the DAC to warm up and reach optimal operating temperature.
Inputs	The DAC comes with the digital input modules of your choice. Connect any digital input to any active digital audio source. The frequency and bit depth of the incoming signal will be displayed on the front panel.
Outputs	Connect the balanced analog outputs to any amplifier. The output level is controlled with the knob or remote.

When stacking the units, you will find enclosed black plastic square inserts. These inserts fit into the square holes in the top of each chassis. This will allow you to stack the units without scratching the chassis.

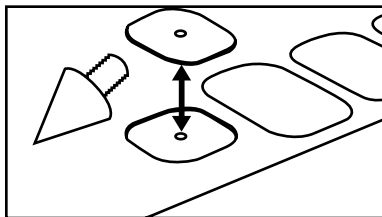

Burn-In

The feedback we receive leads us to recommend at least 100 hours of burn-in on this DAC. Customers generally report improvement up to one month.

Front Panel User Interface

Menu Button	The square button is single purpose. It will enter the setup mode at the top of the menu tree. If in the setup, and it doesn't matter where, this button will exit the setup and return to the normal operational mode.
Input Selection	The right and left arrows switch inputs. The 'Auto' mode will be in the list of inputs. The right and left arrows switch inputs. If 'Auto' is selected, the unit will automatically switch inputs based on priority (Input slot B is higher than Input slot A) with the analog input being lowest priority. When a source with a higher priority becomes active, the unit will automatically switch to the new higher priority input. Toggling through the inputs manually will defeat any auto switching. When in the setup menu the arrows move right and left through the menu structure.
Volume Knob	This knob adjusts the volume between 0 and 106.
Display	The display shows the Input, sample rate, bit depth, and volume.

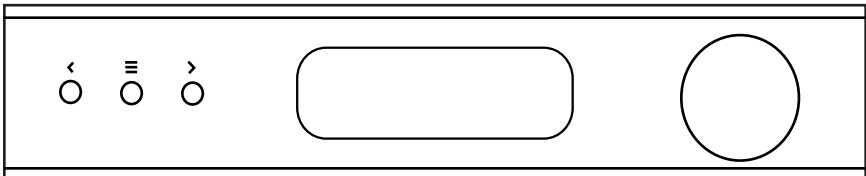

Single Discrete Power Supply Adapter

When using a single Discrete Power Supply, use the supplied power adapter to ensure both the digital and analog circuitry receive power.

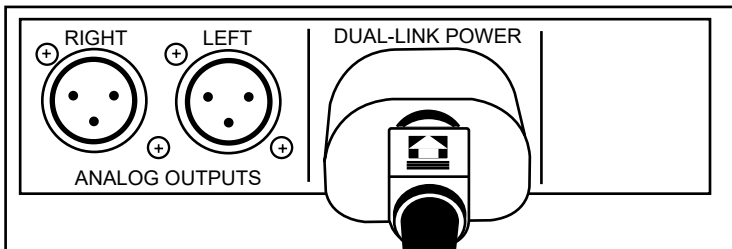

About the 2 input module slots

The DAC has two input module slots. They are labeled A and B. Input modules can be placed in any position. Each module is completely self contained. It is recognized by the DAC and identified on the display. When the module is not in use it is disabled.

Available Digital Input Modules

ProI ² S	MSB proprietary interface for use with MSB transports. This module provides two inputs.
XLR S/PDIF	A single XLR digital input with a word sync output.
Optical/Coaxial S/PDIF	A Toslink and Coaxial digital input with a word sync output.
MQA USB	A single USB interface for playback via a computer based device. This module provides support for MQA decoding. (See USB manual for operation and setup details)
Renderer	A renderer interface for use on a home network or server. (See Renderer manual for operation and setup details)
Pro ISL	MSB proprietary interface for use with MSB transports. This module provides one input.

Output Modules

Balanced output	Offers one set of balanced analog outputs. Provides volume control.
-----------------	---

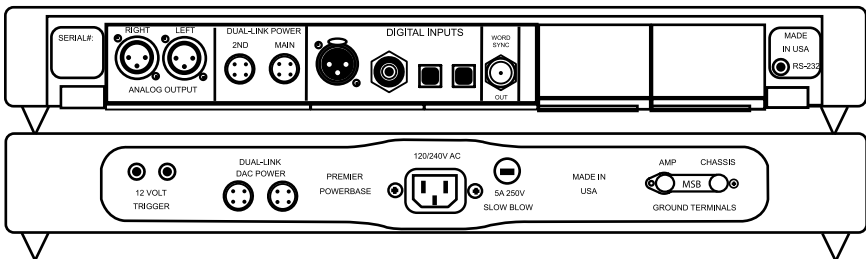

Removing and Installing Modules

Removal and installation of modules is a completely tool free process that is easily performed at the back of the unit. Under the lower lip of each module is a lever arm. Simply pull the lever out and away until it is perpendicular with the back of the unit. Then gently, but firmly, pull the module lip and lever until the module releases and slide it out of the unit. Refer to the “Module Handling” portion of your manual.

Module Handling

It is important that you refrain from touching the circuit board or rear connector of any input or output module when removing or installing any input or output module from your DAC. When handling these modules it is important that you only contact the metal case of the module or the front edge of the module where the cam arm is located. Improper handling of your modules can result in static shock and damage to the module or DAC.

Setup Menu Options

Brightness (Display brightness)	This can be adjusted from 1 - 10 (Default 8)
Display (Display On/Off)	<p>On (Default)</p> <ul style="list-style-type: none"> • The display is on continuously <p>Auto off</p> <ul style="list-style-type: none"> • The display is off but will turn on momentarily when information changes
Volume (Startup volume)	<p>0 - 100 (Default 70)</p> <ul style="list-style-type: none"> • The startup volume can be adjusted from 0 - 100 or disabled <p>Off</p> <ul style="list-style-type: none"> • In this mode, the volume control is disabled <p><i>Note: If you choose to use the DAC with an external preamp, we recommend turning the volume control off. To do this, turn the knob past 100 to "off"</i></p>
Output (Output Level)	<p>Low</p> <ul style="list-style-type: none"> • -6dB output level with a 75Ω output impedance. This setting is recommended if you decide to use an external preamp <p>High (Default)</p> <ul style="list-style-type: none"> • Standard output level with a 150Ω output impedance
Switch (Input switching)	<p>Manual</p> <ul style="list-style-type: none"> • Only allows manual switching between active and previously active inputs. The 'Auto' mode is not available <p>Smart (Default)</p> <ul style="list-style-type: none"> • Allows manual and auto switching between active and previously active inputs <p>Normal</p> <ul style="list-style-type: none"> • Allows manual and auto switching between all installed inputs

Setup Menu Options (continued)

Reset	• This restores the DAC to default factory settings
SN:DI#####	This screen displays the DAC serial number
Code	This screen displays the currently installed firmware

Saving Menu and Startup Settings

When changing settings in the menu, use the enter button in the center of your volume wheel on the remote or the right arrow on the DAC faceplate to confirm settings in the DAC menu. After you have made your changes in the DAC menu, use the menu button to exit the DAC menu completely to save the changes you have made in the DAC menu.

The DAC will not save any of your settings until you exit the menu.

The “Action Buttons” on your remote change certain settings on your DAC without navigating the DAC menu (Phase Invert and Video Mode). However, these settings reset every time the DAC is reset or powered off. If you would like these settings to persist through resets or power offs, you simply have to choose the action button setting that you wish to be default and then enter and exit the DAC menu by double clicking the Menu button on your remote or DAC faceplate.

If at any point the DAC seems to be improperly setup or you want to start fresh with your settings and functions, there is a “Reset” option near the end of the DAC menu. Simply select this and confirm “YES” before closing the DAC menu and restarting the unit.

The MSB Remote

1	Indicator LED	While in use: <i>White</i> - Command Sent <i>Red and White</i> - Command Sent and Low Battery <i>Red Flashing</i> - Needs Charging While charging: <i>Red</i> - Charging <i>White</i> - Fully Charged
2	Power	Powerbase on and off. When the powerbase is linked to an amplifier or MSB product, this button will turn off the entire system
3	Input	Toggles directly through DAC inputs
4	Action 1	Toggles phase invert
5	Action 2	Toggles video mode
6	DAC Menu	Enter DAC menu While in menu: <i>Up</i> - Volume Up <i>Down</i> - Volume Down <i>Enter</i> - Mute <i>Return</i> - DAC Menu
7	Volume	The center scroll wheel controls DAC volume
8	Mute	DAC mute
9	Track Backward	Skip/scan backward <i>(MSB Transport Only)</i>
10	Play/Pause	Play and pause <i>(MSB Transport Only)</i>
11	Track Forward	Skip/scan forward <i>(MSB Transport Only)</i>
12	Eject	Eject media disc <i>(MSB Transport Only)</i>
13	Stop	Stop media <i>(MSB Transport Only)</i>
14	Track Repeat	Track or album repeat <i>(MSB Transport Only)</i>
15	Charging Port	Micro-USB to charge the remote battery

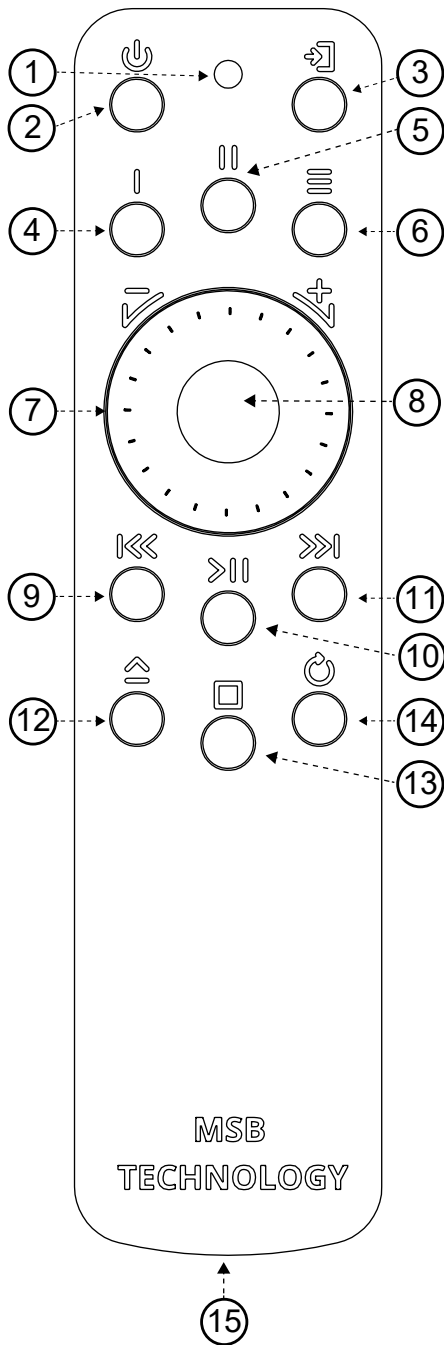

Loading new firmware

Always be certain that you are updated with the current firmware by checking our website. The DACs' firmware is always updated using a .WAV file. If you experience issues with playback of the update file, be sure to check for bit-perfect playback in your system.

All firmware updates can be found at:
www.msbtechnology.com/Support

Bit-Perfect Source Testing

The following files can be downloaded from the MSB website to verify bit-perfect playback on any transport:

16 bit x 44.1 kHz sample rate file.	24 bit x 44.1 kHz sample rate file.
16 bit x 48 kHz sample rate file.	24 bit x 48 kHz sample rate file.
16 bit x 88.2 kHz sample rate file.	24 bit x 88.2 kHz sample rate file.
16 bit x 96 kHz sample rate file.	24 bit x 96 kHz sample rate file.
16 bit x 176.4 kHz sample rate file.	24 bit x 176.4 kHz sample rate file.
16 bit x 192 kHz sample rate file.	24 bit x 192 kHz sample rate file.

They are .WAV test files that when played, will be identified by the DAC and checked, and will be reported on the display if they are bit-perfect. If there is a problem with the test, it will play but the display will not indicate any change. Be sure up-sampling is turned off in any transport as this prevents a file from remaining bit-perfect. This system will allow you to easily test your source, especially computer sources, to see if all your settings are correct. There are files at all sample rates for both 16 bit and 24 bit operation.

Premier Powerbase Upgrade

The powerbase contains isolation technology. The powerbase detects the input voltage and switches to 120 volt or 240 volt operation. It is also available in a fixed 100 volt configuration. All powerbases have over-voltage protection.

Two fuses are provided:

- 5A 250V SLO BLO - 5 mm x 20 mm miniature fuse (This is the main fuse).
- 100mA 250V SLO BLO - 5 mm x 20 mm miniature fuse (This is for the standby supply only).

Powerbase Controls

There is one button on the front of the powerbase as well as two control features just under the front of the powerbase on the bottom.

LED indications	<p>White - Power on. Red - Power off. Amber - Linked mode, 12 volt trigger controlled. Flashing Amber - Over-voltage protection.</p>
Display brightness	This is a rolling wheel to control the brightness of the power indication light
Power control	<p>Normal - This sets the powerbase as the 12 volt trigger master. Linked - This sets the powerbase as the 12 volt trigger slave. The 'master' powerbase will control this unit.</p>

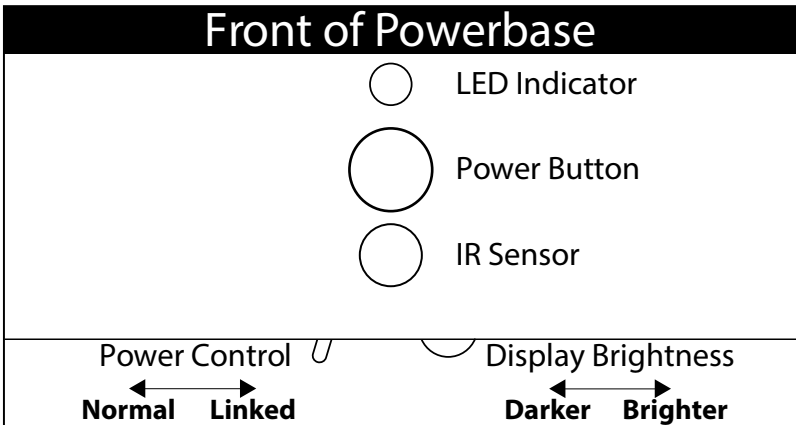

Ground Jumper IN - Basic Operation

The Basic Operation provides isolation only for the DAC. This gets you half the protection available. For full protection, be sure the jumper is in place between the Chassis Ground and Amplifier Ground. This is the shipping configuration. **NEVER OPERATE WITHOUT THE JUMPER OR A GROUND WIRE ATTACHED.**

Ground Jumper OUT - Enhanced Operation

The Enhanced Operation provides isolation for both the DAC and the amplifier. This gets you the full isolation available. With the jumper disconnected, connect the supplied ground wire from the AMPLIFIER GROUND lug to the chassis of the amplifier. Note this connection is dependent on the amplifier so you will have to look for the best place to attach the wire. Generally the easiest place would be to loosen a screw on the Amplifier Chassis and slip the open Spade lug under the screw head and tighten the screw. The only other place a true ground may be found is on the ground pin of the power connector to the AMP but this will not be easy to connect too.

Grounding Diagram

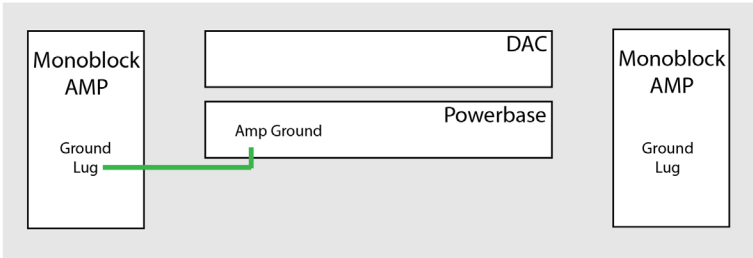

Grounding Lug Configuration

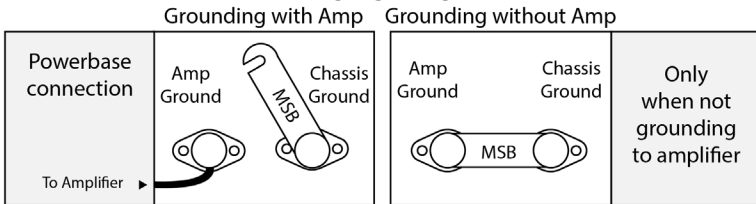

Powerbase Connection

Attach the ground wire to the "Amp ground" lug of the powerbase. Lift the jumper between "Amp Ground" and "Chassis Ground" as shown above.

Amp Connection

Attach the ground wire to the Ground Lug on the jack panel of the MSB amp. If there is no ground lug, attach wire to a chassis screw.

*****Never connect the ground wire to the negative speaker terminal*****

Powerbase - 12 Volt Remote Trigger

This powerbase is equipped with a remote trigger for use with other MSB products. The trigger uses a 3 pin mini jack. When any MSB product is turned off, the other products connected will also turn off and vice-versa. This trigger can also be used with other products. Products may use this trigger differently, so you may need to rewire a cable or use an interface relay. The connector is wired as shown. If you connect "signal" to "ground", all MSB products will turn off. If you connect "signal" to "12 V" or leave it open, all MSB products will turn on.

If the signal is pulled low:
Unit will turn off.

If the signal is pulled down with a 50K resistor:
Unit will go to standby.

If the signal is left floating:
Unit will remain on.

If the signal is driven with 12 V:
Unit will turn on and switch will be ignored.

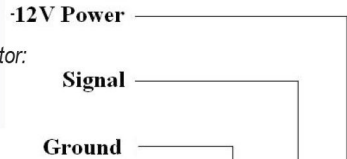

12 Volt Remote Trigger wiring.

To the MSB Power Base

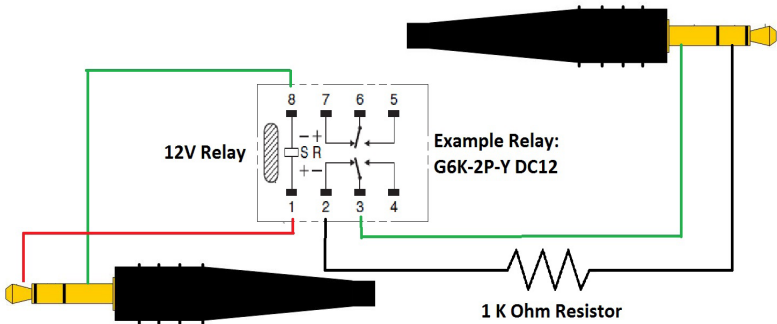

Non-MSB interface
12v = On
Open = Off

Technical Support

If you are experiencing any issues with your MSB product, please contact your nearest dealer or try our support page at www.msbtechnology.com/support. Please be sure you have the most current edition of your products firmware installed. If your issue persists please feel free to contact MSB directly. Emails are usually responded to in 24 - 48 hours.

Email: techsupport@msbtech.com

MSB Return Procedure (RMA)

If a customer, dealer, or distributor has a problem with an MSB product, they should email tech support before sending anything back to the factory. MSB will do their best to respond within 24 hours. Should it be clear that a product must be returned, tech support should be informed and all the following relevant information should be provided:

1	Product in question
2	Serial number
3	Exact configuration when symptom is observed along with a list with the input used, source material, system connections, and amplifier
4	Customer name
5	Customer shipping address
6	Customer phone number and email
7	Special return shipping instructions

MSB will issue an RMA number and create an invoice with all details outlined except the final price as the product has not yet been seen. This invoice will be emailed so all the above information can be checked and verified by the customer.

The product should be returned with the RMA number present on the box. Work can then begin immediately and the product can be sent back quickly.

Any repair that is difficult and cannot be completed in two weeks will be identified and the customer will be informed when it is to be expected. Otherwise the majority of repairs should be shipped back within two weeks if all the required information is present on the invoice.

Link to page:

<http://www.msbtechnology.com/faq/msb-product-return-procedure/>

The Discrete DAC Limited Warranty

Warranty includes:

- MSB warrantys the unit against defects in materials and workmanship for a period of **1 year** from the date the unit was originally shipped from MSB.
- This warranty covers parts and labor only, it does not cover shipping charges or tax/duty. During the Warranty period, there will normally be no charge for parts or labor.
- During the warranty period, MSB will repair or, at our discretion, replace a faulty product.
- Warranty repairs must be carried out by MSB or our authorized dealer. Please contact your dealer if your unit requires service.

Warranty excludes:

- The Warranty does not cover standard wear and tear.
- The product is misused in any way.
- Any unauthorized modifications or repairs were performed.
- The product is not used in accordance with the Operating Conditions stated below.
- The product is serviced or repaired by someone other than MSB or a authorized dealers.
- The product is operated without a mains earth (or ground) connection.
- The unit is returned inadequately packed.
- MSB reserves the right to apply a service charge if the product returned for warranty repair is found to be operating correctly, or if the product is returned without a returns number (RMA) being issued.

Operating Conditions:

- Ambient temperature range: 32F to 90F, non-condensing.
- The supply voltage must remain within the AC voltage specified on the power base.
- Do not install the unit near heat sources such as radiators, air ducts, power amplifiers or in direct strong sunlight. This may cause the product to overheat.