



ArcelorMittal

# Piling Handbook

8th edition, reprint 2008



## Foreword

Welcome to the 2008 revision of the Eighth Edition of the Piling Handbook. ArcelorMittal is the world's number one steel company with 310,000 employees in more than 60 countries, and a crude steel production of 116 million tonnes in 2007, representing around 10% of world steel output. ArcelorMittal is also the world's largest producer of hot rolled steel sheet piles (HRSSP), and market leader in foundation solutions. From its plants in Luxembourg, ArcelorMittal Belval and Differdange produces around 680,000 tonnes of steel sheet piles that are sold worldwide through ArcelorMittal Commercial RPS (Rails, Piles & Special Sections). Since 2006 ArcelorMittal Commercial RPS has integrated the sales of Dabrowa sheet piles produced in Poland, and starting 2008, after a major investment, the new sheet pile sections from Rodange in Luxembourg. This gives ArcelorMittal a production capacity of around 1 million tonnes of foundation solutions, which includes cold rolled steel sheet piles and combined wall systems.

In addition to offering the most comprehensive ranges of steel sheet piling, ArcelorMittal recognises the high importance of technical support for its foundation products. The Piling Handbook is intended to assist design engineers in their daily work and act as a reference book for the more experienced engineers. The eighth edition of the Handbook includes substantial updates, particularly in areas such as Sealants, Noise & Vibration and Installation. The 2008 revision contains all the new sections available beginning of the second semester of 2008. This handbook reflects the dynamism of the foundations industry, and is evidence of ArcelorMittal's commitment to customer support. ArcelorMittal Commercial RPS' mission is to develop excellent working partnerships with its customers in order to consolidate its leadership in sheet piling technology, and remain the preferred supplier in the marketplace.

We sincerely trust that you will find this Handbook a valuable and most useful document, and we look forward to working together with you on many successful projects around the world.

Emile Reuter  
Vice President  
Long Carbon Europe  
Head of Sales and Marketing of  
Rails, Piles and Special Sections

Boris Even  
Commercial Director  
ArcelorMittal Commercial Rails,  
Piles and Special Sections



ArcelorMittal

- 1** Product information
- 2** Sealants
- 3** Durability
- 4** Earth and water pressure
- 5** Design of sheet pile structures
- 6** Retaining walls
- 7** Cofferdams
- 8** Charts for retaining walls
- 9** Circular cell construction design & installation
- 10** Bearing piles and axially loaded sheet piles
- 11** Installation of sheet piles
- 12** Noise and vibration from piling operations
- 13** Useful information

# Product information

## Contents

	Page
<b>1.1 Introduction</b>	1
<b>1.2 Typical uses</b>	1
<b>1.3 Steel qualities</b>	3
<b>1.4 Product tolerances</b>	4
<b>1.5 Section profiles</b>	4
<b>1.6 Maximum and minimum lengths</b>	5
<b>1.7 Interlocking options</b>	5
<b>1.8 Handling holes</b>	5
<b>1.9 Plating to increase section modulus</b>	6
<b>1.10 Plating to enhance durability</b>	6
<b>1.11 Corners and junctions</b>	6
<b>1.12 Stacking of sheet piles</b>	8
<b>1.13 Z profile piles</b>	9
1.13.1 Z profile piles – Dimensions & properties	9
1.13.2 Interlocking in pairs	15
1.13.3 Crimping and welding of interlocks	15
1.13.4 Pile form	16
1.13.5 Circular construction	16
<b>1.14 U profile piles</b>	17
1.14.1 U profile piles – Dimensions & properties	17
1.14.2 Interlocking in pairs	24
1.14.3 Crimping and welding of interlocks	25
1.14.4 Pile form	25
1.14.5 Circular construction	26
<b>1.15 Straight web piles</b>	27
1.15.1 AS-500 straight web piles – Dimensions & properties	27
<b>1.16 Combined wall systems</b>	29
1.16.1 HZ/AZ pile system	29
1.16.2 Box piles	31
1.16.3 Special arrangements – CAZ + AZ combinations	37
1.16.4 Combined walls with U-type sections	38
1.16.5 Load bearing foundations	40
1.16.6 Jagged walls	42
<b>1.17 Cold formed sheet piles</b>	43
1.17.1 PAL and PAU sections – Dimensions & properties	44
1.17.2 PAZ sections – Dimensions & properties	45
1.17.3 Trench sheet sections	47
1.17.4 Threading options	47
1.17.5 Sheet pile assembly	48
1.17.6 Thickness	49
1.17.7 Handling holes	49
1.17.8 Tolerances in accordance with EN 10249 Part 2	50

# Product information



# Product information

## 1.1 Introduction

Steel sheet piling is used in many types of temporary works and permanent structures. The sections are designed to provide the maximum strength and durability at the lowest possible weight consistent with good driving qualities. The design of the section interlocks facilitates pitching and driving and results in a continuous wall with a series of closely fitting joints.

A comprehensive range of sections in both Z and U forms with a wide range of sizes and weights is obtainable in various different grades of steel which enables the most economic choice to be made to suit the nature and requirements of any given contract.

For applications where corrosion is an issue, sections with minimum thickness can be delivered to maximise the effective life of the structure. The usual requirements for minimum overall thickness of 10 mm, 12 mm or 1/2 inch can be met.

Corner and junction piles are available to suit all requirements.

---

## 1.2 Typical uses

### River control structures and flood defence

Steel sheet piling has traditionally been used for the support and protection of river banks, lock and sluice construction, and flood protection. Ease of use, length of life and the ability to be driven through water make piles the obvious choice.

### Ports and harbours

Steel sheet piling is a tried and tested material to construct quay walls speedily and economically. Steel sheet piles can be designed to cater for heavy vertical loads and large bending moments.

### Pumping stations

Historically used as temporary support for the construction of pumping stations, sheet piling can be easily designed as the permanent structure with substantial savings in time and cost. Although pumping stations tend to be rectangular, circular construction should be considered as advantages can be gained from the resulting open structure.

### Bridge abutments

Abutments formed from sheet piles are most cost effective in situations when a piled foundation is required to support the bridge or where speed of construction is critical. Sheet piling can act as both foundation and abutment and can be driven in a single operation, requiring a minimum of space and time for construction.

### Road widening retaining walls

Key requirements in road widening include minimised land take and speed of construction – particularly in lane rental situations. Steel sheet piling provides these and eliminates the need for soil excavation and disposal.

## Product information

### **Basements**

Sheet piling is an ideal material for constructing basement walls as it requires minimal construction width. Its properties are fully utilised in both the temporary and permanent cases and it offers significant cost and programme savings. Sheet piles can also support vertical loads from the structure above.

### **Underground car parks**

One specific form of basement where steel sheet piling has been found to be particularly effective is for the creation of underground car parks. The fact that steel sheet piles can be driven tight against the boundaries of the site and the wall itself has minimum thickness means that the area available for cars is maximised and the cost per bay is minimised.

### **Containment barriers**

Sealed sheet piling is an effective means for the containment of contaminated land. A range of proprietary sealants is available to suit particular conditions where extremely low permeability is required.

### **Load bearing foundations**

Steel sheet piling can be combined with special corner profiles to form small diameter closed boxes which are ideally suited for the construction of load bearing foundations. Developed for use as a support system for motorway sign gantries, the concept has also been used to create foundation piles for bridges.

### **Temporary works**

For construction projects where a supported excavation is required, steel sheet piling should be the first choice. The fundamental properties of strength and ease of use - which steel offers - are fully utilised in temporary works. The ability to extract and re-use sheet piles makes them an effective design solution. However, significant cost reductions and programme savings can be achieved by designing the temporary sheet pile structure as the permanent works.



## Product information

### 1.3 Steel qualities

Hot rolled steel piling is supplied to EN 10248 Part 1 to the grade designations detailed below.

Table 1.3.1 Steel qualities - Hot rolled steel piles

Grade	Min Yield Point*	Min. Tensile strength*	Minimum elongation on a gauge length of $L_0$ = $5.65 \sqrt{S_0}$
	N/mm <sup>2</sup>	N/mm <sup>2</sup>	%
S 240 GP	240	340	26
S 270 GP	270	410	24
S 320 GP	320	440	23
S 355 GP	355	480	22
S 390 GP	390	490	20
S 430 GP	430	510	19
Mill specification			
S 460 AP	460	550	17

\* The values in the table apply to longitudinal test pieces for the tensile test.

S 460 AP (Mill specification) is also available but please contact ArcelorMittal Commercial RPS before specifying.

Steel grades with increased copper content offering higher durability in the splash zone as discussed in the Durability chapter can be supplied upon request.

Steel grades compliant with other standards (i.e. ASTM, JIS ) and special steels are also available by prior arrangement.

Cold formed sheet piling is supplied to EN10249 Part 1 to the grade definitions detailed below.

Table 1.3.2 Steel qualities - Cold formed steel piles

Grade	Min. yield strength N/mm <sup>2</sup>	Tensile strength N/mm <sup>2</sup>	Min. elongation %	Former references			
				France	Germany	U.K.	Belgium
S 235 JRC	235	340 - 470	26	E 24-2	St 37-2	40 B	AE 235-B
S 275 JRC	275	410 - 560	22	E 28-2	St 44-2	43 B	AE 275-B
S 355 JOC	355	490 - 630	22	E 36-3	St 52-3 U	50 C	AE 335-C



# Product information

## 1.4 Product tolerances

Hot rolled sheet piling products are supplied to EN 10248 Part 2 unless an alternative standard (i.e. ASTM, JIS ) is specified.

Fig 1.4

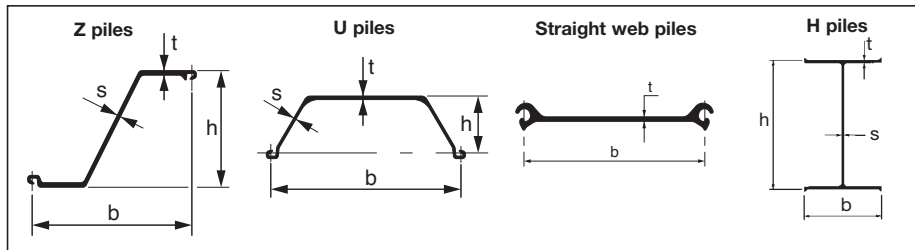

Table 1.4

Height				Width	
				Single piles	Interlocked piles
Z piles	$h \leq 200\text{mm}$ $\pm 5\text{mm}$	$200\text{mm} < h < 300\text{mm}$ $\pm 6\text{mm}$	$h \geq 300\text{mm}$ $\pm 7\text{mm}$	$\pm 2\% b$	$\pm 3\%$ nominal width
U piles	$h \leq 200\text{mm}$ $\pm 4\text{mm}$	$h > 200\text{mm}$ $\pm 5\text{mm}$		$\pm 2\% b$	$\pm 3\%$ nominal width
H piles	$h < 500\text{mm}$ $\pm 5\text{mm}$	$h \geq 500\text{mm}$ $\pm 7\text{mm}$		$\pm 2\% b$	$\pm 3\%$ nominal width
<b>Wall thickness</b>					
Z piles	$t \leq 8.5\text{ mm}$ $\pm 0.5\text{ mm}$	$t > 8.5\text{ mm}$ $\pm 6\%$	$s \leq 8.5\text{ mm}$ $\pm 0.5\text{ mm}$	$s > 8.5\text{ mm}$ $\pm 6\%$	
U piles	$t \leq 8.5\text{ mm}$ $\pm 0.5\text{ mm}$	$t > 8.5\text{mm}$ $\pm 6\%$	$s \leq 8.5\text{ mm}$ $\pm 0.5\text{ mm}$	$s > 8.5\text{mm}$ $\pm 6\%$	
H piles	$t \leq 12.5\text{ mm}$ $+2 / -1\text{ mm}$	$t > 12.5\text{ mm}$ $+2.5 / -1.5\text{ mm}$	$s \leq 12.5\text{ mm}$ $+2 / -1\text{ mm}$	$s > 12.5\text{ mm}$ $+2.5 / -1.5\text{ mm}$	
Straight web piles	$t \leq 8.5\text{ mm}$ $\pm 0.5\text{ mm}$	$t > 8.5\text{mm}$ $\pm 6\%$			
<b>All sections</b>					
<b>Straightness</b>	<b>Length</b>	<b>Squareness of cut</b>	<b>Mass</b>		
$\leq 0.2\%$ of pile length	$\pm 200\text{ mm}$	$\pm 2\% b$	$\pm 5\%$		

Cold formed tolerances can be found on page 1/50

## 1.5 Section profiles

Drawings of all the pile sections available from ArcelorMittal are located at the following website [www.arcelormittal.com/sheetpiling](http://www.arcelormittal.com/sheetpiling)

Sheet pile sections are subject to periodic review and minor changes to the profile may result. It is, therefore, recommended that users visit the ArcelorMittal Sheet Piling website to ensure that they are using the latest pile profiles.

# Product information

## 1.6 Maximum and Minimum lengths

Steel sheet piling can be supplied in lengths up to 31 m (HZ piles are available up to 33m long) but particular care will be required when handling long lengths of the lighter sections.

Should piles be needed which are longer than 31m, splicing to create the required length may be carried out on site.

When short piles are to be supplied direct from the mill it may be advantageous to order them in multiples of the required length and in excess of 6m long with cutting to length being carried out on site.

When considering piles at either end of the length range, we recommend that contact is made with one of our representatives to discuss availability.

Following table summarizes the maximum rolling lengths of the different sections:

Section	AZ	AU, PU	PU-R	GU sp <sup>1)</sup>	GU dp <sup>1)</sup>	AS 500	HZ	RH / RZ	OMEGA 18	C9 / C14	DELTA 13
	31	31	24	24	22	31	33	24	16	18	17

<sup>1)</sup> sp = single pile, dp = double pile

## 1.7 Interlocking options

AZ, AU, PU, PU-R and GU sheet piles feature Larssen interlocks in accordance with EN 10248. AZ, AU, PU and PU-R can be interlocked together.

The theoretical interlock swing of ArcelorMittal's Larssen interlock is 5°.

## 1.8 Handling holes

Sheet pile sections are normally supplied without handling holes. If requested, they can be provided as illustrated below on the centreline of the section.

Table 1.8

Dia	Y
50mm	200mm
50mm	250mm
40mm	75mm
40mm	150mm
40mm	300mm
2½ in	9 in (Dia = 63.5mm; Y = 230mm)

Fig 1.8

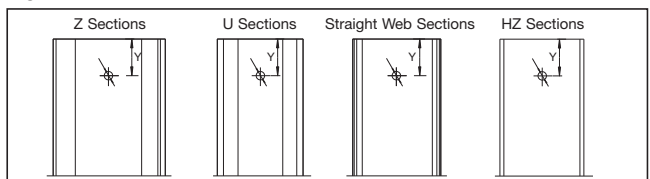

## Product information

### 1.9 Plating to increase section modulus

When increased section modulus or inertia is required to cater for high bending moments over part of the pile length, it may be economic to attach appropriately sized plates to the pans of the piles to locally enhance the engineering properties of the section. It is generally economic to consider this option rather than just selecting a larger pile section when the pile is very long or when the pile is at the top of the range anyway.

---

### 1.10 Plating to enhance durability

Plates can be attached to Z and U piles to provide increased durability to parts of the pile where corrosion activity may be high. This may be the case where the piles are to be installed in a facility where increased corrosion is expected. The economics of providing additional sacrificial steel instead of a heavier pile section will depend upon individual conditions but when the high corrosion effect is only expected over a short length of the pile, the plating option will very often prove to be the more cost effective solution.

---

### 1.11 Corners and junctions

The diagram below illustrates the comprehensive range of hot rolled special sections that is available for use with ArcelorMittal hot rolled sheet piles to create corners and junctions (except for GU sections). The special section is attached to the main sheet pile by welding in accordance with EN12063 and is set back from the top of the pile by 200mm to facilitate driving.

Corner profiles can also be formed by

- bending single rolled sections for changes in direction up to 25°;
- combining two single bent piles for angles up to 50°;
- cutting the piles and welding them together in the required orientation.

A comprehensive range of junction piles can be formed by welding a C9 hot rolled section onto the main sheet pile at the appropriate location and angle.

One advantage that the special connector has over the more traditional fabricated corner or junction section is that once a fabricated pile is formed it cannot easily be changed. In the case of temporary works, the rolled corners or junctions can be tacked in place before driving and burned off after extraction to leave a serviceable pile section and a junction or corner for use elsewhere. In the case of the Omega 18 and Delta 13 profiles, the angle is variable and enables corners to be formed at angles other than 90°.

## Product information

Fig 1.11a

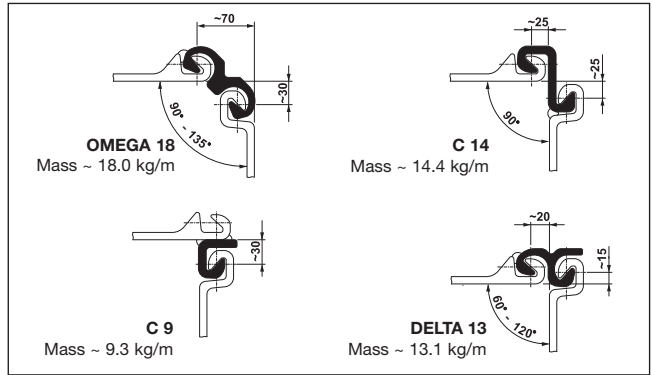
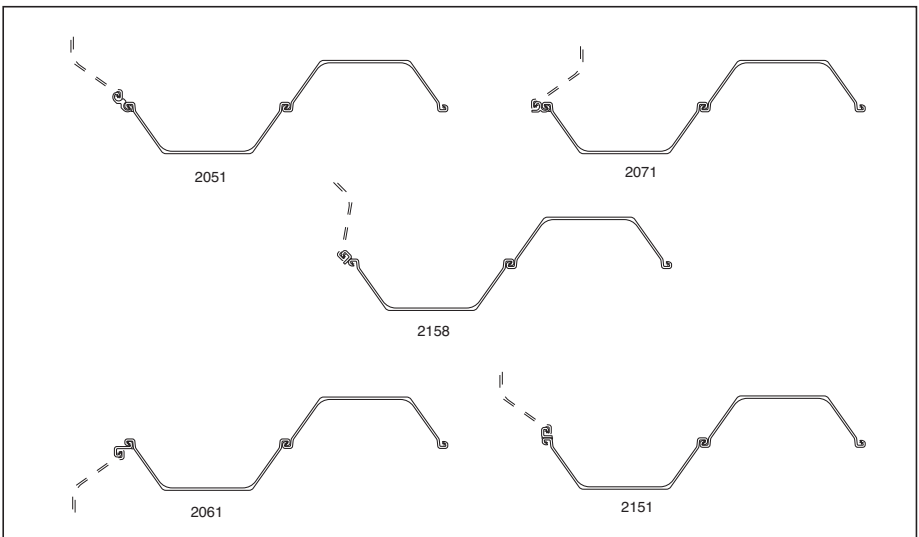

Fig 1.11b



Technical assistance is available on request to ascertain what is required for a particular project.

Drawings of the various rolled profiles may be downloaded from the following website [www.arcelormittal.com/sheetpiling](http://www.arcelormittal.com/sheetpiling).

Please note that:

- generally bent corners will be supplied as single piles.
- corner sections (C9, C14, Delta13, Omega18) are not compatible with GU sections. Contact our technical department for alternative solutions.

# Product information

## 1.12 Stacking of sheet piles

Fig 1.12

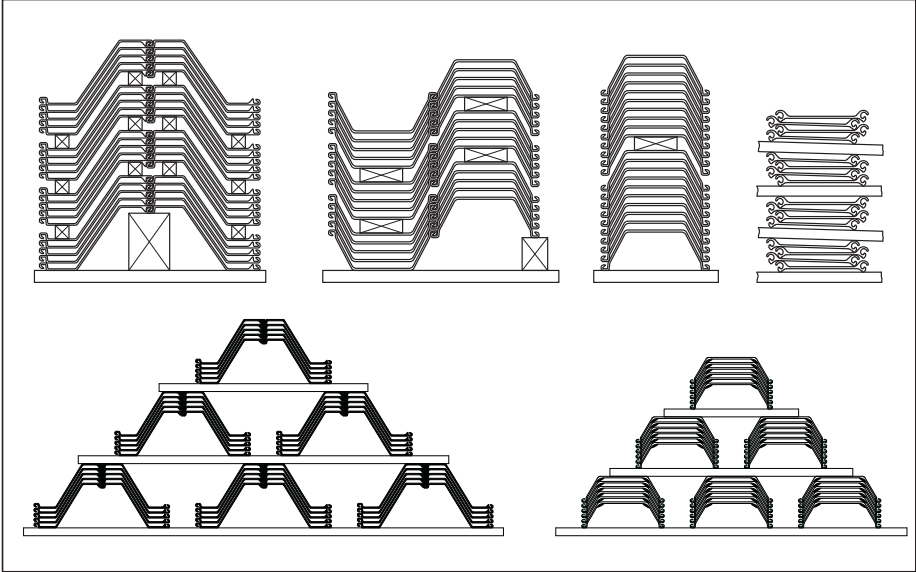

When stacking piles on site it is recommended that they are placed on timber or steel spacers – to allow straps or chains to be placed around the bundles – and on a level surface to prevent the piles being distorted. The spacers should be placed at regular intervals up to 4m apart along the length of the piles and it is recommended that the overhang is limited to 1.5m. It is recommended that pile bundles are stacked not more than 4 high to prevent excessive loads on the bottom tier.

Bundles should ideally be staggered in plan - as illustrated above – to provide stability.

# Product information

## 1.13 Z profile piles

### 1.13.1 Dimensions and properties

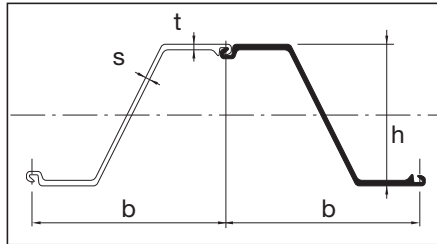

Table 1.13.1a

Section	Width	Height	Thickness		Sectional area	Mass		Moment of inertia	Elastic section modulus	Static moment	Plastic section modulus	Class*					
	b mm	h mm	t mm	s mm		kg/m of single pile	kg/m <sup>2</sup> of wall					cm <sup>2</sup> /m	cm <sup>3</sup> /m	cm <sup>2</sup> /m	cm <sup>3</sup> /m	S 240 GP	S 270 GP
AZ 12	670	302	8.5	8.5	126	66.1	99	18140	1200	705	1409	2	3	3	3	3	3
AZ 13	670	303	9.5	9.5	137	72.0	107	19700	1300	765	1528	2	2	2	3	3	3
AZ 13 10/10	670	304	10.0	10.0	143	75.2	112	20480	1350	795	1589	2	2	2	2	3	3
AZ 14	670	304	10.5	10.5	149	78.3	117	21300	1400	825	1651	2	2	2	2	2	3
AZ 17	630	379	8.5	8.5	138	68.4	109	31580	1665	970	1944	2	2	3	3	3	3
AZ 18	630	380	9.5	9.5	150	74.4	118	34200	1800	1050	2104	2	2	2	3	3	3
AZ 18 10/10	630	381	10.0	10.0	157	77.8	123	35540	1870	1095	2189	2	2	2	2	3	3
AZ 19	630	381	10.5	10.5	164	81.0	129	36980	1940	1140	2275	2	2	2	2	2	3
AZ 25	630	426	12.0	11.2	185	91.5	145	52250	2455	1435	2873	2	2	2	2	2	2
AZ 26	630	427	13.0	12.2	198	97.8	155	55510	2600	1530	3059	2	2	2	2	2	2
AZ 28	630	428	14.0	13.2	211	104.4	166	58940	2755	1625	3252	2	2	2	2	2	2
AZ 46	580	481	18.0	14.0	291	132.6	229	110450	4595	2650	5295	2	2	2	2	2	2
AZ 48	580	482	19.0	15.0	307	139.6	241	115670	4800	2775	5553	2	2	2	2	2	2
AZ 50	580	483	20.0	16.0	322	146.7	253	121060	5015	2910	5816	2	2	2	2	2	2
AZ-700 and AZ-770																	
AZ 12-770	770	344	8.5	8.5	120	72.6	94	21430	1245	740	1480	2	2	3	3	3	3
AZ 13-770	770	344	9.0	9.0	126	76.1	99	22360	1300	775	1546	2	2	3	3	3	3
AZ 14-770	770	345	9.5	9.5	132	79.5	103	23300	1355	805	1611	2	2	2	2	3	3
AZ 14-770 10/10	770	345	10.0	10.0	137	82.9	108	24240	1405	840	1677	2	2	2	2	2	3
AZ 17-700	700	420	8.5	8.5	133	73.1	104	36230	1730	1015	2027	2	2	3	3	3	3
AZ 18-700	700	420	9.0	9.0	139	76.5	109	37800	1800	1060	2116	2	2	3	3	3	3
AZ 19-700	700	421	9.5	9.5	146	80.0	114	39380	1870	1105	2206	2	2	2	3	3	3
AZ 20-700	700	421	10.0	10.0	152	83.5	119	40960	1945	1150	2296	2	2	2	2	2	3
AZ 24-700	700	459	11.2	11.2	174	95.7	137	55820	2430	1435	2867	2	2	2	2	2	3
AZ 26-700	700	460	12.2	12.2	187	102.9	147	59720	2600	1535	3070	2	2	2	2	2	2
AZ 28-700	700	461	13.2	13.2	200	110.0	157	63620	2760	1635	3273	2	2	2	2	2	2
AZ 37-700	700	499	17.0	12.2	226	124.2	177	92400	3705	2130	4260	2	2	2	2	2	2
AZ 39-700	700	500	18.0	13.2	240	131.9	188	97500	3900	2250	4500	2	2	2	2	2	2
AZ 41-700	700	501	19.0	14.2	254	139.5	199	102610	4095	2370	4745	2	2	2	2	2	2

\*: Classification according to EN 1993-5.

Class 1 is obtained by verification of the rotation capacity for a class-2 cross-section.

A set of tables with all the data required for design in accordance with EN 1993-5 is available from our Technical Department.

# Product information

## Z profile piles - Dimensions and properties

Table 1.13.1b

Section	S = Single pile D = Double pile	Sectional area cm <sup>2</sup>	Mass kg/m	Moment of inertia cm <sup>4</sup>	Elastic section modulus cm <sup>3</sup>	Radius of gyration cm	Coating area* m <sup>2</sup> /m
	Per S	84.2	<b>66.1</b>	12160	<b>805</b>	12.02	0.83
	Per D	168.4	<b>132.2</b>	24320	<b>1610</b>	12.02	1.65
	Per m of wall	125.7	<b>98.7</b>	18140	<b>1200</b>	12.02	1.23
	Per S	91.7	<b>72.0</b>	13200	<b>870</b>	11.99	0.83
	Per D	183.4	<b>144.0</b>	26400	<b>1740</b>	11.99	1.65
	Per m of wall	136.9	<b>107.5</b>	19700	<b>1300</b>	11.99	1.23
	Per S	99.7	<b>78.3</b>	14270	<b>940</b>	11.96	0.83
	Per D	199.4	<b>156.6</b>	28540	<b>1880</b>	11.96	1.65
	Per m of wall	148.9	<b>116.9</b>	21300	<b>1400</b>	11.96	1.23
	Per S	87.1	<b>68.4</b>	19900	<b>1050</b>	15.12	0.86
	Per D	174.2	<b>136.8</b>	39800	<b>2100</b>	15.12	1.71
	Per m of wall	138.3	<b>108.6</b>	31580	<b>1665</b>	15.12	1.35
	Per S	94.8	<b>74.4</b>	21540	<b>1135</b>	15.07	0.86
	Per D	189.6	<b>148.8</b>	43080	<b>2270</b>	15.07	1.71
	Per m of wall	150.4	<b>118.1</b>	34200	<b>1800</b>	15.07	1.35
	Per S	103.2	<b>81.0</b>	23300	<b>1225</b>	15.03	0.86
	Per D	206.4	<b>162.0</b>	46600	<b>2445</b>	15.03	1.71
	Per m of wall	163.8	<b>128.6</b>	36980	<b>1940</b>	15.03	1.35

\* One side, excluding inside of interlocks.



# Product information

## Z profile piles - Dimensions and properties

Table 1.13.1c

Section	S = Single pile D = Double pile	Sectional area	Mass	Moment of inertia	Elastic section modulus	Radius of gyration	Coating area*
	Per S	116.6	<b>91.5</b>	32910	<b>1545</b>	16.80	0.90
	Per D	233.2	<b>183.0</b>	65820	<b>3090</b>	16.80	1.78
	Per m of wall	185.0	<b>145.2</b>	52250	<b>2455</b>	16.80	1.41
		Per S	124.6	<b>97.8</b>	34970	<b>1640</b>	16.75
Per D		249.2	<b>195.6</b>	69940	<b>3280</b>	16.75	1.78
Per m of wall		197.80	<b>155.2</b>	55510	<b>2600</b>	16.75	1.41
		Per S	133.0	<b>104.4</b>	37130	<b>1735</b>	16.71
	Per D	266.0	<b>208.8</b>	74260	<b>3470</b>	16.71	1.78
	Per m of wall	211.1	<b>165.7</b>	58940	<b>2755</b>	16.71	1.41
		Per S	168.9	<b>132.6</b>	64060	<b>2665</b>	19.48
Per D		337.8	<b>265.2</b>	128120	<b>5330</b>	19.48	1.89
Per m of wall		291.2	<b>228.6</b>	110450	<b>4595</b>	19.48	1.63
		Per S	177.8	<b>139.6</b>	67090	<b>2785</b>	19.43
	Per D	355.6	<b>279.2</b>	134180	<b>5570</b>	19.43	1.89
	Per m of wall	306.5	<b>240.6</b>	115670	<b>4800</b>	19.43	1.63
		Per S	186.9	<b>146.7</b>	70215	<b>2910</b>	19.38
Per D		373.8	<b>293.4</b>	140430	<b>5815</b>	19.38	1.89
Per m of wall		322.2	<b>252.9</b>	121060	<b>5015</b>	19.38	1.63

\* One side, excluding inside of interlocks.

# Product information

## Z profile piles - Dimensions and properties

Table 1.13.1d

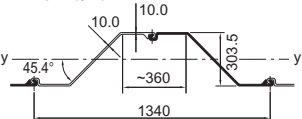
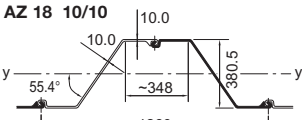
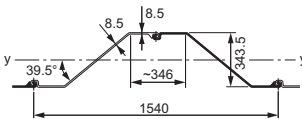
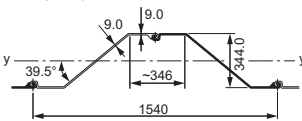
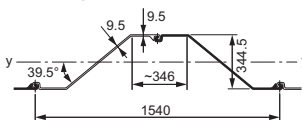
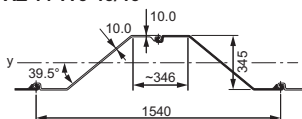
Section	S = Single pile D = Double pile	Sectional area cm <sup>2</sup>	Mass kg/m	Moment of inertia cm <sup>4</sup>	Elastic section modulus cm <sup>3</sup>	Radius of gyration cm	Coating area* m <sup>2</sup> /m
<b>AZ 13 10/10</b>							
	Per S	95.8	<b>75.2</b>	13720	<b>905</b>	11.97	0.83
	Per D	191.6	<b>150.4</b>	27440	<b>1810</b>	11.97	1.65
	Per m of wall	143.0	<b>112.2</b>	20480	<b>1350</b>	11.97	1.23
<b>AZ 18 10/10</b>							
	Per S	99.1	<b>77.8</b>	22390	<b>1175</b>	15.04	0.86
	Per D	198.1	<b>155.5</b>	44790	<b>2355</b>	15.04	1.71
	Per m of wall	157.2	<b>123.4</b>	35540	<b>1870</b>	15.04	1.35
<b>AZ 12-770</b>							
	Per S	92.5	<b>72.6</b>	16500	<b>960</b>	13.36	0.93
	Per D	185.0	<b>145.2</b>	33000	<b>1920</b>	13.36	1.85
	Per m of wall	120.1	<b>94.3</b>	21430	<b>1245</b>	13.36	1.20
<b>AZ 13-770</b>							
	Per S	96.9	<b>76.1</b>	17220	<b>1000</b>	13.33	0.93
	Per D	193.8	<b>152.1</b>	34440	<b>2000</b>	13.33	1.85
	Per m of wall	125.8	<b>98.8</b>	22360	<b>1300</b>	13.33	1.20
<b>AZ 14-770</b>							
	Per S	101.3	<b>79.5</b>	17940	<b>1040</b>	13.31	0.93
	Per D	202.6	<b>159.0</b>	35890	<b>2085</b>	13.31	1.85
	Per m of wall	131.5	<b>103.2</b>	23300	<b>1355</b>	13.31	1.20
<b>AZ 14-770-10/10</b>							
	Per S	105.6	<b>82.9</b>	18670	<b>1085</b>	13.30	0.93
	Per D	211.2	<b>165.8</b>	37330	<b>2165</b>	13.30	1.85
	Per m of wall	137.2	<b>107.7</b>	24240	<b>1405</b>	13.30	1.20

\* One side, excluding inside of interlocks.

# Product information

## Z profile piles - Dimensions and properties

Table 1.13.1e

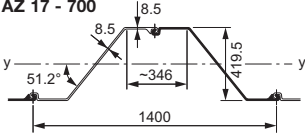
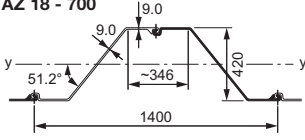
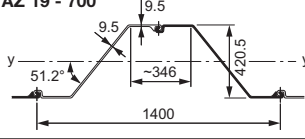
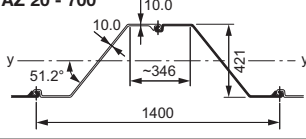
Section	S = Single pile D = Double pile	Sectional area cm <sup>2</sup>	Mass kg/m	Moment of inertia cm <sup>4</sup>	Elastic section modulus cm <sup>3</sup>	Radius of gyration cm	Coating area* m <sup>2</sup> /m
<b>AZ 17 - 700</b> 	Per S	93.1	<b>73.1</b>	25360	<b>1210</b>	16.50	0.93
	Per D	186.2	<b>146.2</b>	50720	<b>2420</b>	16.50	1.86
	Per m of wall	133.0	<b>104.4</b>	36230	<b>1730</b>	16.50	1.33
	<hr/>						
<b>AZ 18 - 700</b> 	Per S	97.5	<b>76.5</b>	26460	<b>1260</b>	16.50	0.93
	Per D	194.9	<b>153.0</b>	52920	<b>2520</b>	16.50	1.86
	Per m of wall	139.2	<b>109.3</b>	37800	<b>1800</b>	16.50	1.33
	<hr/>						
<b>AZ 19 - 700</b> 	Per S	101.9	<b>80.0</b>	27560	<b>1310</b>	16.50	0.93
	Per D	203.8	<b>160.0</b>	55130	<b>2620</b>	16.50	1.86
	Per m of wall	145.6	<b>114.3</b>	39380	<b>1870</b>	16.50	1.33
	<hr/>						
<b>AZ 20 - 700</b> 	Per S	106.4	<b>83.5</b>	28670	<b>1360</b>	16.40	0.93
	Per D	212.8	<b>167.0</b>	57340	<b>2725</b>	16.40	1.86
	Per m of wall	152.0	<b>119.3</b>	40960	<b>1945</b>	16.40	1.33

\* One side, excluding inside of interlocks.

# Product information

## Z profile piles - Dimensions and properties

Table 1.13.1f

Section	S = Single pile D = Double pile	Sectional area cm <sup>2</sup>	Mass kg/m	Moment of inertia cm <sup>4</sup>	Elastic section modulus cm <sup>3</sup>	Radius of gyration cm	Coating area* m <sup>2</sup> /m
	Per S	121.9	<b>95.7</b>	39080	<b>1700</b>	17.90	0.97
	Per D	243.8	<b>191.4</b>	78150	<b>3405</b>	17.90	1.93
	Per m of wall	174.1	<b>136.7</b>	55820	<b>2430</b>	17.90	1.38
	Per S	131.0	<b>102.9</b>	41800	<b>1815</b>	17.86	0.97
	Per D	262.1	<b>205.7</b>	83610	<b>3635</b>	17.86	1.93
	Per m of wall	187.2	<b>146.9</b>	59720	<b>2600</b>	17.86	1.38
	Per S	140.2	<b>110.0</b>	44530	<b>1930</b>	17.83	0.97
	Per D	280.3	<b>220.1</b>	89070	<b>3865</b>	17.83	1.93
	Per m of wall	200.2	<b>157.2</b>	63620	<b>2760</b>	17.83	1.38
	Per S	158.2	<b>124.2</b>	64680	<b>2590</b>	20.22	1.03
	Per D	316.4	<b>248.4</b>	129350	<b>5185</b>	20.22	2.04
	Per m of wall	226.0	<b>177.4</b>	92400	<b>3705</b>	20.22	1.46
	Per S	168.0	<b>131.9</b>	68250	<b>2730</b>	20.16	1.03
	Per D	336.0	<b>263.7</b>	136500	<b>5460</b>	20.16	2.04
	Per m of wall	240.0	<b>188.4</b>	97500	<b>3900</b>	20.16	1.46
	Per S	177.8	<b>139.5</b>	71830	<b>2865</b>	20.10	1.03
	Per D	355.5	<b>279.1</b>	143650	<b>5735</b>	20.10	2.04
	Per m of wall	254.0	<b>199.4</b>	102610	<b>4095</b>	20.10	1.46

\* One side, excluding inside of interlocks.

# Product information

## 1.13.2 Interlocking in pairs

AZ piles are normally supplied in pairs which saves time in handling and pitching. They can however, be supplied singly by prior arrangement but the purchaser must be warned that the bending strength of single AZ piles, especially the lighter ones, is very low and damage by plastic deformation under self-weight can easily occur during handling and driving.

## 1.13.3 Crimping and welding of the interlocks

Crimping or welding of AZ piles is not necessary to guarantee the strength of the piled wall, but can be of benefit during handling and driving.

Fig 1.13.3

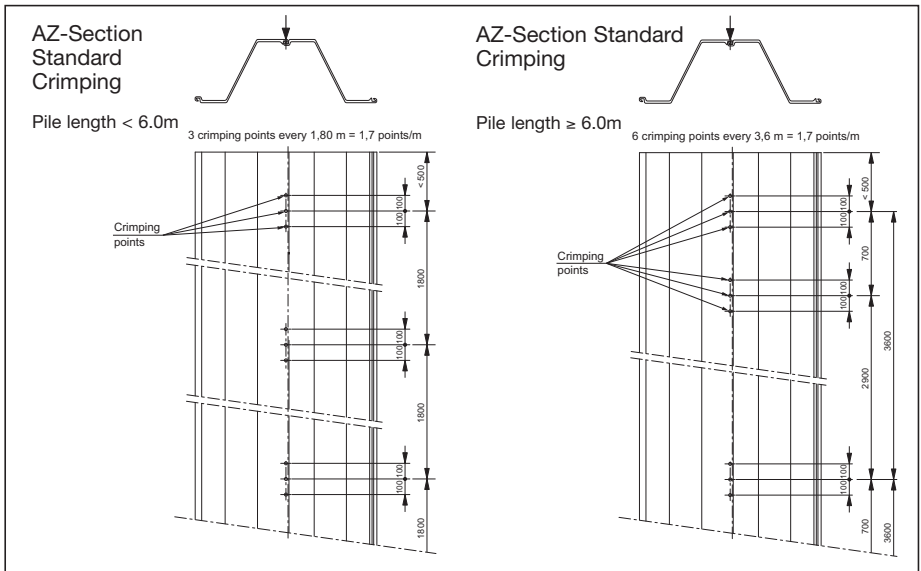

## Product information

### 1.13.4 Pile form

Piles can be supplied as illustrated.

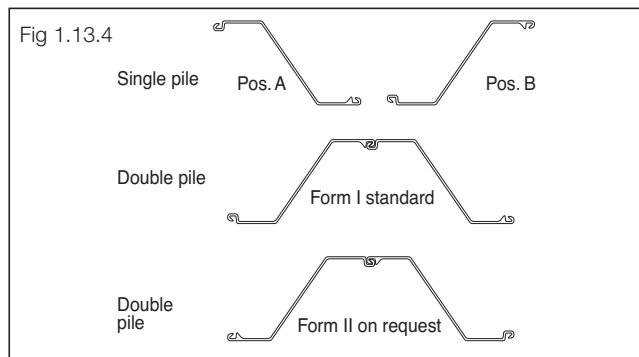

If no particular preference is specified at the time of order, double piles will be supplied as Form 1.

### 1.13.5 Circular construction

Steel sheet piling can be driven to form a complete circle without the need for corner piles. AZ piles have a maximum angle of deviation of 5°.

The following table gives the approximate minimum diameters of circular cofferdam which can be constructed using various sheet pile sections. The diameters are only intended to be for guidance as the actual interlock deviation achieved will be a function of the pile length, the pile section, the penetration required. Smaller diameters can be achieved by introducing bent corner piles, but larger diameters will result if pairs of piles that have been crimped or welded are used.

Table 1.13.5

Section	Minimum number of single piles used Angle = 5°	Approx. min diameter to internal face of wall m
AZ 12, AZ 13, AZ 13/10/10, AZ 14	72	15.1
AZ 17, AZ 18, AZ 18/10/10, AZ 19	72	14.1
AZ 25, AZ 26, AZ 28	72	14.0
AZ 46, AZ 48, AZ 50	72	12.8
AZ 12-770, AZ 13-770, AZ 14-770, AZ 14-770-10/10	72	17.3
AZ 17-700, AZ 18-700, AZ 19-700, AZ 20-700	72	15.6
AZ 24-700, AZ 26-700, AZ 28-700	72	15.6
AZ 37-700, AZ 39-700, AZ 41-700	72	15.5

Contact our technical representatives to obtain data for situations where plated box piles, double box piles or HZ systems are to be used.

# Product information

## 1.14 U profile piles

### 1.14.1 Dimensions and properties

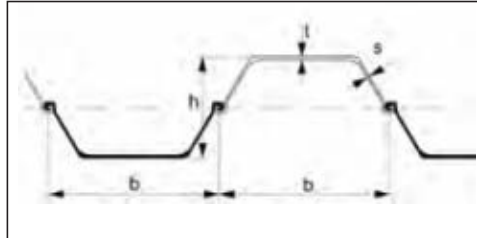

Table 1.14.1a

Section	Width Height		Thickness		Sectional area		Mass		Moment of inertia cm <sup>4</sup> /m	Elastic section modulus cm <sup>3</sup> /m	Static moment cm <sup>2</sup> /m	Plastic section modulus cm <sup>3</sup> /m	Class*					
	b mm	h mm	t mm	s mm	cm <sup>2</sup> /m	kg/m of single pile	kg/m <sup>2</sup> of wall	S <sub>240</sub> GP					S <sub>270</sub> GP	S <sub>300</sub> GP	S <sub>350</sub> GP	S <sub>390</sub> GP	S <sub>430</sub> GP	S <sub>460</sub> AP
<b>AU sections</b>																		
<b>AU 14</b>	750	408	10.0	8.3	132	77.9	<b>104</b>	28680	<b>1405</b>	820	1663	2	2	3	3	3	3	
<b>AU 16</b>	750	411	11.5	9.3	147	86.3	<b>115</b>	32850	<b>1600</b>	935	1891	2	2	2	2	2	3	
<b>AU 17</b>	750	412	12.0	9.7	151	89.0	<b>119</b>	34270	<b>1665</b>	975	1968	2	2	2	2	2	3	
<b>AU 18</b>	750	441	10.5	9.1	150	88.5	<b>118</b>	39300	<b>1780</b>	1030	2082	2	3	3	3	3	3	
<b>AU 20</b>	750	444	12.0	10.0	165	96.9	<b>129</b>	44440	<b>2000</b>	1155	2339	2	2	2	3	3	3	
<b>AU 21</b>	750	445	12.5	10.3	169	99.7	<b>133</b>	46180	<b>2075</b>	1200	2423	2	2	2	2	3	3	
<b>AU 23</b>	750	447	13.0	9.5	173	102.1	<b>136</b>	50700	<b>2270</b>	1285	2600	2	2	2	3	3	3	
<b>AU 25</b>	750	450	14.5	10.2	188	110.4	<b>147</b>	56240	<b>2500</b>	1420	2866	2	2	2	2	2	3	
<b>AU 26</b>	750	451	15.0	10.5	192	113.2	<b>151</b>	58140	<b>2580</b>	1465	2955	2	2	2	2	2	3	
<b>PU sections</b>																		
<b>PU 12</b>	600	360	9.8	9.0	140	66.1	<b>110</b>	21600	<b>1200</b>	715	1457	2	2	2	2	2	3	
<b>PU 12 10/10</b>	600	360	10.0	10.0	148	69.6	<b>116</b>	22580	<b>1255</b>	755	1535	2	2	2	2	2	2	
<b>PU 18 - 1.0</b>	600	430	10.2	8.4	154	72.6	<b>121</b>	35950	<b>1670</b>	980	1988	2	2	2	2	2	3	
<b>PU 18</b>	600	430	11.2	9.0	163	76.9	<b>128</b>	38650	<b>1800</b>	1055	2134	2	2	2	2	2	2	
<b>PU 22 - 1.0</b>	600	450	11.1	9.0	174	81.9	<b>137</b>	46380	<b>2060</b>	1195	2422	2	2	2	2	2	2	
<b>PU 22</b>	600	450	12.1	9.5	183	86.1	<b>144</b>	49460	<b>2200</b>	1275	2580	2	2	2	2	2	2	
<b>PU 28 - 1.0</b>	600	452	14.2	9.7	207	97.4	<b>162</b>	60580	<b>2680</b>	1525	3087	2	2	2	2	2	2	
<b>PU 28</b>	600	454	15.2	10.1	216	101.8	<b>170</b>	64460	<b>2840</b>	1620	3269	2	2	2	2	2	2	
<b>PU 32</b>	600	452	19.5	11.0	242	114.1	<b>190</b>	72320	<b>3200</b>	1825	3687	2	2	2	2	2	2	

The moment of inertia and section moduli values given assume correct shear transfer across the interlock.

\*: Classification according to EN 1993-5.

Class 1 is obtained by verification of the rotation capacity for a class 2 cross-section.

A set of tables with all the data required for design in accordance with EN 1993-5 is available from our Technical Department.



# Product information

## U profile piles - Dimensions and properties

Table 1.14.1a continued

Section	Width		Height		Thickness		Sectional area cm <sup>2</sup> /m	Mass		Moment of inertia cm <sup>4</sup> /m	Elastic section modulus cm <sup>3</sup> /m	Static moment cm <sup>3</sup> /m	Plastic section modulus cm <sup>3</sup> /m	Class*				
	b mm	h mm	t mm	s mm	kg/m of single pile	kg/m <sup>2</sup> of wall												
<b>PU-R sections</b>																		
<b>PU 8R</b>	600	280	7.5	6.9	103	48.7	<b>81</b>	10830	<b>775</b>	445	905	3	3	4	4	4	4	-
<b>PU 9R</b>	600	360	7.0	6.4	105	49.5	<b>82</b>	16930	<b>940</b>	545	1115	3	3	4	4	4	4	-
<b>PU 10R</b>	600	360	8.0	7.0	114	53.8	<b>90</b>	18960	<b>1055</b>	610	1245	3	3	3	3	3	4	-
<b>PU 11R</b>	600	360	9.0	7.6	123	58.1	<b>97</b>	20960	<b>1165</b>	675	1370	2	2	3	3	3	3	-
<b>PU 13R</b>	675	400	10.0	7.4	124	65.6	<b>97</b>	25690	<b>1285</b>	750	1515	2	2	2	2	3	3	-
<b>PU 14R</b>	675	400	11.0	8.0	133	70.5	<b>104</b>	28000	<b>1400</b>	815	1655	2	2	2	2	2	2	-
<b>PU 15R</b>	675	400	12.0	8.6	142	75.4	<b>112</b>	30290	<b>1515</b>	885	1790	2	2	2	2	2	2	-
<b>GU sections</b>																		
<b>GU 7-600</b>	600	309	7.5	6.4	100	47.0	<b>78</b>	11350	<b>735</b>	435	890	2	2	3	3	-	-	-
<b>GU 8-600</b>	600	309	8.5	7.1	110	51.8	<b>86</b>	12690	<b>820</b>	485	995	2	2	2	2	-	-	-
<b>GU 9-600</b>	600	309	9.5	7.9	121	57.0	<b>95</b>	14060	<b>910</b>	540	1105	2	2	2	2	-	-	-
<b>GU 12-500</b>	500	340	9.0	8.5	144	56.6	<b>113</b>	19640	<b>1155</b>	680	1390	2	2	2	2	-	-	-
<b>GU 13-500</b>	500	340	10.0	9.0	155	60.8	<b>122</b>	21390	<b>1260</b>	740	1515	2	2	2	2	-	-	-
<b>GU 15-500</b>	500	340	12.0	10.0	177	69.3	<b>139</b>	24810	<b>1460</b>	855	1755	2	2	2	2	-	-	-
<b>GU 16-400</b>	400	290	12.7	9.4	197	62.0	<b>155</b>	22580	<b>1560</b>	885	1815	2	2	2	2	-	-	-
<b>GU 18-400</b>	400	292	15.0	9.7	221	69.3	<b>173</b>	26090	<b>1785</b>	1015	2080	2	2	2	2	-	-	-

The moment of inertia and section moduli values given assume correct shear transfer across the interlock.

\*: Classification according to EN 1993-5.

Class 1 is obtained by verification of the rotation capacity for a class 2 cross-section.

A set of tables with all the data required for design in accordance with EN 1993-5 is available from our Technical Department.

# Product information

## U profile piles - Dimensions and properties

Table 1.14.1b

Section	S = Single pile D = Double pile T = Triple pile	Sectional area cm <sup>2</sup>	Mass kg/m	Moment of inertia cm <sup>4</sup>	Elastic section modulus cm <sup>3</sup>	Radius of gyration cm	Coating area* m <sup>2</sup> /m
	Per S	99.2	<b>77.9</b>	6590	<b>457</b>	8.15	0.96
	Per D	198.5	<b>155.8</b>	43020	<b>2110</b>	14.73	1.91
	Per T	297.7	<b>233.7</b>	59550	<b>2435</b>	14.15	2.86
	Per m of wall	132.3	<b>103.8</b>	28680	<b>1405</b>	14.73	1.27
	Per S	109.9	<b>86.3</b>	7110	<b>481</b>	8.04	0.96
	Per D	219.7	<b>172.5</b>	49280	<b>2400</b>	14.98	1.91
	Per T	329.6	<b>258.7</b>	68080	<b>2750</b>	14.37	2.86
	Per m of wall	146.5	<b>115.0</b>	32850	<b>1600</b>	14.98	1.27
	Per S	113.4	<b>89.0</b>	7270	<b>488</b>	8.01	0.96
	Per D	226.9	<b>178.1</b>	51400	<b>2495</b>	15.05	1.91
	Per T	340.3	<b>267.2</b>	70960	<b>2855</b>	14.44	2.86
	Per m of wall	151.2	<b>118.7</b>	34270	<b>1665</b>	15.05	1.27
	Per S	112.7	<b>88.5</b>	8760	<b>554</b>	8.82	1.01
	Per D	225.5	<b>177.0</b>	58950	<b>2670</b>	16.17	2.00
	Per T	338.2	<b>265.5</b>	81520	<b>3065</b>	15.53	2.99
	Per m of wall	150.3	<b>118.0</b>	39300	<b>1780</b>	16.17	1.33
	Per S	123.4	<b>96.9</b>	9380	<b>579</b>	8.72	1.01
	Per D	246.9	<b>193.8</b>	66660	<b>3000</b>	16.43	2.00
	Per T	370.3	<b>290.7</b>	92010	<b>3425</b>	15.76	2.99
	Per m of wall	164.6	<b>129.2</b>	44440	<b>2000</b>	16.43	1.33
	Per S	127.0	<b>99.7</b>	9580	<b>588</b>	8.69	1.01
	Per D	253.9	<b>199.3</b>	69270	<b>3110</b>	16.52	2.00
	Per T	380.9	<b>299.0</b>	95560	<b>3545</b>	15.84	2.99
	Per m of wall	169.3	<b>132.9</b>	46180	<b>2075</b>	16.52	1.33
	Per S	130.1	<b>102.1</b>	9830	<b>579</b>	8.69	1.03
	Per D	260.1	<b>204.2</b>	76050	<b>3405</b>	17.10	2.04
	Per T	390.2	<b>306.3</b>	104680	<b>3840</b>	16.38	3.05
	Per m of wall	173.4	<b>136.1</b>	50700	<b>2270</b>	17.10	1.36
	Per S	140.6	<b>110.4</b>	10390	<b>601</b>	8.60	1.03
	Per D	281.3	<b>220.8</b>	84370	<b>3750</b>	17.32	2.04
	Per T	422.0	<b>331.3</b>	115950	<b>4215</b>	16.58	3.05
	Per m of wall	187.5	<b>147.2</b>	56240	<b>2500</b>	17.32	1.36
	Per S	144.2	<b>113.2</b>	10580	<b>608</b>	8.57	1.03
	Per D	288.4	<b>226.4</b>	87220	<b>3870</b>	17.39	2.04
	Per T	432.6	<b>339.6</b>	119810	<b>4340</b>	16.64	3.05
	Per m of wall	192.2	<b>150.9</b>	58140	<b>2580</b>	17.39	1.36

- S: considered neutral axis y'-y'  
 - D: wall: considered neutral axis y-y  
 - T: considered neutral axis y''-y''

\* One side, excluding inside of interlocks.

# Product information

## U profile piles - Dimensions and properties

Table 1.14.1c

Section	S = Single pile D = Double pile T = Triple pile	Sectional area	Mass	Moment of inertia	Elastic section modulus	Radius of gyration	Coating area*
	Per S	84.2	<b>66.1</b>	4500	<b>370</b>	7.31	0.80
	Per D	168.4	<b>132.2</b>	25920	<b>1440</b>	12.41	1.59
	Per T	252.6	<b>198.3</b>	36060	<b>1690</b>	11.95	2.38
	Per m of wall	140.0	<b>110.1</b>	21600	<b>1200</b>	12.41	1.32
	Per S	88.7	<b>69.6</b>	4600	<b>377</b>	7.20	0.80
	Per D	177.3	<b>139.2</b>	27100	<b>1505</b>	12.36	1.59
	Per T	266.0	<b>208.8</b>	37670	<b>1765</b>	11.90	2.38
	Per m of wall	147.8	<b>116.0</b>	22580	<b>1255</b>	12.36	1.32
	Per S	92.5	<b>72.6</b>	6960	<b>473</b>	8.67	0.87
	Per D	185.0	<b>145.2</b>	43140	<b>2005</b>	15.3	1.72
	Per T	277.5	<b>217.8</b>	59840	<b>2330</b>	14.69	2.58
	Per m of wall	154.2	<b>121.0</b>	35950	<b>1670</b>	15.3	1.43
	Per S	98.0	<b>76.9</b>	7220	<b>484</b>	8.58	0.87
	Per D	196.0	<b>153.8</b>	46380	<b>2160</b>	15.38	1.72
	Per T	294.0	<b>230.7</b>	64240	<b>2495</b>	14.78	2.58
	Per m of wall	163.3	<b>128.2</b>	38650	<b>1800</b>	15.38	1.43
	Per S	104.3	<b>81.9</b>	8460	<b>535</b>	9.01	0.90
	Per D	208.7	<b>163.8</b>	55650	<b>2475</b>	16.33	1.79
	Per T	313.0	<b>245.7</b>	77020	<b>2850</b>	15.69	2.68
	Per m of wall	173.9	<b>136.5</b>	46380	<b>2060</b>	16.33	1.49
	Per S	109.7	<b>86.1</b>	8740	<b>546</b>	8.93	0.90
	Per D	219.5	<b>172.3</b>	59360	<b>2640</b>	16.45	1.79
	Per T	329.2	<b>258.4</b>	82060	<b>3025</b>	15.79	2.68
	Per m of wall	182.9	<b>143.6</b>	49460	<b>2200</b>	16.45	1.49
	Per S	124.1	<b>97.4</b>	9740	<b>576</b>	8.86	0.93
	Per D	248.2	<b>194.8</b>	72700	<b>3215</b>	17.12	1.85
	Per T	372.3	<b>292.2</b>	100170	<b>3645</b>	16.40	2.77
	Per m of wall	206.8	<b>162.3</b>	60580	<b>2680</b>	17.12	1.54

- S: considered neutral axis y'-y'
- D, wall: considered neutral axis y-y
- T: considered neutral axis y''-y''

\* One side, excluding inside of interlocks.

# Product information

## U profile piles - Dimensions and properties

Table 1.14.1c continued

Section	S = Single pile D = Double pile T = Triple pile	Sectional area cm <sup>2</sup>	Mass kg/m	Moment of inertia cm <sup>4</sup>	Elastic section modulus cm <sup>3</sup>	Radius of gyration cm	Coating area* m <sup>2</sup> /m
<b>PU 28</b> 	Per S	129.7	<b>101.8</b>	10070	<b>589</b>	8.81	0.93
	Per D	259.4	<b>203.6</b>	77350	<b>3405</b>	17.27	1.85
	Per T	389.0	<b>305.4</b>	106490	<b>3850</b>	16.55	2.77
	Per m of wall	216.1	<b>169.6</b>	64460	<b>2840</b>	17.27	1.54
<b>PU 32</b> 	Per S	145.4	<b>114.1</b>	10950	<b>633</b>	8.68	0.92
	Per D	290.8	<b>228.3</b>	86790	<b>3840</b>	17.28	1.83
	Per T	436.2	<b>342.4</b>	119370	<b>4330</b>	16.54	2.74
	Per m of wall	242.0	<b>190.2</b>	72320	<b>3200</b>	17.28	1.52

Table 1.14.1d

Section	S = Single pile D = Double pile T = Triple pile	Sectional area cm <sup>2</sup>	Mass kg/m	Moment of inertia cm <sup>4</sup>	Elastic section modulus cm <sup>3</sup>	Radius of gyration cm	Coating area* m <sup>2</sup> /m
<b>PU 8R</b> 	Per S	62.0	<b>48.7</b>	2070	<b>200</b>	5.78	0.76
	Per D	124.0	<b>97.3</b>	13000	<b>930</b>	10.24	1.51
	Per T	186.0	<b>146.0</b>	18030	<b>1070</b>	9.85	2.27
	Per m of wall	103.3	<b>81.1</b>	10830	<b>775</b>	10.24	1.26
<b>PU 9R</b> 	Per S	63.0	<b>49.5</b>	3500	<b>285</b>	7.45	0.81
	Per D	126.0	<b>98.9</b>	20320	<b>1130</b>	12.70	1.62
	Per T	189.1	<b>148.4</b>	28260	<b>1320</b>	12.23	2.42
	Per m of wall	105.0	<b>82.5</b>	16930	<b>940</b>	12.70	1.35
<b>PU 10R</b> 	Per S	68.5	<b>53.8</b>	3700	<b>295</b>	7.35	0.81
	Per D	137.1	<b>107.6</b>	22750	<b>1265</b>	12.88	1.62
	Per T	205.6	<b>161.4</b>	31570	<b>1465</b>	12.39	2.42
	Per m of wall	114.2	<b>89.7</b>	18960	<b>1055</b>	12.88	1.35
<b>PU 11R</b> 	Per S	74.1	<b>58.1</b>	3890	<b>305</b>	7.25	0.81
	Per D	148.1	<b>116.3</b>	25150	<b>1395</b>	13.03	1.62
	Per T	222.2	<b>174.4</b>	34830	<b>1610</b>	12.52	2.42
	Per m of wall	123.4	<b>96.9</b>	20960	<b>1165</b>	13.03	1.35

- S: considered neutral axis y'-y'  
 - D, wall: considered neutral axis y-y'  
 - T: considered neutral axis y''-y''

\* One side, excluding inside of interlocks.

# Product information

## U profile piles - Dimensions and properties

Table 1.14.1d continued

Section	S = Single pile D = Double pile T = Triple pile	Sectional area cm <sup>2</sup>	Mass kg/m	Moment of inertia cm <sup>4</sup>	Elastic section modulus cm <sup>3</sup>	Radius of gyration cm	Coating area* m <sup>2</sup> /m
<b>PU 13R</b> 	Per S	83.6	<b>65.6</b>	5390	<b>385</b>	8.03	0.89
	Per D	167.2	<b>131.2</b>	34680	<b>1735</b>	14.40	1.78
	Per T	250.8	<b>196.9</b>	48040	<b>2005</b>	13.84	2.66
	Per m of wall	123.8	<b>97.2</b>	25690	<b>1285</b>	14.40	1.32
<b>PU 14R</b> 	Per S	89.8	<b>70.5</b>	5630	<b>395</b>	7.92	0.89
	Per D	179.7	<b>141.0</b>	37800	<b>1890</b>	14.51	1.78
	Per T	269.5	<b>211.5</b>	52280	<b>2175</b>	13.93	2.66
	Per m of wall	133.1	<b>104.5</b>	28000	<b>1400</b>	14.51	1.32
<b>PU 15R</b> 	Per S	96.1	<b>75.4</b>	5860	<b>410</b>	7.81	0.89
	Per D	192.1	<b>150.8</b>	40890	<b>2045</b>	14.59	1.78
	Per T	288.2	<b>226.2</b>	56470	<b>2340</b>	14.00	2.66
	Per m of wall	142.3	<b>111.7</b>	30290	<b>1515</b>	14.59	1.32

- S: considered neutral axis y'-y'
- D, wall: considered neutral axis y-y
- T: considered neutral axis y''-y''

\* One side, excluding inside of interlocks.

# Product information

## U profile piles - Dimensions and properties

Table 1.14.1e

Section	S = Single pile D = Double pile T = Triple pile	Sectional area cm <sup>2</sup>	Mass kg/m	Moment of inertia cm <sup>4</sup>	Elastic section modulus cm <sup>3</sup>	Radius of gyration cm	Coating area* m <sup>2</sup> /m
<b>GU 7-600</b> 	Per S	59.8	<b>47.0</b>	2440	<b>230</b>	6.39	0.76
	Per D	119.7	<b>94.0</b>	13620	<b>880</b>	10.67	1.51
	Per T	179.5	<b>140.9</b>	18980	<b>1035</b>	10.28	2.27
	Per m of wall	99.7	<b>78.3</b>	11350	<b>735</b>	10.67	1.26
	<b>GU 8-600</b> 	Per S	66.0	<b>51.8</b>	2670	<b>245</b>	6.36
Per D		132.0	<b>103.6</b>	15230	<b>985</b>	10.74	1.51
Per T		198.0	<b>155.4</b>	21190	<b>1155</b>	10.35	2.27
Per m of wall		110.0	<b>86.4</b>	12690	<b>820</b>	10.74	1.26
<b>GU 9-600</b> 		Per S	72.6	<b>57.0</b>	2900	<b>265</b>	6.32
	Per D	145.2	<b>114.0</b>	16880	<b>1090</b>	10.78	1.51
	Per T	217.8	<b>170.9</b>	23470	<b>1280</b>	10.38	2.27
	Per m of wall	121.0	<b>95.0</b>	14060	<b>910</b>	10.78	1.26
	<b>GU 12-500</b> 	Per S	72.1	<b>56.6</b>	3600	<b>315</b>	7.06
Per D		144.3	<b>113.2</b>	19640	<b>1155</b>	11.67	1.44
Per T		216.4	<b>169.9</b>	27390	<b>1365</b>	11.25	2.16
Per m of wall		144.3	<b>113.2</b>	19640	<b>1155</b>	11.67	1.44
<b>GU 13-500</b> 		Per S	77.5	<b>60.8</b>	3870	<b>335</b>	7.07
	Per D	155.0	<b>121.7</b>	21390	<b>1260</b>	11.75	1.44
	Per T	232.5	<b>182.5</b>	29810	<b>1480</b>	11.32	2.16
	Per m of wall	155.0	<b>121.7</b>	21390	<b>1260</b>	11.75	1.44
	<b>GU 15-500</b> 	Per S	88.3	<b>69.3</b>	4420	<b>370</b>	7.07
Per D		176.5	<b>138.6</b>	24810	<b>1460</b>	11.86	1.44
Per T		264.8	<b>207.9</b>	34550	<b>1715</b>	11.42	2.16
Per m of wall		176.5	<b>138.6</b>	24810	<b>1460</b>	11.86	1.44
<b>GU 16-400</b> 		Per S	78.9	<b>62.0</b>	2950	<b>265</b>	6.11
	Per D	157.9	<b>123.9</b>	18060	<b>1245</b>	10.70	1.28
	Per T	236.8	<b>185.9</b>	25060	<b>1440</b>	10.29	1.92
	Per m of wall	197.3	<b>154.9</b>	22580	<b>1560</b>	10.70	1.60
	<b>GU 18-400</b> 	Per S	88.3	<b>69.3</b>	3290	<b>290</b>	6.10
Per D		176.7	<b>138.7</b>	20870	<b>1430</b>	10.87	1.28
Per T		265.0	<b>208.0</b>	28920	<b>1645</b>	10.45	1.92
Per m of wall		220.8	<b>173.3</b>	26090	<b>1785</b>	10.87	1.60

- S: considered neutral axis y'-y'  
 - D, wall: considered neutral axis y-y  
 - T: considered neutral axis y"-y"

\* One side, excluding inside of interlocks.

## Product information

### 1.14.2 Interlocking in pairs

U piles are normally supplied as single piles and are easily handled, stacked and pitched in that form. Subject to prior arrangement, U piles can be supplied interlocked in pairs to minimise the number of handling and pitching operations on site.

It should be noted however that when interlocked in pairs, the resulting shape is asymmetric requiring care when stacking.

When U piles are interlocked prior to delivery in pairs there are two possible orientations when viewed from the end of the pile with the lifting hole as illustrated in Fig 1.14.4. The orientation can be reversed by burning lifting holes at the bottom of the pile and picking it up using the revised holes.

#### Development of section modulus

When sheet piles are driven into reasonably competent soils the longitudinal shear force that develops between the inner and outer leaves of a pair of U piles as a result of bending is resisted by:

- Friction resulting from the variation of interlock geometry along the length of a pile
- Friction due to soil particles being forced into the interlocks during driving
- Embedment of the piles below excavation level to a depth necessary to create sufficient passive resistance
- Friction at the soil/pile interfaces
- Interaction with walings and capping beams
- The type of the installed sheet pile (single, double, triple)
- The driving method

If the resistance generated by these factors is sufficient to counteract the longitudinal shear force, the piles will develop full section modulus.

However, it is advisable, in certain conditions, to connect together the inner and outer leaves of a wall by crimping or welding the common interlock to ensure that the necessary resistance to longitudinal shear is developed. Such conditions arise when:

- The piles are acting in cantilever
- The piles are prevented from penetrating to the design depth of embedment by rock or hard ground
- The piles are supporting open water or very soft clays and silts;
- The pile interlocks have been lubricated



## Product information

U piles have been in use for almost a century for the construction of embedded retaining walls and the need for caution when designing walls in the situations mentioned above is understood. Whilst adoption of the maximum modulus in the situations mentioned above may be slightly optimistic, the automatic reduction of the wall modulus developed by U piles to that of the unconnected sections is far too pessimistic.

### 1.14.3 Crimping and welding of the interlocks

Pairs of piles can be crimped or welded together if required. Normally 3 to 4 crimps per metre are requested but other configurations can be accommodated with prior agreement. Each crimp is applied to provide an allowable shear resistance of 75kN with less than 5mm movement.

Fig 1.14.3

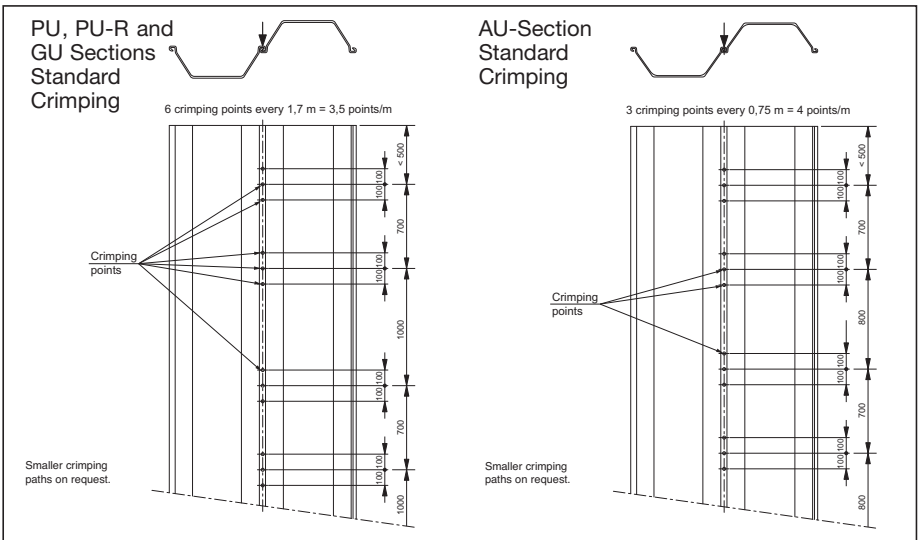

### 1.14.4 Pile form

Piles can be supplied as illustrated.

Fig 1.14.4

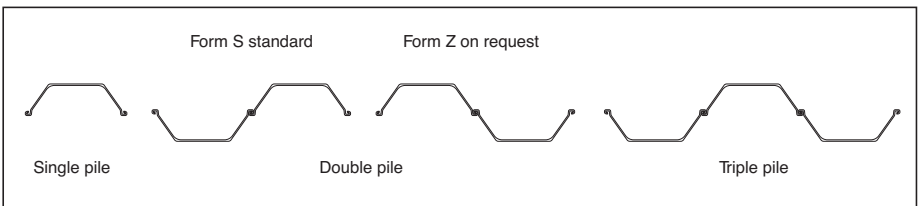

## Product information

### 1.14.5 Circular construction

Steel sheet piling can be driven to form a complete circle without the need for corner piles. The maximum angle of deviation for AU, PU, PU-R and GU sections is 5° for single piles.

The following table gives the approximate minimum diameters of circular cofferdam which can be constructed using various sheet pile sections. The diameters are only intended to be for guidance as the actual interlock deviation achieved will be a function of the pile length, the pile section, the penetration required. Smaller diameters can be achieved by introducing bent corner piles, but larger diameters will result from using pairs of piles that have been crimped or welded.

Table 1.14.5

Section	Minimum number of single piles used Angle = 5°	Approx. min diameter to internal face of wall m
AU 14, AU 16, AU 17	72	16.8
AU 18, AU 20, AU 21	72	16.8
AU 23, AU 25, AU 26	72	16.8
PU 12, PU 12 10/10	72	13.4
PU 18, PU 22, PU28, PU 32	72	13.3
PU 8R	72	13.5
PU 9R, PU 10R, PU 11R	72	13.4
PU 13R, PU 14R, PU 15R	72	15.1
GU 7-600, GU 8-600, GU 9-600	72	13.4
GU 12-500, GU 13-500, GU 15-500	72	11.1
GU 16-400, GU 18-400	72	8.9

# Product information

## 1.15 Straight web piles

### 1.15.1 Dimensions and properties for AS-500 Straight Web piles

Fig 1.15.1a

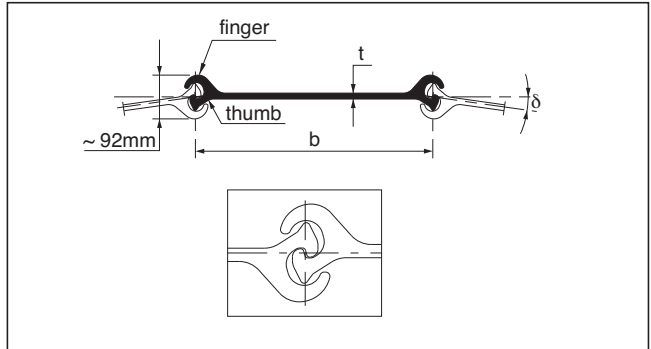

Table 1.15.1

Section	Nominal width*	Web thickness	Deviation angle	Perimeter of a single pile	Steel section of a single pile	Mass per m of a single pile	Mass per m <sup>2</sup> of wall	Moment of inertia of a single pile	Section modulus of a single pile	Coating area***
	b mm	t mm	δ °	cm	cm <sup>2</sup>	kg/m	kg/m <sup>2</sup>	cm <sup>4</sup>	cm <sup>3</sup>	m <sup>2</sup> /m
<b>AS 500-9,5</b>	500	9.5	4.5**	138	81.3	63.8	<b>128</b>	168	46	0.58
<b>AS 500-11,0</b>	500	11.0	4.5**	139	90.0	70.6	<b>141</b>	186	49	0.58
<b>AS 500-12,0</b>	500	12.0	4.5**	139	94.6	74.3	<b>149</b>	196	51	0.58
<b>AS 500-12,5</b>	500	12.5	4.5**	139	97.2	76.3	<b>153</b>	201	51	0.58
<b>AS 500-12,7</b>	500	12.7	4.5**	139	98.2	77.1	<b>154</b>	204	51	0.58

Note: all straight web sections interlock with each other.

\* The **effective width** to be taken into account for design purposes (lay-out) is **503 mm** for all AS 500 sheet piles.

\*\* Max. deviation angle 4.0° for pile length > 20 m.

\*\*\* On one side, excluding inside of interlocks.

# Product information

## Interlock Strength

The interlock complies with EN 10248. Following interlock strength  $F_{max}$  can be achieved with a steel grade S 355 GP. However, higher steel grades are available.

Sheet pile	$F_{max}$ [kN/m]
AS 500 - 9.5	3,000
AS 500 - 11.0	3,500
AS 500 - 12.0	5,000
AS 500 - 12.5	5,500
AS 500 - 12.7	5,500

## Junction piles

In general junction piles are assembled by welding in accordance with EN 12063.

Fig 1.15.1b

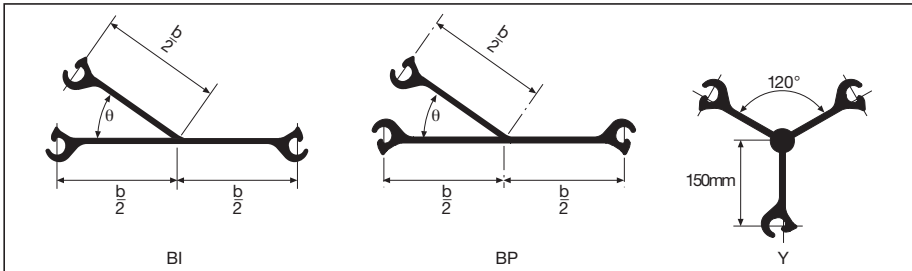

The connecting angle  $\theta$  should be in the range from  $30^\circ$  to  $45^\circ$ .

## Types of cell

Fig 1.15.1c

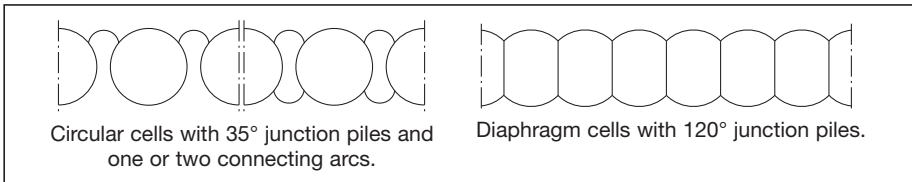

## Bent piles

If deviation angles exceeding the values given in table 1.15.1 have to be attained, piles pre-bent in the mill may be used.

Fig 1.15.1d



# Product information

## 1.16 Combined wall systems

### 1.16.1 HZ/AZ pile system

The HZ /AZ wall is a combined wall system involving HZ king piles as the main structural support elements, AZ sheet piles as the infill members with special connectors to join the parts together.

The following tables give dimensions and properties for the component parts (AZ pile data can be found in Section 1.13.1).

**A new combined wall system HZ-M/AZ will be available from end of 2008 on, based on an innovative concept. During a transition period, both HZ and HZ-M systems will be manufactured.**

Table 1.16.1a

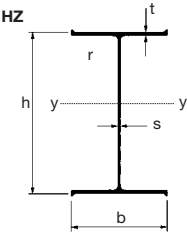
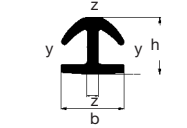
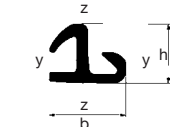
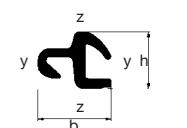
Section	Dimensions					Sectional area cm <sup>2</sup>	Mass kg/m	Moment of inertia y-y cm <sup>4</sup>	Elastic section modulus y-y cm <sup>3</sup>	Perimeter m <sup>2</sup> /m	Interlocking section
	h mm	b mm	t mm	s mm	r mm						
	<b>HZ 775 A</b>	775.0	460.0	17.0	12.5	20	257.9	<b>202.4</b>	280070	<b>7230</b>	3.39 RH16-RZDU16
	<b>HZ 775 B</b>	779.0	460.0	19.0	12.5	20	276.3	<b>216.9</b>	307930	<b>7905</b>	3.40 RH16-RZDU16
	<b>HZ 775 C</b>	783.0	461.5	21.0	14.0	20	306.8	<b>240.8</b>	342680	<b>8755</b>	3.41 RH20-RZDU18
	<b>HZ 775 D</b>	787.0	461.5	23.0	14.0	20	325.3	<b>255.3</b>	371220	<b>9435</b>	3.42 RH20-RZDU18
	<b>HZ 975 A</b>	975.0	460.0	17.0	14.0	20	297.0	<b>233.1</b>	476680	<b>9780</b>	3.79 RH16-RZDU16
	<b>HZ 975 B</b>	979.0	460.0	19.0	14.0	20	315.4	<b>247.6</b>	520700	<b>10635</b>	3.79 RH16-RZDU16
	<b>HZ 975 C</b>	983.0	462.0	21.0	16.0	20	353.9	<b>277.8</b>	582170	<b>11845</b>	3.81 RH20-RZDU18
	<b>HZ 975 D</b>	987.0	462.0	23.0	16.0	20	372.4	<b>292.3</b>	627120	<b>12710</b>	3.81 RH20-RZDU18
	<b>RH 16</b>	62	68	-	12.2	-	20.4	<b>16.0</b>	83	<b>26</b>	-
	<b>RH 20</b>	67	79	-	14.2	-	25.5	<b>20.0</b>	123	<b>34</b>	-
	<b>RZU 16</b>	62	80	-	-	-	20.6	<b>16.1</b>	70	<b>18</b>	-
	<b>RZU 18</b>	67	84	-	-	-	22.9	<b>17.9</b>	95	<b>23</b>	-
	<b>RZD 16</b>	62	80	-	-	-	20.6	<b>16.2</b>	58	<b>19</b>	-
	<b>RZD 18</b>	67	84	-	-	-	22.9	<b>18.1</b>	80	<b>22</b>	-

## Product information

The outstanding feature of this form of wall is the range of options that can be created by combining different beams, sheet piles and connectors.

For example the combination of a single beam and sheet pile with connectors to join everything together can be modified by adding additional 'connectors' to the rear flange of the beam at the level of highest bending moment applied or by adopting two beams for every pair of sheet piles.

The following tables give an indication of what properties can be generated for particular combinations of components.

Table 1.16.1b

Section	Dimension h mm	Properties per metre of wall					Mass***		Coating area Water-side m <sup>2</sup> /m
		Sectional area cm <sup>2</sup> /m	Moment of inertia cm <sup>4</sup> /m	Elastic* section modulus cm <sup>3</sup> /m	Elastic** section modulus cm <sup>3</sup> /m	I AZ = 60 % I HZ kg/m <sup>2</sup>	I AZ = I HZ kg/m <sup>2</sup>		
<b>Combination HZ ... -12 / AZ 18</b>	<b>HZ 775 A</b>	775.0	273.0	210000	5720	<b>4765</b>	174	214	2.332
	<b>HZ 775 B</b>	779.0	283.3	225980	6095	<b>5140</b>	182	222	2.332
	<b>HZ 775 C</b>	783.0	303.0	248530	6660	<b>5630</b>	197	238	2.346
	<b>HZ 775 D</b>	787.0	313.3	264810	7040	<b>6005</b>	205	246	2.346
	<b>HZ 975 A</b>	975.0	294.8	337840	7340	<b>6180</b>	191	231	2.332
	<b>HZ 975 B</b>	979.0	305.1	363060	7815	<b>6655</b>	199	240	2.332
	<b>HZ 975 C</b>	983.0	329.3	402610	8610	<b>7360</b>	217	258	2.347
	<b>HZ 975 D</b>	987.0	339.6	428250	9095	<b>7835</b>	225	267	2.347
<b>Combination HZ ... -24 / AZ 18</b>	<b>HZ 775 A</b>	775.0	346.8	317820	7120	<b>7675</b>	240	272	2.866
	<b>HZ 775 B</b>	779.0	363.0	342750	7690	<b>8270</b>	253	285	2.866
	<b>HZ 775 C</b>	783.0	396.5	382550	8540	<b>9190</b>	279	311	2.886
	<b>HZ 775 D</b>	787.0	412.8	407960	9120	<b>9780</b>	291	324	2.886
	<b>HZ 975 A</b>	975.0	381.3	521630	9505	<b>10090</b>	267	299	2.865
	<b>HZ 975 B</b>	979.0	397.5	561040	10220	<b>10840</b>	280	312	2.865
	<b>HZ 975 C</b>	983.0	438.0	629940	11440	<b>12135</b>	311	344	2.888
	<b>HZ 975 D</b>	987.0	454.3	670070	12170	<b>12885</b>	324	357	2.888

\* Referring to outside of connector

\*\* Referring to outside of HZ flange

\*\*\* Length of RZ connector = Length of AZ

\*\*\* Length of RH connector = Length of HZ

# Product information

Table 1.16.1c

	Section	Dimension		Properties per meter of wall				Mass kg/m <sup>2</sup>	Coating area Water-side m <sup>2</sup> /m
		b	h	Sectional area cm <sup>2</sup> /m	Moment of inertia cm <sup>4</sup> /m	Elastic* section modulus cm <sup>3</sup> /m	Elastic** section modulus cm <sup>3</sup> /m		
		mm	mm						
<b>Combination C1</b>	<b>HZ 775 A</b>	475.0	775.0	585.8	649450	16595	<b>15615</b>	460	0.534
	<b>HZ 775 B</b>	475.0	779.0	624.5	708720	17985	<b>17030</b>	490	0.534
	<b>HZ 775 C</b>	479.0	783.0	693.7	789060	20055	<b>18735</b>	545	0.540
	<b>HZ 775 D</b>	479.0	787.0	732.3	849160	21470	<b>20140</b>	575	0.540
	<b>HZ 975 A</b>	475.0	975.0	668.1	1098910	22515	<b>21185</b>	524	0.534
	<b>HZ 975 B</b>	475.0	979.0	706.8	1192510	24280	<b>22970</b>	555	0.534
	<b>HZ 975 C</b>	480.0	983.0	790.4	1330350	27130	<b>25380</b>	620	0.541
	<b>HZ 975 D</b>	480.0	987.0	828.9	1424880	28915	<b>27155</b>	651	0.541

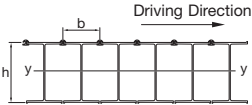

\* Referring to outside of connector

\*\* Referring to outside of HZ-flange

## 1.16.2 Box piles

### General

Welded box piles are fabricated from conventional hot rolled sheet piles and can therefore be supplied in the steel grades indicated in table 1.3.1 and to the lengths indicated in section 1.6. Where greater lengths are required or in cases where equipment on site is unable to handle the total required length, the piles can be extended with minimal effort using site butt welds. Welding details are available on request.

Box piles, formed from four AZ sections, a pair of AZ's and a plate or a pair of U sections can be conveniently introduced into a line of sheet piling at any point where heavy loads are to be applied. They can be used to resist vertical and horizontal forces and can generally be positioned in the wall such that its appearance is unaffected.

Boxes may also be used as individual bearing piles for foundations or in open jetty and dolphin construction. Their large radius of gyration makes them particularly suitable for situations where construction involves long lengths of pile with little or no lateral support.

In general, box piles are driven open ended. Soil displacement and ground heave is normally eliminated since the soil enters the open end of the pile during initial penetration and forms an effective plug as the toe depth increases. Box piles can be driven into all normal soils, very compact ground and soft rocks.

### CAZ box piles

CAZ box piles are formed by welding together two pairs of interlocked and intermittently welded AZ sheet piles.

# Product information

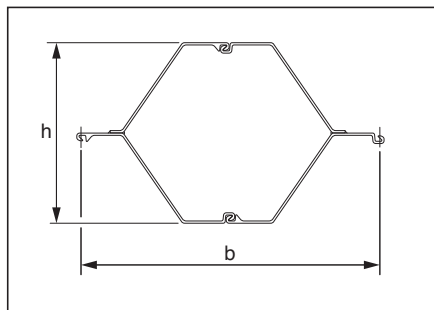

Table 1.16.2a Dimensions and properties of CAZ box piles

Section	b	h	Perim cm	Sectional Area cm <sup>2</sup>	Total Section Area cm <sup>2</sup>	Mass* kg/m	Moment of Inertia		Elastic section modulus		Min Rad of gyration cm	Coating ** area m <sup>2</sup> /m
	mm	mm					y-y cm <sup>4</sup>	z-z cm <sup>4</sup>	y-y cm <sup>3</sup>	z-z cm <sup>3</sup>		
CAZ 12	1340	604	348	293	4166	230	125610	369510	4135	5295	20.7	3.29
CAZ 13	1340	606	349	320	4191	251	136850	402270	4490	5765	20.7	3.29
CAZ 14	1340	608	349	348	4217	273	148770	436260	4865	6255	20.7	3.29
CAZ 17	1260	758	360	305	4900	239	205040	335880	5385	5105	25.9	3.41
CAZ 18	1260	760	361	333	4925	261	222930	365500	5840	5560	25.9	3.41
CAZ 19	1260	762	361	362	4951	284	242210	396600	6330	6035	25.9	3.41
CAZ 25	1260	852	376	411	5540	323	343000	450240	8020	6925	28.9	3.57
CAZ 26	1260	854	377	440	5566	346	366820	480410	8555	7385	28.9	3.57
CAZ 28	1260	856	377	471	5592	370	392170	513050	9125	7820	28.9	3.57
CAZ 46	1160	962	401	595	5831	467	645940	527590	13380	8825	32.9	3.81
CAZ 48	1160	964	402	628	5858	493	681190	556070	14080	9300	32.9	3.81
CAZ 50	1160	966	402	661	5884	519	716620	584560	14780	9780	32.9	3.81
CAZ 12-770	1540	687	389	328	5431	257	175060	557980	3295	4545	23.1	3.67
CAZ 13-770	1540	688	389	344	5446	270	183440	584640	3445	4755	23.1	3.67
CAZ 14-770	1540	689	390	360	5461	283	191840	611290	3600	4985	23.1	3.67
CAZ 14-770-10/1	1540	690	390	376	5476	295	200280	637960	3750	5190	23.1	3.67
CAZ 17 - 700	1400	839	391	330	6015	259	265280	457950	6300	6285	28.3	3.69
CAZ 18 - 700	1400	840	391	347	6029	272	277840	479790	6590	6590	28.3	3.69
CAZ 19 - 700	1400	841	392	363	6044	285	290440	501620	6880	6890	28.3	3.69
CAZ 20 - 700	1400	842	392	379	6058	297	303090	523460	7170	7195	28.3	3.69
CAZ 24 - 700	1400	918	407	436	6616	342	412960	596900	8965	8260	30.8	3.85
CAZ 26 - 700	1400	920	407	469	6645	368	444300	641850	9625	8900	30.8	3.85
CAZ 28 - 700	1400	922	408	503	6674	395	475810	686880	10285	9510	30.8	3.85
CAZ 37 - 700	1400	998	431	556	7223	437	652440	738380	13030	10285	34.2	4.10
CAZ 39 - 700	1400	1000	432	592	7253	465	692730	784530	13805	10930	34.2	4.10
CAZ 41 - 700	1400	1002	432	628	7283	493	733230	830690	14585	11570	34.2	4.10

\* The mass of welds is not taken into account

\*\* Outside surface, excluding inside of interlocks



# Product information

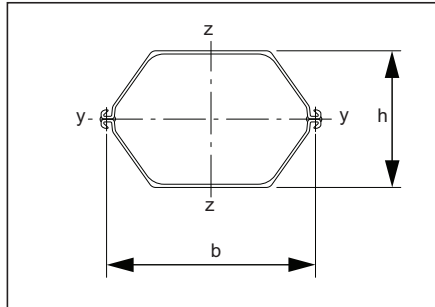

Table 1.16.2b Dimensions and properties of CAU, CU, CPU-R and CGU box piles

Section	b	h	Perim	Sectional Area	Total Section Area	Mass*	Moment of Inertia		Elastic section modulus		Min Rad of gyration	Coating **
							y-y	z-z	y-y	z-z		
	mm	mm	cm	cm <sup>2</sup>	cm <sup>2</sup>	kg/m	cm <sup>4</sup>	cm <sup>4</sup>	cm <sup>3</sup>	cm <sup>3</sup>	cm	m <sup>2</sup> /m
<b>CAU double box piles</b>												
CAU 14 - 2	750	451	230	198	2598	155.8	54400	121490	2415	3095	16.6	2.04
CAU 16 - 2	750	454	231	220	2620	172.5	62240	130380	2745	3325	16.8	2.04
CAU 17 - 2	750	455	231	227	2626	178.1	64840	133330	2855	3400	16.9	2.04
CAU 18 - 2	750	486	239	225	2888	177.0	73770	142380	3035	3625	18.1	2.14
CAU 20 - 2	750	489	240	247	2910	193.8	83370	151220	3405	3850	18.4	2.14
CAU 21 - 2	750	490	240	254	2916	199.3	86540	153990	3530	3920	18.5	2.14
CAU 23 - 2	750	492	244	260	3013	204.2	94540	157900	3845	4020	19.1	2.19
CAU 25 - 2	750	495	245	281	3034	220.8	104810	166600	4235	4240	19.3	2.19
CAU 26 - 2	750	496	245	288	3041	226.4	108260	169510	4365	4315	19.4	2.19
<b>CU double box piles</b>												
CU 12 - 2	600	403	198	168	1850	132.2	34000	70000	1685	2205	14.2	1.72
CU 12 10/10 - 2	600	403	198	177	1850	139.2	35580	73460	1765	2315	14.2	1.72
CU 18 - 2	600	473	212	196	2184	153.8	58020	78300	2455	2470	17.2	1.86
CU 22 - 2	600	494	220	219	2347	172.3	73740	88960	2985	2800	18.3	1.94
CU 28 - 2	600	499	226	259	2468	203.6	96000	103560	3850	3260	19.2	2.00
CU 32 - 2	600	499	223	291	2461	228.3	108800	109200	4360	3435	19.3	1.97
<b>CPU-R double box piles</b>												
CPU 8R-2	600	318	188	124	1555	97.3	17380	52200	1095	1655	11.8	1.62
CPU 9R-2	600	399	199	126	1893	98.9	25850	54900	1295	1740	14.3	1.73
CPU 10R-2	600	399	199	137	1893	107.6	28930	57700	1450	1825	14.5	1.73
CPU 11R-2	600	399	199	148	1893	116.3	31970	60490	1600	1915	14.7	1.73
CPU 13R-2	675	441	215	167	2275	131.2	43580	82570	1975	2335	16.1	1.89
CPU 14R-2	675	441	215	180	2275	141.0	47510	86610	2155	2450	16.3	1.89
CPU 15R-2	675	441	215	192	2275	150.8	51400	90640	2330	2560	16.4	1.89

\* The mass of welds is not taken into account

\*\* Outside surface, excluding inside of interlocks

\* The mass of welds is not taken into account

\*\* Outside surface, excluding inside of interlocks

# Product information

Table 1.16.2b – continued

Section	b	h	Perim	Sectional Area	Total Section Area	Mass*	Moment of Inertia		Elastic section modulus		Min Rad of gyration	Coating **
	mm	mm	cm	cm <sup>2</sup>	cm <sup>2</sup>	kg/m	y-y cm <sup>4</sup>	z-z cm <sup>4</sup>	y-y cm <sup>3</sup>	z-z cm <sup>3</sup>	cm	m <sup>2</sup> /m
<b>CGU double box piles</b>												
<b>CGU 7-600</b>	600	350	184	120	1613	<b>94.0</b>	18320	50470	<b>1045</b>	<b>1595</b>	12.4	1.60
<b>CGU 8-600</b>	600	352	184	132	1625	<b>103.6</b>	20760	54520	<b>1180</b>	<b>1725</b>	12.5	1.60
<b>CGU 9-600</b>	600	354	184	145	1638	<b>114.0</b>	23330	58990	<b>1320</b>	<b>1865</b>	12.7	1.60
<b>CGU 12-500</b>	500	381	178	144	1514	<b>113.2</b>	25800	44790	<b>1355</b>	<b>1665</b>	13.4	1.54
<b>CGU 13-500</b>	500	383	179	155	1525	<b>121.7</b>	28420	47370	<b>1485</b>	<b>1760</b>	13.5	1.54
<b>CGU 15-500</b>	500	387	180	177	1546	<b>138.6</b>	33750	52570	<b>1740</b>	<b>1955</b>	13.8	1.54
<b>CGU 16-400</b>	400	336	169	158	1170	<b>123.9</b>	25270	31900	<b>1505</b>	<b>1465</b>	12.7	1.40
<b>CGU 18-400</b>	400	340	169	177	1187	<b>138.7</b>	29520	34560	<b>1735</b>	<b>1585</b>	12.9	1.40

\* The mass of welds is not taken into account

\*\* Outside surface, excluding inside of interlocks

# Product information

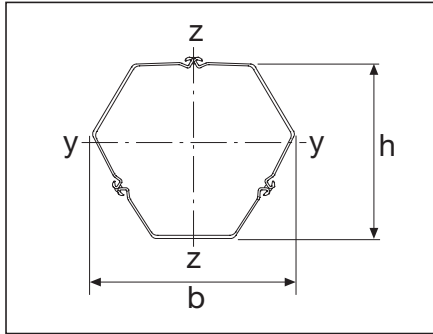

Table 1.16.2c Dimensions and properties of CAU, CU and CPU-R box piles

Section	b	h	Perim	Sectional Area	Total Section Area	Mass*	Moment of Inertia		Elastic section modulus		Min Rad of gyration	Coating **
							y-y	z-z	y-y	z-z		
	mm	mm	cm	cm <sup>2</sup>	cm <sup>2</sup>	kg/m	cm <sup>4</sup>	cm <sup>4</sup>	cm <sup>3</sup>	cm <sup>3</sup>	cm	m <sup>2</sup> /m
<b>CAU triple box piles</b>												
CAU 14 - 3	957	908	341	298	6454	233.7	300330		6510	6275	31.7	3.03
CAU 16 - 3	960	910	342	330	6486	258.7	333640		7235	6955	31.8	3.03
CAU 17 - 3	960	910	343	340	6496	267.2	344760		7475	7180	31.8	3.03
CAU 18 - 3	1009	927	355	338	6886	265.5	363690		7825	7205	32.8	3.17
CAU 20 - 3	1012	928	356	370	6919	290.7	399780		8570	7900	32.9	3.17
CAU 21 - 3	1013	929	359	381	6926	299.0	411460		8810	8125	32.9	3.17
CAU 23 - 3	1036	930	361	390	7073	306.3	431940		9235	8340	33.3	3.24
CAU 25 - 3	1038	931	364	422	7106	331.3	469030		9995	9035	33.3	3.24
CAU 26 - 3	1039	932	364	433	7115	339.6	481240		10245	9260	33.3	3.24
<b>CU triple box piles</b>												
CU 12 - 3	800	755	293	253	4431	198.3	173100		4555	4325	26.2	2.54
CU 12 10/10 - 3	800	755	293	266	4432	208.8	182100		4790	4555	26.2	2.54
CU 18 - 3	877	790	315	294	4931	230.7	227330		5475	5185	27.8	2.76
CU 22 - 3	912	801	326	329	5174	258.4	268440		6310	5890	28.6	2.87
CU 28 - 3	938	817	336	389	5356	305.4	330290		7720	7040	29.1	2.96
CU 32 - 3	926	809	331	436	5345	342.4	367400		8585	7935	29.0	2.92
<b>CPU-R triple box piles</b>												
CPU 8R-3	757	709	278	186	3983	146.0	116000		3120	3065	25.0	2.40
CPU 9R-3	815	750	295	189	4492	148.4	131850		3490	3235	26.4	2.57
CPU 10R-3	815	750	295	206	4492	161.4	143590		3800	3525	26.4	2.57
CPU 11R-3	815	750	295	222	4492	174.4	155280		4110	3810	26.4	2.57
CPU 13R-3	888	836	319	251	5483	196.9	214670		5110	4835	29.3	2.81
CPU 14R-3	888	836	319	269	5483	211.5	230660		5490	5195	29.3	2.81
CPU 15R-3	888	836	319	288	5483	226.2	246580		5870	5555	29.3	2.81

\* The mass of welds is not taken into account

\*\* Outside surface, excluding inside of interlocks

# Product information

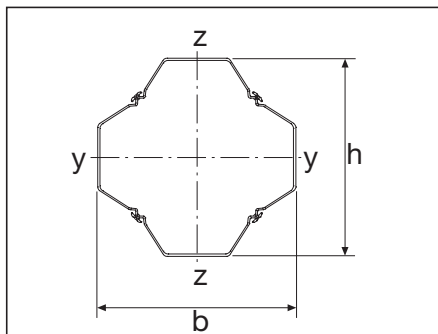

Table 1.16.2d Dimensions and properties of CAU, CU and CPU-R box piles

Section	b	h	Perim	Sectional Area	Total Section Area	Mass*	Moment of inertia		Elastic section modulus		Min. radius of gyration	Coating area**
							y-y cm <sup>4</sup>	z-z cm <sup>4</sup>	y-y cm <sup>3</sup>	z-z cm <sup>3</sup>		
	mm	mm	cm	cm <sup>2</sup>	cm <sup>2</sup>	kg/m					cm	m <sup>2</sup> /m
<b>CAU quadruple box piles</b>												
CAU 14 - 4	1222	1222	453	397	11150	<b>311.6</b>	692030		<b>11325</b>		41.7	4.02
CAU 16 - 4	1225	1225	454	440	11193	<b>345.0</b>	770370		<b>12575</b>		41.8	4.02
CAU 17 - 4	1226	1226	454	454	11206	<b>356.2</b>	796520		<b>12990</b>		41.9	4.02
CAU 18 - 4	1258	1258	471	451	11728	<b>354.0</b>	826550		<b>13140</b>		42.8	4.20
CAU 20 - 4	1261	1261	472	494	11771	<b>387.6</b>	910010		<b>14430</b>		42.9	4.20
CAU 21 - 4	1262	1262	473	508	11783	<b>398.6</b>	937100		<b>14855</b>		43.0	4.20
CAU 23 - 4	1263	1263	481	520	11977	<b>408.4</b>	979870		<b>15510</b>		43.4	4.30
CAU 25 - 4	1266	1266	482	563	12020	<b>441.6</b>	1064910		<b>16820</b>		43.5	4.30
CAU 26 - 4	1267	1267	483	577	12033	<b>452.8</b>	1093300		<b>17250</b>		43.5	4.30
<b>CU quadruple box piles</b>												
CU 12 - 4	1025	1025	388	337	7565	<b>264.4</b>	394000		<b>7690</b>		34.2	3.36
CU 12 10/10 - 4	1025	1025	388	355	7565	<b>278.4</b>	414830		<b>8095</b>		34.2	3.36
CU 18 - 4	1095	1095	417	392	8231	<b>307.6</b>	507240		<b>9270</b>		36.0	3.65
CU 22 - 4	1115	1115	432	439	8556	<b>344.6</b>	593030		<b>10635</b>		36.8	3.80
CU 28 - 4	1120	1120	445	519	8799	<b>407.2</b>	725730		<b>12955</b>		37.4	3.93
CU 32 - 4	1120	1120	440	582	8782	<b>456.6</b>	811100		<b>14480</b>		37.3	3.87
<b>CPU-R quadruple box piles</b>												
CPU 8R-4	938	938	369	248	6958	<b>194.7</b>	268400		<b>5725</b>		32.9	3.18
CPU 9R-4	1019	1019	391	252	7637	<b>197.9</b>	297710		<b>5840</b>		34.4	3.41
CPU 10R-4	1019	1019	391	274	7637	<b>215.2</b>	325130		<b>6380</b>		34.4	3.41
CPU 11R-4	1019	1019	391	296	7637	<b>232.5</b>	352430		<b>6915</b>		34.5	3.41
CPU 13R-4	1136	1136	423	334	9376	<b>262.5</b>	490480		<b>8640</b>		38.3	3.70
CPU 14R-4	1136	1136	423	359	9376	<b>282.1</b>	528080		<b>9300</b>		38.3	3.70
CPU 15R-4	1136	1136	423	384	9376	<b>301.6</b>	565540		<b>9960</b>		38.4	3.70

\* The mass of welds is not taken into account

\*\* Outside surface, excluding inside of interlocks

# Product information

## 1.16.3 Special arrangements - CAZ + AZ combinations

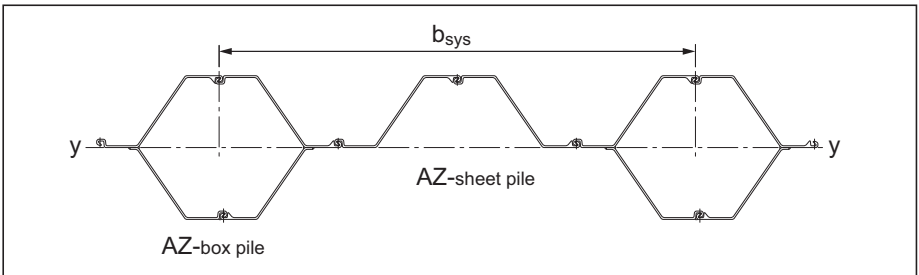

Table 1.16.3

Section	Dimension	Mass <sub>100</sub>	Mass <sub>60</sub>	Moment of inertia	Elastic section modulus
	$b_{sys}$ mm	kg/m <sup>2</sup>	kg/m <sup>2</sup>	$I_{svs/m}$ cm <sup>4</sup> /m	$W_{svs/m}$ cm <sup>3</sup> /m
<b>CAZ 13 / AZ 13</b>	2680	<b>147</b>	<b>126</b>	60910	<b>2000</b>
<b>CAZ 18 / AZ 13</b>	2600	<b>156</b>	<b>134</b>	95900	<b>2510</b>
<b>CAZ 18 / AZ 18</b>	2520	<b>163</b>	<b>139</b>	105560	<b>2765</b>
<b>CAZ 26 / AZ 13</b>	2600	<b>188</b>	<b>166</b>	151240	<b>3530</b>
<b>CAZ 26 / AZ 18</b>	2520	<b>196</b>	<b>173</b>	162660	<b>3795</b>
<b>CAZ 48 / AZ 13</b>	2500	<b>255</b>	<b>232</b>	283040	<b>5850</b>
<b>CAZ 48 / AZ 18</b>	2420	<b>265</b>	<b>241</b>	299290	<b>6190</b>
<b>CAZ 13-770 / AZ 13-7</b>	3080	<b>137</b>	<b>117</b>	70740	<b>2045</b>
<b>CAZ 18-700 / AZ 13-7</b>	2940	<b>144</b>	<b>124</b>	106220	<b>2530</b>
<b>CAZ 18-700 / AZ 18-7</b>	2800	<b>152</b>	<b>130</b>	118130	<b>2800</b>
<b>CAZ 26-700 / AZ 13-7</b>	2940	<b>177</b>	<b>156</b>	162840	<b>3530</b>
<b>CAZ 26-700 / AZ 18-7</b>	2800	<b>186</b>	<b>164</b>	177580	<b>3845</b>
<b>CAZ 39-700 / AZ 13-7</b>	2940	<b>210</b>	<b>189</b>	247340	<b>4930</b>
<b>CAZ 39-700 / AZ 18-7</b>	2800	<b>221</b>	<b>199</b>	266300	<b>5305</b>

Mass<sub>100</sub>  $L_{AZ} = 100\% L_{box\ pile}$

Mass<sub>60</sub>  $L_{AZ} = 60\% L_{box\ pile}$

# Product information

## 1.16.4 Combined walls with U-type sections

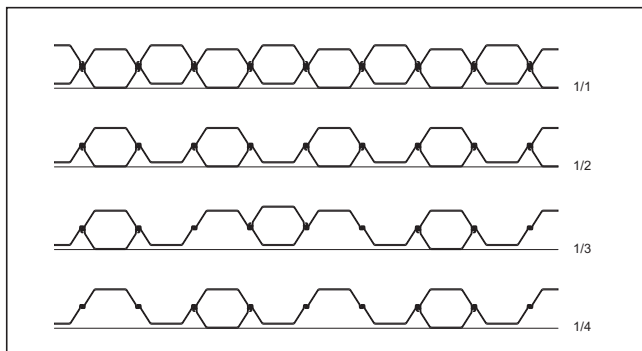

Table 1.16.4

Section	1/1			1/2			1/3			1/4		
	Mass kg/m <sup>2</sup>	Moment of inertia cm <sup>4</sup> /m	Elastic section modulus cm <sup>3</sup> /m	Mass kg/m <sup>2</sup>	Moment of inertia cm <sup>4</sup> /m	Elastic section modulus cm <sup>3</sup> /m	Mass kg/m <sup>2</sup>	Moment of inertia cm <sup>4</sup> /m	Elastic section modulus cm <sup>3</sup> /m	Mass kg/m <sup>2</sup>	Moment of inertia cm <sup>4</sup> /m	Elastic section modulus cm <sup>3</sup> /m
<b>AU box piles / AU sheet piles</b>												
AU 14	208	72530	3220	156	40660	1805	139	43300	1920	130	37980	1550
AU 16	230	82990	3660	173	46230	2035	153	49560	2185	144	43440	1755
AU 17	238	86450	3805	178	48070	2115	158	51660	2275	148	45270	1820
AU 18	236	98360	4045	177	55020	2260	157	58990	2425	148	51760	1950
AU 20	258	111160	4545	194	61830	2525	172	66680	2725	162	58460	2180
AU 21	266	115390	4705	199	64080	2615	177	69250	2825	166	60700	2255
AU 23	272	126050	5125	204	69580	2830	182	75820	3080	170	66410	2435
AU 25	294	139750	5645	221	76800	3105	196	84080	3395	184	73590	2675
AU 26	302	144350	5820	226	79230	3195	201	86880	3505	189	76020	2755
<b>PU box piles / PU sheet piles</b>												
PU 12	220	56670	2810	165	32080	1590	147	33290	1650	138	29190	1370
PU 12 10/1	232	59300	2945	174	33480	1660	155	34820	1730	145	30520	1430
PU 18	256	96700	4090	192	54370	2300	171	58000	2450	160	50940	1980
PU 22	287	122900	4975	215	68730	2785	192	73940	2995	180	64920	2395
PU 28	339	160000	6415	255	88390	3545	226	96310	3860	212	84370	3050
PU 32	381	181330	7270	285	99790	4000	254	108660	4355	238	95070	3445
<b>PU-R box piles / PU-R sheet piles</b>												
PU 8R	162	28970	1825	122	16210	1020	108	16880	1065	101	14760	875
PU 9R	165	43080	2160	124	24460	1225	110	25650	1285	103	22550	1050
PU 10R	179	48210	2415	135	27190	1365	120	28710	1440	112	25210	1170
PU 11R	194	53280	2670	145	29880	1500	129	31730	1590	121	27830	1290
PU 13R	194	64560	2930	146	36270	1645	130	38650	1755	122	33930	1415
PU 14R	209	70390	3190	157	39360	1785	139	42130	1910	131	36960	1535
PU 15R	223	76150	3455	168	42410	1925	149	45570	2065	140	39950	1655

# Product information

## 1.16.4 Combined walls with U-type sections

Table 1.16.4 continued

Section	1/1			1/2			1/3			1/4		
	Mass kg/m <sup>2</sup>	Moment of inertia cm <sup>2</sup> /m	Elastic section modulus cm <sup>3</sup> /m	Mass kg/m <sup>2</sup>	Moment of inertia cm <sup>2</sup> /m	Elastic section modulus cm <sup>3</sup> /m	Mass kg/m <sup>2</sup>	Moment of inertia cm <sup>2</sup> /m	Elastic section modulus cm <sup>3</sup> /m	Mass kg/m <sup>2</sup>	Moment of inertia cm <sup>2</sup> /m	Elastic section modulus cm <sup>3</sup> /m
<b>GU box piles / GU sheet piles</b>												
<b>GU 7-600</b>	<b>157</b>	<b>30540</b>	<b>1745</b>	<b>117</b>	<b>17300</b>	<b>990</b>	<b>104</b>	<b>17750</b>	<b>1015</b>	<b>98</b>	<b>15540</b>	<b>850</b>
<b>GU 8-600</b>	<b>173</b>	<b>34600</b>	<b>1965</b>	<b>130</b>	<b>19520</b>	<b>1110</b>	<b>115</b>	<b>19990</b>	<b>1135</b>	<b>108</b>	<b>17480</b>	<b>955</b>
<b>GU 9-600</b>	<b>190</b>	<b>38880</b>	<b>2195</b>	<b>142</b>	<b>21850</b>	<b>1235</b>	<b>127</b>	<b>22340</b>	<b>1260</b>	<b>119</b>	<b>19500</b>	<b>1060</b>
<b>GU 12-500</b>	<b>227</b>	<b>51590</b>	<b>2705</b>	<b>170</b>	<b>29390</b>	<b>1540</b>	<b>151</b>	<b>30290</b>	<b>1590</b>	<b>142</b>	<b>26590</b>	<b>1325</b>
<b>GU 13-500</b>	<b>243</b>	<b>56830</b>	<b>2965</b>	<b>183</b>	<b>32290</b>	<b>1685</b>	<b>162</b>	<b>33200</b>	<b>1730</b>	<b>152</b>	<b>29110</b>	<b>1445</b>
<b>GU 15-500</b>	<b>277</b>	<b>67490</b>	<b>3485</b>	<b>208</b>	<b>38160</b>	<b>1970</b>	<b>185</b>	<b>39040</b>	<b>2015</b>	<b>173</b>	<b>34150</b>	<b>1695</b>
<b>GU 16-400</b>	<b>310</b>	<b>63180</b>	<b>3760</b>	<b>232</b>	<b>35270</b>	<b>2100</b>	<b>207</b>	<b>36110</b>	<b>2150</b>	<b>194</b>	<b>31460</b>	<b>1805</b>
<b>GU 18-400</b>	<b>347</b>	<b>73800</b>	<b>4340</b>	<b>260</b>	<b>41010</b>	<b>2410</b>	<b>231</b>	<b>41990</b>	<b>2470</b>	<b>217</b>	<b>36530</b>	<b>2075</b>

# Product information

## 1.16.5 Load bearing foundations

The development of rolled corner sections has enabled a new generation of bearing pile to be created. By interlocking a number of sheet piles with the same number of Omega bars a closed tube results which can be driven into the ground sequentially. Using equipment that installs piles without noise and vibration, the ability to drive a closed section pile by pile means that load bearing foundations made of steel can be installed at sensitive sites and in urban areas where impact driven piles would not be tolerated.

In addition to the reduction in environmental disturbance offered by this system, the foundation is effectively load tested as it is installed and can be loaded immediately. Furthermore, the opportunity exists to extract the piles once the useful life of the structure is passed in a reversal of the installation process.

Table 1.16.5 gives the dimensions and properties for foundations created using 4, 5 and 6 sheet pile/omega combinations and ultimate load capacities for both S270GP and S355GP steel grades. The capacity of the foundation in geotechnical terms will need to be assessed for the particular site location.

The effective radius of the pile (used for calculating torsional resistance) is the value given in the column headed 'Maximum boundary distance'.

Fig 1.16.5

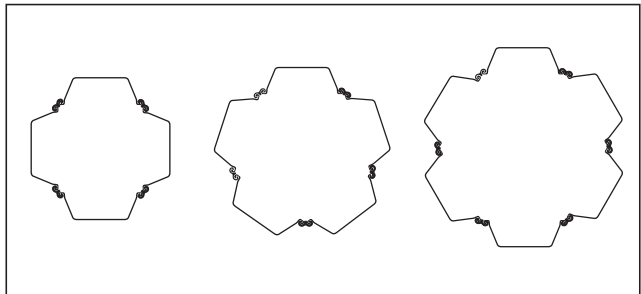



# Product information

Table 1.16.5 Dimensions and properties for foundations using sheet pile / omega combinations

Section		Steel area	Perimeter	Moment of inertia	Radius of gyration	Max boundary distance	Elastic section modulus	Ultimate axial capacity		Coating *
		cm <sup>2</sup>	mm	cm <sup>4</sup>	mm	mm	cm <sup>3</sup>	S270GP kN	S355GP kN	m <sup>2</sup>
<b>AU 16</b>	4	531.2	4750	970430	427	632.7	<b>15340</b>	14342	18858	4.50
	5	664.1	5950	1826530	524	784.5	<b>23285</b>	17931	23575	5.62
	6	796.8	7160	3062970	620	928.9	<b>32975</b>	21514	28287	6.75
<b>AU 20</b>	4	585.5	4920	1114760	436	649.6	<b>17160</b>	15809	20784	4.67
	5	731.8	6170	2083840	534	801.3	<b>26005</b>	19759	25981	5.84
	6	878.2	7410	3476950	629	945.7	<b>36765</b>	23711	31177	7.01
<b>AU 25</b>	4	654.3	5020	1278190	442	652.4	<b>19595</b>	17666	23226	4.77
	5	817.8	6290	2383790	540	804.1	<b>29645</b>	22081	29033	5.96
	6	981.4	7560	3968200	636	948.5	<b>41835</b>	26498	34840	7.15
<b>PU 12</b>	4	428.5	4090	525260	350	522.6	<b>10050</b>	11570	15213	3.84
	5	535.7	5130	983560	429	655.9	<b>14995</b>	14464	19016	4.80
	6	642.8	6170	1645660	506	773.6	<b>21275</b>	17356	22819	5.76
<b>PU 18</b>	4	483.6	4380	645550	365	567.4	<b>11380</b>	13057	17167	4.13
	5	604.5	5490	1194290	444	690.9	<b>17285</b>	16322	21458	5.16
	6	725.4	6600	1979340	522	808.6	<b>24480</b>	19586	25750	6.19
<b>PU 22</b>	4	530.7	4520	735850	372	577.4	<b>12745</b>	14329	18840	4.27
	5	663.4	5670	1353710	452	700.9	<b>19315</b>	17912	23552	5.34
	6	796.1	6820	2233930	530	818.6	<b>27290</b>	21495	28260	6.41
<b>PU 32</b>	4	673.4	4580	964470	378	578.4	<b>16675</b>	18182	23905	4.33
	5	841.8	5740	1771180	459	701.9	<b>25235</b>	22729	29883	5.41
	6	1,010.1	6900	2915900	537	819.6	<b>35575</b>	27273	35857	6.49
<b>PU 11R</b>	4	390.2	4150	486560	353	532.3	<b>9140</b>	10535	13851	3.90
	5	487.7	5170	908170	432	672.5	<b>13505</b>	13168	17314	4.84
	6	585.3	6180	1516130	509	773.6	<b>19600</b>	15802	20777	5.77
<b>PU 14R</b>	4	453.3	4460	696450	392	589.8	<b>11810</b>	12238	16091	4.21
	5	566.6	5560	1304470	480	740.5	<b>17615</b>	15298	20114	5.23
	6	679.9	6650	2181080	566	858.6	<b>25405</b>	18358	24137	6.24
<b>GU 13-500</b>	4	403.9	3810	373590	304	472.3	<b>7910</b>	10906	14340	3.56
	5	504.9	4740	693400	371	590.3	<b>11750</b>	13633	17924	4.41
	6	605.9	5680	1153520	436	677.0	<b>17040</b>	16359	21509	5.27
<b>GU 16-400</b>	4	409.7	3520	271530	257	397.3	<b>6835</b>	11061	14544	3.27
	5	512.1	4380	499730	312	501.3	<b>9970</b>	13827	18179	4.05
	6	614.5	5240	826250	367	565.4	<b>14615</b>	16592	21815	4.83

\* = one side, excluding inside of interlocks

## Product information

**1.16.6 Jagged walls** Jagged walls may be formed by threading AZ piles together in the reverse direction as illustrated below.

This arrangement results in a very wide system which is particularly efficient for the creation of walls such as contamination barriers where section strength is not the main criterion for pile selection, but water-tightness and reduced costs for sealing are.

Fig 1.16.6a AZ Jagged wall

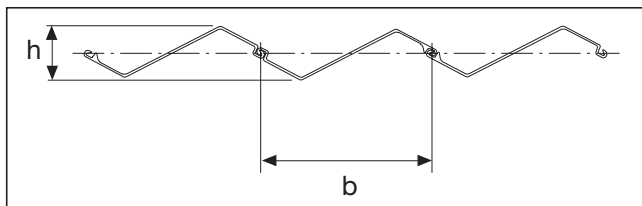

Table 1.16.6a AZ Jagged wall

Section	Dimensions		Sectional area cm <sup>2</sup> /m	Mass kg/m <sup>2</sup>	Moment of inertia cm <sup>4</sup> /m	Elastic section modulus cm <sup>3</sup> /m	Coating area* m <sup>2</sup> /m <sup>2</sup>
	b mm	h mm					
AZ 12	718	185	117	<b>92.1</b>	2540	<b>275</b>	1.14
AZ 13	718	186	128	<b>100.3</b>	2840	<b>305</b>	1.14
AZ 14	718	187	139	<b>109.1</b>	3130	<b>335</b>	1.14
AZ 17	714	223	122	<b>95.8</b>	3840	<b>345</b>	1.19
AZ 18	714	225	133	<b>104.2</b>	4280	<b>380</b>	1.19
AZ 19	714	226	144	<b>113.4</b>	4720	<b>420</b>	1.19
AZ 25	736	237	158	<b>124.3</b>	6070	<b>515</b>	1.21
AZ 26	736	238	169	<b>132.9</b>	6590	<b>555</b>	1.21
AZ 28	736	239	181	<b>141.8</b>	7110	<b>595</b>	1.21
AZ 46	725	308	233	<b>182.9</b>	16550	<b>1,070</b>	1.30
AZ 48	725	310	245	<b>192.6</b>	17450	<b>1,125</b>	1.30
AZ 50	725	312	258	<b>202.3</b>	18370	<b>1,180</b>	1.30
AZ 13 10/10	718	187	133	<b>104.7</b>	2980	<b>320</b>	1.14
AZ 18 10/10	714	225	139	<b>109.0</b>	4500	<b>400</b>	1.19
AZ 12-770	826	181	112	<b>87.9</b>	2330	<b>255</b>	1.12
AZ 13-770	826	182	117	<b>92.1</b>	2460	<b>270</b>	1.12
AZ 14-770	826	182	123	<b>96.2</b>	2600	<b>285</b>	1.12
AZ 14-770 10-10	826	183	128	<b>100.4</b>	2730	<b>300</b>	1.12
AZ 17-700	795	212	117	<b>92.0</b>	3690	<b>330</b>	1.16
AZ 18-700	795	212	123	<b>96.2</b>	3910	<b>350</b>	1.16
AZ 19-700	795	213	128	<b>101.0</b>	4120	<b>365</b>	1.16
AZ 20-700	795	214	134	<b>105.0</b>	4330	<b>385</b>	1.16
AZ 24-700	813	241	150	<b>117.7</b>	5970	<b>495</b>	1.19
AZ 26-700	813	242	161	<b>126.6</b>	6500	<b>535</b>	1.19
AZ 28-700	813	243	172	<b>135.4</b>	7030	<b>580</b>	1.19
AZ 37-700	834	287	190	<b>149.0</b>	11600	<b>810</b>	1.22
AZ 39-700	834	288	201	<b>158.2</b>	12390	<b>860</b>	1.22
AZ 41-700	834	289	213	<b>167.4</b>	13170	<b>910</b>	1.22

\* One side, excluding inside of interlocks.

## Product information

It is also possible to arrange pairs of U piles to form a jagged wall by connecting them together with Omega 18 special connectors. In this arrangement, the pile pairs are orientated at  $90^\circ$  to each other creating a deep wall with very high inertia and section modulus. The choice of section for this type of wall must include driveability criteria and the designer must ensure that the sections are crimped or welded together in order to guarantee the shear force transfer across the interlock on the neutral axis. Omega 18 connectors must also be welded if their contribution is taken into account during design.

Fig 1.16.6b U Jagged wall

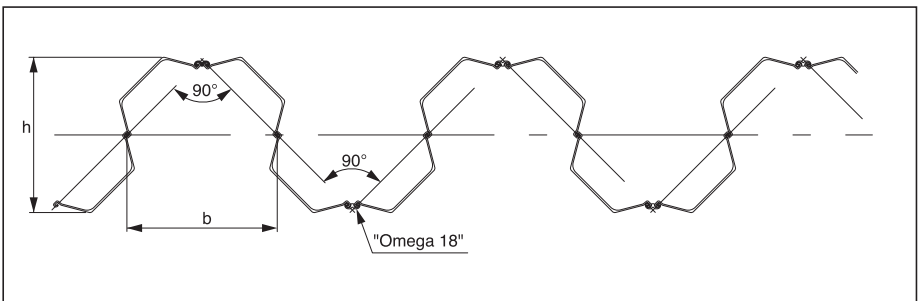

### 1.17 Cold formed sheet piles

Cold formed sheet piles increase the range of sections available to designers particularly at the lower end of the section modulus range. Manufactured in accordance with European standards, cold formed sections are complementary to the range of hot rolled sheet piles.

Cold formed sheet piles are normally used in the structural protection of river banks from erosion and collapse. They are recommended for retaining walls of medium height and are particularly effective as containment walls at polluted sites.

# Product information

## 1.17.1 PAL and PAU sections

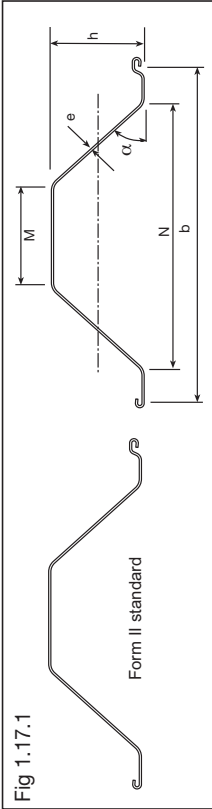

Table 1.17.1

Type	Thickness mm	System width mm	Height h mm	Angle $\alpha$ °	Other dimensions			Mass wall kg/m <sup>2</sup>	Section modulus elastic cm <sup>3</sup> /m	Inertia I cm <sup>4</sup> /m	Radius of gyration cm	Cross area cm <sup>2</sup> /m	Coating area (*) single SSP m <sup>2</sup> /m
	e	b			M	N	single pile kg/m						
PAL3030	3.00	660	89.0	41	260	466	19.4	29.4	112	500	3.70	37.5	0.80
PAL3040	4.00	660	90.0	41	260	466	25.8	39.2	147	686	3.70	49.9	0.80
PAL3050	5.00	660	91.0	41	260	466	32.2	48.8	181	831	3.70	62.2	0.80
PAL3130	3.00	711	125.0	79	350	419	23.5	33.1	199	1244	5.40	42.2	0.97
PAL3140	4.00	711	126.0	79	350	419	31.3	44.0	261	1655	5.40	56.1	0.97
PAL3150	5.00	711	127.0	79	350	419	39.0	54.9	322	2063	5.40	70.0	0.97
PAL3260	6.00	700	149.0	61	299	471	46.2	66.0	413	3096	6.10	84.1	0.92
PAL3270	7.00	700	150.0	61	299	471	53.2	76.0	479	3604	6.10	96.8	0.92
PAL3280	8.00	700	151.0	61	299	471	61.6	88.0	545	4109	6.10	112.1	0.92
PAL3290	9.00	700	152.0	61	299	471	70.0	100.0	605	4611	6.00	127.4	0.92
PAU2240	4.00	922	252.0	48	252	725	39.0	42.3	404	5101	9.70	53.9	1.22
PAU2250	5.00	921	253.0	48	252	725	48.7	52.8	504	6363	9.70	67.3	1.22
PAU2260	6.00	921	254.0	48	252	725	58.3	63.3	600	7620	9.70	80.7	1.22
PAU2440	4.00	813	293.0	60	252	615	39.0	48.0	537	7897	11.40	61.1	1.22
PAU2450	5.00	813	294.0	60	252	615	48.7	59.9	669	9858	11.40	76.3	1.22
PAU2460	6.00	813	295.0	60	252	615	58.3	71.8	801	11813	11.40	91.4	1.22
PAU2760	6.00	804	295.0	60	252	615	60.4	75.1	803	12059	11.20	95.7	1.16
PAU2770	7.00	804	296.0	60	252	615	70.4	87.5	934	14030	11.20	111.4	1.16
PAU2780	8.00	804	297.0	60	252	615	80.3	99.8	1063	15995	11.20	127.1	1.16

Other thicknesses in the PAL and PAU series can be formed. (\* ) 1 side, excluding inside of interlocks

# Product information

## 1.17.2 PAZ sections

Fig 1.17.2

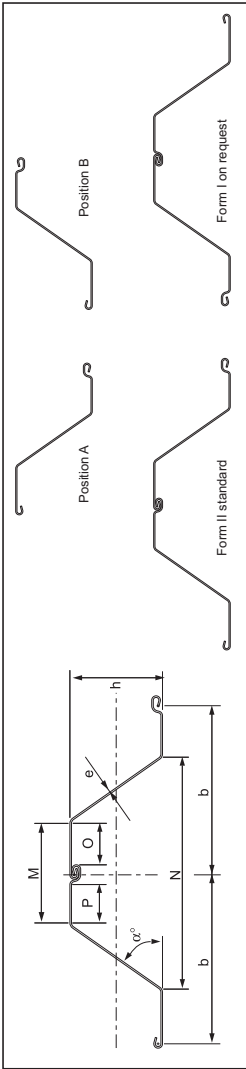

Type	Thickness mm	System width mm	Height mm	Angle °	Other dimensions	Mass single pile kg/m	Section modulus elastic cm <sup>3</sup> /m	Per m of wall Inertia I of gyration cm <sup>4</sup>	Cross section area cm <sup>2</sup>	Coating area (*) single SSP m <sup>2</sup> /m					
	e	b	h	α	M	N	O	P							
	mm	mm	mm	°	mm	mm	mm	mm							
PAZ4350	5.00	770	213.0	34	465	1078	208	182	38.2	49.6	448	4770	8.7	63.2	0.91
PAZ4360	6.00	770	214.0	34	465	1078	208	182	45.8	59.4	534	5720	8.7	75.7	0.91
PAZ4370	7.00	770	215.0	34	465	1078	208	182	53.3	69.2	619	6660	8.7	88.2	0.91
PAZ4450	5.00	725	269.0	45	444	988	203	177	37.7	52.0	612	8240	11.2	66.2	0.91
PAZ4460	6.00	725	270.0	45	444	988	203	177	45.1	62.2	730	9890	11.2	79.3	0.91
PAZ4470	7.00	725	271.0	45	444	988	203	177	52.4	72.3	846	11535	11.2	92.1	0.91
PAZ4550	5.00	676	312.0	55	444	890	203	177	37.7	55.8	772	12065	13	71.0	0.91
PAZ4560	6.00	676	313.0	55	444	890	203	177	45.1	66.7	922	14444	13	85.0	0.91
PAZ4570	7.00	676	314.0	55	444	890	203	177	52.4	77.5	1069	16815	13	98.8	0.91
PAZ4650	5.00	621	347.0	65	438	778	203	177	37.7	60.7	940	16318	14.5	77.3	0.91
PAZ4660	6.00	621	348.0	65	438	778	203	177	45.1	72.6	1122	19544	14.5	92.5	0.91
PAZ4670	7.00	621	349.0	65	438	778	203	177	52.4	84.4	1302	22756	14.5	107.5	0.91

Other section and thickness PAZ's can be formed. (\*) 1 side, excluding inside of interlocks

# Product information

## 1.17.2 PAZ sections continued

Fig 1.17.2

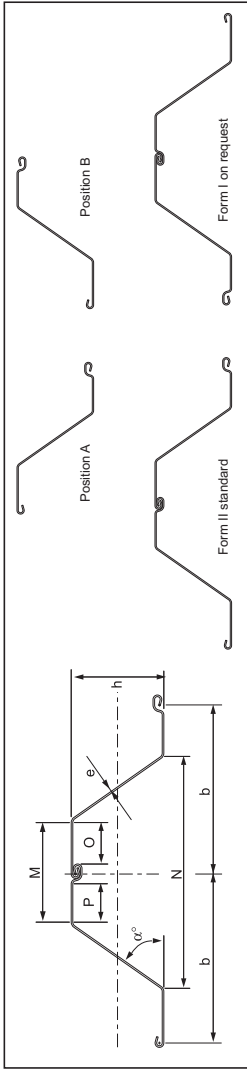

Type	Thickness e mm	System width b mm	Height h mm	Angle $\alpha^c$ °	M mm	N mm	O mm	P mm	Other dimensions	Mass single pile kg/m	Section modulus elastic cm <sup>3</sup> /m	Per m of wall Inertia I cm <sup>4</sup>	Radius of gyration cm	Cross section area cm <sup>2</sup>	Coating area (*) single SSP m <sup>2</sup> /m
PAZ5360	6.00	857	300.0	37	453	1245	192	173	54.3	63.3	766	11502	11.9	80.7	1.04
PAZ5370	7.00	857	301.0	37	453	1245	192	173	63.2	73.7	888	13376	11.9	93.9	1.04
PAZ5380	8.00	857	302.0	37	453	1245	192	173	72.1	84.0	1009	15249	11.9	107.1	1.04
PAZ5390	9.00	857	303.0	37	453	1245	192	173	81.0	94.4	1131	17123	11.9	120.3	1.04
PAZ5460	6.00	807	351.0	45	442	1149	180	167	53.9	66.8	968	16989	14.1	85.1	1.04
PAZ5470	7.00	807	352.0	45	442	1149	180	167	62.6	77.6	1123	19774	14.1	98.9	1.04
PAZ5480	8.00	807	353.0	45	442	1149	180	167	71.4	88.4	1277	22546	14.1	112.7	1.04
PAZ5490	9.00	807	354.0	45	442	1149	180	167	80.2	99.3	1431	25318	14.1	126.5	1.04
PAZ5560	6.00	743	407.0	55	438	1020	180	167	53.9	72.5	1233	25074	16.5	92.4	1.04
PAZ5570	7.00	743	408.0	55	438	1020	180	167	62.6	84.3	1432	29179	16.5	107.4	1.04
PAZ5580	8.00	744	409.0	55	438	1020	180	167	71.4	96.0	1628	33263	16.5	122.3	1.04
PAZ5590	9.00	744	410.0	55	438	1020	180	167	80.2	107.8	1825	37387	16.5	137.3	1.04
PAZ5660	6.00	671	451.0	65	434	875	180	167	53.9	80.3	1525	34340	18.3	102.3	1.04
PAZ5670	7.00	671	452.0	65	434	874	180	167	62.6	93.3	1770	39954	18.3	118.9	1.04
PAZ5680	8.00	672	453.0	65	434	874	180	167	71.4	106.3	2013	45537	18.3	135.4	1.04
PAZ5690	9.00	672	454.0	65	434	874	180	167	80.2	119.3	2259	51180	18.4	151.9	1.04

Other section and thickness PAZ's can be formed. (\*) 1 side, excluding inside of interlocks

# Product information

## 1.17.3 Trench sheet sections

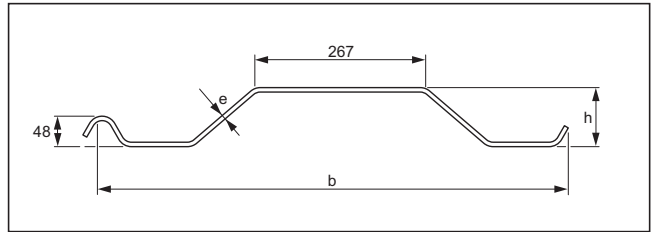

Table 1.17.3

Type	Thickness e mm	System width b mm	Height h mm	Mass single pile kg/m	Mass wall kg/m <sup>2</sup>	Section modulus elastic cm <sup>3</sup> /m	Inertia cm <sup>4</sup> /m	Radius of gyration cm	Cross section area cm <sup>2</sup> /m	Coating area(*) single SSP m <sup>2</sup> /m
<b>RC 8 600</b>	6.0	742	92.0	40.9	55.1	<b>194</b>	896	3.6	70.2	0.87
<b>RC 8 700</b>	7.0	742	93.0	47.6	64.2	<b>224</b>	1045	3.6	81.8	0.87
<b>RC 8 800</b>	8.0	742	94.0	54.2	73.0	<b>254</b>	1194	3.6	93.0	0.87

(\*) 1 side, excluding inside of interlocks

## 1.17.4 Threading options

PAZ sheet piles are usually delivered threaded in pairs and welded at regular intervals using 100 mm runs of weld, the amount is dependent on the length of the sheet piles.

Table 1.17.4

Series	PAL			PAU			PAZ		
	30	31	32	22	24	27	44	54	55
PAL	30	X	X						
PAL	31	X	X						
PAL	32			X		X			
PAU	22			X	X				
PAU	24			X	X				
PAU	27			X		X		X	X
PAZ	44						X		
PAZ	54					X		X	X
PAZ	55					X		X	X

# Product information

## 1.17.5 Sheet pile assembly

Fig 1.17.5

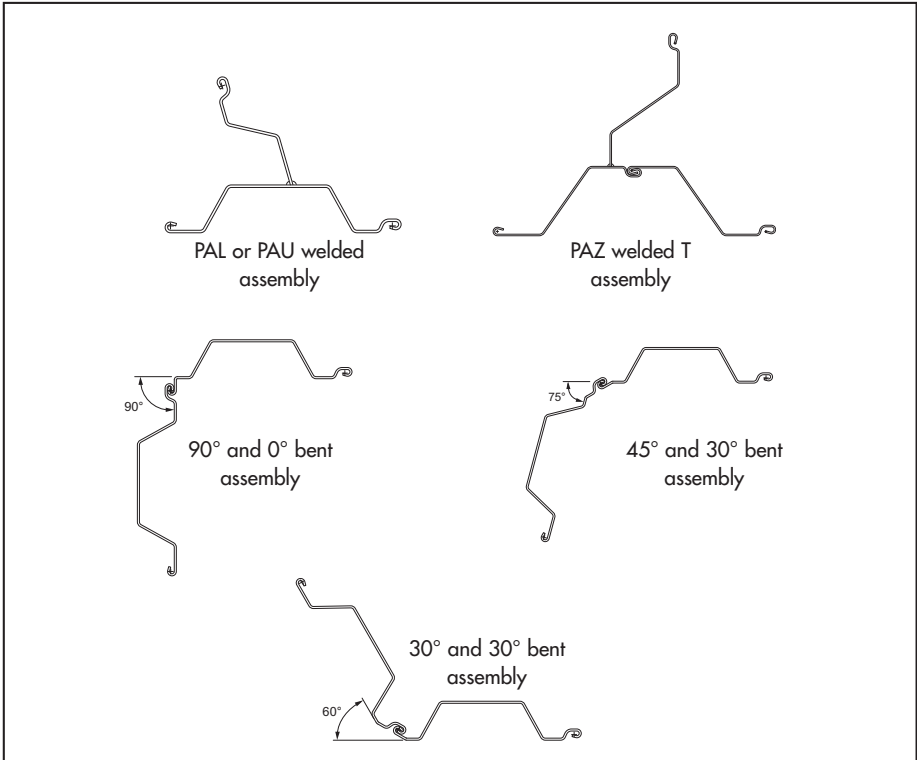



# Product information

## 1.17.6 Thickness

Maximum allowable thickness per type of sheet pile and grade of steel

Table 1.17.6

Series		Grade of steel		
		S 235 JRC	S 275 JRC	S 355 JOC
PAL	30	5.0	5.0	4.5
PAL	31	5.0	5.0	4.5
PAL	32	9.0	9.0	7.0
PAU	22	6.0	6.0	5.0
PAU	24	6.0	6.0	5.0
PAU	27	8.0	8.0	6.5
PAZ	44	7.0	7.0	6.0
PAZ	54	9.0	9.0	7.5
PAZ	55	9.0	9.0	7.5
RC	8000	10.0	10.0	10.0

## 1.17.7 Handling holes

Table 1.17.7

The sheet pile sections can be provided with the following standard handling holes

PAL 30-31	Ø = 40 mm	Y = 150 mm
PAL 32	Ø = 45 mm	Y = 150 mm
PAU	Ø = 45 mm	Y = 200 mm
PAZ	Ø = 50 mm	Y = 200 mm

Other dimension on request

Fig 1.17.7

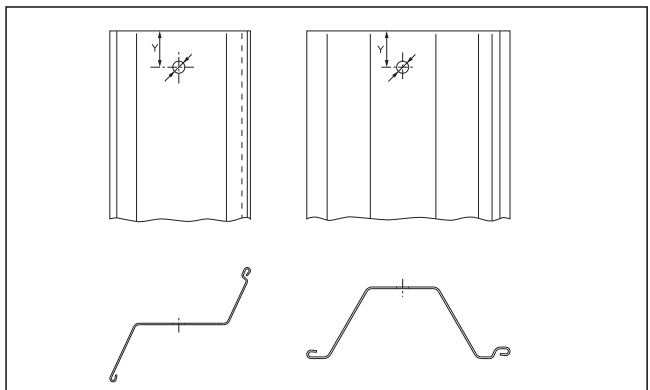

# Product information

## 1.17.8 Tolerances in accordance with EN 10249 Part 2.

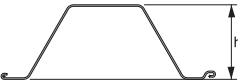
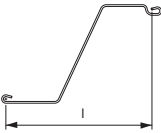
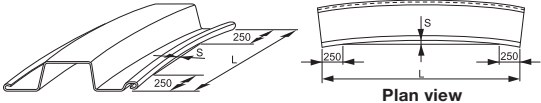
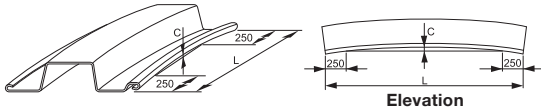
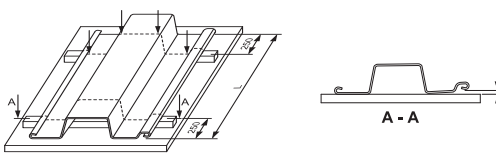
Characteristics	Figures	Nominal size (in mm)	Tolerances (in mm)
SECTIONAL DEPTH depth h		$h \leq 200$ $200 < h \leq 300$ $300 < h \leq 400$ $400 < h$	$\pm 4$ $\pm 6$ $\pm 8$ $\pm 10$
SECTIONAL WIDTH width l		single sheet piles double sheet piles	$\pm 2\% l$ $\pm 3\% l$
SECTIONAL THICKNESS Section thickness tolerance is as specified in Table 3 of EN 10051 for a nominal width of steel strip or sheet of 1800 mm.		$e = 3,00$ $3,00 \leq e \leq 4,00$ $4,00 < e \leq 5,00$ $5,00 < e \leq 6,00$ $6,00 < e \leq 8,00$ $8,00 < e \leq 10,00$	$\pm 0,26$ $\pm 0,27$ $\pm 0,29$ $\pm 0,31$ $\pm 0,35$ $\pm 0,40$
BENDING Deflection (S)			$0,25\% L$
CURVING Deflection (C)			$0,25\% L$
TWIST Dimension (V)			$2\% L$ with 100 mm max
LENGTH			$\pm 50$
SQUARENESS OF ENDS Out-of-squareness (t) of end cuts:			$2\%$ of width
MASS OF SECTIONS Difference between total actual and total theoretical mass delivered:			$\pm 7\%$



ArcelorMittal

- 1** Product information
- 2** Sealants
- 3** Durability
- 4** Earth and water pressure
- 5** Design of sheet pile structures
- 6** Retaining walls
- 7** Cofferdams
- 8** Charts for retaining walls
- 9** Circular cell construction design & installation
- 10** Bearing piles and axially loaded sheet piles
- 11** Installation of sheet piles
- 12** Noise and vibration from piling operations
- 13** Useful information

# Sealants

## Contents

	Page
2.1 Introduction	1
2.2 Basements	1
2.3 Containment barriers	2
2.4 Demountable foundations	2
2.5 Site or factory application	3
2.6 How the sealants work	3
2.7 Installation techniques	4
2.8 Location of the sealants	5
2.9 Chemical durability	6
2.10 Permeability	6
2.11 Welding	7
2.12 Horizontal sealing	9

# Sealants



# Sealants

## 2.1 Introduction

The ability of retaining walls to prevent or restrict the passage of ground water is of great importance in many applications e.g. in basements, underground tanks, temporary cofferdams and containment barriers.

A sealed sheet pile wall provides a safe, economic solution in any situation where control of groundwater, to minimise the risk of settlement of adjacent property and keeping excavations dry, is an issue. The water-tightness of sheet pile interlocks almost invariably improves with time but a sealant will provide a means by which the flow/passage of water can be controlled immediately.

All construction projects are unique with ground conditions and installation methods varying from site to site; therefore the sealant system adopted must be designed accordingly.

The integrity of a sealant system in use will depend upon its suitability with respect to the method of pile installation adopted and the ground conditions. Sealants are available to make driving easier and systems are also available to protect the sealants when driving the piles into gravels and difficult ground.

---

## 2.2 Basements

The use of permanent sheet piling for the walls of basement structures has, until recently, been considered on relatively few occasions partly because the interlocks were assumed to be a potential leakage point. If a steel basement was built, the interlocks would be seal welded following installation to give a fully watertight wall. With narrow piles this would involve a substantial amount of welding on site but following development of wider piles, the amount of sealing to be carried out reduced considerably making sealed basement walls a much more attractive option. The development of new forms of sealant and improved installation techniques means that sealed substructures can now be created using non-welded piles.

The table below is extracted from BS 8102:1990, 'The protection of structures against water from the ground' and indicates the performance level required for the range of possible basement grades. These are all achievable using steel sheet pile walls and appropriate interlock sealants or sealing systems.

# Sealants

Table 2.2 Extract from BS 8102 indicating basement performance levels

Basement grade	Basement usage	Performance level
1	Car parking; plant rooms (excluding electrical equipment); workshops	Some seepage and damp patches tolerable
2	Workshops & plant rooms requiring drier environment; retail storage areas	No water penetration but moisture vapour tolerable
3	Ventilated residential & working areas including offices, restaurants etc.; leisure centres	Dry environment
4	Archives and stores requiring controlled environment	Totally dry environment

## 2.3 Containment Barriers

Sealed sheet pile cut off walls can be used to prevent leachate from contaminated ground or refuse and disposal sites leaking beyond the boundaries of the site.

Traditionally these barriers to horizontal movement of liquids have been made using clay bunds or cement bentonite walls. These traditional methods take up large areas of ground, are generally formed away from the edge of the site and are prone to leakage. It should be noted that concrete and slurry wall systems are porous in the long term and, as they are both relatively brittle materials, their ability to retain water will diminish if cracks appear as a result of movement or exposure to loading fluctuations.

Sheet pile barriers offer a sealed solution on a much smaller footprint and the barrier can be placed at the site boundaries to maximise the ground area contained. Sheet piles used in basements or as the foundations at the perimeter of a building can also be sealed to prevent gases and leachate from redeveloped brown field sites from entering the building.

Steel sheet piles can also be removed at a later date and reused or recycled.

## 2.4 Demountable foundations

With the rapidly changing use of buildings and structures, designers are required to take into consideration the demolition and removal of the building at the end of its life. For a truly sustainable design, this requirement should also include the foundations.

# Sealants

All steel pile foundations and retaining systems, including most sealed pile walls, can be extracted and either reused or recycled. This has the advantage that the site will be free of obstructions and in a much better state to be redeveloped and is therefore less likely to lose value in the long term.

---

## 2.5 Site or factory application

It has been shown by performance testing the various sealant products that best results are obtained by thoroughly preparing the interlocks prior to the application of the sealant. This has the effect of removing any mill scale or other deleterious materials from the interlock and producing a steel surface that the sealant can properly adhere to. Not only is it difficult to clean and prepare the interlocks to the required standard on the construction site but weather conditions, temperature and humidity or the presence of surface moisture may be detrimental to the bond between the sealant and the steel. Interlock preparation to new piles will ensure good adhesion of the sealant to the steel, reducing the risk of damage when driving the piles and loss of performance in service.

Once they have cured, most sealant products are inert and therefore a non-hazardous but handling the constituents requires care as this operation introduces the possibility of exposure to potentially hazardous substances and may involve working with hot fluids. By applying sealants in the workshop, rather than on a construction site, the handling of these materials can be controlled by stringent safety standards. The work is confined to experienced personnel operating in a controlled environment and third parties are not subjected to unnecessary risk.

Once the sealants have cured, the safety risks reduce dramatically so it is possible to carry out a risk assessment for sealant application in the workshop that is complete as the operation is carried out in a fixed and controlled environment. This does not occur on the construction site where conditions will vary with location.

---

## 2.6 How the sealants work

Sealant systems are designed to stop water penetrating the interlocking joints in sheet pile walls and consequently the actual performance of a sealant system will be a function of the interlock geometry and amount of sealant applied by different suppliers.

Sealants can generally be said to operate in two ways; those that create a compression seal between adjacent parts of the interlock and those that displace to fill the voids. Compression sealants will



# Sealants

generally resist greater water pressures than displacement sealants but as indicated above, preparation of the steel surface is essential to performance.

The sealants that are soft in texture when applied to the interlock will generally perform as displacement seals when piles are interlocked together as the material can be squeezed into the voids in the interlocks preventing water flow. However these sealants are usually supplied unprotected and performance can be affected when driving in gravelly soil or by jetting.

Sealants that are firmer in texture will tend to be squashed during installation and form a compression seal when piles are interlocked together. They are generally more durable than displacement sealants from both the design and installation points of view. Hydrophilic compression sealants can also be supplied which have a relatively low volume during the installation phase of a project but swell up following contact with water to fill the voids in the interlocks. The swelling action can occur if the sealant is wetted accidentally by spraying or in heavy rain but a protected form of hydrophilic sealant is available to overcome these issues.

In addition to the materials that are applied before driving, it is also possible to seal weld the interlocks after installation. Further information is given in 2.11.

---

## 2.7 Installation techniques

One of the best ways to minimise the risk of water ingress through a sheet pile wall is to reduce the number of interlocks. This can be achieved by selecting profiles with a larger system width or, where installation conditions allow, it is recommended that sheet piles are welded together into multiple units e.g. pairs or triples and that they are driven in that form.

It has been found during site trials that pitch and drive methods to install sheet piles are usually more practical than panel driving when using pre-applied sealants. Traditionally, panel driving rather than pitch and drive techniques, have been recommended to improve the accuracy with which sheet piles are installed. However, the need to work above ground level can make sealed sheet piles more difficult to pitch and sequential driving may disturb the sealants more. Dependant upon the type, more sealant may be extruded before the piles have been fully driven when panel driving.

Significant technological advances in sheet pile installation equipment have facilitated pitch & drive methods. Telescopic leader rigs and silent pressing machines have revolutionised pile installation and, in the right conditions, it is now possible to install piles accurately using this technique.

## Sealants

To ensure good joint integrity it is important to control the alignment of the piles in both the horizontal and vertical planes but excessive corrective actions can damage the sealants. If it is necessary to remove a pile then suitable repairs should be carried out to the sealant before reuse. If repair is not practical, withdrawn piles should be replaced by new ones.

It is essential not to overdrive sealed sheet piles with a vibratory hammer as the heat generated by vibro driving may cause the sealant to decompose or burn. If hard driving or refusal is encountered it is recommended that vibro driving ceases at once. The pile should then be driven to level with an impact hammer.

It has been found that displacement sealants can reduce friction in the interlocks and make driving easier, but a compression sealant can increase the interlock friction making pitching more difficult. This will not normally be a problem for silent pressing machines and telescopic rigs provided that the mast is of adequate size to enable the piles to be pitched easily.

It is essential that any application of heat to interlocks containing sealant, for example for cutting or welding, should only take place in well-ventilated areas. Inhalation of smoke and vapours could be harmful and should be prevented. It is the Contractor's responsibility to carry out adequate risk assessment procedures for any site operations that involve handling damaged sealant substances, welding, cutting or trimming of piles and carrying out repairs.

When trimming piles containing sealants using oxy acetylene equipment, suitable fire extinguishing equipment and breathing apparatus should be available.

---

### 2.8 Location of the sealants

Hydrophilic sealants should always be applied to the trailing interlock to avoid early swelling. Parts of a sheet pile that will be below excavation level in service cannot be economically sealed after installation and, if required, the sealant system should be applied before driving. Displacement or compression sealants should be applied to the leading interlock when it is necessary to seal the lower part of the pile.

If only the upper part of the pile requires sealant, a sealant system suitable for application to the trailing interlock should be specified. However it should not be forgotten that any exposed lengths of sheet pile can be seal welded after driving to achieve the required water tightness.

The sealant system may be curtailed above the bottom of the pile if penetration into an impermeable strata is required and sealant is not necessary over that part of the pile.

# Sealants

Piles should always be specified and ordered long enough to allow for trimming, in order that the piles and sealed lengths are driven to the required depth. Please note that contractors and designers should specify the distance from the top of the piles to the start of the sealant if trimming with oxy-acetylene equipment is foreseeable.

## 2.9 Chemical durability

After installation, the durability of the various sealant options in the presence of a number of chemicals can be summarised as follows:

Chemical	Hot applied bituminous product	Compressible sealant product	Hydrophilic sealant product
pH 3.5 to pH 11.5	Excellent	Excellent	Excellent
Seawater	Excellent	Excellent	Excellent
Mineral oil	Low	Excellent	Excellent
Petrol	Very low	Excellent	Excellent
Crude oil	Very low	No data available	Excellent

## 2.10 Permeability

The level of permeability achieved by an unsealed sheet pile wall will depend on the soil conditions, the pile section chosen, the water head and the quality of the installation. For this reason it is not easy to predict the permeability of an unsealed wall with any degree of accuracy. However when sealants have been applied to the interlocks many of the variables are no longer relevant and the permeability of the wall and sealant system as a whole may be assessed.

It is imperative for a wall to be watertight that the sheet piles must interlock correctly at corners and junctions. De-clutching caused by faulty installation practice has to be avoided.

A special de-clutching detector, Dixeran, has been developed by ArcelorMittal to confirm that pile interlocking has been successfully achieved. It is welded to the leading interlock of the previously installed pile and gives a signal when the pile being installed has reached the design toe position and is still interlocked. Further information is available from the ArcelorMittal Technical Department.

Sealed and welded sheet pile walls should be impermeable if the sealant system is performing adequately and as a sheet pile wall is very resistant to structural loading, movements occurring after the construction phase, that are sufficient to cause a seal to displace, are not expected in the normal course of events.

## Sealants

The following table gives an indication of the relative permeability values for a number of sealant options.

Table 2.10 Relative permeability of sealant options

Sealing system	$\rho$ [ $10^{-10}$ m/s]		Application of the system	Cost ratio <sup>1)</sup>
	100 kPa	200kPa		
No sealant	>1000	-	-	0
Interlock with Beltan	<600	not recommended	easy	1
Interlock with Arcoseal™	<600	not recommended	easy	2.5
Interlock with ROXAN™ System	0.3	3	with care	5
Welded interlock	0	0	2)	15

1) Cost ratio =  $\frac{\text{Cost of sealing system}}{\text{Cost of bituminous sealing system}}$

2) After excavation for the interlock to be threaded on jobsite

### 2.11 Welding

Welding of the sheet pile interlocks is perhaps the most effective way of permanently sealing sheet pile interlocks. This is commonly carried out in basement construction where the exposed face of the piling is easily accessed and water tightness to Grade 2 or 3 as defined in Table 2.2 is required. However to achieve a quality weld it is necessary to clean the surface and carry out the welding in dry conditions. A special welding procedure for this situation is available from the ArcelorMittal Commercial RPS Technical Department.

# Sealants

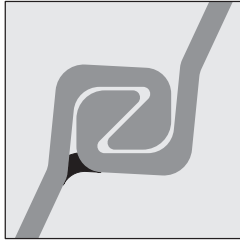

Fig 2.11.1

When the gap between adjacent interlocks is small enough, it is possible to create a seal by applying a simple fillet weld across the joint as illustrated above.

However, as sheet piling work is subject to on site tolerances, a range of practical options have been developed to cope with gaps of varying sizes.

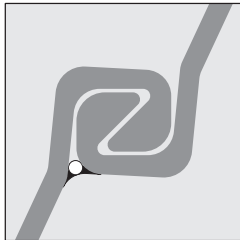

Fig 2.11.2

Where the gap is too large to be bridged by a single pass, introduction of a small diameter bar can be effective with a weld run applied to either side of the joint to create the seal.

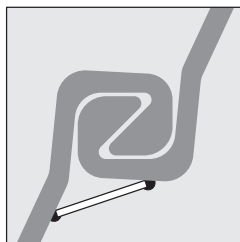

Fig 2.11.3

For wide gaps or where water is running through the interlock making an acceptable weld difficult to achieve, by welding a plate of sufficient width to suit the specific conditions across the joint it is possible to create a vertical drain to channel any seepage away from the weld.

# Sealants

## 2.12 Horizontal sealing

In addition to sealing the walls of an underground structure, it is also necessary to prevent water flow through the joint between the walls and floor. As with many construction activities, attention to detail and workmanship will ensure that the joint remains watertight, but the picture below illustrates a simple waterstop arrangement that can be formed by welding a plate to the piles before it is cast into the base slab. In this example, a hydrophilic strip has been attached to the plate to further enhance the performance of this water barrier.



Fig 2.12

When designing the horizontal joint it is suggested that consideration is given to welding the slab reinforcement to the piles to prevent the concrete shrinking away as it cures thereby creating a crack.



ArcelorMittal

- 1** Product information
- 2** Sealants
- 3** Durability
- 4** Earth and water pressure
- 5** Design of sheet pile structures
- 6** Retaining walls
- 7** Cofferdams
- 8** Charts for retaining walls
- 9** Circular cell construction design & installation
- 10** Bearing piles and axially loaded sheet piles
- 11** Installation of sheet piles
- 12** Noise and vibration from piling operations
- 13** Useful information

**3**

Durability

# Durability

## Contents

	Page
<b>3.1 Introduction</b>	1
<b>3.2 Corrosion of piling in various environments</b>	1
3.2.1 Underground corrosion of steel piles	1
3.2.2 Atmospheric corrosion	2
3.2.3 Corrosion in fresh waters	2
3.2.4 Corrosion in marine environments	3
3.2.5 Other environments	4
3.2.6 Localised corrosion	4
<b>3.3 The effective life of steel sheet piles</b>	6
<b>3.4 Example durability calculations</b>	8
<b>3.5 Protection for new and existing structures</b>	15
3.5.1 Measures for new structures	15
3.5.1.1 Use of a heavier section	15
3.5.1.2 Use of a high yield steel	16
3.5.1.3 Coating systems	16
3.5.1.4 Cathodic protection	17
3.5.1.5 Concrete encasement	18
3.5.2 Measures for existing structures	19
3.5.2.1 Plating of sections	19
3.5.2.2 Protective coatings	19
3.5.2.3 Cathodic protection	20
3.5.2.4 Frontal protection	20
3.5.2.5 Other protection options	20
<b>3.6 Recommendations for various environments</b>	21



# Durability



# Durability

## 3.1 Introduction

Steel piling is widely used in permanent earth retaining and structural foundation works, and in the majority of circumstances it can be used in an unprotected condition. The degree of corrosion and whether protection is required depends upon the working environment - which can be variable, even within a single installation.

In general, marine environments are the most corrosive and variable. In the few metres of vertical zoning which most structures encompass, piles are exposed to underground, seawater immersion, inter-tidal, splash and marine atmospheric environments. For most environments characteristic corrosion rates have been established. However, in some cases, localised corrosion may occur, requiring detailed site examinations and data analysis.

This chapter outlines the corrosion performance and effective life of steel piling in various environments and reviews the protective measures that can be taken to increase piling life in aggressive environments.

---

## 3.2 Corrosion of piling in various environments

In determining the effective life of unprotected piles, the selection of piling section and the need for protection it is necessary to consider the corrosion performance of bare steels in different environments. The corrosion data given for the following environments indicate the loss of section where only one face is exposed to the environment. In practice, opposite sides of a piling structure may be exposed to different environments. For example, one side of a harbour retaining wall may be subject to a marine environment whilst the opposite side is in contact with soil.

These situations are taken into account in 3.3, the tables of corrosion losses being based on those given in Eurocode 3: Part 5.

---

### 3.2.1 Underground corrosion of steel piles

The underground corrosion of steel piles has been studied extensively. A review of published data, outlining mainly overseas experiences, concluded that the underground corrosion of steel piles driven into undisturbed soils is negligible, irrespective of the soil type and characteristics; the insignificant corrosion attack being attributed to the very low oxygen levels present in undisturbed soils. Pitting corrosion in the water table zone is frequently reported in the literature, but nowhere is this regarded as affecting the structural integrity of piling, except for excessive pitting found in some Norwegian marine sediments. Evaluations of

## Durability

piles extracted from UK sites, ranging from canal and river embankments through harbours and beaches to a chemical slurry lagoon containing acid liquors (pH 2.8), also confirm negligible underground corrosion losses.

A further evaluation in Japan of test piles driven into natural soils at ten locations which were considered to be corrosive gave a maximum corrosion rate of 0.015 mm/side per year after ten years exposure.

An aspect of underground corrosion that can arise is that of microbial corrosion by sulphate-reducing bacteria, which is characterised by iron sulphide-rich corrosion products. Although this form of corrosion has been observed on buried steel structures, e.g. pipelines, there is no evidence from the literature or within ArcelorMittal experience that this is a problem with driven steel piles.

It is concluded that in natural, undisturbed soils steel pile corrosion is very slight and, for the purpose of calculations, a maximum corrosion rate of 0.012 mm/side per year can be used. In the special case of recent-fill soils or industrial waste soils, where corrosion rates may be higher, protective systems should be considered.

---

### 3.2.2 Atmospheric corrosion

At inland sites, piles used for foundation work may also be used as support columns or retaining walls above ground level. In such cases bare steel will corrode in the atmosphere at a rate which depends upon the site environment. In order of increasing corrosivity, this can be broadly classified as rural, urban or industrial. Similarly, piling at coastal sites may be subject to a marine atmospheric environment.

Eurocode 3: Part 5 indicates that the atmospheric corrosion of steel averages approximately 0.01 mm/side per year and this value can be used for most atmospheric environments. However, higher corrosion rates may be experienced in close proximity to the sea or when pollution produces very aggressive microclimates.

---

### 3.2.3 Corrosion in fresh waters

Fresh waters are very variable and can contain dissolved salts, gases or pollutants which may be either beneficial or harmful to steel. The term 'fresh waters' is used to distinguish these from sea or estuarine brackish waters.

# Durability

The corrosion of steel in fresh waters depends upon the type of water, although acidity/alkalinity has little effect over the range pH 4 to pH 9, which covers the majority of natural waters. Corrosion losses from fresh water immersion generally are lower than for sea water and effective lives are normally proportionately longer. However fresh waters are very variable and these variable conditions are reflected in the guidelines on corrosion rates given in Eurocode 3: Part 5.

---

## 3.2.4 Corrosion in marine environments

Marine environments normally encompass several exposure zones of differing aggressivity and the corrosion performance of marine structures in these zones requires separate consideration. Factors which can contribute to loss of pile thickness due to localised corrosion are also considered in 3.2.6. Information on loss of section thickness with time is given in tables 3.3.1 and 3.3.2.

### **Below the Bed-Level**

Where piles are below the bed level very little corrosion occurs and the corrosion rate given for underground corrosion is applicable, i.e. 0.012 mm/side per year.

### **Sea Water Immersion Zone**

Above the bed-level, and depending upon the tidal range and local topography, there may be a continuous seawater immersion zone in which, with time, piling exposed to unpolluted waters acquires a protective blanket of marine growth, consisting mainly of seaweeds, anemones and seasquirts. Corrosion of steel piling in immersion conditions therefore is normally low.

### **Tidal Zones**

This zone lies between the low-water neap tides and high-water spring tides and tends to accumulate dense barnacle growths with filamentous green seaweeds. The marine growths again give some protection to the piling, by sheltering the steel from wave action between tides and by limiting the oxygen supply to the steel surface.

Corrosion investigations show that rust films formed in this zone contain lime, derived from barnacle secretions, which also helps to limit the long term corrosion rate of steels to a level similar to that of immersion zone corrosion.

### **Low Water Zone**

At the low water level, where a lack of marine growth is observed, higher corrosion rates are often experienced. It has been established that, for piles in tidal waters, the low water level and the splash zone are regions of highest thickness losses.

## Durability

Higher corrosion rates are sometimes encountered at the low water level because of specific local conditions and it is recommended that periodic inspection of these areas is undertaken.

### **Splash and atmospheric zones**

Above the tidal zone are the splash and marine atmospheric zones, the former being subject to wave action and salt spray and the latter mainly to airborne chlorides. Unlike the tidal zone, these zones are not covered with marine growths. In the splash zone, which is a more aggressive environment than the atmospheric zone, corrosion rates are similar to the low water level, i.e. 0.075 mm/side per year. In this zone thick stratified rust layers can develop and at thicknesses above about 10 mm these tend to spall from the steel, especially on curved parts of the piles such as the shoulders and the clutches. However, it should be borne in mind that rust has a much greater volume than the steel from which it is derived and steel corrosion losses may amount to no more than 10% to 20% of the rust thickness. The boundary between the splash and atmospheric zones is not well defined; however, corrosion rates diminish rapidly with distance above peak wave height and the mean atmospheric corrosion rate of 0.02 mm/side per year can be used for this zone.

---

### 3.2.5 Other environments

The corrosion performance of piling in natural environments has so far been considered. For environments such as industrial waste tips, land reclamation schemes or those affected by man-made pollution, guidelines on corrosion rates are given in Eurocode 3:Part 5.

---

### 3.2.6 Localised corrosion

Localised corrosion can occur particularly in marine environments and recently anomalous corrosion effects have been observed in parts of structures within a number of ports throughout Western Europe. In these cases, highly localised corrosion has occurred at the low water level which conforms to a specific pattern. This form of localised corrosion has become known as 'accelerated low water corrosion'.

#### **Localised corrosion in the low water zone**

This form of corrosion has been experienced on sheet piles, pipe piles, and H sections and on parts of fabricated structures, e.g. angle and channel sections and plate material. These products have been produced by various manufacturers in Europe and Japan and therefore this phenomenon is not restricted to a particular section or steel manufacturer. Localised corrosion at the low water level has been investigated in Japan where it is termed

# Durability

'concentrated corrosion'. In a recent survey of port and harbour authorities throughout five Western European countries it was found that, on steel sheet piles, the localised corrosion followed a distinct pattern. In almost all cases the effect was confined to the outpans of sheet piled walls in a zone at, or just below, the mean low water level. The inpans were almost invariably unaffected. On 'U' shaped piles, this corrosion is most severe in the centre of the outpans, whilst for 'Z' shaped piles, the effect tends to be concentrated on the corners or webs of the outpans. Corrosion rates of 0.3 - 0.8 mm/year have been observed in these circumstances.

In extreme cases, pile thickness reductions in the outpan areas may lead to the premature formation of localised holes or slits in the steel. This can cause a reduction in structural integrity and in some cases, loss of fill material from behind the wall.

## Factors affecting localised corrosion

In marine environments, localised higher rates of corrosion can be caused by several mechanisms, individually or in combination, as discussed below:-

- a. Macro-cell effects have been found to occur on steel sheet piling in tidal waters where a range of corrosive environments is experienced. Research investigations have shown that potential differences exist between the various zones that occur in a marine environment such that the low water zone is anodic with respect to the tidal zone and that a corrosion peak occurs at the low water level due to the formation of a large differential aeration cell. The macro-cathode of this cell being in the tidal zone, where oxygen is available for the cathodic reduction reaction, and the macro-anode being in the adjacent low water zone. These macro-cell effects will vary depending upon local conditions.
- b. Continual removal of the protective corrosion product layer through abrasion or erosion, by the action of fendering systems, propeller wash, bow-thrusters, waterborne sands and gravels or repeated stresses, can lead to intense localised corrosion. The area where the rust layer is continually removed becomes anodic to the unaffected areas, particularly in the low water zone where macro-cell effects are strongest.
- c. In some cases, localised corrosion at the low water level has been associated with microbiological activity. A detailed evaluation of corrosion products from affected structures indicates the presence of compounds e.g. sulphides, which stimulate localised corrosion. It is considered that these compounds are associated with the presence of a consortia of bacteria including sulphate reducing bacteria and aerobic species.

## Durability

- d. Bi-metallic corrosion can occur where steel is electrically connected to other steels, metals or alloys, having nobler potentials or where weld metals are significantly less noble than the parent material. Corrosion is concentrated in the less noble steel, often at the junction between the dissimilar materials.
- e. Discontinuous marine fouling by plants and animals can accelerate the corrosion rate in localised areas because of differential environmental conditions caused by their presence (resulting in the formation of differential aeration cells etc.) or possibly by their biological processes. However, dense continuous marine growth can stifle general corrosion by impeding the diffusion of oxygen to the steel surface.
- f. Stray currents entering the structure from improperly grounded DC power sources can cause local severe localised damage at the point where the current leaves the structure.

### 3.3 The effective life of steel sheet piles

The effective life of unpainted or otherwise unprotected steel piling, depends upon the combined effects of imposed stresses and corrosion.

Performance is clearly optimised where low corrosion rates exist at positions of high imposed stresses.

The opposite faces of a sheet pile may be exposed to different combinations of environments. The following tables indicate the mean loss of thickness due to corrosion for these environments in temperate climates over a given life span.

Table 3.3.1 Loss of thickness [mm] due to corrosion for piles and sheet piles in soils, with or without groundwater

Required design working life	5 years	25 years	50 years	75 years	100 years
Undisturbed natural soils (sand, silt clay, schist, ...)	0,00	0,30	0,60	0,90	1,20
Polluted natural soils and industrial grounds	0,15	0,75	1,50	2,25	3,00
Aggressive natural soils (swamp, marsh, peat, ...)	0,20	1,00	1,75	2,50	3,25
Non-compacted and non-aggressive fills (clay, schist, sand, silt, ...)	0,18	0,70	1,20	1,70	2,20
Non-compacted and aggressive fills (ashes, slag, ...)	0,50	2,00	3,25	4,50	5,75

**Notes:**

- 1) The values given are only for guidance
- 2) Corrosion rates in compacted fills are lower than those in non-compacted ones. In compacted fills the figures in the table should be divided by two.
- 3) The values given for 5 and 25 years are based on measurements, whereas the other values are extrapolated.

## Durability

Table 3.3.2 Loss of thickness [mm] due to corrosion for piles and sheet piles in fresh water or in sea water

Required design working life	5 years	25 years	50 years	75 years	100 years
Common fresh water (river, ship canal, ...) in the zone of high attack (water line)	0,15	0,55	0,90	1,15	1,40
Very polluted fresh water (sewage, industrial effluent, ...) in the zone of high attack (water line)	0,30	1,30	2,30	3,30	4,30
Sea water in temperate climate in the zone of high attack (low water and splash zones)	0,55	1,90	3,75	5,60	7,50
Sea water in temperate climate in the zone permanent immersion or in the intertidal zone	0,25	0,90	1,75	2,60	3,50

**Notes:**

- 1) The values given are only for guidance.
- 2) The highest corrosion rate is usually found at the splash zone or at the low water level in tidal waters.  
However, in most cases, the highest bending stresses occur in the permanent immersion zone,
- 3) The values given for 5 and 25 years are based on measurements, whereas the other values are extrapolated.

The corrosion losses quoted are extracted from Eurocode 3:part 5 and based upon investigations carried out over many years on steel exposed in temperate climates. While the values quoted are considered to be relevant to the design and performance of most sheet piling structures, in some circumstances the designer may have local knowledge which leads to the adoption of higher values.

For combinations of environments where low water corrosion is involved, higher losses than those quoted have been observed at or just below the low water level mark and it is recommended that periodic inspection is undertaken.

Recent fill ground or waste tips will require special consideration.



# Durability

## 3.4 Example durability calculations

To establish the pile section needed for a given effective life in a specific environment it is necessary to follow the procedure below:

- 1 Establish the corrosion losses for each zone using tables 3.3.1, and 3.3.2.
- 2 Using the bending moment diagram Fig 3.4b establish the maximum bending moment in each corrosion zone.
- 3 Calculate the minimum required section modulus for each corrosion zone.
- 4 Using the graphs in 3.4.1, 3.4.2 and 3.4.3 determine the most appropriate section giving the required minimum section modulus after the loss of thickness calculated in step 1 above.

Fig 3.4a Design cross section

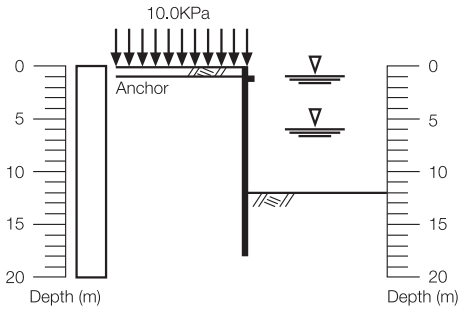
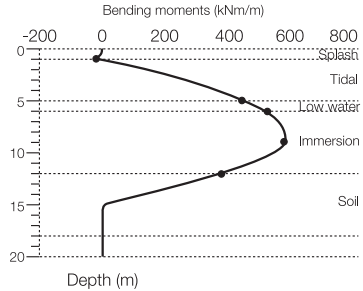

Fig 3.4b Typical marine wall bending moments



# Durability

Using the design cross section and bending moment diagrams given in Figs 3.4a and 3.4b, assess the pile section needed to give a 50 year design life.

Step 1	Depth	Face 1	Face 2	Total thickness loss over 50 year life (mm)
	0 - 1m	Soil	Splash	4.35
	1 - 5m	Soil	Tidal	2.35
	5 - 6m	Soil	Low Water	4.35
	6 - 12m	Soil	Immersion	2.35
	12 - 18m	Soil	Soil	1.2

Step 2	Depth	Maximum ultimate bending moment
	0 - 1m	10kNm/m
	1 - 5m	440kNm/m
	5 - 6m	520kNm/m
	6 - 12m	590kNm/m
	12 - 18m	370kNm/m

This example is based on the use of S390GP steel and hence a Yield Stress of  $390\text{N/mm}^2$  is used to determine the minimum section modulus needed for each corrosion zone.

Step 3	Depth	Minimum section modulus
	0 - 1m	$10 \times 10^3 \times 1.2/390 = 31\text{cm}^3/\text{m}$
	1 - 5m	$440 \times 10^3 \times 1.2/390 = 1354\text{cm}^3/\text{m}$
	5 - 6m	$520 \times 10^3 \times 1.2/390 = 1600\text{cm}^3/\text{m}$
	6 - 12m	$590 \times 10^3 \times 1.2/390 = 1815\text{cm}^3/\text{m}$
	12 - 18m	$370 \times 10^3 \times 1.2/390 = 1139\text{cm}^3/\text{m}$

## Step 4

From the critical minimum section modulus requirements calculated in Step 3 and the appropriate thickness loss from step 1 ( $Z_{\text{min}} = 1815\text{cm}^3/\text{m}$ ,  $t = 2.35\text{mm}$  or  $Z_{\text{min}} = 1600\text{cm}^3/\text{m}$ ,  $t = 4.35\text{mm}$ ) an appropriate pile section can be selected: in this case, AZ 25 in grade S390GP steel is to be adopted.

With application of a coating suitable for marine exposure conditions, an additional 20+ years can be anticipated.

# Durability

## 3.4.1a Elastic section modulus against loss of thickness AZ piles

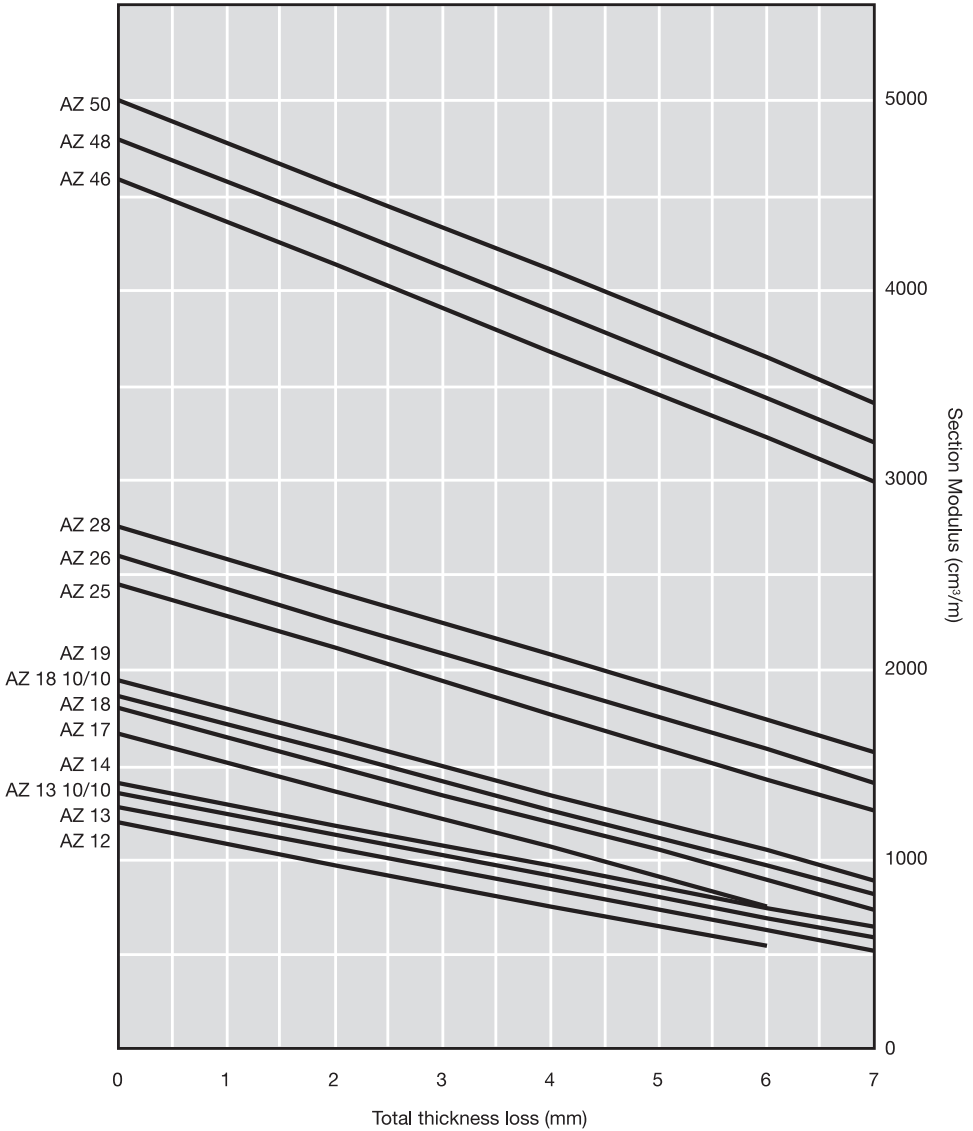

# Durability

## 3.4.1b Elastic section modulus against loss of thickness AZ piles

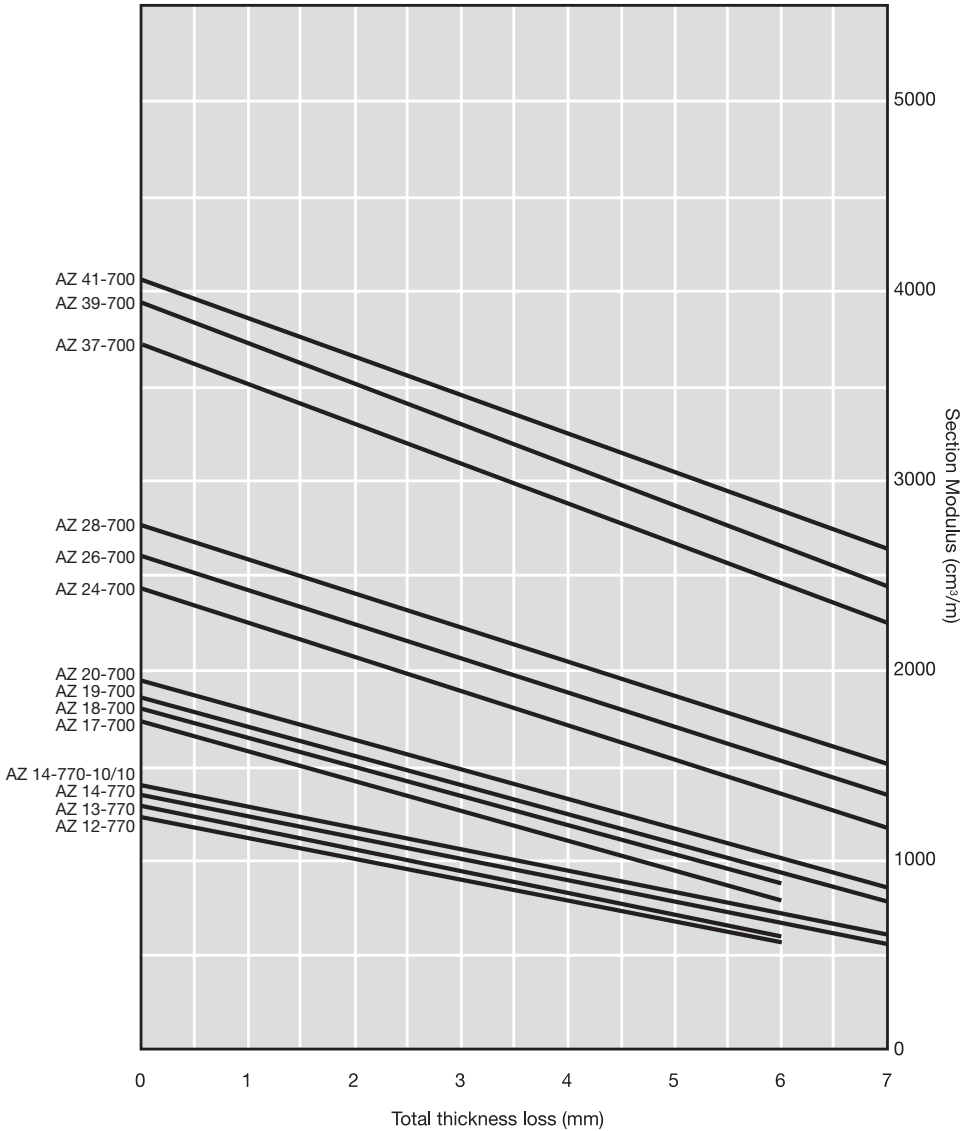

# Durability

## 3.4.2 Elastic section modulus against loss of thickness AU piles

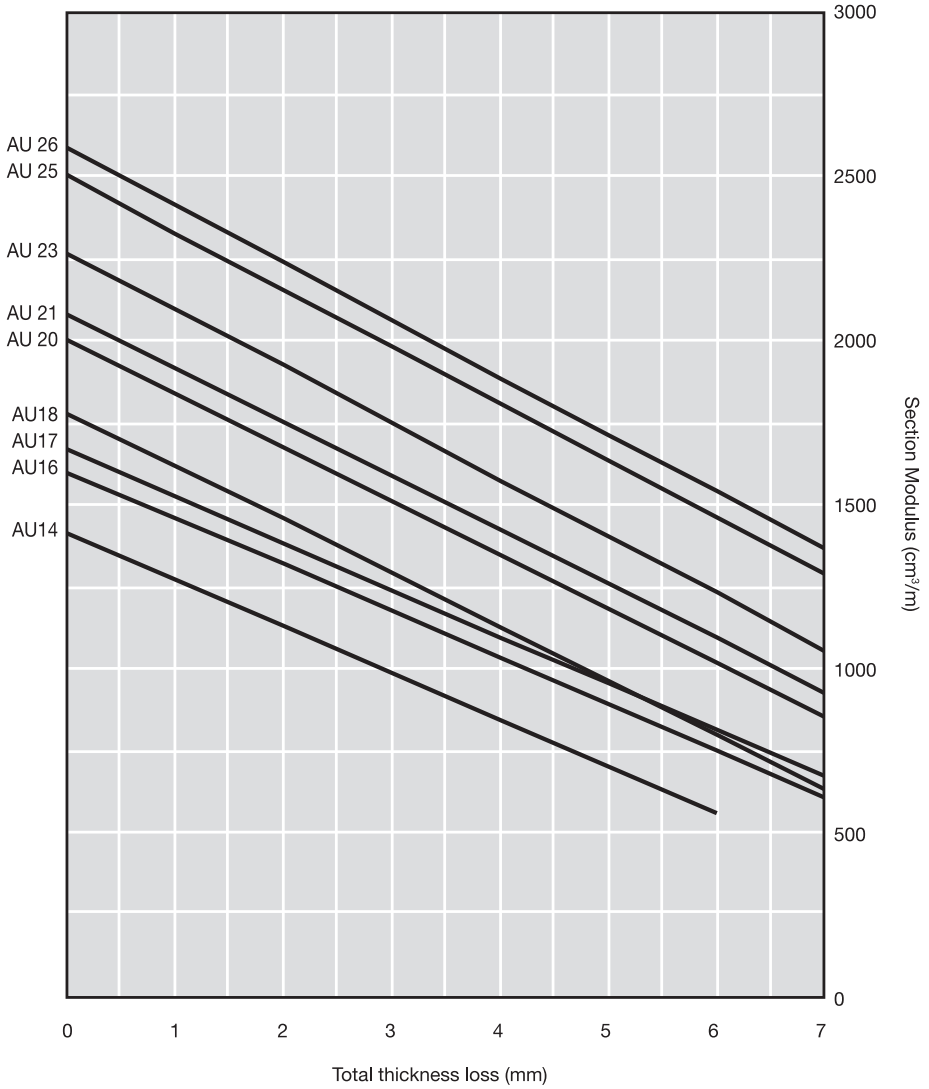

# Durability

## 3.4.3a Elastic section modulus against loss of thickness PU piles

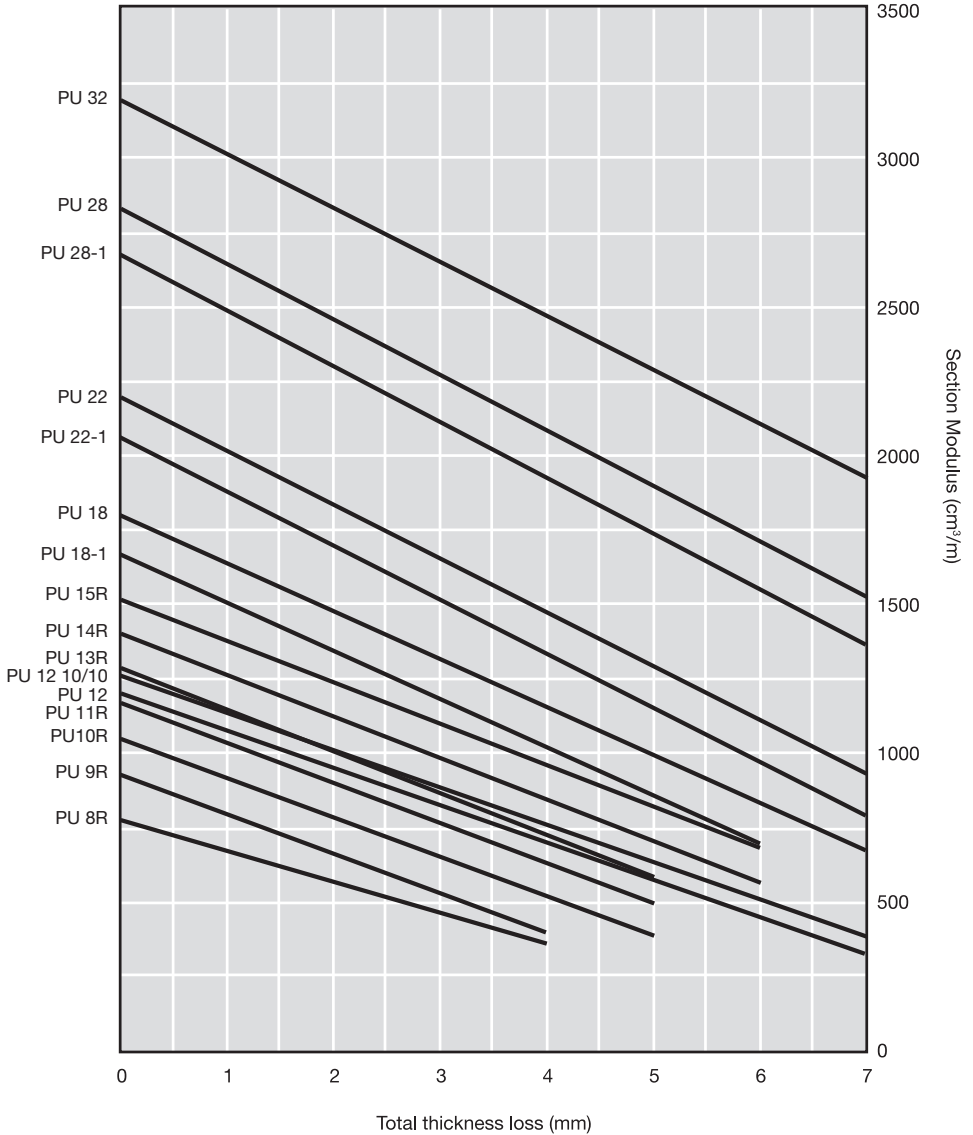

# Durability

## 3.4.3b Elastic section modulus against loss of thickness GU piles

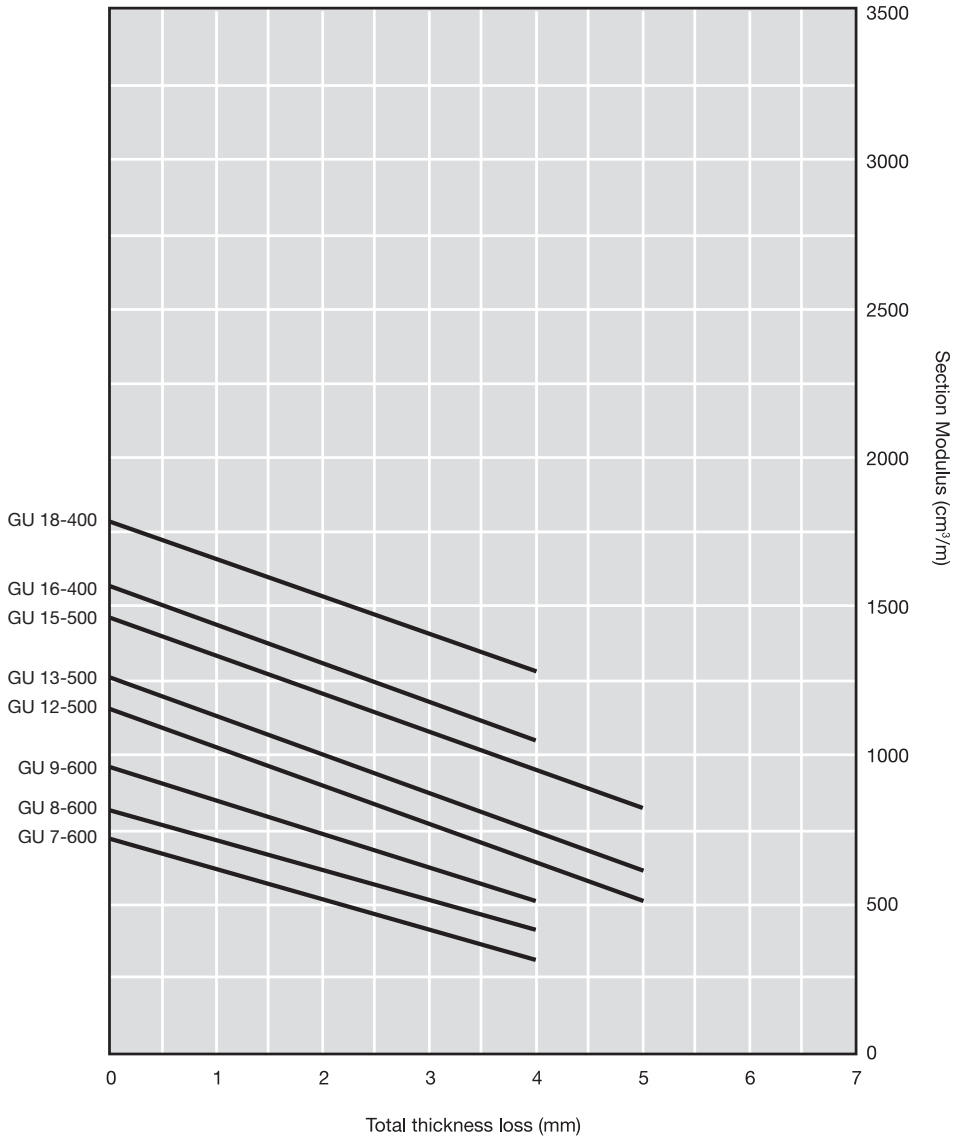

# Durability

## 3.5 Protection for new and existing structures

In many circumstances steel corrosion rates are low and the use of protective systems etc. is not necessary. However, there are circumstances where corrosion of steel piling can be more significant:

In these circumstances methods of increasing the effective life of a structure may need to be considered and the measures that can be taken include the following:

- (a) Use of a heavier section
- (b) Use of a high yield steel at mild steel stress levels
- (c) Applying a protective organic coating or concrete encasement
- (d) Applying cathodic protection

If a sheet piling wall is to be constructed in an area which may be prone to localised corrosion, one or more of the specified measures to provide the desired effective life should be considered at the design stage to allow for the possibility of higher corrosion rates on unprotected steel piles particularly at or around the low water level. (Given the effects are highly localised, the additional expense involved in engineering a repair, when necessary, to account for the phenomenon is often modest in the context of the overall project cost).

Consideration should be given to the provision of an engineered solution to structures which are likely to be subject to abrasion or erosion. The effects of abrasion and erosion should also be taken into account when methods of corrosion protection are being considered, e.g. the use of a paint coating.

---

### 3.5.1 Measures for new structures

#### 3.5.1.1 Use of a heavier section

Effective life can be increased by the use of additional steel thickness as a corrosion allowance. The extra steel thickness required depends upon the working life and environment of the piling structure. The thickness losses for steel piling in various service environments have been outlined in 3.3. In determining this corrosion allowance it is important to consider the stress distribution in the structure in order to locate the region where corrosion losses can be least tolerated. It is possible that the most corrosive zones will not coincide with the most highly stressed zone and therefore, in many circumstances, the use of a corrosion allowance can be a cost effective method of increasing effective life.

Alternatively, it may prove more economical to increase the pile thickness locally in the low water zone by the attachment of plates. Typically, these will need to be 2-3m in length.



# Durability

---

## 3.5.1.2 Use of a high yield steel

An alternative approach to using mild steel in a heavier section is to use a higher yield steel and retain the same section. Although all grades of carbon steel have similar corrosion rates, the provision for example, of grade S355GP sheet piles to EN10248 designed to grade S270GP stresses will allow an additional 30% loss of permissible thickness to be sustained without detriment. This method, in effect, builds in a corrosion allowance and gives an increase of 30% in effective life of a steel piling structure for an increase of less than 2% in steel costs. An even greater performance increase can be achieved by specifying S390GP or S430GP steels for piles designed to S270GP stresses.

## 3.5.1.3 Coating systems

### **Atmospheric exposure.**

In industrial and coastal regions, the corrosion process may be accelerated by the presence of salt and/or industrial pollution – particularly sulphur dioxide. The life of conventional paints is rather short, resulting in frequent maintenance periods. The use of heavy duty epoxy/polyurethane systems will extend the time to first maintenance and reduce the overall cost of steel protection.

Sheet piling is often used in situations where part of it is exposed to the atmosphere, for example as a retaining wall. In such applications, the aesthetic and functional look is important. A coal tar epoxy finish or a rusty surface are unlikely to be acceptable and so polyurethane finishes become an automatic choice. They combine gloss and colour retention and the latest formulations are easy to apply and maintain.

### **Suggested system:**

Zinc silicate epoxy primer  
 Re-coatable epoxy intermediate coating  
 Aliphatic polyurethane topcoat  
 Nominal dry film thickness of the system 240µm

### **Fresh water immersion.**

Fresh water is usually less corrosive than sea water although brackish or polluted water conditions can still be quite severe.

There are often aesthetic considerations in fresh water projects. For convenience a system has been chosen which is capable of performing well both above and below water avoiding the need to apply separate systems and hence saving time and cost.

The proposed system is tar free and suitable for both immersion and atmospheric exposure. Where maximum colour and gloss retention is required, a polyurethane finish may be applied as a topcoat.

# Durability

## **Suggested system:**

Polyamine cured epoxy coating

Nominal dry film thickness of the system 300µm

## **Seawater immersion.**

Structures continuously or partially immersed in sea water require careful attention. Abrasion and impact (direct or indirect) may damage the coating system and soluble salts from the sea will accelerate the rate of corrosion for the damaged areas.

For long term performance in immersed conditions, there should be no compromise on quality. The specification must be clear and the surface preparation must be good.

The application must be properly carried out and inspected and the coating system must be of high quality. Cathodic protection is often specified in combination with a coating system and it is essential that the chosen coating system has been fully tested for compatibility.

## **Suggested system:**

Polyamide cured epoxy primer

Polyamide cured coal tar epoxy coating

Nominal dry film thickness of the system 450µm

(As an alternative, glass flake reinforced epoxy coating could be used with the appropriate primer and sealer).

## **Waste disposal.**

Sheet piling is increasingly being used to isolate severely contaminated ground. It is also used to contain polluted soil which has been moved from other areas. Here, an excellent standard of steel protection is essential. The coating system may have to protect the steel from highly acidic soil. It must have an outstandingly good chemical resistance and especially good resistance to mineral and organic acids. The system must be able to withstand abrasion and impact.

## **Suggested system:**

Micaceous iron oxide pigmented polyamide cured epoxy primer

Polyamine cured epoxy coating with increased chemical resistance

Nominal dry film thickness of the system 480µm

---

### 3.5.1.4 Cathodic protection

The design and application of cathodic protection systems to marine piled structures is a complex operation requiring the knowledge and experience of specialist firms. The principles involved are outlined below.

Two systems are employed, utilising either sacrificial anodes or impressed DC currents. In normal electrochemical corrosion all

## Durability

metal-loss occurs at the anode and both types of CP system impart immunity from corrosion by rendering the steel structure cathodic to externally placed anodes. Bare steel structures initially require an average current density at about  $100 \text{ mA/m}^2$  in seawater, but this value normally falls over a long period of continuous operation to within the range 30 to  $70 \text{ mA/m}^2$ . Therefore, for a sheet piled structure of large surface area, the total current required could be considerable. If piles are coated below the water level then, depending upon the type of coating employed, current requirements are considerably reduced and can be as low as  $5 \text{ mA/m}^2$ . Deterioration of the protective coating occurs with time, though this is counteracted to some extent, by the deposition of protective calcium and magnesium salts on bare areas of the sheet piling and the growth of marine organisms. However, in the long term, an increase in total current may be necessary and the cathodic protection system should be designed with an appropriate margin of capacity to cover this situation. Not all protective coatings can be used in conjunction with cathodic protection. The coating should be of high electrical resistance, as continuous as possible, and resistant to any alkali which is generated by the cathodic reaction on the steel surface. The coating system suggested for sea water immersion in 3.5.1.3 can be used with cathodic protection.

When considering cathodic protection it should be borne in mind that this method is considered to be fully effective only up to the half-tide mark. For zones above this level, including the splash zone, alternative methods of protection are required.

Sacrificial anode or impressed current alone or in conjunction with CP compatible protective coating systems have been evaluated and recommended as a method of protection against localised corrosion at the low water level in both Europe and Japan. These evaluations include bioreactor tests in the presence of bacteria.

It is considered that CP is effective at sea bed level where localised corrosion occurs due to sand eroding away the corrosion product layer (rather than the steel surface). However, sand erosion prevents the deposition of protective calcareous deposits normally formed during CP and, therefore, the protective current density would be higher than typical values.

---

### 3.5.1.5 Concrete encasement

Concrete encasement can be used to protect steel piles in marine environments. Often the use of concrete is restricted to the splash zone by extending the concrete cope to below the mean high water level. However, in some circumstances, both splash and tidal zones are protected by extending the cope to below the lowest low water level.

# Durability

Experience has shown that where the splash zone is only partially encased, a narrow zone of increased corrosion can occur at the steel-concrete junction. This is a result of electrochemical effects at the steel-concrete junction, i.e. a potential difference is generated between steel in concrete and in seawater which, combined with the effects of differential aeration at the junction, causes the exposed steel immediately adjacent to the concrete to become anodic and corrode preferentially.

Concrete is not itself always free from deterioration problems. It normally has a pH value of about 12 to 13 and within this pH range steel remains passive and corrosion is superficial. However, diffusion of chloride ions into the concrete from seawater can break down steel passivity and stimulate the corrosion reactions. Therefore, concrete for protecting steel in seawater must be of good quality, i.e. have high strength, good bonding characteristics, low permeability and be free initially from chlorides. It must also provide adequate cover and be properly placed and cured. If these requirements are not met, then rust formed from corrosion of the steel piles or steel reinforcement within the concrete can exert sufficient pressure to spall the concrete and expose the steel to the marine environment. Remedial work on partially spalled concrete and exposed steel is difficult and expensive.

With correct design and the use of good quality concrete, encasement is an effective method of increasing the working life of a steel piling structure.

---

## 3.5.2 Measures for existing structures

### 3.5.2.1 Plating of sections

Affected areas of a sheet pile wall can be 'thickened' by the attachment of plates, which can also be used to repair holes and slits. Welding of plates is feasible in either wet or dry conditions but the latter is normally preferable to avoid the necessity for divers and special techniques. Limpet dam type devices can be used to dewater around the affected regions and allow welding in dry conditions. After repair, further protective measures can be considered such as the application of a protective coating or cathodic protection.

---

### 3.5.2.2 Protective coatings

Protective coatings can be applied on site to areas affected by localised corrosion. However, it should be noted that surface preparation and cleanliness as well as the properties of the coating are critical to long-term durability.

## Durability

Surface tolerant coatings are available that can be applied under dry conditions using a limpet dam. Such devices have limited depth and enable application of coatings to below the low water level but not necessarily down to bed level.

Solvent free coatings also have been developed that can be applied and will cure under water using special application equipment which enables large surface areas to be treated. Two coats are normally applied to minimise the possibility of through coating defects and such coatings can be applied to bed level.

---

### 3.5.2.3 Cathodic protection

Cathodic protection can be retrofitted to affected or repaired structures. Provided the structure to be protected is electrically continuous and is maintained at the correct protection potential, a good degree of attenuation of corrosion effects is feasible.

---

### 3.5.2.4 Frontal protection

In the extreme, a new steel face to the piled wall can be created by driving a row of shorter piles in front of the existing structure and connecting them together. Concrete may be used to fill the gap. Thus, the front wall may be allowed to corrode away completely without prejudicing the integrity of the overall structure. Obviously, such measures will be impractical in many circumstances owing to the geometrical requirements for berthing etc.

---

### 3.5.2.5 Other protection options

Some developments that are being carried out at the time of writing are outlined below.

An electrochemical method is being developed for the treatment of localised corrosion during its early stages. The affected area is electrochemically cleaned, sterilised and subsequently coated with a calcareous deposit, formed from the salts dissolved in seawater, which protects the treated surface from further corrosion. However, the long term durability of the coating remains to be validated.

Water based cementitious modified polymer coatings are available which are tolerant of on-site conditions and have given long term durability on steel surfaces at coating thicknesses of about 2mm. These coatings are being further developed so that they can be spray applied on-site at economical rates.

Alternatives to existing underwater coatings are currently being developed and tested.

# Durability

## 3.6 Recommendations for various environments

The recommendations outlined below are based on the corrosion data given in 3.3 for the various environments and on our experience. Where local conditions are likely to impair life, for example where the piling is subject to localised corrosion, these circumstances have also been considered.

### **Underground exposures**

Steel piles driven into undisturbed ground require no protection irrespective of the soil types encountered. This also applies to piles driven into harbour, river and sea beds.

For piling driven into recent fill soils and particularly industrial fill soils some protection may be necessary, though each case should be judged on its merits. Where protection is required it is recommended that a durable protective organic coating is applied to a dry film thickness of 480 microns (see 3.5.1.3).

### **Seawater immersion exposures**

Normally the corrosion rate of steel immersed in seawater is low enough to give acceptable steel loss over the design life of a piling structure. Therefore bare steel can be used in immersion conditions. Alternatively, paint coatings or cathodic protection can be used to achieve the required design life.

### **Fresh water immersion exposures**

For practical purposes, the situation is the same as for seawater immersion and corrosion is low enough to permit the use of bare steel. In fresh water immersion conditions, protective organic coatings would be expected to last longer.

### **Fresh water exposures at or above the water level**

In non-tidal situations, corrosion can occur at the water line of piled river embankments and, more usually, canals where these support roughly a constant water level. On smaller canals where this is likely to be a problem, protected trench sheets are normally used. On larger canals etc., where piling is more often used, it is recommended that a protective organic coating is applied to a depth of 1 m above and below the water level to a dry film thickness of 300 microns on the water side. At areas other than the water line, protection is unnecessary. However, if the section of piling above water level is required to be painted for aesthetic reasons, then a protective coating can be used above the recommended 1 m level, depending upon the cost and durability requirements.

Where the water level is variable, protective systems are unnecessary. However, if painting above the water line is required for aesthetic reasons then again, depending upon requirements, protective coatings can be used.

# Durability

## **Marine tidal exposures**

Tidal zones tend to accumulate marine fouling which affords some protection to the underlying steel and acceptable corrosion rates occur over this zone, although a corrosion peak tends to occur at the low water level. Bare steel with an appropriate corrosion allowance can be used or alternatively, the design life can be achieved through the use of a paint coating or cathodic protection. Localised corrosion can occur at the low water level and possible corrosion protection measures that can be applied are discussed in 3.5.2.

## **Marine splash zone exposures**

This zone, together with the low water level, presents the most corrosive conditions for steel and several options exist. In many circumstances bare steel can be used with a corrosion allowance where appropriate. The ASTM standard claims that Grade A690 steel (Mariner grade) gives a performance improvement of 2 to 3 times that of conventional carbon steel in marine splash zone conditions. Alternatively, protection can be employed in the form of organic coatings or concrete encasement. With the former it is recommended that the coating be applied to a dry film thickness of 450 microns and should extend to at least 1 m below mean high water level. It should be borne in mind that, in the absence of good borehole data, it is often impossible to estimate beforehand the driven depth of piling. In such cases more of the pile length may have to be coated to ensure that the piles in situ are protected in the splash zone. The ease and effectiveness of maintenance will depend upon local conditions, for instance the degree of shelter from wave action.

Where the tidal range is small concrete encasement can also be used. With this method the cope should be extended to a minimum of 1 m below mean high water level and the highest quality concrete used. Good coverage of the encased steel should be ensured.

## **Atmospheric exposures**

Piling exposed to rural, urban or industrial atmospheres is usually painted for aesthetic reasons.

A variety of coatings can be used depending upon requirements. Where aesthetic considerations are of prime importance, some coatings can be overcoated on-site with a polyurethane finish coat.

These coatings can also be used where sheet piled bridge abutments or other piled land-sited structures are subject to road salt spray or where piled walls or bridge abutments are hidden by stand-off brick or stone facias.

## Durability

The marine atmosphere zone of a piling structure is normally considered on the same basis as the splash zone and if protection is used on the splash zone then it is normally extended to protect the atmospheric zone.





ArcelorMittal

- 1** Product information
- 2** Sealants
- 3** Durability
- 4** Earth and water pressure
- 5** Design of sheet pile structures
- 6** Retaining walls
- 7** Cofferdams
- 8** Charts for retaining walls
- 9** Circular cell construction design & installation
- 10** Bearing piles and axially loaded sheet piles
- 11** Installation of sheet piles
- 12** Noise and vibration from piling operations
- 13** Useful information

# Earth and water pressure

Contents	Page
<b>Notation</b>	1
<b>4.1 Introduction</b>	3
<b>4.2 Determination of soil properties</b>	3
<b>4.3 Types of boreholes samples and methods of testing</b>	5
4.3.1 Cohesionless soils (gravel, sand etc.)	5
4.3.2 Cohesive soils (clays and silts)	6
4.3.3 Mixed soils (sand with clay, sand with silt)	7
4.3.4 Rock	7
4.3.5 Geophysical methods of site investigation	7
4.3.6 Chemical analysis	8
4.3.7 Seepage water	8
<b>4.4 Information required for design of steel sheet pile retaining walls and cofferdams</b>	8
<b>4.5 Typical soil properties</b>	9
<b>4.6 Earth pressure calculation</b>	9
<b>4.7 Short term, total stress analysis</b>	11
<b>4.8 Long term, effective stress analysis</b>	12
<b>4.9 Tension crack</b>	15
<b>4.10 Groundwater pressures</b>	16
<b>4.11 Permanent structures</b>	17
<b>4.12 Temporary structures</b>	17
<b>4.13 Battered walls</b>	18
<b>4.14 Concentrated and linear surcharge</b>	18
<b>4.15 Sloping ground surface</b>	19
<b>4.16 Earth pressure calculation</b>	19

## Earth and water pressure



<b>Notation</b>		<b>Units</b>
$\gamma$	Bulk "weight density" of soil	kN/m <sup>3</sup>
$\gamma_{\text{sat}}$	Saturated "weight density" of soil	kN/m <sup>3</sup>
$\gamma'$	Submerged "weight density" of soil	kN/m <sup>3</sup>
$\gamma_w$	"Weight density" of water	kN/m <sup>3</sup>
$c'$	Effective cohesion	kN/m <sup>2</sup>
$c'_d$	Design cohesion value (effective stress)	kN/m <sup>2</sup>
$c'_{\text{mc}}$	Moderately conservative value of effective cohesion	kN/m <sup>2</sup>
$\delta$	Angle of wall friction	degrees
$\delta_{\text{max}}$	Limiting angle of wall friction between soil and piles	degrees
$F_s$	Factor of safety	-
$F_{s c'}$	Factor applied to the effective cohesion value	-
$F_{s \phi'}$	Factor applied to the effective angle of shearing resistance	-
$F_{s s_u}$	Factor applied to the undrained shear strength	-
$K_a$	Coefficient of active earth pressure	-
$K_{ac}$	Active pressure coefficient for cohesion	-
$K_p$	Coefficient of passive earth pressure	-
$K_{pc}$	Passive pressure coefficient for cohesion	-
$p_a$	Intensity of active earth pressure (total stress)	kN/m <sup>2</sup>
$p'_a$	Intensity of active earth pressure (effective stress)	kN/m <sup>2</sup>
$p_p$	Intensity of passive earth pressure (total stress)	kN/m <sup>2</sup>
$p'_p$	Intensity of passive earth pressure (effective stress)	kN/m <sup>2</sup>
$\phi$	Total stress angle of shearing resistance	degrees
$\phi'$	Effective stress angle of shearing resistance	degrees
$\phi'_{\text{crit}}$	Critical state angle of shearing resistance (effective stress parameter)	degrees
$\phi'_{\text{mc}}$	Moderately conservative value of shearing resistance of the soil (effective stress parameter)	degrees
$\phi'_d$	Design angle of shearing resistance (effective stress)	degrees

*continued*

## Earth and water pressure

Notation		Units
q	Surcharge Pressure	kN/m <sup>2</sup>
s <sub>u</sub>	Undrained shear strength (total stress)	kN/m <sup>2</sup>
s <sub>ud</sub>	Design Undrained shear strength (total stress)	kN/m <sup>2</sup>
s <sub>umc</sub>	Moderately conservative value of undrained shear strength (total stress)	kN/m <sup>2</sup>
s <sub>wmax</sub>	Limiting value of wall adhesion (total stress)	kN/m <sup>2</sup>
u	Water pressure	kN/m <sup>2</sup>
z	Depth	m

“Weight Density” in kN/m<sup>3</sup> can be readily converted to Mass Density” in kg/m<sup>3</sup> by multiplying by 102.

### Types of soil

- 1 Cohesionless soils: granular materials such as sand, gravel, hardcore, rock, filling etc.
- 2 Cohesive soils: clays and silts. Under certain conditions chalk and other similar materials can be treated as cohesive soils
- 3 Mixed soils: combinations of groups 1 and 2 such as sand with clay, or sand with silt.
- 4 Rock

# Earth and water pressure

## 4.1 Introduction

The assessment of soil stratification and assignment of appropriate engineering parameters is a fundamental part of the design process for an embedded retaining wall. The soil not only creates the forces attempting to destabilise the wall but also provides the means by which stability is achieved so an understanding of the importance of soil in the design of retaining walls is paramount.

It is assumed that the reader has a basic knowledge of soil mechanics and consequently this chapter is included as a refresher for some of the principles on which retaining wall design is based.

Soil parameters for use in design calculations should, wherever possible, be obtained by sampling and testing material from the job site but indicative parameter values are included in this chapter for use in preliminary calculations.

The amount and complexity of data needed to carry out the design of a retaining wall is, to an extent, governed by the calculation method to be used. For example, if the analysis is to be carried out on the basis of limiting equilibrium, relatively simple soil data can be used to obtain a satisfactory answer but if the problem is to be analysed using finite element techniques, the data input required to adequately describe the behaviour of the soil is significantly more complex. Additional or more complex soil data will involve a greater site investigation cost and it is often the case that the client is not prepared to sanction greater expenditure at this stage of a project. In many cases, however, the additional cost is easily recouped by avoiding false economies and conducting a more sophisticated analysis.

---

## 4.2 Determination of soil properties

### **Site Investigation, Boreholes, Soil Sampling and Testing**

The precise and adequate determination of site conditions prior to the commencement of any form of civil engineering construction work is necessarily regarded as standard practice.

Where piled foundations, cofferdams, retaining walls etc. are to be driven it is essential that as much information as possible be obtained regarding strata, ground water, tidal water, embankments, existing foundations, buried services and the like in order to design the most suitable piling in terms of strength, stability and economy.

Full use should therefore be made of all available information, no matter how old, regarding previous investigation of the proposed site and its surroundings. Such information should be supplemented with data obtained from borehole sampling and testing, the number of boreholes depending upon the size and nature of the site.

## Earth and water pressure

For piling work, the number of boreholes, or other form of investigation, should be adequate to establish the ground conditions along the length of the proposed piling and to ascertain the variability in those conditions. The centres between boreholes will vary from site to site but should generally be at intervals of 10 to 50m along the length of the wall. The depth of the investigation will be related to the geology of the site; it is recommended that boreholes be taken down to at least three times the proposed retained height. To assess the precise nature of the ground, samples should be taken at regular intervals within this depth or wherever a change in stratum occurs.

If ground anchorages are proposed, the ground investigation should be of sufficient extent and depth to provide data for the strata in which the anchorages will attain their bond length.

Samples obtained by the borehole method must be correctly labelled to avoid possible error. Duplicate records of all boreholes giving depth and location, should also be maintained.

Table 4.2 Field Identification of Soils

Very Soft	Exudes between fingers when squeezed in fist.
Soft	Can be readily excavated with a spade and can be easily moulded by substantial pressure in the fingers.
Firm	Can be excavated with a spade and can be remoulded by substantial pressure in the fingers.
Stiff	Requires a pick or pneumatic spade for its removal and cannot be moulded with the fingers.
Very Stiff	Requires a pick or pneumatic spade for its removal and will be hard and brittle or very tough.

Many stiff clays exist in their natural state with a network of joints or fissures. A large piece of such clay, when dropped, will break into polyhedral fragments. If possible, it should be determined whether the clay is fissured or intact, as this could be a criterion in the design of steel sheet pile structures.

## Earth and water pressure

### 4.3 Types of borehole sample and methods of testing

#### 4.3.1 Cohesionless soils (gravel, sand etc)

Air tight jar or bag samples (disturbed) are normally forwarded to the laboratory for scientific analysis. When examined on site, this should be carried out by a qualified engineer or geologist.

Table 4.3.1 Relationship of In-situ Tests to Relative Density of Cohesionless Soils

Relative Density	Standard Penetration Test 'N' Value	Cone Penetration Test 'q <sub>s</sub> ' (MN/m <sup>2</sup> )	ϕ' (Degrees)
Very Loose	0-4	2.5	25
Loose	4-10	2.5-7.5	27.5
Medium Dense	10-30	7.5-15.0	30
Dense	30-50	15.0-25.0	35
Very Dense	Over 50	Over 25.0	40

(TESPA – Installation of Steel Sheet Piles)

#### Standard Penetration Test (in-situ density)

The resistance offered by a cohesionless soil to a 50mm external diameter thick-walled sample tube when driven into the bottom of a borehole can be approximated to the relative density of the soil encountered. It is usual to neglect the first 150mm of penetration because of possible loose soil in the bottom of the borehole from the boring operations. The force applied is that of a free-falling load of 64kg travelling 760mm before impact, the number of blows (N) per 300mm of penetration being recorded. See Table 4.3.1 for interpretation of results.

Beware of false values in very fine grained soils when the stratum is subject to high groundwater pressure. Under these conditions it is possible for the bottom of the borehole to blow while the SPT test equipment is being put into the borehole creating very loose conditions for the test that will not be realised in practice.

#### Shear Box Test.

Used to determine the angle of internal friction. Because granular soils are relatively free draining, any excess pore water pressures developed, even under rapid loading, will dissipate readily. Hence the results of this test will always give effective stress values (ϕ').



# Earth and water pressure

## Mechanical Analysis.

This comprises two stages involving the separation of coarser particles by means of sieves and determination of the size of finer particles by a special sedimentation process known as wet analysis. The subject of mechanical analysis exceeds the scope of this type of handbook. Reference should be made to appropriate literature for methods of procedure.

### 4.3.2 Cohesive soils (clays and silts)

**Shear strength.** Two distinct methods of testing are given as the correct procedure, ie “direct” shear tests and “indirect” shear tests.

Direct shear testing involves the use of the Vane Test in which a metal vane is pushed into the soil in the borehole and torque applied. Measurement of the resultant angle-of-twist in the transmitting rod or spring indicates the magnitude of the torque, hence, the strength of the sample material.

Indirect shear tests are carried out on undisturbed samples in two forms:

**1 Triaxial Compression Test** wherein a cylindrical specimen (undrained) is subject to a constant lateral hydrostatic pressure whilst the axial pressure is steadily increased to the yield point of the material.

The test will give the ‘total’ stress parameters of  $\sigma$  and  $s_u$  for all types of clay.

In the absence of site-specific data the undrained shear strength value ( $s_u$ ), of the clay, can be deduced from the soil descriptions shown in table 4.3.2.1.

Table 4.3.2.1 Relationship between soil consistency and undrained shear strength.

Consistency of Clay	Undrained Shear Strength ( $s_u$ ) (kN/m <sup>2</sup> )
Very Soft	<20
Soft	20 - 40
Firm	40 - 75
Stiff	75 - 150
Very Stiff	150 - 300

## Earth and water pressure

When “effective” stress parameters are required ( $\sigma'$  and  $c'$ ), a drained triaxial test should be performed, with the strain rate sufficiently low to ensure the dissipation of pore water pressures.

If no effective stress parameters are available from triaxial tests, Table 4.3.2.2 may be used for initial design studies in conjunction with an effective cohesion value  $c'=0$ .

Table 4.3.2.2 Relationship of Plasticity Index to the critical angle of shearing resistance for cohesive soils.

Plasticity Index %	$\phi'_{crit}$ (degrees)
15	30
30	25
50	20
80	15

**2 Unconfined Compression Test** which measures the shear strength of undrained cohesive soils under zero lateral pressures by means of a special test apparatus, normally portable.

**Natural Moisture Content.** Determination of the natural or in-situ moisture content of a soil sample by weighing before and after drying the sample in a ventilated oven at 105°C. The loss of weight is expressed as a percentage of the final or “dry weight”.

---

### 4.3.3 Mixed soils (sand with clay, sand with silt)

The method referred to in “Cohesive Soils” may be applied to the testing of mixed or combined soils.

---

### 4.3.4 Rock

The resistance to drilling is a good indication of strata material strength. Where possible, especially during the exploration of virgin territory, samples of rock should be obtained for analysis.

---

### 4.3.5 Geophysical methods of site investigation

Information produced as a result of this type of survey should be used only to supplement borehole sampling. It should not be regarded as an alternative method to site investigation.

## Earth and water pressure

### 4.3.6 Chemical analysis

The destructive influence of natural deposits and buried waste or industrial effluent should be fully investigated during soil sampling and testing. Examination will reveal the suitability of the anti-corrosion measures referred to in Chapter 3, or the need for special precautionary measures.

When sealants are to be used in the pile interlocks, and where tests indicate aggressive compounds within the groundwater, for example in landfill sites, the suitability of the sealant product should be checked. Further information and advice on sample testing may be obtained from the ArcelorMittal brochure 'The Impervious Steel Sheet Pile Wall – Practical Aspects'.

---

**4.3.7 Seepage water** The effect which water has on the engineering properties of a soil must be clearly understood and carefully considered during the site investigation period. In addition to the tests on individual soil samples, the direction of seepage, upwards and downwards, should be determined before any decision is reached on the design of a piling system.

---

### 4.4 Information required for the design of steel sheet pile retaining walls and cofferdams

Having determined the precise nature of the ground within the site and ascertained the individual soil properties, it is desirable to release certain basic information to the piling designer to ensure the best possible arrangement in terms of strength and economy.

The minimum details should include the following:

- Copies of relevant site drawings showing the projected retaining wall/cofferdam areas and the proximity of roads, rail or crane tracks, buildings, embankments, viaducts and waterways.
- Information regarding any underground workings, surface traffic loadings, capital plant or heavy machinery which could be affected by piling operations or in turn, affect ground stability by vibration.
- Copies of actual borehole logs, soil analyses and test reports.
- Details of any faults or fissures encountered during drilling.
- Details of seasonal rainfalls, standing water levels, tidal waters and the depths of off-shore reaches. Stream and river velocities, currents etc, should be given where possible.

# Earth and water pressure

## 4.5 Typical soil properties

Table 4.5 Typical Moderately Conservative Soil Properties

Soil	Loose		Compacted		Loose or Compacted		Angle of Internal Friction		Undrained Shear Strength $S_u$ kN/m <sup>2</sup>
	Bulk Density	Bulk "Weight Density"	Bulk Density	Bulk "Weight Density"	Submerged Density	Submerged "Weight Density"	Loose $\phi'$	Compacted $\phi'$	
	kg/m <sup>3</sup>	kN/m <sup>3</sup>	kg/m <sup>3</sup>	kN/m <sup>3</sup>	kg/m <sup>3</sup>	kN/m <sup>3</sup>	Degrees	Degrees	
Fine Sand	1750	17.2	1900	18.6	1050	10.3	30	35	0
Coarse Sand	1700	16.7	1850	18.2	1050	10.3	35	40	0
Gravel	1600	15.7	1750	17.2	1050	10.3	35	40	0
Brick Hardcore	1300	12.8	1750	17.2	800	7.9	40	45	0
Quarry Waste	1500	14.7	1750	17.2	1000	9.8	40	45	0
Rock Filling	1500	14.7	1750	17.2	1000	9.8	40	45	0
Slag Filling	1200	11.8	1500	14.7	900	8.8	30	35	0
Ashes	650	6.4	1000	9.8	400	3.9	35	40	0
Peat	-	-	1300	12.8	300	3.0	-	5	5
River Mud	1450	14.2	1750	17.2	1000	9.8	-	5	5
Loamy Soil	1600	15.7	2000	19.6	1000	9.8	-	10	10
Silt	-	-	1800	17.7	800	7.9	-	10	10
Sandy Clay	-	-	1900	18.6	900	8.8	-	0	15 to 40
Very Soft Clay	-	-	1900	18.6	900	8.8	-	0	<20
Soft Clay	-	-	1900	18.6	900	8.8	-	0	20 to 40
Firm Clay	-	-	2000	19.6	1000	9.8	-	0	40 to 75
Stiff Clay	-	-	2100	20.6	1100	10.8	-	0	75 to 150
Very Stiff Clay	-	-	2200	21.6	1200	11.8	-	0	>150

NOTE: Soil properties should normally be obtained from ground investigation wherever possible.

## 4.6 Earth pressure calculation

### Calculation of Earth Pressures using Limit State Design

Current standards and codes of practice used in the design of embedded retaining walls favour limit state design philosophy. The limit states to consider are the Ultimate Limit State (ULS), which represents the state at which failure of all or part of the wall occurs, and the Serviceability Limit State (SLS), which represents the state, short of failure, beyond which specific service performance requirements are no longer met.

It is important from the outset that the designer establishes the performance criteria of the wall, as this will assist in determining

## Earth and water pressure

which limit state will govern the design, and then demonstrate that the ultimate or serviceability limit state will not be exceeded over the design life of the wall.

It is generally recognised that the loading conditions under ULS are normally more severe than the SLS condition, however there are cases, (for example in the design and construction of urban basements), when SLS conditions (wall deflections, associated ground movements, watertightness etc.), are just as critical as the structural integrity of the wall in the ULS condition.

In limit state design calculations it is usual practice to apply a mobilisation/partial factor to the principal uncertainties, which in geotechnical design tends to be soil strength. A direct adjustment on the other hand, is normally made to any uncertainties in groundwater pressure, excavation depth and ground levels etc.

Application of a mobilisation factor to soil strength is often referred to as the Factor on Strength method, and is incorporated in many of the established codes of practice. The value of the factor used is dependent on the standard/code of practice adopted, whether the design case is that of ULS or SLS, the soil strength parameter under review and also whether the soil parameters are moderately conservative or worst credible values.

Moderately conservative values are generally defined as being a cautious best estimate. They are considered to be equivalent to characteristic values as defined by EC7(1994) or representative values as defined in the United Kingdom Standard BS8002 (1994). Worst credible values on the other hand are the worst case values that the designer believes might occur or values that are considered unlikely, in practice

Generally, for ULS calculations, a factor of safety greater than 1.0 is applied to moderately conservative soil strength parameters, or  $F_s=1.0$  if using worst credible values. The more onerous of these two sets of parameters is then used for the ULS design. With SLS calculations, moderately conservative soil strength parameters are used with  $F_s=1.0$ .

For the ULS design examples in this handbook, representative moderately conservative soil values have been used. The mobilisation factors used are those shown in section 4.7 (Short term, total stress analysis) and section 4.8 (Long term effective stress analysis).

The factored design soil strength parameters are used to determine the earth pressure coefficients that increase the earth pressures on the retained side and reduce the earth pressures on the restraining side as the mobilisation factor increases above unity.

The pressure applied to a vertical wall, when the ground surfaces are horizontal are calculated as follows

$$\text{Active pressure} = p_a = \gamma \cdot z \cdot \tan^2(45 - \frac{\theta}{2}) - 2 \cdot s_u \cdot \tan(45 - \frac{\theta}{2})$$

$$\text{Passive Pressure} = p_p = \gamma \cdot z \cdot \tan^2(45 + \frac{\theta}{2}) + 2 \cdot s_u \cdot \tan(45 + \frac{\theta}{2})$$

The terms

$$\tan^2(45 - \frac{\theta}{2}) \text{ and } \tan^2(45 + \frac{\theta}{2})$$

can be more conveniently referred to as  $K_a$  coefficient of active earth pressure and  $K_p$  coefficient of passive pressure respectively.

$$\text{Hence } p_a = K_a \gamma \cdot z - 2 \cdot s_u \cdot \sqrt{K_a}$$

$$\text{and } p_p = K_p \gamma \cdot z + 2 \cdot s_u \cdot \sqrt{K_p}$$

The above expressions however do not allow for the effects of friction and adhesion between the earth and the wall. They are based on extensions of the Rankine Equation (by the addition of cohesion), from 'Earth Pressures' – A.L. Bell: Proceedings of the Institute of Civil Engineers, Vol. 199 - 1915.

Subsequent research has further developed these formulae to allow for the effects of wall friction, wall adhesion etc on the earth pressure coefficients. These are shown in 4.7 and 4.8 of this chapter.

The above formulae represent the total stress condition. For effective stress the undrained shear strength parameter of the soil ( $s_u$ ) is simply replaced by the effective cohesion value of the soil,  $c'$ .

#### 4.7 Short term, total stress analysis

The short term total stress condition represents the state in the soil before the pore water pressures have had time to dissipate i.e. immediately after construction in a cohesive soil. The initial (total stress) parameters are derived from undrained triaxial tests – section 4.3.2.

For total stress the horizontal active and passive pressures are calculated using the following equations :

$$p_a = K_a (\gamma \cdot z + q) - s_u K_{ac}$$

$$p_p = K_p (\gamma \cdot z + q) + s_u K_{pc}$$

where

$(\gamma \cdot z + q)$  represents the total overburden pressure

$K_a = K_p = 1.0$  for cohesive soils.

## Earth and water pressure

Design  $S_u = S_{ud} = S_{umc} / F_{ssu}$  where  $F_{ssu}$  is typically 1.5.

The earth pressure coefficients,  $K_{ac}$  and  $K_{pc}$ , make an allowance for wall /soil adhesion and are derived as follows :

$$K_{ac} = K_{pc} = 2 \cdot \sqrt{1 + \frac{S_{w \max}}{S_{ud}}}$$

The limiting value of wall adhesion  $S_{w \max}$  at the soil/sheet pile interface is generally taken to be smaller than the design undrained shear strength of the soil,  $S_{ud}$ , by a factor of 2 for stiff clays. i.e.  $S_{w \max} = \alpha \times S_{ud}$ , where  $\alpha = 0.5$ . Lower values of wall adhesion, however, may be realised in soft clays.

A range of  $\alpha$  values and corresponding  $K_{ac}$  and  $K_{pc}$  values are shown in Table 4.7.1.

Table 4.7.1

$\alpha = \frac{S_{w \max}}{S_{ud}}$	Values of $K_{ac}$ and $K_{pc}$
0.00	2.00
0.25	2.24
0.50	2.45

In any case, the designer should refer to the design code they are working to for advice on the maximum value of wall adhesion they may use.

---

### 4.8 Long term, effective stress analysis

The long term effective stress condition represents the state when all the excess pore water pressures, within the soil mass, have dissipated. i.e. the drained state.

Cohesionless soils are free draining, therefore excess pore water pressures created during construction, will dissipate so quickly that “effective stress” conditions exist in both the short and long term. Hence  $\sigma'$  is used throughout.

In cohesive soils, the change from total stress (undrained conditions) to effective stress (drained conditions) generally occurs over a much longer period of time. The exception being the presence/addition of fine silts/granular material which can greatly reduce the time in which effective stress conditions are reached. During this period the strength parameters of the cohesive soil may change significantly due to pore water pressures changes induced following construction of a retaining structure. The change in strength is caused by equalisation of negative pore water pressure

in the soil and results in reduced values of cohesion  $c'$  but increased values of angle of internal friction ( $\phi'$ ).

Whilst all cohesive soils are subject to these changes, the effective stress condition is not usually critical when fine silts and naturally consolidated and slightly over consolidated clays, ie those with cohesion values of less than about  $40\text{kN/m}^2$ , are involved, since the change from effective parameters gives an overall increase in soil strength. However, the reverse is true for over-consolidated clays, ie those with undrained values in excess of about  $40\text{kN/m}^2$ . The overall strength will, in most cases, be reduced as the stress condition changes from total to effective because the loss of substantial cohesive strength is not compensated adequately by the increasing angle of internal friction. Hence it is advised that for cohesive soils both short and long term stress analyses be carried out to determine the more onerous design case.

For effective stress analysis the horizontal active and passive pressures are calculated using the following equations :

$$p'_a = K_a(\gamma z - u + q) - c'_d K_{ac}$$

$$p'_p = K_p(\gamma z - u + q) + c'_d K_{pc}$$

where:

$\gamma z - u + q$  represents the effective overburden pressure  
 design  $c' = c'_d = c'_{mc} / F_{sc'}$  where  $F_{sc'}$  is typically 1.2,  
 and  $K_a$ ,  $K_p$ ,  $K_{ac}$  and  $K_{pc}$  are the coefficients of lateral earth pressure.

The effects of wall friction on active and passive pressures are taken into account by using modified values of  $K_a$  and  $K_p$  and substituting  $K_{ac}$  and  $K_{pc}$  for the terms  $2 \cdot \sqrt{K_a}$  and  $2 \cdot \sqrt{K_p}$  respectively. It is usual to assume no wall adhesion in effective stress analysis and hence this term has been omitted from the formulae.

In determining  $K_a$  and  $K_p$  the limiting value of wall friction,  $\delta_{max}$ , is traditionally taken to be less than the angle of shearing resistance of the soil. This is to allow for variations in roughness at the soil/wall interface and also soil movements associated with the transfer of lateral load to the wall. The designer should refer to the adopted design code to determine whether particular values of wall friction are specified but care is also required to ensure that the sign conventions in the code are obeyed. Positive values of  $\delta$  are usually used for active pressures (resultant acting downwards) and negative values for passive pressures (resulting acting upwards).



## Earth and water pressure

For examples in this Handbook the limiting value of wall friction is taken to be  $\delta_{\max} = \pm 2/3\sigma'_d$  on the active and passive sides of the wall.

Generally, wall friction is beneficial to the stability of the wall by reducing the value of  $K_a$  on the retained side, and increasing  $K_p$  in the soil in front of the wall. This is based on the assumption that the soil behind the wall (i.e. on the retained side) moves downwards relative to the wall, and heaves upwards in front of the wall (passive side) as the wall takes up the lateral loading from the ground. There are instances however, when the direction of soil movement in front or behind the wall may not be beneficial to wall stability - as is normally assumed. For example, load bearing piles, where the pile may move downwards relative to the soil on both sides, or an activity such as dewatering / tunnelling which may cause the soil at the front of the wall to settle. In such cases the direction of the angle of wall friction may change, resulting in much higher active earth pressure coefficients and much lower passive earth pressure coefficients, hence the need for care when selecting appropriate wall friction values.

Values of  $K_a$  and  $K_p$  are given in tables 4.8.1 and 4.8.2. The design angle of shearing resistance  $\sigma'_d$  is determined as follows :

Design  $\sigma' = \sigma'_d = \tan^{-1} (\tan \sigma'_{mc} / F_{s\sigma'})$  where  $F_{s\sigma'}$  is typically 1.2.

Table 4.8.1 Values of  $K_a$

Values of $\sigma'_{mc}$ (°)	Values of $\sigma'_d$ (°)	Values of $\delta$		
		0	$1/2 \sigma'_d$	$2/3 \sigma'_d$
0.00	0.00	1.000	1.000	1.000
5.00	4.17	0.864	0.842	0.837
10.00	8.36	0.746	0.710	0.702
15.00	12.59	0.642	0.599	0.590
20.00	16.87	0.550	0.504	0.494
25.00	21.24	0.468	0.423	0.413
30.00	25.69	0.395	0.352	0.343
35.00	30.26	0.330	0.291	0.282
40.00	34.96	0.271	0.238	0.229
45.00	39.81	0.219	0.191	0.184

Table 4.8.2 Values of  $K_p$

Values of $\delta'_{mc}$ (°)	Values of $\delta'_d$ (°)	Values of $\delta$		
		0	$-1/2 \delta'_d$	$-2/3 \delta'_d$
0.00	0.00	1.000	1.000	1.000
5.00	4.17	1.157	1.193	1.200
10.00	8.36	1.340	1.431	1.451
15.00	12.59	1.557	1.732	1.772
20.00	16.87	1.818	2.122	2.193
25.00	21.24	2.136	2.638	2.761
30.00	25.69	2.531	3.347	3.554
35.00	30.26	3.032	4.356	4.712
40.00	34.96	3.684	5.864	6.493
45.00	39.81	4.558	8.256	9.421

The above tables represent earth pressure coefficients where the ground surface behind the wall is horizontal. The values of  $K_a$  and  $K_p$  are derived using equations from EC7 (1995) Annex G. For sloping surfaces, and for differing values of wall friction the reader may wish to refer to the adopted code of practice or, Appendix A6 of the CIRIA C580 publication “Embedded retaining walls – guidance for economic design”

The total effective horizontal active and passive earth pressures acting against the wall are then determined by :

$$p'_{a \text{ (total)}} = p'_{a} + u$$

and

$$p'_{p \text{ (total)}} = p'_{p} + u$$

where  $u$  is the pore water pressure.

## 4.9 Tension crack

At small depths in cohesive soils or when the soil possesses high undrained cohesion, it may be found that the calculated active pressure has a negative value. Although this implies that the soil is in tension, the situation in fact represents zero pressure and the depth over which it occurs is referred to as a tension crack. In any cohesive soil, the theoretical depth to which a tension crack can develop is given by the expression

$$\text{depth} = (2 \times s_u - q) / \gamma$$

## Earth and water pressure

where  $s_u$  is the undrained shear strength of the soil,

$q$  is any applied surcharge,

and  $\gamma$  is the density of the soil.

When a tension crack is able to develop, careful consideration of the water regime in the vicinity of the wall is needed to ensure that appropriate design pressures are adopted. If the crack could fill up with water to either the normal ground water level or the soil surface then hydrostatic pressures should be adopted from the appropriate elevation. If it is considered unlikely that ground water could enter the crack it is recommended that a minimum effective fluid pressure (MEFP) equivalent to that of a fluid with a density of  $5\text{kN/m}^3$  is applied.

The fluid pressure, either hydrostatic or MEFP, should be applied to the wall to the depth at which the calculated soil and water pressures dominate.

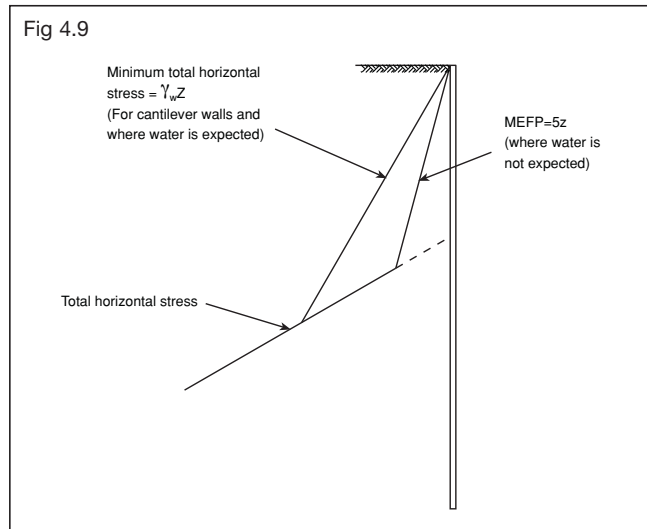

### 4.10 Groundwater pressures

When considering the effects of water pressure for Ultimate Limit State Design (ULS), the water pressure and seepage forces assumed should be the most unfavourable values which may occur in extreme or accidental circumstances over the wall's construction sequence and throughout its design life. An example of an extreme/accidental event being a burst water main in close proximity to the wall.

For Serviceability State Calculations (SLS) the water pressures and seepage forces should be those that occur in 'normal'

circumstances over the wall's construction sequence and throughout its design life. Extreme/accidental events such as a burst water pipe may be excluded, unless the designer considers that in reasonable circumstances such an event may occur.

---

#### 4.11 Permanent structures

The critical design condition for permanent structures in fine silts, normally and slightly over-consolidated clays, will usually be that using total stress parameters, although a check with the alternative effective values may be advisable.

The critical design condition for permanent structures in over-consolidated clays will usually be with effective stress parameters, but a check using total values may be advisable.

---

#### 4.12 Temporary structures

When the anticipated life of the structure is less than three months, and when construction is in clay, it is usual to adopt total stress parameters for the design. However, this assumption carries significant risk and therefore the designer should, if possible, ensure regular monitoring of the works to check that the design assumptions are realised in practice. Where the designer has no direct control over construction activities then it is advisable that the designer also considers the use of long term, effective stress parameters for the design. In any case, contingency measures should also be on hand in case of any untoward changes during the temporary phase.

An allowance in the design should also be made for softening of the soil on the restraining side of the wall for the duration of the temporary works. i.e. due to excavation disturbance and dissipation of pore water pressures at excavation level. The value of the undrained shear strength on the restraining side should be assumed to be zero at excavation level rising to  $s_u$  at a depth of  $L$ , where :

$L = 0.5 \text{ m}$  where there is no potential for groundwater recharge either at excavation level or within the soil

$L = \sqrt{(12 \cdot c_v \cdot t)}$  where recharge occurs at excavation level but with no recharge within the soil.  $c_v$  is the coefficient of consolidation and  $t$  is the time elapsed.

Temporary structures of greater than three months anticipated life should be treated as permanent structures.

# Earth and water pressure

## 4.13 Battered walls

The effect of batters up to 5° may be neglected.

## 4.14 Concentrated and linear surcharge

These are treated in a similar manner to superimposed loads except that allowance should be made for dissipation of the load at increasing depth.

There are various methods of allowing for this dissipation and the following is suggested by Krey when designing for cohesionless soils.

The maximum increase in horizontal total stress is given by :

$$(\sigma_{h \max}) = \frac{4q \cdot \tan^2(45^\circ - \phi'/2)}{2 + (1 + \tan^2(45^\circ - \phi'/2)) \cdot x/z}$$

where  $q$  = magnitude of surcharge (kN/m<sup>2</sup>)

$$a = x \cdot \tan \phi'$$

$$c = x / \tan(45^\circ - \phi'/2)$$

$$d = z / \tan(45^\circ - \phi'/2)$$

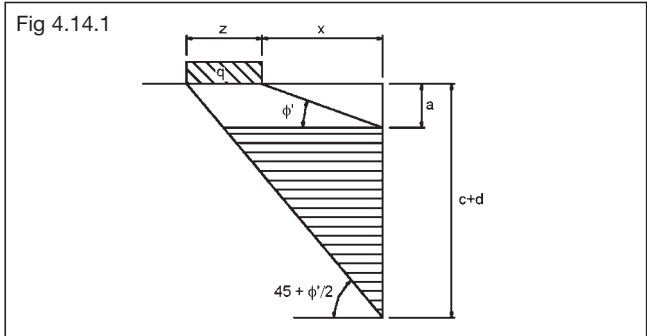

#### 4.15 Sloping ground surface

Approximate pressures can be obtained by assuming a horizontal surface and increasing the pressures thus obtained by 5% for each 5° inclination above the horizontal.

Alternatively an arbitrary horizontal ground surface, at some level above that at which the sloping surface intersects the wall may be assumed.

When dealing with cohesionless soils the following method may be adopted.

$$p_a \text{ at A} = 0.K_a$$

$$p_a \text{ at B} = \gamma.h_1.K_a$$

$$p_a \text{ at C} = \gamma.h_2.K_a$$

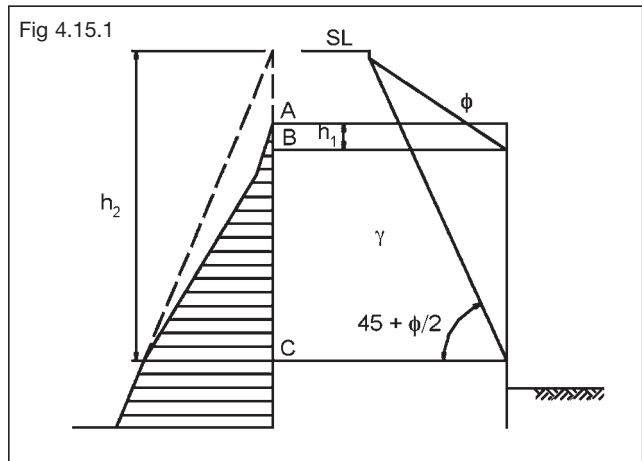

#### 4.16 Earth pressure calculation

In this section a set of design earth pressures for use in Ultimate Limit State checks have been produced for the total stress and effective stress condition. The method of calculation corresponds to that discussed in paragraphs 4.6 to 4.8. i.e. using moderately conservative soil parameters with  $F_s$  values of 1.2 applied to effective stress parameters  $c'$  and  $\phi'$  and an  $F_s$  of 1.5 on the total stress parameter  $s_u$ .

An assessment of the stress in the soil at any change of circumstance, i.e. stratum boundary, water level, formation/excavation level etc is carried out at for both sides of the wall.

For total stress analysis, cohesive strata are assumed to be impervious and the bulk weight density should be used in calculations.

## Earth and water pressure

The earth pressure coefficients,  $K_a$  and  $K_p$  used for both total and effective stress analyses are obtained from tables 4.8.1 and 4.8.2.

Values of  $K_{ac}$  and  $K_{pc}$  for cohesive layers in the total stress analysis are taken from table 4.7.1, assuming  $\alpha = 0.50$ .

Table 4.16.1 - Total Stress Analysis

	Values of $K_a$ , $K_{ac}$ , $K_p$ , $K_{pc}$			
	$K_a$	$K_{ac}$	$K_p$	$K_{pc}$
Loose Fine Sand	0.317		3.963	
Soft Clay	1.000	2.450	1.000	2.450
Sand and Gravel	0.229		6.493	
Firm Clay	1.000	2.450	1.000	2.450

Table 4.16.2 - Effective Stress Analysis

	Values of $K_a$ , $K_{ac}$ , $K_p$ , $K_{pc}$			
	$K_a$	$K_{ac}$	$K_p$	$K_{pc}$
Loose Fine Sand	0.317		3.963	
Soft Clay	0.494	1.406	2.193	2.962
Sand and Gravel	0.229		6.493	
Firm Clay	0.444	1.333	2.512	3.170

\*For the above earth pressure coefficients it is assumed that on both the active and passive sides of the wall, wall/soil friction

$$\delta = \pm \frac{2}{3} \phi'_d$$

# Earth and water pressure

Fig 4.16.1 Total Stress Analysis Example

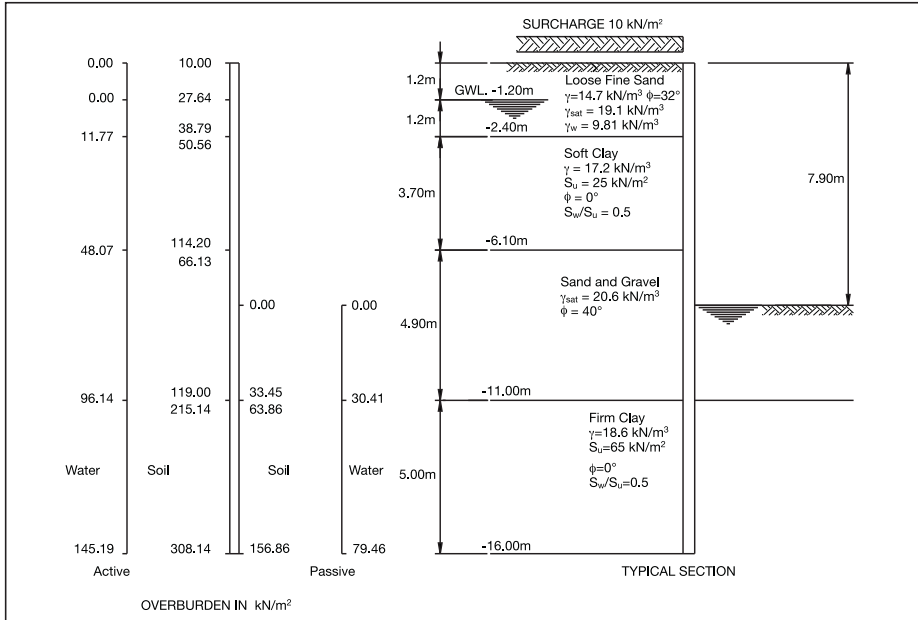

## Earth and water pressures : Total stress analysis (short term)

### Soil overburden including effects of water pressure and buoyancy : Active Side

Overburden at ground level		= 10.00 KN/m <sup>2</sup>
Overburden at -1.2m level in loose fine sand	= (14.70 x 1.20) + 10.00	= 27.64 KN/m <sup>2</sup>
Overburden at -2.4m level in loose fine sand	= (9.29 x 1.20) + 27.64	= 38.79 KN/m <sup>2</sup>
Overburden at -2.4m level in soft clay	= 38.79 + (1.20 x 9.81)	= 50.56 KN/m <sup>2</sup>
Overburden at -6.1m level in soft clay	= (17.20 x 3.70) + 50.56	= 114.20 KN/m <sup>2</sup>
Overburden at -6.1m level in sand and gravel	= 114.20 - (4.90 x 9.81)	= 66.13 KN/m <sup>2</sup>
Overburden at -11.0m level in sand and gravel	= (10.79 x 4.90) + 66.13	= 119.00 KN/m <sup>2</sup>
Overburden at -11.0m level in firm clay	= 119.00 + (9.80 x 9.81)	= 215.14 KN/m <sup>2</sup>
Overburden at -16.0m level in firm clay	= (18.60 x 5.00) + 215.14	= 308.14 KN/m <sup>2</sup>

### Soil overburden including effects of water pressure and buoyancy : Passive Side

Overburden at -7.9m level		= 0.00 KN/m <sup>2</sup>
Overburden at -11.0m level in sand and gravel	= (10.79 x 3.10)	= 33.45 KN/m <sup>2</sup>
Overburden at -11.0m level in firm clay	= 33.45 + (3.10 x 9.81)	= 63.86 KN/m <sup>2</sup>
Overburden at -16.0m level in firm clay	= (18.60 x 5.00) + 63.86	= 156.86 KN/m <sup>2</sup>



# Earth and water pressure

## Earth pressures

### Active side

$p_a$ at ground level	$= 0.317 \times 10$	$= 3.17 \text{ KN/m}^2$
$p_a$ at -1.2m level in loose fine sand	$= 0.317 \times 27.64$	$= 8.76 \text{ KN/m}^2$
$p_a$ at -2.4m level in loose fine sand	$= (0.317 \times 38.79) + 11.77$	$= 24.07 \text{ KN/m}^2$
$p_a$ at -2.4m level in soft clay	$= (1.00 \times 50.56) - (2.45 \times 25/1.5)$	$= 9.73 \text{ KN/m}^2$
$p_a$ at -6.1m level in soft clay	$= (1.00 \times 114.20) - (2.45 \times 25/1.5)$	$= 73.37 \text{ KN/m}^2$
$p_a$ at -6.1m level in sand and gravel	$= (0.229 \times 66.13) + 48.07$	$= 63.21 \text{ KN/m}^2$
$p_a$ at -11.0m level in sand and gravel	$= (0.229 \times 119.00) + 96.14$	$= 123.39 \text{ KN/m}^2$
$p_a$ at -11.0m level in firm clay	$= (1.00 \times 215.14) - (2.45 \times 65/1.5)$	$= 108.97 \text{ KN/m}^2$
$p_a$ at -16.0m level in firm clay	$= (1.00 \times 308.14) - (2.45 \times 65/1.5)$	$= 201.97 \text{ KN/m}^2$

### Passive side

$p_p$ at -7.9m level	$= 0 \times 6.493$	$= 0.00 \text{ KN/m}^2$
$p_p$ at -11.0m level in sand and gravel	$= (6.493 \times 33.45) + 30.41$	$= 247.60 \text{ KN/m}^2$
$p_p$ at -11.0m level in firm clay	$= (1.00 \times 63.86) + (2.45 \times 65/1.5)$	$= 170.03 \text{ KN/m}^2$
$p_p$ at -16.0m level in firm clay	$= (1.00 \times 156.86) + (2.45 \times 65/1.5)$	$= 263.03 \text{ KN/m}^2$

# Earth and water pressure

Fig 4.16.2 Total Stress Diagrams

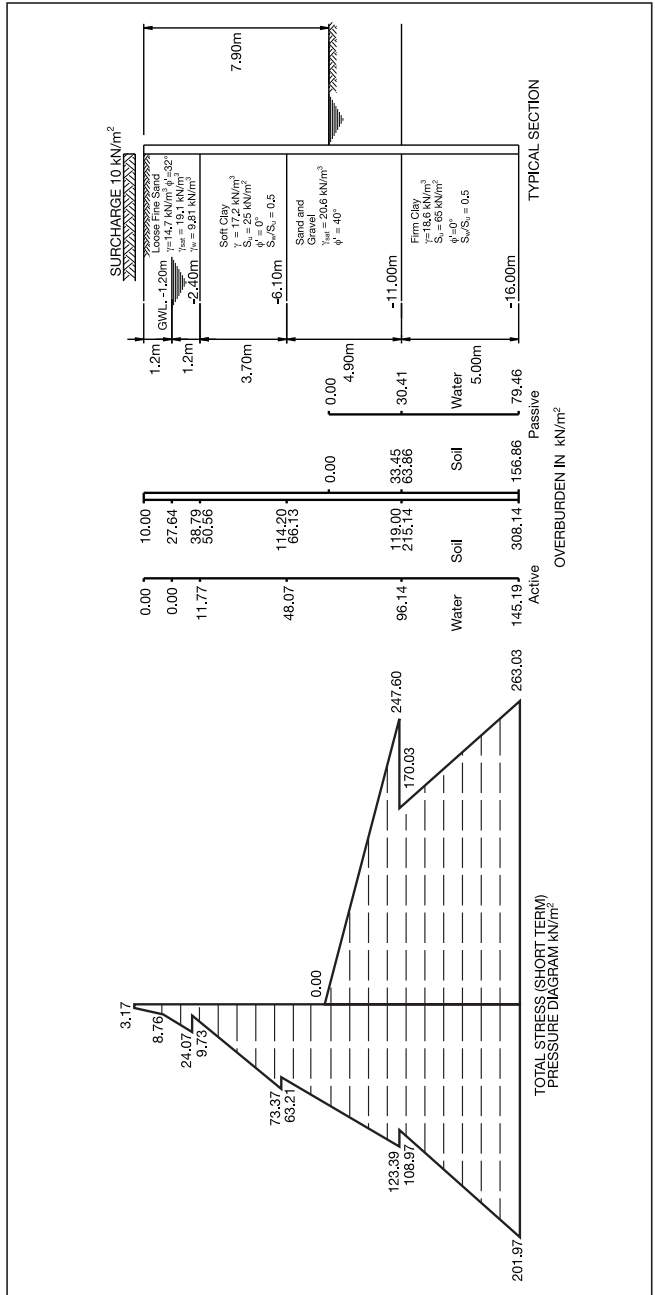

# Earth and water pressure

Fig 4.16.3 Effective Stress Analysis Example

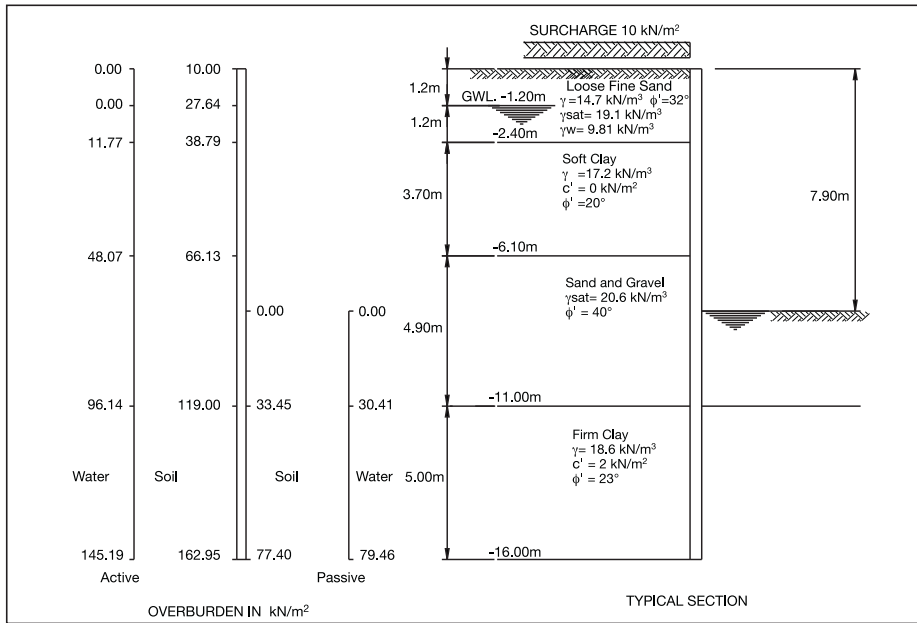

## Effective stress analysis (long term)

### Soil overburden including effects of water pressure and buoyancy : Active side

Overburden at ground level	=	10.00 KN/m <sup>2</sup>
Overburden at -1.2m level in loose fine sand	= (14.70 x 1.20) + 10.00	= 27.64 KN/m <sup>2</sup>
Overburden at -2.4m level in loose fine sand	= (9.29 x 1.20) + 27.64	= 38.79 KN/m <sup>2</sup>
Overburden at -2.4m level in soft clay	=	38.79 KN/m <sup>2</sup>
Overburden at -6.1m level in soft clay	= (7.39 x 3.70) + 38.79	= 66.13 KN/m <sup>2</sup>
Overburden at -6.1m level in sand and gravel	=	66.13 KN/m <sup>2</sup>
Overburden at -11.0m level in sand and gravel	= (10.79 x 4.90) + 66.13	= 119.00 KN/m <sup>2</sup>
Overburden at -11.0m level in firm clay	=	119.00 KN/m <sup>2</sup>
Overburden at -16.0m level in firm clay	= (8.79 x 5.00) + 119.00	= 162.95 KN/m <sup>2</sup>

### Soil overburden including effects of water pressure and buoyancy : Passive side

Overburden at -7.9m level	=	0.00 KN/m <sup>2</sup>
Overburden at -11.0m level in sand and gravel	= (10.79 x 3.10)	= 33.45 KN/m <sup>2</sup>
Overburden at -11.0m level in firm clay	=	33.45 KN/m <sup>2</sup>
Overburden at -16.0m level in firm clay	= (8.79 x 5.00) + 33.45	= 77.40 KN/m <sup>2</sup>

# Earth and water pressure

## Earth pressures

### Active side

$p'_a$ at ground level	= $0.317 \times 10$	= 3.17 KN/m <sup>2</sup>
$p'_a$ at -1.2m level in loose fine sand	= $0.317 \times 27.64$	= 8.76 KN/m <sup>2</sup>
$p'_a$ at -2.4m level in loose fine sand	= $(0.317 \times 38.79) + 11.77$	= 24.07 KN/m <sup>2</sup>
$p'_a$ at -2.4m level in soft clay	= $(0.494 \times 38.79) + 11.77$	= 30.93 KN/m <sup>2</sup>
$p'_a$ at -6.1m level in soft clay	= $(0.494 \times 66.13) + 48.07$	= 80.74 KN/m <sup>2</sup>
$p'_a$ at -6.1m level in sand and gravel	= $(0.229 \times 66.13) + 48.07$	= 63.21 KN/m <sup>2</sup>
$p'_a$ at -11.0m level in sand and gravel	= $(0.229 \times 119.00) + 96.14$	= 123.39 KN/m <sup>2</sup>
$p'_a$ at -11.0m level in firm clay	= $(0.444 \times 119.00) - (1.333 \times 2/1.2) + 96.14$	= 146.75 KN/m <sup>2</sup>
$p'_a$ at -16.0m level in firm clay	= $(0.444 \times 162.95) - (1.333 \times 2/1.2) + 145.19$	= 215.32 KN/m <sup>2</sup>

### Passive side

$p'_p$ at -7.9m level	= $0 \times 6.493$	= 0.00 KN/m <sup>2</sup>
$p'_p$ at -11.0m level in sand and gravel	= $(6.493 \times 33.45) + 30.41$	= 247.60 KN/m <sup>2</sup>
$p'_p$ at -11.0m level in firm clay	= $(2.512 \times 33.45) + (3.170 \times 2/1.2) + 30.41$	= 119.72 KN/m <sup>2</sup>
$p'_p$ at -16.0m level in firm clay	= $(2.512 \times 77.40) + (3.170 \times 2/1.2) + 79.46$	= 279.17 KN/m <sup>2</sup>

# Earth and water pressure

Fig 4.16.4 Effective Stress Diagrams

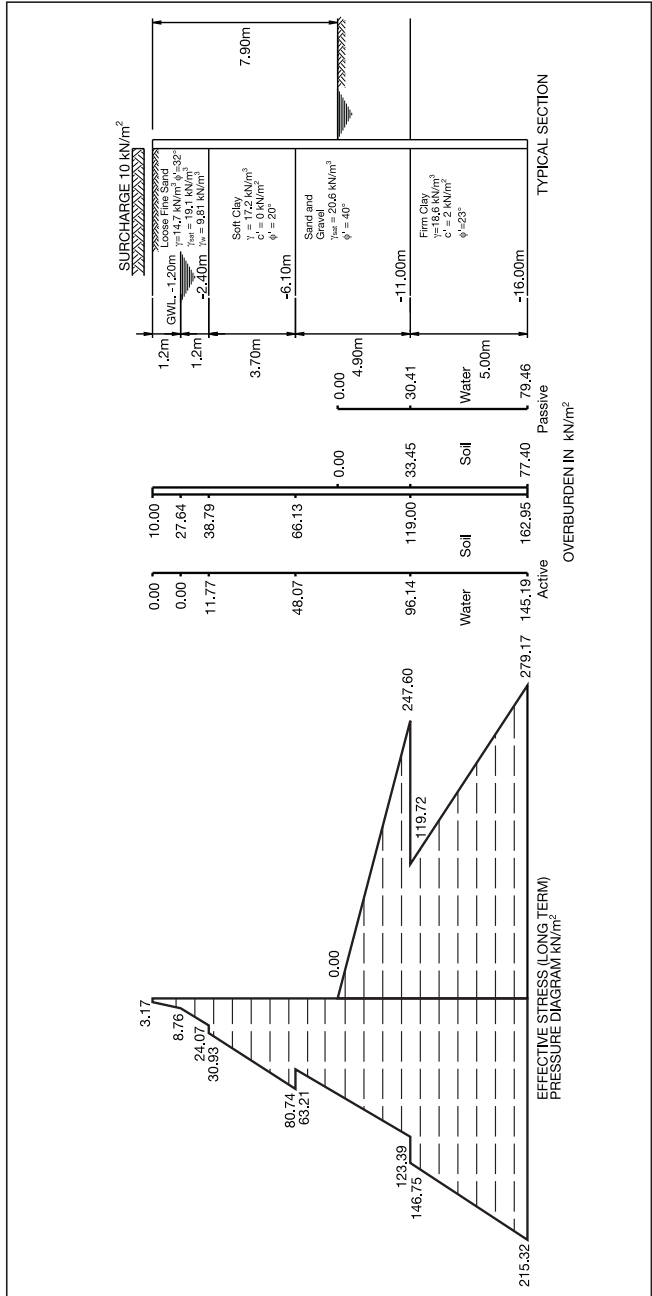

## Earth and water pressure

It is clear from the pressure diagrams, Figures 4.16.2 and 4.16.4, that the active earth pressures generated in the soft/firm clays are considerably greater for the effective stress condition than those produced in the total stress analyses. Also on the passive side, the pressures which provide stability in the effective stress condition are significantly less than for the total stress condition. Clearly in this case the most onerous condition is the effective stress case which should be used for any permanent works design. The earth pressures calculated for the short term condition may be used for temporary construction, but designers should always satisfy themselves that total stress conditions will exist throughout the temporary phase. If in doubt designers should always err on the side of caution and use the worst case earth pressure values.

The methods by which earth pressure diagrams are used to design the embedment depth and minimum structural requirements of a sheet pile structure are illustrated in chapters 6 and 7.



ArcelorMittal

- 1** Product information
- 2** Sealants
- 3** Durability
- 4** Earth and water pressure
- 5** Design of sheet pile structures
- 6** Retaining walls
- 7** Cofferdams
- 8** Charts for retaining walls
- 9** Circular cell construction design & installation
- 10** Bearing piles and axially loaded sheet piles
- 11** Installation of sheet piles
- 12** Noise and vibration from piling operations
- 13** Useful information

# Design of sheet pile structures

Contents	Page
<b>5.1 Introduction</b>	1
<b>5.2 Types of wall</b>	1
<b>5.3 General considerations</b>	3
<b>5.4 Selection of design method</b>	5
<b>5.5 Factor of safety</b>	5
<b>5.6 Limit state designs</b>	8
<b>5.7 Free or fixed earth design</b>	8
<b>5.8 Dealing with water</b>	10
5.8.1 Flow nets	11
<b>5.9 Surcharge loading</b>	11
<b>5.10 Support location</b>	11
<b>5.11 Walls supported by more than one level of struts or ties</b>	12
5.11.1 Hinge method	12
5.11.2 Continuous beam method	12
<b>5.12 Softened zone</b>	13
<b>5.13 Bending moment reduction</b>	14
<b>5.14 Calculating support forces</b>	14
<b>5.15 Structural design of wall</b>	15
<b>5.16 Selection of pile section</b>	16
<b>5.17 Design bending stresses</b>	16
<b>5.18 Checklist of design input parameters</b>	17
5.18.1 ULS conditions	17
5.18.2 SLS conditions	17
<b>5.19 Analysis of pressure diagrams</b>	19



# Design of sheet pile structures



# Design of sheet pile structures

## 5.1 Introduction

A sheet pile retaining wall has a significant portion of its structure embedded in the soil and a very complex soil/structure interaction exists as the soil not only loads the upper parts of the wall but also provides support to the embedded portion.

Current design methods for retaining walls do not provide a rigorous theoretical analysis due to the complexity of the problem. The methods that have been developed to overcome this, with the exception of finite element modelling techniques, introduce empirical or empirically based factors that enable an acceptable solution to the problem to be found. As a result, no theoretically correct solution can be achieved and a large number of different approaches to this problem have been devised.

The design of a retaining structure using currently available techniques requires the performance of two sets of calculations, one to determine the geometry of the structure to achieve equilibrium under the design conditions, the other to determine the structural requirements of the wall to resist bending moments and shear forces determined from the equilibrium calculations. The selected design conditions should be sufficiently severe and varied so that all reasonable situations which may occur during the life of the structure are taken into account.

Designers should not overlook the possibility of global failure resulting from deep-seated slip failure of the soil and ensure that the slip plane passing through the pile toe is not critical. Similarly, anchor walls should be located outside potential slip planes.

This chapter covers the fundamental issues involved in the design of earth retaining structures and is therefore relevant for retaining walls and cofferdams. Information of specific relevance to retaining wall design is included in chapter 6 and to cofferdams in chapter 7.

---

## 5.2 Types of wall

Retaining walls can be divided into cantilever or supported types. Cantilever walls are dependent solely upon penetration into the soil for their support and clearly fixity of the toe is required to achieve equilibrium of the forces acting on the structure. As fixity of the wall toe requires longer and, in many cases, heavier piles to achieve the necessary penetration into the soil, this type of wall can only be economic for relatively low retained heights. It is also likely that deformations will be large for a cantilever solution.

Variations in soil properties, retained height and water conditions along a wall can have significant effects on the alignment of a cantilever wall and care must be taken when designing them for permanent structures, although provision of a capping beam will often alleviate alignment problems.

## Design of sheet pile structures

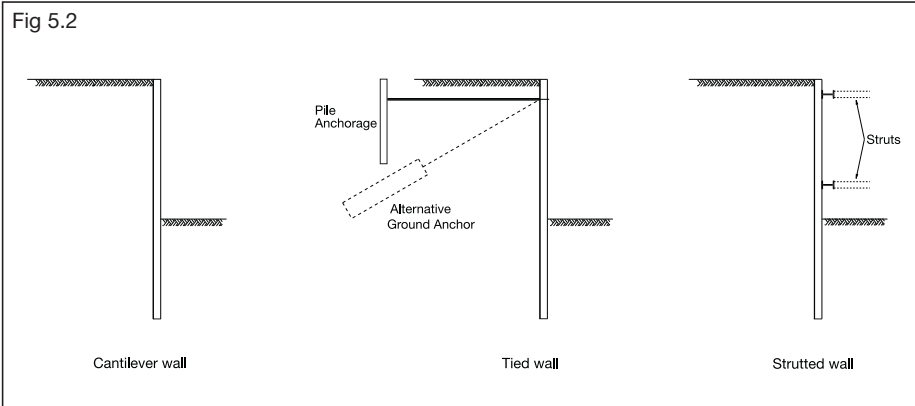

Supported walls, which can be either tied or strutted, achieve stability by sharing the support to be provided between the soil and the supporting member or members. In this situation the soil conditions at the toe of the wall are not as critical to the overall stability of the structure as in the case of a cantilever wall. The provision of longitudinal walings to transfer the soil loadings into ties or struts also caters for variations in displacement along the structure.

The maximum height to which a cantilever wall can be considered to be effective will generally be governed by the acceptable deflection of the wall under load. This comment doesn't just apply to sheet pile walls where the relative flexibility of the wall is often seen as a drawback because the overall deflection of the wall is a combination of bending of the wall structure and movement in the soil which will occur irrespective of the type of wall to be built.

However as a rough guide, it is unlikely that a cantilever wall will be more cost effective than a tied or propped wall when the retained height exceeds about 4.5 to 5 metres because the pile section needed for an unpropped wall of that height will be both long and heavy to resist the applied bending moments. Similarly a wall supported by a single tie or prop will generally only be cost effective up to a retained height in the order of 10 metres.

When more than one level of supports is used, wall stability becomes a function of the support stiffness and the conventional active/passive earth pressure distribution does not necessarily apply.

# Design of sheet pile structures

## 5.3 General considerations

An earth retaining structure must be designed to perform adequately under two particular sets of conditions, those that can be regarded as the worst that could conceivably occur during the life of the structure and those that can be expected under normal service conditions. These design cases represent the ultimate and serviceability limit states respectively for the structure.

Ultimate limit states to be taken into account in design include instability of the structure as a whole including the soil mass, failure of the structure by bending or shear and excessive deformation of the wall or soil to the extent that adjacent structures or services are affected.

Where the mode of failure of the structure involves translation or rotation, as would be expected in the case of a retaining wall, the stable equilibrium of the wall relies on the mobilisation of shear stresses within the soil. Full mobilisation of soil shear strength results in limiting active and passive conditions and these can only act simultaneously on the structure at the point of collapse, the ultimate limit state.

Design for serviceability involves a consideration of the deformation of the structure and movement of the ground to ensure that acceptable limits are not exceeded. The deformations of the ground which accompany full shear strength mobilisation are large in comparison to those which occur in normal service and as the forces on the structure and the forces from the retained soil are inversely proportional to movement, the serviceability limit state of displacement will often be the governing criterion for equilibrium. Although it is impossible or impractical to directly calculate displacements, serviceability requirements can generally be achieved by limiting the magnitude of the mobilised soil strength. This is achieved in practice by applying factors of safety to the design parameters.

One aspect of design that is often overlooked by inexperienced designers is the advantage to be gained by considering at an early stage in the design process which section will be required for installation as it may be necessary to provide a heavy section and / or a high quality of steel where it is anticipated that piles will need to be driven to significant depth or where driving will be hard. Piles that have been sized for onerous driving conditions will generally have high bending resistance and this additional capacity may permit one or more levels of support to be eliminated with a consequent reduction in design effort.

The designer of a retaining wall must assess the design situations to which the wall could be subjected during its lifetime and apply these to the structure to analyse their effect.

## Design of sheet pile structures

The design situations should include the following where appropriate:

### **Applied loads and any combinations of loadings**

Includes surcharges and externally applied loads on each side of the wall.

The surcharge load acting on a wall will depend on its location and intended usage. In the UK it is suggested that a minimum surcharge of 10 kN/m<sup>2</sup> is adopted on the retained side of the wall, but in other European countries, a surcharge of 20 kN/m<sup>2</sup> is recommended to allow for the presence of plant or materials during construction. This is discussed further in section 5.9.

Where very high levels of surcharge or concentrated loads occur, e.g. ports and harbours, it is often more economical to carry them on bearing piles which transfer them to a lower stratum where no lateral pressure is exerted on the retaining structure.

### **Geometry of the problem**

The basic retained height to be used in calculations will be the difference in level between the highest anticipated ground level on the active side of the wall and the lowest level on the passive. An allowance for unplanned excavation in front of the wall of 10% of the retained height of a cantilever or 10% of the distance below the lowest support in a supported wall up to a maximum of 0.5m should be included in the ultimate limit state calculations. It should be noted that if excavation for pipes or cables in the passive zone is likely then the trench depth is considered to be part of the basic excavation depth and should not be part of the unplanned excavation allowance. The unplanned excavation depth does not apply to serviceability calculations.

### **Material characteristics**

In permanent structures, the long-term performance of steel must be considered and a heavier pile section than that determined by structural analysis may be needed to take into account the long-term effects of corrosion.

### **Environmental effects**

Variations in ground water levels, due to dewatering, flooding or failure of drainage systems need to be taken into account in design. Consider the effects of providing weep holes to prevent the accumulation of ground water behind the wall; however these must be designed to prevent clogging by any fines transported in the flowing water. Scour, erosion and tree removal will all affect the structure. Weathering, freezing and other effects of time and environment on the material properties will also have an effect on structural performance.

### **Mining subsidence**

Consider the tolerance of the structure to deformation.

# Design of sheet pile structures

## Construction

Driving of sheet piles into dense soils may necessitate the provision of a section larger than that needed to satisfy the structural requirements. Driveability should be considered at an early stage in the design process as the need to provide a minimum section for driving may lead to a more efficient support system and may also offset any additional thickness needed to achieve the desired life expectancy for the structure.

---

## 5.4 Selection of design system

Modern computer software packages provide the engineer with the opportunity to carry out a simple limit equilibrium design, a more complex soil-structure interaction calculation or a sophisticated finite element analysis. As the complexity of the analysis method rises, the amount and complexity of data also increases and the analysis method should therefore be selected to suit the sophistication of the structure and to ensure that any economies deriving from a more complex analysis can be realised.

When the structure is such that there will be little or no stress redistribution, as can be expected for a cantilever wall, limit equilibrium calculations and soil-structure interaction analyses are likely to give similar wall embedment depths and wall bending moments. For supported walls, where redistribution of stresses may be expected, a soil structure interaction analysis will normally provide a more economic design involving a shorter wall and reduced bending moments.

---

## 5.5 Factor of safety

Many different methods of analysis have been developed to calculate the embedment depth required to ensure stability in a retaining structure. These methods are generally empirical and based on the concept that the soil will attain active and passive pressure conditions at the point of failure. The pressure diagrams resulting from this ultimate condition are then used to determine the length of pile required to achieve moment equilibrium. However as this represents imminent failure of the wall, a factor of safety is applied, to ensure that the soil stresses are limited to an appropriate value and that the failure condition is not realised in practice.

The factor of safety may be applied in a number of different ways:

- 1 application of a scale factor to increase the calculated depth of embedment required for limiting equilibrium,
- 2 reduction of the theoretical soil strengths by application of an appropriate factor,
- 3 application of an appropriate factor to increase the nett or gross pressures acting on the structure.

## Design of sheet pile structures

The magnitude of the factor or factors applied is dependent upon the method of analysis used and reflects the confidence the designer places in his choice of soil parameters for design and the deformation limits to be applied to the structure.

Eurocode 7, which covers geotechnical design, adopts a limit state philosophy which is also a feature of many of the National Standards currently in use (ie BS8002). The traditional design methods – developed through many years of use – apply a global factor of safety to the calculated values to cover all unknowns and the effect of its introduction is well understood by designers.

Limit state design is a more scientific approach as it applies different factors to the various parameters affecting the wall design (i.e. soil density, surcharges, loads etc.) to enhance unfavourable (disturbing) loads and pressures and reduce favourable (restoring) ones. In this way, the design parameters that introduce the most uncertainty are subject to more onerous factors. For example, the reduction factor applied to undrained cohesion is larger than that applied to the angle of internal friction for a soil.

Different factors are applied dependent upon the nature of the analysis being carried out i.e. serviceability or ultimate limit state.

By adopting a partial factor design method, the factors of safety are introduced when the soil parameters and applied loads are determined and the pressure diagram already includes the necessary factors. The designer will need to carry out calculations to determine the length of pile that results in equilibrium of the earth pressures i.e. a factor of safety of 1. Although it is the intention of this publication to support the use of partial factor design, for the sake of completeness, the brief paragraphs following are included to illustrate how factors of safety were applied in some of the more common wall design methods.

### **Gross pressure method**

The factor of safety is applied to the gross passive pressure diagram only. This approach can lead to an anomaly in undrained conditions where  $K_a = K_p = 1$  as, beyond a certain depth of embedment, the calculated factor of safety decreases with increasing length of wall. This situation results from the fact that the bulk weight of the soil on the passive side, used to calculate the earth pressures acting on the wall, is effectively reduced by the factor of safety.

### **Nett pressure method**

The method has been used by designers for many years and is often referred to as the Piling Handbook method. The factor of safety is applied to the nett passive pressure diagram derived by subtracting the active earth and water pressure at a given level from the passive earth and water pressure. The method tends to

## Design of sheet pile structures

give higher factors of safety for a given geometry when compared to other methods, but careful selection of conservative design parameters, will give acceptable analysis results.

### **Revised method**

Developed by Burland and Potts, the factor of safety is applied to the moment of the nett available passive resistance. This is the difference between the gross passive pressure and those components of the active pressure that result from the weight of soil below dredge level. In effect the factor of safety is applied to the dead weight of soil below dredge level on both sides of the wall. This method partially overcomes the anomaly in the gross pressure method.

### **Factor on strength method**

The strength parameters of the soil are reduced by an appropriate factor in a method analogous to the calculation of embankment stability. The effect is to increase  $K_a$  and decrease  $K_p$ , modifying the pressure distribution relative to that used as a base in the other described methods.



# Design of sheet pile structures

## 5.6 Limit state designs

The design calculations prepared to demonstrate the ability of a retaining wall to perform adequately under the design conditions must be carried out with full knowledge of the purpose to which the structure is to be put. In all cases, it is essential to design for the collapse condition or Ultimate Limit State (ULS) and in some situations it may also be appropriate to assess the performance of the wall under normal operating conditions, the Serviceability Limit State (SLS). SLS calculations should be carried out where wall deflections and associated ground movements are of importance.

When a wall is dependent upon its support system for stability and where it is foreseen that accidental loading could cause damage or loss of part or all of that support system, the designer should be able to demonstrate that progressive collapse of the structure will not occur. An example of this is the effect that loss of a tie rod may have on a wall design.

---

## 5.7 Free or fixed earth design

When designing an earth retaining structure, the designer may choose to adopt either free and fixed earth conditions at the toe of the wall. The difference between these two conditions lies in the influence which the depth of embedment has on the deflected shape of the wall.

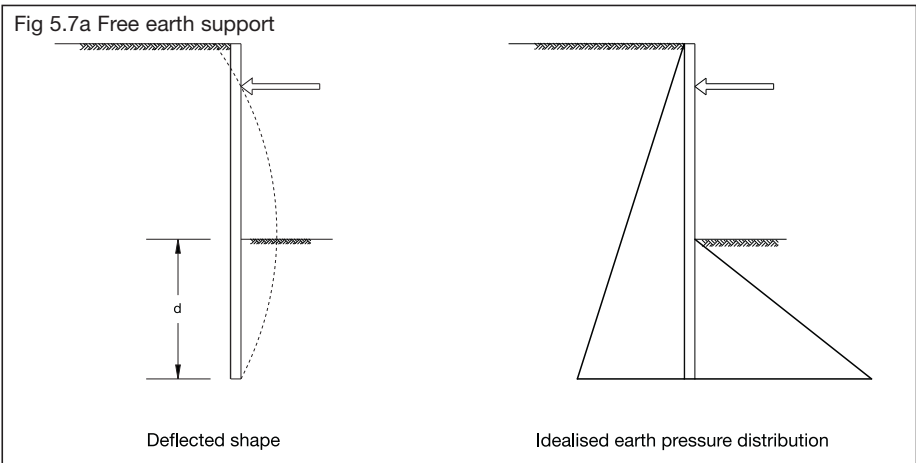

A wall designed on free earth support principles can be considered as a simply supported vertical beam. The wall is embedded a sufficient distance into the soil to prevent translation, but is able to rotate at the toe providing the wall with a pinned

## Design of sheet pile structures

support. A prop or tie near the top of the wall provides the other support. For a given set of conditions, the length of pile required is minimised, but the bending moments are at a maximum.

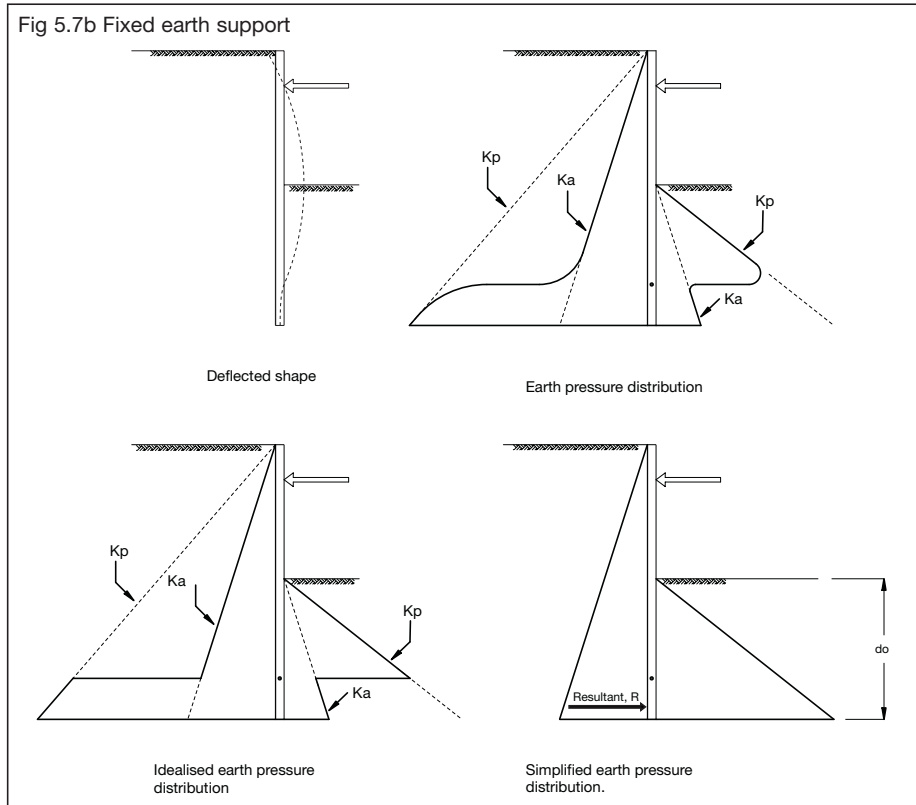

A wall designed on fixed earth principles acts as a propped vertical cantilever. Increased embedment at the foot of the wall prevents both translation and rotation and fixity is assumed. Once again a tie or prop provides the upper support reaction. The effect of toe fixity is to create a fixed end moment in the wall, reducing the maximum bending moment for a given set of conditions but at the expense of increased pile length. The assumption of fixed earth conditions is fundamental to the design of a cantilever wall where all the support is provided by fixity in the soil.

When a retaining wall is designed using the assumption of fixed earth support, provided that the wall is adequately propped and capable of resisting the applied bending moments and shear forces, no failure mechanism relevant to an overall stability check exists. However empirical methods have been developed to

## Design of sheet pile structures

enable design calculations to be carried out, an example of which is given in chapter 6.

Designers must be careful when selecting the design approach to adopt. For example, walls installed in soft cohesive soils, may not generate sufficient pressure to achieve fixity and in those soils it is recommended that free earth conditions are assumed. Fixed earth conditions may be appropriate where the embedment depth of the wall is taken deeper than that required to satisfy lateral stability, i.e. to provide an effective groundwater cut-off or adequate vertical load bearing capacity. However, where driving to the required depth may be problematic, assumption of free earth support conditions will minimise the length of pile to be driven and ensure that the theoretical bending moment is not reduced by the assumption of fixity.

When designing a wall involving a significant retained height and multiple levels of support, the overall pile length will often be sufficient to allow the designer to adopt fixed earth conditions for the early excavation stages and take advantage of reduced bending moment requirements.

The design methods used to determine the pile length required for both free and fixed earth support conditions do not apply if the support is provided below the mid point of the retained height as the assumptions made in the analysis models will not be valid.

---

### 5.8 Dealing with water

The water pressure conditions adopted in retaining wall design should be the most onerous that can be possibly imagined as the effect of water pressures on design calculations is very significant.

When an analysis is being carried out assuming that drained conditions exist, the effect of flow beneath the toes of the sheet pile wall is to increase the active pressures on the wall and decrease the passive pressures, both of which have a de-stabilising effect on the wall.

Water pressures to adopt when tension cracks develop in cohesive soils are covered in section 4.9.

In order to reduce the effect of large water pressures resulting from a difference in water level on each side of a retaining structure, the designer may provide weep holes through the wall preventing an accumulation of ground water. These will generally be located at the bottom of the exposed section of wall to maximise their effect as a means of reducing water levels. It should be noted however that weep holes are only fully effective when free drainage is possible and they should be designed in such a way that any roots, stones or fine material transported by the flow of ground water will not cause them to become clogged. In cohesive soils, weep holes are ineffective in the relief of water pressure behind the wall.

# Design of sheet pile structures

## 5.8.1 Flow nets

The preparation of a flow net can be a useful design tool when assessing the effect of water on a design situation, as it not only allows the engineer to calculate the water pressures in a particular situation, but also provides a visual representation of the flow regime in the soil. An illustration of how a flow net is constructed is included in chapter 7.

---

## 5.9 Surcharge loading

To allow for the presence of plant and equipment around the edge of the excavation during construction, it is recommended that a minimum surcharge load is applied to the surface of the retained ground. The magnitude of the surcharge is dependent upon the size of plant involved and the expected activities. As plant is increasing in size and weight, selection of too low a surcharge may restrict the type of plant that can be used and it is now common practice in Europe to adopt a minimum surcharge of 20 kPa.

In UK, the minimum suggested surcharge is 10 kPa but designers are warned that this should be increased (locally or globally) if heavy plant is to be located adjacent to the cofferdam or if excavated spoil or construction materials are to be stacked close to the pile wall – a 1 m height of spoil will result in a surcharge load in the order of 20 kPa. However, if the wall is retaining less than 3 m height the UK codes allow the designer to reduce the surcharge load provided he /she is confident that a minimum surcharge of 10 kPa will not apply during the life of the structure.

---

## 5.10 Support location

The location of supports to a retaining structure has a critical bearing on the structural requirements of the wall itself. As has been mentioned in the preceding sections, consideration of the wall as either fixed or free in terms of its mode of operation directly affects the bending moments, shear forces and support reactions acting on the wall.

Similarly, the position at which supports are assumed to act will affect the magnitude of bending moments and shear forces in the wall itself and consequently the support reaction required for stability.

When unusual support locations are provided, the conventional methods of analysis do not apply and consideration must be given to the mode or modes of failure that may occur. Walls involving low level props are discussed in section 6.3.1.

## Design of sheet pile structures

### 5.11 Walls supported by more than one level of struts or ties

When more than one level of support is provided to a wall the potential mode of failure is significantly different to that assumed for a wall with a single support provided that the supports are not close enough together to act as a single support. With multiple levels of support, the wall will not fail by rotation in the conventional manner – failure will be as a result of collapse of the support system or excessive bending of the piles. Consequently, provided that the wall and supports are sufficiently strong to resist the worst credible loading conditions, failure of the structure cannot occur.

To assess the bending moments and reaction forces in a multi-propped wall, a number of analysis methods have been developed. Unfortunately, the structure is statically indeterminate and a number of assumptions need to be made to enable the structure to be analysed.

---

#### 5.11.1 Hinge method

This method allows the structure to be analysed at successive stages of construction and the assumption is made that a hinge occurs at each support position except the first. The spans between the supports are considered as simply supported beams loaded with earth and water pressures and the span between the lowest support and the excavation level is designed as a single propped wall with the appropriate earth and water pressures applied. Prop loads calculated using this method include the respective load from adjacent spans.

The analysis of structures using this method is carried out on a stage-by-stage basis with excavation being carried out to sufficient depth to enable the next level of support to be installed. It is therefore possible that the support loads and bending moments calculated for a given stage of excavation are exceeded by those from a previous stage and it is important that the highest values of calculated support force and bending moment are used for design purposes.

---

#### 5.11.2 Continuous beam method

The wall is assumed to act as a vertical beam subjected to a pressure distribution with reactions at support points. The bottom of the beam is also assumed to be supported below excavation level by a soil reaction at the point at which the nett active pressure on the wall falls below zero. Mobilised earth pressures are assumed to act on the wall, the magnitude of these pressures being dependent upon a factor governed by the

## Design of sheet pile structures

permissible movements of the wall being designed. The minimum recommended mobilised earth pressure is however 1.3 times that resulting from the use of  $k_a$  to determine soil pressures on the wall.

Each support is modelled either as rigid or as a spring, depending on its compressibility. The displacement at a rigid support is zero, whereas in a spring it is proportional to the force carried by the spring.

The hypothetical soil support is modelled in one of three ways.

If the nett pressure (active pressure – passive pressure at a given depth) does not fall to zero anywhere along the wall, the hypothetical soil support is ignored and the embedded portion of the wall is treated as if it were a cantilever. This situation is likely to occur if there is only a short depth of embedment or the nett pressures are particularly large. The applied load in this case is carried entirely by the props.

If the nett pressure does fall to zero along the length of the wall, the hypothetical soil support is considered as a rigid prop. This situation is likely to occur if there is a large depth of embedment or the nett pressures are particularly small. The applied load in this case is shared by the props and the soil. The force carried by the soil is equal to the jump in shear force that occurs at the hypothetical soil support. Under this assumption it is essential to check that the force assumed to be provided by the hypothetical soil support is not greater than the available soil resistance below that support. If it is greater, the following method should be applied.

If the nett pressure falls to zero, but the available soil resistance below the point at which that occurs is less than that required by the rigid soil prop a finite soil reaction equal in magnitude to the available soil resistance should be adopted in subsequent calculations. This situation is likely to occur if there is a moderate depth of embedment. The applied load in this case is shared by the props and the soil. The force carried by the soil is equal to the change in shear force that occurs at the hypothetical soil support.

---

### 5.12 Softened zone

Where soft cohesive soils are exposed at dredge or excavation level it is advisable when calculating passive pressures to assume that the cohesion increases linearly from zero to the design cohesion value over a finite depth of passive soil. This is discussed in more detail in 4.12.

## Design of sheet pile structures

### 5.13 Bending moment reduction

The simplifying assumption made in design calculations concerning the linear increase in active and passive pressures in a material does not take into account the interaction between the soil and the structure. Studies have shown that this can have a significant effect on the distribution of earth pressures and consequent bending moments and shear forces on a structure.

The reduction in calculated bending moments is a function of the soil type and the flexibility of the wall in comparison to the supported soil. When a supported, flexible wall deflects, a movement away from the soil occurs between the support position and the embedded portion of the wall. This effect often leads to a form of arching within the supported soil mass which allows the soil to maximise its own internal support capabilities effectively reducing the pressures applied to the wall. For a relatively flexible structure, such as an anchored sheet pile wall, the effect of wall deformation will be to increase the pressures acting above the anchor level, as the wall is moving back into the soil using the support as a pivot, and reduce the pressures on the wall below this level where the biggest deflections occur.

The result of a redistribution of pressures is therefore a reduction in the maximum bending moment on a wall, but an increase in support reaction. Support loads calculated by a limit equilibrium analysis are generally lower than those resulting from soil structure interaction

Redistribution should not be considered for cantilever walls or where the structure is likely to be subjected to vibrational or large impact forces that could destroy the soil 'arch'. Similarly, if the support system is likely to yield or movement of the wall toe is expected, moment reduction should not be applied. Where stratified soils exist, moment reduction should be viewed with caution since soil arching is less likely to occur in soils of varying strength.

The beneficial effects of soil arching on wall bending moment are automatically taken into account in analysis packages based on soil-structure interaction.

---

### 5.14 Calculating support forces

Previous editions of the Piling Handbook have recommended that the calculated reaction force be increased by 25% to ensure that support systems were not under-designed in the event that arching and stress redistribution behind the wall occurred. This additional load was included to take into account the fact that limit equilibrium methods of analysis would not automatically allow for soil structure interaction. When a soil structure interaction

## Design of sheet pile structures

analysis is undertaken, load redistribution is automatic and there is no need to increase the calculated loads.

It is recommended that support loads are calculated for both the serviceability limit state and the ultimate limit state and a distinction should be made between limit equilibrium and soil structure interaction analyses. The recommendation is that loads calculated using limit equilibrium methods should be increased by 85% and that the ULS support load should be the greater of the SLS prop load  $\times 1.35$  or the value derived from the ULS calculation.

Although this may seem to be a large increase, the original Piling Handbook approach to sizing of tie rods involved calculation of the tie load under what were effectively service conditions and application of an additional 25% for arching. The resultant load was then used in conjunction with a maximum steel stress of  $0.5f_y$  to determine the minimum steel area and hence the tie rod size. This combination provided a load factor of 2.5 when compared to  $f_y$  and the proposed factors result in an effective factor of  $1.85 \times 1.35 = 2.4975$ .

---

### 5.15 Structural design of the wall

Traditionally the structural design of steel piling, walings, struts, and tie rods based on loads calculated using the limit equilibrium approach would involve the introduction of a permissible design steel stress. This was almost universally taken to be about 2/3 of the yield stress of the steel. The design method also allowed designers to adopt a small increase in the permissible stress if the work was designated as temporary.

Table 5.15

Class of Work	Steel grade to EN 10248	
	S270GP N/mm <sup>2</sup>	S355GP N/mm <sup>2</sup>
Permanent	180	230
Temporary	200	260

The values in the table above can be used in conjunction with bending moments calculated using unfactored input parameters - which equates to the serviceability limit state.

However when design calculations are based on a limit state approach, factors given in an appropriate structural design code (ie EC3:part5 for piling, EC3:part1 for the other structural elements) should be adopted. For example, in UK, it is recommended that an additional factor should be applied to bending moments derived from worst credible earth and ground-



## Design of sheet pile structures

water loads. These factored loads are then used with the yield strength of the steel multiplied by a material factor. In the UK this material factor is set to 1.0 at the time of going to press.

---

### 5.16 Selection of pile section

The absolute minimum sheet pile section required for the retaining wall is that obtained from consideration of the bending moments derived by calculation for the particular case in question. However, it is also necessary to consider installation of the piles when determining the section to be adopted as hard driving conditions may require a heavier section to prevent buckling during installation. This aspect is covered in more detail in Chapter 11.

Furthermore, the requirements with respect to the effective life of the retaining wall will also need to be assessed. The effect of corrosion on the steel piles is to reduce the section strength and the design must ensure that the section selected will be able to resist the applied bending moments at the end of the specified life span without buckling or exceeding design stresses. In many instances the need for a heavy section for driving automatically introduces some if not all of the additional strength needed for durability.

---

### 5.17 Design bending stresses

The Limit Equilibrium method of analysis enabled the designer to assess the bending moments in the wall under working conditions. To limit the stresses in the structure and thereby control deflections, a factor of safety of 1.5 was applied to the yield strength of the steel when calculating the minimum section size required for the given conditions. Under these rules, normal design conditions would result in a structure where the elements were operating at a stress comfortably within their elastic capacity.

Corrosion activity reduces the section properties of the sheet pile wall and, assuming that the bending moments in the wall do not change, this has the effect of increasing the stress in the steel. Clearly the upper limit on corrosion loss is defined by the point at which the steel stress reaches yield and this was used traditionally as a means of defining the effective life of a sheet pile structure. It must not be overlooked that, while effective as a design method, this approach created the condition where the factor of safety against material failure was reducing with time.

It should be noted that when designing a wall using limit equilibrium methods, it was possible for the designer to adopt a different steel stress for permanent and temporary works on the assumption that temporary works would not be subject to corrosion conditions. Similarly, it was also possible to allow

## Design of sheet pile structures

stresses in the steel to exceed the limit for temporary works for conditions of short duration encountered during the construction period – this was often referred to as the short term, temporary condition.

The ability to flex the design stresses is not available under the limit state system as the design stress in the steel is already based on the yield strength.

---

### 5.18 Checklist of design input parameters

#### 5.18.1 Ultimate Limit State (ULS) conditions

The designer should assess all construction and in-service situations and design for the most onerous.

##### **Soil design parameters**

Factored soil design parameters should be used to derive earth pressure coefficients for use in ULS calculations (see chapter 4).

##### **Groundwater pressures**

The worst credible groundwater pressures at each stage of the construction sequence and throughout the wall's design life should be adopted.

##### **Loads**

The ULS design should be carried out using the worst credible combination of loadings excluding extreme or accidental events.

It is recommended that a minimum surcharge load is applied to the surface of the retained ground as discussed in 5.9.

##### **Unplanned excavation**

The ULS design condition should include an allowance for unplanned excavation as outlined in 5.3.

##### **Softened zone**

If an allowance is to be made for softening of the passive soil in a total stress analysis it should be applied beneath the unplanned excavation level (see 5.12).

---

#### 5.18.2 Serviceability Limit State (SLS) conditions

##### **Soil design parameters**

Unfactored soil design parameters should be used to derive earth pressure coefficients for use in SLS calculations (see chapter 4).

##### **Groundwater pressures**

These should be the most unfavourable values which could occur under normal circumstances during any construction stage or in service. Extreme events such as a burst water main near the wall may be excluded, unless the designer considers that under normal circumstances this can be reasonably included.

## Design of sheet pile structures

### **Loads**

The loadings considered should be those that the designer considers may apply under normal circumstances. Extreme or accidental events should be excluded.

It is recommended that a minimum surcharge load is applied to the surface of the retained ground, as discussed in 5.9.

### **Unplanned excavation**

No allowance should be made for unplanned excavation below the formation level expected in normal circumstances. However, the expected formation level should take into account any temporary excavation for services, if these can be reasonably expected, and if appropriate any allowance for the excavation tolerance.

### **Softened zone**

If an allowance is to be made for softening of the passive soil in a total stress analysis it should be applied beneath the unplanned excavation level.

# Design of sheet pile structures

## 5.19 Analysis of pressure diagrams

When creating a pressure diagram to work with, it is essential that the pressure conditions are calculated at every change of state of the problem i.e. strata boundaries, water tables, excavation depth etc.. However when calculations involve a support, it is often very convenient to include a pressure calculation at this level.

When taking moments of pressures about a given position, the diagram can be broken down in different ways to produce a series of sensible units.

It will be noted that in the situation where the pressure diagram is divided into rectangles and triangles, care must be taken to introduce the 1/2 factor for areas of triangles and either 1/3, 2/3 or 1/2 when assessing moments of areas about a point.

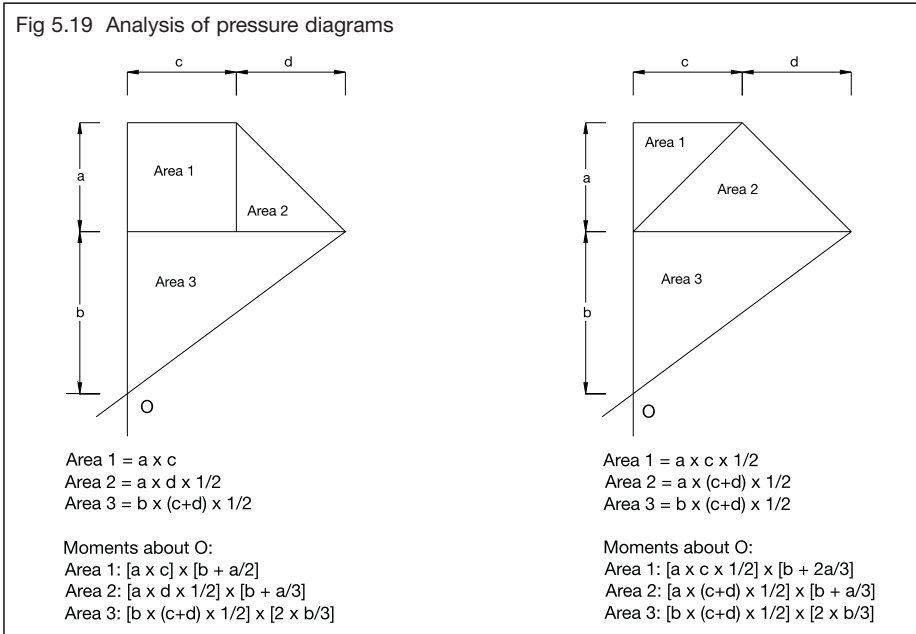

When divided only into triangles, the 1/2 factor in the area calculation appears everywhere and the moment factor will be 1/3 or 2/3.



ArcelorMittal

- 1** Product information
- 2** Sealants
- 3** Durability
- 4** Earth and water pressure
- 5** Design of sheet pile structures
- 6** Retaining walls
- 7** Cofferdams
- 8** Charts for retaining walls
- 9** Circular cell construction design & installation
- 10** Bearing piles and axially loaded sheet piles
- 11** Installation of sheet piles
- 12** Noise and vibration from piling operations
- 13** Useful information

# Retaining walls

Contents	Page
<b>6.1 Introduction</b>	1
<b>6.2 Design activities for simple retaining walls</b>	1
<b>6.3 Pressure distributions</b>	2
6.3.1 Low propped walls	3
6.3.2 Relieving platforms	4
<b>6.4 Wall deflections</b>	5
<b>6.5 Anchorage systems</b>	6
6.5.1 Location	6
6.5.2 Design of anchorages	6
6.5.3 Balanced anchorages	9
6.5.4 Cantilever anchorages	10
6.5.5 Grouted anchors	10
<b>6.6 Walings</b>	10
6.6.1 Design of walings	12
6.6.2 Ultimate bending capacity of parallel flange channel walings.	13
<b>6.7 Tie Rods</b>	14
6.7.1 Tie rod fittings	16
6.7.2 Tie bar corrosion protection	17
6.7.3 Plates and washers	18
6.7.4 Special fittings	18
6.7.5 Site assembly	19
<b>6.8 Example calculations</b>	20
6.8.1 Cantilever retaining wall	20
6.8.2 Tied wall with free earth support	24
6.8.3 Tied wall with fixed earth support	27
6.8.4 Deadman anchorage	31

# Retaining walls



# Retaining walls

## 6.1 Introduction

The design requirements that apply to any sheet pile structure are included in Chapter 5. This chapter is given to highlight information of particular relevance to the design of retaining walls.

---

## 6.2 Design activities for simple retaining walls

The following is a checklist of the activities needed to design a simple retaining wall structure.

The sequence does not include any actions in respect of calculations to confirm that progressive collapse will not occur.

SLS calculations should be carried out where wall deflections and associated ground movements are of importance or if you wish to adopt an allowable stress approach to the wall design.

Should the wall be subject to vertical loading, an additional calculation to verify vertical equilibrium will be needed – this may affect the design wall length determined in step 2 below and subsequent stages will need to take any additional wall length into account.

- 1 Determine soil parameters, groundwater pressures, load case combinations and design geometry appropriate for ultimate limit state (ULS) calculations.
- 2 Carry out collapse (ULS) calculations using limit equilibrium methods or soil-structure interaction analysis and determine the design wall depth
- 3 Carry out ULS limit equilibrium or soil-structure interaction analysis to determine wall bending moment, shear force and prop load.

Note: If SLS assessment is not required, steps 4 to 7 may be omitted.

- 4 Determine soil parameters, groundwater pressures, load case combinations, and design geometry appropriate to SLS calculations. This step may be omitted if SLS calculations are not required.
- 5 For the design wall depth, carry out SLS calculations using limit equilibrium methods or soil-structure interaction analysis to determine SLS load effects (wall bending moment, shear force and prop or anchor loads). This step may be omitted if SLS calculations are not required.
- 6 Determine wall deflections and ground movements from the SLS soil-structure interaction analysis (if undertaken) and empirical correlations with comparable case history data. This step may be omitted if wall deflections and ground movements are not of importance.



## Retaining walls

- 7 Check that the SLS load effects, wall deflections and ground movements determined in step 6 comply with criteria (ie check compliance with allowable stress criteria for steel sheet pile walls, if appropriate).
- 8 Determine ULS bending moments (BM) and shear force (SF) appropriate for the structural design of the wall as the greater of: BM and SF from step 3 or 1.35 times the BM and SF values determined from step 5 (if undertaken)

To calculate the section modulus required using a limit state code, it may be necessary to apply a further factor to the calculated bending moments. In UK this factor is 1.2 for design to BS5950.

The calculation of the SLS wall bending moment, shear force and prop or anchor load (if applicable) requires consideration of the pressures acting on the wall when it is in limiting equilibrium ( $F_s = 1.0$ ). The wall under ULS conditions will have a deeper embedment corresponding to  $F_s > 1.0$ .

The entire embedded depth of the wall should be considered when calculating the groundwater seepage pressure in the SLS condition.

---

### 6.3 Pressure distributions

The pressure diagram most frequently adopted as the starting point for retaining wall design involves a generally triangular distribution of pressure based on the assumption that the wall moves away from the active soil and towards the passive. This simple diagram is ideal for hand calculations and generally results in a conservative solution.

The simple triangular pressure distribution can be modified – this normally requires a computer program - to include the effects of wall movement. The resultant pressure distribution will generally involve a pressure increase at points on the wall where the movement is small (ie supports) and a reduction due to arching where the movement is large.

The pressure diagram can be further modified if the effects of soil/pile interaction are taken into account. Once again a sophisticated computer package is required for this and the effect is generally a reduction in active pressure and an increase in passive.

The pressure diagram may also need to be amended if the wall support is provided at a relatively low level - as may be the case when a base slab is cast up against a cantilever retaining wall. In this situation, the slab will act as the pivot point and the failure mode may then involve forward movement of the upper part of the wall and a backward movement of the lower portion of the pile. This will cause the active and passive pressure zones to change sides below the pivot, the effect of which needs to be included in the design assessment. This is covered in more detail in section 6.3.1.

## Retaining walls

Similarly the inclusion of a relieving platform behind the wall will allow active pressures to be reduced below the platform level on the assumption that any surcharge and the weight of soil are supported by the slab and distributed into the support system for the slab as vertical loads. The intention is that this will result in lower earth pressures and smaller bending moment in the wall.

### 6.3.1 Low propped walls

Research at Imperial College, London has shown that the earth pressures acting on retaining walls that are restrained with a single level of supports at or near excavation level, are different to those assumed in conventional limit equilibrium calculations. Conventional calculations assume that the mode of failure for a retaining structure supported at or near the top will be in the form of a forward rotation of the pile toe and the pressure distribution at failure is based on this assumption. The failure mode assumed for a low propped wall is that the pile will move away from the soil at the top in a similar manner to a cantilever and the pile will move back into the soil below the support level. This will result in the generation of passive pressures on the back of the wall and active pressures on the front.

To design a wall incorporating a low prop, there are two fundamental requirements that must be satisfied for the calculation method to be correct. Firstly, the prop must be sufficiently rigid to act as a pivot and prevent any forward movement of the wall and secondly, the sheet piles forming the wall must be capable of resisting the bending moments induced at the prop level to ensure that rotation of the pile occurs rather than buckling.

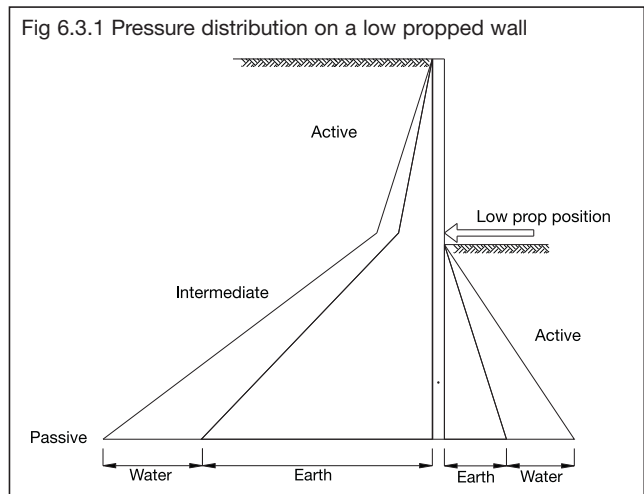

## Retaining walls

The design rules resulting from the Imperial College work suggest that the earth pressures below the support should be calculated assuming that active pressures apply at and above the prop position with full passive pressure at the toe of the pile; the change from one to the other being linear.

The support may be considered to be at low level if the depth to the support exceeds two thirds of the retained height of the excavation.

The operation of a low propped wall is very complex and it is recommended that the design of such a structure is carried out using soil structure interaction.

### 6.3.2 Relieving platforms

When the depth of soil to be retained and/or the applied surcharge loading (e.g. from heavy wharf cranes) is excessive, soil pressures may be reduced by the use of a relieving platform.

The relieving platform is constructed such that it will support the surcharge loads and the upper portion of the retained soil, these loads being transferred to lower strata where there will be no effect on the pressures acting on the wall. Bearing piles, which support the platform and transfer the loads into the soil at depth, may also be designed to provide an anchorage to the wall.

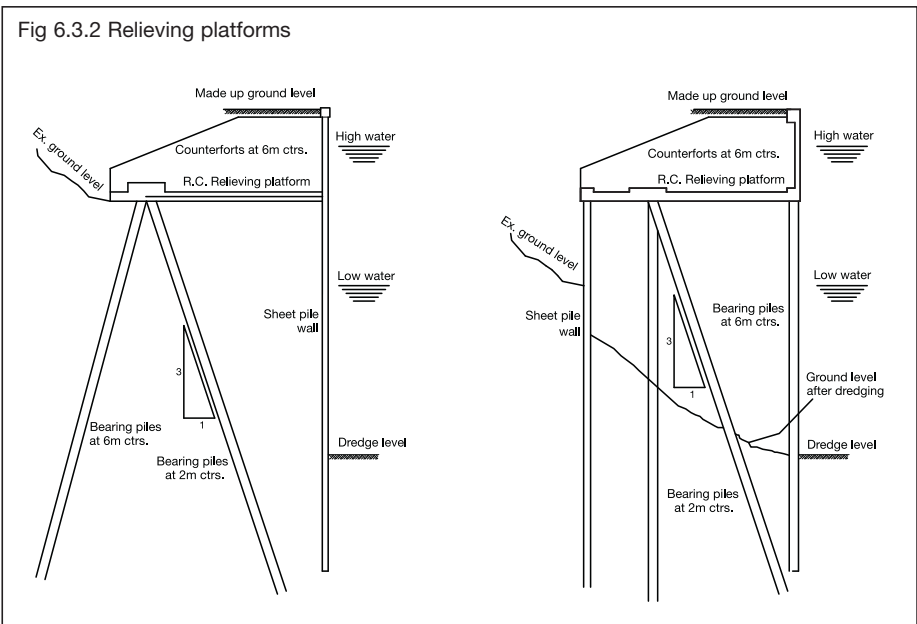

## Retaining walls

The platform can be supported in part by the main sheet pile wall and if the vertical loading becomes excessive, box or high modulus piles may be introduced into the wall at appropriate intervals to carry this load. Alternatively, bearing piles may be provided immediately behind the wall.

The relieving platform must be designed such that it will intersect the plane of rupture from the soil above and behind the platform preventing any load from that soil acting on the wall. The main sheet piles may extend up to ground level or be curtailed at platform level with a concrete retaining wall being provided above that level; the concrete wall must be designed to derive its stability from the platform.

---

### 6.4 Wall deflections

The total deflection exhibited by a retaining wall comprises a component based on the deflection of the section as a result of the applied loads and a component based on compression of the soil as the active/passive pressure regime is established. This latter portion will apply irrespective of the material from which the wall is formed as the magnitude of the movement is a function of the soil properties rather than those of the wall. When assessing the suitability of a particular form of wall for a given situation, the engineer should consider what wall deflection is acceptable for the environment in which the structure is to operate. For example the deflection criteria may not need to be as onerous for a wall in a rural setting compared to one in a congested inner city area.

It is often the case that the deflection for a flexible wall, for a given set of conditions, is not substantially larger than that of a stiff wall. It must not be overlooked however that it is often settlement of the soil immediately behind the retaining wall that is the problem to adjacent structures rather than the horizontal movement of the wall itself.

A number of researchers have investigated the deflection of retaining walls and it has been shown that the deflection of any retaining wall is a function of the global system stiffness (Clough et al, 1989) which is determined with the wall construction and the propping arrangements in mind. This leads to the fact that the expected deflection of a flexible wall with more props will be similar to that of a stiff wall with fewer props.

Although deflection is probably considered to be a negative feature of sheet piling construction, when the effects of flexibility of the retaining structure are taken into account in the design process, soil arching and stress redistribution will occur often resulting in a significant reduction in the required bending moment capacity when compared to a stiff wall. Hence in situations where extra deflection can be accommodated, the reduced wall strength demand means that a smaller pile section can be adopted

## Retaining walls

allowing costs to be optimised and the wall footprint to be minimised.

The deflection of the structure is not taken into account in a limit equilibrium analysis and consequently a separate assessment of the anticipated wall deflections is needed when wall movement is important. The selection of appropriate soil parameters will generally ensure that in-service stresses in the soils are not high enough to result in large movements. It is suggested that adoption of design effective stress parameters based on the lesser of the representative critical state strength or representative peak strength divided by a mobilisation factor of 1.2 will limit in service displacements to 0.5% of the wall height if the soil is medium dense or firm. In the case of total stress designs this limit on movement will be achieved if the representative undrained strength is divided by a mobilisation factor of at least 1.5.

Empirical methods have been developed to assess wall deflection (Clough and O'Rourke, 1990) but when movements are critical, it is recommended that an analysis involving soil structure interaction is undertaken as the expected movements will be incorporated into the analysis amending the soil pressures accordingly.

---

### 6.5 Anchorage systems

#### 6.5.1 Location

For an anchorage system to be effective it must be located outside the potential active failure zone developed behind a sheet pile wall – outside line DE in figure 6.5.1a. Its capacity is also impaired if it is located in unstable ground or if the active failure zone prevents the development of full passive resistance of the system.

If the anchorage is located between CA and DE, only partial resistance is developed due to the intersection of the active and passive failure wedges. However the theoretical reduction in anchor capacity may be determined analytically.

In cohesive soils, the correct position for the anchorage is outside the critical slip circle and at sufficient distance behind the wall to develop a shear resistance equal to the ultimate capacity of the anchorage.

---

#### 6.5.2 Design of anchorages

Anchorage of this type can be formed as discrete units or as a continuous wall and they should be positioned such that the passive failure wedge from the toe of the anchor wall does not coincide with the active failure zone behind the main wall as illustrated in Fig. 6.5.1a.

# Retaining walls

Fig 6.5.1a Location of anchorages

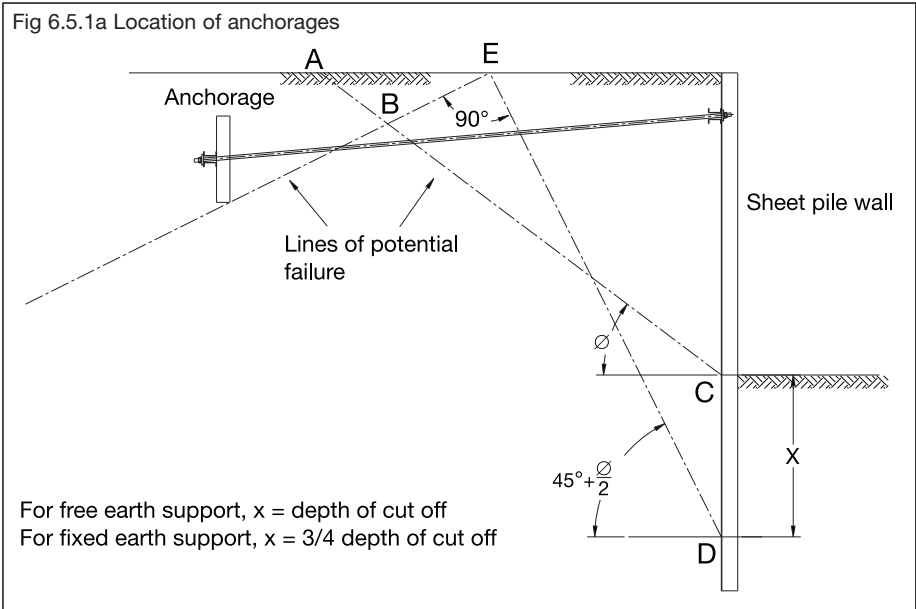

The net passive resistance to be obtained from the soil (passive minus active) is calculated as for the retaining structure using the worst conceivable combination of circumstances. Wall friction should only be taken into account when deriving the earth pressure

Fig 6.5.1b Development of anchor resistance in cohesive soils

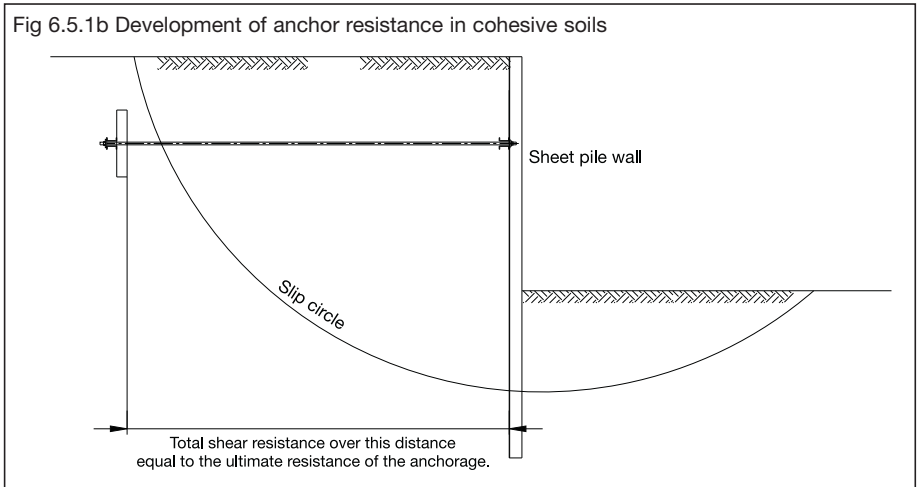

## Retaining walls

coefficients if the designer is confident that it can be realised under all loading conditions – the conservative approach is to ignore it. However, the effect of variations in the ground water level on soil strength properties and the application of surcharge loading to the active side of the anchorage only should be included to maximise the disturbing loads and minimise the restoring loads.

The anchorage system should be designed to provide sufficient resistance to movement under serviceability limit state conditions and sufficient resistance to satisfy ultimate limit state loads in the tie rods.

In a similar manner to the design of the main wall, the anchorage system may be assessed on the basis of serviceability and ultimate limit states – see Section 6.2 for situations where an SLS analysis is essential. The serviceability support load is taken as the actual value derived from a soil structure interaction based analysis or that derived from limit equilibrium based calculations multiplied by a factor of 1.85 and this load is used in the structural design of the anchor components. This factor is used to take into account the fact that the anchorage is a critical part of the stability system for the wall and that loads derived from a limit equilibrium analysis can be significantly lower than those predicted by methods that adopt soil structure interaction.

Similarly, the ultimate limit state load is the greater of that derived for serviceability multiplied by 1.35 or that resulting from an analysis of ULS conditions. Once again the 1.85 factor is applied to the ULS loads derived using limit equilibrium analysis.

Design of the anchorage components, to established structural codes will generally require the support loads generated as indicated above, to be further multiplied by a factor to give ultimate design loads.

In certain situations, progressive collapse of the structure may be a consequence of an extreme condition ie failure of a tie rod and under such circumstances, the designer should carry out a risk assessment and if necessary avoid the possibility by changing the design or applying controls to the construction activities. If necessary calculations may be required to demonstrate that progressive collapse will not occur.

These calculations should be carried out using unfactored soil parameters and normal water levels, the resultant bending moments and support forces being treated as ultimate loads.

With this robust construction requirement in mind, the effectiveness of discrete anchorages needs to be given careful consideration. The waling to the main wall will need to be checked to ensure that it will not collapse if the span between supports doubles following the loss of a tie rod. The ties on either

## Retaining walls

side of the one that has failed will share the load from the missing tie and, dependent upon the magnitude of the loads involved, the resistance to be provided by each discrete anchorage may need to increase to resist the loading. If the tie rods are attached to a continuous anchorage, the total area of the anchorage will not change but the walings will need to be strong enough to provide the necessary support over a double span.

An example of anchorage design is included at the end of this chapter.

---

### 6.5.3 Balanced anchorages

The design of balanced anchorages assumes that the resistance afforded increases with depth below the ground surface giving a triangular pressure distribution. The top of the anchorage is assumed to be at a depth below the ground surface equal to 1/3 of the overall depth to its toe. The tie rod or tendon is placed such that it connects with the anchorage at 2/3 of the overall depth to the toe (on the centre line of the anchorage element). This arrangement ensures that the tie rod force passes through the centre of passive resistance.

The entire passive wedge developed in front of the anchorage, including that above the top of the deadman unit, is effective in providing resistance.

When the design is based on the provision of discrete anchorage units, an additional force equal to that required to shear the wedge of soil in front of the anchorage from adjacent soil at each side can be added to the passive resistance to give the total anchorage resistance.

The additional resistance resulting from shearing of the soil is calculated using the following equations;

$$\begin{array}{ll} \text{Cohesionless soils:} & P_s = \frac{1}{3} \gamma d^3 K_a \tan(45 + \phi/2) \tan \phi \\ \text{and Cohesive soils} & P_s = s_u d^2 \end{array}$$

where  $P_s$  is the total shear resistance on both sides of the wedge

$d$  is the depth to the toe of the anchorage

$s_u$  is the undrained cohesion of the soil.

In the case of an anchorage in cohesive soil, the top metre of soil should be ignored if tension cracks are likely to develop parallel to the tie rods.

The maximum resistance that can be developed in the soil is that resulting from adoption of a continuous anchorage so it is essential that a check is made to ensure that the resistance provided by a series of discrete anchorages does not exceed this figure.



## Retaining walls

### 6.5.4 Cantilever anchorages

Cantilever anchorages may be considered where good soil is overlain by a layer of poor material. This type of anchorage can be designed in the same manner as a cantilever wall where the piles must be driven to sufficient depth in a competent stratum to achieve fixity of the pile toes. The earth pressures can be assessed using conventional methods, but an additional load is introduced to represent the tie rod load and the whole system is then analysed to determine the pile length required to give rotational stability about the pile toe under the applied loads. An additional length of pile is then added to ensure that toe fixity is achieved. A check must be made to ensure that horizontal equilibrium of the forces acting on the anchorage is achieved.

The bending moments induced in this type of anchorage are generally large and wherever possible this type of anchorage should be avoided. Raking piles can often be an economic alternative to this type of anchorage.

---

### 6.5.5 Grouted anchors

An alternative to a deadman anchorage is to use grouted soil or rock anchors. These consist of a tendon, either bar or strand, which is grouted over the anchor bond length, to transfer the tension load into the soil. The part of the tendon between the wall and the anchor bond length is left ungrouted to ensure the load transfer occurs beyond the potentially unstable soil mass adjacent to the wall. The installation of these anchors is usually carried out by specialist contractors from whom further information may be obtained.

---

### 6.6 Walings

Walings usually comprise two rolled steel channel sections placed back to back and spaced to allow the tie rods to pass between the channels. This spacing must allow for the diameter of the tie rod and the thickness of any protective material applied to the rod and take into account any additional space required if the tie rods are inclined and will need to pass between the walings at an angle.

It is generally convenient to use at least 100mm deep channel section diaphragms to create the necessary space positioned at approximately 2.4m centres – although this dimension will generally be determined by the width of the sheet piles and the position of tie bolts and splices.

The walings may be fixed either at the back or front of the retaining wall. The first arrangement is usually adopted for the sake of appearances and, in the case of a wall in tidal or fluctuating water level conditions, to prevent damage to the waling by floating craft or vice versa.

## Retaining walls

Fig 6.6 Typical anchoring arrangements

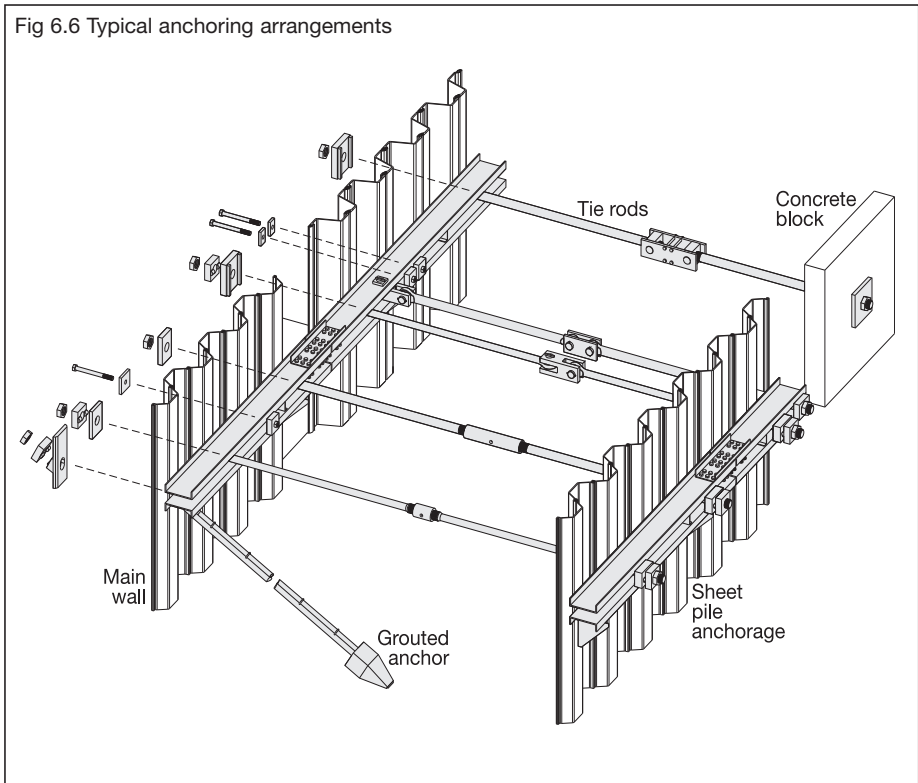

When the waling is placed behind the wall, it is necessary to use short anchor bolts and plates at every point of contact between the piles and the waling to connect them together. Placing the waling in front of the wall eliminates the need for connection bolts and this arrangement is therefore more economical.

Splices should be located at a distance of  $0.2775$  of the tie rod spacing from a tie rod location as this will be close to the position of minimum bending moment in the waling. The walings should be ordered 100mm longer than the theoretical dimensions to allow for any creep which may develop in the wall as the piles are driven, one end only of each length being drilled for splicing (if the splice is to be achieved by bolting). The other end should be plain for cutting and drilling on site, after the actual length required has been determined by measurement of the driven piles.

Where inclined ties are used, the vertical component of the anchor load must not be overlooked and provision must be made to support the waling, usually in the form of brackets or welded connections.

## Retaining walls

In order to prevent the build up of water on top of the waling after backfilling, holes should be provided at any low spots and generally at 3m centres in the webs of the walings.

Where sheet pile anchorages are used, similar walings to those at the retaining wall are required. These are always placed behind the anchor piles and consequently no anchor bolts are required.

Where walings form part of the permanent structure they can be supplied with a protective coating applied before dispatch, a further coat being applied at site after completion of the works.

---

### 6.6.1 Design of walings

For design purposes, the waling may be considered to be simply supported between the tie rods (which will result in a conservative bending moment) with point loads applied by the anchor bolts. The magnitude of the tie bolt load is a function of the bolt spacing and the design support load per metre run of wall. Alternatively, the waling can be considered as continuous with allowance being made for end spans. Although the waling is then statically indeterminate, it is usual to adopt a simplified approach where the bending moment is assumed to be  $wL^2/10$ ,  $w$  being the calculated load to be supplied by the anchorage system acting as a uniformly distributed load and  $L$  is the span between tie rods.

When checking the anchorage system for the loss of a tie rod, the load in the anchorage system is assessed on the basis of the requirements for a serviceability limit state analysis with no allowance being made for overdig at excavation level. The resulting bending moments and tie forces are considered to be ultimate values and are applied over a length of waling of  $2L$ .

In this extreme condition, it can be demonstrated that, with the exception of the ties at either end of the external spans, the bending moment in a continuous waling resulting from the loss of any tie rod will not exceed  $0.3wL^2$  where  $w$  is the support load calculated for this condition expressed as a UDL and, for simplicity,  $L$  is the original span between tie rods. It is intended that this estimation is used for an initial assessment of the effect that loss of a tie rod will have on the structural requirements.

This simplification will enable a check to be made with minimum effort to ascertain whether the normal design conditions are the more critical design situations. If the anchorage design proves to be governed by this extreme case, it may be advantageous to carry out a more rigorous analysis of the waling arrangement with a view towards optimising the design.

# Retaining walls

## 6.6.2 Ultimate bending capacity of parallel flange channel walings

Table 6.6.2 gives information on the theoretical ultimate bending capacity of walings formed from 'back to back' channels in the most commonly used steel grades.

It must not be overlooked that the calculated ultimate bending capacity of the waling will need to be reduced to take into account torsion, high shear loads and axial loading. The values are included as an aid to initial section sizing.

Table 6.6.2 Back-to-back channel walings

Designation	Dimensions				Weight kg/m	CS Area A cm <sup>2</sup>	Section modulus			Yield moment capacity					
	h mm	b mm	tw mm	tf mm			Wy cm <sup>3</sup>	Wpl,y cm <sup>3</sup>	S235JR kNm	S275JR kNm	S355JR kNm	S235JR kNm	S275JR kNm	S355JR kNm	
UPN 180	180	70	8	11	44	56.0	300	358	70.5	82.5	106.5	98.5	84.1	127.1	
UPN 200	200	75	8.5	11.5	51	64.4	382	456	89.8	105.1	135.6	125.4	125.4	161.9	
UPN 220	220	80	9	12.5	59	74.8	490	584	115.2	134.8	174.0	160.6	160.6	207.3	
UPN 240	240	85	9.5	13	66	84.6	600	716	141.0	165.0	213.0	196.9	196.9	254.2	
UPN 260	260	90	10	14	76	96.6	742	884	174.4	204.1	263.4	243.1	243.1	313.8	
UPN 280	280	95	10	15	84	106.6	896	1064	210.6	246.4	318.1	292.6	292.6	377.7	
UPN 300	300	100	10	16	92	117.6	1070	1264	251.5	294.3	379.9	347.6	347.6	448.7	
UPN 320	320	100	14	17.5	119	151.6	1358	1652	319.1	373.5	482.1	454.3	454.3	586.5	
UPN 350	350	100	14	16	121	154.6	1468	1836	345.0	403.7	521.1	504.9	504.9	651.8	
UPN 380	380	102	13.5	16	126	160.8	1658	2028	389.6	456.0	588.6	557.7	557.7	719.9	
UPN 400	400	110	14	18	144	183.0	2040	2480	479.4	561.0	724.2	682.0	682.0	880.4	

The table shows the basic Yield Moment capacity of the walings calculated as  $M_{el} = Y_s \cdot W_y$  and  $M_{pl} = Y_s \cdot W_{pl,y}$ .

Appropriate standards should be used to assess whether the moment capacity needs to be reduced to take into account:

lateral torsional buckling

high shear loading

axial load

Webs should be checked for buckling and bearing.

## Retaining walls

### 6.7 Tie rods

Tie rods are readily available in weldable structural steel complying with EN10025 grade S235J0 and S355J0 but the economies to be gained from specifying high tensile ties mean that steel with a yield stress of 500N/mm<sup>2</sup> is being specified more and more.

Tie rods may be manufactured from plain round bars with the threads formed in the parent metal such that the minimum tensile area will occur in the threaded portion of the bar. Alternatively, they may be manufactured with upset ends which involves forging the parent bar to create a larger diameter over the length to be threaded. Using this process, a smaller diameter bar can be used to create a given size of thread.

Threads may be produced by cold rolling or machining.

The ultimate resistance of a tie rod is calculated on the basis of the lowest resistance from either the threaded part of the rod or the shaft at any time during the life of the structure. It is common practice to limit the stress in the threaded section of a tie rod to the lesser of either the yield stress of the steel or a proportion of it's ultimate tensile strength - in many current design codes this proportion is in the region of 70%. The cross section area applicable to the threaded portion is the net area of the bar allowing for the loss of area over the depth of the threads.

When calculating the shaft resistance, the stress is taken as the yield stress of the steel and the tensile area as the gross area of the bar.

Hence the ultimate resistance of the tie rod is the lesser of

$$K \cdot f_u \cdot A_t$$

$$f_y \cdot A_t$$

or

$$f_y \cdot A_g$$

where K is a reduction factor whose value is defined in local standards;

$f_u$  is the ultimate tensile strength of the steel;

$A_t$  is the tensile stress area at the threads;

$f_y$  is the yield strength of the steel;

$A_g$  is the gross area of the parent bar;

Individual tie rod manufacturers offer different products and designers should check manufacturers literature or websites to ensure that they have the most up to date information.

The following table indicates the nominal steel areas for a range of tie rods providing threads of a given size. As can be seen, a smaller diameter parent bar can be used to create a tie rod with a given thread size when the ends are upset.

Care must be exercised when assessing the ultimate resistance of the tie rods offered by different manufacturers as the quoted tensile area in the threaded section may not take into account manufacturing tolerances for the threading process and consequently may not be the lowest possible tensile area.

# Retaining walls

Table 6.7

Nominal Thread size	Nominal Minimum thread dia* mm	Minimum area under threads mm <sup>2</sup>	Upset bars		Plain bars	
			Bar dia mm	Area of Main bar mm <sup>2</sup>	Bar dia mm	Area of main bar mm <sup>2</sup>
M36	32.253	817	30	707	36	1018
M42	37.763	1120	35	962	42	1385
M48	43.307	1473	40	1257	48	1810
M56	50.840	2030	47	1735	56	2463
M64	58.360	2675	54	2290	64	3217
M72	66.364	3459	61	2922	72	4072
M85	79.364	4947	73	4185	85	5675
M90	84.365	5590	77	4657	90	6362
M100	94.367	6994	87	5945	100	7854
M105	99.368	7755	90	6362	105	8659
M110	104.371	8556	95	7088	110	9503
M120	114.371	10274	105	8659	120	11310
M130	124.371	12149	115	10387	130	13273
M135	129.371	13139	120	11310	135	14313
M140	134.371	14181	123	11882	140	15394
M145	139.371	15249	127	12667	145	16513
M150	144.371	16370	130	13273	150	17671

Note: The optimum bar diameter is generally selected after considering the actual working load, sacrificial corrosion allowance and the effects of strain.

\* Taking manufacturing tolerances into account when defining the minimum thread diameter can reduce the tensile area (based on nominal values) by up to 3% dependent upon the rod diameter.

The load in a tie rod can be difficult to determine with any great degree of accuracy due to factors such as the variability of the material retained and arching within the soil. The adoption of fairly large factors of safety in traditional designs, for what is a safety critical element, has reflected the uncertainty in this area. Under the limit state design philosophy adopted in this Handbook, this practice is continued and the ultimate anchor load is calculated by the application of a 1.85 factor to the reaction force derived by calculation based on limit equilibrium methods of analysis. Reaction forces derived from soil structure interaction methods do not need to have this factor applied as the effect of arching is already built in to the analysis.

## Retaining walls

Elongation of the tie rods under the design load should be checked. Movement under imposed loads may be reduced in many cases by pre-loading the tie rods at the time of installation to develop the passive resistance of the ground.

The effect of sag of the tie rods and forced deflection due to settlement of fill should also be considered. Bending stresses induced at a fixed anchorage may significantly increase the tensile stress in the tie rod locally. Shear stresses may also be induced if a tie rod is displaced when the fill settles causing compound stresses which must be allowed for in the detailed design. This can often be overcome by provision of articulated joints or settlement ducts.

---

### 6.7.1 Tie rod fittings

Tie rod assemblies will normally comprise two lengths of tie rod, a nut and a plate to suit the bearing conditions at each end, and usually a turnbuckle to permit length adjustment and to take out any sag. Individual tie rods are available in lengths up to approximately 20 metres – actual maximum length is different for different manufacturers - but if the length of the complete rod is such that more than two elements of bar are required, couplers with two right hand threads are also included.

Taper or special washers are used when the axis of a tie rod is not perpendicular to its seating. In some instances it is desirable to allow for rotation of the axis of a tie rod relative to the bearing face, and "articulated" anchorages are available for this purpose.

Plates are needed to transmit the load imposed on sheet piling to the tie rods and from the tie rods to the anchorages which may be further sheet piles, a concrete wall or individual concrete blocks. Washer plates are used when the tie rods are anchored within the pans of sheet piles and bearing plates when the load is transmitted through walings. When the load is taken to a concrete wall or block, anchorage plates distribute the load to the concrete. The waling loads are transmitted to the anchorages by means of anchor bolts which also require bearing plates and washers of sufficient size to provide adequate bearing onto the sheet piling, walings, etc.

# Retaining walls

## 6.7.2 Tie bar corrosion protection

Steel sheet piles are used in many aggressive environments and consequently corrosion protection or factors influencing effective life must be considered. Several options are available to the designer.

### 1 Unprotected steel

In this situation, consideration should be given to the probable corrosion rates and consequential loss of bar diameter in a particular environment as outlined in Chapter 3.

### 2 Protective Coatings

Several options are available, such as painting, galvanising or wrapping. The most commonly used method is to wrap tie bars to give an appropriate level of corrosion protection. The vulnerable anchor head should be protected, and Fig. 6.7.2 shows a suggested detail. Commonly adopted wrapping systems are indicated in table 6.7.2.

### 3 Cathodic protection for tie rods underwater

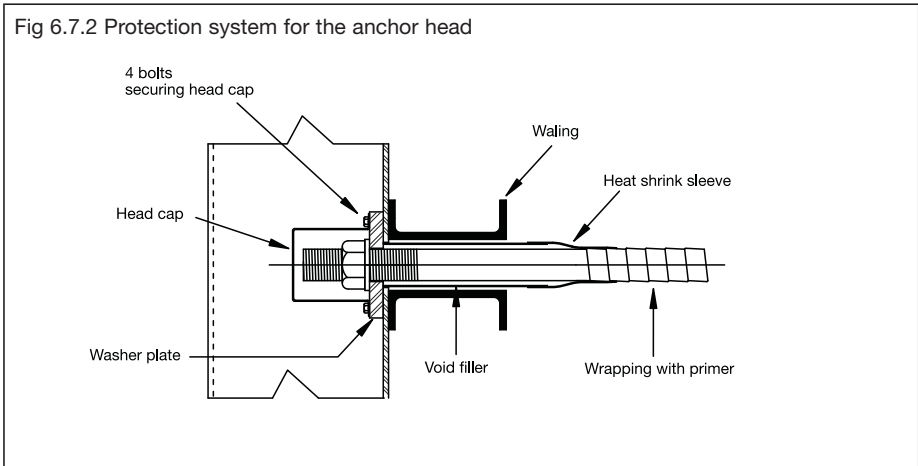



## Retaining walls

Table 6.7.2 Levels of protection using petrolatum fabric reinforced tape and rubber/bitumen tape

Description	Application	Shop/Site application method
Paste, soft petrolatum reinforced tape, 15mm overlap	Backfill, non tidal area or debond through concrete	Shop and site application Machine or hand application
As above, 55% overlap	Backfilled marine environment	Shop and site application Machine or hand application
As above, 55% and pvc overwrap	Backfilled marine environment also ease of handling	Shop and site application Machine or hand application
As above, 55% overlap, Denso Therm overwrap	Aggressive environments, marine environments	Shop application recommended. Machine or hand application
Denso Pol 60 tape system, 55% overwrap	Aggressive environments, marine environments, long life maritime structures.	Shop application only, Machine application only

### 6.7.3 Plates and washers

Dimensions of plates and washers can be obtained from suppliers literature or from their websites.

**6.7.4 Special fittings** Any bending in a tie rod, especially in the threaded length increases the stress locally with the possibility of yield or even failure if the bending is severe. In order to eliminate the risk of bending, several options are available which allow rotation of the axis of a tie rod while maintaining its tensile capacity. These include forged eye tension bars pinned to brackets on the sheet pile. Other options are nuts and washers with spherical seatings or pairs of taper washers which can be rotated to give any angle between zero and a predetermined maximum. The last two methods will cater for initial angularity but will not move to accommodate rotation in service.

## Retaining walls

**6.7.5 Site assembly** Tie rods are normally assembled with component bars supported to the correct level. Any slack is then taken out by tightening either a turnbuckle or the nut at one end. It is not possible to apply more than a nominal tension by tightening the end nut.

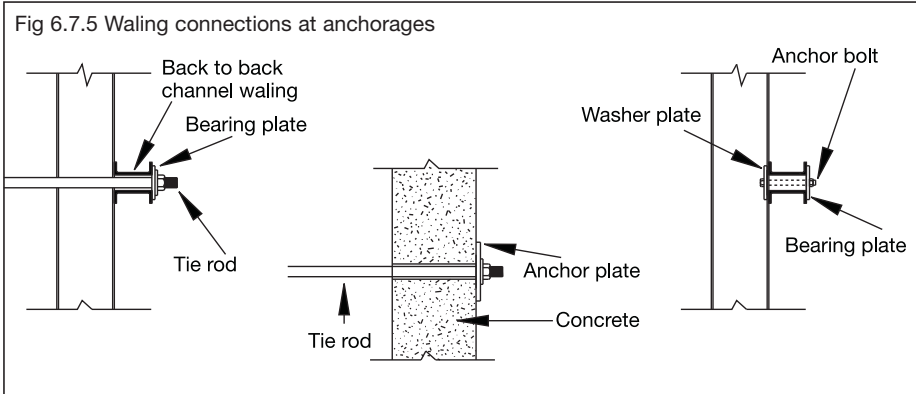

Tie bars perform best in pure tension, so it is good practice to ensure that this is achieved. The following is a recommended sequence of events to ensure that tie rods are installed and tensioned correctly.

- 1 Backfill to approximately 150mm below the finished level for the ties.
- 2 Place sand bags every 6m on either side of a coupler/turnbuckle or articulated joint.
- 3 Fit settlement ducts over the ties. (check the possibility of installing hinge joints or hinge turnbuckles)
- 4 Assemble with turnbuckles or couplers. The minimum screw in length of bar thread is 1 x nominal thread diameter.
- 5 Tension from the anchorage outside of the wall to take up the slack.
- 6 Tension turnbuckles.
- 7 Place sand fill over the settlement ducts.
- 8 Backfill to required level.

This procedure applies to a simple situation and additional activities may be considered for example, applying pretensioning to pull the piles in before final backfilling, stressing after backfilling to prevent future movement due to subsequent loading.

Further information on stressing is available on request from tie rod manufacturers.

# Retaining walls

## 6.8 Example calculations

This section contains sample calculations employing limit state design for the following cases:

- 1 Cantilever retaining wall.
- 2 Tied wall with free earth support.
- 3 Tied wall with fixed earth support.
- 4 Balanced anchorage.

In all the following examples, the friction angles indicated are moderately conservative and need to be factored to obtain design values

### 6.8.1 Cantilever retaining wall

A wall is to be built to support a retained height of 3.6 m of sandy soils. The effective wall height = 3.6 m + 10% = 3.96m say 4.0m (unplanned excavation allowance is 10% with 0.5m maximum)  
 Minimum surcharge loading = 10 kN/m<sup>2</sup>

Loose fine sand	$K_a = 0.317$	$K_p = 3.963$
Compact fine sand	$K_a = 0.260$	$K_p = 5.329$

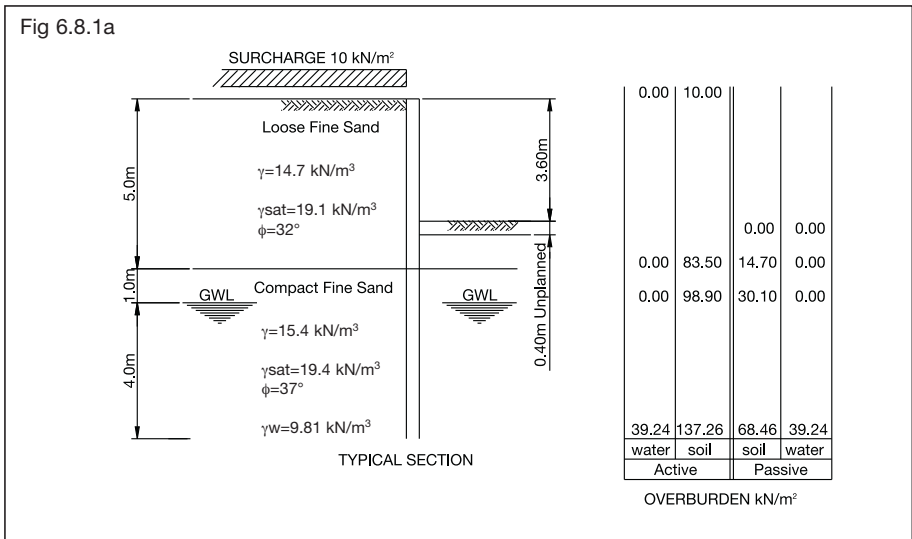

# Retaining walls

## Active pressures

Pa at 0.00m below G.L. in loose sand  
 $= 0.317 \times 10.00 + 0.00 = 3.17 \text{ kN/m}^2$

Pa at 5.00m below G.L. in loose sand  
 $= 0.317 \times 83.50 + 0.00 = 26.47 \text{ kN/m}^2$

Pa at 5.00m below G.L. in compact sand  
 $= 0.260 \times 83.50 + 0.00 = 21.71 \text{ kN/m}^2$

Pa at 6.00m below G.L. in compact sand  
 $= 0.260 \times 98.90 + 0.00 = 25.71 \text{ kN/m}^2$

Pa at 10.00m below G.L. in compact sand  
 $= 0.260 \times 137.26 + 39.24 = 74.93 \text{ kN/m}^2$

## Passive pressures

Pp at 4.00m below G.L. in loose sand  
 $= 3.963 \times 0.00 + 0.00 = 0.00 \text{ kN/m}^2$

Pp at 5.00m below G.L. in loose sand  
 $= 3.963 \times 14.70 + 0.00 = 58.26 \text{ kN/m}^2$

Pp at 5.00m below G.L. in compact sand  
 $= 5.329 \times 14.70 + 0.00 = 78.34 \text{ kN/m}^2$

Pp at 6.00m below G.L. in compact sand  
 $= 5.329 \times 30.10 + 0.00 = 160.40 \text{ kN/m}^2$

Pp at 10.00m below G.L. in compact sand  
 $= 5.329 \times 68.46 + 39.24 = 404.06 \text{ kN/m}^2$

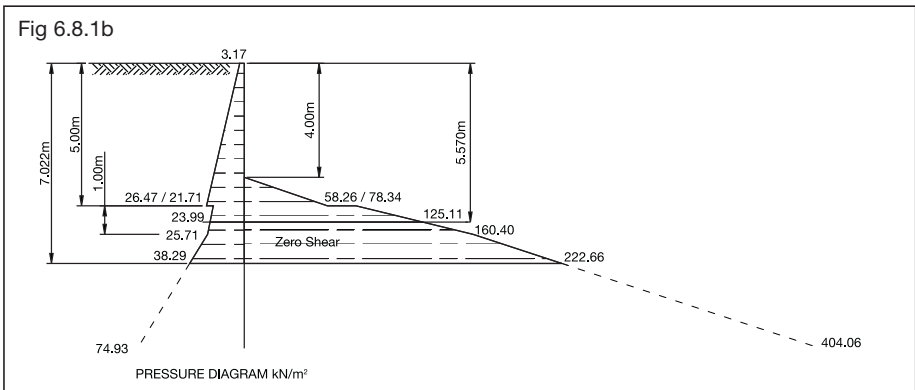

Since the pressure diagram is not uniform the depth of the toe is best found by trial and error which results in a length of 7.022m.

## Retaining walls

Take moments about the toe at 7.022m depth

### Active force

		<b>Force kN/m</b>		<b>Moment abt toe kNm/m</b>
$3.17 \times 5.000 \times 1/2$	=	7.93	x 5.355	= 42.44
$26.47 \times 5.000 \times 1/2$	=	66.17	x 3.689	= 244.12
$21.71 \times 1.000 \times 1/2$	=	10.86	x 1.689	= 18.33
$25.71 \times 1.000 \times 1/2$	=	12.86	x 1.355	= 17.42
$25.71 \times 1.022 \times 1/2$	=	13.14	x 0.681	= 8.95
$38.29 \times 1.022 \times 1/2$	=	19.57	x 0.341	= 6.67
		130.53		337.93

### Passive force

		<b>Force kN/m</b>		<b>Moment abt toe kNm/m</b>
$58.26 \times 1.000 \times 1/2$	=	29.13	x 2.355	= 68.60
$78.34 \times 1.000 \times 1/2$	=	39.17	x 1.689	= 66.16
$160.40 \times 1.000 \times 1/2$	=	80.20	x 1.355	= 108.67
$160.40 \times 1.022 \times 1/2$	=	81.96	x 0.681	= 55.82
$222.66 \times 1.022 \times 1/2$	=	113.78	x 0.341	= 38.80
		344.24		338.05

Since the passive moment is marginally greater than the active moment the length is OK

To correct the error caused by the use of the simplified method the depth below the point of equal active and passive pressure is increased by 20% to give the pile penetration.

Let the point of equal pressure be  $(4.00 + d)$  below ground level

$$\text{Then } \frac{58.26}{1.00} \times d = 3.17 + \frac{23.30}{5.00} \times (4.000 + d)$$

$$\text{Therefore } d = \frac{21.81}{58.26 - 4.66} = 0.407\text{m}$$

Hence the required pile length  
 $= 4.000 + 0.407 + 1.2 \times (3.022 - 0.407) = 7.545\text{m}$  say 7.55m

Zero shear occurs at 5.570m below ground level. (where the area of the active pressure diagram above the level equals the area of the passive pressure diagram above the level.)

## Retaining walls

Take moments about and above the level of zero shear:

	<b>kNm/m</b>
$3.17 \times 5.000 \times 1/2 \times 3.903$	= 30.93
$26.47 \times 5.000 \times 1/2 \times 2.237$	= 148.03
$21.71 \times 0.570 \times 1/2 \times 0.380$	= 2.35
$23.99 \times 0.570 \times 1/2 \times 0.190$	= 1.30
$-58.26 \times 1.000 \times 1/2 \times 0.903$	= -26.30
$-78.34 \times 0.570 \times 1/2 \times 0.380$	= -8.48
$-125.11 \times 0.570 \times 1/2 \times 0.190$	= -6.77
	141.06

Maximum bending moment = 141.1 kNm/m

Since the soil loadings determined in this example are based on factored soil parameters a partial factor of 1.2 is applied to give the ultimate design load.

Section modulus of pile required  
 $= 1.2 \times 141.1 \times 10^3 / 270 = 627 \text{ cm}^3/\text{m}$

Hence use PU7<sup>(1)</sup> piles ( $z = 670 \text{ cm}^3/\text{m}$ ) not less than  
 7.55m long in S270GP

However the designer will need to check the suitability of the section for driving and durability.

<sup>(1)</sup>Section properties of the section: see Table 13.1.1

# Retaining walls

## 6.8.2 Tied wall with free earth support

A wall is to be built to support a retained height of 7.00m (including the unplanned excavation allowance with a low tide level at 5.00m below the top of the wall.

Although the weep holes in the wall will allow the retained soil to drain the ground water will lag behind the tide and hence the ground water level on the retained side is assumed to be 1.00m above the low tide level.

It will be necessary to anchor the top of the wall and the ties are assumed to act at 1.00m below ground level.

Minimum surcharge loading = 10 kN/m<sup>2</sup>

Loose fine sand  $K_a = 0.317$   $K_p = 3.963$   
 Compact fine sand  $K_a = 0.260$   $K_p = 5.329$

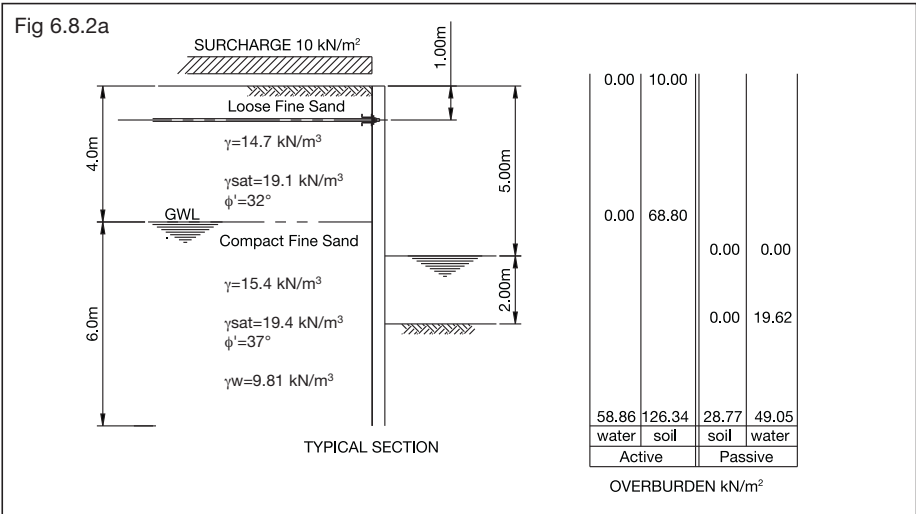

### Active pressures

$$Pa \text{ at } 0.00\text{m below G.L. in loose sand} = 0.317 \times 10.00 + 0.00 = 3.17 \text{ kN/m}^2$$

$$Pa \text{ at } 4.00\text{m below G.L. in loose sand} = 0.317 \times 68.80 + 0.00 = 21.81 \text{ kN/m}^2$$

$$Pa \text{ at } 4.00\text{m below G.L. in compact sand} = 0.260 \times 68.80 + 0.00 = 17.89 \text{ kN/m}^2$$

$$Pa \text{ at } 10.00\text{m below G.L. in compact sand} = 0.260 \times 126.34 + 58.86 = 91.71 \text{ kN/m}^2$$

# Retaining walls

## Passive pressures

$$P_p \text{ at } 7.00\text{m below G.L. in compact sand} \\ = 5.329 \times 0.00 + 19.62 = 19.62 \text{ kN/m}^2$$

$$P_p \text{ at } 10.00\text{m below G.L. in compact sand} \\ = 5.329 \times 28.77 + 49.05 = 202.37 \text{ kN/m}^2$$

Since the pressure diagram is not uniform the length of pile required to provide stability (i.e. Active moment = Passive moment) for rotation about the tie is found by trial and error to be 9.447m

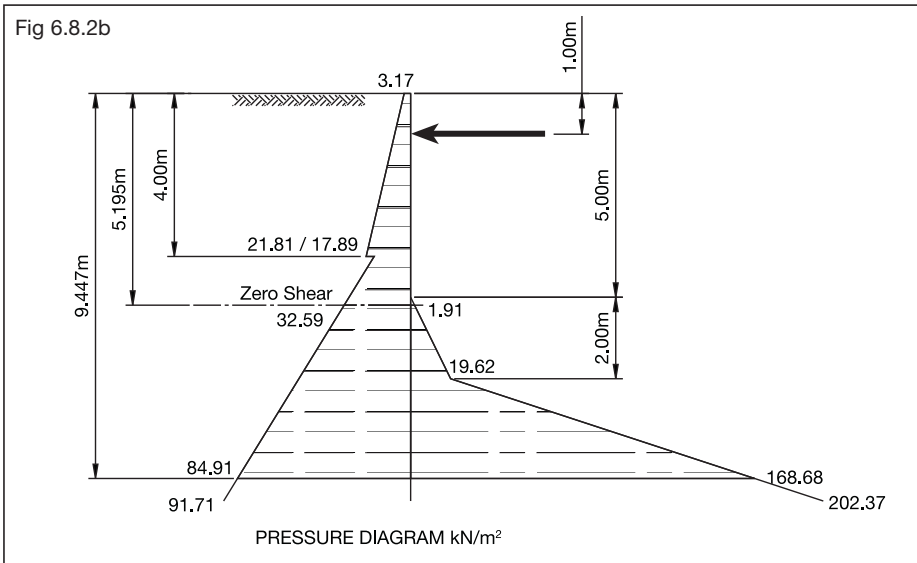

Taking moments of the active pressures about the top frame:

	<b>Active force kN/m</b>		<b>Active moment kNm/m</b>
$3.17 \times 4.000 \times 1/2$	= 6.34	$\times 0.333$	= 2.11
$21.81 \times 4.000 \times 1/2$	= 43.62	$\times 1.667$	= 72.71
$17.89 \times 5.447 \times 1/2$	= 48.72	$\times 4.816$	= 234.65
$84.91 \times 5.447 \times 1/2$	= 231.25	$\times 6.631$	= 1533.43
	<u>329.93</u>		<u>1842.90</u>



## Retaining walls

Taking moments of the passive pressures about the top frame:

		<b>Passive force kN/m</b>		<b>Active moment kNm/m</b>
$19.62 \times 2.000 \times 1/2$	=	19.62	x	5.333 = 104.63
$19.62 \times 2.447 \times 1/2$	=	24.00	x	6.816 = 163.62
$168.68 \times 2.447 \times 1/2$	=	206.38	x	7.631 = 1574.89
		250.00		1843.14

Passive moment is close enough to Active moment therefore OK

Tie load =  $329.93 - 250.00 = 79.93$  kN/m

Zero shear occurs at 5.195m below ground level. (where the area of the active pressure diagram less the area of the passive pressure diagram above the level equals the tie load.)

Take moments about and above the level of zero shear:

		<b>kNm/m</b>
$3.17 \times 4.000 \times 1/2 \times 3.862$	=	24.49
$21.81 \times 4.000 \times 1/2 \times 2.528$	=	110.27
$17.89 \times 1.195 \times 1/2 \times 0.797$	=	8.52
$32.59 \times 1.195 \times 1/2 \times 0.398$	=	7.75
$-1.91 \times 0.195 \times 1/2 \times 0.065$	=	-0.01
$-79.93 \times 4.195$	=	-335.31
		-184.29

Maximum bending moment with free earth support  
= 184.3 kNm/m

Since the soil loadings determined in this example are based on factored soil parameters a partial factor of 1.2 is applied to give the ultimate design load.

For piles in steel grade S270GP  $Y_s = 270$  N/mm<sup>2</sup>

Section modulus of pile required =  $1.2 \times 184.3 \times 10^3 / 270$   
= 819 cm<sup>3</sup>/m

Hence use PU8<sup>(1)</sup> piles ( $z = 830$  cm<sup>3</sup>/m) not less than 9.50m long in S270GP

However the designer will need to check the suitability of the section for driving and durability.

<sup>(1)</sup>Section properties of the section: see Table 13.1.1

# Retaining walls

## 6.8.3 Tied wall with fixed earth support

The conditions adopted for the free earth support example are used again to provide a comparison.

Minimum surcharge loading = 10 kN/m<sup>2</sup>

Loose fine sand  $K_a = 0.317$   $K_p = 3.963$

Compact fine sand  $K_a = 0.260$   $K_p = 5.329$

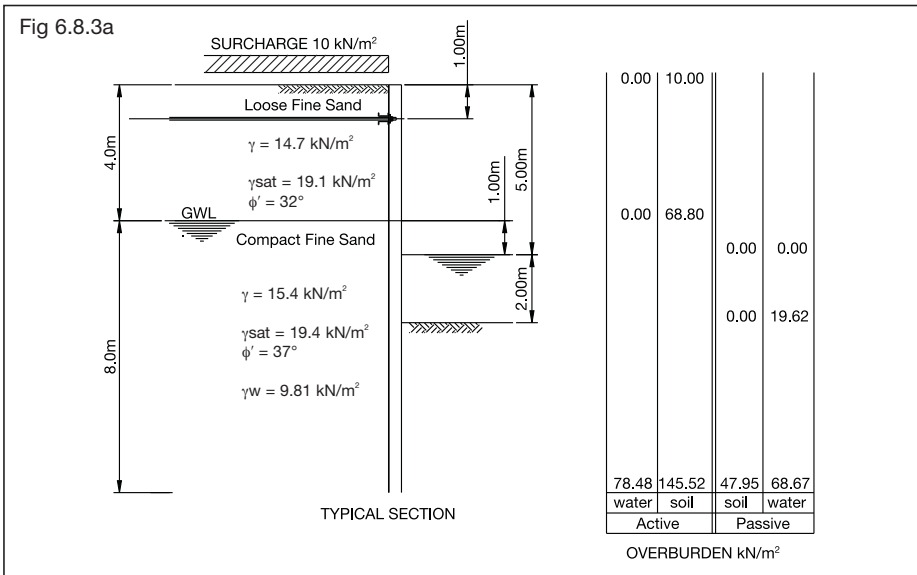

### Active pressures

$$P_a \text{ at } 0.00\text{m below G.L. in loose sand} = 0.317 \times 10.00 + 0.00 = 3.17 \text{ kN/m}^2$$

$$P_a \text{ at } 4.00\text{m below G.L. in loose sand} = 0.317 \times 68.80 + 0.00 = 21.81 \text{ kN/m}^2$$

$$P_a \text{ at } 4.00\text{m below G.L. in compact sand} = 0.260 \times 68.80 + 0.00 = 17.89 \text{ kN/m}^2$$

$$P_a \text{ at } 12.00\text{m below G.L. in compact sand} = 0.260 \times 145.52 + 78.48 = 116.32 \text{ kN/m}^2$$

### Passive pressures

$$P_p \text{ at } 7.00\text{m below G.L. in compact sand} = 5.329 \times 0.00 + 19.62 = 19.62 \text{ kN/m}^2$$

$$P_p \text{ at } 12.00\text{m below G.L. in compact sand} = 5.329 \times 47.95 + 68.67 = 324.20 \text{ kN/m}^2$$

# Retaining walls

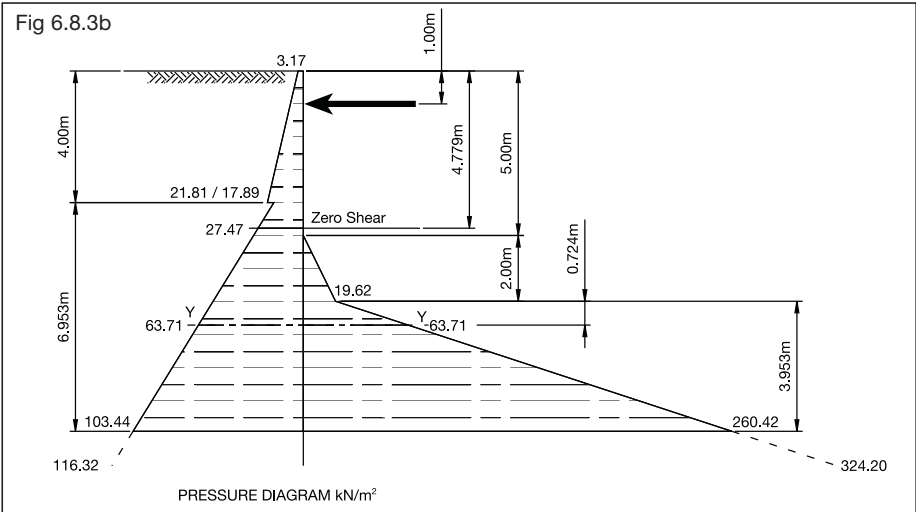

The simplified method for a fixed earth analysis assumes that the point of contraflexure in the bending moment diagram occurs at the level where the active pressure equals the passive pressure and hence the frame load can be calculated by taking moments about this level (Y-Y).

Let Y-Y be 7.00m + d below the retained ground level where  $P_a = P_p$

$$\text{Then } 17.89 + \frac{98.43}{8.00} \times 3 + \frac{98.43}{8.00} \times d = 19.62 + \frac{304.58}{5.00} \times d$$

$$\text{hence } 54.80 + 12.304d = 19.62 + 60.916d$$

$$\text{therefore } d = \frac{35.18}{48.612} = 0.724\text{m}$$

Take moments about Y-Y

	Force kN/m	Moment abt Y-Y kNm/m
$3.17 \times 4.000 \times 1/2$	$= 6.34$	$\times 6.391 = 40.52$
$21.81 \times 4.000 \times 1/2$	$= 43.62$	$\times 5.057 = 220.59$
$17.89 \times 3.724 \times 1/2$	$= 33.31$	$\times 2.483 = 82.71$
$63.71 \times 3.724 \times 1/2$	$= 118.63$	$\times 1.241 = 147.22$
$-19.62 \times 2.000 \times 1/2$	$= -19.62$	$\times 1.391 = -27.29$
$-19.62 \times 0.724 \times 1/2$	$= -7.10$	$\times 0.483 = -3.43$
$-63.71 \times 0.724 \times 1/2$	$= -23.06$	$\times 0.241 = -5.56$
	<u>152.12</u>	<u>454.76</u>

## Retaining walls

$$\text{Then frame load} = \frac{454.76}{6.724} = 67.63 \text{ kN/m}$$

The length of pile is found by taking moments about an assumed toe level such that the moments of all the forces are in equilibrium.

Since the pressure diagram is not uniform, and the equation for a direct solution will have cubic terms, the pile length is found by trial and error to be 10.953m

Taking moments about the toe of the pile

	<b>kNm/m</b>
$3.17 \times 4.000 \times 1/2 \times 9.620$	= 60.99
$21.81 \times 4.000 \times 1/2 \times 8.286$	= 361.44
$17.89 \times 6.953 \times 1/2 \times 4.635$	= 288.27
$103.44 \times 6.953 \times 1/2 \times 2.318$	= 833.57
$-19.62 \times 2.000 \times 1/2 \times 4.620$	= -90.64
$-19.62 \times 3.953 \times 1/2 \times 2.635$	= -102.18
$-260.42 \times 3.953 \times 1/2 \times 1.318$	= -678.40
$-67.63 \times 9.953$	= -673.12
	-0.07

To correct the error caused by the use of the simplified method the depth below the point of contraflexure is increased by 20% to give the pile penetration.

$$\text{Hence the required pile length} \\ = 7.00 + 0.724 + 1.2 \times (10.953 - 7.724) = 11.599\text{m}$$

Zero shear occurs at 4.779m below ground level. (where the area of the active pressure diagram above the level equals the top frame load.)

Take moments about and above the level of zero shear:

	<b>kNm/m</b>
$3.17 \times 4.000 \times 1/2 \times 3.446$	= 21.85
$21.81 \times 4.000 \times 1/2 \times 2.112$	= 92.13
$17.89 \times 0.779 \times 1/2 \times 0.519$	= 3.62
$27.47 \times 0.779 \times 1/2 \times 0.260$	= 2.78
$-67.63 \times 3.779$	= -255.57
	-135.19

$$\text{Maximum bending moment} = 135.2 \text{ kNm/m}$$

## Retaining walls

Since the soil loadings determined in this example are based on factored soil parameters a partial factor of 1.2 is applied to give the ultimate design load.

For piles in steel grade S270GP  $Y_s = 270 \text{ N/mm}^2$

Section modulus of pile required  
 $= 1.2 \times 135.2 \times 10^3 / 270 = 601 \text{ cm}^3/\text{m}$

Hence use PU6<sup>(1)</sup> piles ( $z = 600 \text{ cm}^3/\text{m}$ ) not less than 11.60m long in S270GP

However the designer will need to check the suitability of the section for driving and durability.

<sup>(1)</sup>Section properties of the section: see Table 13.1.1

# Retaining walls

## 6.8.4 Deadman anchorage example

The following example illustrates the method commonly used for the design of balanced anchorages. The conditions adopted are those used to design the retaining wall with fixed earth support conditions assumed at the toe of the main wall.

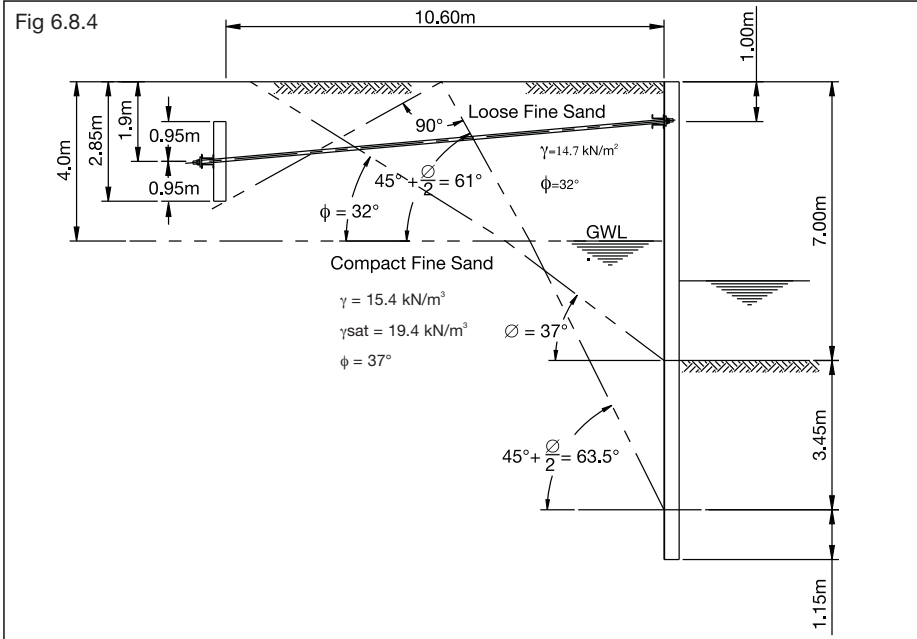

Waling load calculated using factored soil parameters and a fixed earth support = 68 kN/m

Since the design of the front wall used a Limit Equilibrium approach

Ultimate load for anchorage design =  $1.85 \times 68 = 125.8 \text{ kN/m}$

As explained in section 6.5.2 it is usual to provide a robust design for the anchorage and hence this example assumes a continuous anchor wall with a suitable waling.

Passive pressure in front of anchorage =  $K_p \gamma d$

Active pressure behind the anchorage =  $K_a w + K_a \gamma d$ , where  $w$  is the surcharge loading which is applied, as a worst case, behind the anchorage wall only

Hence  $T = (K_p - K_a) \gamma \frac{d^2}{2} - K_a w d$

## Retaining walls

This force is assumed to act at 2/3 depth but this may need to be checked, by taking moments about the toe of the pile for the various components, where there is a large surcharge and/or a high water table. If the toe of the pile is below the water table the calculation should be split and passive and active pressures calculated for each appropriate level in a manner similar to the main wall.

Since there is a lack of restraint against upward movement of the anchor wall skin friction is ignored and hence

$$K_a = 0.368 \text{ and } K_p = 2.716$$

For a 2.85m deep anchorage

$$T = (2.716 - 0.368) \times 14.7 \times \frac{2.85^2}{2} - 0.368 \times 10.00 \times 2.85$$

$$= 129.7 \text{ kN/m} > 125.8 \text{ kN/m} \therefore \text{OK}$$

$$\text{Average pressure on anchorage} = \frac{125.8}{1.90} = 66.2 \text{ kN/m}^2$$

$$\begin{aligned} \text{Bending moment in piles} &= 0.125wL^2 = 0.125 \times 66.2 \times 1.90^2 \\ &= 29.9 \text{ kNm/m} \end{aligned}$$

$$(L = \text{actual length of piles} = \frac{2}{3} \times 2.85 = 1.90\text{m})$$

Since the soil loadings determined in this example are based on factored soil parameters a partial factor of 1.2 is applied to give the ultimate design bending moment.

Hence minimum section modulus required

$$= \frac{1.2 \times 29.9}{270} \times 10^3 = 133 \text{ cm}^3/\text{m}$$

**Therefore use PU6<sup>(1)</sup> piles in steel grade S270GP by 1.9m long**

Assume the tie rods are at 3.60m centres i.e. every sixth pile.

The tie rods are inclined downwards at an angle of

$$\tan^{-1}\left(\frac{0.9}{10.60}\right) = 4.85^\circ$$

Then ultimate design load in tie rod

$$= \frac{1.2 \times 125.8 \times 3.60}{\cos 4.85^\circ} = 545.4 \text{ kN}$$

**Select a tie rod size from manufacturers literature to provide an ultimate resistance in excess of 545.4kN**

Ultimate design load on waling = 1.2 x 125.8 = 151.0 kN/m

Bending moment on waling = 0.1 x 151.0 x 3.60<sup>2</sup> = 195.7 kNm

Maximum shear load = 0.5 x 151.0 x 3.60 = 271.8 kN

<sup>(1)</sup>Section properties of the section: see Table 13.1.1

## Retaining walls

Subject to a check on torsion and shear, a waling formed from back to back UPN 240 channel sections in grade S275JO steel will provide the required moment capacity ( $M_{pl} = 196.9 \text{ kNm}$ )

However it may be necessary to check the exceptional circumstance of a tie failing, as outlined in Section 6.5.2.

For this condition a second pressure diagram should be constructed using un-factored soil parameters and without the unplanned excavation allowance. The depth to the point of equal active and passive pressures is found, moments taken about and above this level and the waling load calculated.

For this wall  $K_a$  for the loose sand is 0.262 and for the compact sand 0.209;  $K_p$  for the compact sand is 7.549 and the depth of excavation without the unplanned excavation allowance is 6.50m. This gives a waling load of 47.33 kN/m.

Hence the ultimate load for waling design  
 $= 1.85 \times 47.33 = 87.6 \text{ kN/m}$

Load in the tierods either side of the failed tie  
 $= \frac{1.2 \times 87.6 \times 1.5 \times 3.60}{\cos 4.85^\circ} = 569.7 \text{ kN}$

The resistance of the chosen tie rod must be checked against this revised value and the diameter increased if necessary.

Ultimate design load on waling  
 $= 1.2 \times 87.6 = 105.1 \text{ kN/m}$

Max bending moment in waling  
 $= 0.3 \times 105.1 \times 3.60^2 = 408.6 \text{ kNm}$

Since this is greater than the capacity of the previously designed waling the proposed section must be increased.

Maximum shear load  $= 0.5 \times 105.1 \times 2.0 \times 3.60 = 378.4 \text{ kN}$

Subject to a check on torsion and shear, a waling formed from back to back UPN 300 channel sections in grade S355JO steel will provide the required moment capacity ( $M_{pl} = 448.7 \text{ kNm}$ ).





ArcelorMittal

- 1** Product information
- 2** Sealants
- 3** Durability
- 4** Earth and water pressure
- 5** Design of sheet pile structures
- 6** Retaining walls
- 7** Cofferdams
- 8** Charts for retaining walls
- 9** Circular cell construction design & installation
- 10** Bearing piles and axially loaded sheet piles
- 11** Installation of sheet piles
- 12** Noise and vibration from piling operations
- 13** Useful information

# Cofferdams

## Contents

	Page
<b>7.1 Introduction</b>	1
<b>7.2 Requirements of a Cofferdam</b>	1
<b>7.3 Planning a Cofferdam</b>	2
<b>7.4 Causes of failure</b>	3
<b>7.5 Support arrangements</b>	3
<b>7.6 Design of Cofferdams</b>	4
<b>7.7 Single skin Cofferdams</b>	4
<b>7.8 Cofferdam arrangements</b>	7
7.8.1 Cofferdams for river crossings	7
7.8.2 Cofferdams with unbalanced loading (dock wall and riverside construction)	8
<b>7.9 Single skin Cofferdam design example</b>	9
<b>7.10 Design of support system</b>	21
<b>7.11 Cofferdam support frames</b>	22
<b>7.12 Strength of waling and struts</b>	23
<b>7.13 Circular Cofferdams</b>	26
<b>7.14 Reinforced concrete walings for circular Cofferdams</b>	28
<b>7.15 Earth filled double-wall and cellular Cofferdams</b>	29
<b>7.16 Double skin / wall Cofferdams</b>	29
<b>7.17 Cellular Cofferdams</b>	30
<b>7.18 Effect of water pressure</b>	30
<b>7.19 Flow nets</b>	33
<b>7.20 Factor of safety against piping</b>	35
<b>7.21 Pump sumps</b>	35
<b>7.22 Sealants</b>	36

# Cofferdams



# Cofferdams

## 7.1 Introduction

The purpose of a cofferdam is to exclude soil and/or water from an area in which it is required to carry out construction work to a depth below the surface. Total exclusion of water is often unnecessary, and in some instances may not be possible, but the effects of water ingress must always be taken into account in any calculations.

For basement construction the designer should always consider incorporating the cofferdam into the permanent works. Considerable savings in both time and money can be achieved by using the steel sheet piles as the primary permanent structural wall. The wall can be designed to carry vertical loading, see Chapter 10, and by the use of a suitable sealant system be made watertight. Details of suitable sealant systems can be found in Chapter 2.

Where control of ground movement is a specific concern the use of top down construction should be considered. This will ensure that movement of the top of the wall is restricted with the introduction of support at ground level prior to excavation starting and will also remove the possibility of secondary movement occurring when the lateral soil loading is transferred from the temporary supports, as they are removed, to the permanent structure.

There are two principal approaches to cofferdam design. Single skin structures are most commonly used but for very large or deep excavations and marine works double wall or cellular gravity structures may be preferred.

---

## 7.2 Requirements of a Cofferdam

The design of a cofferdam must satisfy the following criteria:-

- The structure must be able to withstand all the various loads applied to it.
- The quantity of water entering the cofferdam must be controllable by pumping.
- At every stage of construction the formation level must be stable and not subject to uncontrolled heave, boiling or piping.
- Deflection of the cofferdam walls and bracing must not affect the permanent structure or any existing structure adjacent to the cofferdam.
- Overall stability must be shown to exist against out of balance earth pressures due to sloping ground or potential slip failure planes.
- The cofferdam must be of an appropriate size to suit the construction work to be carried out inside it.

## Cofferdams

- Temporary cofferdams must be built in such a way that the maximum amount of construction materials can be recovered for reuse.

---

### 7.3 Planning a Cofferdam

The designer of a cofferdam must have an established set of objectives before commencing the design. The sequence of construction activities must be defined in order that the design can take into account all the load cases associated with the construction and dismantling of the cofferdam. From this sequence the designer can identify the critical design cases and hence calculate the minimum penetrations, bending moments and shear forces to determine the pile section and length required.

As part of the analysis of the construction activities the designer should undertake a risk assessment of the effect of any deviation from the planned sequence. Such deviations may be in the form of over excavation at any stage, inability to achieve the required pile penetration, installation of the support at the wrong level or the imposition of a large surcharge loading from construction plant or materials. If any stage in the cofferdam construction is particularly vulnerable then contingency plans should be developed to minimise any risk and the site management should be informed to limit the possibility of critical conditions being realised.

The majority of cofferdams are constructed as temporary works and it may be uneconomic to design for all possible loading cases. Decisions will have to be taken, normally involving the site management, to determine the level of risk that is acceptable when assessing the design cases; such a situation may occur when assessing hydraulic loading on a cofferdam. Flood conditions tend to be seasonal and provision of a cofferdam which will exclude water at all times may involve a substantial increase in pile size and strength as well as increased framing. In an extreme flood condition the design philosophy may involve evacuation of the cofferdam and allowing it to overtop and flood. Under these conditions the designer must allow for the overtopping, considering the effect of the sudden ingress of water on the base of the cofferdam and the effect that any trapped water may have on the stability when the flood subsides.

Prior to the commencement of construction the site area should be cleared to permit plant and guide frames to be set up. Excavation should not begin until all the plant and materials for supporting the piles are readily available including pumping equipment where necessary.

Once excavation is complete the cofferdam and support frames should be monitored to ensure that they are performing as

## Cofferdams

expected and to provide as early a warning as possible of any safety critical problems. It is good practice to maintain a written record of such monitoring - in the UK this is a legal requirement. Some possible causes of failure are given below and it will be seen that a number of them relate to problems that may well occur after the cofferdam is finished.

---

**7.4 Causes of failure** There are many possible causes of cofferdam failure but in practice it can generally be attributed to one or more of the following:

- Lack of attention to detail in the design and installation of the structure.
- Failure to take the possible range of water levels and conditions into account.
- Failure to check design calculations with information discovered during excavation.
- Over excavation at any stage in the construction process.
- Inadequate framing (both quantity and strength) provided to support the loads.
- Loading on frame members not taken into account in the design such as walings and struts being used to support walkways, materials, pumps etc..
- Accidental damage to structural elements not being repaired.
- Insufficient penetration to prevent piping or heave. Failure to allow for the effect on soil pressures of piping or heave.
- Lack of communication between temporary works and permanent works designers; designers and site management or site management and operatives.

In many cases failure may result from the simultaneous occurrence of a number of the above factors, any one of which might not have been sufficient, on its own, to cause the failure.

---

## 7.5 Support arrangements

The arrangement of supports to a cofferdam structure is the most critical part of a cofferdam design. The level at which the support is provided governs the bending moments in the sheet piles and the plan layout governs the ease of working within the structure. Whilst structural integrity is paramount, the support layout must be related to the proposed permanent works construction activities causing the minimum obstruction to plant and materials access. As a general rule simplicity should always be favoured.

## Cofferdams

Support frames should be located such that concrete lifts can be completed and the support load transferred to the permanent works before the frame is removed. Clearance to starter bars for the next lift should be considered when positioning frames.

The clear space between frame members should be optimised to provide the largest possible uninterrupted area without the need for excessively large structural elements. Positioning of support members is often a matter of experience.

---

### 7.6 Design of Cofferdams

The design of embedded retaining walls is covered in general terms in chapter 5 but the following comments are of particular relevance to the design and construction of cofferdams.

The life of the cofferdam structure must be assessed in order that the appropriate geotechnical parameters for the soils, in which the cofferdam is to be constructed, can be selected. In the majority of cases total stress parameters can be used since the cofferdam is a temporary structure. However the susceptibility of any clay to the rapid attainment of a drained state must be assessed by the designer and if there is any doubt a check should be made on the final structure using effective stress parameters.

As a rule of thumb it is recommended that cofferdams which are to be in service for three months or more should be designed using effective stress strength parameters. However, the presence of silt laminations or layers within clays can lead to very rapid attainment of drained conditions and hence it may be appropriate to use effective stress parameters for much shorter periods.

---

### 7.7 Single skin Cofferdams

Single skin cofferdams are typically formed of sheet piles supported either by means of internal props or external anchors. The mechanics of single skin cofferdam design are those already outlined in Chapters 5 and 6. The piles are considered to be simply supported between frames and below the lowest frame and will need to be driven to such a level, depending on the type of soil, as to generate sufficient passive resistance. However, where there are at least two frames, if the cut-off of the piles below the excavation is insufficient to provide the necessary passive support the wall will still be stable and the pile below the lowest frame can be considered as a cantilever. This will, however, give rise to large loads in the lowest frame and should be avoided whenever possible.

In all cases the penetration below formation level will need to be sufficient to control the infiltration of water into the excavation.

# Cofferdams

Records should be kept during driving for any indication of declutching of the piles. In such a case it may be necessary to grout behind the piles in order to control seepage. Cantilever pile cofferdams can be formed but have the same limitations as cantilever retaining walls particularly in terms of the achievable retained height.

When the cofferdam has very large plan dimensions, but relatively shallow depth, it is often more economical to incorporate inclined struts or external anchorages similar to those described in chapter 6. It should not however be forgotten that the installation of external anchorages requires space which is outside the cofferdam area and wayleaves may be required to install the anchors under adjacent properties.

For a typical cofferdam with a depth exceeding 3m, a system of internal frames in the form of steel sections or proprietary bracing equipment is normally employed.

The design should be undertaken in stages to reflect accurately the construction process. Typically the sequence of operations would be to excavate and dewater to just below top frame level then install the first frame; this procedure being repeated for each successive frame. In the case of cofferdams in water it should be noted that the stresses occurring during dewatering and frame installation may be considerably in excess of those in the completed cofferdam. For cofferdams in water it is advisable to use a proprietary interlock sealant as described in Chapter 2. When a cofferdam is to be used solely for the purpose of excluding water and the depth of soil to be excavated is only nominal it is often more efficient to install all the framing under water before commencing dewatering.

Fig 7.7.1 shows the optimum spacing of frames for this method of construction. The spacing results in approximately equal loading on the second and successive frames. Figure 7.7.2 indicates the maximum spacing between the top and second frames with respect to section modulus of the pile wall.



# Cofferdams

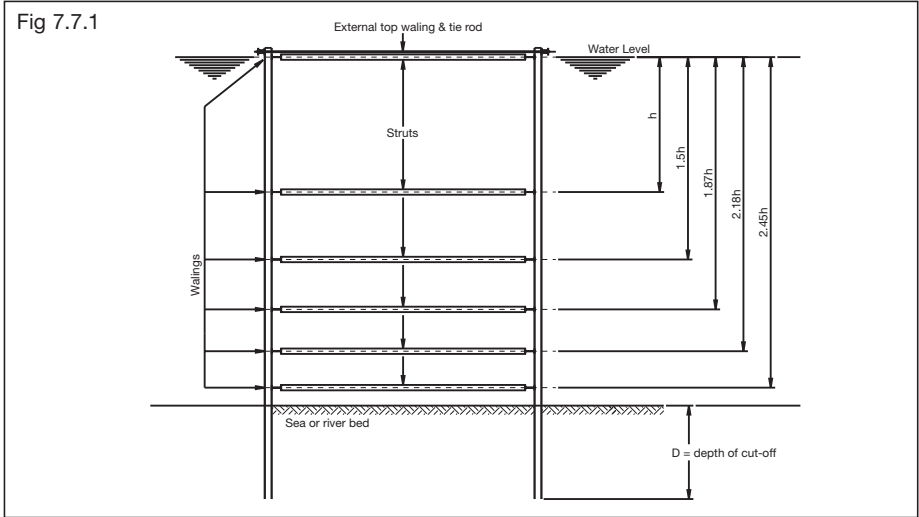

The above is based on the approximate equation:-

$$h^3 = 1.3 \times Z \times f_y \times 10^{-3}$$

where Z = section modulus in  $\text{cm}^3/\text{m}$

It should be noted that when depth (h) exceeds about 8m the waling loads may become excessive.

Fig 7.7.2 Depth v Section Modulus

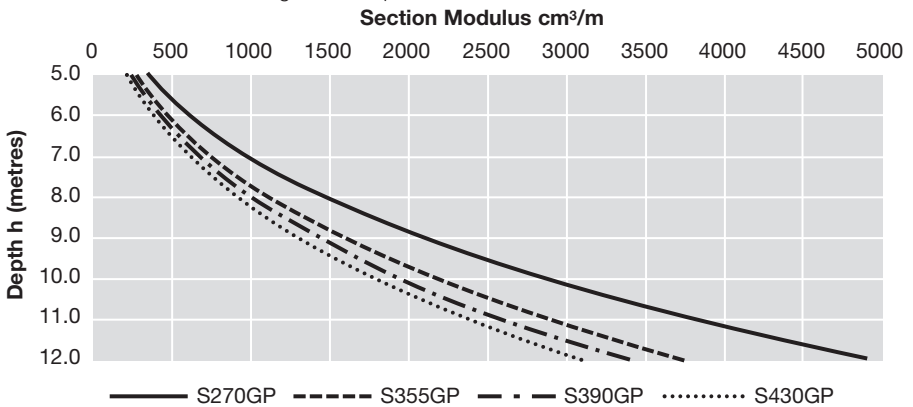

# Cofferdams

## 7.8 Cofferdam arrangements

### 7.8.1 Cofferdams for river crossings

When a pipeline has to be laid under a river bed and it is not possible to close off the waterway the cofferdam may be constructed in two or more stages using the arrangement shown in fig 7.8.1.

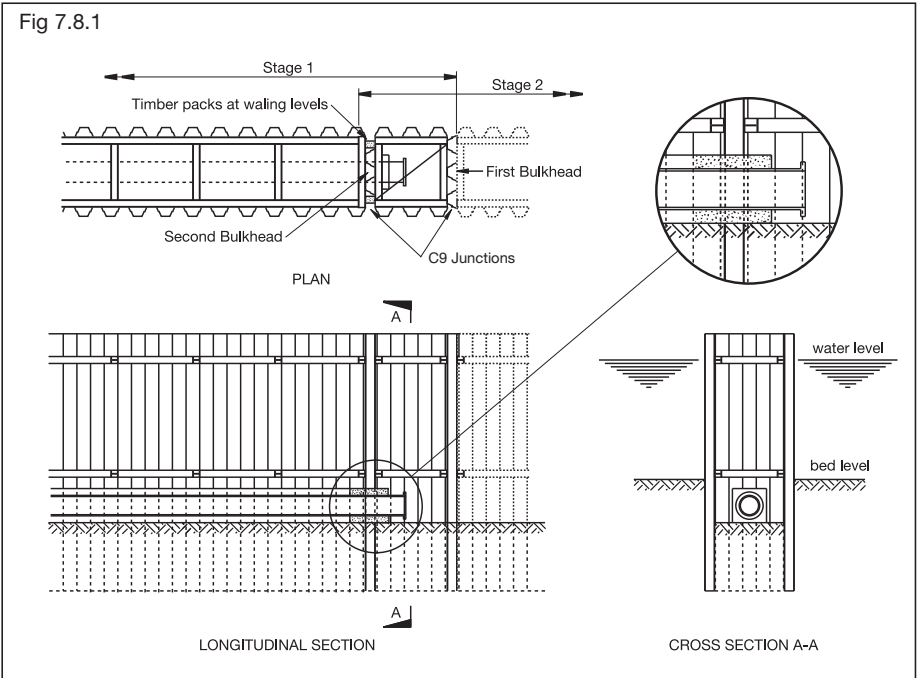

# Cofferdams

## 7.8.2 Cofferdams with unbalanced loading (dock wall and riverside construction)

This type of cofferdam is usually subjected to greater loading on the landward side due to soil pressure plus construction loads hence special precautions may be needed to overcome the resulting unbalanced loading. The method used will, of course, depend upon the specific site conditions but the following methods are suggested as general practice subject to approval by the relevant supervising authority:-

- Method A – the removal of soil from the landward side
- Method B – the use of 'fill' on the water side of the cofferdam
- Method C – the use of external anchorages to the landward side
- Method D – the use of raking struts inside the cofferdam

These methods are illustrated in Fig 7.8.2.

Fig 7.8.2 Construction of cofferdams in river banks

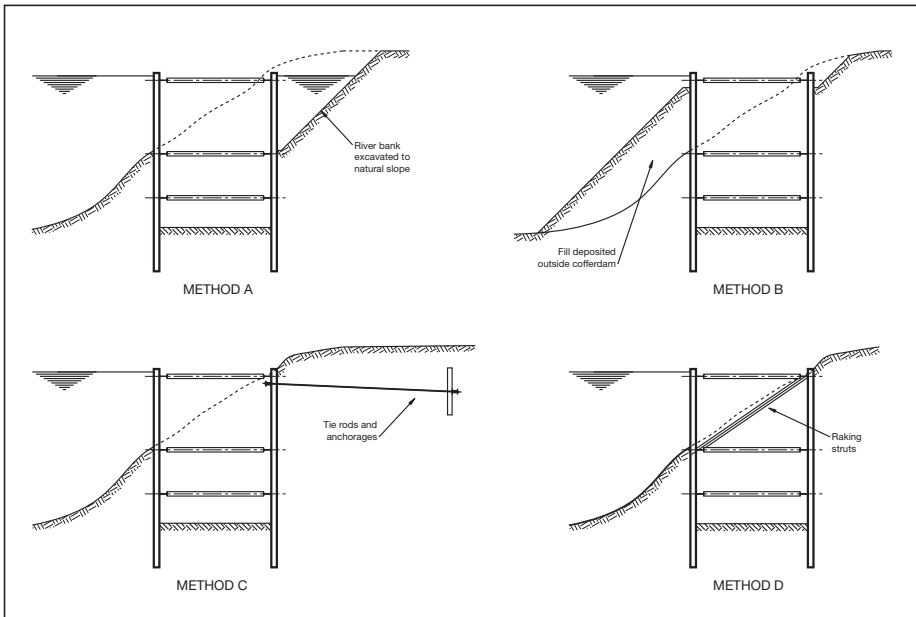

# Cofferdams

## 7.9 Single skin Cofferdam design example

The following example is based upon the soil conditions used for the earth pressure calculation example, at a nominal excavation depth of 7.90m, included in Chapter 4. A number of issues in the design of cofferdams are illustrated in this example. The iterative nature of cofferdam design, particularly for the positioning of frames, lends itself to computer calculation methods but this example has been manually prepared to illustrate the steps to be followed in the calculation process.

The diagram below indicates the soil stratification and relevant properties, the water levels on each side of the wall and the proposed final excavation level. The active earth pressures are those calculated previously, in the example in Chapter 4 for the short term total stress condition. This is considered to be appropriate for a temporary works construction that will only be open for a limited period of time. The passive pressures are calculated for the short term total stress condition, for the appropriate excavation level at each stage.

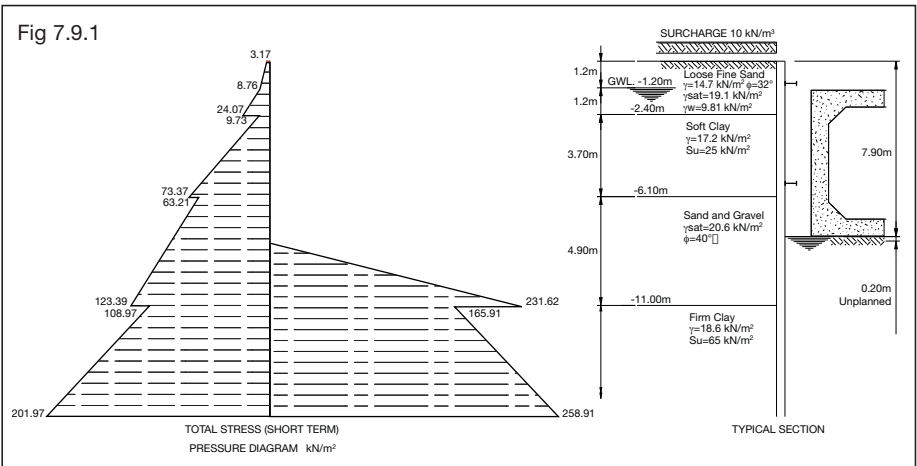

The proposed construction sequence has been assumed to be:

- 1** Install sheet piles and excavate, including dewatering, for top frame
- 2** Install top frame and excavate, including dewatering, for bottom frame
- 3** Install bottom frame and excavate to the final level

In this example, the analysis of the sheet piles assumes the presence of a hinge at the lower prop position to make the problem statically determinate. The problem can, using this

# Cofferdams

assumption, be treated as two single propped retaining walls. It is also assumed that the control of excavation levels will be good and therefore no allowance is made, in the intermediate construction stages, for unplanned excavation. For the final construction stage an allowance of 0.20m of over excavation will be included.

## Stage 1 : Excavate for Top Frame

Before placing the top frame the piles will act in cantilever. The pressure diagram for this case, assuming excavation to 1.5m, is given in the figure below. Clearly, in this example, the pile length and bending strength required for later stages will be much greater than required at this initial stage and hence no calculations have been carried out.

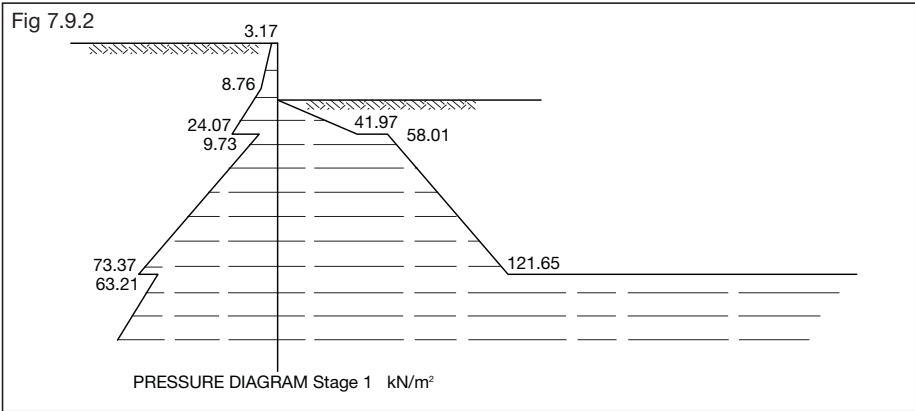

## Stage 2 : Excavate for Bottom Frame

The top frame is assumed to be 1m below the ground surface. We will assume in this example that the lower frame is positioned 5.5m below the ground surface. This assumption is based on experience to provide clearance for construction of the base slab and wall kicker.

The excavation depth required to install the lower frame, providing sufficient working space, is therefore 6.1m.

$$P_p \text{ at 6.1m below ground level in sand and gravel} \\ = 6.493 \times 0.00 = 0 \text{ kN/m}^2$$

$$P_p \text{ at 11m below ground level in sand and gravel} \\ = (6.493 \times 52.87) + 48.07 = 391.35 \text{ kN/m}^2$$

$$P_p \text{ at 11m below ground level in firm clay} \\ = 1.00 \times 100.94 + (2.45 \times 65/1.5) = 207.11 \text{ kN/m}^2$$

$$P_p \text{ at 16m below ground level in firm clay} \\ = 1.00 \times 193.94 + (2.45 \times 65/1.5) = 300.11 \text{ kN/m}^2$$

# Cofferdams

The pressure diagram for this condition is given below:

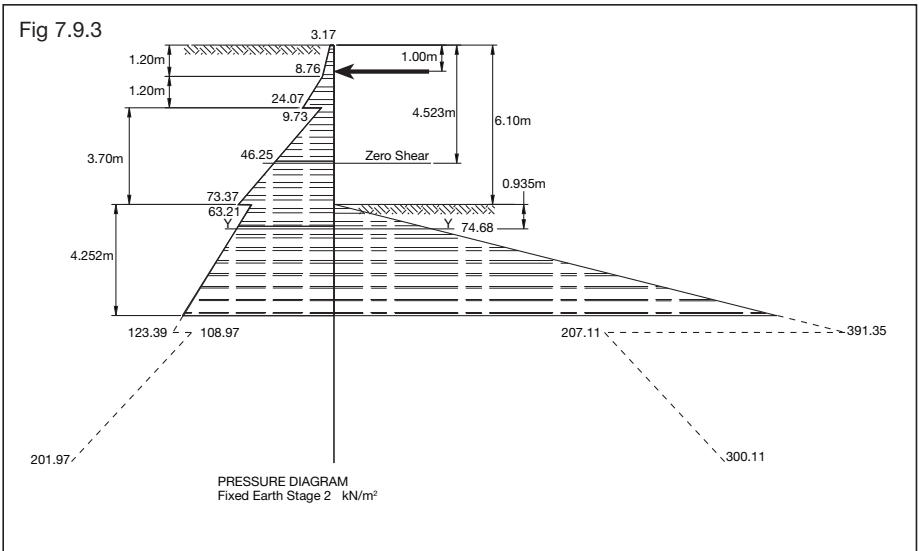

## Fixed Earth Support Option

At this stage it may be appropriate to consider a fixed earth support condition as the pile length needed in the final stage may well be long enough to provide fixity at the toe for this lesser excavation depth. Since the simplified method assumes that the point of contraflexure in the bending moment diagram occurs at the level where the active pressure equals the passive pressure the frame load can be calculated by taking moments about this level (Y-Y).

Let Y-Y be  $y$  below  $-6.10\text{m}$  level where  $P_a = P_p$

$$\text{Then } 63.21 + \frac{60.18}{4.9} \times y = \frac{391.35}{4.9} \times y$$

$$\text{hence } y = 63.21 \times 4.9 / 331.17 = 0.935\text{m}$$

Take moments about Y-Y

	Force kN/m	Moment abt Y-Y kNm/m
$3.17 \times 1.200 \times \frac{1}{2}$	$= 1.90$	$\times 6.635 = 12.62$
$8.76 \times 1.200 \times \frac{1}{2}$	$= 5.26$	$\times 6.235 = 32.77$
$8.76 \times 1.200 \times \frac{1}{2}$	$= 5.26$	$\times 5.435 = 28.57$
$24.07 \times 1.200 \times \frac{1}{2}$	$= 14.44$	$\times 5.035 = 72.72$
$9.73 \times 3.700 \times \frac{1}{2}$	$= 18.00$	$\times 3.402 = 61.24$
$73.37 \times 3.700 \times \frac{1}{2}$	$= 135.73$	$\times 2.168 = 294.27$
$63.21 \times 0.935 \times \frac{1}{2}$	$= 29.55$	$\times 0.623 = 18.41$
$74.68 \times 0.935 \times \frac{1}{2}$	$= 34.91$	$\times 0.312 = 10.89$
$-74.68 \times 0.935 \times \frac{1}{2}$	$= -34.91$	$\times 0.312 = -10.89$
	<b>210.14</b>	<b>520.60</b>

# Cofferdams

$$\text{Then frame load} = \frac{520.60}{6.035} = 86.26 \text{ kN/m}$$

The length of pile is found by taking moments about an assumed toe level such that the moments of all the forces are in equilibrium

From the calculation above

$$\text{total active force above } -6.10\text{m} = 180.59 \text{ kN/m}$$

$$\text{total active moment above } -6.10\text{m} = 502.19 \text{ kNm/m}$$

$$\text{This force acts at } \frac{502.19}{180.59} = 2.781\text{m above Y-Y}$$

or 1.846m above -6.10m

Assume the pile penetration below -6.10m is d

Then taking moments about the toe

clockwise moments =

$$180.59 \times (1.846+d) + \frac{63.21}{2} \times \frac{2d^2}{3} + (63.21 + \frac{60.18}{4.9}xd) \times \frac{d^2}{6}$$

$$\text{anticlockwise moment} = \frac{391.35}{4.9} \times \frac{d^3}{6} + 86.26 \times (5.10+d)$$

Equating clockwise moments to anticlockwise moments produces a cubic equation which is solved by successive approximations giving d= 4.252m.

To correct the error caused by the use of the simplified method the depth below the point of contraflexure is increased by 20% to give the pile penetration.

Hence the required pile length

$$= 6.10 + 0.935 + 1.2 \times (4.252 - 0.935) = 11.015\text{m say } 11.02\text{m}$$

Zero shear occurs at 4.523m below ground level. (Where the area of the active pressure diagram above the level equals the top frame load).

Take moments about and above the level of zero shear:

	=	<b>kNm/m</b>
3.17 x 1.200 x 1/2 x 4.123	=	7.84
8.76 x 1.200 x 1/2 x 3.723	=	19.57
8.76 x 1.200 x 1/2 x 2.923	=	15.36
24.07 x 1.200 x 1/2 x 2.523	=	36.44
9.73 x 2.123 x 1/2 x 1.415	=	14.61
46.25 x 2.123 x 1/2 x 0.708	=	34.76
-86.26 x 3.523	=	-303.89
		<b>-175.31</b>

Maximum bending moment with fixed earth support = 175.3 kNm/m

# Cofferdams

## Free Earth Support Option

However if the pile length for the final stage is shorter than 11.02m, the design for this intermediate stage should be considered as free earth. The passive pressures are as before and the pressure diagram is shown below:

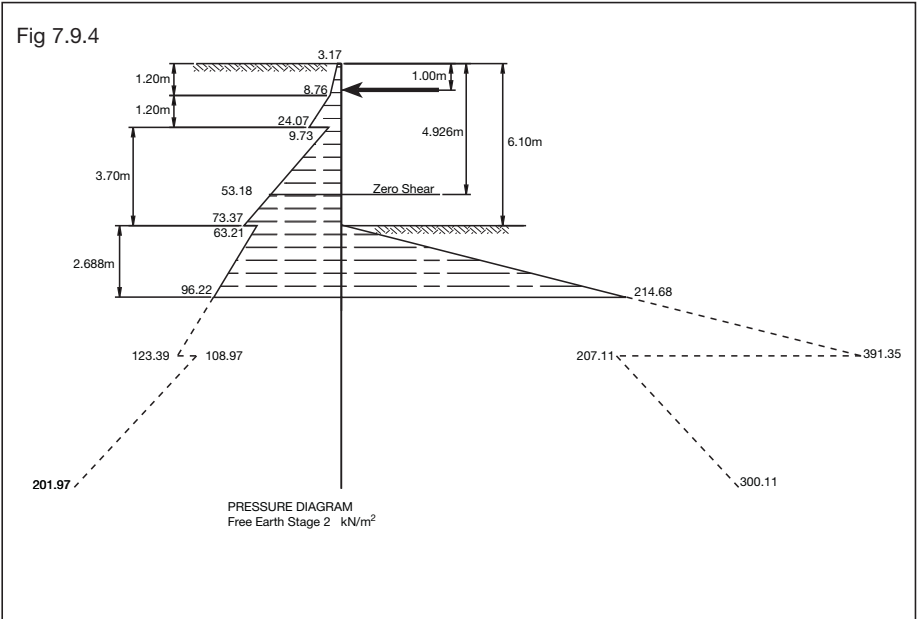

The length of pile required to provide stability (i.e. Active moment = Passive moment) for rotation about the top frame is found by trial and error to be 8.788m

Taking moments of the active pressures about the top frame:

	Active Force kN/m		Active Moment kNm/m
$3.17 \times 1.200 \times \frac{1}{2}$	= 1.90	x -0.600	= -1.14
$8.76 \times 1.200 \times \frac{1}{2}$	= 5.26	x -0.200	= -1.05
$8.76 \times 1.200 \times \frac{1}{2}$	= 5.26	x +0.600	= 3.15
$24.07 \times 1.200 \times \frac{1}{2}$	= 14.44	x +1.000	= 14.44
$9.73 \times 3.700 \times \frac{1}{2}$	= 18.00	x +2.633	= 47.40
$73.37 \times 3.700 \times \frac{1}{2}$	= 135.73	x +3.867	= 524.89
$63.21 \times 2.688 \times \frac{1}{2}$	= 84.95	x +5.996	= 509.39
$96.22 \times 2.688 \times \frac{1}{2}$	= 129.32	x +6.892	= 891.27
	<b>394.86</b>		<b>1988.35</b>



# Cofferdams

Taking moments of the passive pressure about the top frame:

$$\text{Passive force} = 214.68 \times 2.688 \times \frac{1}{2} = 288.53 \text{ kN/m}$$

$$\text{Passive moment} = 288.53 \times 6.892 = 1988.55 \text{ kNm/m}$$

[equal to Active Moment therefore OK]

$$\text{Top frame load} = 394.86 - 288.53 = 106.33 \text{ kN/m}$$

Zero shear occurs at 4.926m below ground level. (Where the area of the active pressure diagram above the level equals the top frame load).

Take moments about and above the level of zero shear:

	=	kNm/m
3.17 x 1.200 x 1/2 x 4.526	=	8.61
8.76 x 1.200 x 1/2 x 4.126	=	21.69
8.76 x 1.200 x 1/2 x 3.326	=	17.48
24.07 x 1.200 x 1/2 x 2.926	=	42.26
9.73 x 2.526 x 1/2 x 1.684	=	20.69
53.18 x 2.526 x 1/2 x 0.842	=	56.55
-106.33 x 3.926	=	-417.45
		<b>-250.17</b>

Maximum bending moment with free earth support = 250.2 kNm/m

### Final Stage : Excavate to Formation Level

With the lower frame installed at 5.5m below ground level excavation is carried out to final level. The design is to include for 0.20m of unplanned excavation so the passive pressures are calculated for an excavation depth of 8.10m

$$P_p \text{ at 8.1m below ground level in sand and gravel} \\ = 6.493 \times 0.00 = 0 \text{ kN/m}^2$$

$$P_p \text{ at 11m below ground level in sand and gravel} \\ = (6.493 \times 31.29) + 28.45 = 231.62 \text{ kN/m}^2$$

$$P_p \text{ at 11m below ground level in firm clay} \\ = 1.00 \times 59.74 + (2.45 \times 65/1.5) = 165.91 \text{ kN/m}^2$$

$$P_p \text{ at 16m below ground level in firm clay} \\ = 1.00 \times 152.74 + (2.45 \times 65/1.5) = 258.91 \text{ kN/m}^2$$

# Cofferdams

The pressure diagram for this condition is given below:

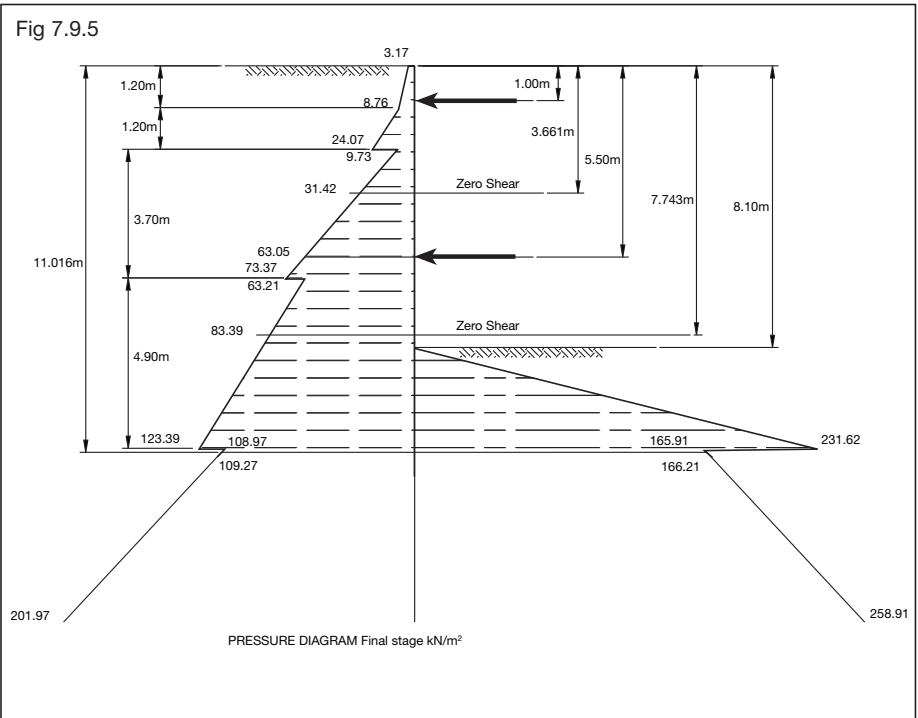

The depth of cut off is found by considering the piles to be simply supported at the bottom frame position due to the assumption of a hinge at the support position.

Consider first the lower span. The pile length for stability is found, by trial and error, to be 11.016m.

Taking moments of the active pressures about the bottom frame:

	Active Force kN/m			Active Moment kNm/m
63.05 x 0.600 x 1/2	= 18.92	x	0.200	= 3.78
73.37 x 0.600 x 1/2	= 22.01	x	0.400	= 8.80
63.21 x 4.900 x 1/2	= 154.86	x	2.233	= 345.81
123.39x 4.900 x 1/2	= 302.31	x	3.867	= 1169.02
108.97x 0.016 x 1/2	= 0.87	x	5.505	= 4.80
109.27x 0.016 x 1/2	= 0.87	x	5.511	= 4.82
	<u>499.84</u>			<u>1537.03</u>

# Cofferdams

Taking moments of the passive pressure about the bottom frame:

		<b>Passive Force kN/m</b>				<b>Active Moment kNm/m</b>
231.62x 2.900 x 1/2	=	335.85	x	4.533	=	1522.40
165.91x 0.016 x 1/2	=	1.33	x	5.505	=	7.31
166.17x 0.016 x 1/2	=	1.33	x	5.511	=	7.33
		<u>338.51</u>				<u>1537.04</u>

(Active Moment and Passive Moment are equal therefore OK)

For the lower span bottom frame load  
 = 499.84 – 338.51 = 161.33 kN/m

Zero shear occurs at 7.743m below ground level. (This is where the area of the active pressure diagram below the bottom frame and above the zero shear level equals the bottom frame load calculated above).

Take moments about and above the level of zero shear  
 (for the lower span):

		<b>kNm/m</b>
83.39 x 1.643 x 1/2 x 0.548	=	37.54
63.21 x 1.643 x 1/2 x 1.095	=	66.86
73.37 x 0.600 x 1/2 x 1.843	=	40.57
63.05 x 0.600 x 1/2 x 2.043	=	38.64
-161.33 x 2.243	=	<u>-361.86</u>
		<b>-188.25</b>

Now consider the upper span

Taking moments of the active pressures about the bottom frame:

		<b>Active Force kN/m</b>				<b>Active Moment kNm/m</b>
3.17 x 1.200 x 1/2	=	1.90	x	5.100	=	9.70
8.76 x 1.200 x 1/2	=	5.26	x	4.700	=	24.70
8.76 x 1.200 x 1/2	=	5.26	x	3.900	=	20.50
24.07 x 1.200 x 1/2	=	14.44	x	3.500	=	50.55
9.73 x 3.100 x 1/2	=	15.08	x	2.067	=	31.17
63.05 x 3.100 x 1/2	=	97.73	x	1.033	=	100.95
		<u>139.67</u>				<u>237.57</u>

Then top frame load = 237.57/4.500 = 52.79 kN/m

And hence total load in bottom frame  
 = (139.67 – 52.79) + 161.33 = 248.21 kN/m

Zero shear occurs at 3.661m below ground level.

# Cofferdams

Take moments about and below the level of zero shear:

		<b>kNm/m</b>
31.42 x 1.839 x 1/2 x 0.613	=	17.71
63.05 x 1.839 x 1/2 x 1.226	=	71.08
-86.88 x 1.839	=	-159.77
		<b>-70.98</b>

Table 7.9.1 Summary

		Stage 2		Final Stage
		Fixed Earth	Free Earth	
Required Pile Length	m	11.02	8.79	11.02
Max. bending Moment	KNm/m	175.3	250.2	188.3
Top Frame Load	KN/m	86.26	106.33	52.79
Bottom Frame Load	KN/m	-	-	248.21

Fixed earth support at stage 2 can be assumed since the pile length required is not greater than the length required for the final stage.

Since the soil loadings determined in this example are based on factored soil parameters a partial factor of 1.2 is appropriate to give the ultimate design load.

Section modulus of pile required for S270GP steel.  
 $= 1.2 \times 188.3 \times 10^3 / 270 = 837 \text{ cm}^3/\text{m}$

Section modulus of pile required for S355GP steel.  
 $= 1.2 \times 188.3 \times 10^3 / 355 = 636 \text{ cm}^3/\text{m}$

To provide control over the inflow of ground water it would be sensible to ensure the piles are toed into the underlying clay by not less than 0.3m which requires a pile of 11.3m long.

Hence use PU 9<sup>(1)</sup> piles ( $z = 915 \text{ cm}^3/\text{m}$ ) in steel grade S270GP or PU 7<sup>(1)</sup> ( $z = 670 \text{ cm}^3/\text{m}$ ) in steel grade S355GP not less than 11.3m long.

However the designer will need to check the suitability of the section for driving. See chapter 11.

In accordance with the recommendation in Section 5.14 the calculated propping loads should be increased by 85 per cent. Also to provide the ultimate design load for structural design a partial factor of 1.2 should be applied.

Hence the ultimate design loads are:-

Top Frame  $= 1.85 \times 1.2 \times 86.26 = 191.5 \text{ kN/m}$

Bottom Frame  $= 1.85 \times 1.2 \times 248.21 = 551.0 \text{ kN/m}$

<sup>(1)</sup>Section properties of the section: see Table 13.1.1

# Cofferdams

## Check on Effective Stress Loading for the Final Stage

Since the clay strata are inter-bedded with free draining material then it is possible that they may reach a drained state during the period while the cofferdam is open and it may be appropriate to check the final stage in the effective stress condition.

Effective stress active pressures are as the example in chapter 5, so calculate the appropriate passive pressures.

Excavate to final level. The design has included for 0.20m of unplanned excavation so the passive pressures are calculated for an excavation depth of 8.10m.

$$P_p \text{ at 8.1m below ground level in sand and gravel} \\ = 6.493 \times 0.00 = 0 \text{ kN/m}^2$$

$$P_p \text{ at 11m below ground level in sand and gravel} \\ = (6.493 \times 31.29) + 28.45 = 231.62 \text{ kN/m}^2$$

$$P_p \text{ at 11m below ground level in firm clay} \\ = 2.512 \times 31.29 + (3.170 \times 2/1.2) + 28.45 = 112.33 \text{ kN/m}^2$$

$$P_p \text{ at 16m below ground level in firm clay} \\ = 2.512 \times 75.24 + (3.170 \times 2/1.2) + 77.50 = 271.79 \text{ kN/m}^2$$

The pressure diagram for this condition is given below:

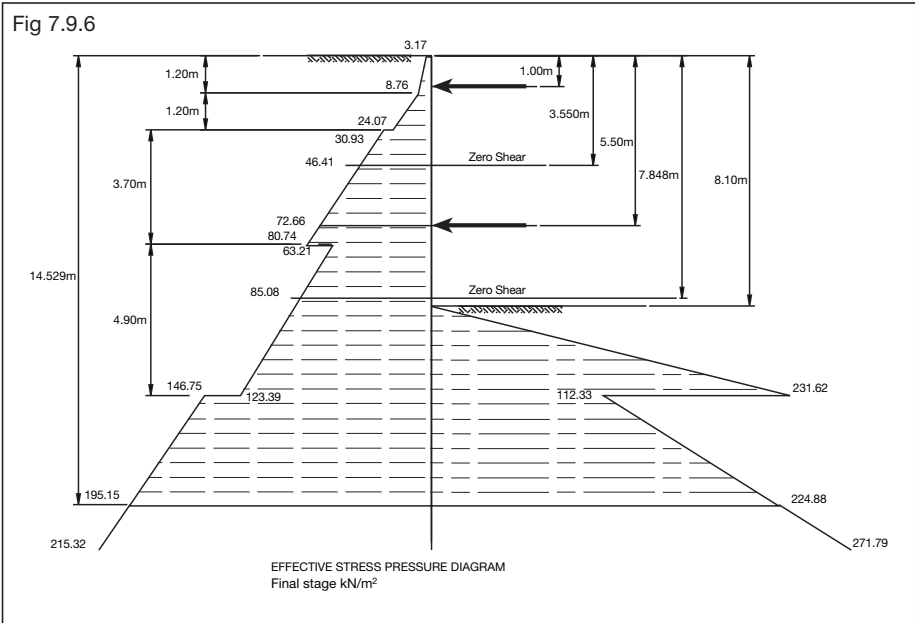

It can clearly be seen that in the clay strata the active pressures have increased while the passive have decreased compared with the total stress condition previously considered hence it is necessary to calculate the stability and structural loads for this condition.

# Cofferdams

As before the depth of cut off is found by considering the piles to be simply supported at the bottom frame position due to the assumption of a hinge at the support position.

Consider first the lower span. The pile length for stability is found, by trial and error, to be 14.529m.

Taking moments of the active pressures about the bottom frame:

	<b>Active Force</b>		<b>Active Moment</b>
	<b>kN/m</b>		<b>kNm/m</b>
72.66 x 0.600 x 1/2	=	21.80 x 0.200	= 4.36
80.74 x 0.600 x 1/2	=	24.22 x 0.400	= 9.69
63.21 x 4.900 x 1/2	=	154.86 x 2.233	= 345.81
123.39 x 4.900 x 1/2	=	302.31 x 3.867	= 1169.02
146.75 x 3.529 x 1/2	=	258.94 x 6.676	= 1728.69
195.15 x 3.529 x 1/2	=	344.34 x 7.853	= 2704.12
		<b>1106.47</b>	<b>5961.69</b>

Taking moments of the passive pressure about the bottom frame:

	<b>Passive Force</b>		<b>Active Moment</b>
	<b>kN/m</b>		<b>kNm/m</b>
231.62x 2.900 x 1/2	=	335.85 x 4.533	= 1522.40
112.33 x 3.529 x 1/2	=	198.21 x 6.676	= 1323.23
224.88 x 3.529 x 1/2	=	396.80 x 7.853	= 3116.08
		<b>930.86</b>	<b>5961.71</b>

[Active Moment and Passive Moment are equal therefore OK]

For the lower span bottom frame load =  
 1106.47 – 930.86 = 175.61 kN/m

Zero shear occurs at 7.848m below ground level for the lower span.

Take moments about and above the level of zero shear for the lower span:

		<b>kNm/m</b>
85.08 x 1.748 x 1/2 x 0.583	=	43.35
63.21 x 1.748 x 1/2 x 1.165	=	64.36
80.74 x 0.600 x 1/2 x 1.948	=	47.18
72.66 x 0.600 x 1/2 x 2.148	=	46.82
-175.61 x 2.348	=	-412.33
		<b>-210.62</b>

# Cofferdams

Now consider the upper span

Taking moments of the active pressures about the bottom frame:

		<b>Active Force kN/m</b>			<b>Active Moment kNm/m</b>
3.17 x 1.200 x 1/2	=	1.90	x	5.100	= 9.70
8.76 x 1.200 x 1/2	=	5.26	x	4.700	= 24.70
8.76 x 1.200 x 1/2	=	5.26	x	3.900	= 20.50
24.07 x 1.200 x 1/2	=	14.44	x	3.500	= 50.55
30.93 x 3.100 x 1/2	=	47.94	x	2.067	= 99.10
72.66 x 3.100 x 1/2	=	112.62	x	1.033	= 116.34
		<b>187.42</b>			<b>320.89</b>

Then top frame load = 320.89/4.500 = 71.31 kN/m

And hence total load in bottom frame  
 = (187.42 – 71.31) + 175.61 = 291.72 kN/m

Zero shear occurs at 3.550m below ground level.

Take moments about and below the level of zero shear:

					<b>kNm/m</b>
46.41 x 1.950 x 1/2 x 0.650	=				29.41
72.66 x 1.950 x 1/2 x 1.300	=				92.10
-116.11 x 1.950	=				-226.41
					<b>-104.90</b>

Table 7.9.2 Summary

		<b>Short term design All stages</b>	<b>Long term design Final stages</b>
Required pile length	m	11.02	14.53
Max. bending moment	kNm/m	188.3	210.6
Max. load in top frame	kN/m	86.26	71.31
Max. load bottom frame	kN/m	248.21	291.72

Hence for a long term effective stress design

Section modulus of pile required for S270GP steel  
 = 1.2 x 210.6 x 10<sup>3</sup> / 270 = 936 cm<sup>3</sup>/m

Section modulus of pile required for S355GP steel  
 = 1.2 x 210.6 x 10<sup>3</sup> / 355 = 712 cm<sup>3</sup>/m

Therefore the original pile specified, PU 9<sup>(1)</sup> in steel grade S270GP or PU 7<sup>(1)</sup> in steel grade S355GP 11.3m long, will have to be increased to

Either PU 11<sup>(1)</sup> (Z = 1095 cm<sup>3</sup>/m) by 14.6m in steel grade S270GP.

Or PU 8<sup>(1)</sup> (Z = 830 cm<sup>3</sup>/m) by 14.6m in steel grade S355GP.

In addition the bottom frame should be checked as the frame loading is increased by some 18%.

<sup>(1)</sup>Section properties of the section: see Table 13.1.1

# Cofferdams

## 7.10 Design of support system

Traditionally cofferdam bracing was constructed in either timber or steel, the choice being governed by the loads to be carried. However over the past ten to fifteen years the increasing use of proprietary equipment combined with the loss of skilled timbermen means that it is now exceedingly rare for timber to be used and virtually all framing is now in steel. The loads on the walings are obtained from consideration of the same conditions used to obtain the bending moments in the piles.

For the majority of small to medium sized cofferdams, which will only be open for a relatively short period, it is probably more economic to use a proprietary frame or frames on hire and possibly designed by the supplier. These frames use hydraulic rams to apply a pre-load and have been developed from the support systems used for trenches for more than thirty years. At the time of writing props can be obtained with capacities of up to 2500kN and walings to provide spans of 20 m. However if large span walings are proposed the deflections should be checked since these may well be large and will permit significant movement of the wall and the ground behind.

As an alternative, and for larger cofferdams beyond the scope of the proprietary equipment, purpose made frames utilising universal beams and column sections and tubes will be necessary. These members may require suitable stiffeners to prevent local buckling. Information on the strength of typical members is given in the tables below.

Traditionally steel frames have been designed using permissible stress methods. The use of either serviceability or ultimate limit state codes of practice is acceptable for determining the appropriate design value from calculations for the pile wall. However there is a move towards limit state methods and the load tables included in this chapter show ultimate loads, based on the UK code BS5950.

The way the framing is detailed can make a significant difference to the ease with which it is erected and dismantled. Waling beams should be supported at regular intervals either with brackets welded to the piles or with hangers, possibly chains, from the top of the piles. Struts should be fitted with a hanger to support their weight on the waling while being aligned and fixed in position. Prop design must include for accidental impact by materials or machinery – the tables below include an allowance of 10kN applied at mid-span – and the designer should ensure, by discussion with the contractor's site management, that the allowance is adequate for the size of machines being used. Various sources give guidance on this in the range 10 – 50 kN. Where the walings do not bear directly on the piles suitable packers will be required which may be of timber, either softwood or hardwood, concrete filled bags or steel plates depending on the loads to be transferred.



# Cofferdams

## 7.11 Cofferdam support frames

Fig 7.11

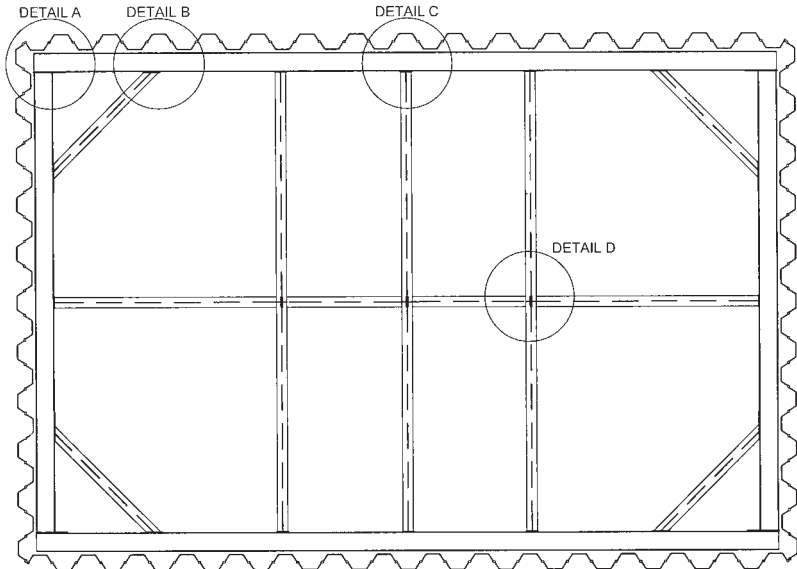

PLAN LAYOUT

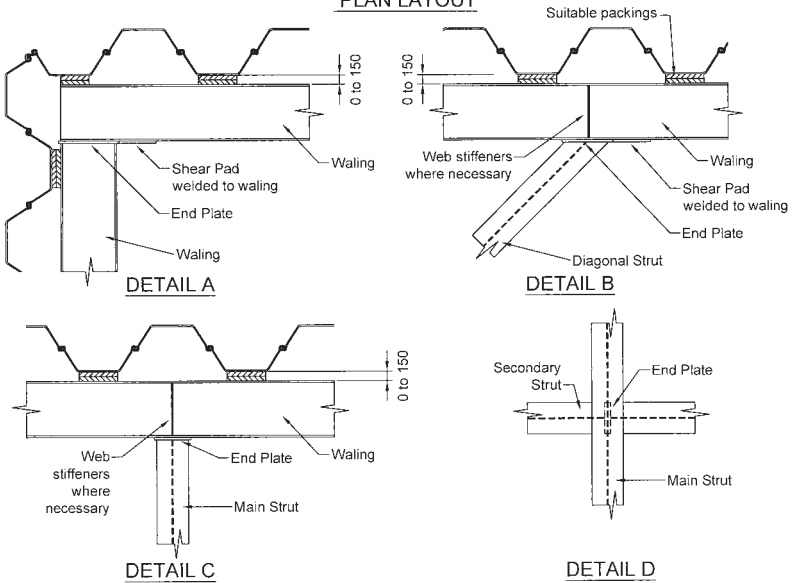

# Cofferdams

## 7.12 Strength of walings and struts

Table 7.12.1 Ultimate Capacity Table for Universal Beam Walings

Section Size	Section Classification	Moment Capacity $M_{cx}$ kNm	Shear Capacity $P_v$ kN
254 x 146 x 31 kg/m	Plastic	108	249
305 x 165 x 40 kg/m	Plastic	171	300
356 x 171 x 45 kg/m	Plastic	213	406
406 x 178 x 60 kg/m	Plastic	330	530
457 x 152 x 67 kg/m	Plastic	400	680
457 x 191 x 74 kg/m	Plastic	455	679
533 x 210 x 92 kg/m	Plastic	649	888
610 x 229 x 113 kg/m	Plastic	869	1070
610 x 305 x 149 kg/m	Plastic	1220	1150

### Notes:

The table shows Ultimate Limit State (maximum applied) moment and shear capacities based on BS5950-1:2000.

Waling capacities are based on S275 material to EN10025.

The moment capacity assumes the shear load to be low (<60% of shear capacity). Where the shear load is high the moment capacity will need to be reduced (see BS5950 cl 4.2.5.3)

The waling will need to be checked for lateral torsional buckling which may give a reduced bending capacity (see BS5950 cl 4.3.6.2)

Webs should also be checked for bearing and buckling.

When the waling is also subject to axial load the bending capacity will be reduced and the section should be checked in accordance with BS5950 cl 4.8.3.3

# Cofferdams

Table 7.12.2 Ultimate Capacity Table for Horizontal Universal Column Struts

Universal Column Designation D x B x wt(kg/m)	Ultimate Limit State Axial Capacity (kN)												Length (m)	
	2	3	4	5	6	7	8	9	10	11	12	13	14	
152 x 152 x 30	602	417	259	146										
203 x 203 x 46	1095	902	695	511	363	250	165							
203 x 203 x 60	1444	1213	963	734	544	401	292	209						
254 x 254 x 73	1875	1672	1431	1182	949	751	588	457	352					
254 x 254 x 89	2205	1989	1719	1445	1178	948	758	606	481					
305 x 305 x 97	2567	2368	2119	1849	1575	1318	1085	892	730	591	476	381	299	
305 x 305 x 118	3030	2804	2533	2226	1922	1627	1363	1131	938	777	643	529	432	
356 x 368 x 129	3345	3151	2942	2692	2417	2137	1859	1603	1378	1175	996	842	709	
356 x 368 x 153	4040	3826	3578	3274	2956	2625	2296	1998	1723	1478	1271	1083	925	

**Notes:**

The table shows Ultimate Limit State (maximum applied) axial load based on BS5950-1:2000.

H sections are to be used with the web vertical.

Struts are assumed to be effectively pinned in plan and elevation

Allowance has been made for strut self weight and an accidental vertical load of 10kN at the centre of the strut.

An allowance has been made for the axial load to act eccentrically at 10% of the section depth.

Strut axial capacity is based on S275 material to EN10025.

For additional or alternate loading, or alternative material, calculations must be made to establish the correct axial capacity.

**Common Values**

Sections must be class 1 or 2 with Low Shear

Gravity = 9.81 m/sec<sup>2</sup>

Accidental Load = 10kN

ULS Load Factors:

Steel self weight = 1.4

Live load = 1.6

Effective length factor = 1.0

Section type = H

Grade = S275

# Cofferdams

Table 7.12.3 Ultimate Capacity Table for Circular Hollow Section Struts

Circular Hollow Section	Strut Size	Ultimate Limit State Axial Capacity (kN)										
		Length (m)										
		5	6	8	10	12	14	16	18	20	22	24
CHS	273 x 10	1807	1645	1191	810	548	374	255				
CHS	323.9 x 10	2294	2166	1825	1359	986	715	522	382			
CHS	355.6 x 12.5	3242	3106	2742	2206	1657	1246	941	716	546		
CHS	406.4 x 12.5	3829	3712	3401	3001	2401	1865	1454	1137	893	704	554
CHS	457 x 12.7	4473	4367	4097	3711	3245	2631	2099	1682	1350	1087	877
CHS	508 x 12.7	4783	4743	4653	4392	3940	3378	2807	2303	1885	1544	1268
CHS	559 x 14.3	5964	5923	5832	5666	5233	4662	4010	3376	2817	2347	1957
CHS	610 x 14.3	6554	6515	6428	6326	5990	5491	4876	4215	3587	3035	2563
CHS	660 x 15.9	7907	7867	7777	7672	7437	6952	6334	5616	4880	4195	3589
CHS	711 x 15.9	8559	8521	8434	8331	8212	7787	7237	6569	5831	5098	4419
CHS	762 x 17.5	9822	9783	9692	9584	9459	9180	8667	8035	7297	6508	5733
CHS	813 x 17.5	10518	10480	10391	10285	10162	10012	9547	8975	8292	7524	6728
CHS	864 x 20.6	13134	13093	12995	12877	12739	12581	12197	11585	10847	9993	9065
CHS	914 x 20.6	13935	13895	13799	13682	13546	13389	13159	12596	11919	11123	10229

## Notes:

The table shows Ultimate Limit State (maximum applied) axial load based on BS5950-1:2000.

Allowance has been made for strut self weight and an accidental load of 10kN at the centre of the strut.

An allowance has been made for the axial load to act eccentrically at 10% of the section diameter.

Strut axial capacity is based on S355 material to EN10210.

For additional or alternate loading, or alternative material, calculations must be made to establish the correct axial capacity.

## Common Values

Sections must be class 1, 2 or 3 with Low Shear

Gravity = 9.81m/sec<sup>2</sup>

Accidental Load = 10 kN

ULS Load Factors:

Steel self weight = 1.4

Live load = 1.6

Effective length factor = 1.0

Section type = H

Grade = S355

Slenderness ratio limit for  $l = 180$

# Cofferdams

## 7.13 Circular Cofferdams

Tables 1.13.5 and 1.14.5 in chapter 1 give the approximate minimum diameters of cofferdams constructed in AZ, AU, PU, GU and PU-R sheet piling.

The tables are intended as a guide since the minimum diameter will depend upon several other factors such as type of ground, length of piles and penetration required.

Smaller diameters can be achieved by introducing individual bent piles.

On site it may be advantageous to pitch the whole circle before driving, to ensure the circle can be closed, the piles being driven in stages as the hammer works its way several times around the circumference. However for larger circles, or when using a leader rig, this may be impractical but great care will be needed to ensure that the final piles close the ring without departing too far from the required line.

Earth pressures are calculated as for straight-sided cofferdams and circular ring beams, instead of walings and struts, may support the piles leaving the central area clear of obstructions. The ring beams will work in hoop compression and are thus normally subjected to axial loads only which are calculated as follows:

Axial load (kN) = waling load (kN/m) x radius of cofferdam (m)

Ring beams can be made from either steel or concrete. For steel rings there are specialist fabricators that can roll large H and I sections to the required radius the design of which should take in to account the stiffness of the ring, using Timoshenko's formula described below, and the possibility of local flange instability.

The following table gives an indication of suitable sizes of reinforced concrete ring beams for various cofferdam diameters and loadings.

# Cofferdams

Table 7.13 Reinforced Concrete Walings for Circular Cofferdams

Diameter of Cofferdam (metres)	Ultimate Waling Load (kN per metre run)							
	Size of Waling 'd' x 'b' in mm and number of reinforcing bars							
	450 x 300 6 no. 12Ø bars	600 x 400 10 no. 12Ø bars	750 x 500 8 no. 16Ø bars	900 x 600 8 no. 20Ø bars	1050 x 700 10 no. 20Ø bars	1200 x 800 8 no. 25Ø bars	1350 x 900 10 no. 25Ø bars	1450 x 950 8 no. 32Ø bars
5	852	1504	2328					
10	376	752	1164	1690				
15	164	501	776	1127	1520	1977		
20		292	582	845	1140	1483	1875	
25			457	676	912	1186	1500	1725
30				563	760	989	1250	1437
35					652	847	1071	1232
40						742	937	1078
45							833	958
50								862

**Note:**

The number and size of reinforcing bars given in the table is based on the minimum area of steel for column construction given by table 3.25 of BS8110-1: 1997 and assumes the use of High Yield Steel ( $f_y = 460 \text{ N/mm}^2$ ) reinforcing bars to BS4449:1988

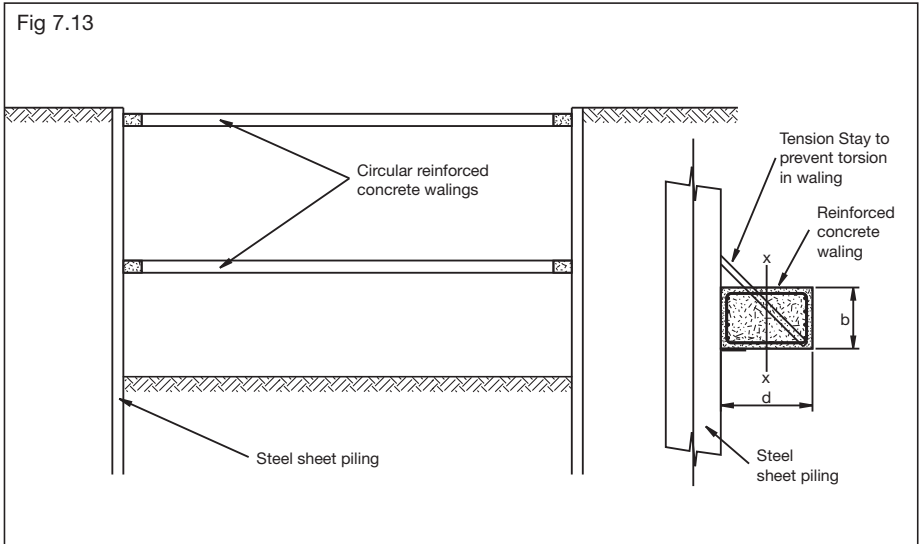

## Cofferdams

### 7.14 Reinforced concrete walings for circular Cofferdams

The tabulated ultimate waling loads are based on :

1. Ultimate load for concrete calculated in accordance with BS8110-1:1997 clause 3.8.4.3 for C35 concrete and reinforcement with  $f_y = 460 \text{ N/mm}^2$

2. 
$$W = \frac{3EI}{r^3 \cdot 10^9}$$

where

$W$  = waling load in kN/m

$E$  = Young's Modulus for concrete =  $21000 \text{ N/mm}^2$

$I$  = Moment of Inertia about 'x-x' in  $\text{mm}^4$

$r$  = Mean radius of ring beam in metres

3. The cofferdam diameter ( $D$ ) divided by the width of the beam ( $d$ )  $< 35$

The above formula is based on Timoshenko's work wherein the formula is given as:

$$W_u = \frac{kEI}{r^3 \cdot 10^9} \text{ kN/m}$$

Where  $W_u$  is the ultimate waling load and  $k$  is a factor, the value of which is dependent on the stiffness of the retained medium (3 is the value for water, eg in a marine cofferdam built to facilitate construction on the sea bed). Progressively higher values are, in theory, applicable for weak/medium/strong soils. However it is common to use the value of 3 for all conditions. It is worth noting that for the majority of the values in table 7.13 the load is governed by the limiting column load from BS8110 and not by the Timoshenko value which is higher. Increasing the reinforcement may give increased loads up to the Timoshenko value.

The ring beam can tolerate very little distortion from a true circle before the onset of catastrophic instability. Hence the empirical rule:

$$D/d < 35$$

Where  $d$  is the width of the ring beam, ie the difference between the inner and outer radii of the beam and  $D$  is the diameter of the cofferdam (ie the diameter of the inner face of the piles). If the sheet piles deflect to any great extent then the load in the walings will be concentrated at the top or bottom of the waling and will impart torsion into the beam. This condition should also be checked in the design.

# Cofferdams

## 7.15 Earth filled double-wall and cellular Cofferdams

Earth filled cofferdams are self supporting gravity structures, either parallel-sided double-wall cofferdams or cellular cofferdams. The stability of both types is dependent on the properties of the fill and the soil at foundation level as well as on the arrangement and type of the steel sheet piling. Typical uses are as dams to temporarily seal off dock entrances so that work below water level can be carried out in the dry and in the construction of permanent walls for land reclamation, quays, wharves and dolphins.

---

## 7.16 Double skin / wall Cofferdams

Double wall cofferdams comprise two parallel lines of sheet piles connected together by a system of steel walings and tie rods at one or more levels. The space between the walls is generally filled with granular material such as sand, gravel, or broken rock.

The exposed or inner wall is designed as an anchored retaining wall while the outer line of piles acts as the anchorage. U or Z profile sheet piles are appropriate to this form of construction.

The wall as a whole should be analysed as a gravity structure and, in order to achieve adequate factors of safety against overturning and sliding, the width will generally be found to be not less than 0.8 of the retained height of water or soil. It is recommended that the overall stability of the structure is checked using the logarithmic spiral method devised by Jelinek.

Transverse bulkheads should be provided to form strong points at the ends and at intermediate positions to assist construction and confine any damage that might occur. The strong points may comprise a square or rectangular cell tied in both directions.

The water regime both inside and outside the structure is critical. It is recommended that weepholes are provided on the inner side of the structure near the bottom of the exposed portion of the piles to permit free drainage of the fill material reducing the pressures on the inner wall and preventing a decrease in the shear strength of the fill with time. Weepholes are only effective for small structures and complete drainage of the fill may not always be practical. Wellpoints and pumping offer an alternative option and will provide fast drainage if required. However the designer should always make allowance for any water pressure acting on the piles. It is essential that clay or silt is not used as fill material and any material of this type, occurring above the main foundation stratum, within the cofferdam must be removed prior to fill being placed.



## Cofferdams

The piles must be driven into the soil below excavation or dredge level to a sufficient depth to generate the required passive resistance. In this condition the structure will deflect towards the excavated side and the lateral earth pressures on the retained side may be taken as active. When cohesionless soils occur at or below excavation level, the penetration of the piling must also be sufficient to control the effects of seepage. The bearing capacity of the founding stratum should be checked against the weight of the structure and any superimposed loading.

The presence of rock at excavation level makes this type of cofferdam unsuitable unless:

- The rock is of a type that will allow sheet piles to be driven into it to an adequate penetration (see chapter 11).
- Tie rods can be installed at low level (probably underwater).
- A trench can be preformed in the rock into which the piles can be placed and grouted.
- The pile toes can be pinned with dowels installed in sockets in the rock.

If the piles are driven onto hard rock, or to a nominal depth below dredged level, the resistance to overturning and sliding should be developed by base friction and gravitational forces alone. In this condition the lateral earth pressure on the retained side will be in a condition between at rest and active, depending on the amount of deflection.

The internal soil pressures acting on the outer walls are likely to be greater than active due to the non uniform distribution of vertical stresses within the cofferdam (due to the moment effects) and hence the design should be based on pressures of 1.25 times the active values.

---

### 7.17 Cellular Cofferdams

The design and construction of cellular cofferdams is discussed in Chapter 9.

---

### 7.18 Effect of water pressure

The stability of a cofferdam can be adversely affected by the action of water pressures on the soils at formation level to the extent that collapse may occur. In granular soils excess water pressure causes piping and in cohesive or very tightly packed soils heave results.

# Cofferdams

Piping occurs when the pressure on the soil grains due to the upward flow of water is so large that the effective stress in the soil approaches zero. In this situation the soil has no shear strength and assumes a condition that can be considered as a quicksand, which will not support any vertical load. This is obviously a very dangerous situation for personnel operating in the cofferdam and will also lead to a significant reduction in passive resistance afforded to the cofferdam wall by the soil. In extreme cases this can lead to a complete loss of stability of the wall and failure of the cofferdam. The likelihood of piping for a given cross section can be predicted by the construction of a flow net, which will allow the engineer to calculate the exit hydraulic gradient. Comparison of the calculated value to the critical hydraulic gradient will indicate the factor of safety against piping; for clean sands this should generally lie between 1.5 and 2.0. Care should be taken when designing circular cofferdams and at the corners of rectangular structures where the three dimensional nature of the situation is more critical than in the case of a long wall.

The factor of safety against piping can be increased by installing the piles to a greater depth thereby increasing the flow path length and reducing the hydraulic gradient.

Table 7.18 Minimum cut-off depth

Width of Cofferdam W	Depth of cut-off D
2H or more	0.4H
H	0.5H
0.5H	0.7H

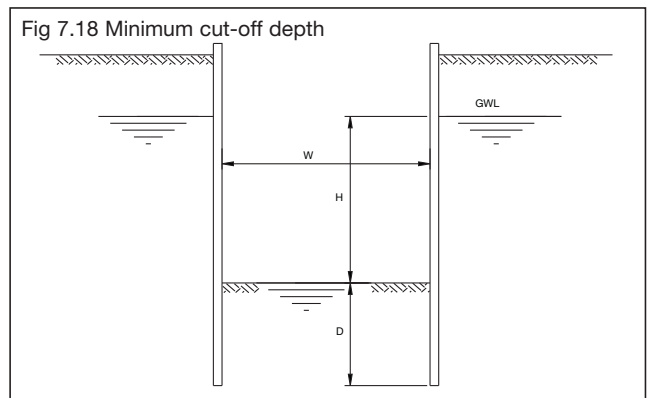

Table 7.18 gives an approximate guide to the safe minimum cut-off depth for a cofferdam constructed in medium uniform cohesionless soil when the toes of the piles do not penetrate

## Cofferdams

impermeable soils and excess water is pumped from sumps at excavation level.

Base heave can occur in cohesive or very tightly packed granular material if the force exerted by the water pressure acting on a block of material inside the cofferdam exceeds the bulk weight of the block. The likelihood of heave can be assessed using a flow net to calculate the average water pressure acting on the line drawn between the toes of the piles and converting this to an uplift force on the soil plug within the cofferdam.

The flow of water into a cofferdam may also be reduced by lowering the ground water level by means of well points outside the cofferdam. Alternatively, flow into the cofferdam can be reduced by pumping from well points located inside the cofferdam at or below the pile toe level. It should however be remembered that, when the stability or ease of operation of a cofferdam involves pumping, reliability of the pumps is of paramount importance and back-up capacity must be available to cope with any emergencies.

# Cofferdams

## 7.19 Flow nets

The preparation of flow nets is a useful tool, as it not only allows the engineer to calculate the water pressures in a particular situation, but also provides a visual representation of the flow regime in the soil.

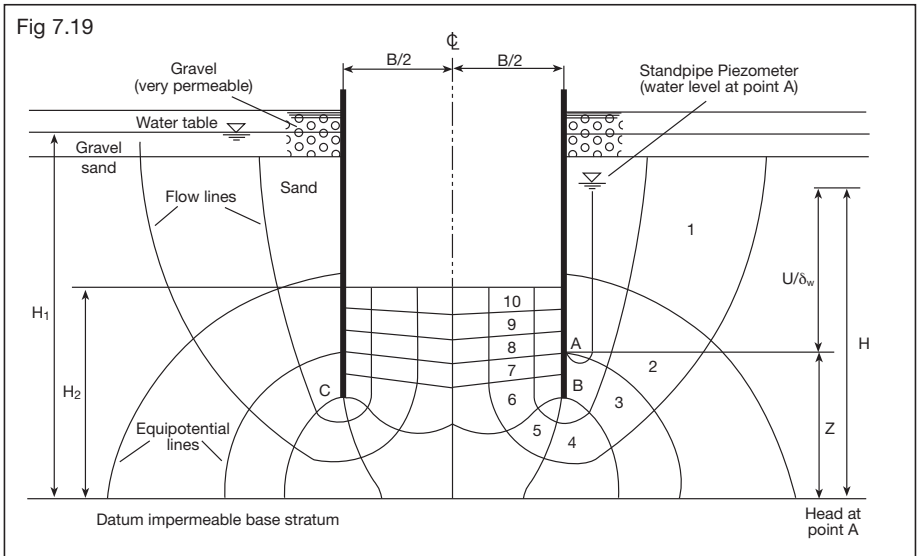

The shape and complexity of a flow net is a function of the homogeneity and permeability of the soil and the following notes indicate how a net can be drawn for uniform soil conditions and permeability.

- A scaled cross section drawing of the problem should be produced.
- A datum level should be marked on the cross section either at an impermeable boundary or at a suitable level below the cofferdam.
- The flow criteria must be determined.
- External water level.
- Internal water level.
- Centre line of cofferdam (this is the axis of symmetry).
- Lines of flow must be parallel to the cofferdam walls and the impervious datum.

Using the above as guidelines, the net is produced from flow lines and equipotential lines (a stand pipe at any point on an equipotential line would register the same height  $H$  above the datum level). These are at right angles to each other and form

# Cofferdams

approximate squares. This process is very much trial and error but practice will enable the flow net to be produced with a reasonable degree of speed and accuracy.

To calculate the pore water pressure 'u' at any point (using the example above)

- Calculate the potential head 'H' at the desired point (note that the potential head drop is always the same between successive equipotential lines once a square net has been formed)

$$H = H_1 - (H_1 - H_2) \cdot \frac{n}{N_d}$$

**where**

n = number of equipotential drops to the point being considered

N<sub>d</sub> = total number of drops

Hence at point A,

$$H = H_1 - (H_1 - H_2) \cdot \frac{2}{10}$$

- At any point  $H = \frac{u}{\gamma_w} + z$

**where**

u = pore water pressure

γ<sub>w</sub> = density of water

z = height of point above datum

As H, γ<sub>w</sub> and z are known, u can be calculated,

$$u = (H - z) \cdot \gamma_w$$

Flow nets can also be used to estimate the approximate volume of water flowing around the toes of the piles into the cofferdam.

The flow volume 'Q' m<sup>3</sup>/s per metre run of wall is given by

$$Q = k (H_1 - H_2) \cdot \frac{N_f}{N_d}$$

**where**

k = coefficient of permeability of the ground (m/s)

H<sub>1</sub> - H<sub>2</sub> = total head drop (m)

N<sub>f</sub> = number of flow channels (in half width of cofferdam)

N<sub>d</sub> = number of potential drops



## Cofferdams

It should not be forgotten that pumps are able to remove soil as well as water and a suction hose laid in the bottom of a cofferdam can disturb the base of the excavation with subsequent movement of the wall if the hose is badly located. Consideration should be given to forming a sump using a perforated drum into which the hose can be fixed to limit damage.

---

### 7.22 Sealants

While cofferdams on land will generally have sufficient soil within the interlocks to restrict the flow of water the use of sealants should not be discounted. In open granular soils particularly a suitable sealant in the interlock may restrict the volume of water entering the cofferdam such that the reduction in pumping costs will be significantly greater than the initial cost of the sealant. For cofferdams in water the problem of sealing a cofferdam that is leaking badly is such that it is advisable to use a sealant as a matter of course. If it does prove necessary to attempt to seal a cofferdam, post construction, then the traditional method is to use a mixture of ashes and sawdust dropped in the water on the outside where it, hopefully, will be sucked into the leaking interlocks and form a seal. If access to the outside is not feasible, for instance in a cofferdam on land, then the sealing has to be carried out from the inside using either a mastic putty or some other form of malleable caulking product. The main problem with sealing on the inside will always be preventing the water pressure from pushing the sealant out. It is essential, therefore, that to obtain the best results, the sealing material is forced as far as possible into the interlock and certainly beyond the corner radii.



ArcelorMittal

- 1** Product information
- 2** Sealants
- 3** Durability
- 4** Earth and water pressure
- 5** Design of sheet pile structures
- 6** Retaining walls
- 7** Cofferdams
- 8** Charts for retaining walls
- 9** Circular cell construction design & installation
- 10** Bearing piles and axially loaded sheet piles
- 11** Installation of sheet piles
- 12** Noise and vibration from piling operations
- 13** Useful information



# Charts for retaining walls

## Contents

			Page
<b>8.1</b>	<b>Typical retaining walls</b>		1
Cantilever	Water condition A	$\phi = 40^\circ$	5
		$\phi = 30^\circ$	6
		$\phi = 20^\circ$	7
Cantilever	Water condition B	$\phi = 40^\circ$	8
		$\phi = 30^\circ$	9
		$\phi = 20^\circ$	10
Cantilever	Water condition C	$\phi = 40^\circ$	11
		$\phi = 30^\circ$	12
		$\phi = 20^\circ$	13
Tied	Water condition A	$\phi = 40^\circ$	14
		$\phi = 30^\circ$	15
		$\phi = 20^\circ$	16
Tied	Water condition B	$\phi = 40^\circ$	17
		$\phi = 30^\circ$	18
		$\phi = 20^\circ$	19
Tied	Water condition C	$\phi = 40^\circ$	20
		$\phi = 30^\circ$	21
		$\phi = 20^\circ$	22
Cantilever	Water condition C	$S_u = 75\text{kN/m}^2$	23
		$S_u = 40\text{kN/m}^2$	24
Cantilever	Water condition D	$S_u = 75\text{kN/m}^2$	25
		$S_u = 40\text{kN/m}^2$	26
Tied	Water condition C	$S_u = 75\text{kN/m}^2$	27
		$S_u = 40\text{kN/m}^2$	28
Tied	Water condition D	$S_u = 75\text{kN/m}^2$	29
		$S_u = 40\text{kN/m}^2$	30

# Charts for retaining walls

## 8.1 Typical retaining walls

The following charts indicate the structural requirements for a retaining wall operating in the conditions specified. As the range of possible design conditions is vast, a simplified set of parameters has been chosen which illustrate the effect of change of soil strength, water regime and support conditions. While it is not intended that these charts should be used as a substitute for actual design for a set of circumstances they may be useful when assessing the likely requirements for a project at project appraisal stage.

The soil parameters referenced in these examples are assumed to be the representative values for the soil which are then factored before carrying out the design calculations.

The user should select the conditions which represent the case in question and then read off the minimum section modulus by steel grade, the support force if appropriate and minimum pile length from the charts. The values thus obtained should be regarded as ultimate loads and equated to the ultimate capacity of the walings etc.

The charts are based on the assumption that weep holes are provided where necessary and the retained soil is capable of allowing the design water regime to be realised. In the case of cohesive soils, the charts allow for the accumulation of ground water in any tension cracks which may develop.

The length of pile below excavation level has not been checked to ensure that there is sufficient penetration to prevent piping or heave. This must be considered separately.

Note:

Cantilever walls in excess of about 4.5m to 5m high are not generally recommended as the section required to resist bending moments and the length required for stability mean that uneconomic designs may result. In circumstances where the retained height exceeds 4.5m, a cantilever wall may be considered, but the deflection of the wall is likely to be large and this should be checked to ensure that serviceability criteria are not exceeded. This caveat should not be seen as a limitation on the use of steel sheet piling as much of the deflection on a cantilever wall results from soil movements and is therefore applicable to walls formed in any material.

It is further recommended that cantilever walls in soft clays are considered with extreme care and that they should not be designed for permanent construction using total stress soil parameters.

When U profile sheet piles are selected for the construction of cantilever retaining walls, the designer must satisfy himself that the section is capable of developing the required section modulus. Guidance on the selection of pile sections is given in Chapter 1.

# Charts for retaining walls

The parameters below have been adopted in the following typical examples:

Table: 8.1

Unfactored soil strength parameter	$\gamma$ (kN/m <sup>3</sup> )	$\gamma'$ (kN/m <sup>3</sup> )	$\delta$ (Both sides)	$S_w/S_u$	$K_a$	$K_{ac}$	$K_p$	$K_{pc}$
$\phi' = 40^\circ$	20.5	18.1	$2/3 \phi$	-	0.229	-	6.493	-
$\phi' = 30^\circ$	19.1	14.7	$2/3 \phi$	-	0.343	-	3.554	-
$\phi' = 20^\circ$	18.6	18.6	$2/3 \phi$	-	0.494	-	2.193	-
$S_u = 75 \text{ kN/m}^2$	19.6	19.6	-	0.5	1	2.449	1	2.449
$S_u = 40 \text{ kN/m}^2$	18.6	18.6	-	0.5	1	2.449	1	2.449

$\gamma_w = 9.81 \text{ kN/m}^3$

The following water conditions have been adopted.

**Water condition A:**

Ground water at the top of the piles on the active side and at excavation level on the passive side.

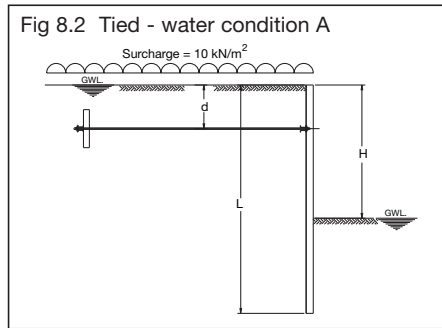
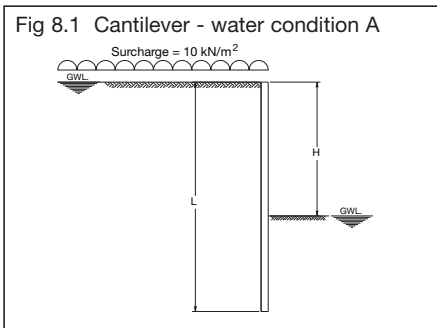

**Water condition B:**

Ground water at excavation level on the both sides of the wall.

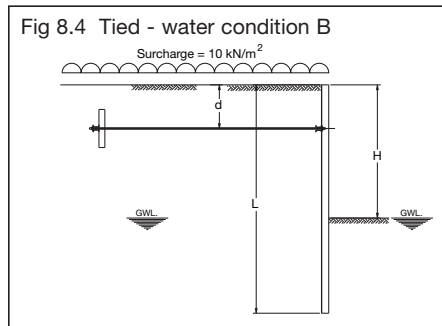
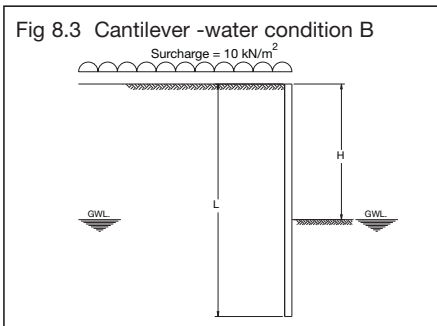

# Charts for retaining walls

## Water condition C:

No ground water is assumed in this case

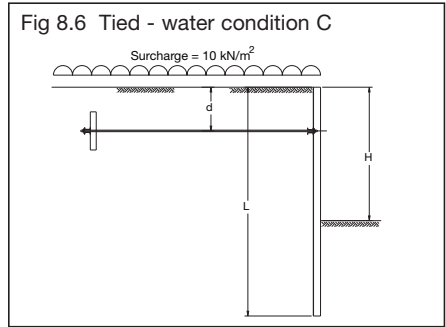
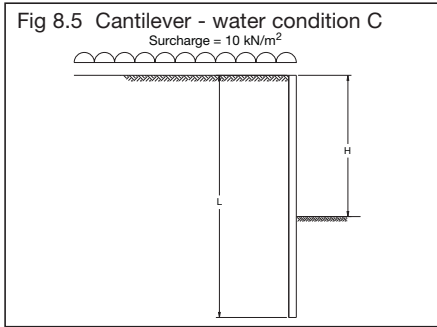

## Water condition D:

Active water to the top of the piles and passive water at excavation level. Soil is at the passive water level on both sides.

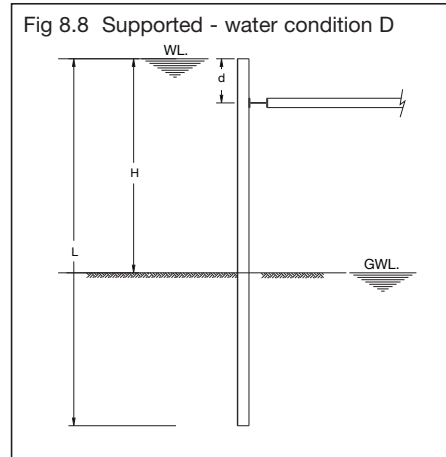
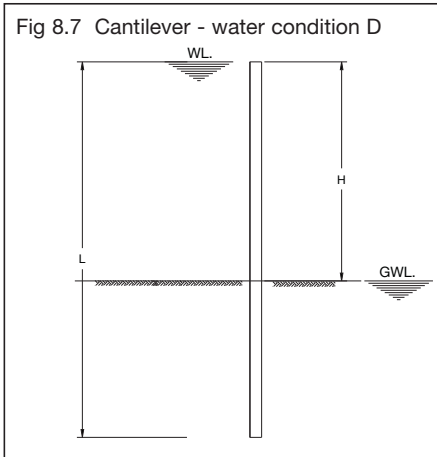

Details of sheet pile products and steel grades are given in chapter 1.

# Charts for retaining walls

**Using the plots.** (refer to Fig. 8.9 example plot)

- 1 Select the plot appropriate to the particular conditions under review.
- 2 For a given retained height, excluding any allowance for overdig, draw a vertical line to intersect with the lines on both the upper and lower plots.
- 3 Draw a horizontal line from the intersection point with the solid line on the lower plot to the right hand vertical axis to obtain the overall pile length.
- 4 Draw a horizontal line from the intersection point with one of the dashed lines (dependant on selected steel grade) to the left hand vertical axis to obtain the minimum section modulus.
- 5 Draw a horizontal line from the intersection point with the line on the upper plot to the left hand vertical axis to obtain the support load.
- 6 Tie load and Section modulus values obtained from these charts include the factors recommended in chapters 5 and 6.

Fig. 8.9 Example plot

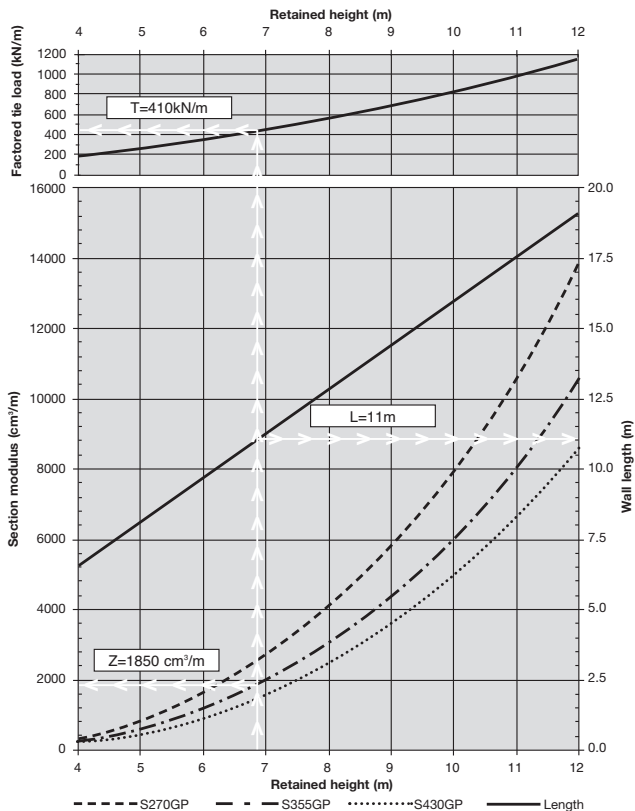

The charts indicate the section modulus required for steel grades S270GP, S355GP and S430GP. The requirements for alternative steel grades can be determined by looking up the modulus needed for a given set of conditions, multiplying the number by either 270, 355 or 430 depending on which plot has been used and dividing the result by the yield strength of the proposed steel.

# Charts for retaining walls

Fig. 8.10 Cantilever - Water condition A

$\phi = 40^\circ$

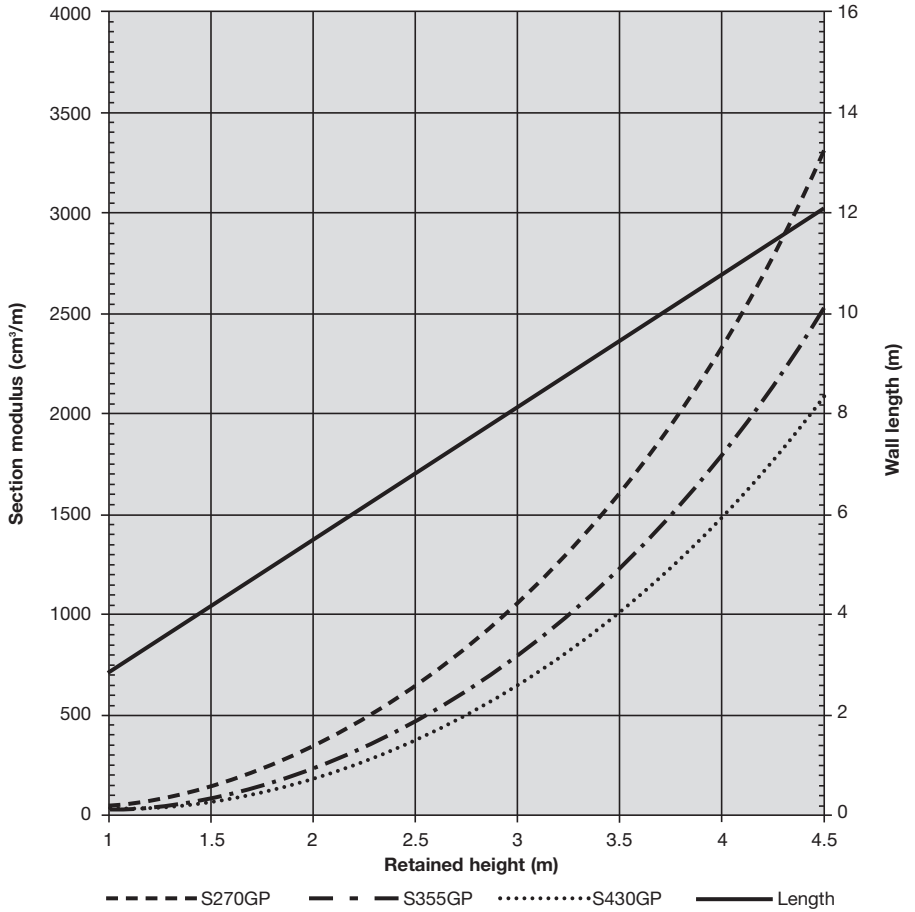

# Charts for retaining walls

Fig. 8.11 Cantilever - Water condition A

$\phi = 30^\circ$

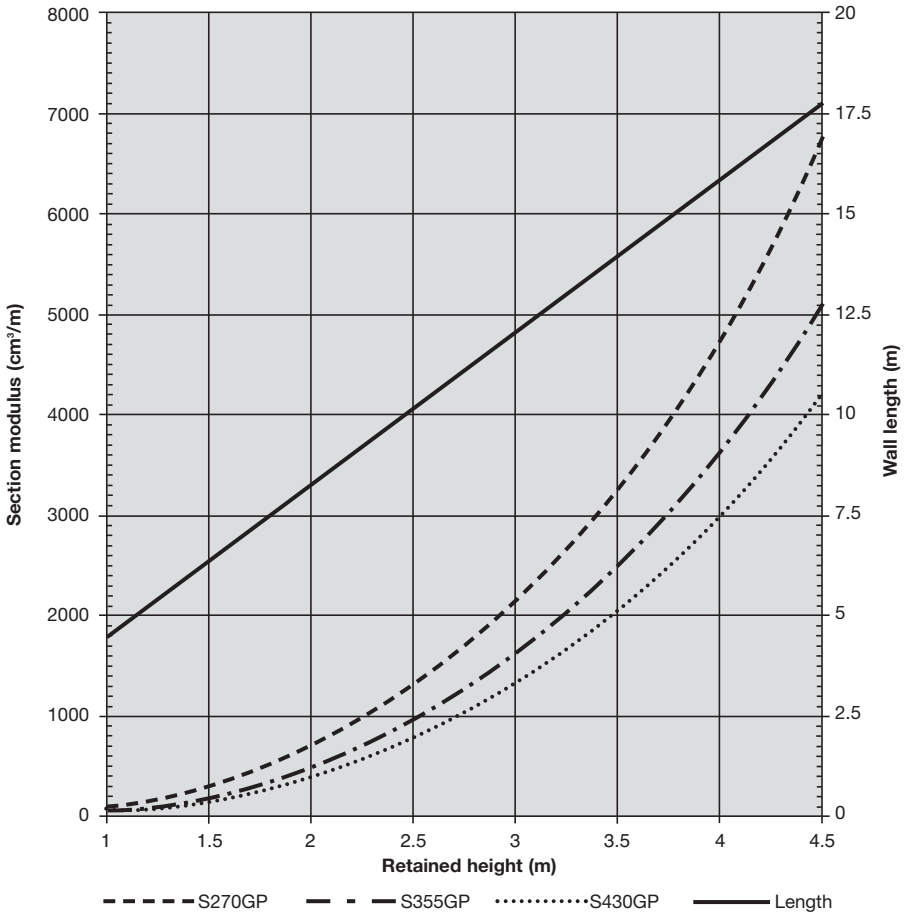

# Charts for retaining walls

Fig. 8.12 Cantilever - Water condition A

$\phi = 20^\circ$

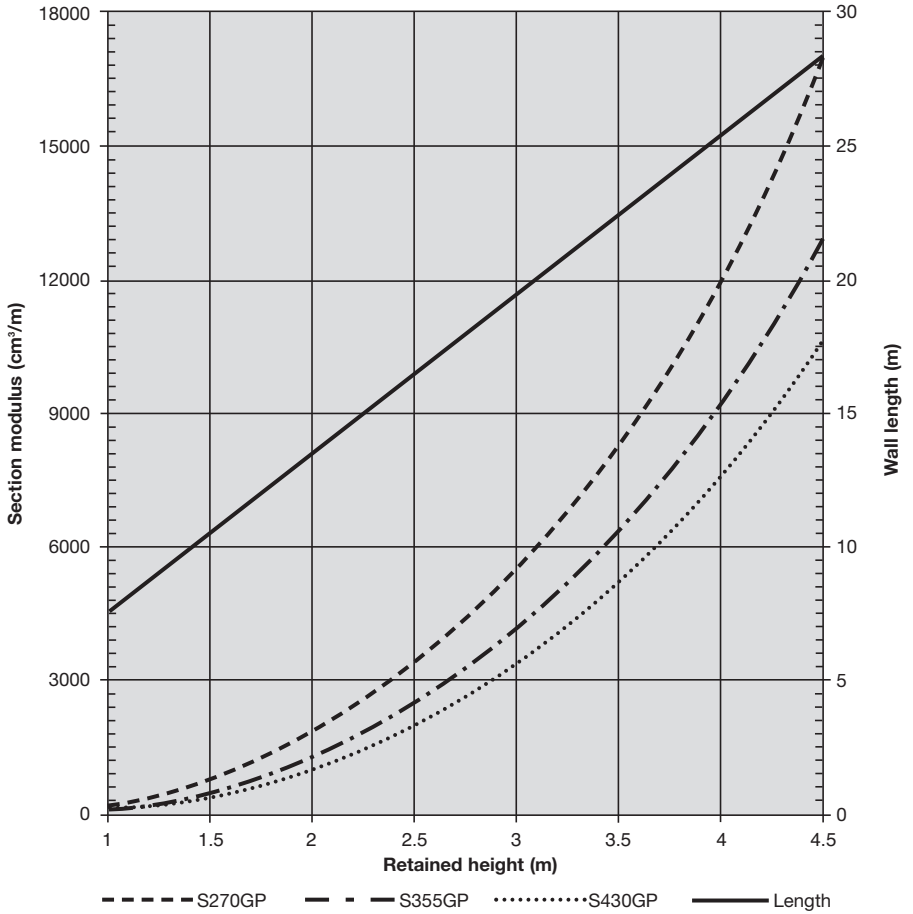



# Charts for retaining walls

Fig. 8.13 Cantilever - Water condition B

$\phi = 40^\circ$

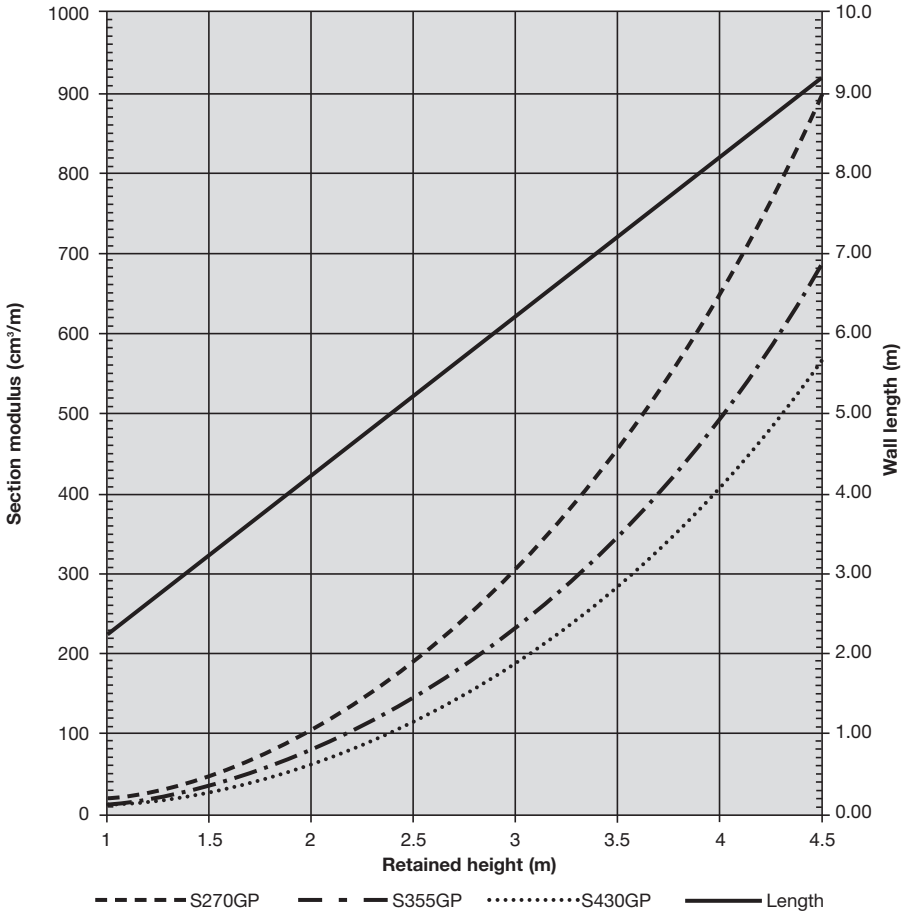

# Charts for retaining walls

Fig. 8.14 Cantilever - Water condition B

$\phi = 30^\circ$

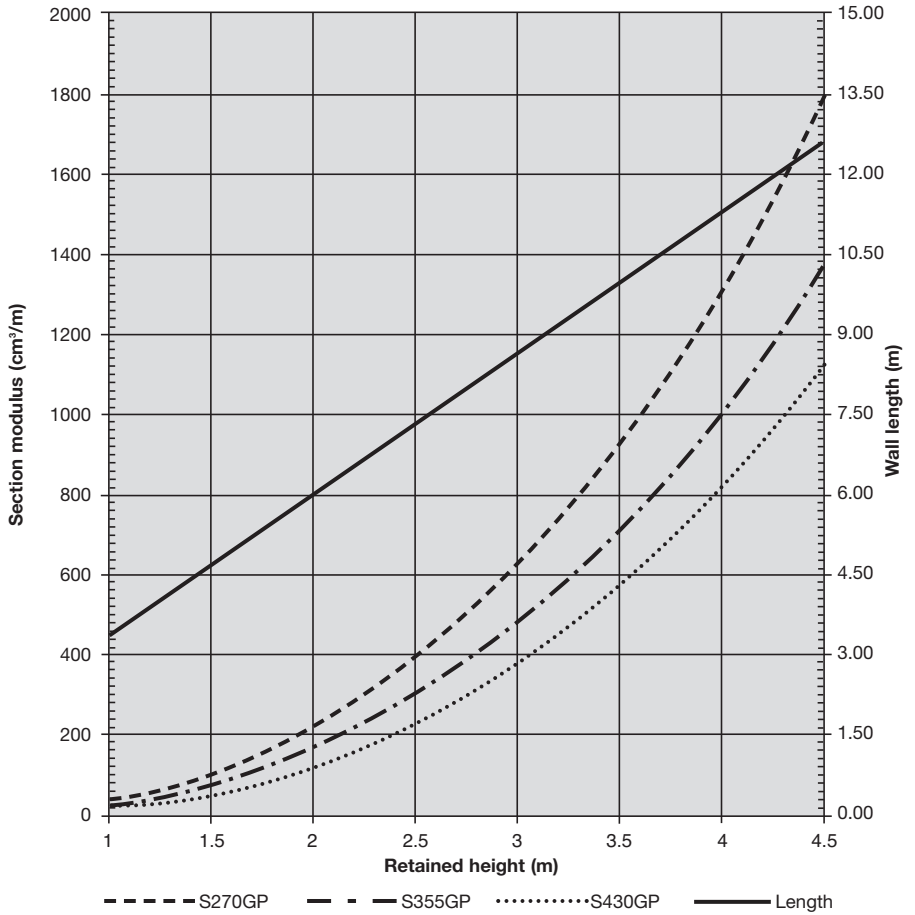

# Charts for retaining walls

Fig. 8.15 Cantilever - Water condition B

$\phi = 20^\circ$

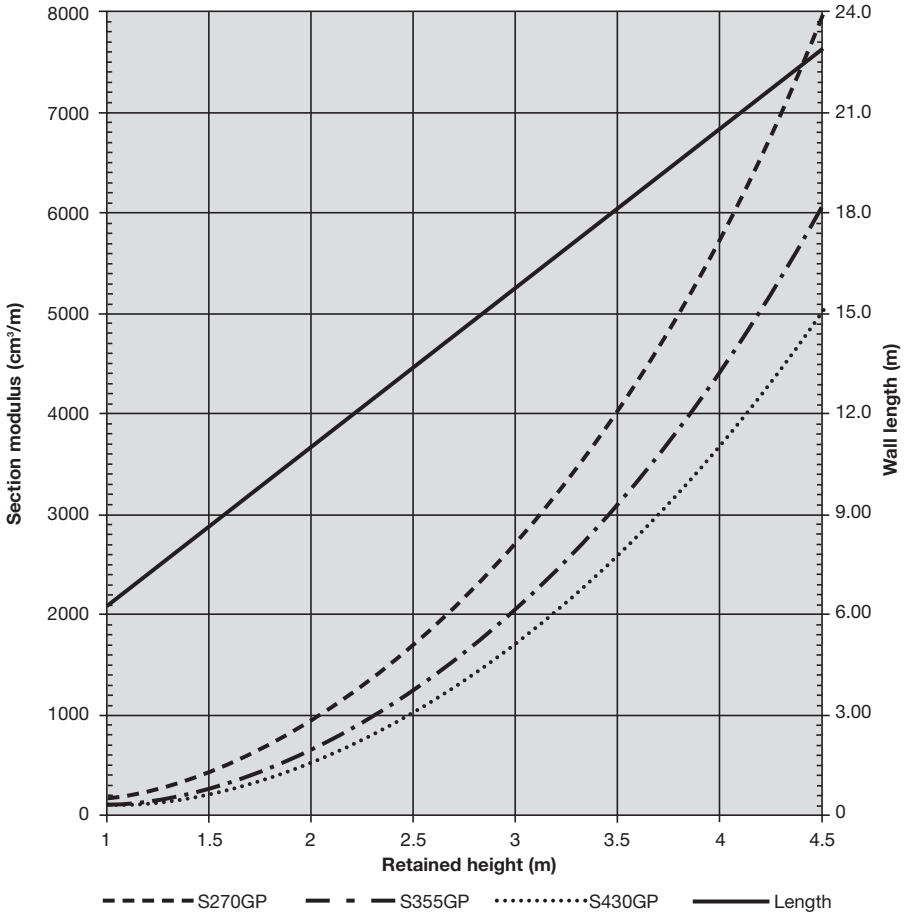

# Charts for retaining walls

Fig. 8.16 Cantilever - Water condition C

$\phi = 40^\circ$

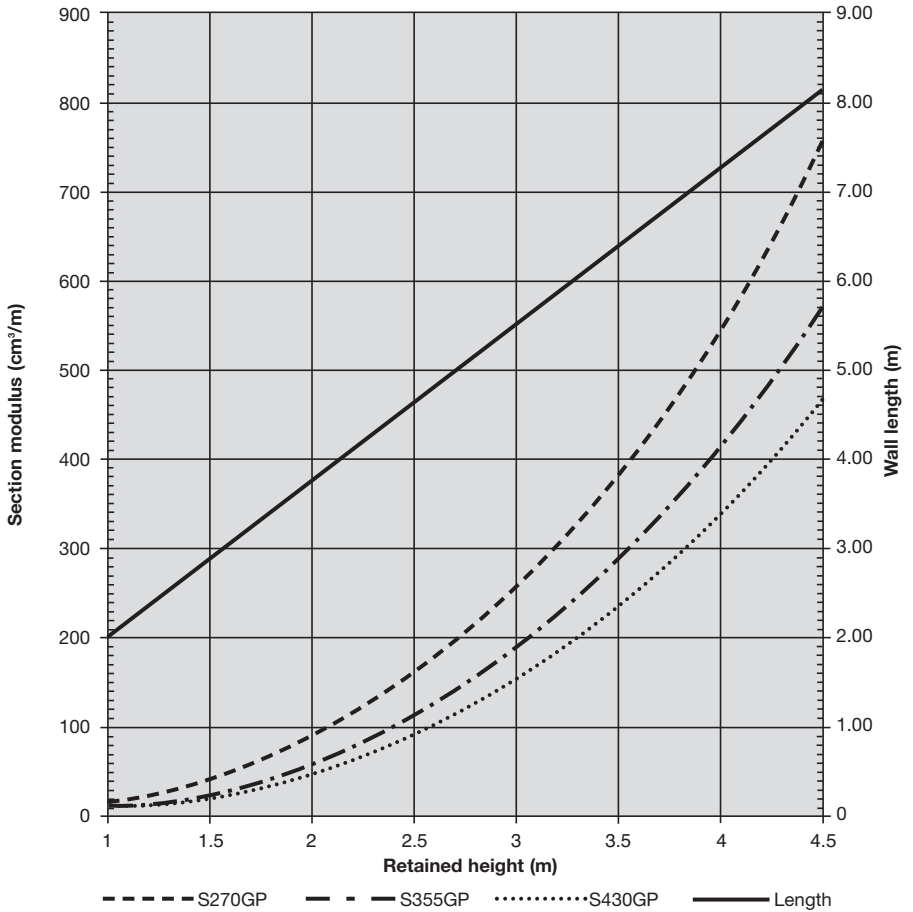

# Charts for retaining walls

Fig. 8.17 Cantilever - Water condition C

$\phi = 30^\circ$

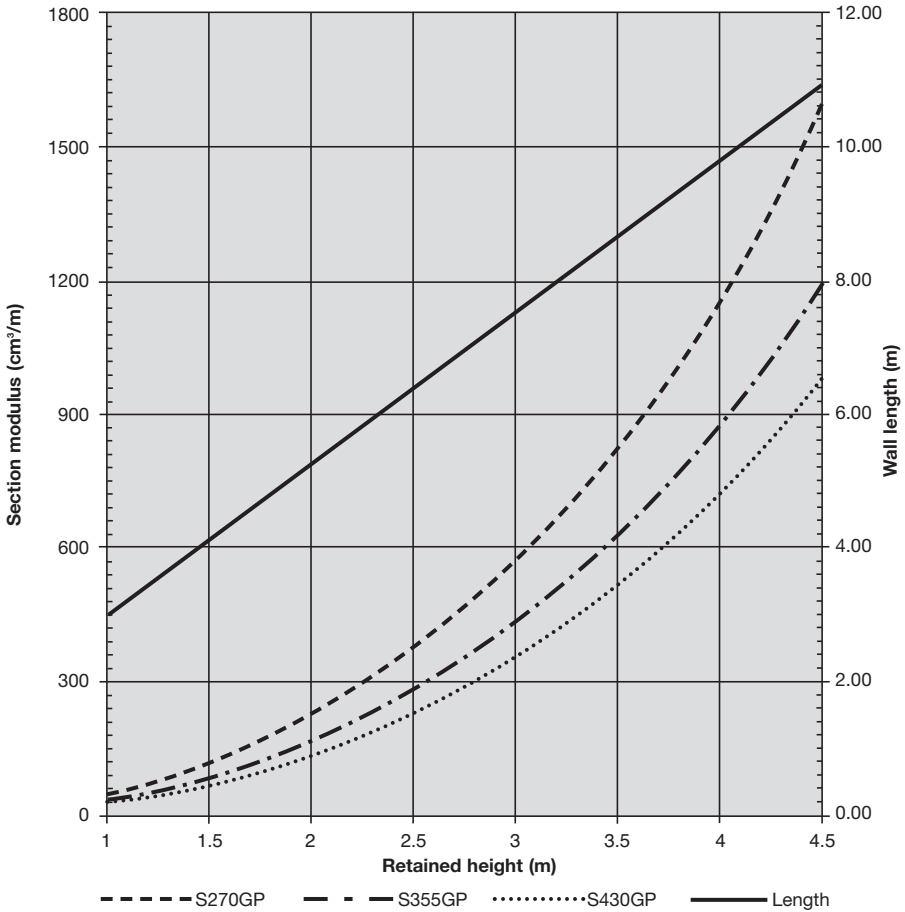

# Charts for retaining walls

Fig. 8.18 Cantilever - Water condition C

$\phi = 20^\circ$

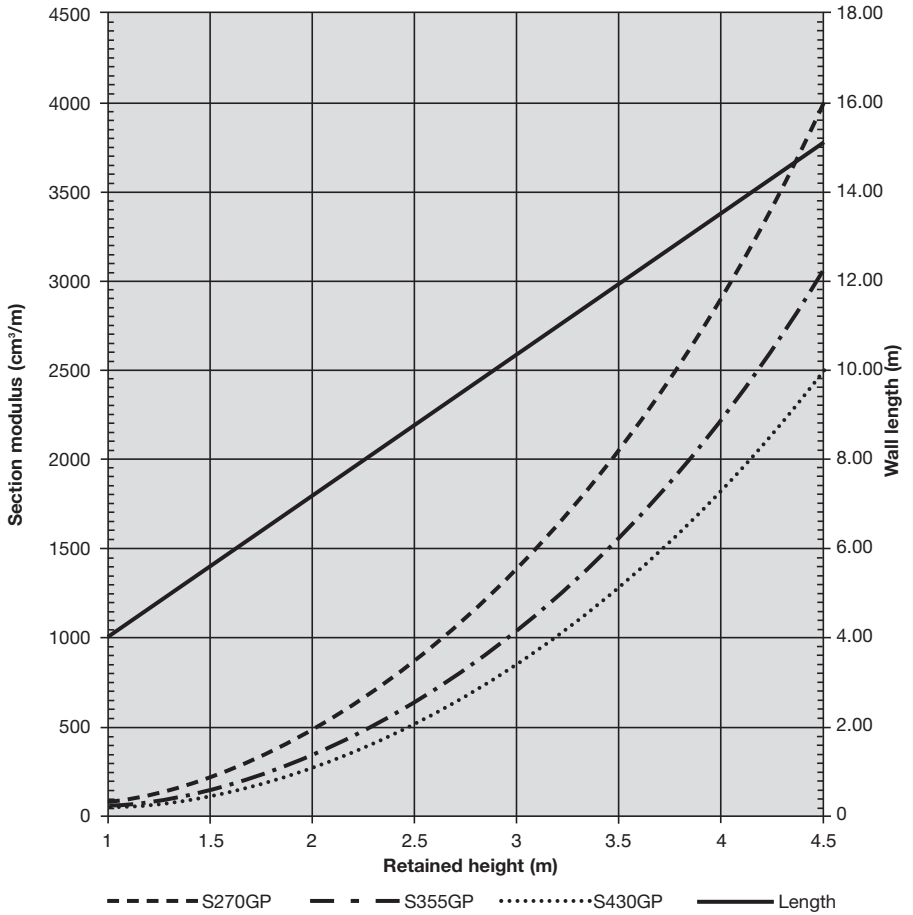

# Charts for retaining walls

Fig. 8.19 Tied - Water condition A (d=1.5m)

$\phi = 40^\circ$

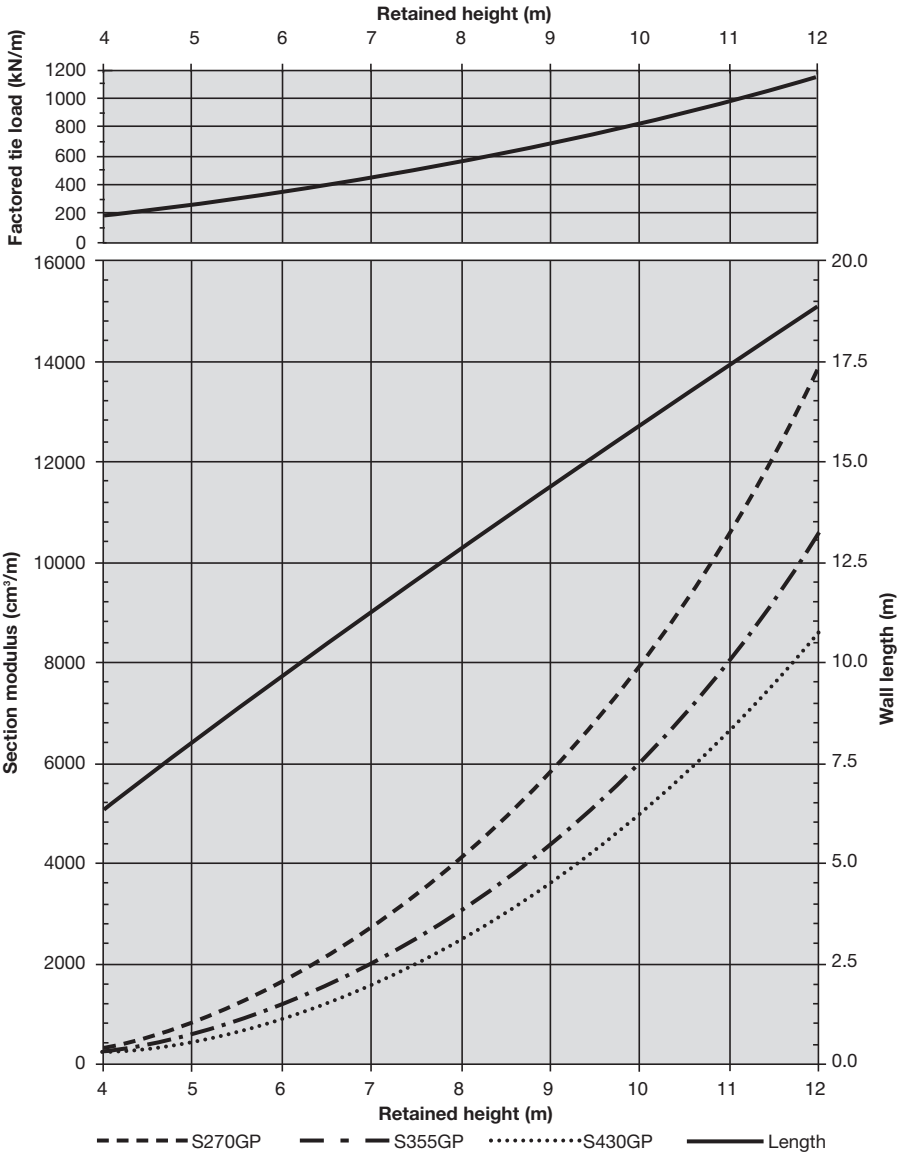

# Charts for retaining walls

Fig. 8.20 Tied - Water condition A (d=1.5m)

$\phi = 30^\circ$

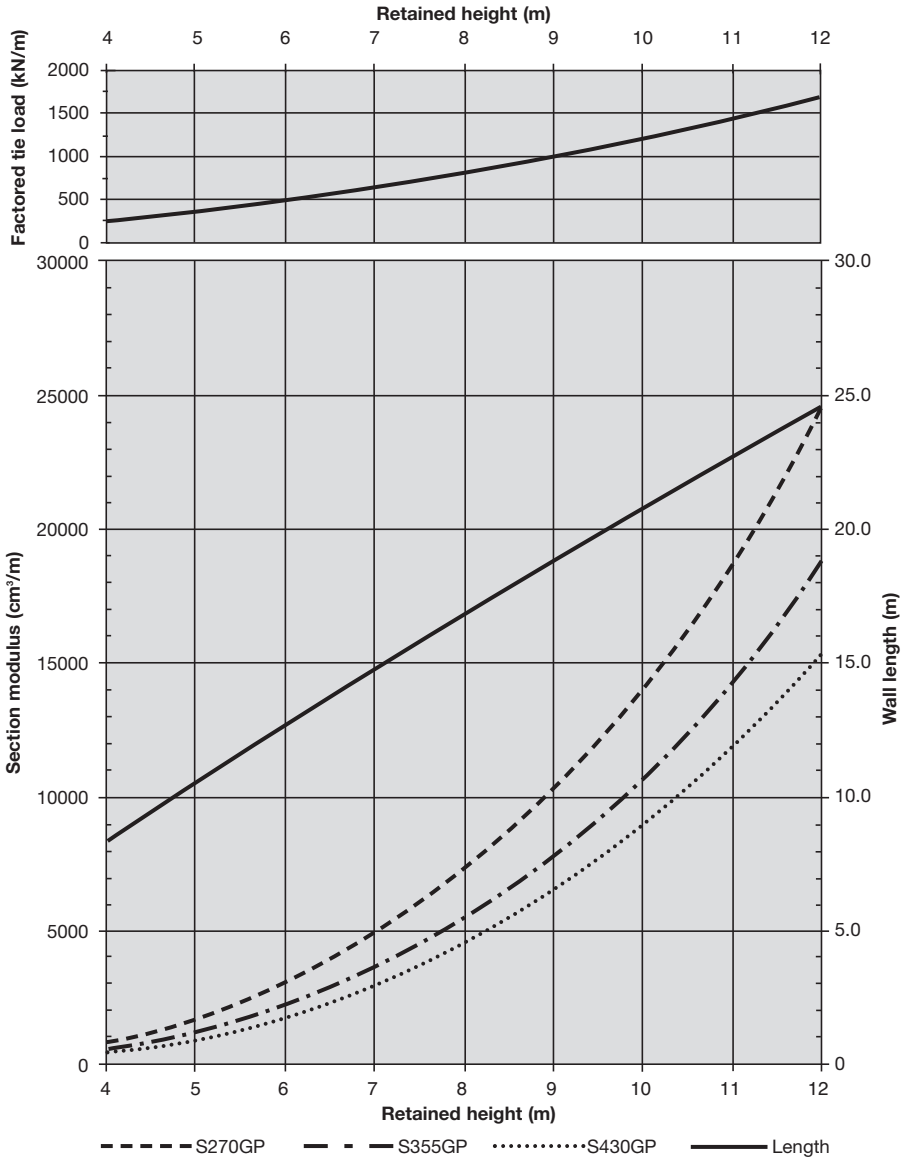



# Charts for retaining walls

Fig. 8.21 Tied - Water condition A (d=1.5m)

$\phi = 20^\circ$

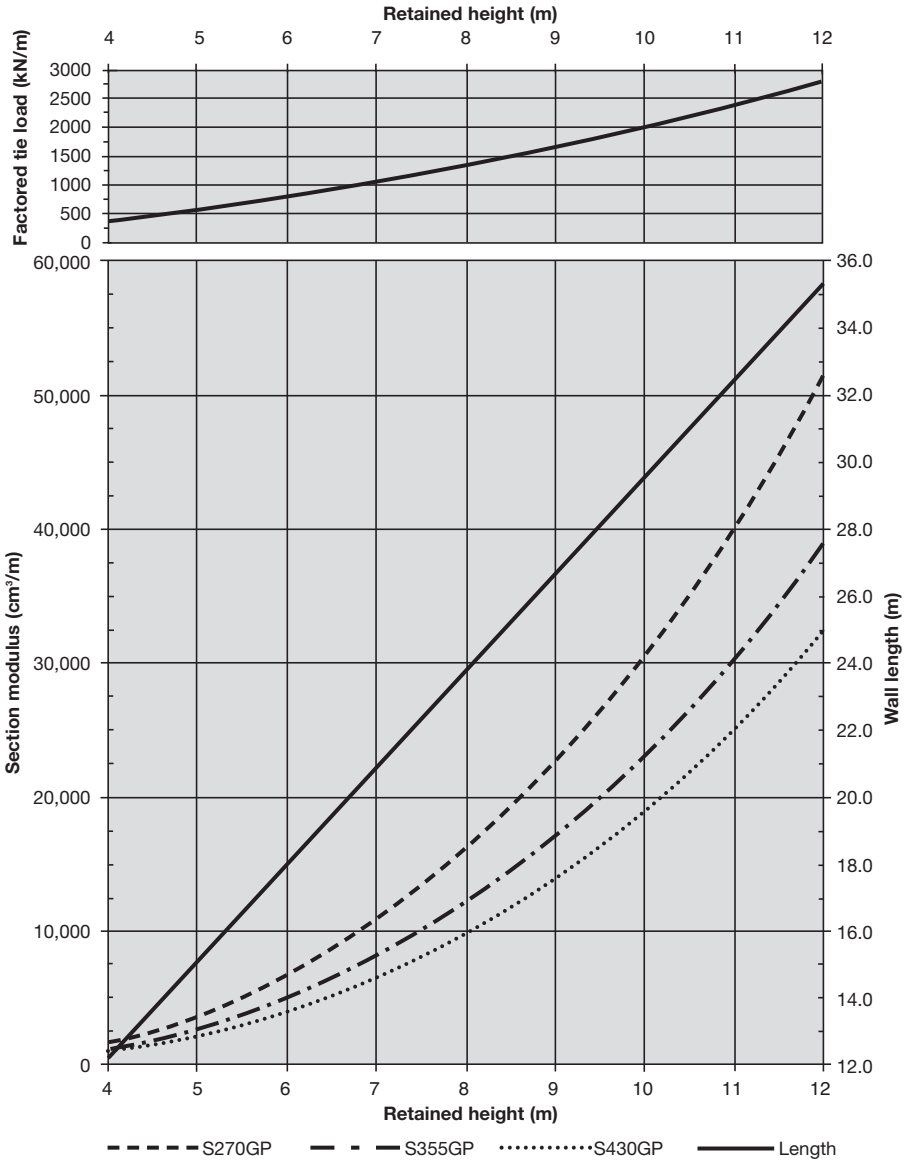

# Charts for retaining walls

Fig. 8.22 Tied - Water condition B (d=1.5m)

$\phi = 40^\circ$

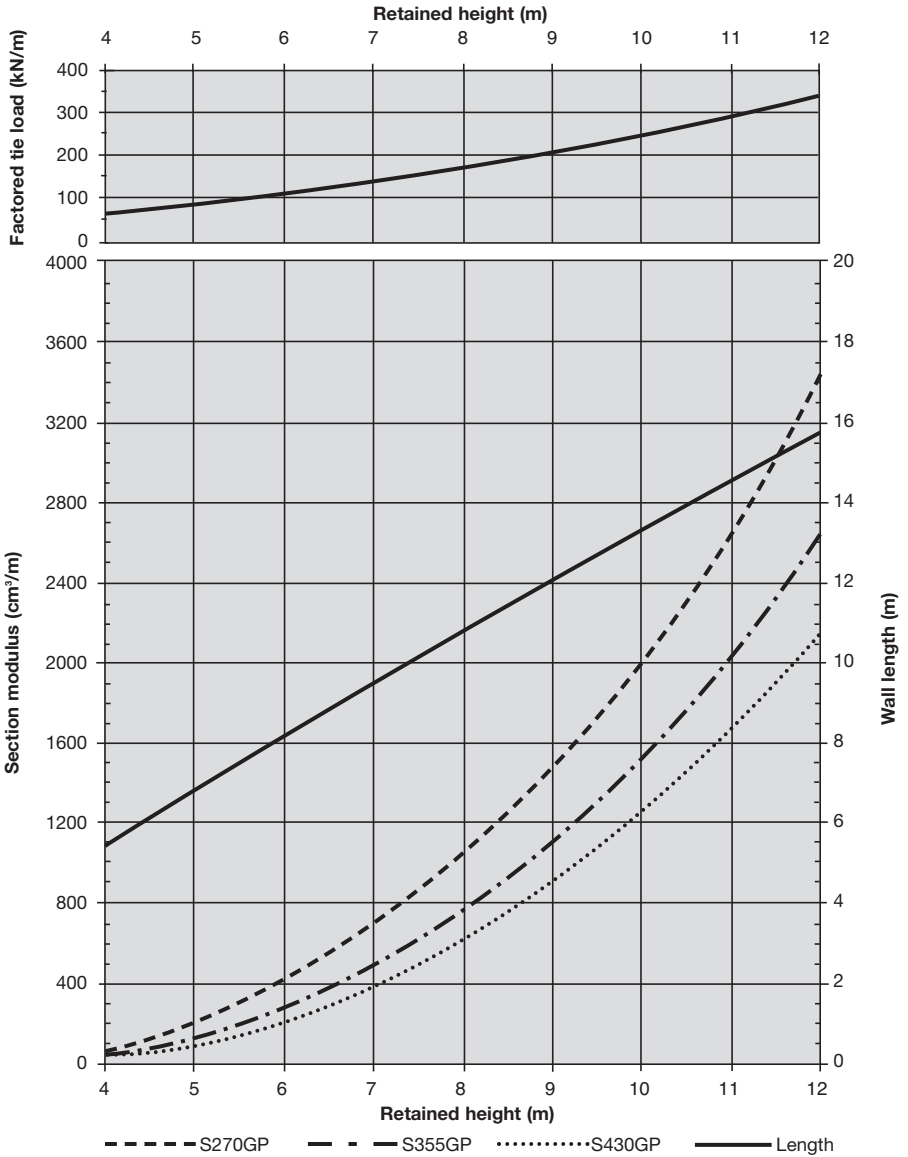

# Charts for retaining walls

Fig. 8.23 Tied - Water condition B (d=1.5m)

$\phi = 30^\circ$

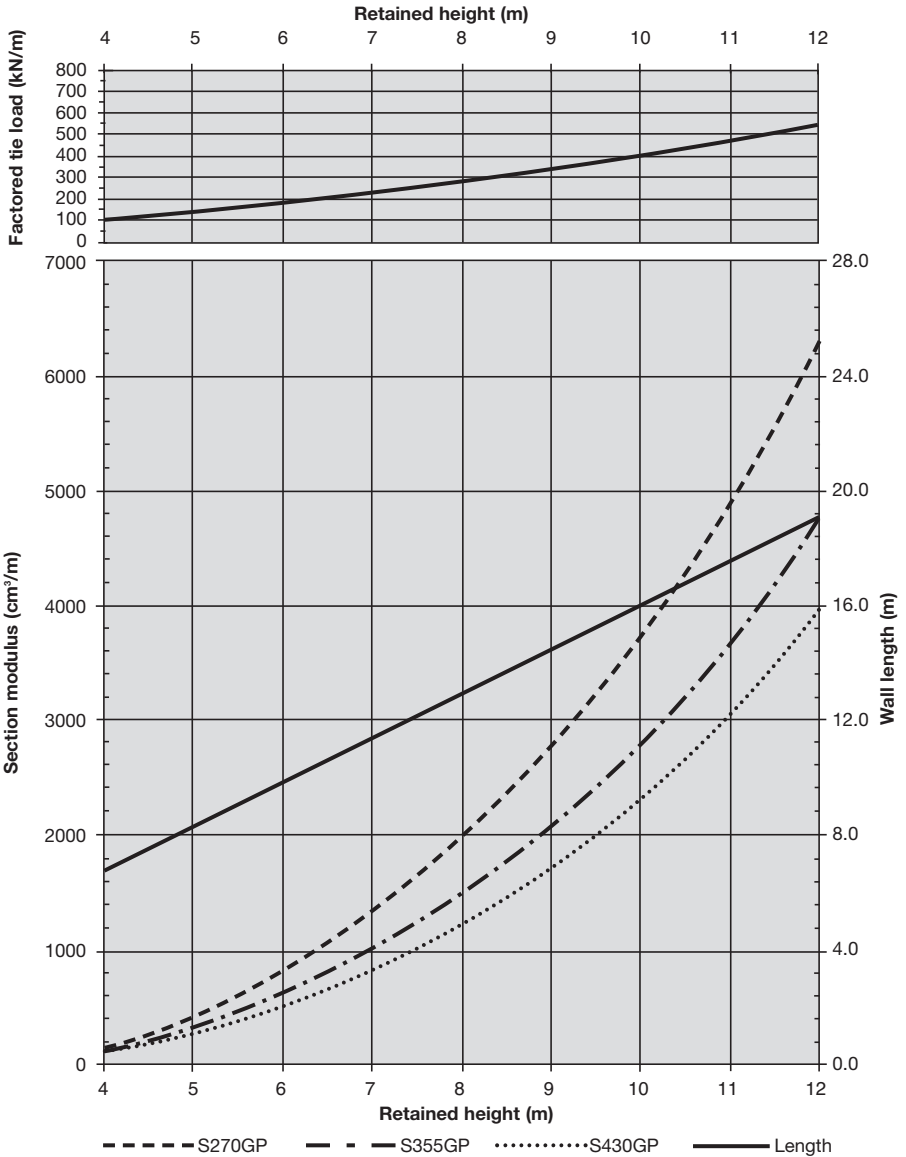

# Charts for retaining walls

Fig. 8.24 Tied - Water condition B (d=1.5m)

$\phi = 20^\circ$

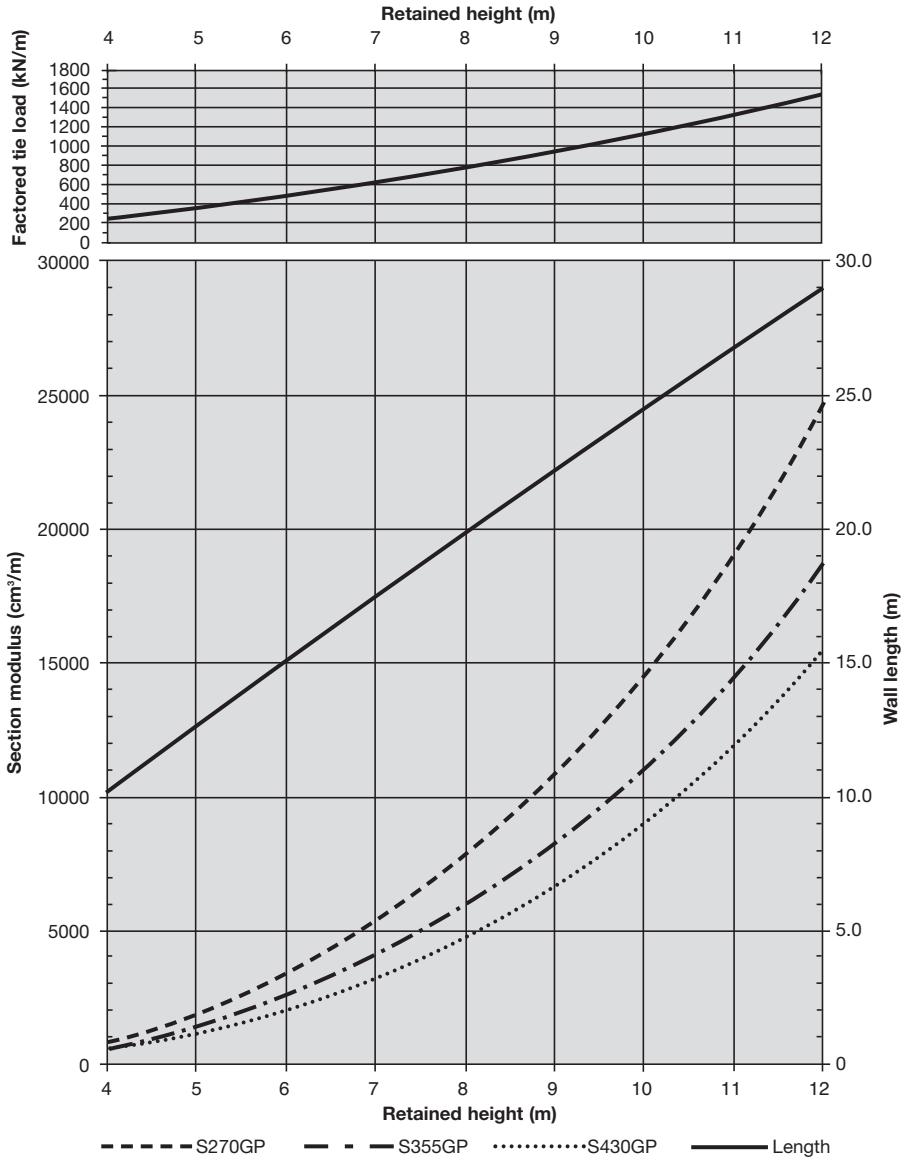

# Charts for retaining walls

Fig. 8.25 Tied - Water condition C (d=1.5m)

$\phi = 40^\circ$

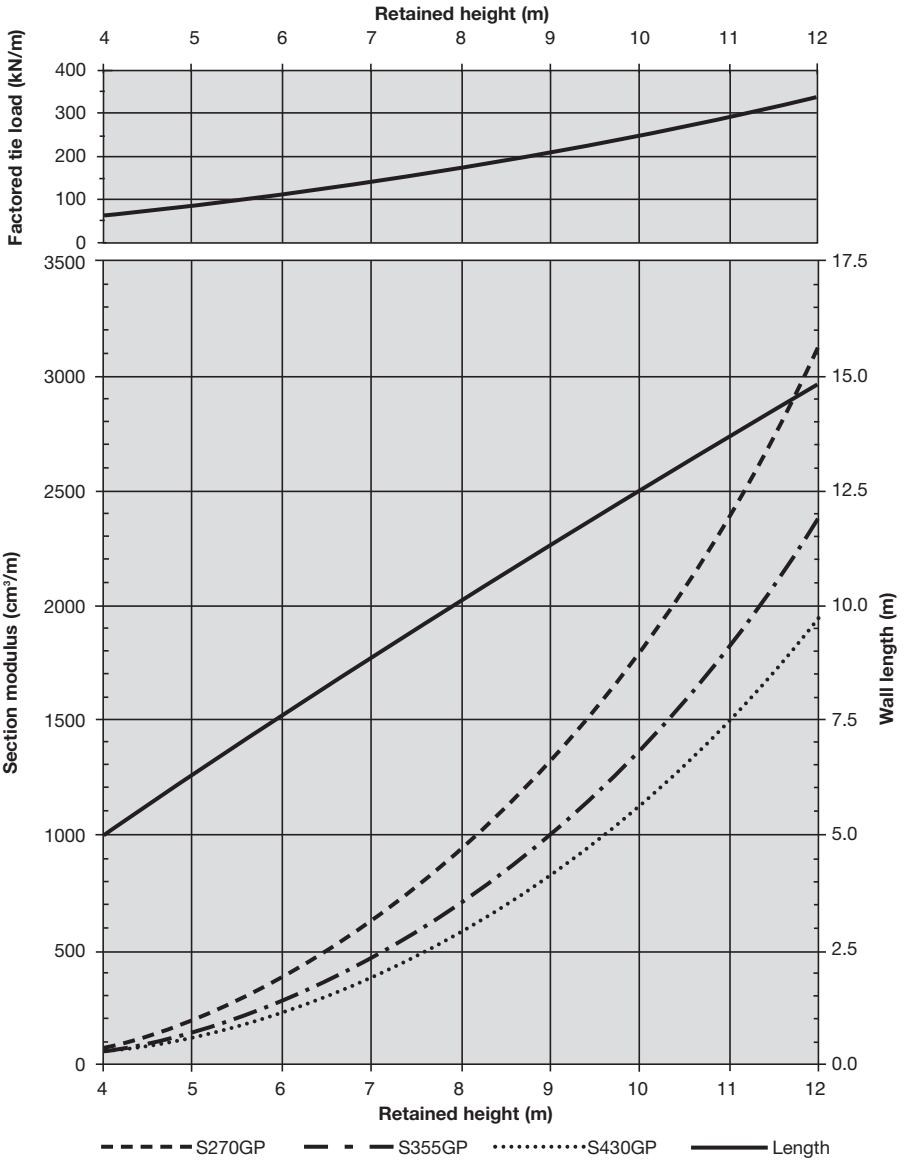

# Charts for retaining walls

Fig. 8.26 Tied - Water condition C (d=1.5m)

$\phi = 30^\circ$

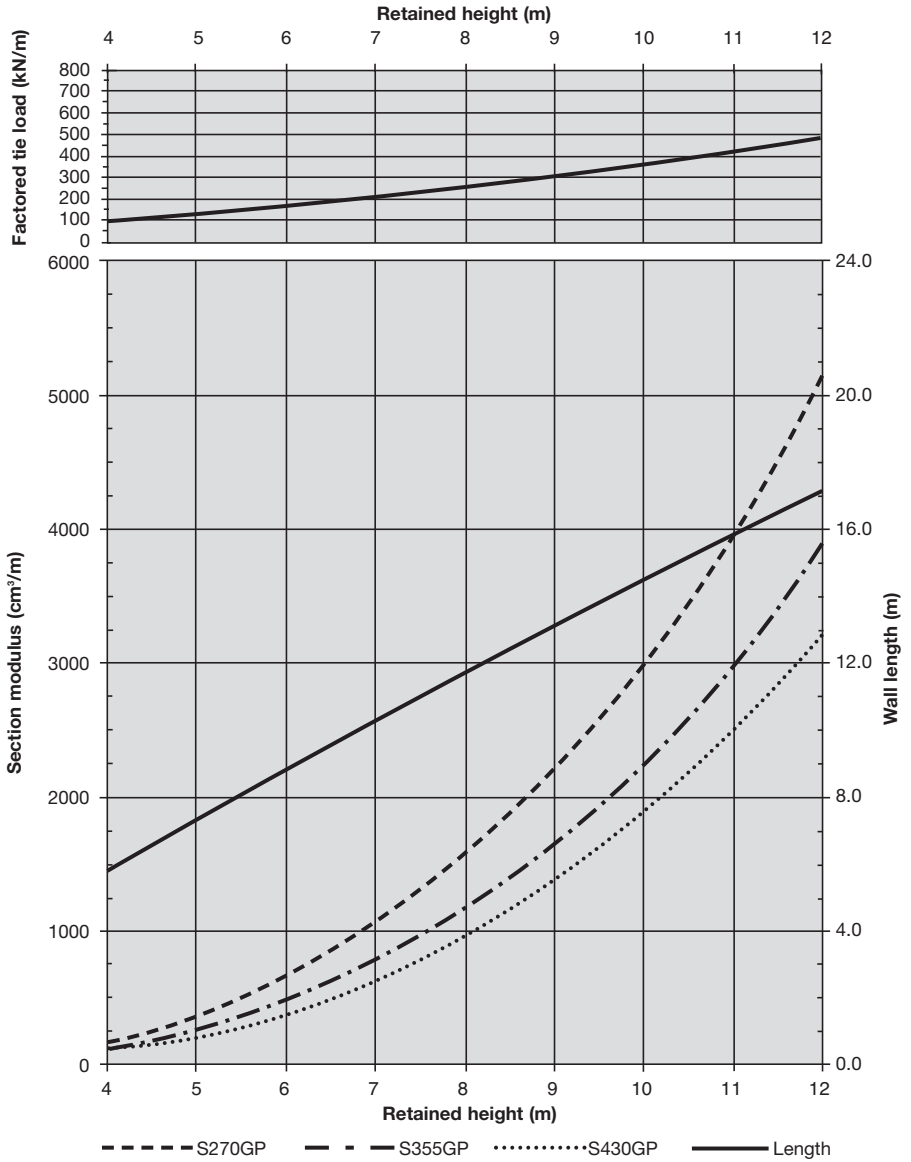

# Charts for retaining walls

Fig. 8.27 Tied - Water condition C (d=1.5m)

$\phi = 20^\circ$

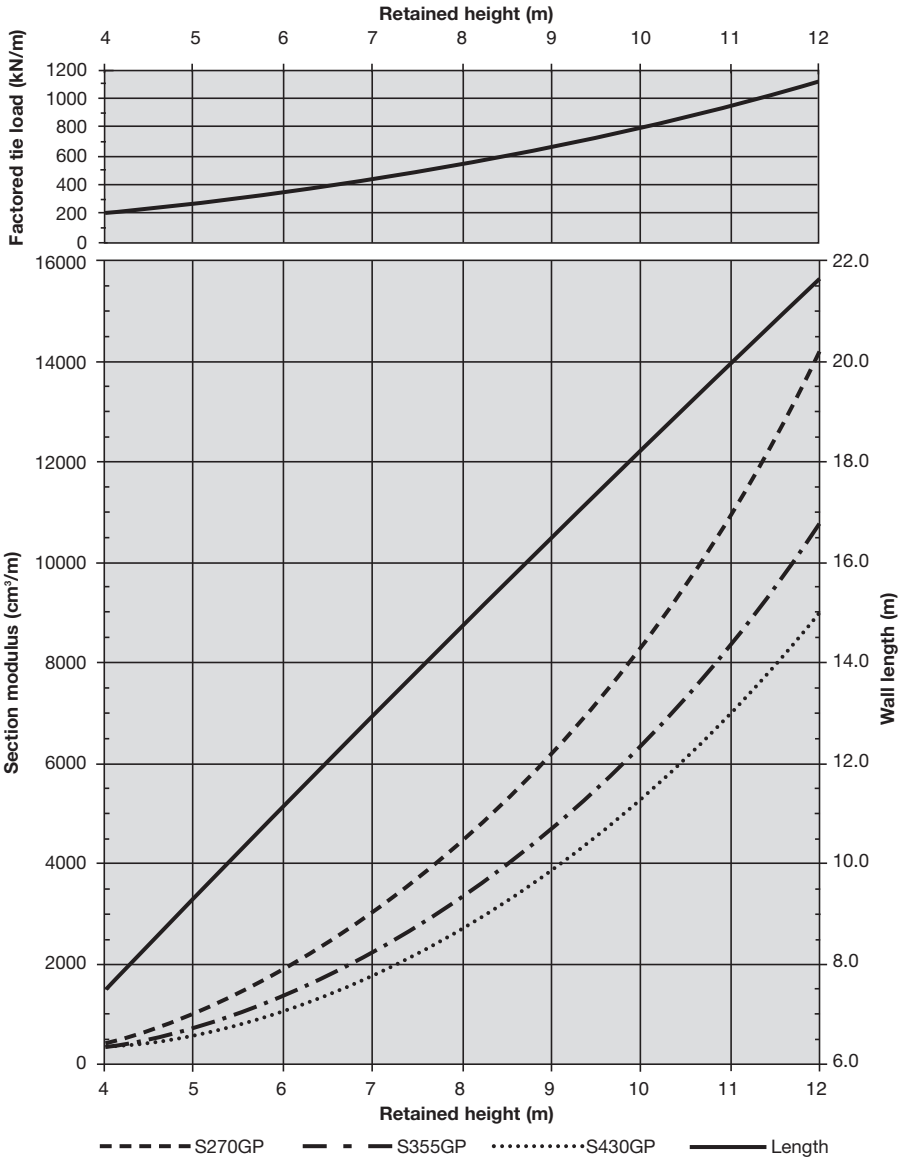

# Charts for retaining walls

Fig. 8.28 Cantilever - Water condition C

$S_u = 75\text{kN/m}^2$

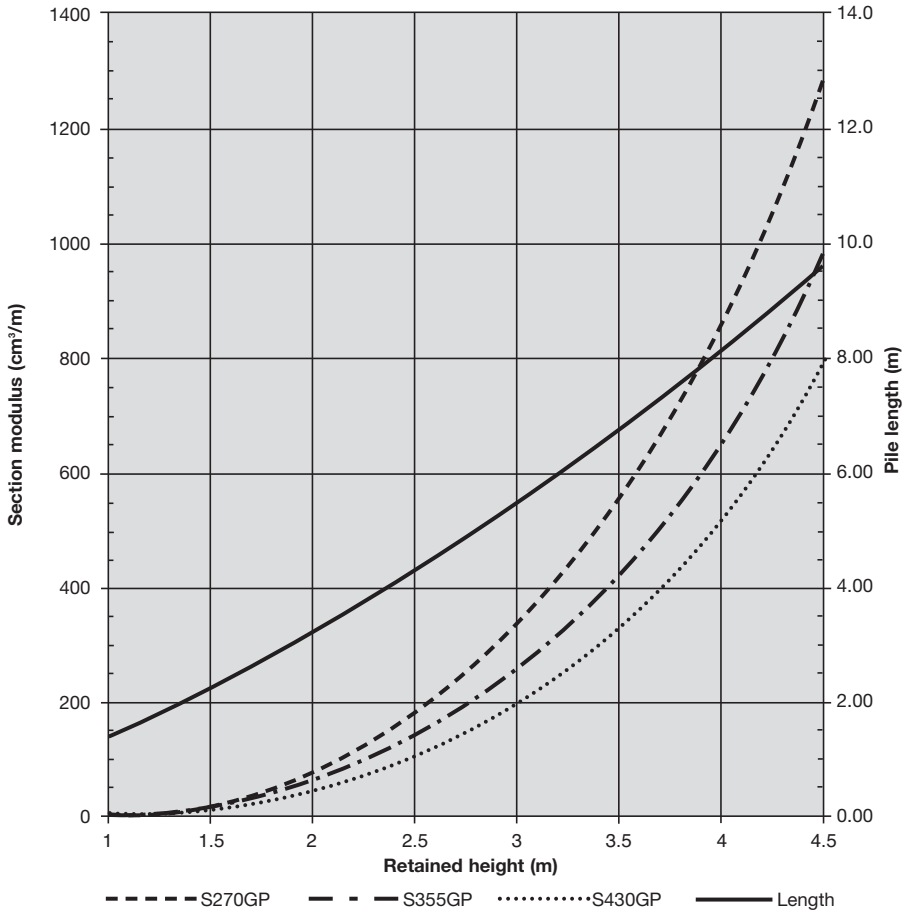



# Charts for retaining walls

Fig. 8.29 Cantilever - Water condition C  $S_u = 40\text{kN/m}^2$

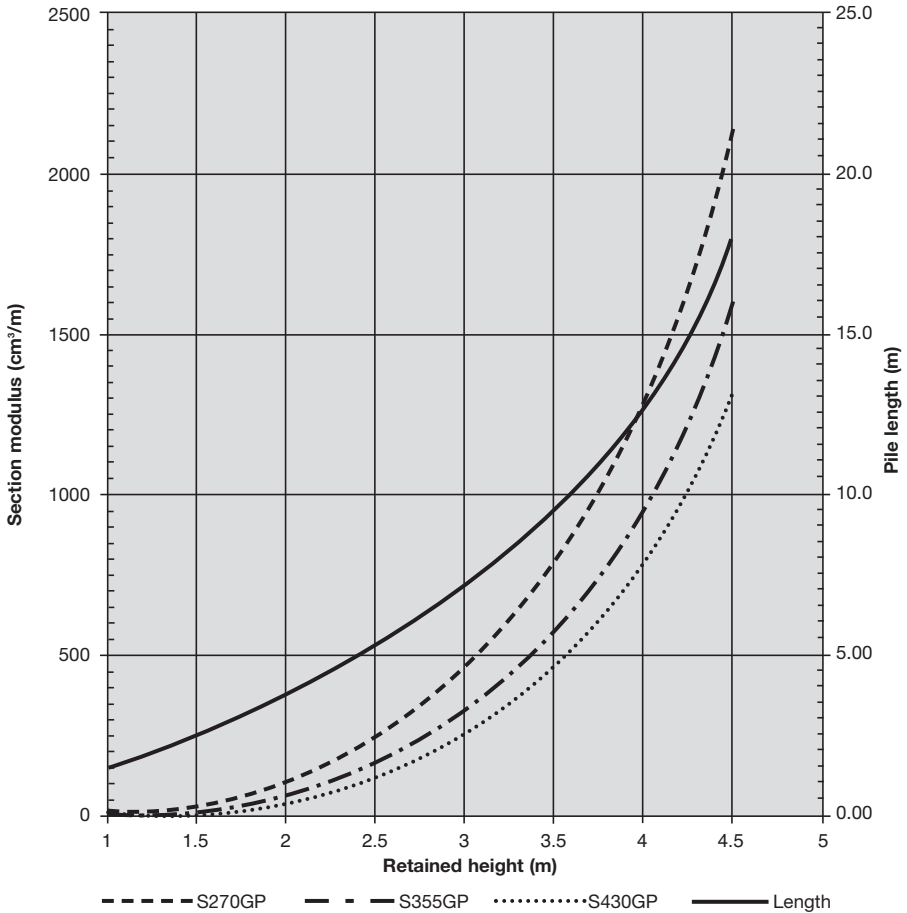

# Charts for retaining walls

Fig. 8.30 Cantilever - Water condition D  $S_u = 75\text{kN/m}^2$

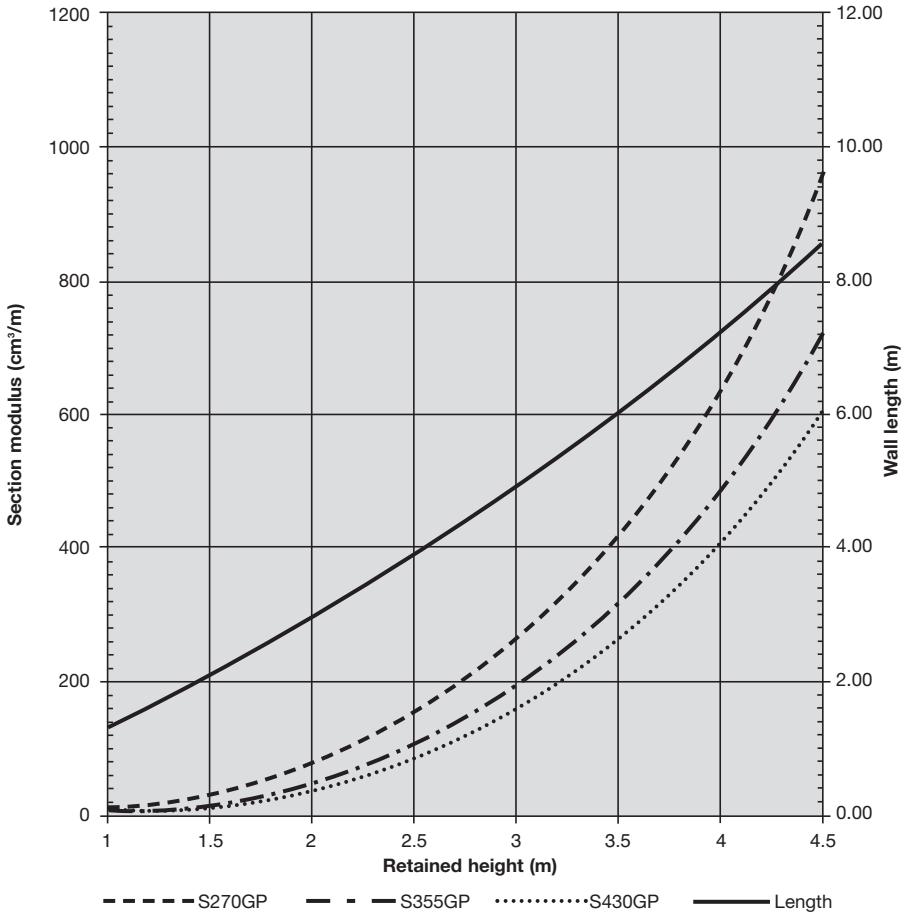

# Charts for retaining walls

Fig. 8.31 Cantilever - Water condition D  $S_u = 40\text{kN/m}^2$

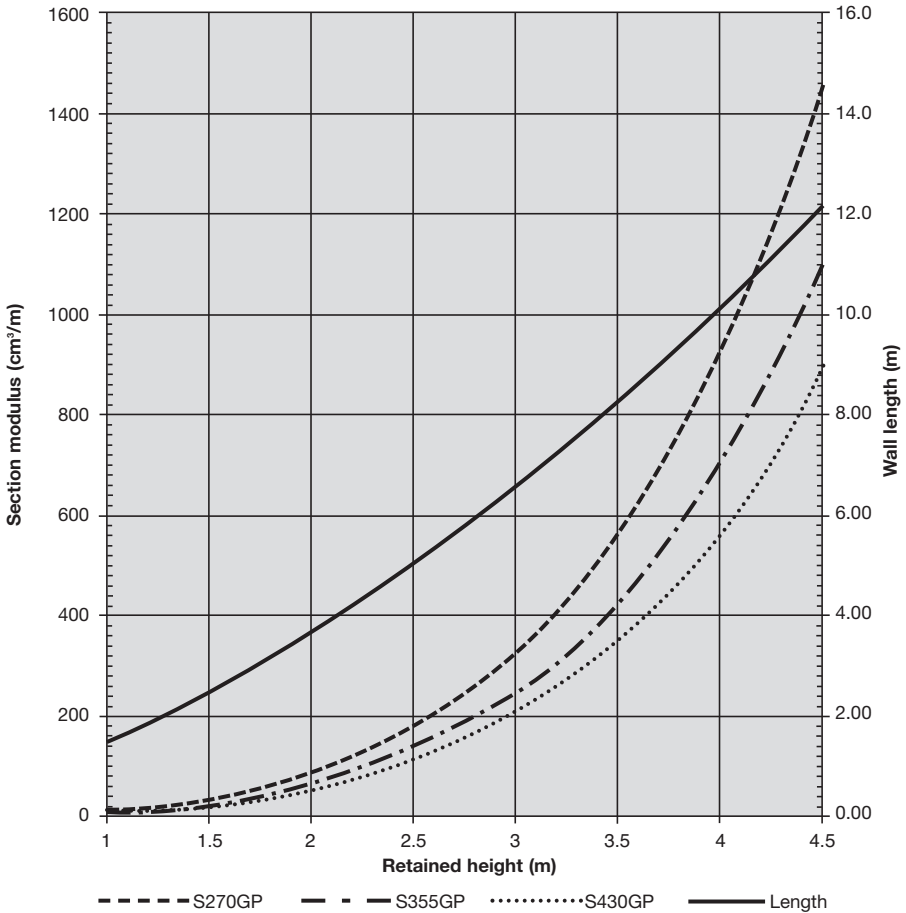

# Charts for retaining walls

Fig. 8.32 Tied - Water condition C (d=1.2m)  $S_u = 75\text{kN/m}^2$

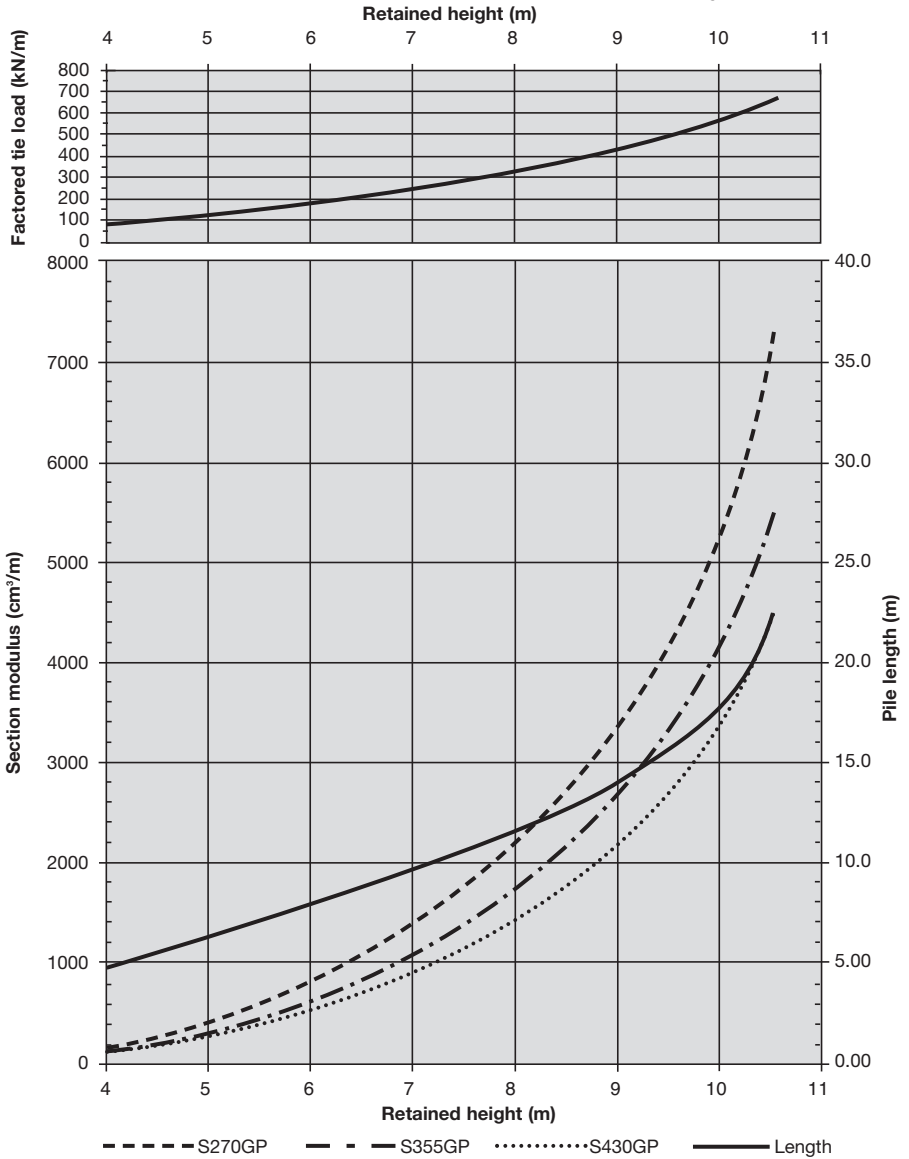

# Charts for retaining walls

Fig. 8.33 Tied - Water condition C (d = 1.2m)  $S_u = 40\text{kN/m}^2$

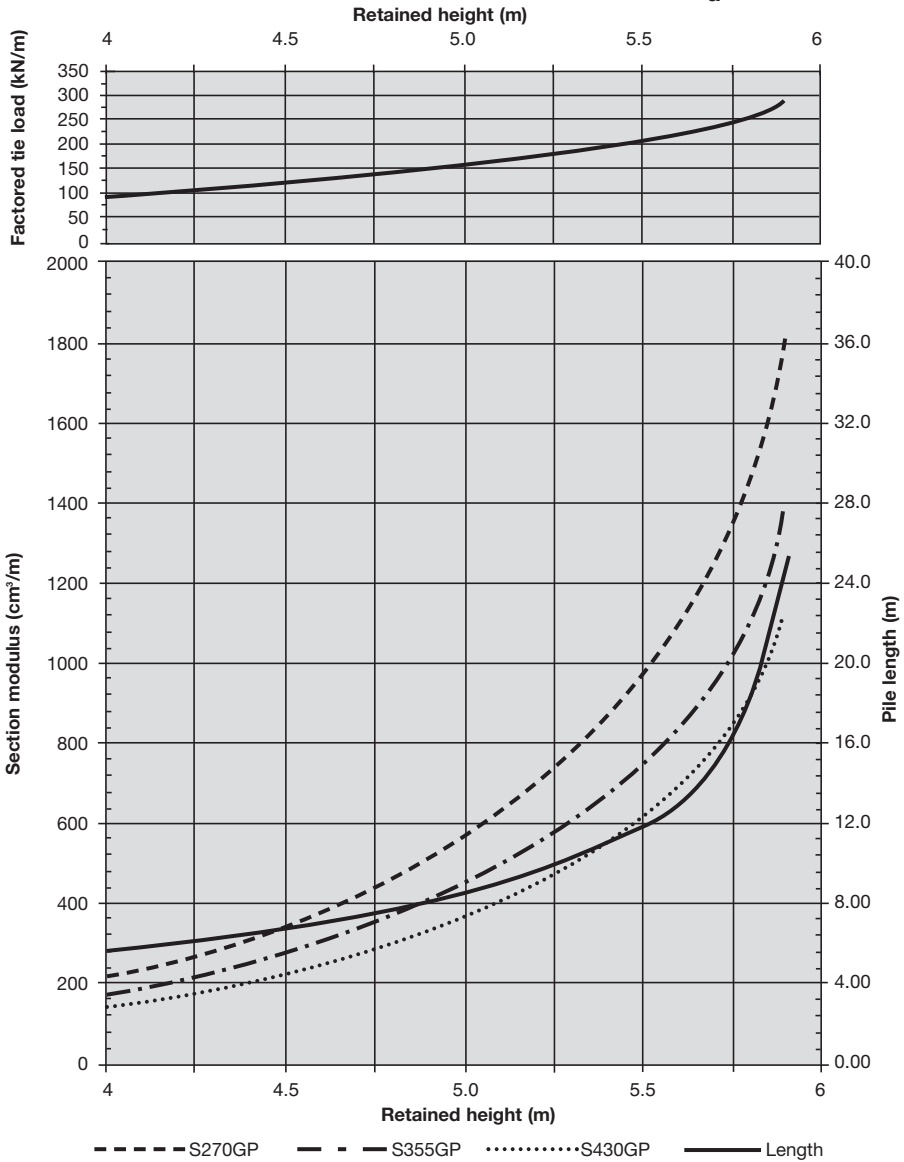

# Charts for retaining walls

Fig. 8.34 Tied - Water condition D (d=1.2m) **S<sub>u</sub> = 75kN/m<sup>2</sup>**

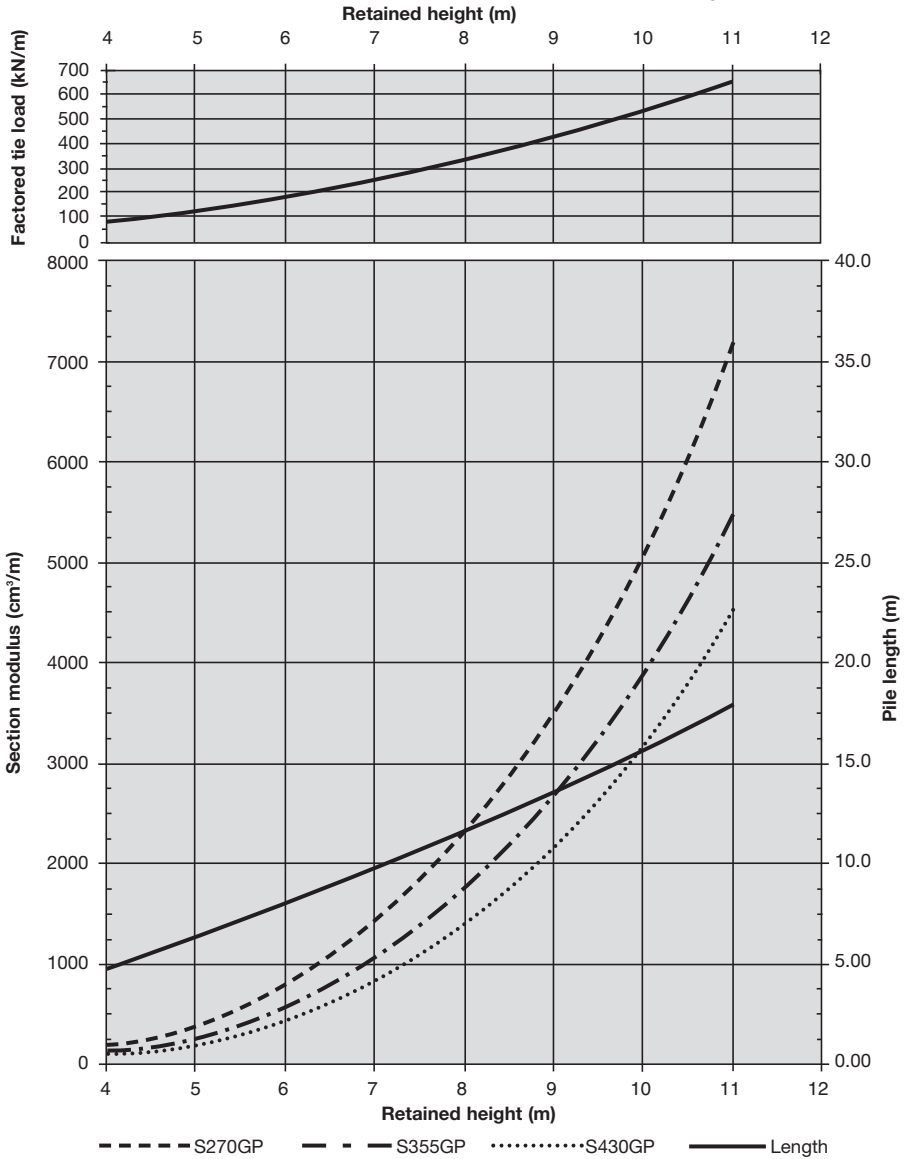

# Charts for retaining walls

Fig. 8.35 Tied - Water condition D (d=1.2m)  $S_u = 40\text{kN/m}^2$

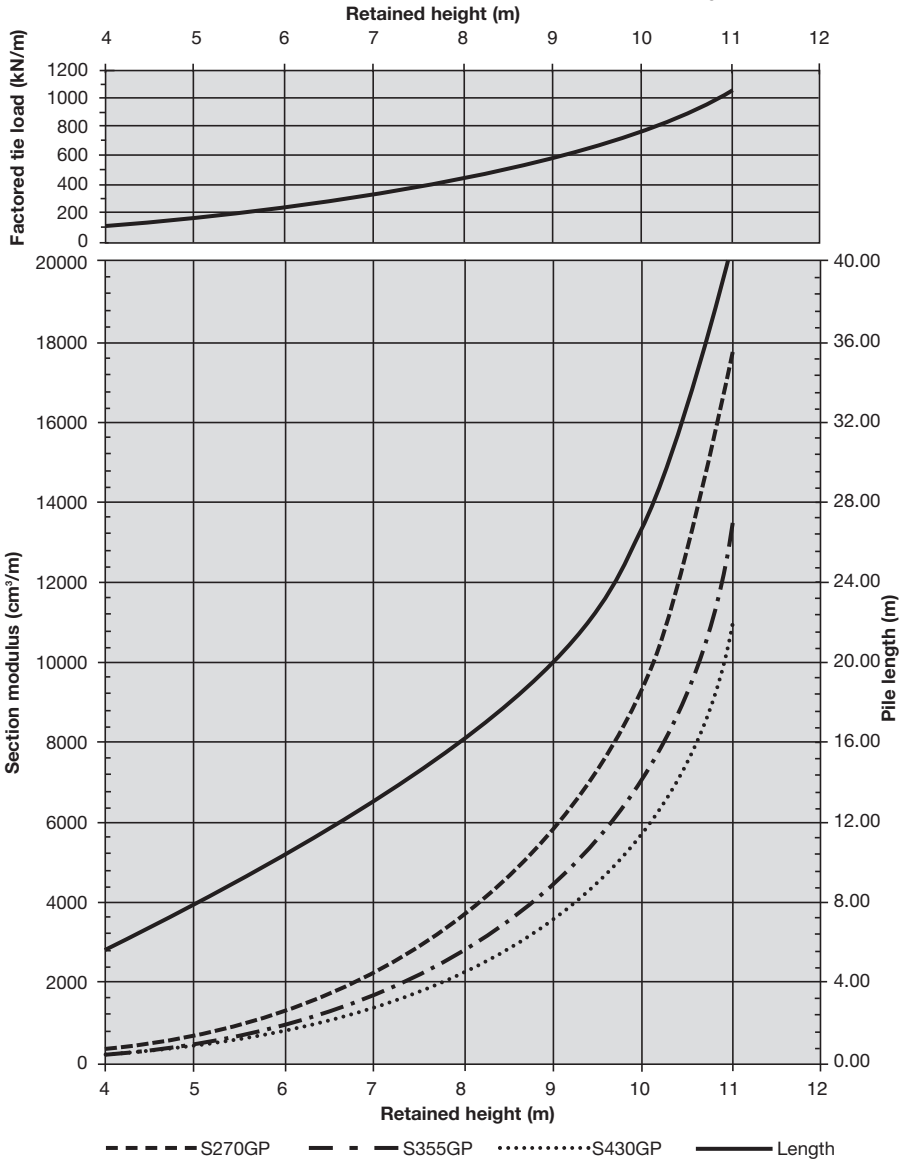



ArcelorMittal

- 1** Product information
- 2** Sealants
- 3** Durability
- 4** Earth and water pressure
- 5** Design of sheet pile structures
- 6** Retaining walls
- 7** Cofferdams
- 8** Charts for retaining walls
- 9** Circular cell construction design & installation
- 10** Bearing piles and axially loaded sheet piles
- 11** Installation of sheet piles
- 12** Noise and vibration from piling operations
- 13** Useful information



# Circular cell construction design & installation

Contents	Page
<b>9.1 Introduction</b>	1
<b>9.2 Straight web piling</b>	1
9.2.1 Dimensions and properties for AS 500 straight web piles	1
<b>9.3 Interlock strength</b>	2
<b>9.4 Junction piles</b>	3
<b>9.5 Types of cell</b>	3
<b>9.6 Bent piles</b>	3
<b>9.7 Equivalent width and ratio</b>	4
<b>9.8 Geometry</b>	5
9.8.1 Circular cells	5
9.8.2 Diaphragm cells	6
<b>9.9 Handling straight web piles</b>	7

## Circular cell construction design & installation



# Circular cell construction design & installation

## 9.1 Introduction

Cellular cofferdams are self-supporting gravity structures constructed using straight web sheet piles to form various shapes. The piles are interlocked and driven to form closed cells which are then filled with cohesionless material. To achieve continuity of the wall, the circular cells are connected together using fabricated junction piles and short arcs.

Provided that the material on which they are to be founded is solid they require only nominal penetration to be stable. Pile penetration will assist in the resistance of any lateral loads occurring during the construction phase in the vulnerable period before the fill has been placed and the cell has become inherently stable.

Cellular cofferdam structures are used to retain considerable depths of water or subsequently placed fill. They are commonly used as dock closure cofferdams, or to form quay walls and breakwaters. The straight web pile section and particularly the interlocks have been designed to resist the circumferential tension which is developed in the cells due to the radial pressure of the contained fill and at the same time permit sufficient angular deflection to enable cells of a practical diameter to be formed. In cellular construction no bending moments are developed in the sheet piles which enables the steel to be disposed in such a manner that the maximum tensile resistance is developed across the profile. The sections have therefore very little resistance to bending and are not suitable for normal straight sheet pile wall construction. Walings and tie rods are not required.

The design and construction of cellular cofferdams is very complex and further information is available from our Technical Department.

# Circular cell construction design & installation

## 9.2 Straight web piling

Table 9.2 Tolerances for straight web piles to EN 10248 Part 2

Tolerances	AS 500
Mass	±5%
Length	±200mm
Height	-
Thickness	t, s > 8.5mm: ±6%
Width single pile	±2%
Width double pile	±3%
Straightness	0.2% of the length
Ends out of square	2% of pile width

### 9.2.1 Dimensions and properties for AS 500 Straight Web piles

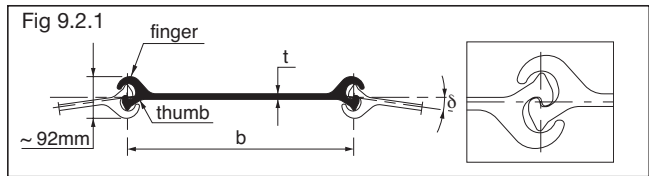

Table 9.2.1

Section	Nominal width*	Web thickness	Deviation angle	Perimeter of a single pile	Steel section of a single pile	Mass per m of a single pile	Mass per m <sup>2</sup> of wall	Moment of inertia of a single pile	Section modulus	Coating area***
	b mm	t mm	δ °							
<b>AS 500-9,5</b>	500	9.5	4.5**	138	81.3	63.8	<b>128</b>	168	46	0.58
<b>AS 500-11,0</b>	500	11.0	4.5**	139	90.0	70.6	<b>141</b>	186	49	0.58
<b>AS 500-12,0</b>	500	12.0	4.5**	139	94.6	74.3	<b>149</b>	196	51	0.58
<b>AS 500-12,5</b>	500	12.5	4.5**	139	97.2	76.3	<b>153</b>	201	51	0.58
<b>AS 500-12,7</b>	500	12.7	4.5**	139	98.2	77.1	<b>154</b>	204	51	0.58

Note: all straight web sections interlock with each other.

\* The **effective width** to be taken into account for design purposes (lay-out) is **503 mm** for all AS 500 sheet piles.

\*\* Max. deviation angle 4.0° for pile length > 20 m.

\*\*\* On both sides, excluding inside of interlocks.

### 9.3 Interlock strength

The interlock complies with EN 10248. Following interlock strength  $F_{max}$  can be achieved with a steel grade S 355 GP. However, higher steel grades are available.

Sheet pile	$F_{max}$ [kN/m]
AS 500 - 9.5	3,000
AS 500 - 11.0	3,500
AS 500 - 12.0	5,000
AS 500 - 12.5	5,500
AS 500 - 12.7	5,500

For verification of the strength of piles, both yielding of the web and failure of the interlock should be considered. The allowable tension force T in the pile may be obtained by applying a safety factor, for example:

$$T = \frac{1}{\eta} R.$$

## Circular cell construction design & installation

The magnitude of the safety factor depends on the calculation method and assumptions, the installation method and the function of the structure. When two different sections are used in the same section of wall, the lowest allowable tension force is to be taken into account. The value of  $\eta = 2.0$  is currently used.

### 9.4 Junction piles

In general junction piles are assembled by welding in accordance with EN 12063.

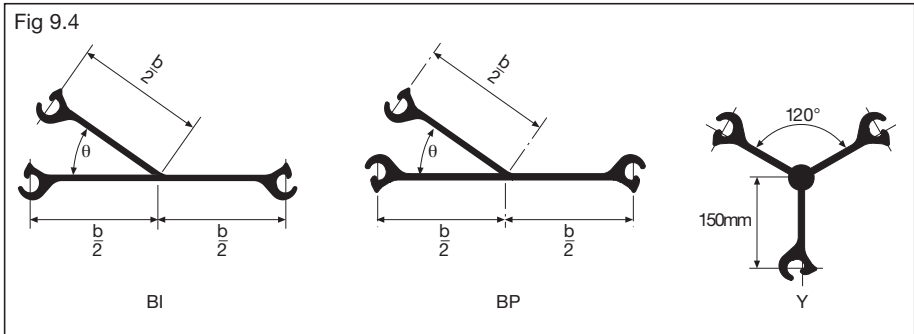

The connecting angle  $\theta$  should be in the range from  $30^\circ$  to  $45^\circ$ .

### 9.5 Types of cell

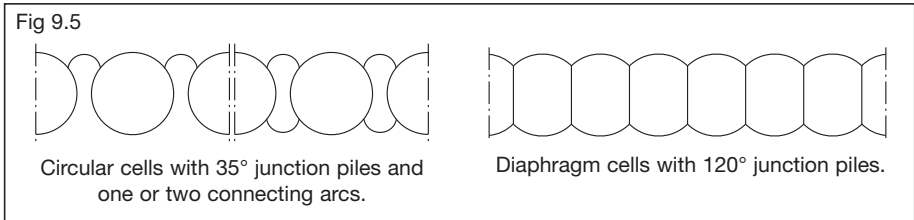

### 9.6 Bent piles

If deviation angles exceeding the values given in table 9.2.2 have to be attained, piles pre-bent in the mill may be used.



# Circular cell construction design & installation

## 9.7 Equivalent width and ratio

Fig 9.7

The **equivalent width**  $w_e$  which is required for stability verification, determines the geometry of the chosen cellular construction.

- for circular cells

$$w_e = \frac{\text{Area within 1 cell} + \text{Area within 2 (or 1) arc(s)}}{\text{System length } x}$$

The **ratio** shown on tables indicates how economical the chosen circular cell will be.

$$\text{Ratio} = \frac{\text{Development 1 cell} + \text{Development 2 (or 1) arc(s)}}{\text{System length } x}$$

- for diaphragm cells

$$w_e = \text{diaphragm wall length (d)} + 2 \cdot c$$

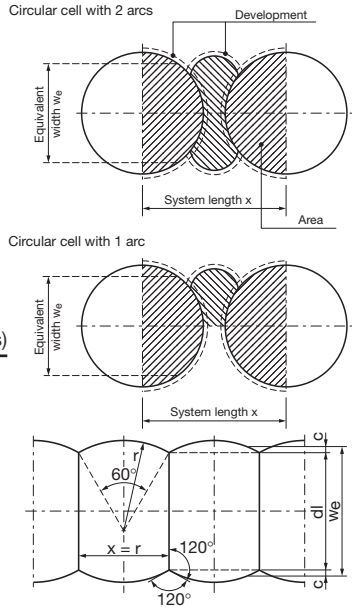

# Circular cell construction design & installation

## 9.8 Geometry

### 9.8.1 Circular cells

Once the equivalent width has been determined, the geometry of the cells is to be defined. This can be done with the help of tables or with computer programs. Several solutions are possible for both circular and diaphragm cells with a given equivalent width.

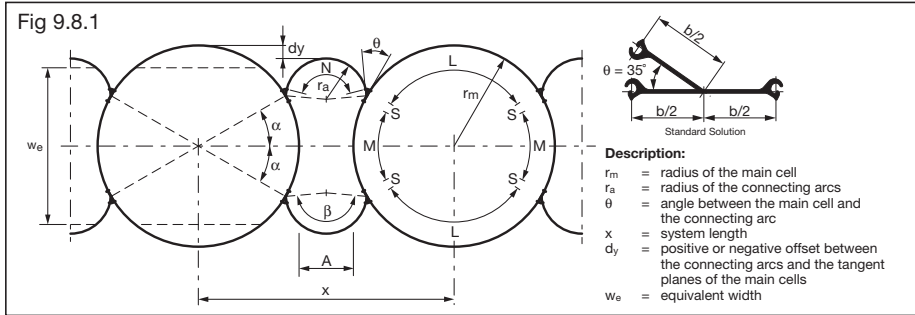

Junction piles with angles  $\theta$  between  $30^\circ$  and  $45^\circ$ , as well as  $\theta = 90^\circ$ , are possible on request. The following table shows a short selection of solutions for circular cells with 2 arcs and standard junction piles with  $\theta = 35^\circ$ .

Table 9.8.1

Cell	Number of piles per					Geometrical values						Interlock deviation cell arc		Design values	
	L pcs.	M pcs.	S pcs.	N pcs.	pcs.	$d=2r_m$ m	$r_a$ m	$x$ m	$d_y$ m	$\alpha$ °	$\beta$ °	$\delta_m$ °	$\delta_a$ °	$w_e$ m	ratio
100	33	15	4	25	150	16.01	4.47	22.92	0.16	28.80	167.60	3.60	6.45	13.69	3.34
104	35	15	4	27	158	16.65	4.88	24.42	0.20	27.69	165.38	3.46	5.91	14.14	3.30
108	37	15	4	27	162	17.29	4.94	25.23	0.54	26.67	163.33	3.33	5.83	14.41	3.27
112	37	17	4	27	166	17.93	4.81	25.25	0.33	28.93	167.86	3.21	6.00	15.25	3.35
116	37	19	4	27	170	18.57	4.69	25.27	0.13	31.03	172.07	3.10	6.15	16.08	3.42
120	39	19	4	29	178	19.21	5.08	26.77	0.16	30.00	170.00	3.00	5.67	16.54	3.38
124	41	19	4	29	182	19.85	5.14	27.59	0.50	29.03	168.06	2.90	5.60	16.82	3.35
128	43	19	4	31	190	20.49	5.55	29.09	0.53	28.13	166.25	2.81	5.20	17.27	3.32
132	43	21	4	31	194	21.13	5.42	29.11	0.33	30.00	170.00	2.73	5.31	18.10	3.39
136	45	21	4	33	202	21.77	5.82	30.61	0.36	29.12	168.24	2.65	4.95	18.56	3.35
140	45	23	4	33	206	22.42	5.71	30.62	0.17	30.86	171.71	2.57	5.05	19.39	3.42
144	47	23	4	33	210	23.06	5.76	31.45	0.50	30.00	170.00	2.50	5.00	19.67	3.39
148	47	25	4	35	218	23.70	5.99	32.13	0.00	31.62	173.24	2.43	4.81	20.67	3.44
152	49	25	4	35	222	24.34	6.05	32.97	0.34	30.79	171.58	2.37	4.77	20.95	3.42
156	49	27	4	35	226	24.98	5.94	32.98	0.15	32.31	174.62	2.31	4.85	21.76	3.48
160	51	27	4	37	234	25.62	6.33	34.48	0.17	31.50	173.00	2.25	4.55	22.23	3.44
164	53	27	4	39	242	26.26	6.72	35.98	0.20	30.73	171.46	2.20	4.29	22.69	3.41
168	55	27	4	41	250	26.90	7.12	37.48	0.23	30.00	170.00	2.14	4.05	23.15	3.38
172	55	29	4	41	254	27.54	7.00	37.49	0.03	31.40	172.79	2.09	4.11	23.98	3.43
176	57	29	4	41	258	28.18	7.06	38.32	0.37	30.68	171.36	2.05	4.08	24.26	3.41
180	59	29	4	43	266	28.82	7.46	39.82	0.40	30.00	170.00	2.00	3.86	24.72	3.39
184	59	31	4	43	270	29.46	7.35	39.83	0.20	31.30	172.61	1.96	3.92	25.54	3.43
188	61	31	4	45	278	30.10	7.74	41.33	0.23	30.64	171.28	1.91	3.72	26.00	3.41

# Circular cell construction design & installation

## 9.8.2 Diaphragm cells

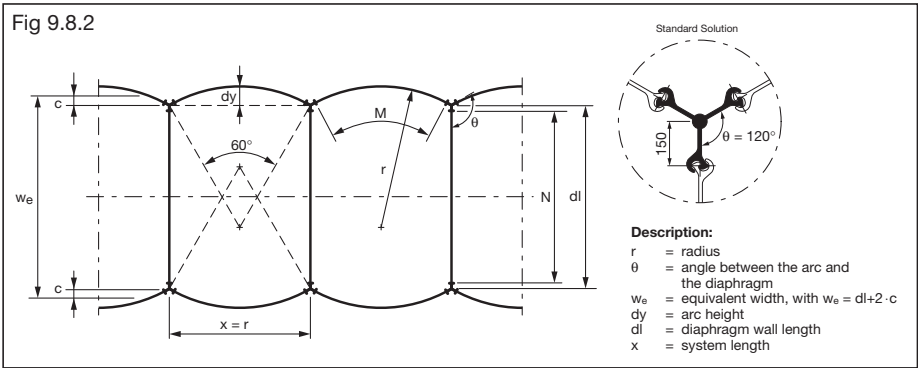

The two parts of the following table should be used separately depending on the required number of piles for the diaphragm wall and the arcs.

Table 9.8.2

Geometry of the diaphragms		Geometry of the arcs				
Number of piles	Wall length	Number of piles	System length	Arc height	Interlock deviation arc	
N	dl m	M	x m	dy m	c m	$\delta a$ °
11	5.83	11	5.57	0.75	0.51	5.17
13	6.84	13	6.53	0.87	0.59	4.41
15	7.85	15	7.49	1.00	0.68	3.85
17	8.85	17	8.45	1.13	0.77	3.41
19	9.86	19	9.41	1.26	0.86	3.06
21	10.86	21	10.37	1.39	0.94	2.78
23	11.87	23	11.33	1.52	1.03	2.54
25	12.88	25	12.29	1.65	1.12	2.34
27	13.88	27	13.26	1.78	1.20	2.17
29	14.89	29	14.22	1.90	1.29	2.03
31	15.89	31	15.18	2.03	1.38	1.90
33	16.90	33	16.14	2.16	1.46	1.79
35	17.91	35	17.10	2.29	1.55	1.69
37	18.91	37	18.06	2.42	1.64	1.60
39	19.92	39	19.02	2.55	1.73	1.52
41	20.92	41	19.98	2.68	1.81	1.44
43	21.93	43	20.94	2.81	1.90	1.38
45	22.94	45	21.90	2.93	1.99	1.32
47	23.94	47	22.86	3.06	2.07	1.26
49	24.95	49	23.82	3.19	2.16	1.21
51	25.95	51	24.78	3.32	2.25	1.16
53	26.96	53	25.74	3.45	2.33	1.12
55	27.97	55	26.70	3.58	2.42	1.08



# Circular cell construction design & installation

## 9.9 Handling straight web piles

Unlike piles designed to resist bending moments, straight-web sheet piles have low flexural stiffness, which means that care must be taken over their handling.

Incorrect storage could cause permanent deformation, making interlock threading difficult if not impossible. It is therefore vital to have a sufficient number of wooden packing pieces between each bundle of stacked sheet piles, and to position these pieces above each other to limit the risk of deformation.

Fig 9.9a Storage of straight-web sheet piles

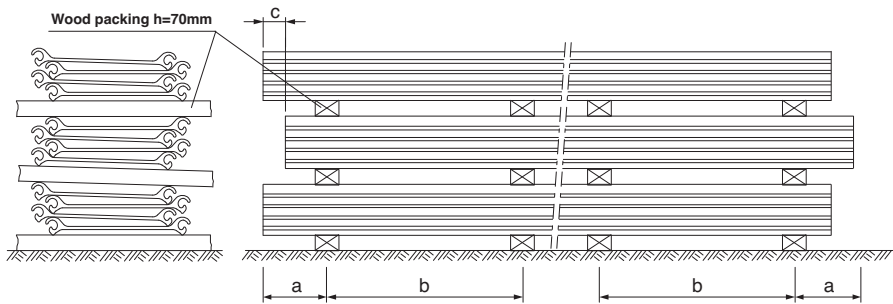

- max. bundle weight: 7.5 tonnes
- Overhang "a" less than 1.5 m
- Spacing of packings "b" less than 4.0 m
- Offset of bundle "c" not less than 0.15 m
- Wood packings to be aligned in the vertical plane

Fig 9.9b Storage and handling of straight-web sheet piles

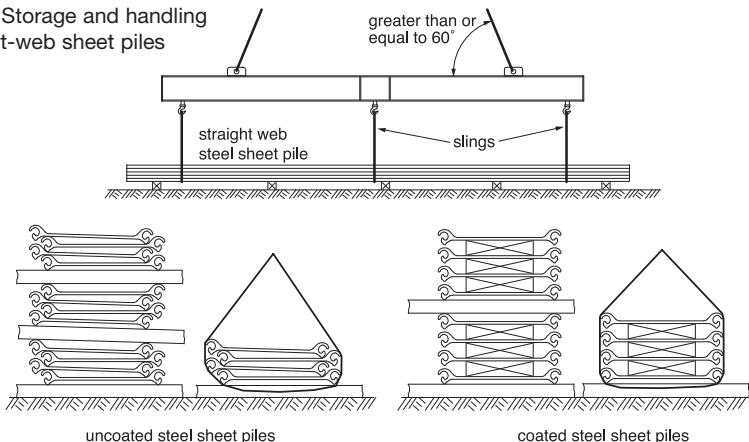

## Circular cell construction design & installation

When sheet piles have to be moved from the horizontal storage position to another storage location, lifting beams or brackets made from pile sections threaded into the interlocks prior to lifting should be used.

When pitching piles up to 15 m long into the vertical position, only one point of support near the top (the handling hole) is necessary.

Straight-web sheet piles more than 15 m long should be lifted at two or even three points, in order to avoid plastic distortion.

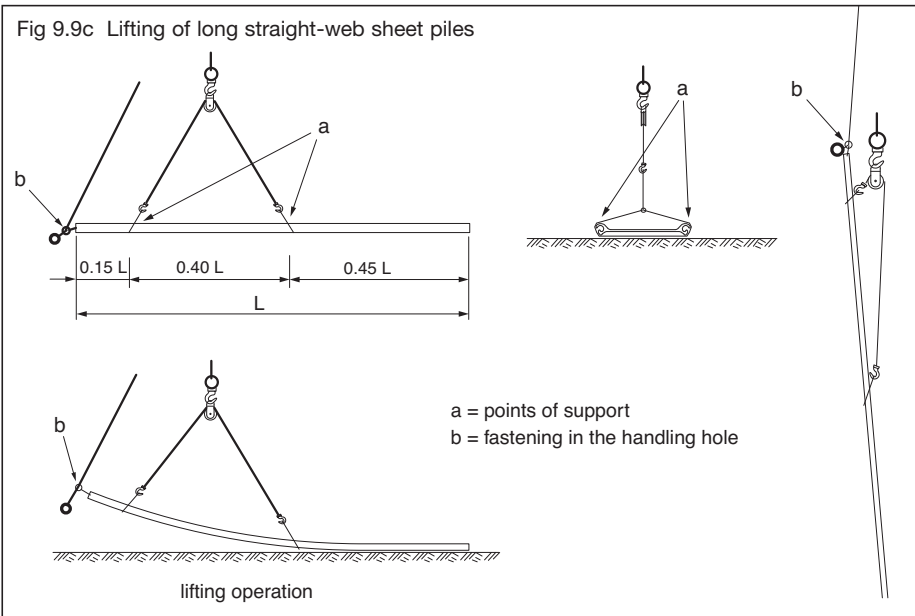



ArcelorMittal

- 1** Product information
- 2** Sealants
- 3** Durability
- 4** Earth and water pressure
- 5** Design of sheet pile structures
- 6** Retaining walls
- 7** Cofferdams
- 8** Charts for retaining walls
- 9** Circular cell construction design & installation
- 10** Bearing piles and axially loaded sheet piles
- 11** Installation of sheet piles
- 12** Noise and vibration from piling operations
- 13** Useful information

# Bearing piles and axially loaded sheet piles

<b>Contents</b>	<b>Page</b>
<b>10.1 Introduction</b>	1
<b>10.2 Types of load bearing piles</b>	2
<b>10.3 Design</b>	3
10.3.1 General	3
10.3.2 Determination of effective length	4
10.3.3 Vertical load capacity	4
10.3.4 Piles subjected to tensile forces	9
10.3.5 Lateral load	10
10.3.6 Pile groups	10
10.3.7 Negative skin friction	10
10.3.8 Set up	10
<b>10.4 Testing the load capacity of steel bearing piles</b>	11
<b>10.5 Welding of steel piles</b>	12
<b>10.6 Installation of bearing piles</b>	13
<b>10.7 Driving shoes</b>	13
<b>10.8 Axially loaded sheet piles</b>	13
<b>10.9 Steel sheet piling in bridge abutments</b>	13
<b>10.10 Integral bridge abutments</b>	14
<b>10.11 Steel sheet piles in basements</b>	14
<b>10.12 Load bearing sheet piles</b>	15

## Bearing piles and axially loaded sheet piles



# Bearing piles and axially loaded sheet piles

## 10.1 Introduction

Steel sections can be used as bearing piles where soil and ground conditions preclude the use of shallow foundations. They transmit vertical loads from the structure through the upper soft layers to ground of adequate strength for support. Steel sheet piles can be used as simple bearing piles and have the added advantage that they can be designed as a retaining wall that carries vertical loads. The main advantages that steel piles have over alternative systems are as follows:

- They are available in a wide range of profiles and section weights to allow the most economical choice of section for any particular loading condition or soil profile.
- They are well suited to use in cases where very soft clays or loose sands and gravels are present in the soil profile or when piles are being installed below the water table - conditions which can pose problems for cast in-situ systems.
- Steel piles have a very high load-carrying capacity which can be further enhanced, given suitable ground conditions, by the use of high yield strength steel. The option of using a higher grade steel is also useful when hard-driving conditions are anticipated.
- Because they are comparatively light in weight, but very robust, they require no special handling equipment for transport and they can be supplied in long lengths (up to 33m for some sections).
- The ease with which steel piles can be extended, increasing their load carrying capacity, is of great value to the designer working with a material as variable as soil. The inherent uncertainty of a calculated pile capacity is less of a problem to the designer and the effect of unforeseen ground conditions on the construction process can be reduced. For example, to maintain load capacity if weak soils are encountered, it is a simple welding operation to extend the pile or where a pile achieves the required 'set' earlier than predicted it can be shortened, with the advantage that off-cuts from piles on one part of the site can be used as extension pieces for other piles.
- Steel bearing piles are extractable at the end of the life of the structure and therefore the opportunity for either re-use or recycling exists, resulting in an economic and environmental bonus. The resulting site is enhanced in value since there are no old foundations that can obstruct or hinder future development.
- Steel bearing piles are of the low-displacement type and therefore there is no spoil to dispose of, which is of particular benefit when piles are being installed into contaminated ground.
- Steel bearing piles can be readily used as raking members in order to accommodate horizontal loads on structures such as bridge abutments.

This chapter is designed to give an overview of bearing piles and axially loaded sheet piles. Deep foundations using driven steel piles is a subject in its own right. The ArcelorMittal document 'Deep Foundations on HP piles' and the SCI publication 'Steel Bearing Piles Guide' provide in-depth guidance on the subject.

# Bearing piles and axially loaded sheet piles

Table 10.2 HP piles - characteristics

Section	Mass kg/m	Dimensions				Steel area A cm <sup>2</sup>	Total area A <sub>tot</sub> = h x b cm <sup>2</sup>	Peri- meter P m	Moment of inertia		Section modulus		HISTAR <sup>4)</sup>
		h mm	b mm	t <sub>w</sub> mm	t <sub>f</sub> mm				Axis Y cm <sup>4</sup>	Axis Z cm <sup>4</sup>	Axis Y cm <sup>3</sup>	Axis Z cm <sup>3</sup>	
HP 200 x 43	42.5	200	205	9	9	54.14	410	1.180	3888	1294	388.8	126.2	
HP 200 x 53	53.5	204	207	11.3	11.3	68.4	422.3	1.200	4977	1673	488	161.7	
HP 220 x 57 <sup>3)</sup>	57.2	210	224.5	11	11	72.9	471.5	1.265	5729	2079	545.6	185.2	
HP 260 x 75 <sup>3)</sup>	75	249	265	12	12	95.5	659.9	1.493	10650	3733	855.1	281.7	
HP 260 x 87 <sup>1) 3)</sup>	87.3	253	267	14	14	111	675.5	1.505	12590	4455	994.9	333.7	
HP 305 x 79 <sup>3)</sup>	78.4	299.3	306.4	11	11	99.9	917.1	1.780	16331	5278	1091	344.5	
HP 305 x 88 <sup>1) 3)</sup>	88	301.7	307.2	12.3	12.3	112	926.8	1.782	18420	5984	1221	388.9	
HP 305 x 95 <sup>1) 3)</sup>	94.9	303.7	308.7	13.3	13.3	121	936.6	1.788	20040	6529	1320	423	
HP 305 x 110 <sup>1) 3)</sup>	110	307.9	310.7	15.3	15.4	140	955.4	1.800	23560	7709	1531	496.2	Hi
HP 305 x 126 <sup>1) 3)</sup>	126	312.3	312.9	17.5	17.6	161	976.2	1.813	27410	9002	1755	575.4	Hi
HP 305 x 149 <sup>1)</sup>	149	318.5	316	20.6	20.7	190	1005	1.832	33070	10910	2076	690.5	Hi
HP 305 x 180	180	326.7	319.7	24.8	24.8	229	1044	1.857	40970	13550	2508	847.4	Hi
HP 305 x 186 <sup>1)</sup>	186	328.3	320.9	25.5	25.6	237	1052	1.861	42610	14140	2596	881.5	Hi
HP 305 x 223 <sup>1)</sup>	223	337.9	325.7	30.3	30.4	284	1100	1.891	52700	17580	3119	1079	Hi
HP 320 x 88 <sup>3)</sup>	88.5	303	304	12	12	113	921.1	1.752	18740	5634	1237	370.6	
HP 320 x 103	103	307	306	14	14	131	939.4	1.764	22050	6704	1437	438.2	Hi
HP 320 x 117	117	311	308	16	16	150	957.9	1.776	25480	7815	1638	507.5	Hi
HP 320 x 147	147	319	312	20	20	187	995.3	1.800	32670	10160	2048	651.3	Hi
HP 320 x 184	184	329	317	25	25	235	1043	1.830	42340	13330	2574	841.2	Hi
HP 360 x 84 <sup>3)</sup>	84.3	340	367	10	10	107	1248	2.102	23210	8243	1365	449.2	
HP 360 x 109 <sup>1) 3) 3)</sup>	109	346.4	371	12.8	12.9	139	1283	2.123	30630	10990	1769	592.3	
HP 360 x 133 <sup>1) 3)</sup>	133	352	373.8	15.6	15.7	169	1314	2.140	37980	13680	2158	731.9	Hi
HP 360 x 152 <sup>1) 3)</sup>	152	356.4	376	17.8	17.9	194	1338	2.153	43970	15880	2468	844.5	Hi
HP 360 x 174 <sup>1) 3)</sup>	174	361.5	378.5	20.3	20.4	222	1367	2.169	51010	18460	2823	975.6	Hi
HP 360 x 180	180	362.9	378.8	21.1	21.1	230	1375	2.173	53040	19140	2923	1011	Hi
HP 400 x 122 <sup>3)</sup>	122	348	390	14	14	156	1357	2.202	34770	13850	1998	710.3	
HP 400 x 140	140	352	392	16	16	179	1380	2.214	40270	16080	2288	820.2	Hi
HP 400 x 158	158	356	394	18	18	201	1403	2.226	45940	18370	2581	932.4	Hi
HP 400 x 176	176	360	396	20	20	224	1426	2.238	51770	20720	2876	1047	Hi
HP 400 x 194	194	364	398	22	22	248	1449	2.250	57760	23150	3174	1163	Hi
HP 400 x 213	213	368	400	24	24	271	1472	2.262	63920	25640	3474	1282	Hi
HP 400 x 231	231	372	402	26	26	294	1495	2.274	70260	28200	3777	1403	Hi

<sup>1)</sup> Section conforming to BS4: Part 1: 1993.

<sup>2)</sup> Sections also available according to ASTM A6-2000

<sup>3)</sup> Sections are also available in steel grade S460

<sup>4)</sup> Sections marked Hi are available in HISTAR 355 and HISTAR 460 grades (see special HP catalogue for details).

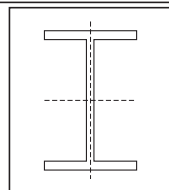

# Bearing piles and axially loaded sheet piles

## 10.2 Types of load bearing piles

Four basic types of steel bearing piles are available:-

- 1 H Piles – columns and bearing pile sections  
(see Table 10.2 for details)
- 2 Box Piles. These are formed by welding together two or more units to form a single section and are sub-divided into the following types:
  - 1 CAZ Piles
  - 2 CAU, CU, CPU-R, and CGU box piles  
(see 1.16.2 for details)
- 3 Tubular Piles.
- 4 Sheet Piles. It should be noted that as well as being widely specified for the construction of purely earth-retaining structures, sheet piling also has a capacity to carry axial load in addition to earth and water pressures and can be used to form structures such as bridge abutments or basement walls without modification. (see Chapter 1 for sizes)

Where piles are fully embedded, ie the whole length of the pile is below ground level, an H-section pile is most suitable. This situation usually occurs when piles are used to support land-sited structures such as road and railway bridges and industrial buildings.

Box piles and tubular piles are most useful when part of the pile is exposed above ground level, as in pier and jetty construction, or when hard-driving conditions are anticipated. They can also be incorporated into a plain sheet pile wall to increase its bending strength and/or its ability to support axial loads. These sections possess a comparatively uniform radius of gyration about each axis, and hence provide excellent column properties, which is a particular advantage in these situations.

---

## 10.3 Design

### 10.3.1 General

The basis of design for any bearing pile is its ultimate axial capacity in the particular soil layers in which it is founded. This can be determined by testing the pile after it has been installed or, more usually by using empirical formula at the design stage to predict the capacity from the soil properties determined during the site investigation. From this it can be seen that a good site investigation is of paramount importance to the design process.

The structural capacity of the pile itself must also be determined to ensure that it is adequate to transmit the foundation loads from the structure to be supported into the founding soil. Provided the soil is not of a very soft consistency, steel bearing piles can generally be considered as fully laterally restrained by the soil over the length of embedment. This means that, in most cases, the maximum structural capacity of the bearing pile can be used in the calculations.



## Bearing piles and axially loaded sheet piles

### 10.3.2 Determination of effective length

The structural capacity must be checked when a pile projects above the soil level for a jetty or mooring dolphin. In this case the above ground section must be designed as a free-standing column. The effective length of the column ( $L$ ) for the determination of its slenderness ratio is dependent on the type of ground at the surface. Where soft soils are encountered ' $L$ ' should be taken as the distance between the point of connection with the deck (or bracing) and a point at half the depth of the soft strata or 3m below ground, whichever is the lesser. Where firm soils occur immediately below bed level, ' $L$ ' is the distance between the point of connection with the deck (or bracing) and a point located at bed level.

Hence, if the top of the pile is fixed in position in the orientation being considered but is not effectively fixed in direction, the effective length is ' $L$ '. If however, the pile is also fixed in direction the effective length should be taken as  $0.75 \times L$ .

For partial fixity in this situation the effective length should be taken as  $1.5 \times L$ .

When the top of the pile is neither fixed in position nor in direction in the orientation being examined, the effective length is  $2 \times L$ .

Very soft strata such as liquid mud should be treated as water for design purposes.

---

### 10.3.3 Vertical Load Capacity

The ultimate load carrying capacity of a pile in the ground can be assessed by calculation using a variety of different methods. Possibly the most suitable for driven piles in general is that based on CPT (Cone Penetration Test) results but it is less reliable in compact gravels, marls and other hard soils.

The designer is aiming to use the available soil test data to establish acceptable values for the skin friction and end bearing resistances that can be generated.

The following method of analysis, based on SPT test results, has been in use for many years

#### **Granular soil (SPT Method from Meyerhof)**

The ultimate capacity of a bearing pile in granular soil can be determined from the SPT values obtained from site investigation boreholes using the following formulae

Ultimate Capacity  $Q_{Ult} = Q_s + Q_b$ .

Ultimate Shaft Resistance  $Q_s = 2N_s A_s$  (kN)

Ultimate Base Resistance  $Q_b = 400N_b A_b$  (kN)

Where  $N_s$  is the average dynamic SPT resistance over the embedded length of the pile (blows/300mm)

$A_s$  is the embedded area of the shaft of the pile in contact with the soil ( $m^2$ ).

## Bearing piles and axially loaded sheet piles

$N_b$  is the dynamic SPT resistance at the predicted base of the pile which is calculated using the following equation

$$N_b = 0.5(N_1 + N_2)$$

where  $N_1$  is the smallest of the  $N$  values over two effective diameters below toe level

and  $N_2$  is the average  $N$  value over 10 effective diameters below the pile toe.

$A_b$  is the area of the base of the pile ( $m^2$ ).

For submerged sands, the  $N$  value needs to be reduced ( $N_{red}$ ) using the following relationship

$$N_{red} = 15 + 0.5(N - 15) \text{ for values of } N \text{ which exceed } 15.$$

### Cohesive Soils

The ultimate capacity of a bearing pile in cohesive soils is a function of the undrained shear strength of the soil and its area in contact with the pile.

$$\text{Ultimate Capacity } Q_{Ult} = Q_s + Q_b$$

$$\text{Ultimate Shaft Resistance } Q_s = \alpha S_u A_s \text{ (kN)}$$

$$\text{Ultimate Base Resistance } Q_b = 9 S_u A_b \text{ (kN)}$$

### Where

$\alpha$  is the pile wall adhesion factor (or soil shear strength modification factor) for each soil layer

$S_u$  is the average undrained shear strength of the layer being considered.

Values used for  $\alpha$  under static load will diminish with increasing undrained cohesion but generally lie between 0.5 and 1.0. This is shown in Fig 10.3.3.1.

When calculating the values for  $A_s$  and  $A_b$  the possibility that 'plugging' may occur must be considered. This is the situation where the soil does not shear at the pile/soil interface but away from the pile and a plug of soil forms at the base which is drawn down with the pile as it is driven. The various conditions are shown in Fig 10.3.3.2.

It is recommended that the shaft friction area ( $A_s$ ) is calculated assuming that no plug forms but when assessing the end bearing area ( $A_b$ ), full plugging is assumed but a reduction factor of 0.5 for clay soils and 0.75 for sands is then introduced.

# Bearing piles and axially loaded sheet piles

Fig 10.3.3.1

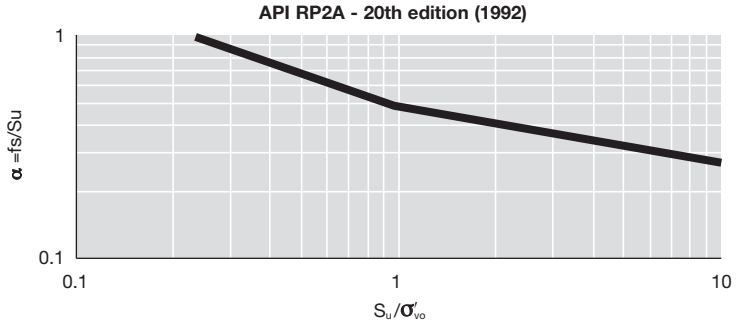
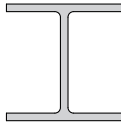
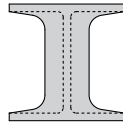

Fig 10.3.3.2 H pile end bearing and skin friction areas

End Bearing areas



No plug



Partial plug

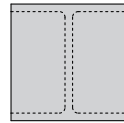

Full plug

Corresponding skin friction area

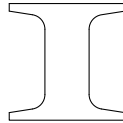
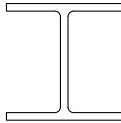

# Bearing piles and axially loaded sheet piles

## Pile capacity from end bearing

When rock or another suitably competent layer exists, steel piles can transmit the loads from the structure to the foundation in end bearing alone.

The table below gives the ultimate axial load capacity for the common bearing pile sizes based on the yield stress applicable to a given steel thickness.

The values are applicable to piles founded in:

- 1 Hard and medium rock or equivalent, strata such as extremely dense or partially cemented sands or gravels.
- 2 Soft rocks, dense sands and gravels or extremely hard clays, hardpan and similar soils.

In the second case, the piles will act in a combination of end bearing and friction in the founding stratum and the required penetration will be greater than that for the first case where penetration is dependent on the hardness of the rock and on the degree of weathering of its upper surface.

It should however be noted that traditional load capacity tables were based on a working stress of 30% of the yield strength of the steel to give a factor of safety of 2 on the load and some additional capacity to prevent damage should the driving stresses increase. When driving piles through relatively soft soils onto rock, a working stress of 50% of the yield strength of the steel could be adopted giving a factor of safety of 2 on the applied loading. The tabulated values below need to be factored to give comparable load capacities for the various pile sections.

The ability of the rock on which the pile is founded to withstand the foundation loads must be determined by establishing the compressive strength of the strata (MPa) from site investigation.

## Bearing piles and axially loaded sheet piles

Table 10.3.3a H piles ultimate load capacity

Serial size	Mass kg/m	Section area cm <sup>2</sup>	Ultimate load capacity		
			Steel grade		
			S235 kN	S275 kN	S355 kN
HP200	43	54.1	1272	1489	1922
HP200	53	68.4	1607	1881	2428
HP220	57.2	72.9	1712	2003	2586
HP260	75	95.5	2245	2627	3392
HP260	87.3	111	2609	3053	3941
HP305	79	99.9	2348	2747	3546
HP305	88	112	2632	3080	3976
HP305	95	121	2844	3328	4296
HP305	110	140	3290	3850	4970
HP305	126	161	3623	4267	5555
HP305	149	190	4275	5035	6555
HP305	180	229	5153	6069	7901
HP305	186	237	5333	6281	8177
HP305	223	284	6390	7526	9798
HP320	88.5	113	2656	3108	4012
HP320	103	131	3079	3603	4651
HP320	117	150	3525	4125	5325
HP320	147	187	4208	4956	6452
HP320	184	235	5288	6228	8108
HP360	84.3	107	2515	2943	3799
HP360	109	139	3267	3823	4935
HP360	133	169	3972	4648	6000
HP360	152	194	4365	5141	6693
HP360	174	222	4995	5883	7659
HP360	180	230	5175	6095	7935
HP400	122	156	3666	4290	5538
HP400	140	179	4207	4923	6355
HP400	158	201	4523	5327	6935
HP400	176	224	5040	5936	7728
HP400	194	248	5580	6572	8556
HP400	213	271	6098	7182	9350
HP400	231	294	6615	7791	10143

## Bearing piles and axially loaded sheet piles

The following table give examples of the compressive strength of rocks found close to the Earth's surface in which piles may be founded.

Table 10.3.3b Compressive strength

Rock type		Compression strength MPa			
		100	200	300	400
Hard	Leptite				○
	Diabase			○	
	Basalt			○	
	Granite		○		
	Syenite	○			
	Quartz porphyry		○		
	Diorite, gabbro		○		
	Quartzite		○		
	Quartzitic phyllite		○		
Weak	Metamorphic phyllite	○			
	Layered phyllite	○			
	Hornblende		○		
	Chalkstone		○		
	Marble		○		
	Dolerite		○		
	Oil shale		○		
	Mica shist		○		
	Sandstone		○		
	Lava		○		

- Variation about mean
- Cylinder sample H = D
- Cylinder sample H = 2D
- Cube test

### 10.3.4 Piles subjected to tensile forces

Bearing Piles manufactured in steel have the advantage of being able to withstand high tensile loadings, which makes them ideal for resisting uplift forces. This tensile capacity also makes them extractable without the need for special and expensive techniques.

Table 10.3.3a gives the ultimate tensile capacity for each pile section.

The tensile resistance of the soil/pile interface is calculated from the skin friction on the pile shaft only.

Testing of tension piles to establish the tension load is a relatively simple process of applying a load using a hydraulic ram founded on the ground.

## Bearing piles and axially loaded sheet piles

**10.3.5 Lateral loads** Lateral loads on piles vary in their importance from the major load in such structures as transmission towers or mooring dolphins to the relatively insignificant loads on low rise buildings.

For further information refer to SCI document 'Steel Bearing Piles Guide, Chapter 5 Lateral Load resistance.'

---

**10.3.6 Pile groups** Where piles are installed in groups to support a structure, the performance of the group is dependant upon the layout of the piles and may not equate to the sum of the theoretical performance of individual piles in the group.

A general rule is that the centre to centre spacing of the pile should not be less than 4 times the maximum lateral dimension of the pile section. However a check of the settlement of the overall group should be made.

See SCI document ' Steel Bearing Piles Guide chapter 6 Pile group effect'.

---

### 10.3.7 Negative skin friction

This phenomenon can occur when piles are driven through soft compressible soils which are subjected to an external load such as a surcharge. Squashing a compressible layer will apply a downward force to the pile through skin friction, which counteracts the load bearing capacity of the layer in question.

If this phenomenon is likely to occur it should be included in the design calculations. The load bearing capacity of the pile can be reduced to take into account the negative skin friction or a slip coating can be applied to the length of the pile in the soft zone to prevent the negative load affecting the pile.

---

### 10.3.8 Set up

The properties of the soil immediately adjacent to a driven pile are changed by the process of forcing the pile into the ground, giving rise to a phenomenon called set up.

Set up is the time interval during which the soil recovers its properties after the driving process has ceased. In other words the load capacity of an individual pile will increase with time after the pile has been driven. In granular soils this can be almost immediate but in clays this can take days, or months for some high plasticity clays.

In granular soils this change can be in the form of liquefaction caused by a local increase in pore water pressure due to the displacement by the pile. In clays it can be due to the remoulding of the clay in association with changes in pore water pressures.

## Bearing piles and axially loaded sheet piles

The load capacity of the piles should be verified by testing and if sufficient time for set up to occur is not available before the pile is loaded then its effects should be taken into account in the design. The important point to remember is that in clay soils the capacity of the piles will tend to improve over time.

---

### 10.4 Testing the load capacity of steel bearing piles

There are four categories of tests that are commonly used to determine the load capacity of steel bearing piles.

#### 1 Maintained Load Test and 2 Constant Rate of penetration test

Both these tests use similar apparatus and in both cases the test load is applied by hydraulic jack(s) with kentledge or tension piles/soil anchors providing a reaction.

Modern Pile pressing systems provide this information as part of the installation process. The amount of force required to install the pile can be used to gauge the likely capacity of the pile.

In the Maintained Load Test, the load is increased incrementally, and is held at each level of loading until all settlement has either ceased or does not exceed a specified amount in a stated period of time. In the Constant Rate of Penetration Test, the load is increased continuously at a rate such that the settlement of the pile head occurs at a constant rate. A rate of 0.75mm/min is suitable for friction piles in clay, whilst for end-bearing piles in sand or gravel a penetration rate of 1.5mm/min may be used. The amount of kentledge or tension resistance should always be in excess of the estimated pile resistance and if kentledge is used, its support system and 'foundations' should be carefully considered well in advance of the test.

It is desirable to carry out test loading of steel bearing piles to failure/ultimate load to determine whether the factor of safety or penetration is approximately correct and this can generally be done without affecting the subsequent load carrying capacity of the pile.

The ultimate bearing capacity of the pile is commonly defined as the load at which the total head settlement is 10% of the pile width or the load at which the net residual head settlement, after removal of all load, is equal to a specified amount eg 8mm



## Bearing piles and axially loaded sheet piles

### 3 Dynamic Testing

The test pile is instrumented with strain transducers and accelerometers and is struck with the piling hammer. The force and velocity data are recorded and analysed. Using this data, methods are available that give an on-site estimate of the pile bearing capacity, although more rigorous and detailed analysis of the recorded data can be performed using a computer program such as the Case Pile Wave Analysis Program (CAPWAP). Using the program, an engineer can determine the pile bearing capacity, in terms of shaft resistance and toe resistance and the distribution of resistance over the pile shaft. A load-settlement curve is calculated and is similar in form to traditional static load tests. It is advisable to correlate the results of dynamic pile tests with those of at least one maintained load test.

### 4 Pile Driving Formulae

This approach, eg the Hiley formula, relates the measured permanent displacement of the pile at each blow of the hammer to the dynamic capacity of the pile, from which the static capacity can be obtained by the application of a factor of safety, normally 2.0. It should be noted that a dynamic formula should be applied only to piles founded in hard or soft rocks, sands and gravels or extremely hard clays and that it is then applicable only if a satisfactory re-drive check is obtained, ie the immediate set per blow on re-driving the pile after an interval of several hours should be either equal to, or less than, the previous final set per blow.

---

## 10.5 Welding of steel piles

Two main types of weld are used in steel piling:

- 1 Primary welds, used to form tubular or box piles and fabricate corners, junctions etc in sheet piles.
- 2 Splice Welds to connect an extra length to a pile, either before or after an initial installation to increase the overall pile length.

Until relatively recently there has been no generally agreed Standard or Code of Practice stipulating the weld quality level to be used for this type of work which has resulted in specifications being written to an excessively high standard. Over specification leads to higher labour and welding consumable costs, increased Non-Destructive Testing costs, high rectification costs and consequent delays to the overall construction programme.

## Bearing piles and axially loaded sheet piles

### 10.6 Installation of bearing piles

Until recent times the installation of bearing piles was limited to Impact and Vibro driving methods (see Installation Chapter). The recent development of a hydraulic pile press for bearing applications has meant that there is now a very low noise and vibration free method for installing bearing piles in urban areas. Large capacity bearing piles can be created using sheet piles and Omega sections to form a circle involving 4 to 8 piles. Installation of a bearing pile formed in this way is most easily achieved by leader rig. Driving may therefore be by vibrodriver or pile press. The leader rig mounted pile press system has a number of hydraulic rams which clamp to each pile in the group. The piles are installed by pressing one pile while reacting against the others in the group to advance the piles in a series of increments (see Section 11.3.25 for more information).

---

### 10.7 Driving shoes

Where piles are end bearing onto rock and the rock surface is not horizontal a rock shoe can be used to seat the pile on the rock.

Other types of shoe can be used to strengthen the tip of the pile to allow the pile to break through debris, scree, boulders and weathered rock surfaces without damage.

It is also possible to profile the end of the section prior to driving.

---

### 10.8 Axially loaded sheet piles

The use of sheet piles in this handbook has focused, up to now on purely retaining structures. However, the ability of sheet piles to carry vertical loads in addition to predominantly horizontal loads from the retained soil has been known about since their introduction at the start of the 20th century. Over that time, this ability has been put to good use in maritime structures where quay walls need to support cranes on the sheet piles in addition to the surcharges imposed on the ground behind the wall.

This ability to carry these combined loads is particularly relevant to land sited structures such as bridge abutments and basements below multi-storey buildings.

Point loads from columns can be transferred into the sheet piles by use of a suitably designed capping beam.

---

### 10.9 Steel sheet piling in bridge abutments.

Steel sheet piles can be used to form the abutments of bridges in one of two ways.

- 1 By using a line of sheet piles as the bearing structure and landing the bridge beams directly onto the sheet pile capping beam. In this situation the length of the bridge deck is minimised. In this instance, the term sheet piles includes standard rolled sections, box piles and high modulus piles.

## Bearing piles and axially loaded sheet piles

- 2 By forming a box using driven sheet piles which have an upstand equal to the required height of the abutment. The upstand is filled with a suitable fill material onto which the landing for the bridge beams is formed. This method not only uses the bearing capacity of the sheet piles, but mobilises the contained soil as a foundation support, distributing the load over a much larger plan area, reducing the soil stresses and hence settlement.



---

### 10.10 Integral bridge abutments

Steel piles, either in the form of sheet piles in an abutment wall or as a group of bearing piles supporting a conventional abutment, are of particular use in integral bridge abutments. The flexible nature of steel allows the abutments to move in response to the lateral loads which are transmitted to the abutment from the bridge beams due to thermal expansion, but remain robust enough to cope with the vertical loads and such lateral loads as braking forces and impacts.

---

### 10.11 Steel sheet piles in basements

Sheet piles are useful for the construction of basement walls in buildings on restricted redevelopment sites. The narrow profile of the finished wall together with equipment that allows installation right up to the site boundary means that the usable space in the basement is maximised.

The foundation loads from the perimeter of the building frame can be applied directly to the sheet piling. The point loads from the building frame can be distributed to the entire sheet pile wall by means of a capping beam and these loads are then shed to the founding soil over the entire length of the basement perimeter. If a

## Bearing piles and axially loaded sheet piles

steel frame is being used for the building the anchor bolts for the columns can be cast into the R/C capping beam in readiness for the frame erection. A major advantage from this form of construction is the potential for saving time on site as, once installed, the steel piles can be loaded immediately.

This method reduces construction time when compared to more traditional ones. The installed piles, when painted, give an appropriate finish for basement car parks and various cost effective cladding systems are available for habitable basements.

For further details the SCI publish a design Guide 'Steel Intensive Basements'.

---

### 10.12 Load bearing sheet piles

As the sheet piles will be designed for ultimate conditions and will use all the friction available in the resistance of horizontal forces, axial loads in sheet piles will have to be carried by an additional length of pile beneath that needed for horizontal stability.

In addition to ascertaining the length of pile needed to support the applied loads using one of the empirical methods mentioned earlier in this chapter, it will be necessary to check that the combination of bending and axial loads does not overstress the pile section. This structural check should be carried out using the appropriate national standard.



ArcelorMittal

- 1** Product information
- 2** Sealants
- 3** Durability
- 4** Earth and water pressure
- 5** Design of sheet pile structures
- 6** Retaining walls
- 7** Cofferdams
- 8** Charts for retaining walls
- 9** Circular cell construction design & installation
- 10** Bearing piles and axially loaded sheet piles
- 11** Installation of sheet piles
- 12** Noise and vibration from piling operations
- 13** Useful information

# Installation of sheet piles

<b>Contents</b>	<b>Page</b>
11.1 Introduction	1
11.2 Driving methods	1
11.3 Driving systems & types of hammer	5
11.4 The soil	19
11.5 Choice of sheet pile section for driving	23
11.6 Resistance to driving	28
11.7 Guiding the piles & controlling alignment	37
11.8 Handling, sorting & lifting piles on site	40
11.9 Pitching	43
11.10 Threading devices	43
11.11 Driving assistance	44
11.12 Blasting	46
11.13 Driving corrections	47
11.14 Special aspects of installation	50
11.15 Extracting	51
11.16 Installing combined HZ or high modulus walls	52

## Installation of sheet piles



# Installation of sheet piles

## 11.1 Introduction

This chapter provides an introduction to the modern methods of installing sheet piling taking into account the equipment available for safe working practice.

A knowledge of the characteristics of the steel and the section are not enough to guarantee good results prior to installation and this chapter briefly describes the practical information to be considered to ensure proper product installation. It also indicates how pile driveability can be predicted following a thorough evaluation of the ground conditions.

This chapter also contains information on pile driving equipment which is current at the time of writing and includes impact hammers, vibratory pile drivers, hydraulic pressing and special systems. Brief descriptions of driving methods, ancillary equipment and guideline procedures to assist in the adoption of good practice when installing sheet piles are also included.

Finally some common installation problems are illustrated and special aspects of driving briefly outlined.

---

## 11.2 Driving methods

### 11.2.1 General

Whilst it is recognised that, in common with most civil engineering projects, a measure of flexibility is desirable to meet site conditions, every precaution must be taken to maintain the necessary standards of safety whilst giving the required alignment and verticality of the installed piles.

Therefore principal consideration must be given to access of plant and labour and working positions for handling the piles and threading the sheets together. The length of the piles and height from which they can be pitched and driven safely and accurately is also important

Whenever possible sheet piles should be driven in pairs. The first sheet piles in a wall must be installed with great care and attention to ensure verticality in both planes of the wall. Control of the sheet pile installation must be maintained during both the pitching and driving phases of the installation process.

There are two principal pile driving methods available to installers, pitch and drive and panel driving. The features, advantages and disadvantages of each method are described below.

---

### 11.2.2 Pitch and drive method

This method requires equipment to control the verticality of the pile during installation so that piles can be pitched and driven one by one. The pitching operation can be carried out close to ground level meaning that operatives are potentially at less risk and downtime in windy conditions can be reduced.

Piles can be installed to final level by this method (necessary when using the Japanese presses with single piles) or left at a higher level



## Installation of sheet piles

to backdrive using panel driving techniques with other, generally heavier, hammers to speed up production or drive accurately in deeper more difficult strata.

This method is the simplest way of driving piles but is only really suited to loose soils and short piles. For dense sands and stiff cohesive soils or in the case of possible obstructions, pitch and drive is not recommended.

In recent years, the method has become more favoured by installers as purpose built equipment is now available to adequately control the pile during installation. In the right conditions, productivity is maximised.

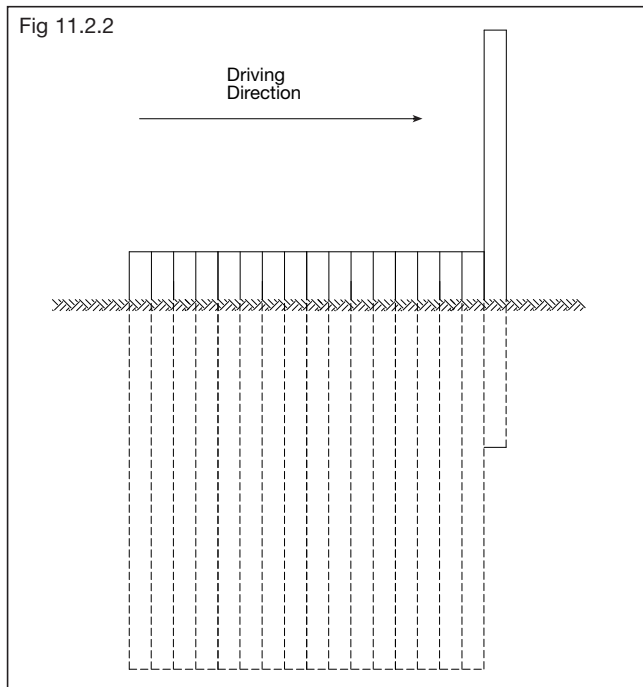

It is more difficult to control forward lean using the pitch and drive method because the leading lock has less resistance than the trailing or connected lock as a result of soil and interlock friction. Although the piling may commence from a true vertical position, the top of the piles will have a natural tendency to lean in the direction of driving. This will get progressively worse if not countered. When driving long straight sections of wall with a planned pitch & drive method it may be advisable, with the Engineers consent, to allow for supplying pre-fabricated tapered correction piles for use at approximately fifty metre intervals. This

## Installation of sheet piles

is important to consider when using the Japanese pressing machines because it may not be possible to revert to a panel backdriving system to avoid or correct the forward lean problem.

With pitch and drive, the free leading interlock is constantly in danger of rotation in plan which increases the deeper the free end penetrates the ground as it is unsupported during the driving operation. When a pile rotates during installation, friction develops in the connected locks making driving progressively more difficult.

---

### 11.2.3 Panel driving

Piles may be threaded together above the ground in a support frame to form a panel prior to driving. In this situation, both interlocks are engaged before any driving takes place and this balancing of the friction forces ensures maximum control and accuracy. The piles are then driven in stages and in sequence into the ground. Sequential driving enables verticality to be maintained.

Sheet piles should be installed using the panel-driving technique to ensure that good verticality and alignment is achieved and to minimise the risk of driving difficulties or declutching problems.

This technique is important for maintaining accuracy when driving long piles or driving into difficult ground

As a whole panel of piles has been pitched there is no need to drive all piles fully to maintain progress of the piling operations. During driving, the tops of adjacent piles can be kept close together meaning that the stiffness of the piles is maintained across both connected locks allowing the pile toe to be driven through soil of greater resistance without undue deviation.

If obstructions are encountered, individual piles can be left high without fear of disruption to the overall efficiency of the installation process. Engineering decisions can then be taken to attempt to remove the obstruction or drive piles carefully either side of the obstruction before trying once more to drive or punch through it if further penetration is necessary.

Panel driving is the best method for driving sheet piles in difficult ground or for penetrating rock - which is unlikely to be possible with the pitch and drive method. Piles are usually paired up or neighbouring sheets levelled up at the head before commencing the hard driving operation with a heavier hammer. Care should be taken when piles are firstly pitched and installed in singles and driven in the first stage with a vibrohammer. It is easier to execute two stage driving in pairs if the piles are pre-ordered and installed in crimped pairs. Difficulty of pairing up in the panel is avoided in this way and safer more efficient operation of impact hammers can be ensured.

# Installation of sheet piles

Fig 11.2.3

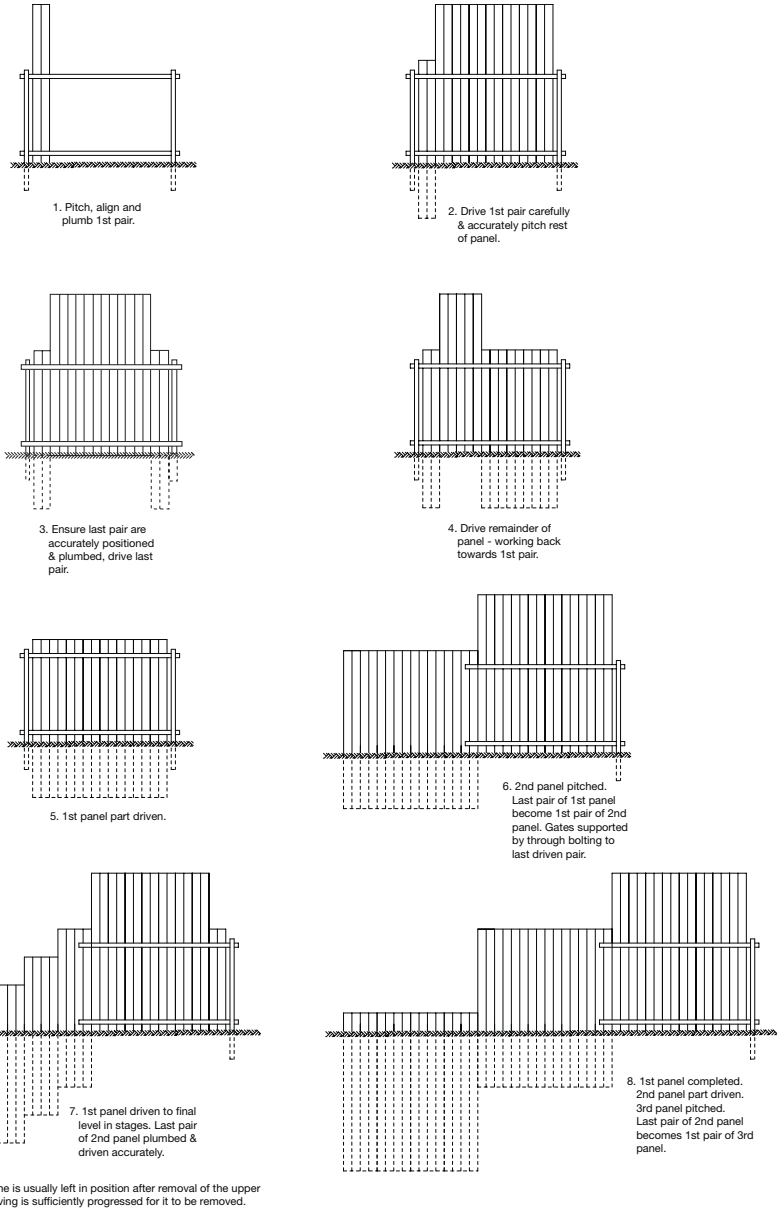

# Installation of sheet piles

## 11.2.4 Staggered driving

It is essential that the heads of adjacent piles or pairs are kept close together to maximise the pile performance when driving in hard conditions. This means that the installer should keep moving the hammer from one pile to another in sequence to advance the toe of the piling with less risk of damage or refusal. This technique is known as staggered driving. It is not recommended that piles are advanced more than 2 metres beyond neighbouring piles unless driving conditions are relatively easy for the pile section and equipment used.

---

## 11.2.5 Cofferdam and closure installation techniques

When installing cofferdams or high modulus walls, accuracy is essential – particularly where it is necessary to pitch a pile of significant length into both adjacent pile interlocks to close a gap. If the gap tapers it will be very difficult to interlock and drive the closure pile successfully. Therefore the panel driving method is the favoured method for installing structures of this type.

CIRIA SP95 gives sound guidance on what needs to be considered when installing sheet piles for cofferdams and dealing with the issues that need to be addressed to be able to carry out other operations in the dry. With any sheet pile project, the risk of declutching should be minimised especially when men are required to work in dewatered cofferdams.

When joining walls or closing to fixed positions, panel installation methods are obligatory to maintain safe working conditions. It is necessary to avoid the risks and potential disaster caused by declutched or damaged piles when planning, designing and executing the works.

The panel driving technique is also best for the control of wall length and creep by using appropriate guide walings. This may be important when dimensions are critical. Curved walls can also be set out using this method with curved walings to suit.

---

## 11.3 Driving systems and types of hammer

The choice of a suitable driving system is of fundamental importance to ensure successful pile installation with due regard to the safety of operatives and environmental disturbance.

The three basic driving methods are:

## Installation of sheet piles

### Impact driving

This is the best method for driving piles into difficult ground or final driving of piles to level in panel form. With a correctly selected and sized hammer it is the most effective way of completing deep penetration into hard soils in most conditions. The downside is that it can be noisy and not suitable for sensitive or restricted sites

### Vibrodriving

This is usually the fastest and most economical method of pile installation but usually needs loose or cohesionless soil conditions for best results. Vibration and noise occurs but this can be kept to a minimum provided the right equipment is used and the site is not too sensitive

### Pressing

Otherwise known as silent vibrationless hydraulic jacking. Machines of various types are now widely used. This method is very effective in clay soils but less so in dense cohesionless ground unless pre-augering or jetting techniques are used. This is the most effective method to use when installing sheet piles in sensitive locations where piling would have not been considered in the past.

---

### 11.3.1 Mixed driving methods

Specialist plant and equipment is now available that may combine methods such as pressing and vibrodriving by use of a telescopic leader rig fitted with a high frequency vibrodriver. The pressing, which in this case is carried out by lowering the mast of the rig using hydraulic rams, is known as 'crowding' and is normally limited to a force of 15 to 30 tonnes

---

### 11.3.2 Impact hammers

There are several types of impact hammer available to suit the particular requirements of a site. Most impact hammers will involve a piston or ram and an anvil block with a driving cap which spreads the blow to the pile head. The machines are usually supported by a heavy frame or chassis and normally need leg guides set up to fit snugly to the pile section being driven to maintain a vertical position during operation. Alternatively the hammers can be set up to be supported and aligned by a leader rig. It is very important that, because of the height and slenderness of these types of hammer, the hammer is prevented from rocking or swaying when delivering powerful blows to the piles.

## Installation of sheet piles

The principle differences between hammers are the size and mechanism for delivering the blow from the ram. Some hammers deliver the blow freely under gravity, others are able to accelerate the fall of the ram and are described as double acting. In all cases the effectiveness of driving will depend on the power and efficiency of the blow.

Modern hammers are in widespread supply and, provided they are adequately maintained, can be expected to totally outperform the older types of pile hammer. Therefore the impact hammer types described below are those that are most commonly in use. Descriptions and detail of older types such as diesel hammers can be found in previously published installation guides. Hydraulic hammers totally outperform diesel hammers in terms of efficiency, are more environmentally acceptable, and are less likely to damage the head of the pile when transmitting the driving force.

---

### 11.3.3 Transmitting the blow to the pile

Any pile section can be set up to be driven with a suitable impact hammer. However it is not only important to size the hammer correctly but it is imperative that the driving cap and / or anvil plate fits well and is correctly sized to suit the pile section being driven - especially on wide piles or pairs of piles. The hammers should not be used to drive piles of different widths without changing the fittings. The central axis of the ram should always align with the centre of the driven pile section in plan and the blow spread evenly over the full cross sectional area of the pile.

---

### 11.3.4 Refusal criteria – hard driving

It is crucial to set refusal criteria for hard driving with impact hammers. A penetration of 25 mm per 10 blows should be considered as the limit for the use of all impact hammers in accordance with the hammer manufacturer's recommendations.

Under certain circumstances a penetration of 1 mm per blow could be allowed for a few minutes. Longer periods of time at this blow rate will cause damage to the hammer and ancillary equipment and may also result in damage to the pile head.

---

### 11.3.5 Hydraulic single acting hammers

These hammers are suitable for driving pairs of Z or U-piles in all ground conditions. They are usually too wide to fit on single piles. As the hammers can be adapted with heavy block ram weights they are particularly suitable for prolonged driving into thick clay strata.

This type of hammer consists of a segmental ram guided by two external supports; the ram is lifted by hydraulic pressure to a pre-

## Installation of sheet piles

set height and allowed to free-fall onto the anvil or driving cap. The weight and the height of drop of the ram can be varied to suit the pile section and the site conditions

Ram weights are usually set up in 3, 5, 7 or 9 tonne modes although some up to 14 tonnes are available to suit driving of HZ, high modulus and box pile sections. The drop height is variable up to approximately 1.2 metres. At maximum ram weight and stroke height a blow rate of 40 blows/minute can be achieved when used in automatic sequence.

For driving in stiff clays it is always preferable to use a heavy ram, with short stroke to minimise pile head damage and noise emission levels.

The hammer controls are precise, and used correctly this type of hammer can achieve 75-90% of rated output energy.

---

### 11.3.6 Hydraulic double-acting hammers

These hammers can be used on single or pairs of piles. They are particularly suited to drive U-piles or heavy Z piles with reinforced shoulders in hard driving situations and with rapid blow action can be used effectively to penetrate very dense sands gravels and rock

This type of hammer consists of an enclosed ram which is lifted by hydraulic pressure. On the downward stroke, additional energy is delivered to the ram, producing acceleration above that from gravity alone and powerful blows to strike the anvil or driving cap which is purpose built to fit the pile section.

When set up for use with sheet piles, these hammers will deliver a maximum energy/blow of 15 kNm to 90kNm with a blow rate up to 150 per minute. The electronic control system ensures optimum control of the piling process.

The ram weight of the machines suitable for standard sheet pile sections range from 1.2t to 6.5t

Bigger machines are available for driving large non-standard pile sections and HZ piles for high modulus systems and offshore projects. The total weight of the hammer ranges from approximately 2.5t to 20t.

The machines are usually rope suspended from a crane and because even the lighter machines are very powerful, effective driving systems are available at significant reach using large crawler cranes.

Under normal site conditions it is usual to select a ram weight that is in the range 0.75 to 2 times the weight of the pile plus the driving cap.



## Installation of sheet piles

### 11.3.7 Control and settings

These hammers can usually be operated on different settings to suit the pile and ground conditions. For instance a heavy ram weight ratio hammer on wide piles can be used with a low setting to suit driving in clay and smaller hammers on a rapid blow setting can be used to drive single piles in dense sandy soils. Equipment to provide digital readout of energy and blow count, for driving records and control, is available to be fitted to most machines.

---

### 11.3.8 Impact hammers and driving stresses

The driving stresses in the pile, when using impact hammers, are likely to be greatest at the head of the pile. This is known as the peak head stress value ( $\sigma_p$ ). The mean driving stress ( $\sigma_m$ ) is estimated by dividing the driving resistance (soil resistance + friction) by the cross-sectional area of the pile.

The peak driving stress can be estimated using the following formula:-

$$\sigma_p = \sigma_m \cdot \left[ \left( \frac{2}{\sqrt{\xi}} \right) - 1 \right]$$

where  $\xi$  represents the efficiency of the blow from the piling hammer (e.g. 1 = 100% efficiency, 0.75 = 75% efficiency, etc).

Where the impact hammer has a low efficiency (for instance, diesel hammers may rate at 30%-40% efficiency) then the yield stress of the steel section may be exceeded by the peak driving stress causing buckling at the pile head.

Also note that for highly efficient hydraulic hammers which usually operate at 85 to 95% efficiency, the hammer energy may be transmitted effectively to the toe of the pile. It is therefore important that the pile continues to penetrate the ground when driving for a sustained period because toe damage can occur when the penetration rate is low or refusal sets are exceeded.

---

### 11.3.9 Vibratory pile drivers

These hammers are usually the quickest and most effective equipment for driving piles in loose to medium dense cohesionless soils. They are particularly useful for extracting piles or withdrawing the pile being driven in order to take corrective action.

---

### 11.3.10 Mechanism and use

Vibratory driving works by reducing the friction between the pile and the soil. The vibrations imparted to the pile temporarily disturb the surrounding soil causing minor liquefaction, which results in a



## Installation of sheet piles

noticeable decrease in resistance to movement of the pile through the soil. This enables the pile to be driven into the ground with very little added load, ie. its own weight plus the weight of the driver or additional crowd force if the vibrodriver is used with a leader rig.

For rope suspended operations, crawler cranes are usually used. Telescopic mobile cranes are not recommended for use with vibratory pile drivers.



The typical vibratory driver generates oscillations inside a vibration case in which eccentric weights are gear-driven by one or more motors. The weights turn at the same speed but in opposite directions resulting in purely vertical oscillations as the horizontal components of the forces cancel each other out. Vibratory drivers can be powered by electric or hydraulic motors - or a combination of both - , the input energy being provided by a silenced power pack.

Hydraulically operated clamps mounted under the vibration case ensure a secure attachment and transmit the oscillating movements to the pile. The crane or leader rig suspending the vibratory driver must be isolated from the vibration case by rubber cushions or spring elements. The variable speed features of hydraulic vibrators enable the frequency of the system to be matched to varying soil conditions.

---

### 11.3.12 Use as an extractor

The vibratory pile driver is also a very efficient pile extractor if the weights are rotated in the reverse direction. The extraction force applied to the sheet pile will depend on the size of the vibrator and the pulling force that can be applied to the pile from a safe stable position. This force will be a function of the capacity of the crane or rig and the distance it is located from the pile line.

# Installation of sheet piles

## 11.3.13 Types of vibratory hammer

Vibratory hammers are available in a wide range of sizes and also operate in different frequency modes. The standard machines usually operate at a frequency between 800 to 1800 RPM. The power available is described by the centrifugal force of the hammer which ranges from 400 to 1400 kN for telescopic rig mounted units up to 5360 kN for fixed leader or rope suspended models.

Higher frequency drivers are also available extending the range up to 3000 RPM. The high vibrations developed attenuate very rapidly limiting any problems to adjacent properties. The Variable (Resonance free) High frequency machines allow the frequency and power to be adjusted at start up and shut down to eliminate resonance and the generation of unwanted vibrations through the upper strata on sensitive sites and close to buildings.

---

## 11.3.14 Ground conditions and use of vibrodrivers

The soils best suited to vibration work are non-cohesive soils, gravel or sand, especially when they are water-saturated and provided the soil is not too dense. If SPT's over 50 prevail then driving will be difficult. Machines operating at higher amplitudes are normally more effective in difficult soils. With mixed or cohesive soils, vibro-drivers can also be very effective where there is a high water content and the ground is loose or soft.

Clay soils have a damping effect and reduce the energy available for driving the pile. Vibratory driving is difficult where firm or stiff clay soils are encountered but once again a high amplitude is likely to give the best results.

---

## 11.3.15 Gripping the pile

All pile sections can be driven with vibrohammers but attention should be given to the area where the machine jaws grip the top of the pile. For example, the thick part of the pan on U type piles is most suited for this when driving or extracting piles singly. If the jaws need to be attached to the web of a pile section – for instance on Z-piles – care should be taken to avoid ripping the steel especially during extraction. Tearing can be a particular problem with wide piles if the vibrodriver is equipped with small size grips and attaches to the pile at handling hole level. Multiple clamps are available and it is recommended that they are used on paired sections especially when driving wide piles. A correctly fitting clamp should have grips in good condition – particularly when it is being used for extraction - and recesses to accommodate the pile interlock if used in the centre of paired units.

## Installation of sheet piles

---

### 11.3.16 Refusal criteria, limitations and hard driving

Formulae to determine the size of vibratory driver needed for a given set of conditions vary from manufacturer to manufacturer and readers should obtain guidance from their plant hire company on this topic if in doubt. Vibrators are also used for installing bearing piles and high modulus or HZ king piles. Note that performance on sheet piles and isolated piles is different and care should be taken not to undersize the hammer or overdrive the pile.

It is essential that movement is maintained when driving or extracting piles with vibratory hammers and it is generally recognised that a penetration rate of approximately 50 cm per minute be used as a limit. This not only acts as a control on possible vibration nuisance but also as a precaution against the detrimental effects of overdriving.

When refusal occurs and the pile ceases to move, the energy being input by the vibrodriver will be converted into heat through friction in the interlocks of the pile being driven. The steel can sometimes melt and damage the interlocks themselves, any sealants being used and also the hammer if prolonged driving in refusal conditions takes place.

Performance may be improved by using water jetting (see 11.11) and/or by adding extra weights to the vibrohammer.

---

### 11.3.17 Setting up the hammer and driving methods

The driving method to be adopted needs to be taken into account when choosing the type and model of hammer. Rope suspended machines are best if heavy extraction or pitching in panels are used. Small rope suspended vibrators are sometimes used as starter hammers for long piles or when the hammer needs to operate at distance from the crane.

Vibrohammers can also be mounted on tall masted leader rigs. Double clamps can be used to centralise the driving action on long paired piles and the equipment is specially suited for use with pitch and drive methods.

Telescopic leader rigs (picture (a) below) generally use high frequency vibrators and can apply a crowding force from the telescopic pistons which adjust the height of the mast to deliver additional driving or withdrawal force. These machines can therefore press and vibrate the piles simultaneously. The length of the mast, size of the rig and hammer will determine the capability of the installation when using pitch and drive methods.

## Installation of sheet piles



(a)



(b)

---

### 11.3.18 Excavator mounted vibrodrivers

Excavator mounted, small, high frequency hammers (picture b above) can also be used for installing very short piles. Care should be taken when handling piles because excavators are not built for this process and it is not as safe as using purpose built lifting equipment when threading the piles together. This is an inferior means of installing sheet piles and is less capable of driving piles successfully and accurately. It should only be used when installing short, light piles in loose soils when accuracy is not of paramount importance.

---

### 11.3.19 Vibrationless sheet pile pressing

There are several forms that these machines can take but the principle of operation remains the same. They represent a means by which sheet piles can be installed without noise and vibration often called pressing or silent, vibration free hydraulic jacking.

Pressing is the best system for avoiding noise and vibration problems when driving sheet piles on sensitive sites. Especially suited to the installation of piles next to buildings and party walls it eliminates the need for expensive property surveys and minimises the risk of disturbance.

## Installation of sheet piles

As the sheet piles can be installed permanently close to buildings and boundaries more space is available for basements and property development. This yields a major commercial benefit which can be of more value than the cost of the wall itself.

---

### 11.3.20 The 'Japanese' Silent Pressing machine

The Japanese silent presses have been available now for over 15 years and are widely available across Europe. Many different models (ie Giken, Tosa etc) have been developed providing improved operational features which are suited to particular installation situations. The machines and controls have been developed to enable the plant to "walk" over the tops of the driven piles. A system is available to work independently and remotely from access roads and also over water.

The most readily available machines are used to drive single piles, usually 600mm wide U-piles, although sometimes Z-piles may be driven in singles in suitable conditions. Presses have been built that can drive pairs of piles but it is important to note that different machines are used to drive different pile sections so if the pile sections to be driven are not 600mm wide U-piles then the availability of an appropriate machine should be checked.

The machines, which are especially suited for use in cohesive soils, are hydraulically operated and derive most of their reaction force from the friction between the soil and previously driven piles.



# Installation of sheet piles

## 11.3.21 Procedure and control

The most widely used machine is the Japanese silent press which jacks one pile after another to full depth, using a pitch and drive procedure, while walking on the previously set piles. These machines work independently from a crane which is used to handle the piles.

The sheet piles are fed by a crane into the enclosed chuck or pressing jaws of the machine which acts as a guide to align the piles without the need for guide walings. Setting out control is executed by using a laser light beam focused on the leading interlock of the pile being driven. The operator adjusts the verticality and position of the leading lock by remote control and a push pull action on the pile during driving.

The press is able to move itself forwards ('walk') automatically using remote control. The machine raises its body and travels forward to the next position without crane support.

---

## 11.3.22 Starting off

A reaction stand weighted down with kentledge or delivered sheet piles is used to commence the pile line using a few temporary piles to precede the first working pile to be driven. A crane is used to initially lift the machine on to the reaction stand but there is usually no need to lift it off again until completion of the pile line. Ancillary equipment is also available that has been designed to 'walk' along the top of the installed piles, including a crane, to enable the whole piling operation to be carried out on the top of the sheet piles without any other means of access.

---

## 11.3.23 Operational issues and suitability

These presses can also be used for withdrawing temporary sheet piles using this silent, vibrationless method.

The machines work best in clayey, cohesive or very fine grained soils and are usually supplied with jetting equipment for low to high pressure water jetting. This is necessary to loosen fines in cohesionless strata and is also used to lubricate dry soils to make driving easier. For difficult or dense cohesionless strata or gravely soils pre-augering is usually required to loosen the soil. Pre-augering can also be used to probe for and deal with obstructions prior to commencement of the piling. Superficial obstructions are dealt with by digging a lead trench and either backfilling with suitable material or using the trench to control surplus water and arisings when jetting.

## Installation of sheet piles

Japanese pressing machines are not capable of driving piles that have already been installed by other means and therefore cannot be used with panel driving techniques except for initial setting of the panel.

---

### 11.3.24 Panel type silent pressing machines

These pressing machines can drive the sheet piles after they have been installed in a panel but need to be set on the panel using a crane or attached to a driving rig.

The Pilemaster has been in service for many years and uses panel driving techniques. It has 8 rams (delivering up to 200t pressing force per ram) which clamp to plates which, in turn, are bolted to the heads of the piles to be driven. This can be a tedious operation but good silent pressing results are obtainable in stiff clay. Z-piles are preferred with this equipment because the plates can be attached to the web of the piles on the ground before pitching and preliminary driving with a vibro hammer. If U-piles are used the plates would need to be fixed to the pile heads after the vibro driving is completed.



The Pilemaster is still available and is used for hard pressing in London clay and other heavy clay soils when jetting and pitch & drive methods are unsuitable. It needs to be handled by a heavy crane.

The Hydropress, shown below, is smaller than the Pilemaster but can deliver up to 80t pressing force on 4 rams which clamp directly to the pile pans.

This machine is usually mounted on a leader rig or heavy excavator.

## Installation of sheet piles



It should be noted that panel type pressing machines are not suitable for medium dense cohesionless strata and are not compatible with water jetting equipment.

These machines are usually considered for driving in clayey soils only or for completion of a drive into clay after the piles have been driven firstly through cohesionless strata usually by high frequency vibrators. It is therefore important to level the pile tops before application of the panel press

The rams (hydraulic cylinders) are connected to the piles in such a manner that both tensile and compressive forces can be applied. Pressurising the rams in sequence while the others are locked enables the piles to be pushed into the ground, one or two at a time, to the full extent of the rams. The cycle is then repeated to completion.

---

### 11.3.25 **Silent pressing and high frequency (HF) vibrating combined – the DCP power push**

Recently developed, this innovative system combines the power of the silent panel drive system with the versatility of the telescopic leader rig. This machine can be set up to drive AZ, AU, PU and PU-R piles in pairs but they must be supplied in uncrimped form. The HF vibratory method may be combined with the crowding force available from the rig to commence the driving operation in order to develop sufficient reaction force for the press to operate. In this way the commencement of the drive causes very little noise and vibration before the heavy duty pressing mechanism is used for the final stages of driving.



## Installation of sheet piles

The rig is capable of being used for both pitch and drive and panel driving techniques. Rams or cylinders can be arranged in multiples of paired units to deliver push-pull forces to the piles for either driving or withdrawal. It can also be used to finish piles that have been previously installed using other methods, particularly for ground conditions such as sands or gravels overlying clays.



Each double acting cylinder can generate 200t pressing force. Reaction is derived from the weight of the press, the crowd force from the piling rig and by gripping adjacent piles to mobilise static skin friction.

The cylinder and hydraulic jaws can be reconfigured to suit different pile types and layouts including box piles formed from sheet piles (see diagram below and 1.16.5). Up to 4 cylinders can be used on a leader rig and 8 cylinders in line can be used when crane mounted.

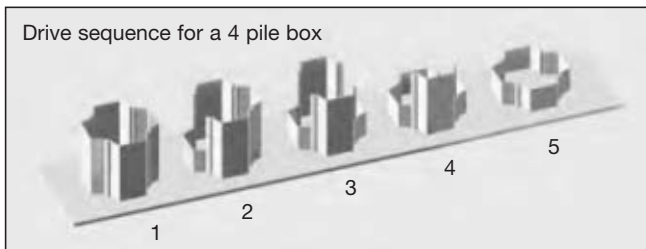

## Installation of sheet piles

### 11.3.26 Silent pressing and augering combined – silent driving into rock

For soil conditions where water jetting and conventional augering techniques would be ineffective, pile driving is now made possible by use of the Super Crush Piling System. A development of the Japanese silent pressing machine, this system uses an integral rock auger inside a casing to penetrate hard ground. The pressing-in action is carried out while simultaneously extracting the auger. As for all situations where augering is involved, care has to be taken not to remove the soil.

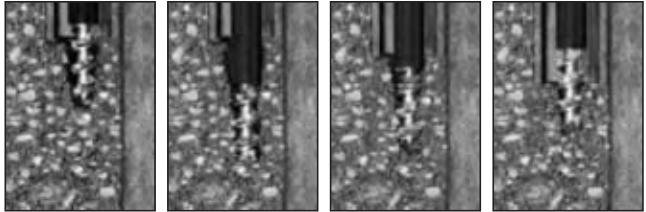

This technique enables silent piling into rock and allows sheet piles to be designed to take significant vertical loads in end bearing. Piles may also be extended by butt welding on site to build deep sheet pile walls that otherwise would not be considered feasible using traditional installation methods. (48m long piles have been installed in Tokyo using this type of machine)

Consideration should be given to the integrity of the seating of the pile and the effectiveness of the water cut-off provided when using this technique. Injection grouting or re-seating of the pile using vibratory or impact driving may be necessary to repair holes or voids in the soil strata caused by the augering process.

The advantage of using these machines in city centres for deep basement construction can be very commercially important for sustainable solutions.

---

## 11.4 The Soil

### 11.4.1 Site conditions

For the successful driving of sheet piles, it is essential that a good knowledge of the site conditions is available to enable an accurate assessment to be made of environmental and geological conditions.

The local environment of the site will influence working restrictions such as noise and vibration. Each site will be subject to its own unique set of restrictions which varies according to the proximity and nature of neighbouring buildings, road category, underground services, power supplies, material storage areas etc.

## Installation of sheet piles

Geological conditions refer to the vertical characteristics of the soil strata. In order to achieve the required penetration of the sheet piles, site investigation of the soils together with field and laboratory tests can aid installation assessment by providing information on:

- a) stratification of the subsoil
- b) particle size, shape distribution & uniformity
- c) inclusions
- d) porosity and void ratio
- e) density
- f) level of the groundwater table
- g) water permeability and moisture content of the soil
- h) shear parameters, cohesion
- i) dynamic and static penetrometer test results and results of standard penetration or pressuremeter tests.

---

### 11.4.2 Soil characteristics

The following table shows the density in relation to penetrometer and pressuremeter-test results for non-cohesive soils:

Table 11.4.2a

Standard penetration test - dynamic SPT $N_{30}$	Cone penetration test - static CPT $q_s$ MN/m <sup>2</sup>	Pressuremeter Test		Density
		$p_l$ MN/m <sup>2</sup>	$E_M$	
< 4	2.5	< 0.2	1.5	very loose
4 to 10	2.5 to 7.5	0.2 to 0.5	1.5 to 5.0	loose
10 to 30	7.5 to 15	0.5 to 1.5	5.0 to 15	medium dense
30 to 50	15 to 25	1.5 to 2.5	15 to 25	dense
> 50	> 25	> 2.5	> 25	very dense

## Installation of sheet piles

The consistency of cohesive soils in relation to SPT, CPT and pressuremeter-test results is as follows:

Table 11.4.2b

SPT # $N_{90}$	CPT $q_s$ MN/m <sup>2</sup>	Pressuremeter Test		Consistency	Undrained shear strength kN/m <sup>2</sup>
		pl MN/m <sup>2</sup>	$E_M$		
< 2	< 0.25	< 0.15	1.5	very soft	< 20
2 to 4	0.25 to 0.5	0.15 to 0.35	1.50 to 5.25	soft soft to firm	20 to 40 40 to 50
4 to 8	0.5 to 1.0	0.35 to 0.55	5.25 to 8.25	firm firm to stiff	50 to 75 75 to 100
8 to 15	1.0 to 2.0	0.55 to 1.0	8.25 to 20	stiff	100 to 150
15 to 30	2.0 to 4.0	1.0 to 2.0	20 to 40	very stiff	150 to 200
> 30	> 4.0	> 2.0	> 40	hard	>200

The correlations between the different methods of soil tests are not based on any standards.

Each method gives its own specific classification of the subsoil. The tables serve only as an aid to the user to complement his or her own experience.

# SPT values are not normally used for evaluating clay layers.  
NOTE: 1 MN/m<sup>2</sup> = 10 bar.

### 11.4.3 Driving system characteristics of various soils

Different types of soil present varying driving characteristics dependant upon the driving system to be adopted. Brief notes on each system are given below.

#### Impact driving

Easy driving may be anticipated in soft soils such as silts and peats, in loosely deposited medium and coarse sands and gravels provided the soil is free from cobbles, boulders or obstructions

Difficult driving may be expected in densely deposited fine, medium and coarse sands and gravels, stiff and hard clays, (depending on the thickness of the strata) and soft-to-medium rock strata.

## Installation of sheet piles

### **Vibratory driving**

Round-grain sand and gravel and soft soils are especially suited to vibratory driving. Easy driving should be expected when soils are described as loose. Dense angular-grain material or cohesive soils with firm consistency are much less suited. Difficult driving may be experienced when dominant SPT values are greater than 50 or significant thicknesses of cohesive strata are encountered

It is also found that dry soils give greater penetration resistance than those which are moist, submerged or fully saturated.

If the granular subsoil is compacted by prolonged vibrations, then penetration resistance will increase sharply leading to refusal.

For difficult soil layers it may be necessary to pre-auger or loosen the soil before installation. Jetting may also be necessary. For penetrating rock, pre-blasting or use of specialised installation equipment may be needed.

### **Pressing**

This method is especially suited to soils comprising cohesive and fine material. Easy driving is usually experienced in soft clays and loose soils. This technique usually employs jetting assistance to loosen silt and sand particles in cohesionless strata to be able to advance the piles by pressing. Successful installation will also depend on the soil providing cohesive adhesion to the reaction piles.

Difficult soil conditions are found when dense sands and gravels or soil containing cobbles or any large particles - which would make jetting ineffective - are encountered. When boulders or rock are encountered, reaction failure or refusal may occur. Lead trenches may be of assistance for the removal of obstructions encountered near the surface.

In these circumstances pre-augering is usually necessary to be able to adopt the pressing technique; otherwise piles will have to be driven to final level by percussive means.

Wet soil conditions are also favourable for pressing. In dry, stiff clay strata, it is normal practice to use low pressure jetting to lubricate the soil to pile interface and make driving easier.

# Installation of sheet piles

## 11.5 Choice of sheet pile section for driving

### 11.5.1 Influence of pile section properties.

Effective construction with sheet piling will depend on the selection of an adequate pile section for the chosen method of installation taking into account any environmental restrictions and ground conditions over the full driven length of the pile. The pile section selected must at least be able to accommodate the structural requirements but this in itself may not prove to be suitable for driving through the various strata to the required penetration depth.

The driveability of a pile section is a function of its cross-section properties, stiffness, length, steel grade, quality, preparation and the method employed for installation. The piles also need to be driven within acceptable tolerances to retain their driveability characteristics.

The driving force required to achieve the necessary penetration is affected by the soil properties and the resistance to driving that develops on the pile profile. Resistance to driving will develop through friction on the pile surfaces that are in contact with the soil and as an end bearing resistance. Normally, the greater the surface or cross section area of the piling profile, the greater the driving force required but changes to the corner geometry of the AU piles has resulted in a reduction in soil compaction and hence resistance during driving. Friction in the interlocks will also influence the driving force together with the physical nature of the soil resisting movement at the toe of the pile. If the tip of the pile meets an immovable object the pile will not drive.

---

### 11.5.2 Influence of driving resistance

Whatever force is required to drive the pile, it is necessary to overcome the total resistance and move the pile without damaging it. While the pile is moving, the hammer energy is expended in overcoming the driving resistance but when the pile ceases to move, the energy from the piling hammer will have to be absorbed by the pile section. This situation increases the stress level in the steel immediately under the hammer and at the point of maximum resistance which will result in deformation of the pile, usually at the head or toe - often both locations - when the driving stresses exceed the yield stress in the steel. The driving stress will also increase with inefficiency of the hammer blow or if the force is not applied properly and spread uniformly across the whole of the pile section being driven. Although it sounds illogical, it is also possible to damage the pile head by using a hammer that is too light and therefore unable to generate sufficient momentum to overcome the resistances and drive the pile.

## Installation of sheet piles

---

### 11.5.3 Influence of steel grade and shape

There is a definite limit to the driveability of a given pile profile and the steel grade being used. As the steel grade increases, the stress that the piles can withstand also increases and so, logically, the higher-yield steel piles are more resistant to head or toe deformation than the same section in a lower steel grade.

In a similar manner, it can be seen that the larger the area of steel in a profile, the higher the load it can carry and hence the heavier pile sections will have increased driveability when compared to light, thin sections. However, it must not be forgotten that under certain driving conditions, a large cross section area may result in an end bearing resistance that exceeds the increase in driveability.

Consideration of the soil layers and appropriate parameters will enable the expected driving resistance to be assessed and hence a suitable section to be selected.

---

### 11.5.4 Influence of method of installation

It is also very important to consider the installation technique to be used. Pitch and drive (P&D) methods will reduce the driveability of the section as discussed in section 11.6.8. When silent pressing using Japanese hydraulic jacking machines, the stiffness of the pile is of paramount importance to maximise driveability as the machine operates on pure P&D methods.

Experience of driving sheet piles enabled relationships to be developed to assess the driveability of particular profiles. One such relationship used the section modulus of the pile profile as the key factor. However, it is not possible to derive the most suitable choice of pile section by consideration of section modulus alone. The section required to be commercially effective and successfully installed depends on consideration of a number of factors and the following selection procedure is recommended:-

# Installation of sheet piles

Figure 11.5.4 Summary diagram showing influences on choice of section

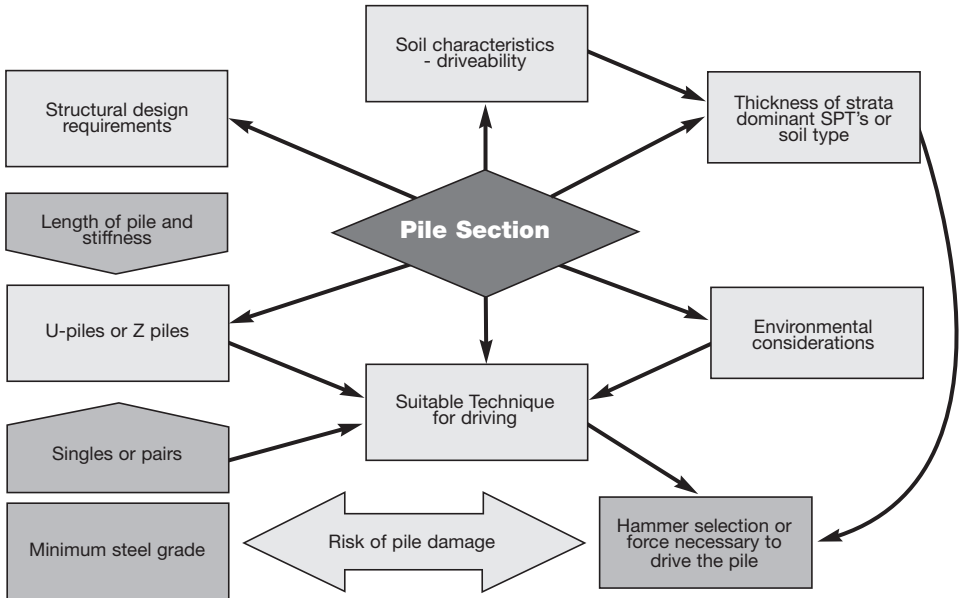

## 11.5.5 Influence of soil type

To assess the prevailing soil characteristics and driveability the following tables may assist in the identification of suitable ranges of sections for driving. The two distinct methods of installation, panel driving or pitch & drive and three methods of driving are taken into account. The choice of section and suitability of the driving method will also depend on whether the piles are driven in singles or pairs.

Please note that the following tables do not take into account thicknesses of strata or the length of pile driven into the ground. This will be considered in subsequent tables



## Installation of sheet piles

Table 11.5.5.1 Driving in cohesionless or principally cohesionless ground

SPT value	Driving method		
	Vibrodrive	Impact drive	Pressing in singles (with Jetting)
0 - 10	Very easy	Runaway problem –use vibro method to grip pile	Stability problem & insufficient reaction
10 - 20	Easy	Easy	Suitable
21 - 30	Suitable	Suitable	Suitable
31 - 40	Suitable	Suitable	Consider pre-auger
41 - 50	Very difficult	Suitable –consider high yield steel	Pre-auger
50+	Not recommended	Suitable –consider high yield steel	Very difficult

The selection of a suitable pile section for driving into cohesive strata is a complex process and the section choice is usually based on previous experience. However it is possible to assess the driving resistance using the surface area of the piling profile and the characteristics of the cohesive strata. The following table may be used for preliminary assessment.

Table 11.5.5.2 – Driving in cohesive strata

Su value	Driving method		
	Vibrodrive	Impact drive	Pressing in singles
0 - 15	Easy	Runaway problem –use vibro method to grip pile	Possible stability problem & insufficient reaction
16 - 25	Suitable	Easy	Easy
26 - 50	Suitable – becoming less effective with depth	Suitable	Easy
51 - 75	Very difficult	Suitable	Suitable
76 - 100	Not Recommended	Suitable	Suitable
100+	Not Recommended	Suitable	Difficult

## Installation of sheet piles

Table 11.5.5.3 - Consideration of driveability characteristics relative to cohesive strata thickness

Su value	Driveability of pairs		
	0-2m penetration	2-5m penetration	>5m penetration
0 - 15	Not recommended	Easy	Easy
16 - 25	Easy	Normal	Normal
26 - 50	Easy	Normal	Normal
51 - 75	Normal	Normal	Hard – consider high yield steel
76 - 100	Normal	Hard – consider high yield steel	Hard – consider high yield steel
100+	Hard – consider high yield steel	Hard – consider high yield steel	Very hard – high yield steel

Table 11.5.5.4 – Maximum recommended driving lengths for Silent Japanese pressing rigs (Giken and Tosa type)

Section	Pressing force (<60t)	Pressing force (60t-100t)	Pressing force (>100t)
Single PU 8R	unsuitable	unsuitable	unsuitable
Single PU12	8m	6m	Not recommended
Single PU18*	10m	9m	8m
Single PU22*	13m	12m	11m
Single PU25	14m	13m	12m
Single PU32	16m	15m	14m

\* Section with reinforced shoulders

### 11.5.6 Driving dynamics and driving characteristics for impact driving sheet piles

Whichever method is adopted it is important that an acceptable rate of penetration is maintained. The size as well as the type of hammer must be suitable for the length and weight of the pile being driven and it is assumed that the ground is penetrable.

For impact driving the rate of penetration, or blow count, is the most recognisable indicator of the driving conditions. The mean driving stress,  $\sigma_m$ , in the pile section will also be a function of the resistance and section properties of the pile.

$$\sigma_m = R_{app} / A_{act}$$

where  $R_{app}$  is the total apparent resistance and  $A_{act}$  is the actual cross section area of the pile being driven.

## Installation of sheet piles

The driving stress in the pile section can be used as an indication of the expected driving difficulty; an approximate guide is given in table 11.5.6.

Table 11.5.6

Driving condition	Easy	Normal	Hard
Driving stress	< 25% $f_y$	25 – 50% $f_y$	50 – 75% $f_y$
Rate of penetration (blows per 25mm)	< 2	2 - 8	> 8

### 11.6 Resistance to driving

In penetrable ground, sheet piles are regarded as minimal displacement piles. The driving resistance of a sheet pile (single or pair) is simplified by the following relationship:

$$R_{app} = \text{Soil Resistance} + \text{Interlock Resistance}$$

The apparent resistance depends on both the soil conditions and the length of embedment. Unlike tubes, H piles and other relatively closed sections, up to the onset of refusal, plugging of sheet piles is unlikely and skin friction will dominate.

The frictional resistance will depend on the type of interlocks, method of driving, whether the interlocks have lubricating sealants or whether soil particles enter the locks and most important of all the joint resistance will depend on the straightness and verticality of the installation of adjacent piles relative to each other. Damage to piles and poor condition will also increase resistance significantly.

For a pile to drive effectively the total resistance has to be overcome by such a margin that the pile progresses into the soil at a high enough rate so that damage to the pile or the hammer is unlikely to occur. In order to achieve this when impact driving, the momentum of the hammer (namely the product of the ram mass and the velocity at impact) must be sufficient. The delivered kinetic or potential energy are often used as criteria for selecting an appropriate size of impact hammer.

#### 11.6.1 Impact hammer efficiency ( $\xi$ )

The delivered energy =  
 Hammer operating rated energy x efficiency of the blow.  
 (Please note that some hammers have adjustable output).

The efficiency takes into account losses of energy at impact, in the pile driving cap and the effect of absorption into the pile. Hammers of different types with different caps, plates and guides have various efficiency ratings. The poorer the fit to the pile the lower the efficiency of the hammer and hence the amount of

# Installation of sheet piles

energy delivered. The following table indicates the potential difference in efficiency of hammers when used on sheet piling.

Efficiency of diesel hammers on sheet piling can also be affected by a tendency to rock and move position during the driving process resulting in inaccurate alignment of the central axis of the hammer and the sheet pile section being driven.

Table 11.6.1

Impact Hammer type	Efficiency rating (Hammers and fittings varying condition conservative expectation)	Efficiency rating (Hammers and fittings in very good condition)
Hydraulic	75-85%	85-95%
Diesel	20%-40%	30%-60%

The efficiency of the blow is also affected by absorption of energy into the pile and the ratio of the impact hammer's ram weight ( $W$ ) to the weight of the pile and driving cap ( $P$ ).

Fig 11.6.1 demonstrates the effect on efficiency by comparing pile to ram weight ratios on different types of hammer.

Fig 11.6.1

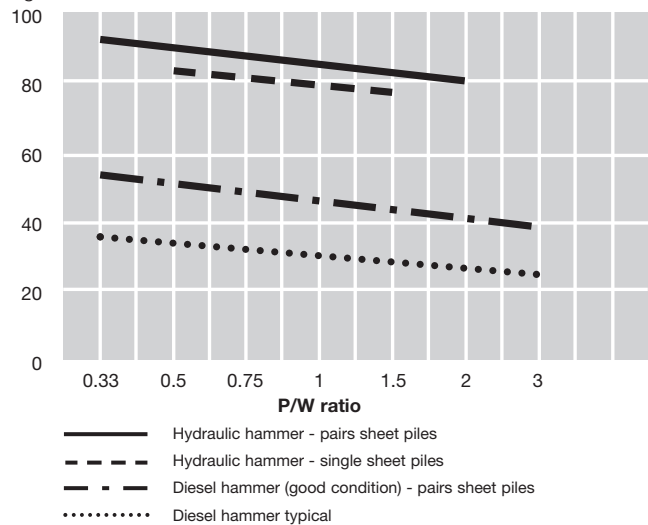

Note that driving in pairs doubles the mass of the piles to be driven. Larger hammers with heavier rams can be used on pairs but it may not be possible to fit such a hammer on single piles.

## Installation of sheet piles

### 11.6.2 Delivered energy

For impact hammers the delivered energy is either of the following:

- a) For impact hammers where the ram weight delivers the blow by free fall under gravity

$E = Wh\xi$  where  $W$  = weight of the ram,  $h$  = drop height,  $\xi$  = overall efficiency of the blow

- b) For double acting or accelerated hammer

$E = E_{op} \xi$  where  $E_{op}$  = Hammer operational delivered energy set by the operator

The maximum deliverable energy

$E_{max} = E_R \xi$  where  $E_R$  = Hammer manufacturers maximum energy rating

$E_R = 0.5 m v^2$  where  $m$  is the ram weight and  $v$  is the velocity at impact

---

### 11.6.3 Measuring the delivered energy

- a) By means of the hammer operation and control equipment:

For a drop hammer, the free fall distance is measured or set by the operator – if the control equipment provides the facility, a digital readout may be obtained for hydraulic drop hammers. Diesel hammers are usually difficult to assess. Although different settings are available on the controls, the usual method of assessing the energy is by recording the blow rate and referring to graphs provided by the hammer manufacturer.

For double acting hammers, timing the blow rate may also be necessary but by far the best way is to have the controls calibrated and fitted with digital readout equipment. Some hammers can be controlled by pre-setting the required delivered energy in this way. The readouts can also be connected to a portable laptop to store and monitor the readout for driving record purposes.

- b) By means of dynamic monitoring:

Pile Driving Analyser (PDA) equipment is obtainable from specialist firms and transducers can be fitted to the sheet piles so that measurements can be taken for the following:-

Hammer efficiency, internal driving stresses and pile capacity.

The blow count and hammer stroke can be measured by using a Saximeter or similar equipment

A software program for analysing measured force such as the Case Pile Wave Analysis Program Continuous Model (CAPWAPC) can be used to determine site specific soil parameters.

# Installation of sheet piles

## 11.6.4 Sizing the impact hammer

Studies have shown that modern hydraulic hammers which operate at impact velocities in the order of 5m/sec are able to overcome approximately 100 tonnes of apparent resistance per tonne of ram mass at maximum performance. On the basis that these hammers operate at 80 to 95% efficiency, it is possible to relate the required delivered energy to the apparent driving resistance at a rate of penetration approaching refusal as illustrated in Fig 11.6.4. The line on this graph represents the boundary between acceptable performance and effective refusal (defined here as 10 blows per 25mm penetration); the chosen hammer should operate on or below the line.

Fig 11.6.4 Relationship between required delivered energy and apparent driving resistance near refusal

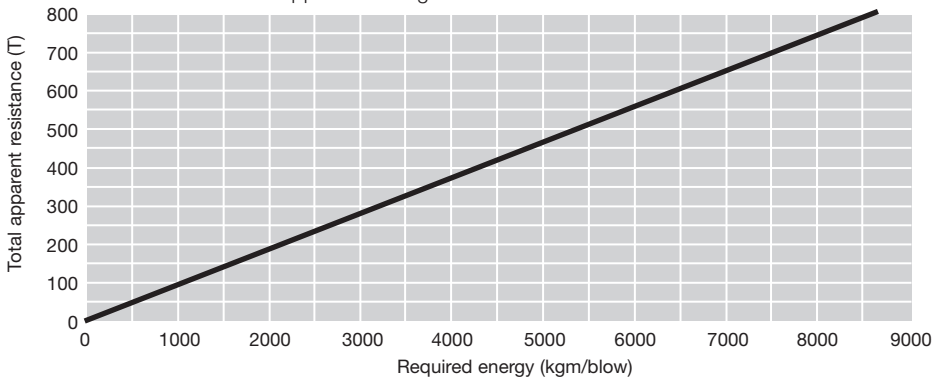

The total apparent resistance may be estimated on the following basis:

$R_{app} = R_s \times F_d$  where  $R_s$  is the sum of the skin friction resistance over the embedded length of the driven pile.

The end bearing resistance is ignored for the purposes of sizing the hammer, as the pile is assumed to be driven at a rate less than 10 blows per inch and end bearing usually only becomes significant as refusal is approached.

Skin friction = Area of pile in contact with the soil x unit frictional resistance (See 10.3.3 for suggested method of assessing unit friction resistances in cohesive and granular soils).

$F_d$  is a dynamic resistance factor for sheet pile driving which depends on the velocity at impact, damping effects and interlock friction. Damping effects and interlock friction will also depend on soil characteristics and length of embedment of the pile.

# Installation of sheet piles

The following table serves as an empirical guide to estimate  $F_d$ .

Table 11.6.4

Depth of pile embedment	Hammer ram velocity at impact Less than 4m/sec	Hammer ram velocity at impact More than 4m/sec
Up to 5m	1.2	1.2
5 to 15m	1.2 to 1.5	1.2 to 2.0
Over 15m	Not recommended	> 2.0

Using the above procedure a suitable pile hammer can be selected.

Please note that the selection of appropriate driving equipment is an iterative process as the apparent driving resistance is a function of the pile size and depth of embedment.

## 11.6.5 Driving dynamics and selection of suitable pile section and grade of steel for impact driving

Taking into account the above tables, criteria for selection of the pile section can now be established for impact driving in penetrable ground.

When identifying a suitable pile section it is recommended that the peak driving stress should generally not exceed 75% of the yield stress.

Fig 11.6.5 Minimum steel area to be driven for a given apparent driving resistance

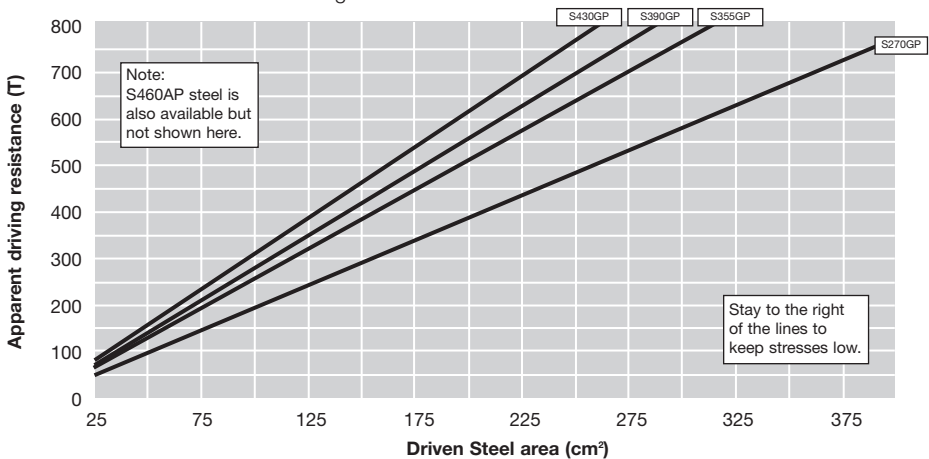

Figure 11.6.5 may be used to estimate the minimum area of steel pile to be driven before selecting a pile section and steel grade.

To further reduce the risk of head damage, the area of steel provided should be assessed on the basis of the area actually covered by the hammer anvil not the cross section area of the pile.

## Installation of sheet piles

After selecting a section, the mean driving stress can be estimated by dividing the apparent resistance by the section area.

Please note that for  $R_{app} > 8000\text{kN}$ , high yield steel grades or HZ/AZ systems may be appropriate. We recommend contacting our Technical Advisory Service for further guidance when selecting appropriate products and installation methods for anticipated resistance of this magnitude or for hard driving where toe resistance is significant for example when driving into rock.

---

### 11.6.6 Relationship between peak stress and hammer efficiency

For hammers with low efficiency it is possible that peak stresses will be significantly higher than mean stresses.

Table 11.6.6 below is based on the equation

$$\sigma_p = \sigma_m \cdot \left[ \left( \frac{2}{\sqrt{\xi}} \right) - 1 \right]$$

(introduced in Section 11.3.8) and shows the magnification factors to be applied for different hammer efficiencies.

Table 11.6.6 Factor for peak stresses in the pile section

$\xi$	0.9	0.8	0.7	0.6	0.5	0.4	0.3
Factor $\sigma_p/\sigma_m$	1.108	1.236	1.390	1.582	1.828	2.16	2.65

The effect of reduced hammer efficiency can thus be taken into account by multiplying the calculated apparent mean driving stress by the factor from Table 11.6.6 to obtain the estimated peak driving stress. If this is greater than  $0.75f_y$ , then a larger section or higher steel grade should be tried and the mean and peak stress re-calculated.

---

### 11.6.7 General comments on driveability and use of tables

The method indicated above for the selection of pile section and hammer does not take into account driving method.

Generally, a heavier section will drive better than a lighter section and panel driving, provided the lead on the pile being driven is not too great, will yield better results - in line with forecasts - than pitch & drive techniques. In this respect there is a limit to the suitability of any particular pile section in respect of a pure pitch & drive technique.



# Installation of sheet piles

## 11.6.8 Influence of stiffness of pile and driving method

The pile length and its stiffness and the distance driven into the ground ahead of its neighbour will principally govern driveability.

Panel driving methods should limit the distance any pile is driven ahead of its neighbour. Recommendations are as follows.

Table 11.6.8

	Easy	Normal	Hard	Driving into rock
Panel driving – by impact driving in pairs	8m - At contractors risk above this	4m	2m	0.5 m
Pitch & drive – by vibro-driving methods (refer to table 11.5.5.4 for pressing methods)	Singles possible Maximum usually about 14m -accuracy difficult beyond this.	Pairs better than singles - length of advancement depends on section and ability to control alignment	Not to be recommended  Methods of altering the ground such as pre-augering sometimes possible	Totally unsuitable

## 11.6.9 Sizing vibro-drivers

Although there is less risk of damage to the pile section where conditions allow the use of vibrohammers, where driving becomes more difficult the selection process for these hammers is different. When using a vibrohammer it is imperative that the pile continues to penetrate the soil at an appropriate rate. This will ensure that the energy being input is expended in overcoming the soil resistance and not in the generation of heat in the interlocks which may be sufficiently high to weld interlocked sections together.

Usually environmental considerations are a main concern but the effectiveness of a vibrohammer in tough ground conditions is not easy to predict. If pitch and drive techniques are used the recommendations in the above table should be followed. If control of alignment and good rates of penetration cannot be achieved then panel driving techniques possibly using other types of hammer should be considered. Generally vibrohammers with greater power and self weight and higher amplitude will perform better in harder and deeper strata. If it is necessary to complete driving with a vibrohammer the following figure may assist in identifying the size of machine required. Leader rigs may add an additional crowding force of say up to 300kN but this may not be sufficient to penetrate thick clay or dense soil strata. Also, it is worth noting that for harder driving conditions associated with trying to install long piles with up to 20m penetration using vibro driving, the apparent resistance significantly increases and hammers with much greater power are necessary unless impact driving techniques are used.

# Installation of sheet piles

It is important to ensure that the vibrohammer is capable of supplying the necessary centrifugal force to drive the piles and that the power pack or carrier machine is capable of supplying sufficient power for the vibrohammer to operate at its maximum output.

Fig 11.6.9 Guidance for size of vibrohammer (rated by centrifugal force) in terms of pile weight and driving conditions

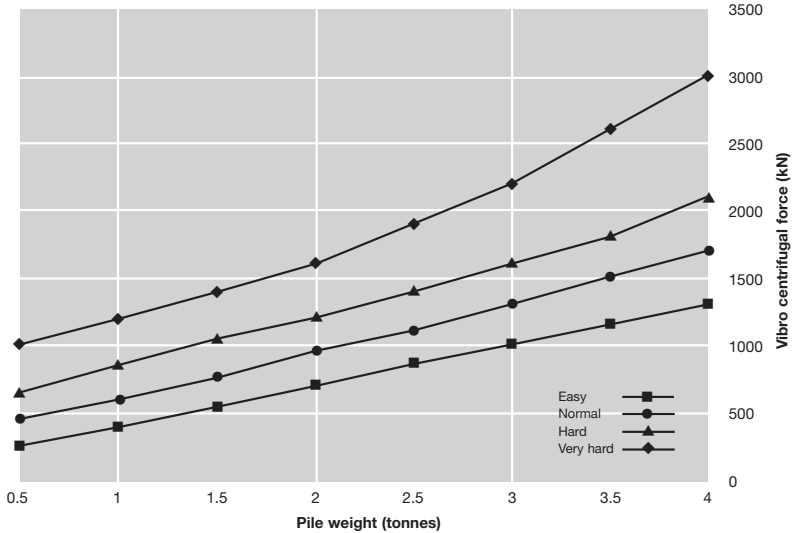

Amplitude is also an important factor when sizing vibrodrivers.

$$\text{Amplitude} = \frac{2000 \times \text{Eccentric Moment (kgm)}}{\text{Dynamic weight (kg)}}$$

(where the dynamic weight includes the clamp and sheet pile)

Table 11.6.9 Minimum amplitude requirement

Easy driving	Normal driving	Hard driving
4mm	6mm	8mm

Note that the amplitude quoted in manufacturers literature does not normally allow for the weight of the clamp and pile.



# Installation of sheet piles

## 11.6.11 Other factors affecting choice of section

After identifying a suitable pile section for driveability, the following factors should also be taken into consideration to adjust the final choice of section and steel grade.

Table 11.6.11 Other factors influencing choice of section

Condition or Technique	Factors
	Influence on pile section choice
Increase steel grade	Possible reduction in section size when impact driving
Increase length of pile at head or toe	Increase pile section when using pressing or P&D method
Second hand piles, good condition	Increase section size or assume mild steel if grade unknown
Cobbly ground, boulders, rock etc	Increase section size and grade of steel, consider impact & panel drive methods. May also consider reinforcing pile head and toe.
Pre-augering	Possible reduction in section size but reconsider structural design implications and risk of increased deflections.
Allowing rotation at interlocks (P&D)	Increases friction - increase section size - not suitable for Z piles
Japanese standard pile pressing	Single U-piles best - increase pile section or stiffness

## 11.7 Guiding the piles and controlling alignment

### 11.7.1 General

It is recommended that a rigid guide waling system is employed when driving steel sheet piles and purpose built steel pile driving guides are available for this purpose. When using pitch and drive methods it is often the case that the leader rig is assumed to provide sufficient guidance to the piles and guide walings are not used. While a string line will indicate the line that the piles should follow, it can be easily moved and consequently will not prevent misalignment. It is better to use guide walings to prevent rotation of the interlocks and to limit the twist that can be induced in a pile by the driving equipment - see also 11.7.4.

In the past, timber support systems were used but steel systems are stronger and cheaper than timber and it is easier to make temporary connections by tack welding steel guide walings to the driven sheets and vice versa to control accuracy.

Walkways of the correct width, handrails and proper access ladders must be provided to comply with H&S regulations. Supporting trestles are quick to erect, strip and move, and can be dismantled and neatly stacked for transportation. Safety features are incorporated to provide safe access and working space when assembly is either partially or fully complete. Walkway walings provide safe access to the work area and a secure working space. They are stiff box-girder beams and therefore will also serve as a rigid guide and straight edge for accurate pile alignment.

Regular cleaning and the provision of drain holes is recommended.

## Installation of sheet piles

11.7.2 **Guide walings** The functions of the guide walings are

- 1 To support piles in the vertical plane during pitching operations;
- 2 To restrain the sheet piles during driving and prevent lateral flexing;
- 3 To control parallelism of the pans or flanges of the piles;
- 4 To minimise rotation of the interlocks and thereby minimise friction in the lock;
- 5 To act as setting out restraints and a physical check on the correct alignment of the pile line;
- 6 To provide access for personnel to pitch the piles, carry out welding and access the piles effectively, provided they are wide enough to function as a walkway;
- 7 To facilitate fixing of permanent walings to structurally support the sheet pile wall;
- 8 To act as a template when constructing walls with complex and irregular shapes, setting out corner and junctions accurately and construction of circular cofferdams.

It is particularly important that sheet piles are maintained in the correct horizontal and vertical alignment during installation. This is achieved by the use of effective temporary works and guide frames which should provide support to the piles at two levels. To be effective, the top and bottom guides must be rigid. The temporary works may be pinned to the ground using temporary H piles to prevent movement of the whole frame.

The effectiveness of the guides and accuracy of driving will be improved by maximising the distance between the two support levels. Very long sheet piles may need intermediate guides to prevent flexing and other problems associated with the axial loading of long, slender structural members. Pile installation may exert large horizontal forces on the guides and it is essential that the temporary works used to support the guide walings are adequately designed and rigidly connected so that movement or collapse does not occur during driving operations.

To prevent pile twist within the guide frame, the free flange of a Z type sheet pile or free leg of a U type pile should be secured by a guide block or strap connected across the waling beam during driving.

When driving piles in water the lower frame can be attached (above or below water) to temporary bearing piles.

When installing in marine conditions it is possible to use tube pile sections as the horizontal walings to facilitate pitching if the lower guide is expected to become submerged by the incoming tide.

## Installation of sheet piles

The curved upper surface of the tube will ensure that the pile being pitched is guided into the correct location between the walings.

Ladder access must comply with H&S regulations and because of the inherent danger, it is essential that sheet pile pitching is not carried out from ladders. Access platforms must be positioned to enable safe access throughout all operations.

Purpose built trestles and walkways are designed so that the top guide waling can be removed at the appropriate time to allow the pile to be driven with the bottom guide in place maintaining control in the intermediate stages of driving.

---

### 11.7.3 Commencement of driving pitched panels with rope-suspended hammers

It is recommended that two levels of guide walings are used. Rope suspended hammers are usually used for the initial stages of panel driving because they can be used at greatest reach with the crane for withdrawing or lifting the pile if adjustments are necessary. Alternatively, leader rigs may be used for initial driving if access is available close to the pile line and the pile length does not exceed the working height of the mast.

Temporary works provide support to the upper level guide waling for the piles. To be effective it should be at least a third of the pile length above the lower guide and preferably located as close to the top of the pitched piles as possible.

---

### 11.7.4 Guiding the piles when installing with fixed or telescopic leaders

With this method it is usual for both the hammer and the pile to be guided by the leader. As a result there is less need for upper guide walings but it is nevertheless recommended that a rigid, ground level guide waling is used to prevent excessive twisting of the piles by the leader rig during the driving and correction process.



## Installation of sheet piles

It is important that the leader is always vertical and that the hammer delivers its energy through the centroid of the pile profile.

Pile lines are found to be straight and true more often when suitable guide walings have been used than when attempts have been made to follow string lines between setting out pegs.

The spacing of the beams must be maintained by spacers to suit the theoretical depth of the paired pile section + approximately 10mm. Therefore if PU22 piles are to be used the spacing of the pile guide walings should be  $450\text{mm} + 10\text{mm} = 460\text{mm}$ .

When pitching and driving a guide element consisting of spreader and bracket should be located adjacent to the sheet piles being driven to prevent frame bulging. The wider the guide walings are set apart the more freedom for rotation occurs making the wall untidy and more difficult to drive

---

### 11.8 Handling, sorting and lifting the piles on site

#### 11.8.1 Stacking and handling

It is essential that the piles are stacked safely on firm level ground before handling for installation. This is not only important to prevent accidents caused by stacks toppling and trapping personnel but also to minimise damage whilst piles are stockpiled on site.

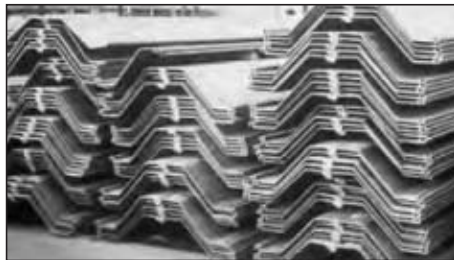

---

#### 11.8.2 Bundles of piles

These should be lifted from the delivery lorry using a crane of adequate size and lifting chains fitted by an experienced and trained piling crew and banksmen. Bundles of piles can be heavy so it is essential that adequate hard-standing is available for unloading operations.

Unloading piles using telescopic leader rigs and excavators is not recommended

## Installation of sheet piles

### 11.8.3 Splitting bundles and lifting individual piles

These operations need special ancillary equipment which is designed specifically for this purpose.

Makeshift equipment and use of inappropriate plant such as excavators should be avoided.

Simple cast-steel shoes have been designed to slide between each pile in a stack enabling them to be easily separated and moved horizontally. The shoes are usually attached to long steel rope slings which allow them to be attached at both ends of the pile. U-piles are easy to handle in this way because single bars balance well in the horizontal position. When handling pairs of piles the shoes have to be attached to the same individual bar to prevent the two piles from sliding apart. Spreader beams are sometimes needed for handling very long piles and straight web sections.

---

### 11.8.4 Shackles

A variety of special “quick” ground release shackles are available and should be an essential part of the sheet pile installers equipment.



These enable the crane connection to the pile top to be released, when required, from ground level or walkway waling level. This is fast, efficient and safe and eliminates the risk of personnel climbing ladders to release the lifting device from a pitched pile. The shackle uses a lifting hole in the head of the pile through which a shear pin passes.



## Installation of sheet piles

Piles stacked in bundles should be carefully lifted with purpose built shoes and suitable dunnage inserted to space out the piles before connecting the quick release shackle (QRS). The slinging holes in the piles should be ordered or cut to suit the QRS or other lifting attachment to be used. It is necessary for personnel to be trained to attach and check the QRS to ensure correct insertion of the lifting pins in the pile head hole before the signal to lift the pile is given.

### 11.8.5 Lifting chains



When telescopic leader rigs are used for pile installation the process of lifting the pile off the ground is usually achieved by attaching chains fastened near the end of the mast and driving equipment. Holes of adequate size to accommodate the lifting chains are usually cut in the webs of the sheet piles about 300mm from the top of the piles before pitching. This enables the pile to be lifted up to the hammer jaws near the top of the mast. The pile is then driven and the chains are released near to ground level before the hammer or mast needs to be moved away from the pile.

## Installation of sheet piles

### 11.9 Pitching - connecting the interlocks when pitching the piles

Interlocking the piles together in the vertical position is called pitching.

The greatest risk of injury to piling personnel occurs during pile pitching so it is important to develop a safety plan and an approved method of working before work commences.



The following actions or conditions must be ensured to comply with H&S regulations

- 1 The lifting plant or crane must be securely connected to the top of the pile until the pile is fully threaded and supported by the ground. Piles should not be allowed to free fall.
- 2 Personnel threading the piles or handling the free end of the pile being lifted must operate from a safe working platform or ground level. Operatives must not stand on ladders or balance on the tops of piles when piles are being pitched
- 3 Sufficient numbers of personnel need to be available for handling the size of pile being pitched especially in windy conditions. One or two operatives should restrain the pile from swaying - using ropes if necessary. The crane operatives should avoid slewing or moving the jib when operatives are attempting to pitch the piles by hand. The piles should only be lowered when the correct signal is given by a qualified banksman

As a consequence of panel driving, there is a need to interlock piles and release the crane connection, at a high level, with efficiency and safety. To do this correctly, appropriate temporary platforms need to be erected and special threading equipment should be used.

---

### 11.10 Threading devices

The sheet pile threader is designed to interlock any steel sheet pile accommodating the different profiles, handling and interlock types without the need for a man to be employed at the pile top.

## Installation of sheet piles

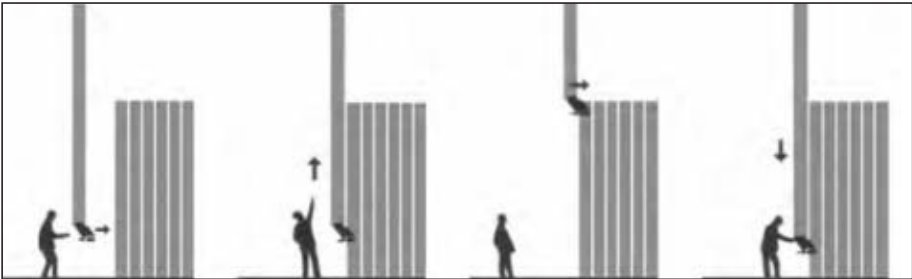

The threader is attached at platform level

The signal is given to raise the pile

The spring mechanism guides the interlocks in place at the top

After the interlocks engage the pile is lowered and the threader is removed

Use of a pile threader allows pile pitching to continue in windy conditions which would stop manual interlocking, making the work both safer and more efficient.

---

### 11.11 Driving Assistance

#### 11.11.1 General

Under certain conditions, impact driving, vibrating and pressing of piles can be made easier with the help of jetting. The process delivers water to the toe of the pile where it loosens the soil causing the toe resistance of the pile to reduce and, depending on the soil conditions, causes a reduction of skin and interlock friction as it flows back to the ground surface along the faces of the pile.

The equipment comprises a lance (and nozzle) fitted to the sheet pile to deliver a water jet at the toe of the pile. The water is delivered at controlled pressure by hoses connected to the lance from a water jetting unit fed by a pump from tanks capable of supplying sufficient water.



## Installation of sheet piles

The effectiveness of jetting is influenced by the density of the soil and the proportion of fines present, the available water pressure and the number of jetting pipes. Planning the disposal of water and provision of silt trap tanks is also necessary. Piling installed in a leading trench will help to control the disposal of jetting water and help to keep operations and the site as tidy as possible.

Care must be exercised to ensure that this form of ground treatment does not endanger adjacent structures. It is not unusual for a loss of fines to occur in the soil near to the pile but, other than the risk of a small amount of settlement and a reduction of the angle of friction of the soil acting on the wall, structural properties of the sheet pile wall will be substantially unaffected.

Jetting equipment that can be controlled by the piling gang is recommended. The least amount of water pressure should be used to advance the piling and the piles should be finally driven to level without jetting wherever possible to ensure that the integrity of any cut-off at the bottom of the wall is not compromised and that voids will not be created at the pile toe potentially reducing the bearing capacity.

Test-driving to define the parameters is recommended.

---

### 11.11.2 Silent Pressing and Jetting

Silent pressing machines work best in cohesive soils. The Japanese presses can be effective if cohesionless soils are encountered because they can be used with water jetting equipment. A water supply and disposal facility is therefore required. Water jetting is not usually available for or compatible with the panel jacking machines.

---

### 11.11.3 Low pressure jetting

Low pressure jetting is mainly used in cohesive soils with vibro driving and in dry stiff cohesive soils with Japanese presses.

In combination with a vibratory pile driver, jetting can enable piles to penetrate very dense soils.

In general the soil characteristics are only slightly modified, although special care must be taken when piles have to carry vertical loads. See ArcelorMittal publication, 'Jetting-assisted sheet pile driving' for further details.

---

### 11.11.4 High pressure jetting

High pressure jetting may be used for driving in extremely dense soil layers and if gravels are encountered when using Japanese presses.

## Installation of sheet piles

If high pressure jetting is envisaged, water consumption should be checked with the equipment supplier and provision made for supply and disposal of the water with the Client and appropriate authorities.

High pressure jetting should only be carried out with the Engineers consent and an agreed method statement.

---

### 11.12 Blasting

This process is applicable to types of rock which until now would have been classified as difficult or impossible for driving steel piles to specific penetration designed requirements.

---

#### 11.12.1 Normal blasting technique

Explosives are lowered into drilled holes and covered with soil before detonation. This can create a V-shaped trench along the proposed line of the wall or shatter the rock into various sized particles. The size of the fragments in the trench is dependent upon the amount of explosives used, the competence and stratification of the rock and the spacing of the drilled holes. Pre-blasting may be more appropriate for stronger more brittle competent rock types. Soft rock types are usually unsuitable for blasting techniques.

Nevertheless if the blasting technique shatters the rock very well, the driving conditions in the loosened area will still be very tough and high yield steel and toe reinforcement of the piles is recommended.

In many instances, the process has to be repeated locally, because the blasting has failed to shatter the rock and the piles refuse during the subsequent driving operation. As a result, this process can be very costly, it is difficult to price and estimate rates of production and each project considered using this process is likely to be different

It is therefore recommended that sheet pile walls are designed with maximum support towards the top of the piles to keep the required penetration into rock to a minimum.

## Installation of sheet piles

### 11.12.2 Pre-augering



Dense cohesionless strata are usually pre-augered on the pile line to loosen the soil before pressing is attempted. Easier impact driving, vibrating and pressing can be achieved by pre-augering. Holes of about 20cm - 30 cm diameter are drilled at approximately 600mm centres on the centre line of the wall. Depths of up to 10m can easily be treated using auger equipment mounted on a telescopic leader rig which may be interchangeable with equipment for installing the piles.

When loosening the soil by augering, care must be taken not to remove the

soil and leave holes – as can occur when attempting to auger into dense cohesionless soils underlying clay strata. Any holes that do occur should be filled with granular soil before driving piles.

Pre-augering should be avoided in the passive zone, near the toe of the piles and where artesian water could be encountered.

It must not be forgotten that augering effectively changes the nature of the soil and possibly the water table regime in which the pile is located which may invalidate the design assumptions. It is also likely that wall deflections will increase especially in any temporary construction stage cantilever condition.

---

### 11.13 Driving Corrections

#### 11.13.1 Correction of lean

Care should be taken to pitch the first piles vertically and maintain them in a true position within permitted tolerances.

In order to avoid the tendency of sheet piling to lean, the hammer should be positioned over the centre of gravity of the piles being driven and should be held vertically and firmly on the piles by means of efficient grips. When driving in pairs the adjacent piles should be square and true at the top and the hammer blow spread evenly across the maximum area of steel by means of a correctly sized and fitting anvil or driving cap.

Transverse leaning of sheet piles is eliminated by the use of efficient guide walings. If the piles develop a transverse lean which needs to be corrected, the piles should be extracted and re-driven in shorter steps to maintain control.

## Installation of sheet piles

Longitudinal leaning in the direction of driving may be caused by friction between the previously driven pile and the pile being driven or by incorrect use of the hammer and should be counteracted immediately if it becomes apparent. If left unchecked, the lean can become uncontrollable requiring piles to be withdrawn until an acceptably vertical pile is found. Pile installation can then continue using panel methods to reduce the risk of further lean.

Prevention is better than the cure and when using pitch and drive methods, driving should cease before the lean approaches the maximum permitted verticality tolerance limits. Panel installation methods should then be used to eliminate further leaning by backdriving from piles installed with acceptable verticality towards the leaning piles against the direction of installation.

In conjunction with the above method, longitudinal lean may be corrected by pulling the misaligned piles back with a wire rope while displacing the hammer from the centre of the pair towards the last driven piles.

When a lean cannot be eliminated and piles cannot be withdrawn and replaced, the error may be corrected by introducing taper piles, but only with the consent of the Engineer.

---

### 11.13.2 Drawing down

When piles are driven in soft ground or loose sandy soils the pile being driven may draw down the adjacent pile below its intended final level. The problem sometimes occurs when the Pitch & Drive method is used and is caused when more friction develops in the interlock connected to the pile being driven than is available in the interlock connected to the previously driven piles.

This may happen when either or all of the following occurs

- the piles are leaning forward
- the piles have been allowed to rotate causing interlock friction
- vibrodriving action has compacted sand into the interlocks during installation
- interlocks have not been cleaned before driving
- interlocks have been damaged or bind together on one side of the pile

A remedy for the problem when vibrodriving is to re-level the heads by withdrawing the piles and tack welding them together in pairs and proceeding with a panel backdriving method. Pairs of piles will usually be driven easily in soft ground where this problem is usually found.

## Installation of sheet piles

Alternatively impact driving may be used instead of vibrodriving. Where the problem is encountered locally the simplest means of prevention is to tack weld the pile being drawn down to the temporary guide walings – however these must be adequately supported so that they do not move or collapse when driving the piles.

The problem is less likely to occur if the piles are installed with good alignment and verticality and the problem may be alleviated by introducing a sealant to the interlocks to prevent the ingress of soil to the interlock area during driving.

---

### 11.13.3 Control of wall length

When using uncrimped piles, a limited degree of wall length control may be achieved by adjusting the distance between guide walings and rotation of the piles at the interlock positions to suit. This is not recommended for permanent construction as rotation at the interlocks will affect the appearance of the wall, can be expected to increase driving resistance and will increase the possibility of declutching. When piles are supplied crimped, this method of wall length adjustment will not be possible as the process fixes the position and orientation of the connected piles.

If accurate theoretical wall dimensions have to be achieved, it may be necessary to introduce a fabricated pile.

---

### 11.13.4 Driving tolerances

Theoretical position and orientation of the sheet piles are usually indicated in the driving plan on working drawings. Deviations from this theoretical layout may occur due to rolling tolerances, soil conditions and driving procedure.

General tolerances for a straight and plumb sheet pile wall should be in accordance with the following figures (see also EN 12063).

- a) deviation in plan normal to the wall line at the top of the pile  $\pm 50$  mm ( $\pm 75$  mm for silent pressing)
- b) finished level deviation from nominal level of top of pile  $\pm 20$  mm
- c) deviation of verticality for panel driving - all directions 1 in 100
- d) deviation of verticality along line of piles for pitch & drive 1 in 75

Tolerances for plan and verticality are accumulative and designers and architects should allow for this especially when considering design of internal fittings or within a cofferdam.



## Installation of sheet piles

### 11.14 Special Aspects of installation

**11.14.1 Test-driving** Where the driveability of the soil is difficult to assess, test-driving is recommended.

Test-driving is undertaken to determine the pile section which, when driven by a suitable hammer, will reach the required depth most economically. Test drives should be carried out on the line of the final wall, their number depending on the size of the project and on the expected variations in the underlying strata. Good control of the pile and the hammer is required and driving records must be taken.

Subsequent extraction of the piles may give supplementary information.

In the event that the piling is to carry axial load, it may be convenient to use the test piles to carry out a load test using Dynamic Analysis in conjunction with a suitable impact hammer.

Silent pressing machines may record pressing and withdrawal forces which can assist Engineers to assess the ultimate skin friction capacity of a pile for carrying vertical load.

Simple equipment for carrying out static load testing of the piles is also available.

---

### 11.14.2 Driving in restricted headroom

Under bridges etc. the free height between soil level and the structure is often insufficient to allow normal pile threading/pitching. One possibility is to drive the piles in short lengths, butt welded or fish-plated together as driving proceeds, the joints being to the full strength of the section; but, if possible, this should be avoided for reasons of economy. A better way of overcoming the problem is to assemble a panel of piles horizontally on the ground, the length of the piles being less than the headroom. The panels should be bolted to temporary walings and moved into position. In any case, the headroom may be increased by the excavation of a trench along the proposed line of the piling. Driving is commenced using a double-acting hammer mounted in a cradle suspended at the side of the pile. As soon as sufficient headroom is available, the hammer should be moved to the normal driving position.

# Installation of sheet piles

## 11.15 Extracting

### 11.15.1 General

When piling is intended to serve only as temporary protection for permanent construction work, it can be extracted for re-use by means of suitable extractors which are usually of the vibratory or jacking type.

For an evaluation of the required pulling force, the previous establishment of a driving record for each pile is very useful. This identifies the piles with the lowest resistance, thus defining the most advantageous starting-point for the extraction work. If driving records for the piles are not available, then the first pile to be extracted should be selected with care. Piles near the centre of a wall should be tried until one pile begins to move. If difficulty is experienced, then a few driving blows may be used to loosen a pile. It may also be necessary to reinforce the head of the piles to aid the successful extraction of the initial pile. Accurate driving of the piles in the soil makes extraction easier.

When designing temporary works and selecting the pile section it may be necessary to increase the section to ensure good driveability and minimise damage to the piles. The commercial success of the operation will depend on the quantity of piles recovered with minimal damage

---

### 11.15.2 Extraction by vibrator

Vibrators and extractors of various sizes are available. They loosen the pile from its initial position, so that it moves with the help of the pulling force of the crane. The limit values of the extractors and crane loads given by the manufacturer must be respected. The connection between pile and the extractor should allow for the maximum pulling force of the crane and extractor.

---

### 11.15.3 Extraction by silent press

Silent presses are excellent for extracting piles in sensitive locations, the extraction process being the reverse of driving. Piles that have been pre-treated with sealants are ideal to extract with the silent presser.

## Installation of sheet piles

### 11.15.4 Extraction using the sustainable base extractor

This powerful tool can be used to clear steel pile foundations from a site and also extract long heavy sheet piles.

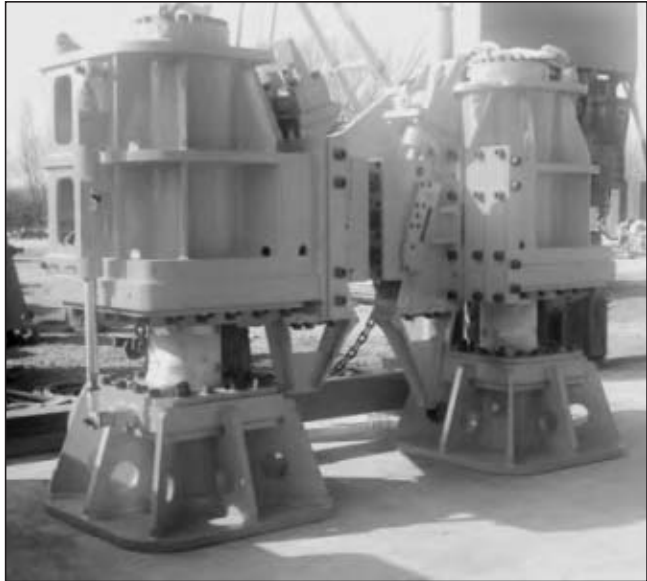

A maximum pulling force of approximately 400t is currently available with this machine

It requires at least 1.5m working space either side of the pile line and a firm hard-standing to work from. The machine needs to be positioned at the open end of a pile line and work backwards. A heavy crane is needed to move the extractor to different positions.

---

### 11.16 Installing Combined HZ or high modulus walls

High Modulus walls may consist of special rolled King piles or fabricated box piles combined with standard sheet piles. The King or Primary piles are structural elements which are connected by intermediate secondary sheet piles.

One of the most important and efficient systems that provides a “straight” face suitable for Marine projects and deep berths is the HZ system. The HZ beams are rolled specially up to lengths of 33m. These major sheet pile walls should only be installed by leading experienced contractors equipped with heavy plant suitable for offshore conditions where appropriate.

## Installation of sheet piles

Techniques for successful installation involve panel driving methods but involve installing the primary elements before secondary elements in the panels. It is essential that the primary elements are established accurately before joining together with the shorter secondary piles. In this respect special temporary works in the form of guide waling trusses have proven to be the best method for setting out, supporting and commencing the installation of the primary piles.

The procedure adopted to drive the piles is different to that of installing standard sheet piling and different hammers need to be used for the primary and secondary piles. Details of the procedures and hints for suitable techniques are described in more detail in the ArcelorMittal publication "HZ steel wall system ref 1.4.01".

The HZ system combines all hot rolled products mechanically jointed together and is the best system available for joint integrity when installed correctly.

Other systems may combine fabricated primary elements such as tubes with interlocks welded on either side or box piles welded together. In such cases all welding of interlocks and splicing together to form the correct length needs to be executed in accordance with relevant codes to high standards of workmanship and testing.

In all cases the secondary elements must consist of at least two suitable sheet piles (and no more than three) with interlocks capable of withstanding additional stresses from the action of forcing the sheets between stiff primary elements. Pairs of AZ piles which have a Larssen type lock are considered the most suitable for secondary piles in combined walls.

Declutching in dense fine sands may be avoided by filling the interlocks with bituminous sealant prior to driving.



ArcelorMittal

- 1** Product information
- 2** Sealants
- 3** Durability
- 4** Earth and water pressure
- 5** Design of sheet pile structures
- 6** Retaining walls
- 7** Cofferdams
- 8** Charts for retaining walls
- 9** Circular cell construction design & installation
- 10** Bearing piles and axially loaded sheet piles
- 11** Installation of sheet piles
- 12** Noise and vibration from piling operations
- 13** Useful information

**12**

Noise and  
vibration

# Noise and vibration from piling operations

Contents	Page
<b>12.1 Introduction</b>	1
<b>12.2 Regulatory guidance</b>	2
<b>12.3 Vibration from piling operations</b>	2
12.3.1 The effects of vibration	2
12.3.2 Reducing pile driving vibrations	3
12.3.3 Good practice	3
12.3.4 Vibration level estimation	4
12.3.4.1 Pile presses	4
12.3.4.2 Vibrodrivers	4
12.3.4.3 Impact hammers	5
12.3.5 Estimate limitations	6
12.3.6 Significance of vibration	7
12.3.6.1 Disturbance to people	7
12.3.6.2 Damage to structures	8
12.3.6.3 Compaction and settlement	9
12.3.6.4 Destabilisation of slopes	10
<b>12.4 Noise from piling operations</b>	10
12.4.1 The effects of noise	10
12.4.2 Reducing pile driving noise	11
12.4.3 Good practice	11
12.4.4 Noise level estimation	11
12.4.5 Significance of noise	14

# Noise and vibration from piling operations



# Noise and vibration from piling operations

## 12.1 Introduction

For many years piling and driven piling in particular, has been perceived as one of the most environmentally disruptive activities on a construction site. This perception was justified until recent developments in pile installation technology. The range of methods now available ensures cost effective pile installation with appropriate control of noise and vibration.

When heavy construction is to be carried out close to houses, offices, laboratories or historic buildings, careful planning is required to ensure that the work proceeds at an appropriate rate, in a manner that will minimise disruption to the area. The physical presence of a construction site in a community will cause a degree of disruption to normal activities, but choosing the most appropriate technology for each activity will ensure that the construction period is minimised and that the work proceeds within acceptable levels of noise and vibration. This will benefit both local residents and also site workers.

Modern piling techniques can enable noise and vibration to be eliminated from the installation process for steel piles. When ground conditions are appropriate, hydraulic pile pressing technology enables piles to be driven almost silently and without causing any noticeable vibrations. This technology gives engineers the opportunity to use steel piling in areas where this type of construction would previously have been unthinkable. Sheet piling can now be considered as a first choice material for sites where environmental disturbance will not be tolerated, such as adjacent to hospitals, within urban areas, alongside sensitive cable or pipeline installations or near delicate computer facilities.

Vibrodrivers, which offer the fastest rate of installation of any pile driving system in granular soils, cause more vibration than pile presses, but are less disruptive than impact hammers. Engineering advances have given operators the ability to vary the frequency and amplitude of vibrations generated by the machine, so that the system can be tuned to suit the ground conditions. This technology has also eliminated the severe vibrations generated close to the pile when the vibrodriver passes through the resonant frequency of the surrounding ground and buildings during run up and run down.

Impact hammers cause higher levels of noise and vibration than other types of pile driver, but will drive piles into any type of soil and may be the only method available for driving into stiff, cohesive soils or soft rock. The operation of this type of hammer has changed with advances in technology and over the past half century, steam has given way to diesel power, which in turn has been replaced by hydraulic actuation. As a result, modern hydraulic drop hammers are much less environmentally damaging than their predecessors. Further reductions in noise levels can be achieved by the use of shroudings to enclose the area where noise is generated.



## Noise and vibration from piling operations

Before choosing the pile driving method to use, you need to consider the circumstances at your site and the levels of noise and vibration that will be acceptable. Not every site demands silent and vibration-free pile installation, and cost and time savings may be achieved if it is acceptable to adopt a less environmentally-sensitive method of installation. The opportunity to adopt combinations of driving method should not be overlooked, as it may be feasible to press piles during more sensitive times of day, completing the final stage of the drive using an impact hammer.

---

### 12.2 Regulatory guidance

Local Authorities may stipulate and impose their restrictions prior to and during piling operations. To avoid this situation, a preferable approach is to arrange prior consent. Discussion with the Local Authority can lead to a 'Consent to Work' agreement, usually embodying the 'best practicable means' for the work.

The original Eurocode 3 (1998), Steel Structures, Part 5: Piling, [ENV 1993:5 (1998)] made specific recommendations on vibration limits for human tolerance and on thresholds for minor damage to buildings. Please note that this information has been removed from the latest revision of EN1993:5 as it is considered by CEN to be more appropriate in an execution standard. The information has not yet been relocated but the authors feel it is of value to piling engineers and is included here.

Although present British Standards do not give rigid limits on levels of vibration or noise, there are three British Standards that give helpful guidance on these issues:

BS 5228 parts 1 & 4, (1997/1992),

'Noise control on construction and open sites'.

BS 6472 (1992),

'Guide to evaluation of human exposure to vibration in buildings'.

BS 7385 part 2 (1993)

'Evaluation and measurement for vibrations in buildings'.

---

### 12.3 Vibration from piling operations

#### 12.3.1 The effects of vibration

Pile driving using an impact hammer or vibro-driver generates ground vibrations, which are greatest close to the pile.

Humans are very sensitive to ground vibrations, and it should be noted that even minor vibrations may attract complaints from people living or working in the area.

Reports of damage to buildings caused by piling vibrations are rare. You will find guide values to help avoid cosmetic damage in ENV 1993:5 (1998), BS5228 pt 4 and BS7385 pt 2.

Heavy ground vibrations may also disturb soils. Piling vibrations may de-stabilise slopes or lead to compaction settlements of very loose saturated granular soils.

# Noise and vibration from piling operations

## 12.3.2 Reducing pile driving vibrations

Potential problems caused by ground vibrations can be alleviated or eliminated by:

- Pre-contract planning, to obtain a Consent to Work Agreement,
- Selecting the most appropriate pile driver and working method,
- Forewarning residents of the forthcoming work and its duration and assuring them of the very low risk of damage to property,
- Carrying out property surveys, before and after your work.

The selection of an appropriate pile driving system is essential if ground vibrations are to be controlled.

In highly-sensitive locations, very close to existing buildings or near to historic structures, a pile pressing rig may be used. Pile pressing systems are vibration-free, and are now effective in most soils.

For driving into stiff, cohesive soils, an impact hammer may be needed. Modern hydraulic drop hammers are efficient and controllable. The combination of a controllable hammer and vibration monitoring can help to meet vibration limits, while achieving effective pile installation.

---

**12.3.3 Good practice** Excessive ground vibrations can also be avoided by following good piling practice. Particular care should be taken to ensure that the pile is maintained in a vertical position by using well-designed guide frames or a leader. An appropriate size of hammer should be selected, and the hammer should strike the centroid of the pile along its axis. Equipment should be in good condition and piling should be stopped if any head deformation occurs, until the problem is identified.

Hammering against any obstructions will cause excessive vibrations. Specialist measures to overcome this problem include:

- Excavation to a depth of 2-3m to avoid old concrete, brick or timber foundations, or buried services in a previously-developed site.
- Water jetting of dense sands
- Cut-off trenches (although the excavation may cause an unacceptable risk of ground disturbance).
- Pre-augering to break up hard soils for easy pile driving.

With careful planning and by adopting sensitive piling techniques, appropriate to your project and the conditions of the site, it is possible to minimise the vibrations caused by your operations in the surrounding area.

## Noise and vibration from piling operations

### 12.3.4 Vibration level estimation

During the past 20 years, a large number of ground vibrations have been recorded on piling sites by interested parties from industry, universities and other research establishments. This body of knowledge has been formulated into simple empirical equations for estimation of probable levels of peak particle velocity (ppv) caused by various piling operations and conditions, and for probable upper bound levels (ENV 1993:5 1998; Attewell et al, 1992; Hiller & Crabb, 2000).

The equations generally take the form of

$$v = \frac{C \sqrt{W}}{r}$$

where  $v$  is the estimated ppv in mm/s;  $C$  is a parameter related to soil type and hammer;  $W$  is the hammer energy per blow or per cycle (Joules/blow, or Joules/cycle for vibrodrivers);  $r$  is the horizontal distance from the piling operation to the point of interest (m). However, it should be emphasised that, while this equation gives a useful indication of vibrations, it is not an exact predictor.

Table 12.3.4 The recommendations in ENV 1993:5 (1998) for  $C$  values.

Driving method	Ground conditions	C
Impact	Very stiff cohesive soils, dense granular media, rock, fill with large solid obstructions	1.0
	Stiff cohesive soils, medium dense granular media, compact fill	0.75
	Soft cohesive soils, loose granular media, loose fill, organic soils	0.5
Vibratory	All soil conditions	0.7

**12.3.4.1 Pile presses** None of the following calculations are necessary if a pile pressing rig is used to install steel sheet piling, since it causes negligible levels of vibration provided pile verticality is maintained.

**12.3.4.2 Vibrodrivers** For vibrodrivers, the calculation may be taken as power rating divided by frequency, from the manufacturer's information, with power in Watts (1 Watt = 1N.m/s) and frequency in cycles/s, so the resulting unit is N.m/cycle, i.e. J/cycle. The choice of parameter  $C$  depends upon the standard used. ENV 1993:5 recommends  $C = 0.7$  while BS5228 recommends a value of 1.0. The former is preferred.

Some site records have shown high values of vibrations at low frequencies during run-up and run-down, and 'non-resonant' vibrodrivers have been developed to avoid this behaviour, which

## Noise and vibration from piling operations

has been attributed to a resonant form of ground response. While there is some support for this explanation, opinions have been voiced by Hiller (2000) and by Holeyman (2000) that the level of vibrations is less a function of hammer energy per cycle, than of the soil resistance to driving.

At the present state of knowledge, it seems appropriate to follow the ENV 1993:5 procedure in which energy/cycle is used within the basic empirical equation.

Example 1: A vibrodriver driving and extracting sheet piles in medium dense sands and gravels. The vibrodriver has a power rating of 120kW and operating frequency of 38Hz. Calculate ppv's at distances of 2m and 10m.

The energy/cycle

$$= 120000(\text{Nm/s}) / 38 \text{ (cycles/s, i.e. Hz),}$$

$$= 3160 \text{ Joules/cycle}$$

Take  $C=0.7$  (in accordance with Eurocode 3), and for  $r=2\text{m}$ ,

$$v = \frac{0.7 \times \sqrt{3160}}{2} = 20\text{mm/s}$$

and at  $r=10\text{m}$ ,  $v = 4.0\text{mm/s}$

The development of high frequency vibro-drivers with variable eccentric moment has resulted in a very effective driving system for sensitive areas. Varying the energy input and the frequency allows the system to be tailored to suit conditions on site.

---

### 12.3.4.3 Impact hammers

Calculation of impact hammer energy,  $W$ , is by loss of potential energy in free fall for a drop hammer (mass x gravitational acceleration x drop height, or, m.g.h.). For a double acting device, energy = m.g.h. + stored energy, as quoted in the manufacturer's literature.

Units are Joules per blow, where  $1\text{J} = 1\text{N.m}$ .

Example 2: A hydraulic drop hammer driving well-guided steel H piles in medium clays. The hammer element weighs three tonnes, and is falling through 0.8m. Estimate ppv's,  $v$ , at distances,  $r$ , from the pile of 2m, 5m and 20m.

Hammer energy

$$= \text{mass} \times \text{gravitational acceleration} \times \text{drop (m.g.h.)}$$

$$= 3000\text{kg} \times 9.8\text{m/s}^2 \times 0.8\text{m}$$

$$= 23520 \text{ Joules (or N.m)}$$

Take  $C$  to be 0.75, then

$$\text{For } r=2\text{m } v = 57\text{mm/s}$$

$$\text{For } r=5\text{m } v = 23\text{mm/s}$$

$$\text{and for } r=20\text{m } v = 6\text{mm/s}$$

## Noise and vibration from piling operations

### 12.3.5 Estimate limitations

While the above methods give reasonable estimates of probable vibration levels, it must be recognised that a number of factors can cause higher than expected vibration levels, such as obstructions, mechanical wear or failure, poor support, and pseudo-resonance of the soil during run-up and run-down. Thus the estimation methods can be used to give a good indication of magnitude, but not as an exact and reliable prediction. They are appropriate for the basis of a Consent to Work Agreement, or for setting realistic permissible limits to piling vibrations.

In assessing driveability, selecting the size of piling hammer that achieves a steady rate of penetration is important. This often leads to a minimum vibration disturbance, taking account of both intensity and duration.

Before commencing the main works, predicted vibrations can be checked by driving a test pile using the proposed equipment. Some examples of records of observed ground vibrations are given in Table 12.3.5. It should be emphasised that there is considerable variation in vibrations generated, even from a single pile being driven by a single hammer, due to changing toe depth, soil strata, accuracy of blow, upstand of the pile, guide system, clutch of adjacent pile, meeting of obstructions, and driver efficiency. Both the curves and the equation tend to overestimate ppv's very close to the pile.

Table 12.3.5 Examples of ppv's recorded on sites.

Hammer and pile	distances from pile, m	radial ppv, mm/s	transverse ppv, mm/s	vertical ppv, mm/s	resultant ppv, mm/s
Air, 600N, U pile z=1600 cm <sup>3</sup> /m	2	8.6	7.2	17.0	18.0
	8	5.6	2.9	8.2	8.4
	22	3.8	2.7	5.1	6.1
BSP 357, (3 <sup>1</sup> ) Z pile z=2300 cm <sup>3</sup> /m	2	10.6	7.7	22	25
	5	4.5	5.0	4.8	6.1
	18	0.5	0.6	0.9	0.9
BSP 357, (5 <sup>1</sup> ) H section	4	10	4.5	25.9	26.9
	17	13.8	2.3	11.0	15.0
	37	3.3	1.0	1.2	3.5
Vibro MS25H Z pile z=1700 cm <sup>3</sup> /m	2	22	28	6.8	34
	5	2.8	2.6	8.2	9.0
	16	1.5	1.7	2.3	2.5

# Noise and vibration from piling operations

## 12.3.6 Significance of vibration

There are at least four consequences arising from ground vibrations during piling, which may require consideration.

They include:

- disturbance to people
- risk of cosmetic or structural damage to buildings
- compaction settlement of loose granular soils
- destabilization of slopes or excavations.

Guidance on limits for the first two issues is provided by Eurocode 3: Part 5 (1998) and British Standards, especially BS5228:part 4 (1992), BS 6472 (1992) and, BS 7385:part 2 (1993).

---

### 12.3.6.1 Disturbance to people

Ground vibrations may cause reactions ranging from “just perceptible”, through “concern” to “alarm” and “discomfort”. The levels of vibration from piling are not such as to cause risk to health, (as may occur through prolonged use of a pneumatic hand-held breaker). The subjective response varies widely, and is a function of situation, information, time of day and duration.

Table 12.3.6.1 Human tolerance to vibrations from Eurocode 3 :Part 5.

Duration D in days	D ≥ 1 day	6 d ≤ D ≤ 26 d	26 d ≤ D ≤ 78 d
Level I	1.5	1.3	1.0
Level II	3.0	2.3	1.5
Level III	4.5	3.8	2.0

Notes:

- 1 Level I Below this level vibration is likely to be accepted  
 Level II Below this level vibration is likely to be accepted, with advanced warning.  
 Level III Above level III vibration is likely to be unacceptable
- 2 The above values relate to 4 hours of vibrations per working day.

For different durations of vibrations, 
$$V_{tc} = \frac{V_4}{2} \sqrt{(T_r/T_c)}$$

where  $T_r=16$  hours and  $T_c$  is the exposure time in hours per day.

- 3 These limiting values apply for all environments other than hospitals, precision laboratories and libraries, in which vibrations of up to 0.15 mm/s should be acceptable

---

Humans are very sensitive to vibrations and the threshold of perception is of the order of 0.2mm/s of ppv, in the appropriate range of frequency of 8Hz to 80Hz. BS6472 gives base curves of vibrations for minimal adverse comment and also vibration dose values (VDV's) at which complaints are probable, (VDV's include consideration of the duration of the disturbance). The vibration levels deduced from these recommendations are low. It should be

## Noise and vibration from piling operations

noted that the standards provide guidance on prediction of probability of adverse comment, but they do not impose a legal requirement of adherence to any particular vibration threshold level. This responsibility rests with the Local Authority.

For normal piling operations, the human tolerance to vibration should be assessed by reference to the table in Eurocode 3 :Part 5 reproduced in Table 12.3.6.1. The level of background vibrations should not be overlooked when considering reasonable values.

### 12.3.6.2 Damage to structures

There is little evidence to suggest that vibrations from piling alone cause even cosmetic damage (minor cracking) to buildings in good repair (BRE,1983, Malam, 1992, Selby, 1991). However, buildings in poor condition may offer less resistance to minor damage. Where property owners are concerned about possible damage to their buildings, before-and-after surveys should be conducted to record any additional defects in the building. BS5228 : pt 4 (1992), and BS7385 : pt 2 (1993), both give helpful but conflicting guidance on ppv's above which cosmetic damage might occur. Impact piling causes intermittent ground vibrations, and should therefore be considered as transient vibrations, while ground vibrations during vibrodriving are continuous. The recommended levels for continuous vibrations are generally taken as 50 per cent of those for transient values.

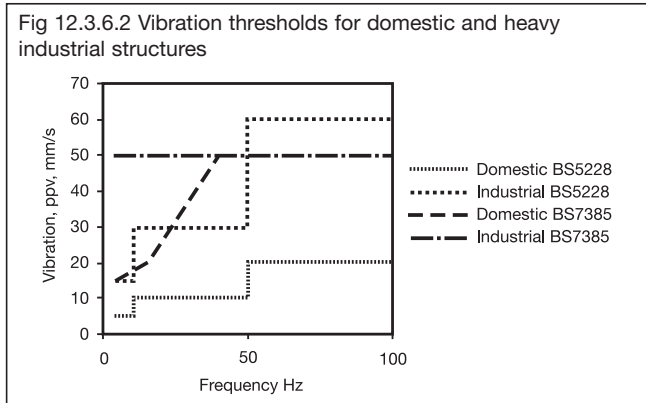

The recommended threshold limits for intermittent vibrations acting on residential and industrial buildings from the two standards are summarised in Figure 12.3.6.2. BS7385 generally gives more generous limits. BS5228 recommends that the limits be reduced by up to 50 per cent for buildings showing significant defects. Where vibrations exceed four times the threshold values, then structural damage may occur.

## Noise and vibration from piling operations

There is considerable lack of agreement among national codes as to the advisory threshold ppv's for avoidance of cosmetic damage. The structural form of the building should also be considered when setting limits on vibrations impinging upon buildings. A building with a stiff ground-bearing raft, or stiff shear walls, will reduce the ground waves substantially, through dynamic soil-structure interaction. However, a slender frame will follow the dynamic disturbance of the passing wave. In addition, slender suspended floors may show dynamic magnification of the disturbance if frequencies are similar. BS5228 also recommends limiting ppv's in masonry retaining walls to 10mm/s at the base and 40mm/s at the crest, and gives general recommendations for consideration of stability. The BS5228 recommended limits for vibrations impinging on buried services are 30mm/s intermittent and 15mm/s continuous, but with reductions of 20-50 per cent for elderly brickwork sewers.

The recommendations from Eurocode 3 :Part 5, reproduced in Table 12.3.6.2 are generally more conservative, but should result in the low probability of even minor damage.

Table 12.3.6.2 Tolerance of buildings to vibration, Eurocode 3: Part5.

Type of property	Peak particle velocity mm/s	
	Continuous vibration	Transient vibrations
Ruins, buildings of architectural merit	2	4
Residential	5	10
Light commercial	10	20
Heavy industrial	15	30
Buried services	25	40

### 12.3.6.3 Compaction and settlement

BS7385-2 (1993) notes the possibility of compaction of loose granular soils by vibration, which may lead to problems of differential settlement.

Recent work (Bement & Selby, 1997) has shown that loose granular saturated soils may compact during prolonged vibration in excess of some 0.2 to 0.4g of particle acceleration, but to limited depths below surface of no more than 10m. Compaction is unlikely at more than about 5m distant from a piling operation unless widespread liquefaction occurs.

The situations most likely to cause compaction settlement include extraction of temporary sheet piling directly contiguous to a new slab or wall when vibrations exceed 1g, and the vibration of hydraulic fills.



## Noise and vibration from piling operations

### 12.3.6.4 Destabilisation of slopes

There is little guidance available on this subject, although a simple analysis of granular soil slide, Fig. 12.3.6.4, gives a factor of safety against sliding of  $F = (\text{resistance to sliding})/(\text{downslope force})$  or  $F = \tan \phi / \tan \beta$ , where  $\phi$  is the soil friction angle and  $\beta$  is the slope angle. If a transient vertical acceleration is applied, this increases both downslope force and resistance by the same fraction, so vertical vibration has no effect. If, however, a horizontal acceleration applies outward from the slope, then the downslope force is increased by mass  $\times$  acceleration, and the factor of safety is reduced.

Example:

Consider a mass of soil having weight  $W$ .

Assume horizontal acceleration =  $0.1g$ , so horizontal force =  $0.1W$ .

Downslope force =  $W \sin \beta + 0.1 W \cos \beta$ .

If the slope angle is  $20^\circ$ , then the downslope force increases from  $0.34 W$  to  $0.43 W$ , or an increase of some 27 per cent.

If  $\phi = 35^\circ$ , the factor of safety is reduced from 1.9 to 1.5.

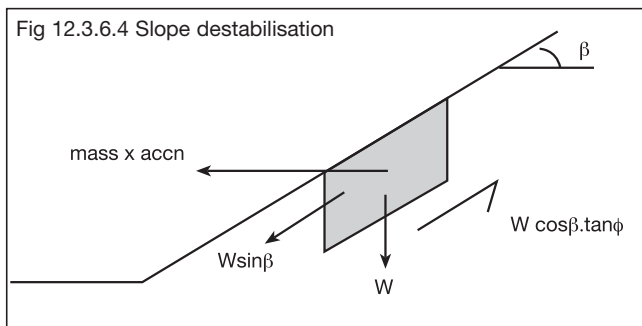

## 12.4 Noise from piling operations

### 12.4.1 The effects of noise

Noise, or unwanted sound, may be generated during pile driving in the form of sharp repetitive pulses, or a more uniform drone. Noise in excess of the current threshold level for the workplace requires the contractor to protect the hearing of workers exposed to it. Any additional noise imposed upon the public should be minimised, to avoid disturbance and the risk of damage to hearing.

## Noise and vibration from piling operations

### 12.4.2 Reducing pile driving noise

Pile pressing systems generate negligible noise at the pile, and only low-level background noise from the diesel power pack, which can be located away from noise-sensitive areas of the site.

Modern, enclosed hydraulic drop hammers and smooth-running vibro-drivers are now carefully designed to limit noise, and are much quieter than older models. By selecting the most appropriate hammer type and head packing, you can reduce noise significantly.

---

**12.4.3 Good practice** If using vibro-drivers or impact hammers, following a few straightforward guidelines can help to reduce noise levels.

Noise reduces with distance, so locating noisy plant well away from the public and site workers, where possible, will limit the noise disturbance. The impact of steel upon steel is particularly noisy, so a timber or plastic dolly can be used to cut noise levels. It may also be possible to muffle some hammers in an enclosure.

A partly-embedded pile may ring when it is struck. To help prevent this, timber wedges can be used between the pile and guide frame. Absorbent drapes or packs can also be used.

Noise screens can be constructed between the noise source and any sensitive properties or locations. Solid obstructions such as stout timber fences, earth mounds or dense trees may reduce noise by between 5dB and 10dB.

---

### 12.4.4 Noise level estimation

Noise levels experienced in the vicinity of pile driving are a function of the noise power level,  $L_w$ , which is the air pressure fluctuation at the surface of the equipment (hammer or pile), expressed in dB, and the distance,  $R$ , from the source. A convenient way to estimate an equivalent continuous A-weighted sound level over the working day,  $L_{aeq}$ , is by the equation

$$L_{aeq} = L_w - 20 \log(R) - 8. \text{ dB(A)}$$

Sound power levels for specific plant items should be obtained from the supplier but impact hammers driving steel sheet or H piles may typically operate in the range 120 to 135 dB. Modern shrouded hammers – incorporating a noise-reducing enclosure – may be as much as 10 dB quieter. Pile pressing systems produce negligible sound levels, with only the power pack generating low-level noise.

## Noise and vibration from piling operations

Table 12.4.4a Examples of recorded noise levels around piling rigs driving steel sheet piling.

Plant type	Sound power level, $L_w$ dB	Primary observed noise, $L_{eq}$ dB	$L_{eq}$ at 10m dB	$L_{eq}$ at 30m dB
<b>Hydraulic impact hammers</b>				
HPH1200/2400		97@4m	90	80
HH 357-9 BSP			95	85
HH1.5DA		95@12m	97	87
<b>Vibrodrivers</b>				
PTC City 15HF1		93@3m	73	61
ICE216		91@7m	87	74
ICE416		80@7m	77	65
ICE 815		97@7m	94	83
<b>Japanese type Silent Piler</b>				
		75@1m	55	45
<b>Power Pack</b>				
		90@1m	70	60
<b>NCK crane tick-over</b>				
		71@2m	57	47
<b>NCK crane, revving</b>				
		83@2m	69	59
<b>Examples from BS5228</b>				
Double acting air hammer (5.6kNm)	134		106	96
Enclosed drop (3 t)	98		70	60
Hydraulic drop (60kNm)	121		93	83

Here are some calculations of noise levels:

Example 1:

Impact hammer driving steel sheet piles with  $L_w = 135$ dB.

Calculate  $L_{aeq}$  values at 2m, 10m, 20m and 50m.

From  $L_{aeq} = L_w - 20 \log(R) - 8$  dB(A)

$L_{aeq} = 135 - 20 \log(R) - 8$ .

For  $R = 2$ m,  $L_{aeq} = 135 - 6 - 8 = 121$  dB(A)

For  $R = 10$ m,  $L_{aeq} = 107$ dB(A)

For  $R = 20$ m  $L_{aeq} = 101$ dB(A)

(Note, for doubled distance, a 6dB reduction occurs)

For  $R = 50$ m  $L_{aeq} = 93$ dB(A)

## Noise and vibration from piling operations

Often a piling operation will run for some 10-50 per cent of the working day, which reduces the  $L_{aeq}$  by a small amount. (Note that because of the logarithmic relation, a reduction in duration is accompanied by a much smaller reduction in  $L_{aeq}$ ). This effect can be calculated simply, where  $L_1$  is the sound acting over time  $t_1$  compared with working day duration  $T$ , from:

$$L_{aeq} = 10 \cdot \log \left\{ \frac{1}{T} [t_1 \cdot 10^{L_1/10}] \right\}$$

Example 2: If the noise level of  $L_{aeq} = 107\text{dB(A)}$  at  $R=10\text{m}$ , from the previous example is now restricted to 50 per cent of the working day, then the newly-calculated  $L_{aeq}$  becomes

$$L_{aeq} = 10 \cdot \log \{ 0.5 \times 10^{107/10} \} = 104 \text{ dB(A)}$$

This is a 3dB reduction, which is just perceptible.

The next condition to consider is when several operations occur during the day that generate different levels of noise,  $L_1, L_2, L_3$ , each of which lasts for time  $t_1, t_2, t_3$ .

These can be evaluated from an expanded form of the previous equation as

$$L_{aeq} = 10 \cdot \log \left\{ \frac{1}{T} [t_1 \cdot 10^{L_1/10} + t_2 \cdot 10^{L_2/10} + t_3 \cdot 10^{L_3/10}] \right\}$$

Example 3: Let us assume that three noisy operations occur, for limited periods of the day illustrated in table 12.4.4b below.

Table 12.4.4b Cumulative noise sources.

Activity	Lw dB	On time	Laeq at 10m for t =100%*	Laeq for each alone	Cumulative Laeq
1	130	20%	102	95	97
2	126	30%	93	93	
3	120	40%	92	92	

\* calculated from earlier equation.

The calculation for the cumulative  $L_{aeq}$  comes from the above equation as:

$$L_{aeq} = 10 \cdot \text{Log} \{ [0.2 \times 10^{102/10} + 0.3 \times 10^{98/10} + 0.4 \times 10^{92/10}] \}$$

i.e.  $L_{aeq} = 10 \cdot \text{Log} \{ 0.2 \times \text{inv.log} (10.2) + 0.3 \times \text{inv.log} (9.8) + 0.4 \times \text{inv.log} (9.2) \} = 97 \text{ dB}$ , as the cumulative equivalent day-long noise level.

Example 4: The addition of two noise sources, acting concurrently for the full working day is a simple calculation:

$$\text{e.g. } 95\text{dB and } 93\text{dB: } L_{aeq} = 10 \log [10^{95/10} + 10^{93/10}] = 97.1\text{dB.}$$

This is a mere 2.1dB increase above the larger signal.

## Noise and vibration from piling operations

### 12.4.5 Significance of noise

The two areas of concern about noise are the health and safety of operators, and annoyance to the public. Prolonged exposure to noise causes hearing impairment. Exposure to extreme noise causes instantaneous hearing damage. Employers are normally expected to assess noise levels, and to respond to different action levels as follows:

- At the first action level of 85dB (of daily personal noise exposure,  $L_{aeq}$ ): to provide information about hearing risk and to provide protection on request.
- At the second action level of 90dB: to control exposure to noise by limiting noise at source, requiring ear protection to be worn, limiting people's time of exposure. Noisy areas should have the hat and ear muff signs displayed.
- At the peak action level of 140 dB (of a single loud noise): to prevent noise exposure. Such noise can cause instant hearing damage.

The employer shall reduce, so far as is reasonably practical, the exposure to noise of the employee. Where necessary, a noise assessment should be carried out by a competent person with respect to:

- Reduction of noise exposure
- Ear protection
- Ear protection zones
- Provision of information to employees.

Current Standards, do not give maximum levels of extraneous noise. Some suggested limits include:

- a maximum  $L_{aeq}$  during the daytime period of 75dB(A) at one metre outside a noise-sensitive building in urban areas, or of 70dB(A) in rural areas.
- Sunday working should be subject to a reduction of 10dB.
- night-time working should not normally be permitted outside residential properties, although 40-50dB(A) may be appropriate.

Normal daytime locations are subject to some level of background noise. If the noise level increases by 3dB then the change is just perceptible. If the noise level increases by 10dB then it is perceived as being twice as loud. An increase of 20dB implies a tenfold increase in pressure.

It is important to measure ambient noise at any sensitive location, and to measure the increase in noise caused by piling operations. An increase in noise level by 10dB is likely to attract some

## Noise and vibration from piling operations

objection. With prior warning, a working agreement might be to limit the increase in noise to some 10 to 20dB(A) above typical ambient conditions. An office environment of 65dB(A) could be expected to tolerate 75dB(A).

As with vibrations, a forewarning of the noise and its duration and intensity will improve people's tolerance of the intrusion. European Community Council Directives are under consideration for noise controls of construction plant.



ArcelorMittal

- 1** Product information
- 2** Sealants
- 3** Durability
- 4** Earth and water pressure
- 5** Design of sheet pile structures
- 6** Retaining walls
- 7** Cofferdams
- 8** Charts for retaining walls
- 9** Circular cell construction design & installation
- 10** Bearing piles and axially loaded sheet piles
- 11** Installation of sheet piles
- 12** Noise and vibration from piling operations
- 13** Useful information

# Useful information

<b>Contents</b>		<b>Page</b>	
	<b>13.1</b>	<b>Discontinued U piles</b>	<b>1</b>
	<b>13.2</b>	<b>Discontinued Z piles</b>	<b>3</b>
	<b>13.3</b>	<b>The metric system</b>	<b>4</b>
	<b>13.4</b>	<b>Conversion factors and constants</b>	<b>5</b>
	<b>13.5</b>	<b>Bending moments in beams</b>	<b>6</b>
	<b>13.6</b>	<b>Properties of shapes</b>	<b>7</b>
	<b>13.7</b>	<b>Mensuration of plane surface</b>	<b>8</b>
	<b>13.8</b>	<b>Mensuration of solids</b>	<b>9</b>
		<b>Acknowledgements</b>	<b>10</b>



# Useful information

## 13.1 Discontinued U piles

The table of values below applies to U piles when interlocked together to form a wall

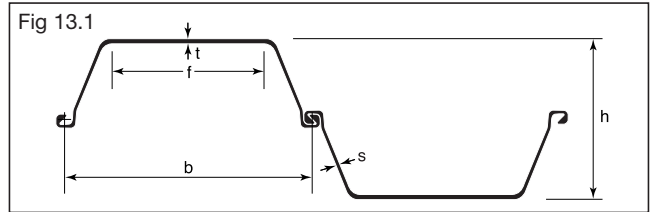

### 13.1.1 ArcelorMittal sections

Table 13.1.1 ArcelorMittal sections

Section	Width b mm	Height h mm	Thickness t mm	Thickness s mm	Flat of pan f mm	C/S area cm <sup>2</sup> /m	Mass Linear kg/m	Wall kg/m <sup>2</sup>	Inertia cm <sup>4</sup> /m	Elastic modulus cm <sup>3</sup> /m	Plastic modulus cm <sup>3</sup> /m
PU 6	600	226	7.5	6.4	335	97	45.6	76	6780	600	697
PU 7	600	226	8.5	7.1	335	106	49.9	83.1	7570	670	779
PU 8	600	280	8.0	8.0	318	116	54.5	90.9	11620	830	983
PU 9	600	280	9.0	8.7	318	125	58.8	98.0	12830	915	1083
PU 11	600	360	8.8	8.4	258	131	61.8	103.0	19760	1095	1336
PU 16	600	380	12.0	9.0	302	159	74.7	124.5	30400	1600	1878
PU 20	600	430	12.4	10.0	307	179	84.3	140.0	43000	2000	2363
PU 25	600	452	14.2	10.0	339	199	93.6	156.0	56490	2500	2899
LS3	500	400	14.1	10.0	232	201	78.9	157.8	40010	2000	2390

### 13.1.2 Corus sections

Table 13.1.2a Corus sections

Section	Width b mm	Height h mm	Thickness t mm	Thickness s mm	Flat of pan f mm	C/S area cm <sup>2</sup> /m	Mass Linear kg/m	Wall kg/m <sup>2</sup>	Inertia cm <sup>4</sup> /m	Elastic modulus cm <sup>3</sup> /m	Plastic modulus cm <sup>3</sup> /m
LX8	600	310	8.2	8.0	250	116	54.6	91.0	12863	830	1017
LX 12	600	310	9.7	8.2	386	136	63.9	106.5	18727	1208	1381
LX12d	600	310	10.0	8.3	386	139	65.3	108.8	19217	1240	1417
LX12d10	600	310	10.0	10.0	382	155	72.9	121.5	19866	1282	1493
LX 16	600	380	10.5	9.0	365	157	74.1	123.5	31184	1641	1899
LX 20	600	430	12.5	9.0	330	177	83.2	138.7	43484	2023	2357
LX 20d	600	450	11.2	9.7	330	179	84.3	140.5	45197	2009	2380
LX 25	600	460	13.5	10.0	351	202	95.0	158.3	57656	2507	2914
LX 25d	600	450	15.0	11.0	326	212	100.0	166.7	57246	2544	2984
LX 32	600	460	19.0	11.0	340	243	114.4	190.7	73802	3209	3703
LX 38	600	460	22.5	14.5	337	298	140.4	234.0	87511	3805	4460

# Useful information

## 13.1.2 Corus sections

Table 13.1.2a Corus sections continued

Section	Width b mm	Height h mm	Thickness t mm	Thickness s mm	Flat of pan f mm	C/S area cm <sup>2</sup> /m	Mass		Inertia cm <sup>4</sup> /m	Elastic modulus cm <sup>3</sup> /m	Plastic modulus cm <sup>3</sup> /m
							Linear kg/m	Wall kg/m <sup>2</sup>			
GSP 2	400	200	10.5	8.6	266	157	49.4	123.5	8756	876	1020
GSP 3	400	250	13.5	8.6	270	191	60.1	150.3	16316	1305	1520
GSP 4	400	340	15.5	9.7	259	242	76.1	190.3	38742	2279	2652
6 (42)	500	450	20.5	14.0	329	339	133.0	266.0	94755	4211	4933
6 (122)	420	440	22.0	14.0	250	371	122.5	291.7	92115	4187	4996
6 (131)	420	440	25.4	14.0	250	396	130.7	311.2	101598	4618	5481
6 (138.7)	420	440	28.6	14.0	251	419	138.3	329.3	110109	5005	5924

Table 13.1.2b Dimensions and properties of interlocked U sections

Section	Width b mm	Height h mm	Thickness t mm	Thickness s mm	Flat of pan f mm	C/S area cm <sup>2</sup> /m	Mass		Combined inertia cm <sup>4</sup> /m	Section modulus cm <sup>3</sup> /m
							Linear kg/m	Wall kg/m <sup>2</sup>		
<b>6W</b>	525	212	7.8	6.4	333	109	44.8	85.3	6508	711
<b>9W</b>	525	260	8.9	6.4	343	124	51.0	97.1	11726	902
<b>12W</b>	525	306	9.0	8.5	343	147	60.4	115.1	18345	1199
<b>16W</b>	525	348	10.5	8.6	341	166	68.3	130.1	27857	1601
<b>20W</b>	525	400	11.3	9.2	333	188	77.3	147.2	40180	2009
<b>25W</b>	525	454	12.1	10.5	317	213	87.9	167.4	56727	2499
<b>32W</b>	525	454	17.0	10.5	317	252	103.6	197.4	70003	3216
<b>1U</b>	400	130	9.4	9.4	302	135	42.4	106.0	3184	489
<b>2</b>	400	200	10.2	7.8	270	156	48.8	122.0	8494	850
<b>2B</b>	400	270	8.6	7.1	248	149	46.7	116.8	13663	1013
<b>2N</b>	400	270	9.4	7.1	248	156	48.8	122.0	14855	1101
<b>3</b>	400	247	14.0	8.9	248	198	62.0	155.0	16839	1360
<b>3B</b>	400	298	13.5	8.9	235	198	62.1	155.2	23910	1602
<b>3/20</b>	508	343	11.7	8.4	330	175	69.6	137.0	28554	1665
<b>4A</b>	400	381	15.7	9.4	219	236	74.0	185.1	45160	2371
<b>4B</b>	420	343	15.5	10.9	257	256	84.5	200.8	39165	2285
<b>4/20</b>	508	381	14.3	9.4	321	207	82.5	162.4	43167	2266
	508	381	15.7	9.4	321	218	86.8	170.9	45924	2414
<b>5</b>	420	343	22.1	11.9	257	303	100.0	237.7	50777	2962
<b>10B/20</b>	508	171	12.7	12.7	273	167	66.4	130.7	6054	706

## Useful information

### 13.2 Discontinued Z piles

#### 13.2.1 ArcelorMittal sections

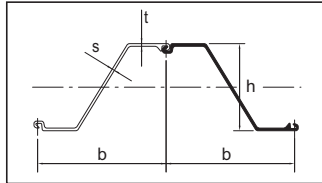

Table 13.2.1 Dimensions and properties of AZ sections

Section	Width	Height	Flange	Web	Mass		Elastic section modulus
	b				Linear	Wall	
	mm	mm	mm	mm	kg/m	kg/m <sup>2</sup>	cm <sup>3</sup> /m
AZ 34	630	459	17.0	13.0	115.5	183.3	3430
AZ 36	630	460	18.0	14.0	122.2	194.0	3600
AZ 38	630	461	19.0	15.0	129.1	204.9	3780
AZ 36-700	700	499	17.0	11.2	118.5	169.3	3600
AZ 38-700	700	500	18.0	12.2	126.2	180.3	3800
AZ 40-700	700	501	19.0	13.2	133.8	191.1	4000

#### 13.2.2 Corus sections

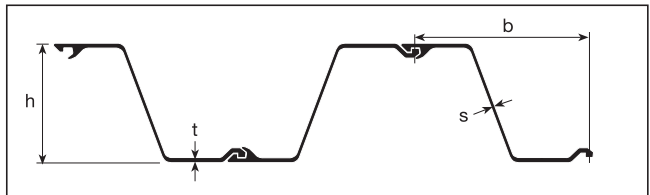

Table 13.2.2 Dimensions and properties of Frodingham sections

Section	Width	Height	Flange	Web	Mass		Elastic section modulus
	b				Linear	Wall	
	mm	mm	mm	mm	kg/m	kg/m <sup>2</sup>	cm <sup>3</sup> /m
1 BXN	476	143	12.7	12.7	63.4	133.2	692
1 N	483	170	9.0	9.0	48.0	99.4	714
2 N	483	235	9.7	8.4	54.8	113.5	1161
3 NA	483	305	9.7	9.5	62.7	129.8	1687
4 N	483	330	14.0	10.4	82.7	171.2	2415
5	426	311	17.1	11.9	101.0	237.1	3171
1A	400	146	6.9	6.9	35.6	89.1	563
1B	400	133	9.5	9.5	42.1	105.3	562
2	400	185	8.1	7.6	47.2	118.0	996
3	400	229	10.7	10.2	61.5	153.8	1538
4	400	273	14.0	11.4	80.1	200.1	2352

# Useful information

## 13.3 The Metric System

### Linear Measure

1 inch	= 25.4mm	1mm	= 0.03937 inch
1 foot	= 0.3048m	1cm	= 0.3937 inch
1 yard	= 0.9144m	1m	= 3.2808 feet or 1.0936 yds
1 mile	= 1.6093km	1km	= 0.6214 mile

### Square Measure

1 sq inch	= 645.16mm <sup>2</sup>	1cm <sup>2</sup>	= 0.155 sq in
1 sq foot	= 0.0929m <sup>2</sup>	1m <sup>2</sup>	= 10.7639 sq ft or 1.196 sq yds
1 sq yard	= 0.8361m <sup>2</sup>	1hectare	= 2.4711 acres
1 acre	= 0.4047 hectare		
1 sq mile	= 259 hectares	1km <sup>2</sup>	= 247.105 acres
	1 hectare = 10,000m <sup>2</sup>		

### Cubic Measurement

1 cubic inch	= 16.387cm <sup>3</sup>	1mm <sup>3</sup>	= 0.000061 cubic in
1 cubic foot	= 0.0283m <sup>3</sup>	1m <sup>3</sup>	= 35.3147 cubic ft or 1.308 cubic yds
1 cubic yard	= 0.7646m <sup>3</sup>		

### Measure of Capacity

1 pint	= 0.568 litre	1litre	= 1.7598 pints or 0.22 gallon
1 gallon	= 4.546 litres		

### Weight

1 oz	= 28.35 kg	1g	= 0.0353 oz
1 pound	= 0.4536 kg	1kg	= 2.2046 lb
1 ton	= 1.016 tonnes or 1016 kg	1tonne	= 0.9842 ton

### Section modulus and inertia

1 inch <sup>3</sup>	= 16.387 cm <sup>3</sup>	1cm <sup>3</sup>	= 0.0610 inch <sup>3</sup>
1 inch <sup>3</sup> /foot	= 53.76 cm <sup>3</sup> /m	1cm <sup>3</sup> /m	= 0.0186 inch <sup>3</sup> /foot
1 inch <sup>4</sup>	= 41.62 cm <sup>4</sup>	1cm <sup>4</sup>	= 0.0240 inch <sup>4</sup>
1 inch <sup>4</sup> /foot	= 136.56 cm <sup>4</sup> /m	1cm <sup>4</sup> /m	= 0.0073 inch <sup>4</sup> /foot

## Useful information

### 13.4 Miscellaneous Conversion Factors and Constants

#### Linear Measure

1 lb (f)	= 4.449N
1 pound per linear foot	= 1.4881 kg per linear m
1 pound per square foot	= 4.883kg per m <sup>2</sup>
0.205 pound per square foot	= 1kg per m <sup>2</sup>
1 ton (f) per linear foot	= 32.69kN per linear m
1000 pound (f) per square foot	= 47.882kN per m <sup>2</sup>
1 ton (f) per square inch	= 15.444N per mm <sup>2</sup>
1 ton (f) per square foot	= 107.25kN per m <sup>2</sup>
100 pound per cubic foot	= 1602kg per m <sup>3</sup>
100 pound (f) per cubic foot	= 15.7kN per m <sup>3</sup>
1 ton (f) foot Bending Moment per foot of wall	= 10kNm Bending Moment per metre of wall
1m head of fresh water	= 1kg per cm <sup>2</sup>
1m head of sea water	= 1.025kg per cm <sup>2</sup>
1m <sup>3</sup> of fresh water	= 1000kg
1m <sup>3</sup> of sea water	= 1025kg
1 radian	= 57.3 degrees
Young's Modulus, steel	= 210kN/mm <sup>2</sup>
Weight of steel	= 7850 kg/m <sup>3</sup>
100 microns	= 0.1mm = 0.004 inch

## Useful information

### 13.5 Bending moments in beams

Type	Total Load W Bending Moment	Maximum	Deflection
<b>Cantilever</b>	Concentrated at End	WL	$\frac{WL^3}{3EI}$
	Uniformly Distributed	$\frac{WL}{2}$	$\frac{WL^3}{8EI}$
<b>Freely Supported</b>	Concentrated at Centre	$\frac{WL}{4}$	$\frac{WL^3}{48EI}$
	Uniformly Distributed	$\frac{WL}{8}$	$\frac{5WL^3}{384EI}$
	Varying Uniformly from zero at one end to a maximum at other end	0.128WL	$0.0131 \frac{WL^3}{EI}$
<b>One end fixed, other end freely supported</b>	Concentrated at Centre	$\frac{3WL}{16}$	$0.00932 \frac{WL^3}{EI}$
	Uniformly Distributed	$\frac{WL}{8}$	$0.0054 \frac{WL^3}{EI}$
<b>Both ends fixed</b>	Concentrated at Centre	$\frac{WL}{8}$	$\frac{WL^3}{192EI}$
	Uniformly Distributed	$\frac{WL}{12}$	$\frac{WL^3}{384EI}$

# Useful information

## 13.6 Properties of shapes

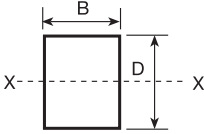
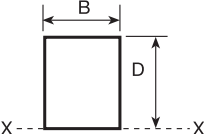
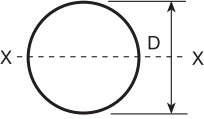
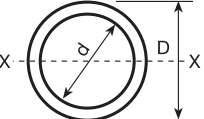
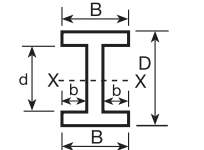
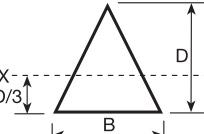
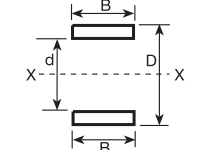
Section	Moment of Inertia $I_{xx}$	Section Modulus $Z_{xx}$	Radius of Gyration $r_{xx}$
	$\frac{BD^3}{12}$	$\frac{BD^2}{6}$	$\frac{D}{\sqrt{12}}$
	$\frac{BD^3}{3}$		
	$\frac{\pi D^4}{64}$	$\frac{\pi D^3}{32}$	$\frac{D}{4}$
	$\frac{\pi(D^4-d^4)}{64}$	$\frac{\pi(D^4-d^4)}{32D}$	$\sqrt{\frac{D^2+d^2}{16}}$
	$\frac{BD^3-2bd^3}{12}$	$\frac{BD^3-2bd^3}{6D}$	$\sqrt{\frac{BD^3-2bd^3}{12(BD-2bd)}}$
	$\frac{BD^3}{36}$	$\frac{BD^2}{24}$	$\frac{D}{\sqrt{18}}$
	$\frac{B(D^3-d^3)}{12}$	$\frac{B(D^3-d^3)}{6D}$	$\sqrt{\frac{D^3-d^3}{12(D-d)}}$

# Useful information

## 13.7 Mensuration of plane surface

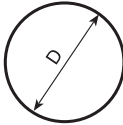
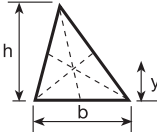
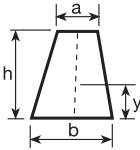
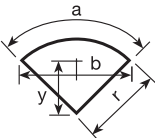
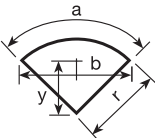
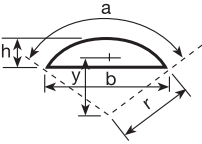
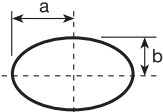
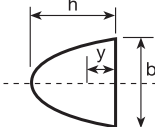
Figure	Descriptor	Area	Distance 'y' to centre of Gravity
	Circle	$\frac{\pi D^2}{4}$	At centre
	Triangle	$\frac{1}{2} bh$	$\frac{h}{3}$ at intersection of median lines
	Trapezoid or Parallelogram	$\frac{1}{2} (a+b) h$	$\frac{h (2a+b)}{3 (a+b)}$
	Circular Arc	-	$\frac{br}{a}$
	Circular Sector	$\frac{1}{2} ar$	$\frac{2br}{3a}$
	Circular Segment	$\frac{ar}{2} - \frac{b}{2} (r-h)$	$\frac{b^3}{12 \times \text{Area}}$
	Ellipse	$\pi ab$	At centre
	Parabolic Segment	$\frac{2}{3} bh$	$\frac{2}{5} h$



# Useful information

## 13.8 Mensuration of solids

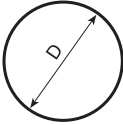
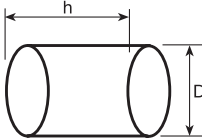
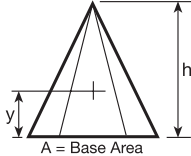
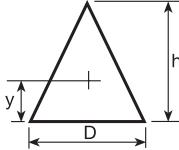
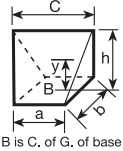
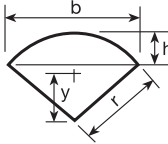
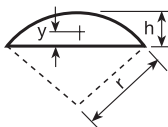
Figure	Descriptor	Surface area A and Volume V	Distance 'y' to centre of Gravity
	Sphere	$A = \pi D^2$ $V = \pi/6 D^3$	At centre
	Cylinder	Curved Surface $A = \pi Dh$ $V = \pi/4 D^2 h$	At centre
 <p>A = Base Area</p>	Pyramid	$V = \frac{1}{3} Ah$	$\frac{h}{4}$ Above base
	Cone	Curved Surface $A = \frac{\pi}{4} D \sqrt{4h^2 + D^2}$ $V = \frac{\pi}{12} D^2 h$	$\frac{h}{4}$ Above base
 <p>B is C, of G. of base</p>	Wedge	$V = \frac{bh}{6} (2a+c)$	$\frac{h(a+c)}{2(2a+c)}$
	Spherical Sector	Total Surface $A = \pi r \times (2h + 1/2b)$ $V = 2 \frac{\pi}{3} r^2 h$	$\frac{3}{4} \left( r - \frac{h}{2} \right)$
	Spherical Segment	Spherical Surface $A = 2\pi rh$ $V = \frac{\pi}{3} h^2 (3r-h)$	$\frac{h(4r-h)}{4(3r-h)}$

## Acknowledgements

ArcelorMittal Commercial RPS would like to express it's thanks to the many people who have been involved in the preparation of this Handbook and for the use of photographs and drawings.

In particular the authors would like to mention

Robin Dawson

Mike Kightley

Eddie Marsh

Dr Alan Selby

who have given us the benefit of their considerable experience.

Care has been taken to ensure that the contents of this publication are accurate at the time of going to press, but ArcelorMittal Commercial RPS S.à.r.l. and its subsidiary companies do not accept responsibility for errors or for information which is found to be misleading. Suggestions for, or descriptions of, the end use or application of products or methods of working are for information only and ArcelorMittal Commercial RPS S.à.r.l. and its subsidiaries accept no liability in respect thereof. Before using products supplied or manufactured by ArcelorMittal Commercial RPS S.à.r.l. the customer should satisfy himself as to their suitability for the intended use.

## **LUXEMBOURG**

**ArcelorMittal Commercial RPS S.à r.l.**

### **Sheet Piling**

66, rue de Luxembourg  
L-4221 Esch-sur-Alzette  
G.D. of Luxembourg

**T** +352 5313 3105

**F** +352 5313 3290

[sheet-piling@arcelormittal.com](mailto:sheet-piling@arcelormittal.com)

[www.arcelormittal.com/sheetpiling](http://www.arcelormittal.com/sheetpiling)

## **UK**

**ArcelorMittal Commercial RPS U.K. Ltd.**

### **Sheet Piling**

Arcelor House | 4 Princes Way  
Solihull | West Midlands B91 3AL  
United Kingdom

**T** +44 (0)870 770 80 57

**F** +44 (0)870 770 80 58

[sheet-piling@arcelormittal.com](mailto:sheet-piling@arcelormittal.com)

[www.arcelormittal.com/sheetpiling](http://www.arcelormittal.com/sheetpiling)