

BASIC PRINCIPLES

of non-contact
temperature measurement

Contents

	Page
Physical principles	4 – 9
Emissivity and temperature measurement	10 – 14
Optics, sighting techniques and electronics	15 – 18
Infrared thermometers and applications	19 – 24
Infrared cameras and applications	25 – 31
Literature	32
Appendix: Glossary	33
Appendix: Emissivity table	34 – 38
Appendix: Selection criteria for IR temperature measurement devices	39

Physical principles

Physical principles

With our eyes we see the world in visible light. Although visible light makes up only a small part of the radiation spectrum, the invisible light covers most of the remaining spectral range. The radiation of invisible light carries much more additional information.

The infrared temperature measurement system

Each body with a temperature above absolute zero ($-273,15\text{ }^{\circ}\text{C} = 0\text{ Kelvin}$) emits electromagnetic radiation from its surface, which is proportional to its intrinsic temperature. A part of this so-called intrinsic radiation is infrared radiation, which can be used to measure a body's temperature. This radiation penetrates the atmosphere. With the help of a lens (input optics) the beams are focused on a detector element, which generates an electrical signal proportional to the radiation. The signal is amplified and, using successive digital signal processing, is transformed into an output signal proportional to the object temperature. The measuring value may be

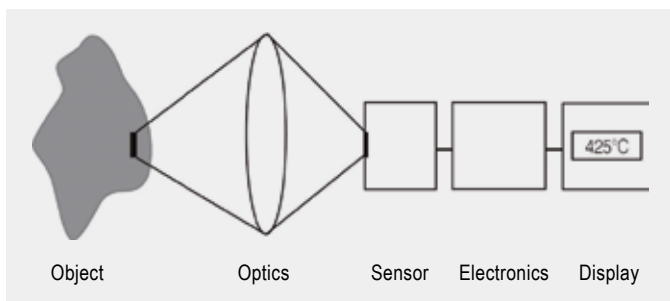

Infrared System

shown in a display or released as analog output signal, which supports an easy connection to control systems of the process management.

The advantages of non-contact temperature measurement are obvious – it supports:

- Temperature measurements of moving or overheated objects and of objects in hazardous surroundings
- Very fast response and exposure times
- Non-interactive measurement, no influence on the measuring object
- Non-destructive measurement
- Measurement point durability, no mechanical wear

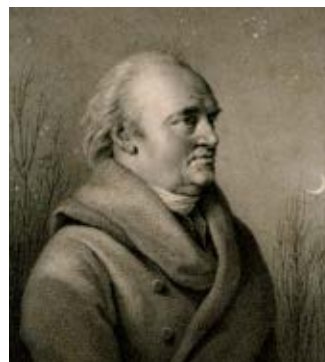

William Herschel (1738–1822)



Discovery of the infrared radiation

Searching for new optical material, William Herschel accidentally discovered the infrared radiation in 1800. He blackened the tip of a sensitive mercury thermometer and used it as measuring system to test the heating properties of different colors of the spectrum, which were directed to a tabletop by having beams of light shine through a glass prism. With this, he tested the heating of different colors of the spectrum. When he moved the thermometer in the dark area beyond the red end of the spectrum, Herschel noticed that the temperature continued to rise. The temperature rose even more in the area behind the red end of the spectrum. He ultimately found the point of maximum temperature far behind the red area. Today this area is called “infrared wavelength area”.

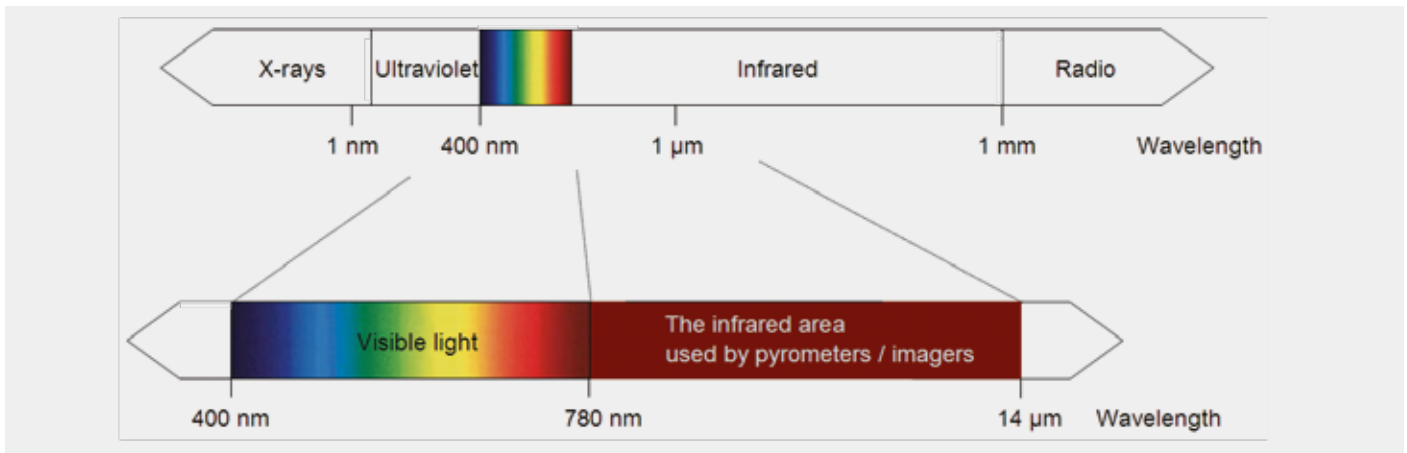

The electromagnetic spectrum with the infrared area used by pyrometers.

The electromagnetic radiation spectrum

In a literal and physical sense, a spectrum is understood as the intensity of a mixture of electromagnetic waves that function as wavelength or frequency. The electromagnetic radiation spectrum covers a wavelength area of about 23 decimal powers and varies from sector to sector in origin, creation and application of the radiation. All types of electromagnetic radiation follow similar principles of diffraction, refraction, reflection and polarization. Their expansion speed corresponds to the light speed under normal conditions: The result of multiplying wavelength with frequency is constant:

$$\lambda \cdot f = c$$

The infrared radiation covers a very limited part in the whole range of the electromagnetic spectrum: It starts at the visible range of about 0.78 μm and ends at wavelengths of approximately 1000 μm.

Wavelengths ranging from 0.7 to 14 μm are important for infrared temperature measurement. Above these wavelengths the energy level is so low, that detectors are not sensitive enough to detect them.

Physical principles

In 1900 Max Planck, Josef Stefan, Ludwig Boltzmann, Wilhelm Wien and Gustav Kirchhoff precisely defined the electromagnetic spectrum and established qualitative and quantitative correlations for describing infrared energy.

The black body

A black body is an abstracted physical body, which absorbs all incoming radiation. It has neither reflective nor transmissive properties.

$$\alpha = \varepsilon = 1 \quad (\alpha \text{ absorption, } \varepsilon \text{ emissivity})$$

A black body radiates the maximum energy possible at each wavelength. The concentration of the radiation does not depend on angles. The black body is the basis for understanding the physical principles of non-contact temperature measurement and for calibrating infrared thermometers.

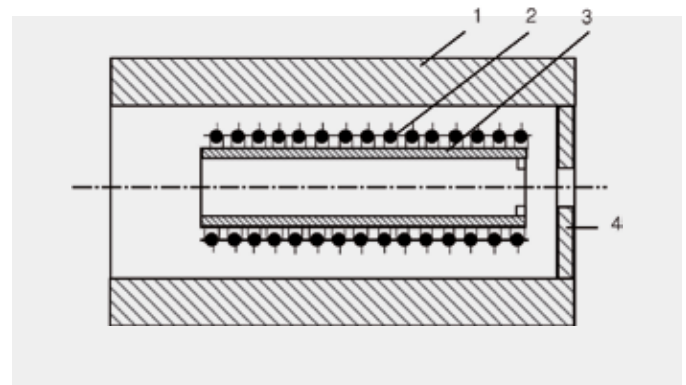

Cross section of a black body:

1 – ceramic conduit, 2 – heating, 3 – conduit made from Al₂O₃, 4 – aperture

The construction of a black body is simple. A thermal hollow body has a small hole at one end. If the body is heated and reaches a certain temperature, and if temperature equilibrium is reached inside the hollow room, the hole ideally emits black radiation of the set temperature. For each temperature range and application purpose the construction of these black bodies depends on material and the geometric structure. If the hole is very small compared to the surface as a whole, the interference of the ideal state is very small. If you point

Physical principles

the measuring device on this hole, you can declare the temperature emitting from inside as black radiation which you can use for calibrating your measuring device. In reality, simple systems use surfaces, which are covered with pigmented paint and show absorption and emissivity values of 99 % within the required wavelength range. Usually, this is sufficient for calibrations of actual measurements.

Radiation principles of a black body

The radiation law by Planck shows the basic correlation for non-contact temperature measurements: It describes the spectral specific radiation $M_{\lambda S}$ of the black body into the half space depending on its temperature T and the wavelength λ .

$$M_{\lambda S} = \frac{2\pi hc^2}{\lambda^5} \frac{1}{e^{hc/\lambda kT} - 1} = \frac{C_1}{\lambda^5} \frac{1}{e^{C_2/\lambda T} - 1}$$

The following illustration shows the graphic description of the formula depending on λ with different temperatures as parameters.

With rising temperatures the maximum of the spectral specific

C light speed
 C_1 $3.74 \cdot 10^{-16} \text{ W m}^2$
 C_2 $1.44 \cdot 10^{-2} \text{ K m}$
 h Planck's constant

radiation shifts to shorter wavelengths. As the formula is very abstract it cannot be used for many practical applications. But, you may derive various correlations from it. By integrating the spectral radiation intensity for all wavelengths from 0 to infinite you can obtain the emitted radiation value of the body as a whole. This correlation is called Stefan Boltzmann law.

$$M_{\lambda S} = \sigma \cdot T^4 \text{ [Watt m}^2\text{]} \quad \sigma = 5.67 \cdot 10^{-8} \text{ WM}^{-2} \text{ K}^{-4}$$

The entire emitted radiation of a black body within the overall wavelength range increases proportional to the fourth power of its absolute temperature. The graphic illustration of Planck's law also shows that the wavelength, which is used to generate the maximum of the emitted radiation of a black body, shifts when temperatures change. Wien's displacement law can be derived from Planck's formula by differentiation.

$$\lambda_{\max} \cdot T = 2898 \text{ } \mu\text{m} \cdot \text{K}$$

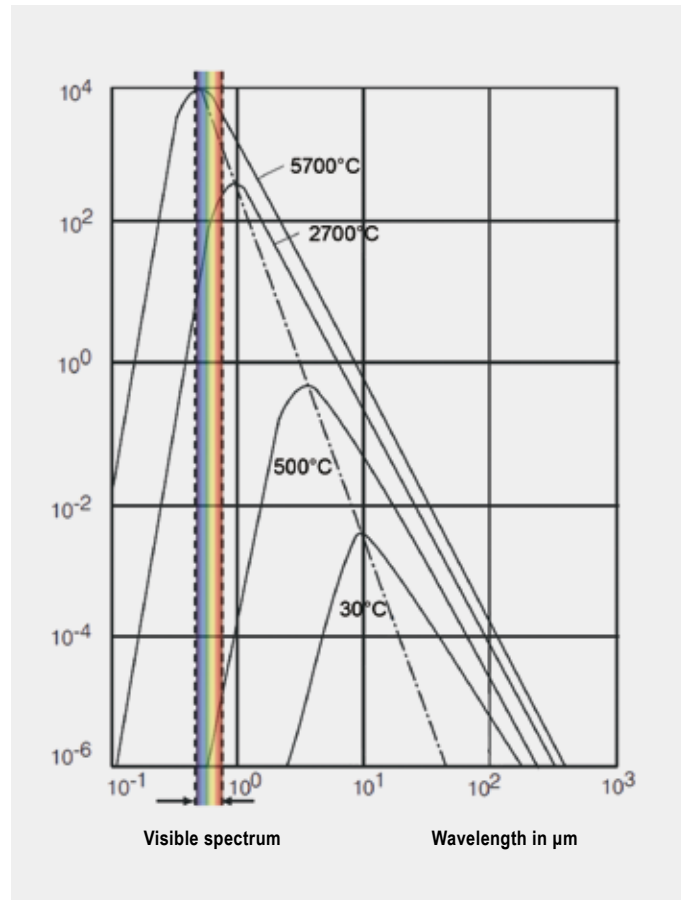

Spectral specific radiation $M_{\lambda S}$ of the black body depending on the wavelength

The wavelength, showing the maximum radiation, shifts with increasing temperature towards the range of short wavelengths.

The gray body

Only few bodies meet the ideal of the black body. Many bodies emit far less radiation at the same temperature. The emissivity ϵ defines the relation of the actual radiation value and that of the black body. It is between zero and one. The infrared sensor receives the emitted radiation from the object surface, but also reflected radiation from the surroundings and potentially infrared radiation that has been transmitted through the black body.

$$\epsilon + \rho + \tau = 1$$

ϵ emissivity

ρ reflection

τ transmissivity

Most bodies do not show transmissivity in infrared. Therefore the following applies:

$$\epsilon + \rho = 1$$

Construction and operation of infrared thermometers

The illustration shows the basic construction of an infrared thermometer. Using input optics, the emitted infrared radiati-

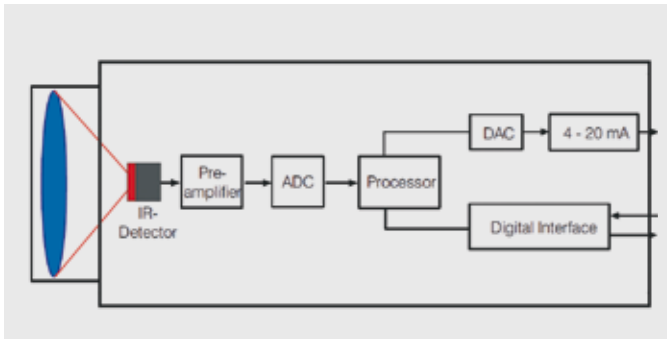

Block diagram of an infrared thermometer

on is focused onto an infrared detector. The detector generates an electrical signal that corresponds to the radiation, which is subsequently amplified and can be used for further processing. Digital signal processing transforms the signal into an output value proportional to the object temperature, which is then either shown on a display or provided as an analog signal.

To compensate environmental temperature influences, a second detector records the temperature of the measuring device or its optical channel. The calculation of the temperature of the measuring object is done in three basic steps:

1. Transformation of the received infrared radiation into an electrical signal
2. Compensation of background radiation from device and object
3. Linearization and output of temperature information

In addition to the displayed temperature value, the thermometers also support linear outputs such as 0/4–20 mA, 0–10 V and thermocouple elements, which allow easy connection to process management control systems. Furthermore, due to internal digital measurement processing, most of the currently used infrared thermometers also feature digital interfaces (e.g. USB, RS485, Ethernet) for data output and to enable access to device parameters.

Infrared detectors

The most important element in each infrared thermometer is the radiation receiver, also called detector. There are two main groups of infrared detectors.

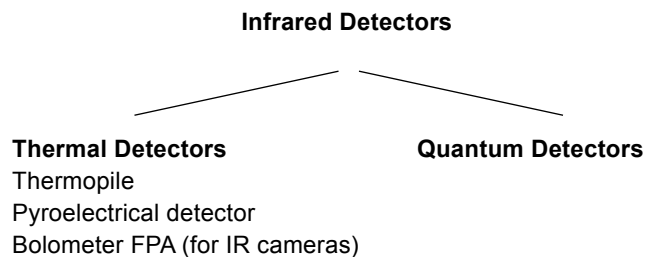

Physical principles

Thermal detectors

With these detectors, the temperature of the sensitive element changes due to the absorption of electromagnetic radiation. The temperature change causes a modification of the temperature-dependent property of the detector, which is electrically analyzed and serves as a measure for the absorbed energy.

Radiation thermocouple elements (thermopiles)

If the connection point between two different metallic materials is heated, the thermoelectrical effect results in an electrical voltage. The contact temperature measurement has been using this effect for a long time with the help of thermocouple elements. If the connection is warm because of absorbed

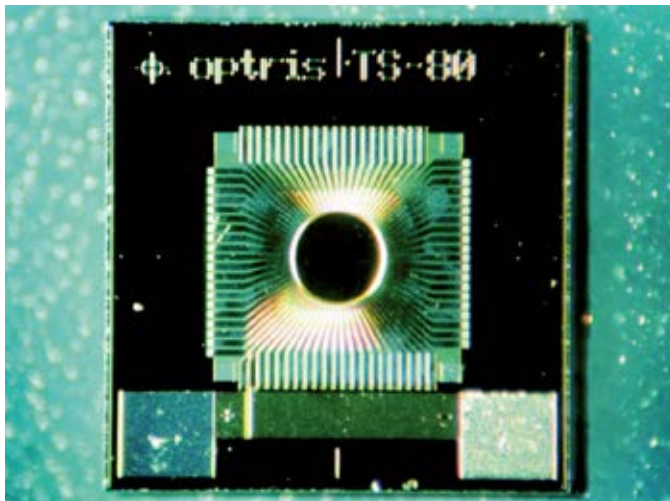

Thermopile TS80

radiation, this component is called radiation thermocouple. The illustration shows thermocouples made of bismuth/antimony which are arranged on a chip round an absorbing element. In case the temperature of the detector increases, this results in a proportional voltage, which can be caught at the end of the bond isles.

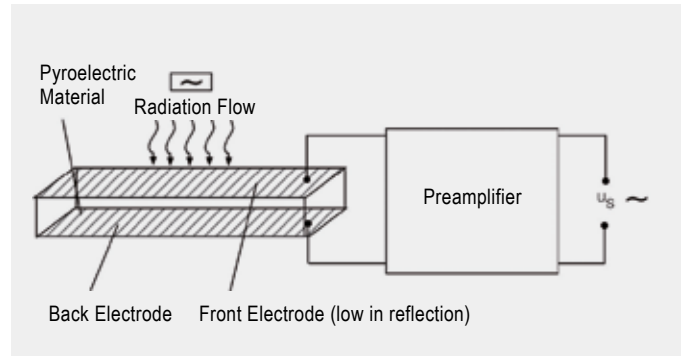

Construction of a pyroelectric detector

Pyroelectric detectors

The illustration shows the basic construction of a pyroelectric detector. This sensitive element consists of pyroelectric material with two electrodes. As a result of the temperature change of the sensitive detector element, caused by the absorption of infrared radiation, the surface loading changes due to the pyroelectric effect. The so created electric output signal is processed by a preamplifier.

Due to the nature of how the loading is generated in the pyroelectric element, the radiation flow has to be continuously and alternately interrupted. The advantage of the frequency selective preamplifying is a better signal-to-noise ratio.

Bolometers

Bolometers exploit the temperature dependency of electric resistance. The sensitive element consists of a resistor, which changes when it absorbs heat. The change in resistance leads to a changed signal voltage. The material should have a high temperature factor of the electrical resistance in order to achieve high sensitivity and high specific detectivity. Bolometers that operate at room temperature use the temperature coefficient of metallic resistors (e.g. black layer and thin layer bolometer) as well as of semiconductor resistors (e.g. thermistor bolometers).

Nowadays, infrared imagers are based on the following technological developments:

The semiconductor technology replaces mechanical scanners. FPAs (Focal Plane Arrays) are produced on the basis of thin layer bolometers. Consequently VOX (Vanadium oxide) or amorphous silicon are used as alternative technologies. These technologies significantly improve the price-performance ratio. Today, common detector sizes are 160 x 120, 320 x 240 and 640 x 480 pixels.

Quantum detectors

The decisive difference between quantum detectors and thermal detectors is their faster reaction on the absorbed radiation. The mode of operation of quantum detectors is based on the photo effect. The visible photons of the infrared radiation lead to an increase of the electrons into a higher energy level inside the semiconductor material. When the electrons fall back, an electric signal (voltage or power) is generated. Also, a change of the electric resistance is possible. These signals can be precisely evaluated. Quantum detectors are very fast (ns to μ s).

The temperature of the sensitive element of a thermal detector changes relatively slowly. Time constants of thermal detectors are usually bigger than time constants of quantum detectors. Roughly approximated, one can say that time constants of thermal detectors can be measured in milliseconds whereas time constants of quantum detectors can be measured in nanoseconds or even microseconds.

Despite the fast development in the field of quantum detectors, there are many applications where thermal detectors are more suitable. That is why they share an equal status with quantum detectors.

Transformation of infrared radiation into an electrical signal and calculation of the object temperature

Since per the Stefan Boltzmann law, the electric signal of the detector is as follows:

$$U \sim \varepsilon T_{obj}^4$$

As the reflected ambient radiation and the self-radiation of the infrared thermometer must also be considered, the formula is as follows:

$$U = C \cdot [\varepsilon T_{obj}^4 + (1 - \varepsilon) \cdot T_{amb}^4 - T_{pyr}^4]$$

U	Detector signal
T_{obj}	Object temperature
T_{amb}	Temperature of background radiation
T_{pyr}	Temperature of the device
C	Device-specific constant

$$\rho = 1 - \varepsilon \quad \text{Reflection of object}$$

Since infrared thermometers do not cover the total wavelength range, the exponent n depends on the wavelength λ . At wavelengths ranging from 1 to 14 μ m.

n is between 17 and 2 (at long wavelengths between 2 and 3 and at short wavelengths between 15 and 17).

$$U = C \cdot [\varepsilon T_{obj}^n + (1 - \varepsilon) \cdot T_{amb}^n - T_{pyr}^n]$$

Thus the object temperature is determined as follows:

$$T_{obj} = \sqrt[n]{\frac{U - C \cdot T_{amb}^n + C \cdot \varepsilon T_{amb}^n + C \cdot T_{pyr}^n}{C \varepsilon}}$$

The results of these calculations for all temperatures are stored as curve band in the EEPROM of the infrared thermometer. This guarantees quick access to the data and fast calculation of the temperature.

Emissivity

The formula shows that the emissivity ε is essential, if you want to determine the temperature with radiation measurement. The emissivity measures the ratio of thermal radiation, which is generated by a gray and a black body of equal temperature. The maximum emissivity for the black body is 1. A gray body is an object, that has the same emissivity at all wavelengths and emits less infrared radiation than a black radiator ($\varepsilon < 1$). Bodies with emissivities, which depend on the temperature as well as on the wavelength, are called non-gray or selective bodies (e.g. metals).

see emissivity table starting page 34

Emissivity and temperature measurement

Emissivity and temperature measurement

Emissivity is a key factor for the accurate measurement of temperatures. It depends on various influences and must be adjusted according to the application.

Theoretically, emissivity depends on the material, its surface, temperature, wavelength, measuring angle and sometimes on the measuring arrangement. Many objects consisting of non-metallic material show high and relatively constant emissivity independent of their surface consistency, at least in long-wave spectral ranges.

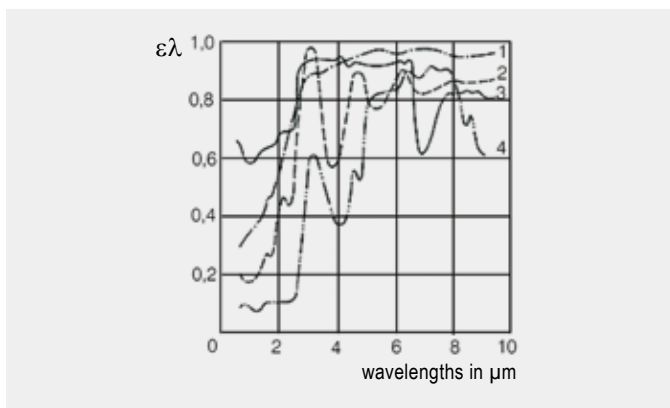

Spectral emissivity of some materials: 1 Enamel, 2 Plaster, 3 Concrete, 4 Chamotte

Generally, metallic materials show a low emissivity, which strongly depends on the surface consistency and which drop in higher wavelengths.

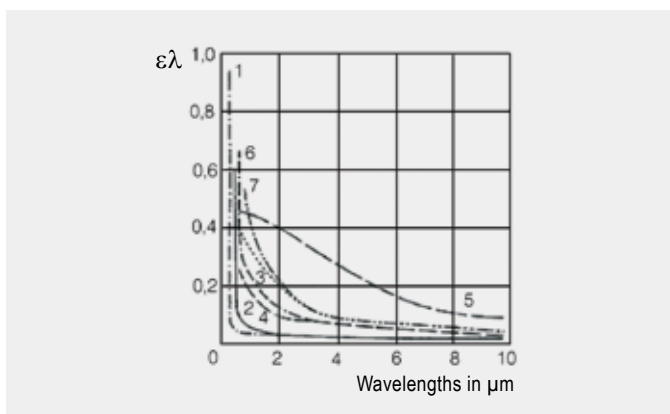

Spectral emissivity of metallic materials: 1 Silver, 2 Gold, 3 Platinum, 4 Rhodium, 5 Chrome, 6 Tantalum, 7 Molybdenum

Temperature measurement of metallic materials

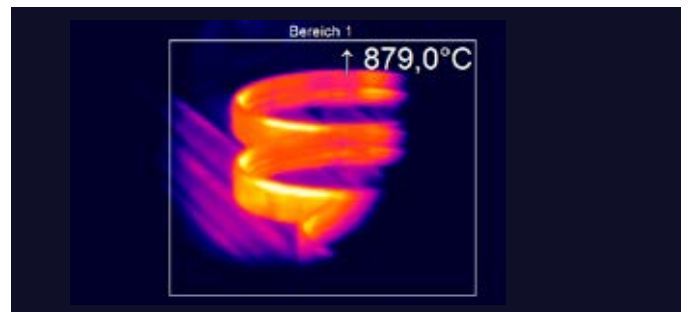

Measurement on bearing rings during hardening process

This may result in varying and unreliable measuring results. When selecting a suitable temperature measurement device, please ensure that the infrared radiation is measured at a specific wavelength and in a specific temperature range, in which metallic materials display a relatively high emissivity. The graph below shows that it makes sense to use the shortest possible wavelength available for measuring, since measuring errors increase in correlation to the wavelength for many types of metals. For metals, the optimal wavelength at high temperatures is 0.8 to 1.0 μm , which lies at the limit of the visible area.

In addition, wavelengths of 1.6 μm , 2.2 μm and 3.9 μm are possible.

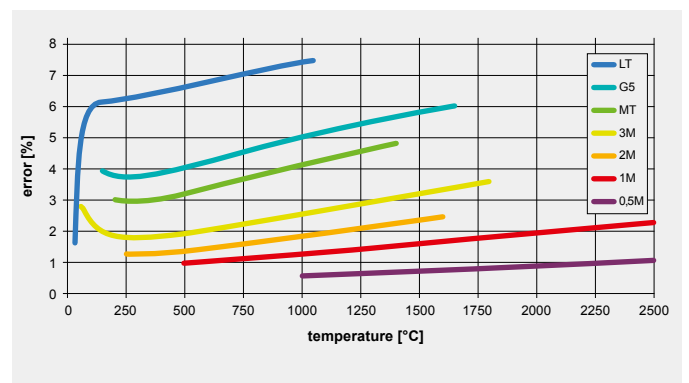

Measurement error of 10 % as result of wrongly adjusted emissivity and in dependence on wavelength and object temperature (LT: 8–14 μm ; G5: 5 μm ; MT: 3.9 μm ; 3M: 2.3 μm ; 2M: 1.6 μm ; 1M: 1.0 μm); 0.5M: 525 nm.

Further information in our High Temperature Applications brochure: www.optris.co.uk/temperature-measurement-metal

Temperature measurement of plastics

Transmission rates of plastics vary according to wavelength. They react inversely proportional to the thickness, whereas thin materials are more transmissive than thick plastics. Optimal measurements can be carried out with wavelengths, where transmissivity is almost zero. Independent of the thickness. Polyethylene, polypropylene, nylon and polystyrene are non-transmissive at 3.43 μm ; polyester, polyurethane, Teflon, FEP and polyamide are non-transmissive at 7.9 μm . For thicker and pigmented films, wavelengths between 8 and 14 μm can be selected.

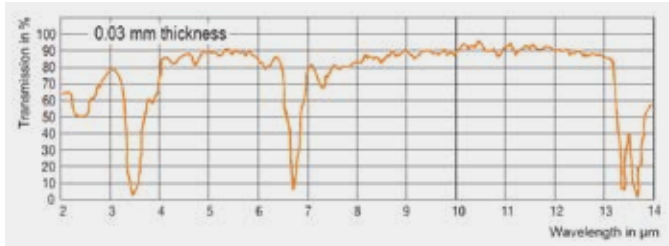

Spectral transmissivity of plastic films made from polyethylene

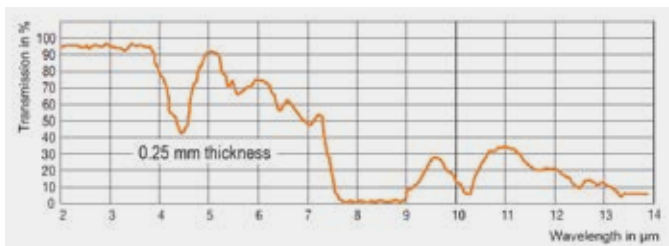

Spectral transmissivity of plastic films made of polyester

The manufacturer of infrared thermometers can determine the optimal spectral range for the temperature measurement by testing the plastics material. The reflection is between 5 and 10 % for almost all plastics.

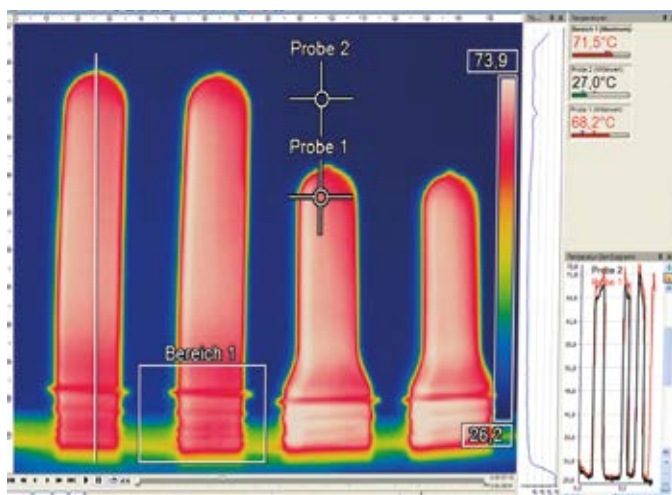

Detailed analysis of preforms during bottle manufacturing

Further information about plastics applications in our brochure: www.optris.co.uk/temperature-measurement-plastics

Temperature measurement of glass

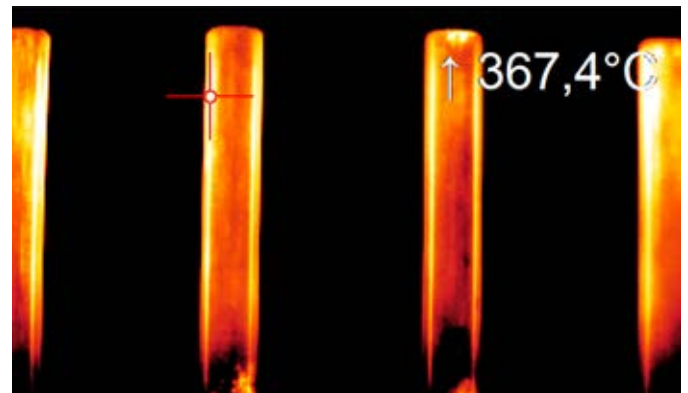

Hot spot measurement on glass tubes

If temperature measurements are performed on glass with IR thermometers or the special IR camera optris PI G7, both reflection and transmissivity must be considered. A careful selection of the wavelength facilitates measurements of the glass surface as well as of the deeper layers of the glass. Wavelengths of 1.0 μm , 2.2 μm or 3.9 μm are appropriate for measuring deeper layers, whereas 5 μm and 7.9 μm are recommended for surface measurements. At low temperatures, wavelengths between 8 and 14 μm should be selected in combination with an emissivity of 0.85 in order to compensate reflection. For this purpose, a thermometer with short response time should be used, since glass is a poor heat conductor and the surface temperature can change quickly.

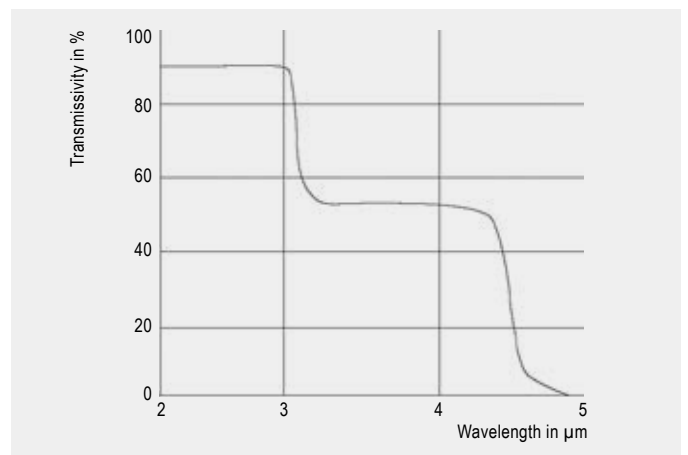

Spectral transmissivity of glass

Further information in our glass applications overview: www.optris.co.uk/temperature-measurement-for-producing-spsq-and-lsg

Emissivity and temperature measurement

Environmental influences

The chart below shows that the transmissivity of air strongly depends on the wavelength. Areas of high damping alternate with areas of high transmissivity – the so-called atmospheric windows. The transmissivity in the long-wave atmospheric window (8–14 μm) is constantly high, whereas, due to the atmosphere, there are measurable reductions in the shortwave area, which may lead to false results. Typical measuring windows are 1.1 ... 1.7 μm , 2 ... 2.5 μm and 3 ... 5 μm .

Additional influencing variables are potential from heat sources in the environment of the measuring object. To prevent wrong measuring results due to increased ambient temperatures, the infrared thermometer compensates the influence of ambient temperatures beforehand (e.g. when measuring temperatures of metals in industrial ovens, where the oven walls are hotter than the measuring object). A second temperature measuring head helps to generate accurate measuring results by automatically compensating the ambient temperatures and correctly adjusting emissivity.

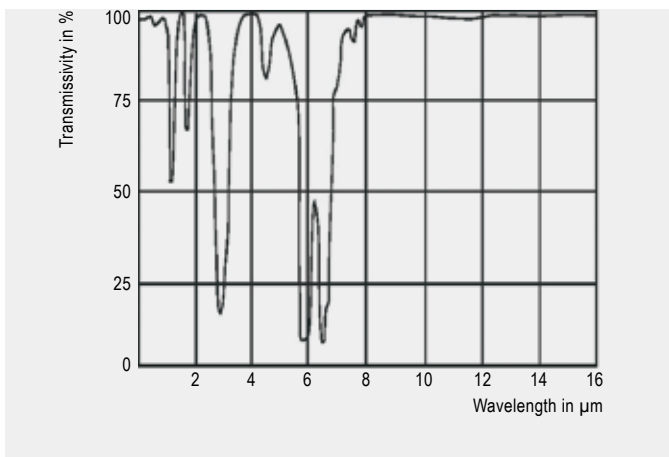

Spectral transmissivity of air (1 m, 32 °C, 75 % r. F.)

Dust, smoke and suspended matter in the atmosphere can pollute the lens and result in false measuring results. The use of air purge units (screw-on pipe socket connections with compressed air) prevents particles in the air from collecting on the lens. Accessories for air and water cooling support the use of infrared thermometers even under harsh environmental conditions.

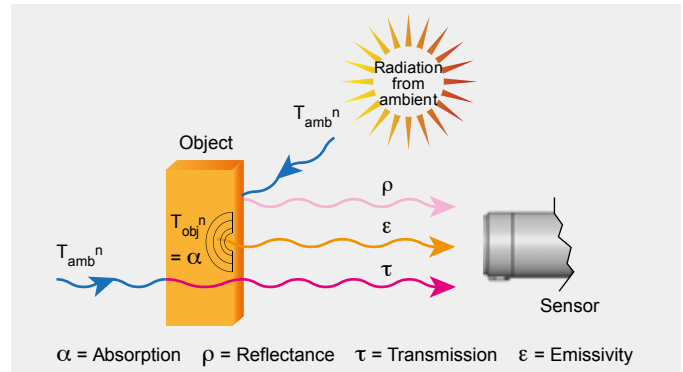

Compensating ambient influences

Experimental determination of emissivity

In the appendix you will find emissivity data for various materials from technical literature and measurement results. There are different ways to determine emissivity.

Method 1: With the help of a thermocouple:

With the help of a contact probe (thermocouple), the real temperature of an object surface is measured simultaneously to the radiation. The emissivity is subsequently adjusted so that the temperature measurement of the infrared thermometer corresponds to the value shown by the contact measurement. The contact probe should have good temperature contact and only low heat dissipation.

Method 2: Creating a black body with a test object from the measuring material:

A drilled hole (ratio diameter to drilling depth $\leq \frac{1}{3}$) in thermal conducting material reacts similarly to a black body with an emissivity near 1. It is necessary to aim at the bottom of the drilled hole due to the optical properties of the infrared device and the measuring distance. Emissivity can be subsequently determined.

Method 3: Applying reference emissivity:

A band or color with a known emissivity is applied to the measurement object. This emissivity is set on the infrared measurement device and the temperature of band or paint can be measured. Subsequently, the temperature next to this reference point will be measured, whereby the emissivity must simultaneously be adjusted until the same temperature measurement of the band or paint is displayed. Emissivity is subsequently displayed on the device.

Calibration of infrared thermometers ^{[1] [2]}

Infrared thermometers are calibrated with the help of reference radiation sources, so called black bodies. These radiation sources are able to produce different temperatures with a high stability (see also page 5, The black body).

Knowing the exact value of the radiation temperature is essential for the calibration process. It can be measured by either using a contact thermometer (in combination with the determination of the emissivity) or a transfer standard infrared thermometer. This value can then be used to determine the device constant for an initial calibration of the infrared sensors. In order to conduct post-calibration by customers or local calibration facilities, the calibration temperature should be close to the temperatures which occur during the respective applications.

Optris uses the transfer standard radiation thermometer LS-PTB (see image) to measure the radiation temperature of a reference source. The LS-PTB is based on the portable IR thermometer optris® LS. The LS-PTB must be traceable to the International Temperature Scale from 1990 (ITS-90). It is calibrated by the PTB (German National Metrological Institute) in regular intervals.

ITS-90 is a very good approximation of thermodynamic temperature. It is based on 17 well-reproducible fixed values such as melting points of highly purity metals. Within the scope of ITS-90, the LS-PTB is compared to PTB national temperature standards within a closed chain of comparative measurements with known uncertainty.



Certificate of German National Metrological Institute (PTB)

Based on the LS-PTB, Optris produces the LS-DCI as a high-precision reference IR thermometer for its customers. The DCI units are produced with pre-selected components which ensure high measurement stability. In combination with dedicated calibration at three calibration points, the LS-DCI achieves higher accuracy at these reference points.



optris® LS-PTB

Emissivity and temperature measurement



Automated calibration stations at Optris GmbH

The optics of an IR thermometer is described by the distance-to-spot-ratio (D:S). Depending on the quality of the optics, a certain amount of radiation is also received from sources outside the specified measurement spot. The maximum value here equals the radiation emitted by a hemispheric radiant source. The respective signal change in correlation with re-sizing the radiation source is described as the size-of-source effect (SSE).

As a result of this correlation, all manufacturers of IR thermometers use accurately defined geometries for the calibration of their units; meaning depending on the aperture of the radiation source (A) a distance (a) between the IR thermometer and the reference source is defined. Thus, the value specified in datasheets and technical documentation as measurement field is generally a specific defined percentage of this radiation maximum – values of 90 % or 95 % are common.

Optris has state-of-the-art in-house laboratories which fulfill the mandatory requirements for calibration stations. When issuing calibration certificates, not only laboratory temperature and humidity are documented, but also the measurement distance and source diameter (calibration geometry).

Optics, sighting techniques and electronics

Construction of the infrared thermometers

Infrared thermometers have various configurations and designs, which differ in optics, electronics, technology, size and housing. Despite these differences, the signal-processing chain is always the same: It starts with an infrared signal and ends with an electronic temperature output signal.

Lenses and windows

The measuring chain begins with an optical system – usually consisting of lens optics. The lens receives the emitted infrared energy from a measuring spot and focuses it onto a detector. Measurements based on this technology can only be correct, if the measuring object is bigger in size than the detector spot. The distance ratio describes the size of the measuring spot at a specific distance. It is defined as D:S-ratio: relation of measuring distance to spot diameter. The optical resolution improves with increasing values of the D:S ratio.

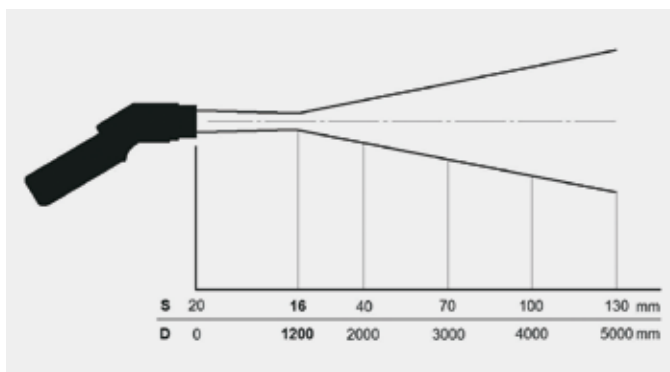

Optical diagram of an infrared sensor

Depending on their material, infrared lenses can only be used for a certain wavelength range. The following chart presents typical lenses and window materials for infrared thermometers with their corresponding wavelength.

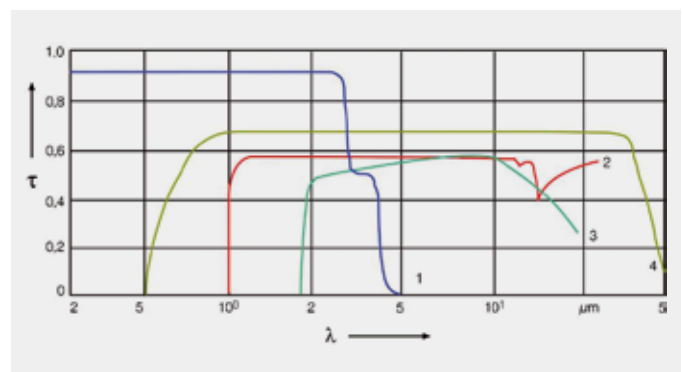

Transmissivity of typical infrared materials (1 mm thick)
1 Glass, 2 Germanium, 3 Silicon, 4 KRS₅

Some measurements make it necessary to take the temperature through an appropriate measuring window, as in closed reaction containers, ovens or vacuum chambers. The transmissivity of the measuring window should match the spectral sensitivity of the sensor. Quartz glass is suitable for high measuring temperatures, while special materials like germanium, AMTIR or zink selenide should be used for low temperatures in the spectral range between 8 – 14 μm . The following parameters should also be considered when selecting a window: diameter of the window, temperature conditions and maximum pressure difference. A window of 25 mm in diameter, which has to resist a pressure difference of 1 unit of atmosphere, should be 1.7 mm thick. To focus the sensor on the measuring object for measurements in, for example, a vacuum container, it makes sense to use window material, that is also transparent in the visible range.

Optics, sighting techniques and electronics

Window Materials / Properties	Al ₂ O ₃	SiO ₂	CaF ₂	BaF ₂	AMTIR	ZnS	ZnSe	KRS ₅	GE	Si
Recommended infrared wavelength in μm	1 ... 4	1 ... 2.5	2 ... 8	2 ... 8	3 ... 14	2 ... 14	2 ... 14	1 ... 14	2 ... 14	1.5 ... 8
Max. window temperature in $^{\circ}\text{C}$	1800	900	600	500	300	250	250	no info	100	200
Transmissivity in visible area	yes	yes	yes	yes	no	yes	yes	yes	no	no
Resistance against humidity, acids, ammonia compound	very good	very good	few	few	good	good	good	good	good	very good
Appropriate for UHV	yes	yes	yes	yes	no info	yes	yes	yes	yes	yes

The table presents a comparative overview of various window materials

Windows with anti-reflection coating have significantly higher transmissivity (up to 95 %). The transmission loss can be corrected with transmissivity adjustment on the window, providing that the manufacturer has specified transmissivity for the corresponding wavelength range. Otherwise, it must be experimentally determined with an infrared thermometer and a reference source.

Latest trends in sighting techniques

New measuring principles and sighting techniques enable greater accuracy in the use of infrared measuring devices. Innovations in the field of solid state lasers are adapted by using multiple laser systems to mark spot sizes. As a result, actual spot sizes inside the object field are displayed using laser crosshair technology. In other devices, video camera chips replace optical sighting systems.

Development of high-performance optics in combination with crosshair laser sighting technologies

Simple, cost-effective portable infrared thermometers use single spot laser pointers in order to mark the center of the spot with a parallax default. Applying this technique, the user has to estimate the spot size with the help of the spot size diagram and the likewise estimated measuring distance.

If the measuring object covers only a part of the measuring spot, temperature rises are only displayed as an average value of hot area and ambient cold area. If, for example, the higher resistance of an electric connection due to a corroded contact results in an overheating, this rise in temperature will only be shown as minor heating for smaller objects and oversized spot dimensions, and the potential danger of the situation will not be recognized.

In order to correctly display spot size, optical sighting systems were developed with size marking in the crosshairs, which enable precise targeting. Since laser pyrometers are significantly easier and safer than contact thermometers, engineers have tried to mark the spot size with laser sighting techniques independently from the distance – according to the distance-spot-size ratio in the diagram.

Two warped laser beams approximately show the narrowing of the measuring beam and its broadening in longer distances. However, the diameter of the spot size is only indicated by two spots on the outer circumference. Due to the design, the angle position of these laser points on the measuring circuit moves, which makes aiming difficult.

One advancement are video pyrometers, which enable precise measuring field marking with help of a simultaneous use of a video module and a crosshair laser sighting technology.

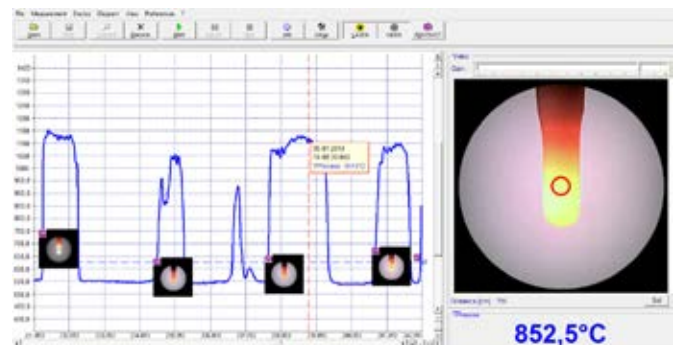

The Optris Compact Connect software features extensive setting options for the video pyrometer

The crosshair concept

New laser sighting technologies make it possible to present measuring spots of infrared thermometers as real-size crosshairs, which exactly match the dimensions of the measuring spot.

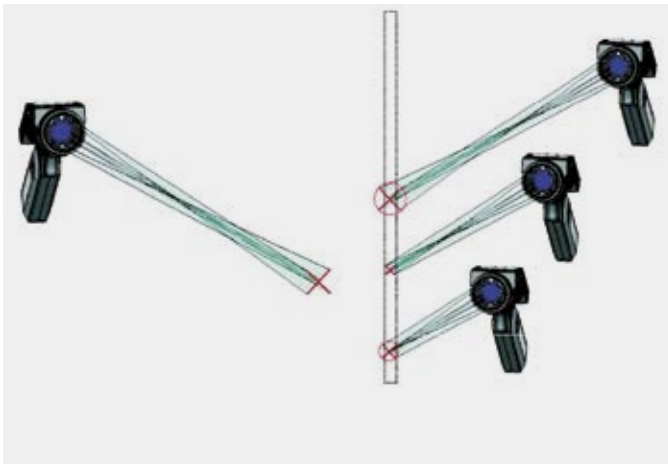

Infrared thermometer with laser crosshairs for exact spot size marking

Four laser diodes connected to line generators are arranged in symmetrical order around the infrared optical measuring channel, to create a line of defined length inside the focus distance. The line generators, arranged in pairs, face each other and completely overlap the projected laser lines at the focus, generating a measuring cross or crosshairs, which subsequently define the exact diameter of the measuring spot. At longer or shorter distances, overlapping is only partially, thereby changing the line length and the measuring crosshairs for the user. With the help of this technology, it is possible to determine the precise dimensions of a measuring spot for the first time. This development significantly improves the practical application of products with good optical performance.

Switching to close focus mode

In addition to measuring common applications in electrical maintenance and industrial quality control at optimal measuring distances of about 0.75 to 2.5 metres, it is often necessary to measure distinctly smaller objects at shorter distances. As a result, devices have been designed, that enable focusing within specific limits. Still, it remains a challenge to generate spot sizes smaller than 1 mm.

New products apply a technology which uses two-lens optics: Similar to digital cameras, the inner lens position can be switched mechanically into focusing onto very small spot sizes. The result is a very small spot size, but only at a constant distance. If the distance grows smaller or longer between measuring spot and infrared thermometer, the measuring spot increases in size. Using two intersecting laser beams, which cross precisely at the smallest spot size position and thereby merge into one single spot, it is possible to show optimal distance as well as measuring spot size. The image shows the optical system of a modern infrared thermometer: The lens position is selectable and various laser sighting systems simultaneously support a real-size display of the measuring spot.

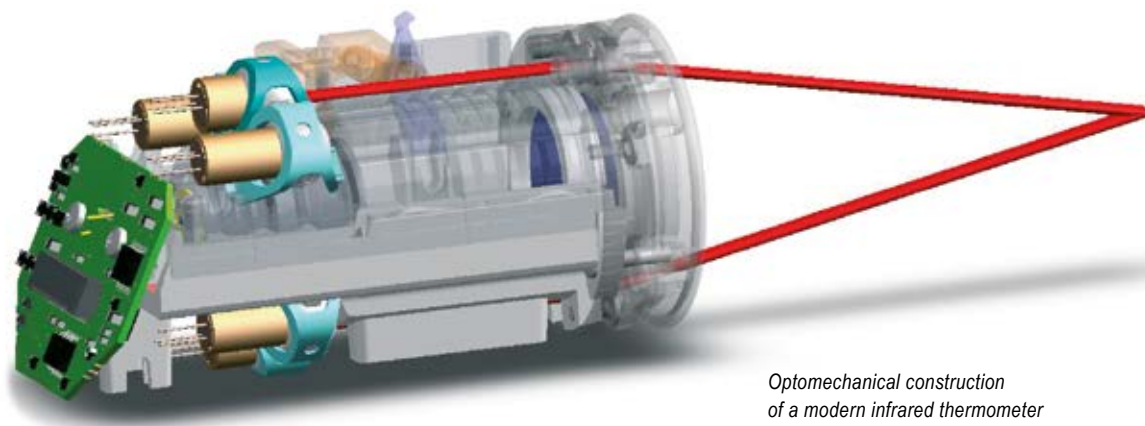

Optomechanical construction of a modern infrared thermometer

Optics, sighting techniques and electronics

Electronics

Displays, outputs and interfaces

The electronics of the infrared thermometer linearizes the output signal of the detector to ultimately generate a linear power signal 0/4–20 mA or voltage signal 0–10 V. The portable thermometers show this signal as a temperature result on the LCD displays. Additionally, some of the portable units as well as online sensors offer various outputs and interfaces for further signal processing.

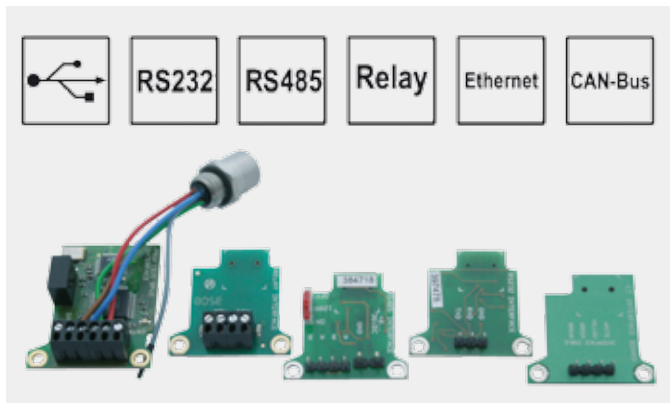

Outputs and interfaces (analog and digital).

As an example: pluggable, digital interface modules of the electronic box

Examples for outputs and interfaces of infrared thermometers

Industrial field bus systems are becoming increasingly important. They give the user greater flexibility and reduce wiring efforts. If changes are made, products in a product line, the sensor parameters (emissivity, measuring range or limiting value) can be adjusted remotely.

Consequently, continuous process control and management is guaranteed even in hazardous surroundings and with a minimum of labor. If a malfunction occurs, e.g. cable interruptions or component failure, an error, an error message appears automatically.

A further advantage of infrared thermometers with digital interface is the option of carrying out field calibrations with calibration software of the manufacturer.

The output interfaces of infrared thermometers may be directly connected with PC, laptop, measuring data printer. Customer-specific graphics and charts can be created with PC software.

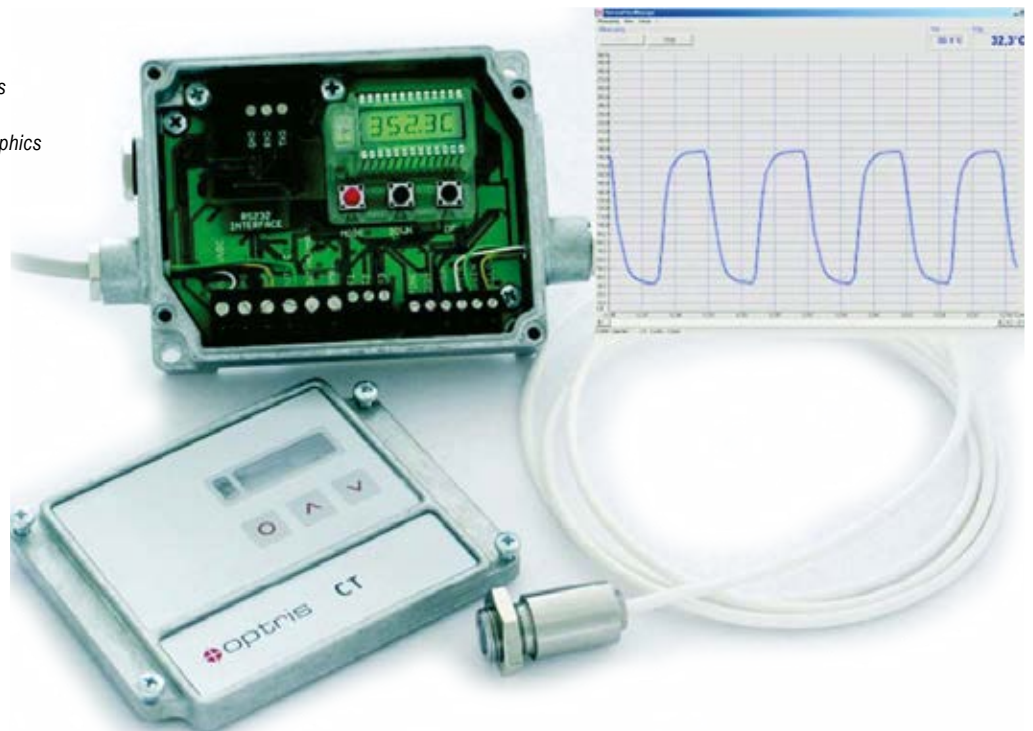

Infrared thermometers and applications

Non-contact temperature measurement with infrared thermometers is a qualified method of controlling, monitoring and managing process temperatures and of preventive maintenance of machines and facilities. Portable infrared thermometers or infrared online sensors are categorized as point and image measuring devices, and can be selected depending on the application.



Portable infrared thermometers

Portable infrared thermometers are generally used to verify critical parts quickly and easily, for example for preventive maintenance and inspection of electrical facilities, rotating machines as well as a diagnostic tool for heating, ventilation and air conditioning systems and for quick error analysis of cars.

Infrared thermometers are also designed for applications under harsh industrial conditions. They may be used indoors and outside, in sun and rain, in fluctuating temperature conditions. The optris® MS is not only portable and lightweight, it is rugged and easy to handle. Whether you carry it in your shirt pocket, on your belt or in the toolbox, it should be your tool of choice for fast inspections.

Temperatures ranging from -32 to 530 °C can be measured with an accuracy of ± 1 and ± 1 °C in only 0.3 seconds. The installed laser focuses at the measuring object and with only one click, the temperature is displayed with a resolution of 0.1 °C. An alarm signal for maximum and minimum values supports systematic scanning of the measuring object and quick detection of the hot spot. The new precision glass lens

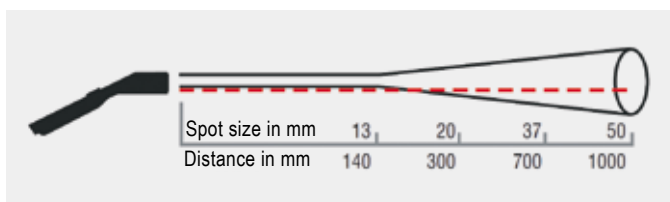

Distance-to-spot-ratio (D:S) 20:1

supports measurement of very small objects. If the measuring object can be approached at a distance of up to 14 cm, the spot size is only 13 mm. The spot size increases if the distance is further. At a distance (D) of 1 meter, you can take the temperature of a 50 mm surface in size (S) – meaning that, the optical resolution D:S is 20:1.

1. Typical applications in maintenance and service

Defective switchgears, fuses, engines and electrical connections are hardly visible with the naked eye. But it is common knowledge that most production facilities, which consume electricity or transfer mechanical power, heat up prior to malfunctioning.

Non-contact temperature measurement is an important instrument in preventive maintenance in order to guarantee the safety of facilities.

The optris® LS portable thermometers are ideal tools for fast everyday measurements of a vast number of industrial measuring objects with their spot size of only 1 mm and laser crosshair technology.

- Temperature measurements of hard-to-reach and moving machines and facilities in hazardous environments, or on electrical engine connections
- Detection of loose connection joints
- Localization of hidden failures in cable channels
- Inspection of fuses and circuit breakers
- Monitoring low and medium voltage facilities
- Detection of one-sided overload and unbalanced energy distribution
- Checking transformers and small components



Portable Optris infrared thermometers

Infrared thermometers and applications

Temperature measurement of contacts

During the transfer of high electrical performance, bus contacts often show unbalanced load distribution and overheating, which might be a safety risk. Mechanical movement of material may result in loose contacts, which – due to cyclic heating and cooling - increase their electrical resistance, which leads to higher power consumption and heat generation.



Detailed infrared temperature measurement of an electric control system using the optris® LS integrated close focus optics for 1 mm ranges

Dust and corrosion may also cause higher resistance. By comparing temperature differences to evenly charged contacts and the ambient temperature, it is possible to draw conclusions about the operating condition. 10 K difference indicate a bad connection, 30 K imply a critical state.

Checking the transformers

Transformers have a maximum operating temperature. If overheating occurs during measurement of air transformer coiling, this indicates a malfunction. This can either be caused by the the coiling itself, or an unsteady charging of the phases.

Localization of defective cables

“Hidden” defects in cables may be localized by a fast scan with infrared thermometers. Increased temperatures signalize increased power consumption. At these points, the cables can be checked for splits, corrosion and aging.

2. Typical applications in heating, ventilation and air conditioning systems

Drafty rooms or bad climate are often the result of defective or unsteadily working heating, ventilation and air conditioning systems. The HVAC engineer is asked to locate the source of trouble in the shortest possible time and to prevent unscheduled shutdowns. Depending on the method, this was previously very time-consuming and work-intensive. The engineer often had to drill holes into channels in order to trace leakage in channels, jammed filters or iced refrigerating coils. It also took time before the inserted thermometers stabilized and could correctly measure the air temperature in the channel.

The use of infrared thermometers makes this work considerably easier and saves valuable working time. Surface temperatures of components can now be measured at a safe di-



Temperature monitoring of heating circuits

stance in a quick and convenient way. Ladders are no longer necessary. HVAC engineers need measuring tools, that work efficiently and reliably, are designed for durability and are easy to handle.

The optris® LS LT supports:

- detecting defective isolations
- finding leakages in floor heating systems
- checking burners of oil heaters and gas boilers
- controlling heat exchangers, heating circuits and heating distributors
- locating leakages in conduits
- controlling air outlets and safety valves
- regulating thermostats or indoor climate systems

Controlling air conduits

Air conduit joints are often sources of trouble. They either loosen due to vibrations or because of the constant expansion and contraction of the conduits when cold and warm air alternately runs through them. Cracks may lead to an overloaded climate aggregate and may shorten their durability.

Regular controls of the conduits with infrared thermometers can detect fluctuations in temperature (increases or decreases) which may detect leakages, cracks or defective isolation.

Checking outlets for air supply and extraction

Differences in temperature between supply and extracted air indicate malfunctions. 10 to 12 K are normal in cooling processes. Values that rise above 12 K may indicate air flow that is too low and consequently cooling liquid that is too cold. If values drop below 10 K, they indicate jammed refrigerating coils, which prevents the passage of coolants. Temperatures in heating systems may vary between 15 and 40 K. If temperatures show more variation, jammed filters or malfunction in heat exchangers may be the reason.

Regulating the condition of air in a room

The engineer requires detailed information on the temperature distribution inside a room in order to dimension climate aggregates or evaluate air outlets. Walls, ceilings and floors can be scanned in seconds with an Optris infrared thermometer. Just aim at the measuring surface and the temperature is displayed. By reading the measuring data, the HVAC engineer is able to create the optimal climate. Optimal ambient conditions help protect devices and facilities, while also providing employees with a healthy climate.

Inspecting burners

Burners of oil heating systems and gas boilers can be inspected using infrared temperature measurement. The results offer information on the sources of trouble. Increased temperatures may indicate jammed heat exchangers and polluted surfaces on the flaming side.

3. Typical applications for automotive analysis

Locating and eliminating sources of trouble as quickly as possible is key for both vehicle inspections and race track pit stops. Listed below are some examples of how to use non-contact temperature measurement in order to prevent repetitive replacement of expensive components by trial and error: Diagnosis of:

- engine malfunction,
- overheating of catalytic converters,
- fuel injection systems,
- air conditioning systems,
- cooling systems or
- braking systems.

Functional testing of brakes and tires

In order to determine the cause of irregular braking performance, the car is driven on a straight road and then the breaks are applied. The temperature of the brake drums or disks is subsequently immediately measured. The occurrence of significant temperature differences indicates jammed or malfunctioning brake calipers and brake pistons.

Heating inspection

Check the temperature of the coolant at the upper end of the pipe when the engine is warm. If the temperature drops notably below 95 °C, the thermostat probably does not close. Subsequently measure the input and output temperatures of the tubes at the spray wall. A 20 K increase in temperature at the supply is normal. If the outlet tube is cold, this indicates that no coolant is flowing through the heating system. Either the heat exchanger is jammed or the heating control spool is closed.

Diagnosis of the cooling system

The engine overheats, but a leakage in the cooling system cannot be found. This could be due to various reasons: a jammed radiator block, a defective fan sensor, a defective thermostat or a worn out rotor in the coolant pump.

The cooler, cooling liquid sensor and catalytic converter have already been checked with the handheld laser thermometer. To check the thermostat, let the engine warm up at idling speed. Subsequently measure the temperature of the upper end of the cooling tube and of the thermostat housing.

As soon as the engine reaches a temperature of 80 to 105 °C, the thermostat should open and a temperature increase in the upper end of the cooling pipe should be displayed. If the values remain unchanged, no cooling liquid is flowing and the thermostat can be identified as source of the problem.



Checking the heating system

Advantages of infrared thermometers at a glance:

- Easy to handle
- Non-contact function and precise measurement result delivery within seconds
- Carry out safe inspections on hot components or objects in hazardous environments
- Locate sources of problem without exchanging components
- Detect weak points before they become a problem
- Save valuable time and money

Infrared thermometers and applications

Stationary infrared thermometers

In contrast to handheld thermometers, stationary infrared temperature sensors are frequently used for quality assurance purposes in production lines. In addition to the non-contact temperature measurement and the display of the results, the user is able to control and manage process temperatures. The wide range of possibilities to adapt infrared sensors to the measuring task allows an easy upgrade in existing production facilities as well as for long-term planned equipment of new facilities in cooperation with OEM customers in the machine construction industry.

There is a variety of applications:



Metal industry



Plastics processing



Paper processing



Glass processing



Laser welding process

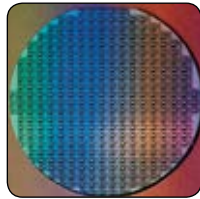

Electronic components



Automotive industry



Medical science



Food production

1. Temperature measurement during induction hardening



optris® CTlaser 1M/2M/3M devices used during induction-hardening

Thermal processing has taken on a significant role in the metal industry. Properties like corrosion resistance, magnetism, hardness, ductility, scuff resistance and breaking behavior can be influenced by targeted thermal processing of metals. Induction heating is one type of thermal processing. Work-pieces are brought into a strong electromagnetic field, thereby heating them, before they are ultimately frozen in a defined texture.

By controlling the frequency, it is possible to locally adjust the penetration depth of the heat, enabling processing of specific component areas. The desired microstructure of the metal depends on the ideal temperature time process. It is therefore important to continuously monitor the temperature.

Due to high electromagnetic fields, the optris® CTlaser 1M, 2M and 3M are ideal for this application, since the electronics are separated from the sensing head and therefore protected from radiation.



optris® CTlaser

2. Process control during thermoforming

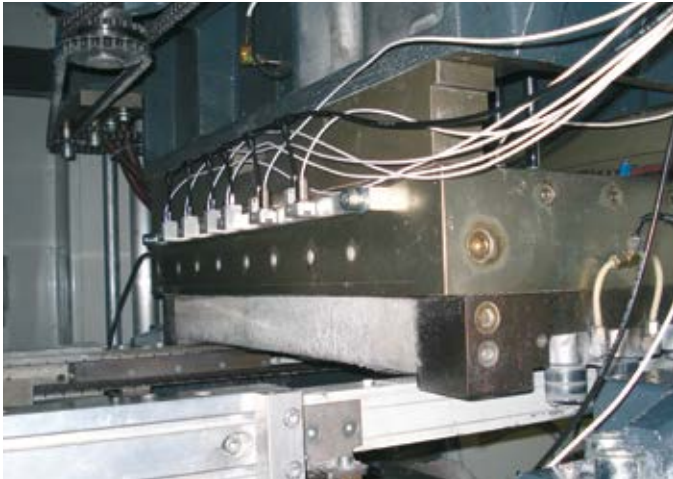

Small optris® CT LT sensor heads installed in a thermoforming machine with laminar air purge collar

Plastics processors are producing a wide range of plastic products with different dimensions, thickness, textures, colors and embossing patterns.

Product production is subjected to numerous thermal processes. If the critical areas within the process are known, infrared thermometers are used to measure and control temperature.

An important field of application is the installation in thermoforming machinery. Within thermoforming processes, the base material will be heated with emitters and thermally homogenized. High surface homogeneity and correctly adjusted forming temperature lead to high quality forming results. For example, optris® CT LT infrared thermometers are arranged in one line positioned at the heating zone exit to monitor the temperature profile and visualize temperature gradients.

3. Paper web production and gluing processes



Infrared temperature measurement in paper and cardboard processing

The high production speed of paper web feed in modern laminating facilities requires quick and accurate control of the paper temperature, the adhesive and of the base product intended for lamination. Accurate and distortion-free lamination is only possible, when the technologically defined temperature conditions between the product components is maintained at all times.

The use of miniaturized infrared temperature sensors from Optris to monitor and manage the temperatures along the paper web of the press-on roller and along the glue application roller, enable high laminating uniformity. Air purging and cleaning processes on the optical channels of the infrared sensors support maintenance-free measurement. The intelligent signal processing of the infrared sensors alongside the track, additionally enable the geometrical correction of the glue application process.



optris® CT LT sensing head



optris® CSmicro

Infrared thermometers and applications

4. Temperature control of electronic components during functional testings

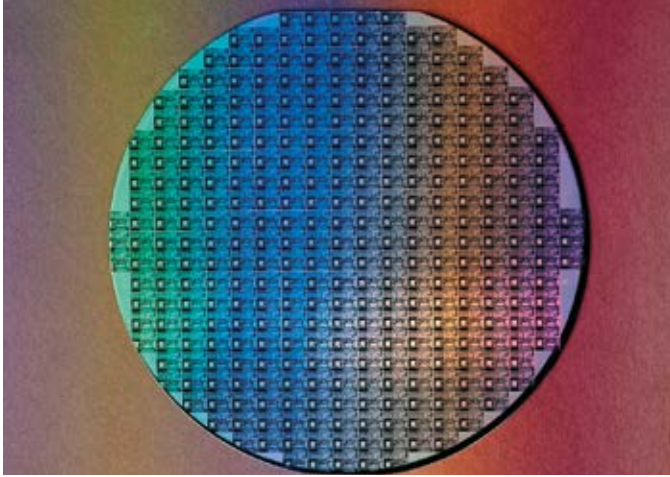

Infrared temperature measurement of wafers and electronic components

A growing number of manufacturers of electronic components and PCBs use non-contact temperature measurement to monitor and control the thermal behavior of their products.

Infrared cameras support a detailed real-time analysis of the thermal reaction of circuit boards in research and development as well as in serial production. Under certain circumstances, high production numbers and the increasing number of test and calibration stations make the use of infrared thermal cameras too expensive or effort-intensive. In such cases, optris® CT LT miniaturized infrared temperature sensors can be applied for serial monitoring of critical components in production facilities, like those which can be repeatedly reproducibly positioned at the measuring point (on a circuit board) during serial production, with results communicated to the test station workflow for further decision making. Additional optris® CT LT lens attachments are able to measure even smallest spot sizes of only 0.6 mm.

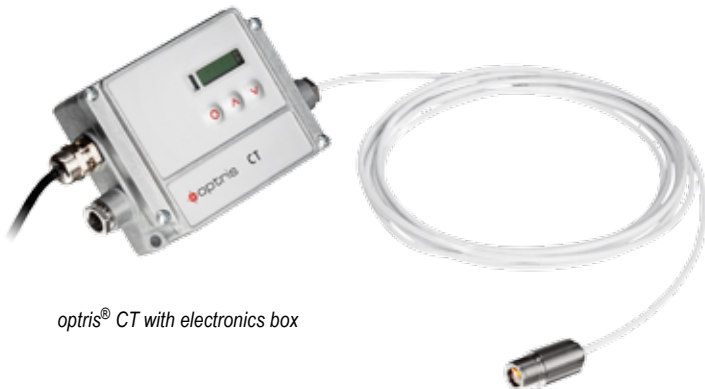

optris® CT with electronics box

5. Monitoring product temperature during laser welding and laser cutting processes



Infrared temperature measurement during laser welding processes

Using lasers for joining and cutting processes presents a highly sophisticated, cost- and time-effective technology. These processes take advantage of laser precision and high energy density. At the same time, higher precision requirements on the joining and cutting edges and shorter retention times combined with higher temperature require extremely high quality product handling and compensation routines. Causes of reduced precision include expansion in material length due to temperature changes.

The miniaturized infrared temperature sensors optris® CT LT measure product temperature at the cutting or joining edges extremely quickly and react with corresponding correction signals. The optris® CT LT and an installed focus lens can measure small spots of 0.6 mm. This supplies production engineers with a measurement and control system, that operates continuously and monitors the temperature reaction of the products in order to:

- quickly adjust and start facilities during batch changes, reduction of idle times and test material
- monitor and record batch production
- guarantee high and consistent process quality

Thermographic cameras and applications

What web cams and IR cameras have in common

The ability to see local warming and consequently detect weak points in our environment has always been a fascinating aspect within modern thermal imaging technology. Increasingly efficient manufacturing technologies for IR optical image sensors have not only resulted in drastically improved price-performance ratio.

The devices have become smaller, more durable and more economic in their power consumption. Thermographic measuring systems have been available for quite some time, which – similar to a traditional web-cam – are operational with only a USB port.



Thermal imager with power supply via USB of a tablet PC

Introduction

Thermographic cameras function like normal digital cameras: They have a sighting area, the so called field of view (FOV), which can vary between 6° (telescopic optic) and 90° (wide angle optic). Most standard optics work with a 26° FOV. The more distant the object, the larger the observed area will be, and with it also the part of the image is, which represents a single pixel. The advantage of this circumstance is that the radiation density is independent from the distance for sufficiently large measuring surfaces. Temperature measurements are therefore largely uninfluenced by the distance to a measuring object. [1]

In the long-wave infrared range, thermal radiation can only be focused with lenses made of germanium, germanium alloys,

zinc salts or with surface mirrors. When compared to conventional, mass-serial produced lenses in the visible spectral range, such hardened and tempered lenses still represent a significant cost factor for thermal imagers. They are designed as spherical three lens or aspheric two lens versions and, especially for cameras with exchangeable lenses, each lens must be calibrated for every single pixel in order to obtain correct measurements.

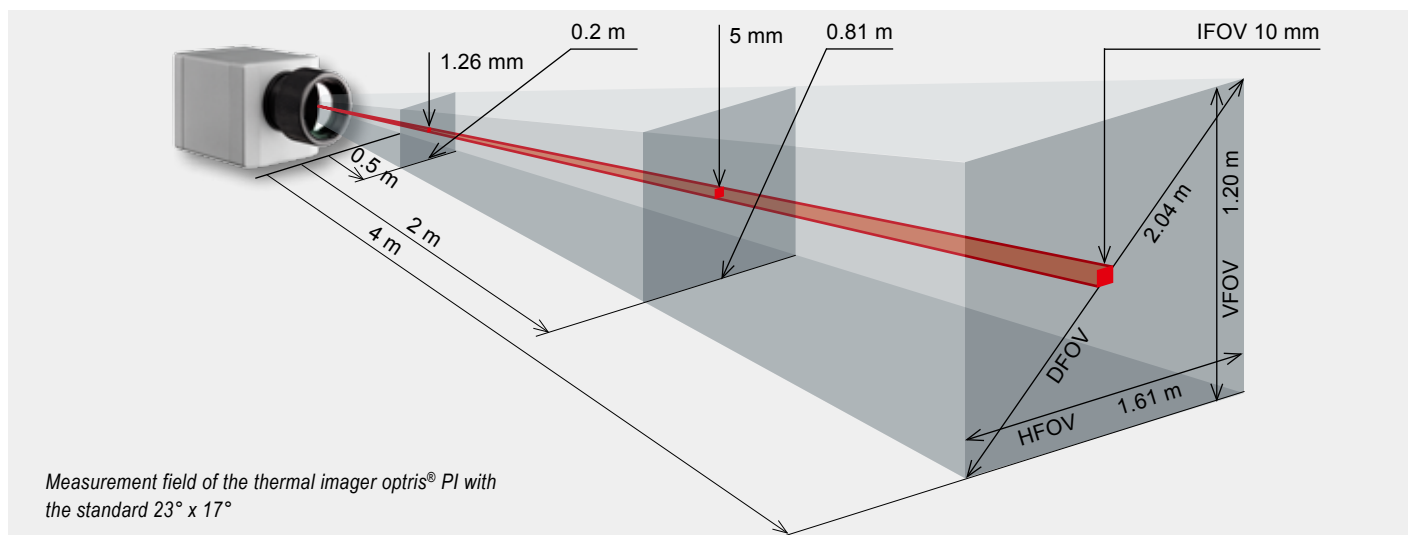

Calculate exact measurement field dimensions at: www.optris.co.uk/optics-calculator

Thermal imagers and applications

The core of almost all globally used thermographic systems is a focal plane array (FPA), an integrated image sensor with sizes of 20,000 to 1 million pixels. Each individual pixel is a microbolometer with the dimensions $17 \times 17 \mu\text{m}^2$ to $35 \times 35 \mu\text{m}^2$. Thermal radiation heats such 150 nanometer thin thermal detectors within 10 ms to about a fifth of the temperature difference between object and chip temperature. This extremely high sensitivity is achieved by a very low thermal capacity in connection with a superb insulation to the evacuated environment. The absorption of the semitransparent receiver area is improved by the interference of the transmitted and on the surface of the read out circuit reflected light wave with the succeeding light wave. [3]

To exploit this effect of self interference, the etched vanadium oxide or amorphous siliconbolometer surface must be positioned about $2 \mu\text{m}$ distance from the read-out circuit. The surface and bandwidth specific detectivity of the described FPAs achieve values of $10^9 \text{ cm Hz}^{1/2}/\text{W}$. It is therefore one magnitude better than other thermal detectors, which are used for example in pyrometers.

Changes to the bolometer's intrinsic temperature changes its resistance, which is transformed into an electrical voltage signal. Fast 14 bit A/D converters digitize the previously amplified and serialized video signal. A digital signal processor calculates a temperature value for each pixel and generates the known false color images in real time.

Thermal imaging cameras require a rather complex calibration, in which a number of sensitivity values are allocated to each pixel at different chip and black body temperatures. To increase measuring accuracy, bolometer FPAs are often

stabilized at defined chip temperatures with high control accuracy.

Due to the development of better performing, smaller and at the same time less expensive laptops, UMPCs, netbooks and tablet PCs, it is currently possible to use their

- big displays for attractive thermal image presentations,
- optimized Li-Ion rechargeable batteries as power supply,
- computation capacity for flexible and high-quality real time signal display,
- large memories for practically unlimited infrared video records and
- Ethernet, Bluetooth, WLAN and software interfaces for the integration of the thermographic system into their application environment.

The standardized USB 2.0 interface is available everywhere and assures data transmission rates of

- 30 Hz with 320×340 pixel image resolution and
- 120 Hz with image sizes of 20.000 pixel.

The USB 3.0 technology is even suitable for XGA thermal image resolutions up to 100 Hz video frequency. The use of the webcam principle in the field of thermography enables totally new product features with significantly improved price-performance ratio. The infrared camera is connected via a 480 MegaBaud interface in real time with a Windows® based computer, which simultaneously supplies the required power.



USB infrared cameras for thermal image transmission with resolutions up to 640×480 pixels and up to 1,000 Hz

USB IR camera hardware

USB was previously seen as a pure office communication medium. Unlike FireWire, the very broad use of this standard interface has initiated a number of developments to improve industrial applicability and consequently the usability of USB 2.0 end devices – especially USB cameras. The innovations include:

- drag chain compatibles and up to 200 °C resistant USB cables with lengths of up to 10 m [4]
- Cat. 5e (Ethernet) cable extensions of up to 100 m with signal amplifiers
- Optical fiber to USB modems for cable lengths of up to 10 km [5]

Due to the high bandwidth of the USB bus, it is possible, for example, to connect up to six 120 Hz IR cameras to a laptop via a standard hub over a 100 m Ethernet cable.

The water-tight, vibration and shock resistant thermal imaging devices are NEMA 4 rated and therefore also suitable for demanding applications in test booths. Dimensions of 4 x 5 x 4 cubic centimeters and a weight of 200 grams significantly reduce cooler housing and air purges efforts.

Due to the thermal drift of bolometers and their on-chip signal processing, all globally marketed IR measuring cameras require offset correction in specific intervals. This correction is done by positioning a mechanically driven piece of blackened metal in front of the image sensor.

As a result, each image element is referenced with the same known temperature. During this type of offset calibrations, thermal cameras are of course blind. In order to minimize this disturbing effect, the offset correction can be initiated by an external control pin at a suitable point of time. At the same time, the cameras are designed to minimize the duration of their self-calibration: The installation of correspondingly fast

actuators in the USB IR camera enables self-referencing within 250 ms. This is comparable with the time it takes to blink an eye and therefore acceptable for many of measurement processes. In conveyor belt processes in which sudden hot spots have to be detected, promptly generated “good” reference images can often be used for dynamic difference image measurement. This enables continuous operation without a mechanically moved component.



To enable offset referencing, the whole field of view of an infrared sensor array is closed for a brief period

Especially in applications where 10.6 µm-CO₂ lasers are used, externally controlled closure of the optical channel is favorable in connection with simultaneous independent signaling of this optomechanically-self protected camera operation mode. Due to a good filter blocking, temperature measurements for all other laser operating in the spectral range between 800 nm and 2.6 µm can be conducted in situ.

Main application areas of the described thermal imaging device are:

- Analysis of dynamic thermal processes during product and process development,
- Stationary use for continuous monitoring and control of heating and cooling procedures and
- Occasional use in electrical and mechanical maintenance and for the detection of thermal leakages in buildings



Thermal imagers and applications

The advantages of 120 Hz video recording have been established for applications in the R&D area. Thermal processes that have only been shown in the camera's field of view for a short time can be analyzed in slow motion. This enables the extraction of individual frames from a video sequence in full geometric and thermal resolution. In addition, exchangeable lenses, including a microscope accessory, offer many options to adapt the camera to different measuring tasks. While 9° optics are rather suitable to monitor details from a greater distance, a microscope accessory can be used to measure objects with dimensions of 4 x 3 mm² and with a geometric resolution of 25 x 25 μm².

A galvanically isolated process interface is best for built-in USB IR cameras, where the temperature information generated by the thermal image can be transmitted as signal voltage. In addition, area referenced emissivities and contact or non-contact measured reference temperatures can be transmitted via voltage input to the camera system. For documentation purposes, an additional digital input can initialize snapshots and video sequences. Such individual product-related thermal images can be stored automatically on central servers.

Thermal analysis software guarantees flexibility

No driver installation is required, since USB IR cameras use the standard USB video class and HID driver already integrated in Windows XP and higher. The single pixel related real-time correction of the video data and temperature calculation are done on a PC. The impressive image quality at only 20,000 sensor pixels is achieved by a complex software-based rendering algorithm, which calculates temperature fields in VGA format.

The application software is characterized by a high flexibility and portability. In addition to standard functions, the software also has the following advanced features:

- Numerous data and thermal imaging export functions to support reports and offline analyses
- Mixed scalable color pallets with isotherms
- Freely positionable profile display
- Unlimited number of measuring areas with separate alarm options
- Comparative video displays based on reference images, temperature/ time diagrams for different regions of interest

The software also provides a layout mode, which saves and stores different modes of presentation. An integrated video software enables radiometric AVI (.ravi) file editing. These file types can also be analyzed offline using software with multiple parallel usability. The video acquisition modes also allow the intermittent recording of slow thermal processes and their fast display.

The transfer of real time data to other programs is done using a comprehensively documented DLL as part of a software development kit. All other camera functions can be controlled via this DLL interface. Alternatively, the software can communicate with a serial port and, for example, directly connected to an RS422 interface.

Applications

In the next chapter, five typical applications are discussed, which describe the wide range of USB infrared camera applications.

1. Manufacturing process optimization

The production of plastic parts like PET bottles requires a defined temperature increase of the so-called preforms in order to guarantee a homogeneous material thickness during blow molding. Test runs are done with only a few of the 20 mm thick blanks at full working speed of about 1 m/s.

In order to measure the temperature profile of a preform, a video sequence with 120 Hz must be recorded since the moment when the blanks are in the field of view can vary.

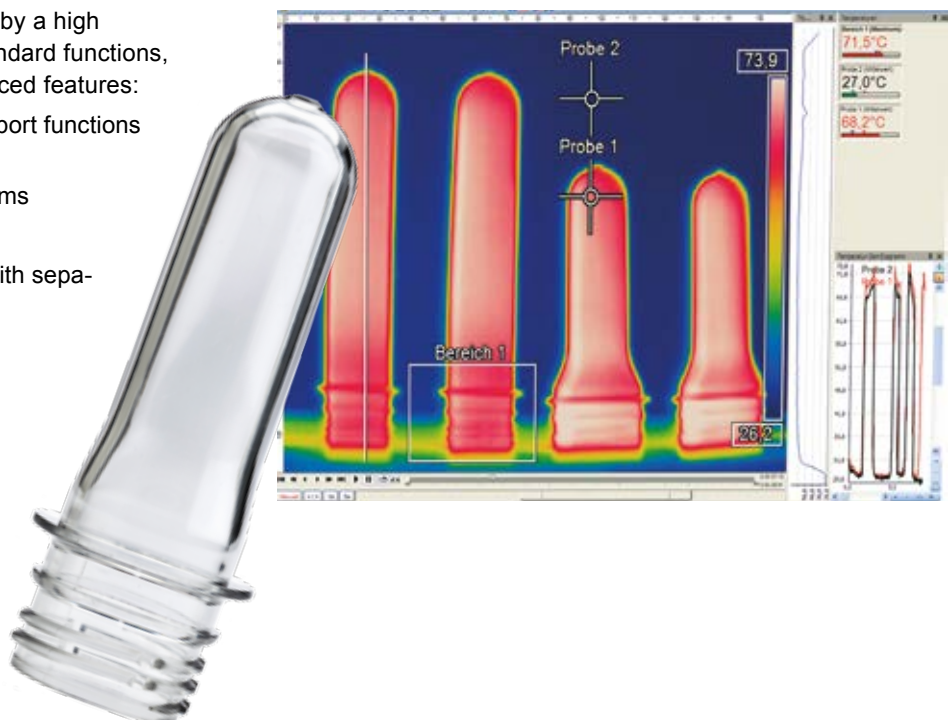

The camera is positioned in such a way that it follows the motion of the material in an oblique angle – similar to the view of the last wagon of a moving train. The IR video sequence ultimately delivers the temperature profile, which is essential for the adjustment of heating parameters.

During vacuum forming of large scale plastic parts for refrigerators, video recordings enable the exact measurement of the cooling behavior at various areas of form pieces. Different cooling speeds may result in material warping. In addition, cooling speed optimization may prevent memory effects in the plastic. Those effects basically represent form changes after a certain time e.g. on dash-boards. Similar to an oscilloscope for the analysis of electric signal behaviors, the IR video camera is an important tool to qualify dynamic thermal processes.

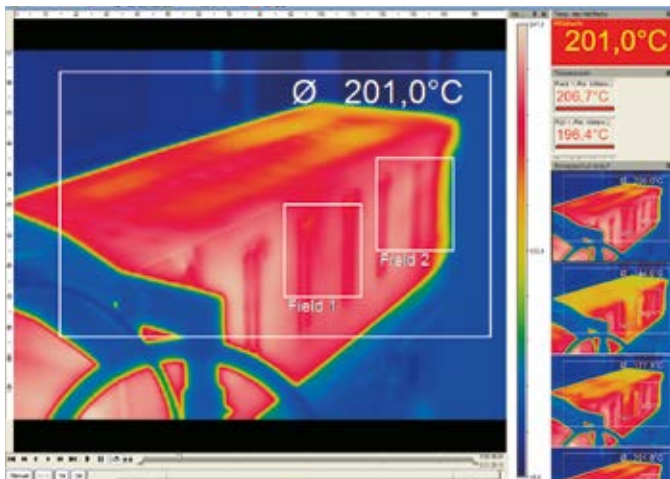

Examples for different options of IR video and image-analysis

2. H1N1 fever inspection of travelers



Monitoring skin surface temperature of travelers

Ebola and the swine flu virus epidemic created a global demand for suitable screening techniques enabling fast non-contact detection of travelers possibly having fever, to prevent them from spreading the disease by air travel. It is based on the measurement of face temperature in the eye cavity area to determine the core body temperature. Although this method does not represent an absolutely accurate fever temperature measurement, it is still suitable for screening larger groups of travelers with sufficiently high detection reliability.

Normal IR cameras are only ± 2 °C accurate due to the limited

- stability of the sensing system and the
- imaging quality of the widely opened optics.

For measurements in the medical area, this uncertainty is insufficient. Therefore, reference radiators have been developed that provide a measuring accuracy of 0.2 °C at 34 °C radiation temperature. Those emitters are positioned on the border of the IR image at the same distance as the skin surface. Core of the measurement system is a certified IR thermometer with 25 mK thermal resolution. This device integrated in the reference radiator measures thermal radiation and transmits the actual temperature values via 4–20 mA interface to the analog port of the IR camera. The software calculates a correction value in the corresponding image area, which is also used for all other pixels of the measuring image. An alarm is automatically triggered if the present fever temperature is measured and a radiometric image is stored for documentation. For the affected persons, a contact fever measurement must subsequently be taken e.g. using an ear thermometer.

Thermal imagers and applications

3. Line scanning cameras in glass tempering facilities

After construction glass has been cut to its final form, its surface must usually be toughened. This is done in glass tempering facilities, where the glass is heated in furnaces to about 600 °C. After this heating process, rollers transport the material from the oven into a cooling section, where the surface is cooled down quickly and evenly. This creates a fine crystalline hardened structure, which is essential for safety glass. The fine structure and especially the breaking resistance of the glass depends on uniform heating and cooling of all surface parts.

Since furnace housing and cooling section are located close to each other, it is only possible to monitor the glass surfaces leaving the oven through a small slot. As a result, the infrared image of the material is only shown a few lines. The software displays the glass surface as an image generated out of a specified amount of lines.

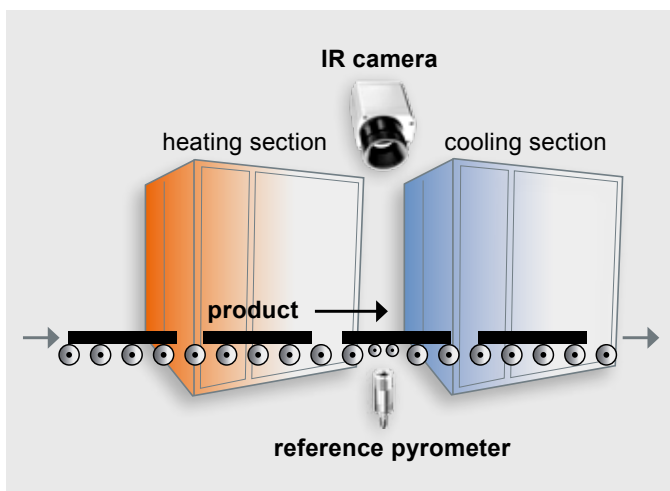

Thermal image measurement on a glass tempering line with IR camera and reference pyrometer

The camera measures the slot in a diagonal mode, enabling an overall field of view of 60° with a 48° lens. Glass has different emissivities depending on its coating layers. An IR thermometer measures the exact temperature on the non-coated lower side at the optimal wave-length of 5 μm for those surfaces. These temperatures, measured along a column of the measuring image, are transmitted to the analog input of the camera and compared with the corresponding camera measuring values. The result is a corrected emissivity, calculated for the overall measuring image. Ultimately, the measuring images allow exact adjustment of all heating sections in the furnace, assuring good thermal homogeneity.

4. Infrared cameras for aerial thermography

The application of thermal imaging cameras on drones and other airborne objects is growing. The scope of application is hereby quite broad: from the control and thermal analysis of major industrial facilities and buildings, follow-up fire monitoring to find smoldering nests and missing persons, and even for taking population census in the field. Airborne operated thermography for quality assurance and maintenance of photovoltaic systems is of particular significance. The systems must operate efficiently to quickly redeem the high acquisition costs. To ensure reliable operation, faulty solar modules must be promptly repaired.

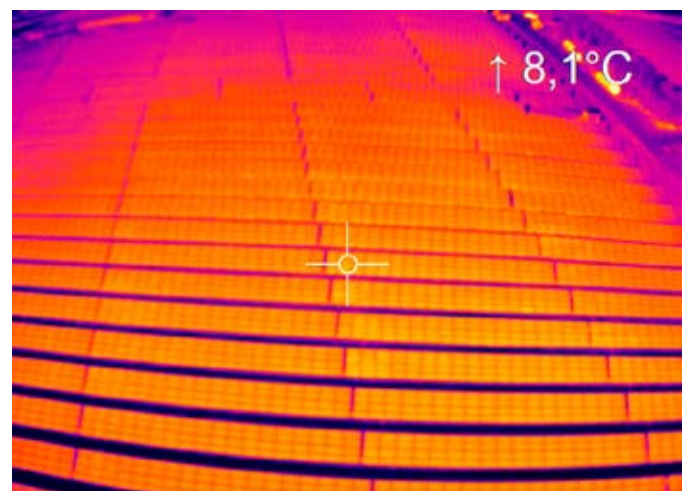

Temperature monitoring of solar park

5. Inline temperature measurement technology for food production plant management

The challenge in producing ready-made meals, is to produce a finished product containing different ingredients that tastes good despite industrial preparation. For reasons of food safety, all ingredients are required to be heated to 95 °C. If a steam cooker was used for processing, the vegetables would turn to mush before the meat was cooked.



Temperature monitoring during heating of broccoli florets

The globally unique processing technology of Naprotec, a company located in Zetel, uses microwave technology for heating. It takes advantage of the effect that each food has its own individual frequency for particularly fast heating. In compliance with the HACCP concept (Hazard Analysis and Critical Control Points), both the monitoring of pasteurization temperatures for the ready-made meals, which are sealed in PE foil-covered tubs, and the management of the system are conducted using an optris® PI 160 infrared camera.

Conclusions

In regard to flexibility and broad scope of applications, the new camera technology is an innovation on the infrared market. In addition to sophisticated temperature analysis, when connected to tablet PCs the device can also be used to solve simple maintenance tasks. With the exception of the hardware of the USB IR camera measuring heads, both of the other key components of the thermographic system described here – Windows software and PC hardware – can also be updated later. On the one hand, this is done by simply downloading software updates and upgrades. On the other hand, the standard USB interface makes it possible to supplement the measuring system at any time with innovative technological and functional PC hardware.



Literature

References

- [1] VDI/VDE Richtlinie, Technische Temperaturmessungen – Spezifikation von Strahlungsthermometern, Juni 2001, VDI 3511 Blatt 4.1
- [2] VDI/ VDE Richtlinie Technische Temperaturmessungen, Strahlungsthermometrie – Kalibrierung von Strahlungsthermometern, 2004, VDI/ VDE 3511, Blatt 4.3
- [3] Trouilleau, C. et al.: High-performance uncooled amorphous silicon TEC less XGA IRFPA with 17 μm pixel-pitch; "Infrared technologies and applications XXXV", Proc. SPIE 7298, 2009
- [4] Schmidgall, T.; Glänzend gelöst – Fehlerdetektion an spiegelnden Oberflächen mit USB2.0 – Industriekameras, A&D Kompendium 2007/2008, S. 219
- [5] Icron Technology Corp.; Options for Extending USB, White Paper, Burnaby; Canada, 2009

Recommended literature

1. VDI/VDE Richtlinie, Technische Temperaturmessungen – Spezifikation von Strahlungsthermometern, Juni 2001, VDI 3511 Blatt 4.1
2. Stahl, Miosga: Grundlagen Infrarottechnik, 1980, Dr. Alfred Hütthig Verlag Heidelberg
3. Walther, Herrmann: Wissensspeicher Infrarotmesstechnik, 1990, Fachbuchverlag Leipzig
4. Walther, L., Gerber, D.: Infrarotmesstechnik, 1983, Verlag Technik Berlin
5. De Witt, Nutter: Theory and Practice of Radiation Thermometry, 1988, John Wiley & Son, New York, ISBN 0-471-61018-6
6. Wolfe, Zissis: The Infrared Handbook, 1978, Office of Naval Research, Department of the Navy, Washington DC.
7. Crastes, A. et al.: Uncooled amorphous silicon $\frac{1}{4}$ VGA IRFPA with 25 μm pixel-pitch for High End applications, "Infrared technologies and applications XXXIV", Proc. SPIE 6940, 2008
8. Holst, Gerald C.: Electro-optical Imaging System Performance, JCD Publishing Winter Park, Florida USA, 2006, ISBN: 0-8194-6179-2
9. Ulrich Kienitz: Thermal imaging as a modern form of pyrometry, in: Journal of Sensors and Sensor Systems, 3, 265–271, 2014.

Term	Explanation
Absorption	Ratio of absorbed radiation by an object to incoming radiation. A number between 0 and 1.
Emissivity	Emitted radiation of an object compared to the radiation from a black body source. A number between 0 and 1.
Filter	Material, only permeable by certain infrared wavelengths.
FOV	Field of view: Horizontal field of view of an infrared lens.
FPA	Focal Plane Array: type of an infrared detector.
Gray Body Source	An object, which emits a certain part of the energy which a black body source emits at every wavelength.
IFOV	Instantaneous field of view: A value for the geometric resolution of a thermal imager.
NETD	Noise equivalent temperature difference. A value for the noise (in the image) of a thermal imager.
Object parameter	Values, with which measurement conditions and measuring object are described (e.g. emissivity, ambient temperature, distance, etc.)
Object signal	A non-calibrated value, which refers to the radiation the thermal imager receives from the measuring object.
Palette	Colors of the infrared image
Pixel	Synonym for picture element. A single picture point in an image.
Reference temperature	Temperature value used to compare regular measuring data.
Reflection	Ratio of radiation reflected by the object and incoming radiation. A number between 0 and 1.
Black body source	Object with a reflection of 0. Any radiation is based on its own temperature.
Spectral specific radiation	Energy emitted by an object relevant to time, area and wavelength ($W/m^2/\mu m$).
Specific radiation	Energy emitted from an object relevant to units of time and area (W/m^2).
Radiation	Energy emitted by an object relevant to time, area and solid angle ($W/m^2/sr$).
Radiation flow	Energy emitted by an object relevant to the unit of time (W).
Temperature difference	A value determined by subtraction of one temperature value from another.
Temperature range	Current temperature measuring range of a thermal imager. Imagers can have several temperature ranges. They are described with the help of two black body source values, which serve as threshold values for the current calibration.
Thermogram	Infrared image
Transmissivity	Gases and solid states have different transmissivities. Transmissivity describes the level of infrared radiation, which permeates the object. A number between 0 and 1.
Ambient environment	Objects and gases, which pass radiation to the measuring object.

Appendix: Emissivity table

Below you will find a list of emissivities from technical literature and from measurements carried out by Optris GmbH.

References

1. Mikaél A. Bramson: Infrared Radiation, A Handbook for Applications, Plenum Press, N.Y.
2. William L. Wolfe, George J. Zissis: The Infrared Handbook, Office of Naval Research, Department of Navy, Washington, D.C.
3. Madding, R.P.: Thermographic Instruments and Systems. Madison, Wisconsin: University of Wisconsin – Extension, Department of Engineering and Applied Science
4. William L. Wolfe: Handbook of Military Infrared Technology, Office of Naval Research, Department of Navy, Washington, D.C.
5. Jones, Smith, Probert: External thermography of buildings ..., Proc. Of the Society of Phot-Optical Instrumentation Engineers, vol. 110, Industrial and Civil Applications of Infrared Technology, Juni 1977 London
6. Paljak, Pettersson: Thermography of Buildings, Swedish Building Research Institute, Stockholm 1972
7. Vlcek, J.: Determination of emissivity with imaging radiometers and some emissivities at $\lambda = 5 \mu\text{m}$. Photogrammetric Engineering and Remote Sensing.
8. Kern: Evaluation of infrared emission of clouds and ground as measured by weather satellites, Defence Documentation Center, AD 617 417.
9. Öhman, Claes: Emittansmätningar med AGEMA E-Box. Teknisk rapport, AGEMA 1999. (Emissionsmessungen mit AGEMA E-Box. Technischer Bericht, AGEMA 1999.)
10. VDI/VDE - Richtlinien 3511, Blatt 4, technische Temperaturmessungen, Strahlungsthermometrie, Dez. 2011

T: total spectrum SW: 2–5 μm LW: 8–14 μm LLW: 6,5–20 μm					
					References
Material	Specification	Temperature in °C	Spectrum	Emissivity	R
Aluminum	Plate, 4 samples differently scratched	70	LW	0.03–0.06	9
Aluminum	Plate, 4 samples differently scratched	70	SW	0.05–0.08	9
Aluminum	anodized, light gray, dull	70	LW	0.97	9
Aluminum	anodized, light gray, dull	70	SW	0.61	9
Aluminum	anodized, light gray, dull	70	LW	0.95	9
Aluminum	anodized, light gray, dull	70	SW	0.67	9
Aluminum	anodized plate	100	T	0.55	2
Aluminum	film	27	3 μm	0.09	3
Aluminum	film	27	10 μm	0.04	3
Aluminum	roughened	27	3 μm	0.28	3
Aluminum	roughened	27	10 μm	0.18	3
Aluminum	cast, sandblasted	70	LW	0.46	9
Aluminum	cast, sandblasted	70	SW	0.47	9
Aluminum	dipped in HNO ₃ , plate	100	T	0.05	4
Aluminum	polished	50–100	T	0.04–0.06	1
Aluminum	polished, plate	100	T	0.05	2
Aluminum	polished, plate	100	T	0.05	4
Aluminum	roughened surface	20–50	T	0.06–0.07	1
Aluminum	deeply oxidized	50–500	T	0.2–0.3	1
Aluminum	deeply weather beaten	17	SW	0.83–0.94	5
Aluminum	unchanged, plate	100	T	0.09	2
Aluminum	unchanged, plate	100	T	0.09	4
Aluminum	vacuumcoated	20	T	0.04	2
Aluminum bronze		20	T	0.6	1
Aluminum-hydroxide	powder		T	0.28	1
Aluminumoxide	activated, powder		T	0.46	1
Aluminumoxide	clean, powder (aluminium oxide)		T	0.16	1
Asbestos	floor tiles	35	SW	0.94	7
Asbestos	boards	20	T	0.96	1
Asbestos	tissue		T	0.78	1
Asbestos	paper	40–400	T	0.93–0.95	1
Asbestos	powder		T	0.40–0.60	1
Asbestos	brick	20	T	0.96	1
Asphalt, road surface		4	LLW	0.967	8
Brass	treated with 80-sandpaper	20	T	0.2	2
Brass	plate, milled	20	T	0.06	1
Brass	plate, treated with sandpaper	20	T	0.2	1
Brass	strongly polished	100	T	0.03	2
Brass	oxidized	70	SW	0.04–0.09	9
Brass	oxidized	70	LW	0.03–0.07	9

Material	Specification	Temperature in °C	Spectrum	Emissivity	R
Brass	oxidized	100	T	0.61	2
Brass	oxidized at 600 °C	200–600	T	0.59–0.61	1
Brass	polished	200	T	0.03	1
Brass	blunt, patchy	20–350	T	0.22	1
Brick	aluminum oxide	17	SW	0.68	5
Brick	dinas-silicon oxide, fireproof	1000	T	0.66	1
Brick	dinas-silicon oxide, glazed, toughened	1100	T	0.85	1
Brick	dinas-silicon oxide, glazed, toughened	1000	T	0.8	1
Brick	fireproof product, corundom	1000	T	0.46	1
Brick	fireproof product, magnesit	1000–1300	T	0.38	1
Brick	fireproof product, mildly beaming	500–1000	T	0.76–0.80	1
Brick	fireproof product, strongly beaming	500–1000	T	0.8–0.9	1
Brick	fire brick	17	SW	0.68	5
Brick	glazed	17	SW	0.94	5
Brick	brickwork	35	SW	0.94	7
Brick	brickwork, plastered	20	T	0.94	1
Brick	normal	17	SW	0.86–0.81	5
Brick	red, normal	20	T	0.93	2
Brick	red, raw	20	T	0.88–0.93	1
Brick	chamotte	20	T	0.85	1
Brick	chamotte	1000	T	0.75	1
Brick	chamotte	1200	T	0.59	1
Brick	amorphous silicon, 95 % SiO ₂	1230	T	0.66	1
Brick	sillimanite, 33 % SiO ₂ , 64 % Al ₂ O ₃	1500	T	0.29	1
Brick	waterproof	d17	SW	0.87	5
Bronze	phosphorbronze	70	LW	0.06	9
Bronze	phosphorbronze	70	SW	0.08	1
Bronze	polished	50	T	0.1	1
Bronze	porous, harshened	50–100	T	0.55	1
Bronze	powder		T	0.76–0.80	1
Carbon	Grafit, surface filed	20	T	0.98	2
Carbon	plumbago powder		T	0.97	1
Carbon	charcoal powder		T	0.96	1
Carbon	candle soot	20	T	0.95	2
Carbon	lamp soot	20–400	T	0.95–0.97	1
Cast Iron	treated	800–1000	T	0.60–0.70	1
Cast Iron	fluent	1300	T	0.28	1
Cast Iron	cast	50	T	0.81	1
Cast Iron	blocks made of cast iron	1000	T	0.95	1
Cast Iron	oxidized	38	T	0.63	4
Cast Iron	oxidized	100	T	0.64	2
Cast Iron	oxidized	260	T	0.66	4
Cast Iron	oxidized	538	T	0.76	4
Cast Iron	oxidized at 600 °C	200–600	T	0.64–0.78	1
Cast Iron	polished	38	T	0.21	4

Appendix: Emissivity table

Material	Specification	Temperature in °C	Spectrum	Emissivity	R
Cast Iron	polished	40	T	0.21	2
Cast Iron	polished	200	T	0.21	1
Cast Iron	untreated	900–1100	T	0.87–0.95	1
Chipboard	untreated	20	SW	0.9	6
Chrome	polished	50	T	0.1	1
Chrome	polished	500–1000	T	0.28–0.38	1
Clay	burnt	70	T	0.91	1
Cloth	black	20	T	0.98	1
Concrete		20	T	0.92	2
Concrete	pavement	5	LLW	0.974	8
Concrete	roughened	17	SW	0.97	5
Concrete	dry	36	SW	0.95	7
Copper	electrolytic, brightly polished	80	T	0.018	1
Copper	electrolytic, polished	–34	T	0.006	4
Copper	scraped	27	T	0.07	4
Copper	molten	1100–1300	T	0.13–0.15	1
Copper	commercial, shiny	20	T	0.07	1
Copper	oxidized	50	T	0.6–0.7	1
Copper	oxidized, dark	27	T	0.78	4
Copper	oxidized, deeply	20	T	0.78	2
Copper	oxidized, black		T	0.88	1
Copper	polished	50–100	T	0.02	1
Copper	polished	100	T	0.03	2
Copper	polished, commercial	27	T	0.03	4
Copper	polished, mechanical	22	T	0.015	4
Copper	clean, thoroughly prepared surface	22	T	0.008	4
Copperoxide	powder		T	0.84	1
Copperoxide	red, powder		T	0.7	1
Earth	saturated with water	20	T	0.95	2
Earth	dry	20	T	0.92	2
Enamel		20	T	0.9	1
Enamel	paint	20	T	0.85–0.95	1
Fiberboard	hard, untreated	20	SW	0.85	6
Fiberboard	Ottrelith	70	LW	0.88	9
Fiberboard	Ottrelith	70	SW	0.75	9
Fiberboard	particle plate	70	LW	0.89	9
Fiberboard	particle plate	70	SW	0.77	9
Fiberboard	porous, untreated	20	SW	0.85	6
Glass	thin	25	LW	0.8–0.95	10
Glazing Rebates	8 different colors and qualities	70	LW	0.92–0.94	9
Glazing Rebates	9 different colors and qualities	70	SW	0.88–0.96	9
Glazing Rebates	aluminum, different age	50–100	T	0.27–0.67	1
Glazing Rebates	on oily basis, average of 16 colors	100	T	0.94	2
Glazing Rebates	chrome green		T	0.65–0.70	1
Glazing Rebates	cadmium yellow		T	0.28–0.33	1
Glazing Rebates	cobalt blue		T	0.7–0.8	1

Material	Specification	Temperature in °C	Spectrum	Emissivity	R
Glazing Rebates	plastics, black	20	SW	0.95	6
Glazing Rebates	plastics, white	20	SW	0.84	6
Glazing Rebates	oil	17	SW	0.87	5
Glazing Rebates	oil, different colors	100	T	0.92–0.96	1
Glazing Rebates	oil, shiny gray	20	SW	0.96	6
Glazing Rebates	oil, gray, dull	20	SW	0.97	6
Glazing Rebates	oil, black, dull	20	SW	0.94	6
Glazing Rebates	oil, black, shiny	20	SW	0.92	6
Gold	brightly polished	200–600	T	0.02–0.03	1
Gold	strongly polished	100	T	0.02	2
Gold	polished	130	T	0.018	1
Granite	polished	20	LLW	0.849	8
Granite	roughened	21	LLW	0.879	8
Granite	roughened, 4 different samples	70	LW	0.77–0.87	9
Granite	roughened, 4 different samples	70	SW	0.95–0.97	9
Gypsum		20	T	0.8–0.9	1
Gypsum, applied		17	SW	0.86	5
Gypsum, applied	gypsum plate, untreated	20	SW	0.9	6
Gypsum, applied	roughened surface	20	T	0.91	2
Iron and Steel	electrolytic	22	T	0.05	4
Iron and Steel	electrolytic	100	T	0.05	4
Iron and Steel	electrolytic	260	T	0.07	4
Iron and Steel	electrolytic, brightly polished	175–225	T	0.05–0.06	1
Iron and Steel	freshly milled	20	T	0.24	1
Iron and Steel	freshly processed with sandpaper	20	T	0.24	1
Iron and Steel	smoothed plate	950–1100	T	0.55–0.61	1
Iron and Steel	forged, brightly polished	40–250	T	0.28	1
Iron and Steel	milled plate	50	T	0.56	1
Iron and Steel	shiny, etched	150	T	0.16	1
Iron and Steel	shiny oxide layer, plate	20	T	0.82	1
Iron and Steel	hot milled	20	T	0.77	1
Iron and Steel	hot milled	130	T	0.6	1
Iron and Steel	cold milled	70	LW	0.09	9
Iron and Steel	cold milled	70	SW	0.2	9
Iron and Steel	covered with red dust	20	T	0.61–0.85	1
Iron and Steel	oxidized	100	T	0.74	1
Iron and Steel	oxidized	100	T	0.74	4
Iron and Steel	oxidized	125–525	T	0.78–0.82	1
Iron and Steel	oxidized	200	T	0.79	2
Iron and Steel	oxidized	200–600	T	0.8	1
Iron and Steel	oxidized	1227	T	0.89	4
Iron and Steel	polished	100	T	0.07	2
Iron and Steel	polished	400–1000	T	0.14–0.38	1

Material	Specification	Temperature in °C	Spectrum	Emissivity	R
Iron and Steel	polished plate	750 – 1050	T	0.52 – 0.56	1
Iron and Steel	harshened, even surface	50	T	0.95 – 0.98	1
Iron and Steel	rusty, red	20	T	0.69	1
Iron and Steel	rusty, red, plate	22	T	0.69	4
Iron and Steel	deeply oxidized	50	T	0.88	1
Iron and Steel	deeply oxidized	500	T	0.98	1
Iron and Steel	deeply rusted	17	SW	0.96	5
Iron and Steel	deeply rusted plate	20	T	0.69	2
Iron tinned	plate	24	T	0.064	4
Ice:	see water				
Iron, galvanized	plate	92	T	0.07	4
Iron, galvanized	plate, oxidized	20	T	0.28	1
Iron, galvanized	plate, oxidized	30	T	0.23	1
Iron, galvanized	deeply oxidized	70	LW	0.85	9
Iron, galvanized	deeply oxidized	70	SW	0.64	9
Lead	shiny	250	T	0.08	1
Lead	non oxidized, polished	100	T	0.05	4
Lead	oxidized, gray	20	T	0.28	1
Lead	oxidized, gray	22	T	0.28	4
Lead	oxidized at 200 °C	200	T	0.63	1
Lead, red		100	T	0.93	4
Lead, red, powder		100	T	0.93	1
Leather	tanned fur		T	0.75 – 0.80	1
Limestone			T	0.3 – 0.4	1
Magnesium		22	T	0.07	4
Magnesium		260	T	0.13	4
Magnesium		538	T	0.18	4
Magnesium	polished	20	T	0.07	2
Magnesium-powder			T	0.86	1
Molybdenum		600 – 1000	T	0.08 – 0.13	1
Molybdenum		1500 – 2200	T	0.19 – 0.26	1
Molybdenum	twine	700 – 2500	T	0.1 – 0.3	1
Mortar		17	SW	0.87	5
Mortar	dry	36	SW	0.94	7
Nickel	wire	200 – 1000	T	0.1 – 0.2	1
Nickel	electrolytic	22	T	0.04	4
Nickel	electrolytic	38	T	0.06	4
Nickel	electrolytic	260	T	0.07	4
Nickel	electrolytic	538	T	0.1	4
Nickel	galvanized, polished	20	T	0.05	2
Nickel	galvanized on iron, not polished	20	T	0.11-0.40	1
Nickel	galvanized on iron, not polished	22	T	0.11	4
Nickel	galvanized on iron, not polished	22	T	0.045	4
Nickel	light dull	122	T	0.041	4

Material	Specification	Temperature in °C	Spectrum	Emissivity	R
Nickel	oxidized	200	T	0.37	2
Nickel	oxidized	227	T	0.37	4
Nickel	oxidized	1227	T	0.85	4
Nickel	oxidized at 600 °C	200 – 600	T	0.37 – 0.48	1
Nickel	polished	122	T	0.045	4
Nickel	clean, polished	100	T	0.045	1
Nickel	clean, polished	200 – 400	T	0.07 – 0.09	1
Nickel-chrome	wire, bare	50	T	0.65	1
Nickel-chrome	wire, bare	500 – 1000	T	0.71 – 0.79	1
Nickel-chrome	wire, oxidized	50 – 500	T	0.95 – 0.98	1
Nickel-chrome	milled	700	T	0.25	1
Nickel-chrome	sandblasted	700	T	0.7	1
Nickel-oxide		500 - 650	T	0.52 – 0.59	1
Nickel-oxide		1000 – 1250	T	0.75 – 0.86	1
Oil, Lubricating Oil	0.025-mm-layer	20	T	0.27	2
Oil, Lubricating Oil	0.050-mm-layer	20	T	0.46	2
Oil, Lubricating Oil	0.125-mm-layer	20	T	0.72	2
Oil, Lubricating Oil	thick layer	20	T	0.82	2
Oil, Lubricating Oil	layer on Ni-basis, only Ni-basis	20	T	0.05	2
Paint	3 colors, sprayed on aluminum	70	LW	0.92 – 0.94	9
Paint	4 colors, sprayed on aluminum	70	SW	0.50 – 0.53	9
Paint	aluminium on harshened surface	20	T	0.4	1
Paint	bakelite	80	T	0.83	1
Paint	heat-proof	100	T	0.92	1
Paint	black, shiny, sprayed on iron	20	T	0.87	1
Paint	black, dull	100	T	0.97	2
Paint	black, dull	40 – 100	T	0.96 – 0.98	1
Paint	white	40 – 100	T	0.8 – 0.95	1
Paint	white	100	T	0.92	2
Paper	4 different colors	70	LW	0.92 – 0.94	9
Paper	4 different colors	70	SW	0.68 – 0.74	9
Paper	coated with black paint		T	0.93	1
Paper	dark blue		T	0.84	1
Paper	yellow		T	0.72	1
Paper	green		T	0.85	1
Paper	red		T	0.76	1
Paper	black		T	0.9	1
Paper	black, blunt		T	0.94	1
Paper	black, blunt	70	LW	0.89	9
Paper	black, blunt	70	SW	0.86	9
Paper	white	20	T	0.7 – 0.9	1
Paper	white, 3 different shiny coatings	70	LW	0.88 – 0.90	9

Appendix: Emissivity table

Material	Specification	Temperature in °C	Spectrum	Emissivity	R
Paper	white, 3 different shiny coatings	70	SW	0.76–0.78	9
Paper	white, bonded	20	T	0.93	2
Plastics	fiber optics laminate (printed circuit board)	70	LW	0.91	9
Plastics	fiber optics laminate (printed circuit board)	70	SW	0.94	9
Plastics	polyurethane-insulating plate	70	LW	0.55	9
Plastics	polyurethane-insulating plate	70	SW	0.29	9
Plastics	PVC, plastic floor, blunt, structured	70	LW	0.93	9
Plastics	PVC, plastic floor, blunt, structured	70	SW	0.94	9
Platinum		17	T	0.016	4
Platinum		22	T	0.05	4
Platinum		260	T	0.06	4
Platinum		538	T	0.1	4
Platinum		1000–1500	T	0.14–0.18	1
Platinum		1094	T	0.18	4
Platinum	band	900–1100	T	0.12–0.17	1
Platinum	wire	50–200	T	0.06–0.07	1
Platinum	wire	500–1000	T	0.10–0.16	1
Platinum	wire	1400	T	0.18	1
Platinum	clean, polished	200–600	T	0.05–0.10	1
Polystyrene	heat insulation	37	SW	0.6	7
Porcelain	glazed	20	T	0.92	1
Porcelain	white, glowing		T	0.70–0.75	1
Rubber	hard	20	T	0.95	1
Rubber	soft, gray, harshened	20	T	0.95	1
Sand			T	0.6	1
Sand		20	T	0.9	2
Sandpaper	coarse	80	T	0.85	1
Sandstone	polished	19	LLW	0.909	8
Sandstone	harshened	19	LLW	0.935	8
Silver	polished	100	T	0.03	2
Silver	clean, polished	200–600	T	0.02–0.03	1
Skin	Human Being	32	T	0.98	2
Slag	basin	0–100	T	0.97–0.93	1
Slag	basin	200–500	T	0.89–0.78	1
Slag	basin	600–1200	T	0.76–0.70	1
Slag	basin	1400–1800	T	0.69–0.67	1
Snow:	see water				
Stainless steel	plate, polished	70	LW	0.14	9
Stainless steel	plate, polished		SW	0.18	9
Stainless steel	plate, not treated, scratched	70	LW	0.28	9
Stainless steel	plate, not treated, scratched	70	SW	0.3	9
Stainless steel	milled	700	T	0.45	1
Stainless steel	alloy, 8 % Ni, 18 % Cr	500	T	0.35	1
Stainless steel	sandblasted	700	T	0.7	1
Stainless steel	type 18–8, shiny	20	T	0.16	2

Material	Specification	Temperature in °C	Spectrum	Emissivity	R
Stainless steel	type 18–8, oxidized at 800 °C	60	T	0.85	2
Stucco	roughened, yellow green	90	T	0.91	1
Tar			T	0.79–0.84	1
Tar	paper	20	T	0.91–0.93	1
Tin	shiny	20–50	T	0.04–0.06	1
Tin	tin plate	100	T	0.07	2
Titanium	oxidized at 540 °C	200	T	0.4	1
Titanium	oxidized at 540 °C	500	T	0.5	1
Titanium	oxidized at 540 °C	1000	T	0.6	1
Titanium	polished	200	T	0.15	1
Titanium	polished	500	T	0.2	1
Titanium	polished	1000	T	0.36	1
Tungsten		200	T	0.05	1
Tungsten		600–1000	T	0.1–0.16	1
Tungsten		1500–2200	T	0.24–0.31	1
Tungsten	twine	3300	T	0.39	1
Varnish	on parquet flooring made of oak	70	LW	0.90–0.93	9
Varnish	on parquet flooring made of oak	70	SW	0.9	9
Varnish	dull	20	SW	0.93	6
Vulcanite			T	0.89	1
Wall Paper	slightly patterned, light gray	20	SW	0.85	6
Wall Paper	slightly patterned, red	20	SW	0.9	6
Water	distilled	20	T	0.96	2
Water	ice, strongly covered with frost	0	T	0.98	1
Water	ice, slippery	–10	T	0.96	2
Water	ice, slippery	0	T	0.97	1
Water	frost crystals	–10	T	0.98	2
Water	coated >0.1 mm thick	0–100	T	0.95–0.98	1
Water	snow		T	0.8	1
Water	snow	–10	T	0.85	2
Wood		17	SW	0.98	5
Wood		19	LLW	0.962	8
Wood	planed	20	T	0.8–0.9	1
Wood	planed oak	20	T	0.9	2
Wood	planed oak	70	LW	0.88	9
Wood	planed oak	70	SW	0.77	9
Wood	treated with sandpaper		T	0.5–0.7	1
Wood	pine, 4 different samples	70	LW	0.81–0.89	9
Wood	pine, 4 different samples	70	SW	0.67–0.75	9
Wood	plywood, even, dry	36	SW	0.82	7
Wood	plywood, untreated	20	SW	0.83	6
Wood	white, damp	20	T	0.7–0.8	1
Zinc	plate	50	T	0.2	1
Zinc	oxidized at 400 °C	400	T	0.11	1
Zinc	oxidized surface	1000–1200	T	0.50–0.60	1
Zinc	polished	200–300	T	0.04–0.05	1

Selection criteria for infrared thermometers

A wide selection of infrared sensors is available for non-contact temperature measurement. The following criteria will help to find the optimal measuring device for your application:

- Initial question
- Temperature range
- Environmental conditions
- Spot size
- Material and surface of the measuring object
- Response time of infrared thermometers
- Interface
- Emissivity

Initial question

The basic question is: point measurement or surface measurement? Based on the aim of application, the use of either an infrared thermometer or an infrared camera is possible. Once this is established, the product must be specified. In exceptional cases, there are also applications where both technologies would make sense; in this situation, we recommend consulting the relevant application engineers.

Temperature range

Choose the temperature range of the sensor as optimal as possible in order to reach a high resolution of the object temperature. The measuring ranges for IR-cameras can be adjusted to the measuring task manually or via digital interface.

Environmental conditions

The maximum acceptable ambient temperature of the sensors is very important. The optris® CT line operates in up to 250 °C without any cooling. By using water and air cooling the measuring devices operate in even higher ambient temperatures. Air purge systems help keep the lenses clean from additional dust in the atmosphere.

Spot size

The size of the measuring object has to be equal to or bigger than the viewing field of the sensor in order to reach accurate results. The spot diameter (S) changes accordingly to the distance of the sensor (D). The brochures specify the D:S relation for the different optics.

Further information is available on our online spot size calculator:
www.optris.co.uk/spot-size-calculator

Material and surface of the measuring object

The emissivity depends on material, surface and other factors. The common rule reads as follows: The higher the emissivity, the easier the measurement generates a precise result. Many infrared sensors offer adjustment of the emissivity. The appropriate values can be taken from the tables in the appendix.

Response time of infrared thermometers

The response time of infrared sensors is very fast as compared to contact thermometers. They range between 1 ms to 250 ms, strongly depending on the detector of the device. Due to the detector, response time is limited in the lower range. The electronics help to correct and adjust the response time according to the application (e.g. average or maximum hold).

Signal output interfaces

The interface supports the analysis of the measuring results. The following interfaces are available:

- Output/ alarm: 0/4 – 20 mA
- Output/ analog: 0 – 10 V
- Thermocouple: Type J, Type K
- Interfaces: CAN, Profibus-DP, RS232, RS485, USB, Relais, Ethernet



You can find an overview of the technical data of all Optris products in our product brochure:

www.optris.co.uk/downloads

innovative infrared technology

Optris GmbH
Ferdinand-Buisson-Str. 14
13127 Berlin · Germany
Phone: +49 (0)30 500 197-0
Fax: +49 (0)30 500 197-10
E-mail: info@optris.co.uk
www.optris.co.uk