

Garantie
12 ANS!
THERMOFORM
12-YEAR
Warranty!



Porte monopièce

Monopiece Door

Français | English

THERMOFORM

Composantes d'armoires polymères | *Polymer Cupboard Components*

Grâce à la productivité de l'entreprise, son service et sa supériorité technologique, Thermoform offre la plus grande variété de composantes d'armoires en Amérique du Nord.

La méthode de travail et les équipements perfectionnés de l'entreprise garantissent l'excellence de la production. Les défonceuses utilisées sont parmi les plus sophistiquées au monde : elles assurent des coupes lisses et permettent des variations infinies. Ainsi, il est possible de marier plusieurs profils intérieurs, profils extérieurs, styles et autres options.

Synonymous with high productivity, service and technological superiority, Thermoform offers the widest range of cupboard components in North America. Modern techniques and state-of-the-art equipment guarantee excellent production. Routers used are among the most sophisticated in the world, thus ensuring smooth cutting and an infinite number of variations, allowing inside profiles, edge profiles, styles and other options to be mixed and matched.



Variété et durabilité

Le polymère : un matériel tendance et pour longtemps!

Implantée solidement en Europe depuis plus de 25 ans, la technique du thermoformage a fait ses preuves. Elle connaît encore une popularité croissante dans plusieurs marchés grâce à ses possibilités infinies, ses coûts abordables et sa fiabilité à long terme.

Variety and durability

Polymer: a trendy material for a long time!

Used widely in Europe for more than 25 years, the technique of thermoforming has proved its worth. Its popularity is still growing in several markets through its infinite possibilities, affordability and long-term reliability.

Matériaux solides et raffinés

Les portes sont découpées dans des panneaux de fibre de pin, matériau idéal pour le thermoformage grâce à sa surface parfaitement lisse et sa densité qui met en valeur les détails machinés.

Strong and stylish material

Doors are cut out of pine fiber panels, the ideal material for thermoforming because of its perfectly smooth surface and density that enhance routing details.

Encollage supérieur

La durabilité et l'allure des composantes résident dans le processus d'encollage. Thermoform a mis au point un processus incomparable, à l'épreuve du décollement. Avec une colle exclusive et une application robotisée, les composantes résistent encore mieux au temps et à l'usure.

Superior gluing

Cupboard durability and look lie in the gluing process. Thermoform has developed a matchless gluing process, proven against delamination. With its exclusive glue and robotic application, components withstand even better the test of time and wear.



Pour définir le numéro de modèle

1. Choisir le profil intérieur

- Le profil intérieur décrit le détail intérieur de la porte.
- Il est défini par trois chiffres, qui sont les trois premiers du numéro de modèle.
- Les profils intérieurs sont regroupés par séries, présentés aux pages 6 et 7.

2. Choisir le style

- Le style est la forme du détail intérieur de la porte.
- Il est défini par un ou deux chiffres.
- Les styles sont présentés en pages 8 et 9.

3. Choisir le profil extérieur

- Le profil extérieur est le détail du contour de la porte.
- Il est identifié par une lettre.
- Les profils extérieurs sont présentés en pages 10 et 11.

To define the model number

1. Select inside profile

- Inside profile refers to the inside detailing of the door.
- It is defined by three numbers, the first three of the model number.
- The edge profiles are classified by series presented on pages 6 and 7.

2. Select style

- The style is the shape of the inside detailing of the door.
- It is defined by one or two numbers.
- Styles are presented on pages 8 and 9.

3. Select edge profile

- The edge profile is the outside detailing of the door.
- It is identified by one letter.
- Edge profiles are presented on pages 10 and 11.

Modèles spéciaux

Les modèles spéciaux sont identifiés par quatre chiffres, qui comportent à la fois le profil intérieur et le style.

Special models

Special models are identified with four digits, referring to both the inside profile and the style.



Standard – Standard

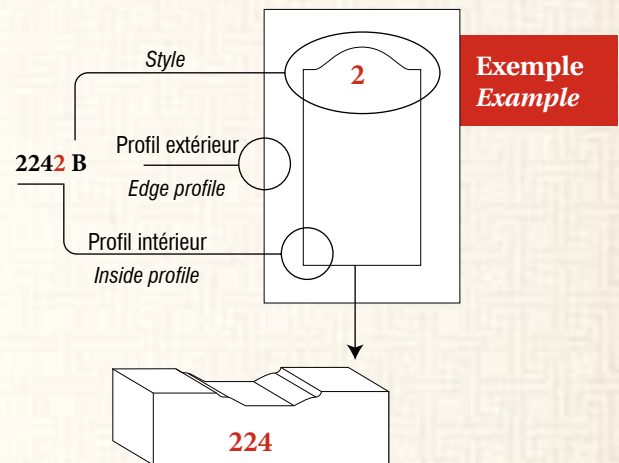

Spécial – Special

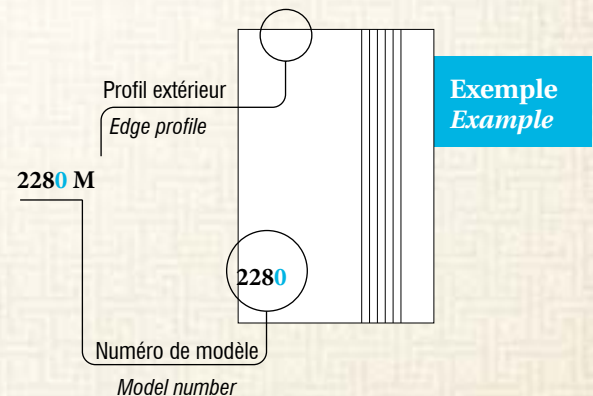

Table des matières

Table of contents

Introduction – <i>Introduction</i>	2
Pour définir le numéro de modèle – <i>To define the model number</i>	3
Table de matières – <i>Table of contents</i>	4
Options, Perforations de pentures – <i>Options, Hinge drilling</i>	5
Séries et profils intérieurs – <i>Series and inside profiles</i>	6
Styles – <i>Styles</i>	8
Modèles spéciaux – <i>Special models</i>	9
Profils extérieurs – <i>Edge profiles</i>	10
Panneaux d'appareils électroménagers – <i>Appliance panels</i>	11
Portes verrières – <i>Mullions doors</i>	12
Panneaux multiples – <i>Multiple panels</i>	15
Série 1000 <i>Series</i>	17
Série 2000 <i>Series</i>	19
Série 3000 <i>Series</i>	31
Série 4000 <i>Series</i>	57
Série 5000 <i>Series</i>	71
Série 6000 <i>Series</i>	95
Série 7000 <i>Series</i>	105
Série 8000 <i>Series</i>	115
Accessoires – <i>Accessories</i>	
● Moulures – <i>Mouldings</i>	126
● Cache-luminaires – <i>Light valances</i>	130
● Pilastres, rosettes – <i>Fluted fillers, rosettes</i>	131
● Socles et colonnes décoratives, supports – <i>Base blocks and decorative columns, brackets</i>	132
● Chapiteaux décoratifs, cantonnières – <i>Decorative corbels, valances</i>	133
● Arabesques – <i>Appliqués</i>	134
● Portes à angles – <i>Angle doors</i>	136
● Coins à rayon – <i>Radius corners</i>	138
● Moulures pour coins à rayon, tablettes de coin – <i>3 inch radius corner mouldings, corner shelves</i>	139
● Casiers à bouteilles – <i>Wine racks</i>	140
● Colonnes – <i>Columns</i>	141
● Feuilles polymères, Thermolam et Polylam – <i>Polymer sheets, Thermolam and Polylam</i>	142
● Panneaux de particules et de MDF – <i>Particle and MDF boards</i>	143
● Abattants, déflecteurs de chaleur, bandes de chant – <i>Tambours, heat deflectors, edge strips</i>	144
Recommandations – <i>Recommendations</i>	145
Couleurs • Finis – <i>Colors • Finishes</i>	146
Garantie – <i>Warranty</i>	151

Options

Ajouter LG, VG dans les battants, ou VL, DVL au cœur de la porte choisie.

Exemple / Example

Ajouter / Add: **LG VG**

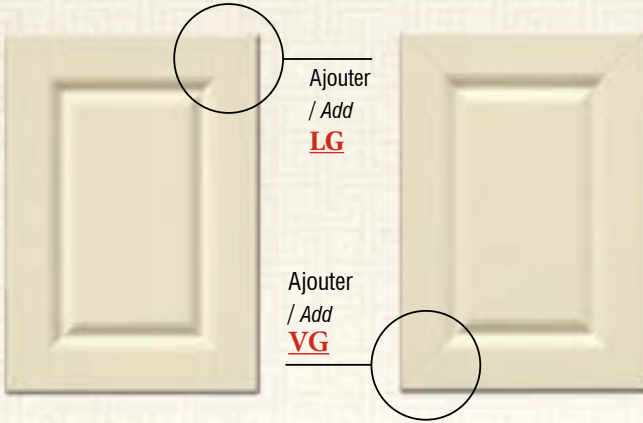

Options

Add LG, VG on stiles and rails, or VL, DVL in the centre of your door.

Ajouter / Add: **VL DVL**

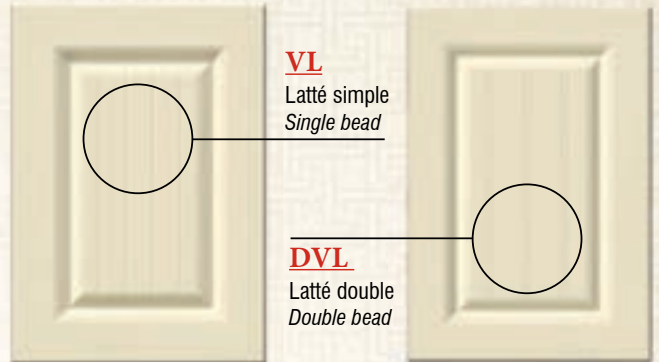

Griffe – Finger pull

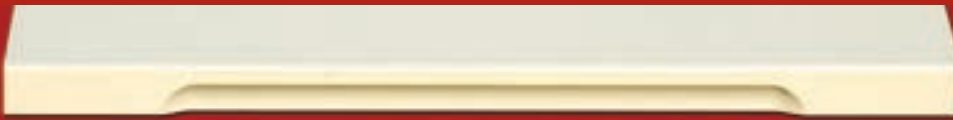

Disponible pour tous les modèles
Available on all models



Perforations de pentures / Hinge drilling

Standard européen / Face fame

Profondeur / Thickness: 1/2 "

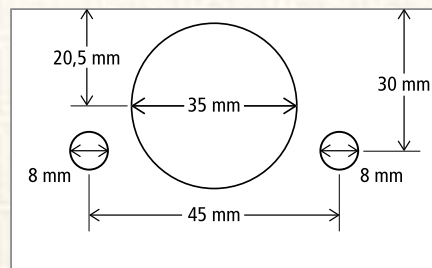
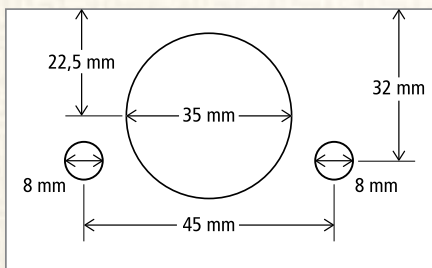
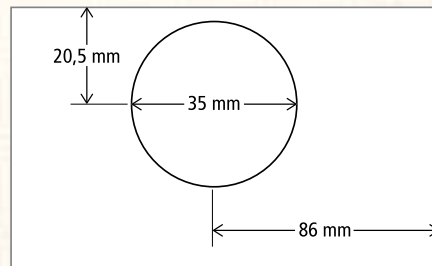
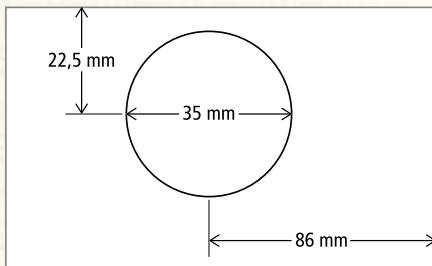

Aussi disponible / Also available

Perforations sur mesure ou avec petits trous de 5 mm.
Made to order hinge drilling or with little holes of 5 mm.



Note : Les perforations de penture doivent être faites avec une mèche de 35 mm qui est composée de deux couteaux extérieurs pour pré-couper le polymère. Disponible chez Thermoform.

Note : Hinge drilling must be done with a 35 mm hinge boring bit with two fluted sides for a pre-cutting of the polymer. Available at Thermoform.

Séries et profils intérieurs

Series and inside profiles

SÉRIE 1000 SERIES

Sans profil intérieur : *Without inside profile:*

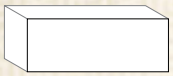

1000

SÉRIE 2000 SERIES COIN ROND ROUND CORNER

Profils intérieurs : *Inside profiles:*



220

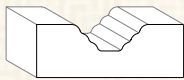

223

Spécial : 2220-2221
Special : 2220-2221

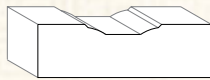

224

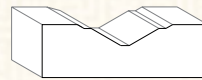

227



2280 à 2010
Spécial - Special

SÉRIE 3000 SERIES COIN CARRÉ SQUARE CORNER

Profils intérieurs : *Inside profiles:*



330



331

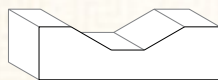

332



3070 à 3180
Spécial - Special



335



336



337



338

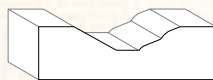

339



340

SÉRIE 4000 SERIES COIN CARRÉ SQUARE CORNER

Profils intérieurs : *Inside profiles:*

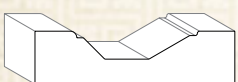

440



441



447

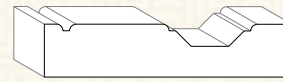

448



449

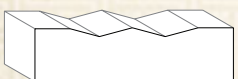

4420
Spécial - Special

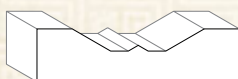

4430
Spécial - Special

SÉRIE 5000 SERIES COIN CARRÉ SQUARE CORNER

SHAKER MDF
disponible avec ou sans centre. /
Available with or without center

Profils intérieurs : Inside profiles:

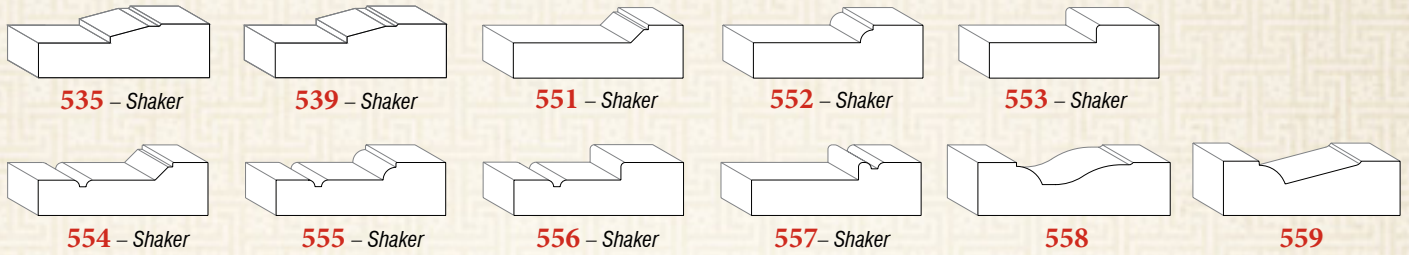

SÉRIE 6000 SERIES COIN CARRÉ SQUARE CORNER

Profils intérieurs : Inside profiles:

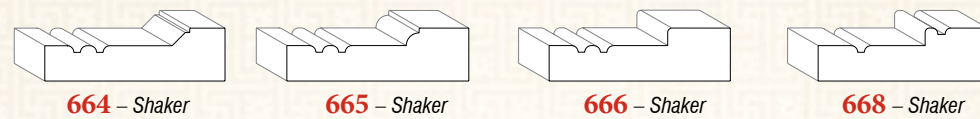

SÉRIE 7000 SERIES COIN CARRÉ SQUARE CORNER

Profils intérieurs : Inside profiles:

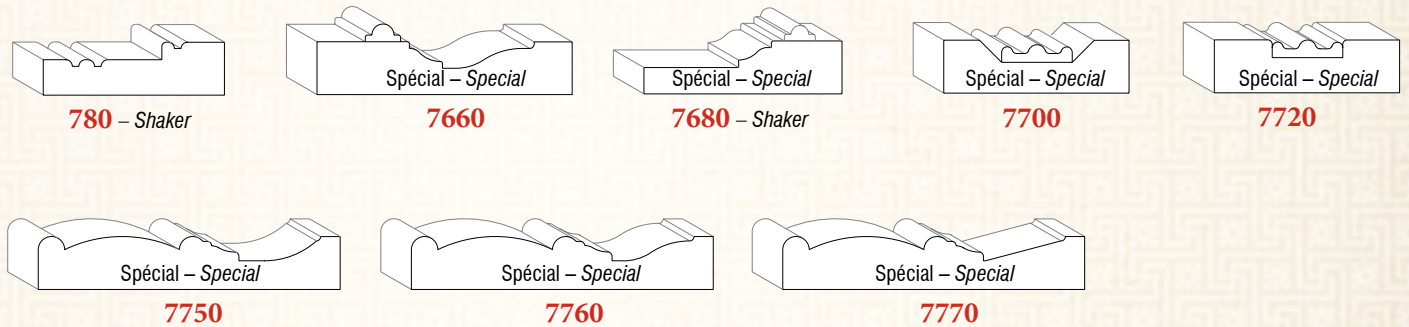

SÉRIE 8000 SERIES COIN CARRÉ SQUARE CORNER

Modèles spéciaux : Special models:

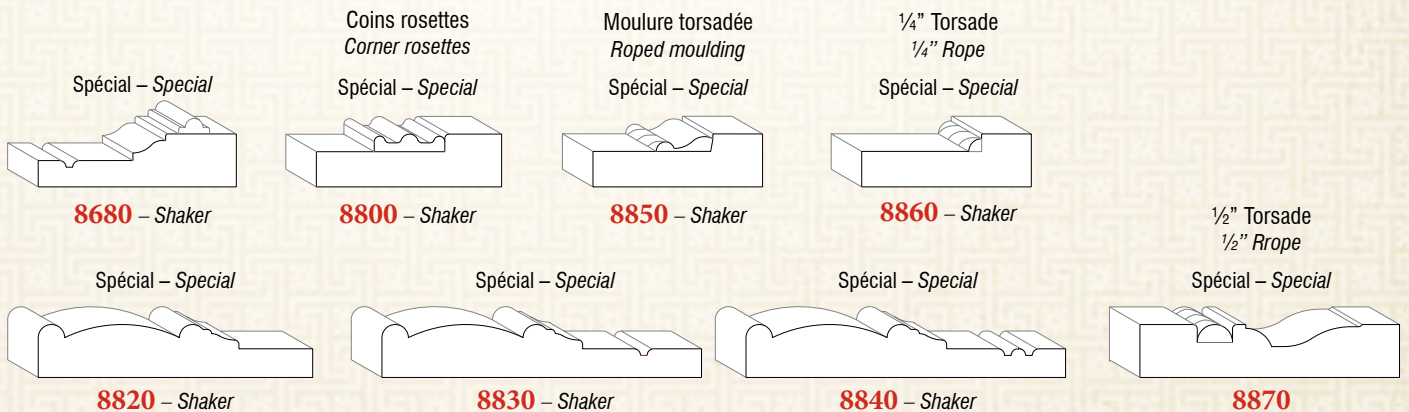

Styles

Styles

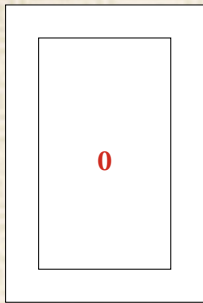

0

Carré
Square

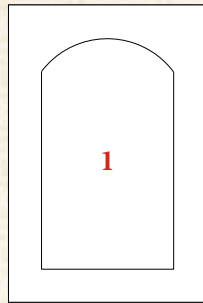

1

Romain
Roman

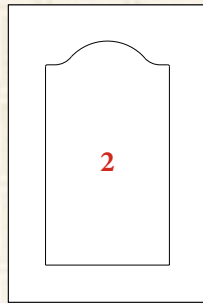

2

Cathédrale
Cathedral

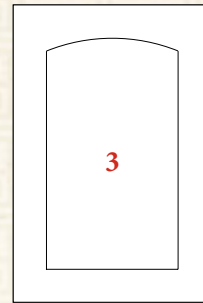

3

Arqué
Arch

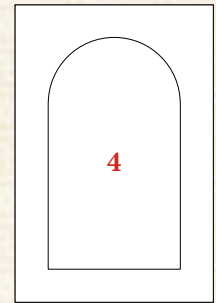

4

Demi-cercle
Half circle

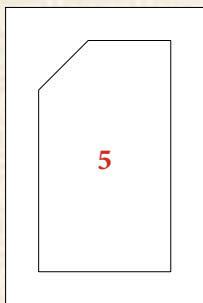

5

Pentagone gauche
Pentagon left

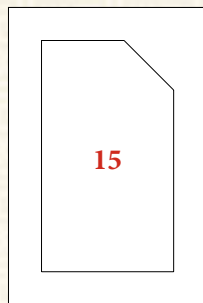

15

Pentagone droite
Pentagon right

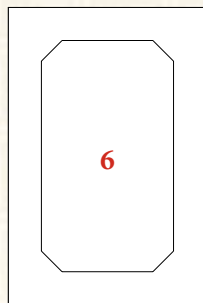

6

Octogone
Octagon

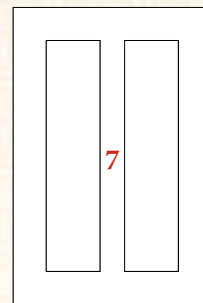

7

Double
Double

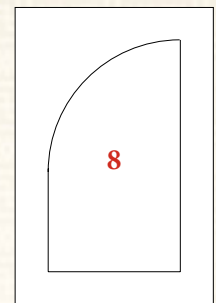

8

Quart-cercle gauche
Quarter circle left

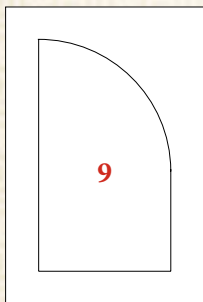

9

Quart-cercle droite
Quarter circle right

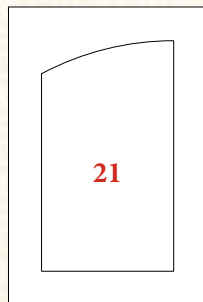

21

Demi-romain gauche
Half roman left

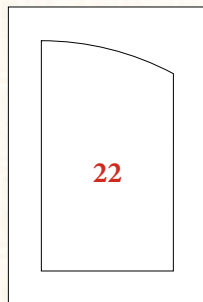

22

Demi-romain droite
Half roman right

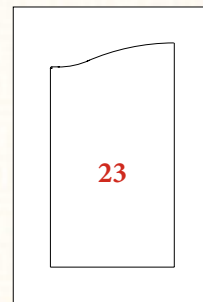

23

Demi-cathédrale gauche
Half cathedral left

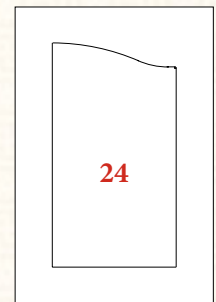

24

Demi-cathédrale droite
Half cathedral right

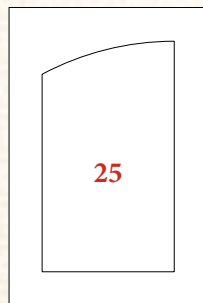

25

Demi-arqué gauche
Half arch left

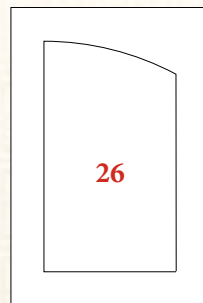

26

Demi-arqué droite
Half arch right

Pour connaître les combinaisons possibles entre styles et profils, consultez les pages détaillées des modèles.

To find out possible combinations of styles and profiles refer to detailed model pages.

Modèles spéciaux

Special models

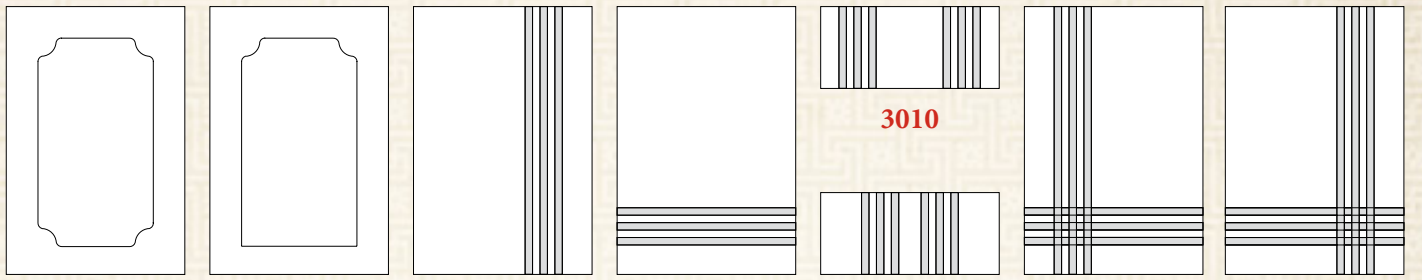

2220

2221

2280

2010

3010

3020

3030

3040

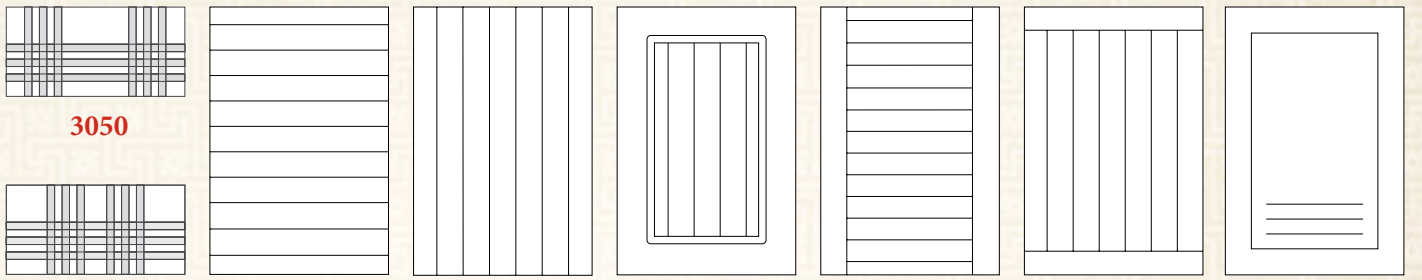

3050

3060

3070

3080

3090

3100

3110

3120

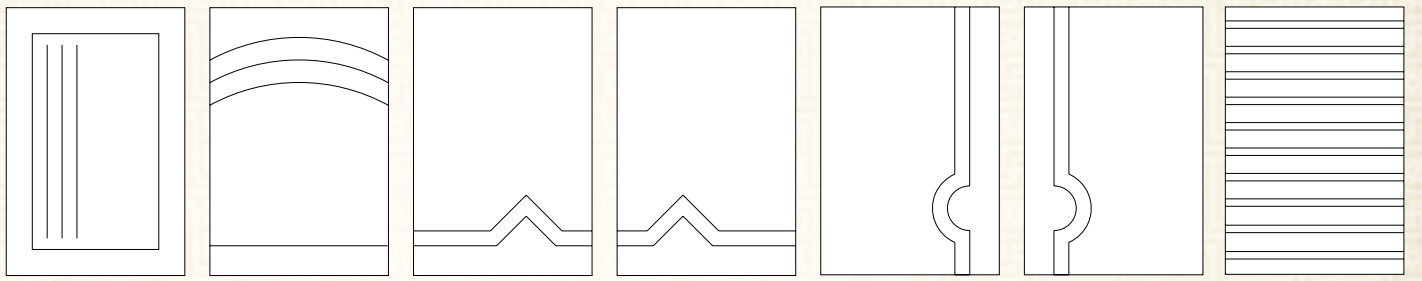

3130

3140

3150

3160

3170

3180

4010

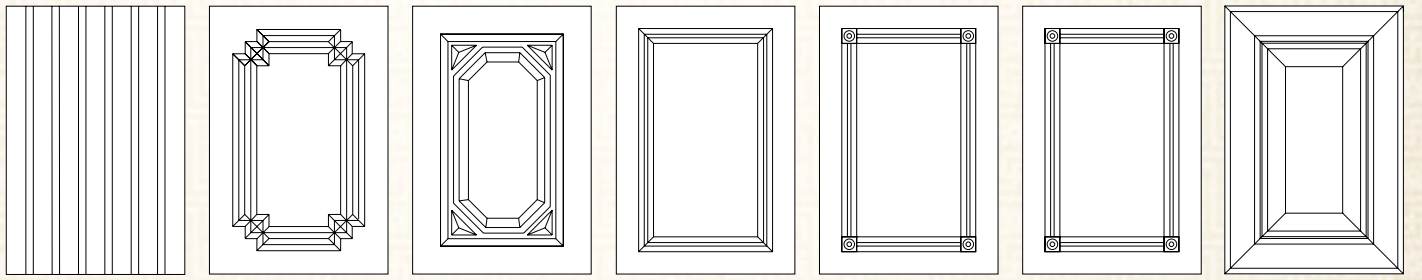

4020

4420

4430

7700

8800 – Shaker Rosettes

7720 Rosettes

7750-7760-7770

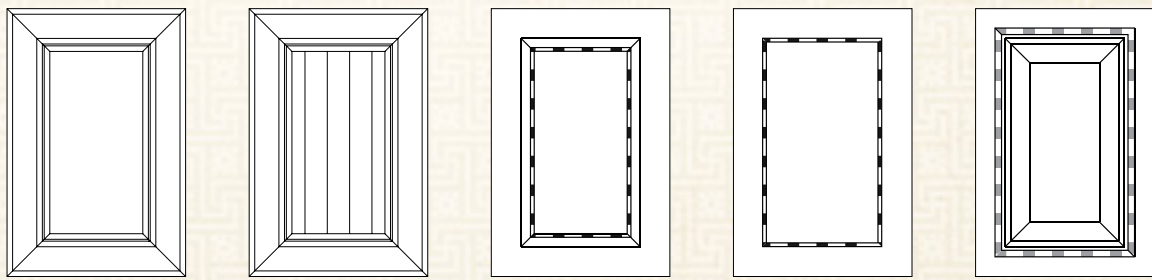

8820 – Shaker

8830-8840 – Shaker

8850 – Shaker Moulure torsadée Roped moulding

8860 – Shaker 1/4" torsade 1/4" rope

8870 1/2" torsade 1/2" rope

Profils extérieurs

Edge profiles

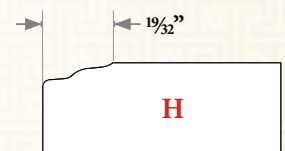
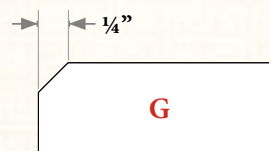
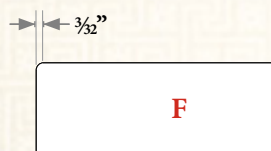
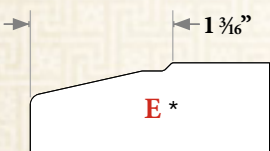
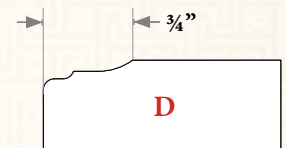
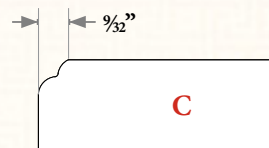
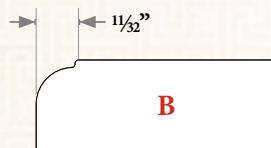
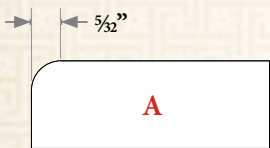

*Non disponible avec les couleurs lustrées
 *Not available in gloss colors

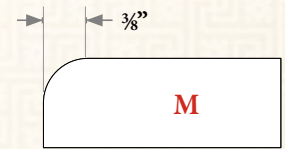
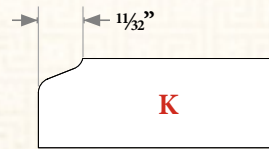
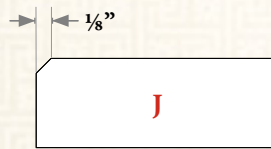
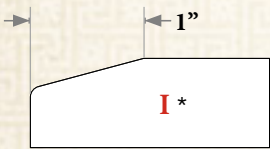

*Non disponible avec les couleurs lustrées
 *Not available in gloss colors

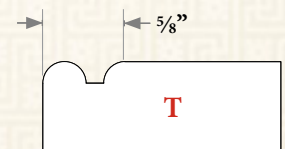
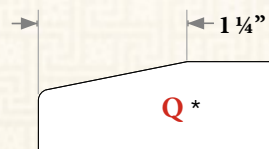
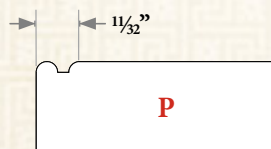
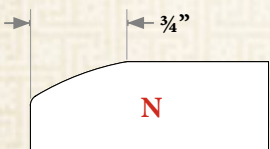

*Non disponible avec les couleurs lustrées
 *Not available in gloss colors

Panneaux d'appareils électroménagers

Appliance panels

Fournir les mesures C et D

C & D dimensions to be specified

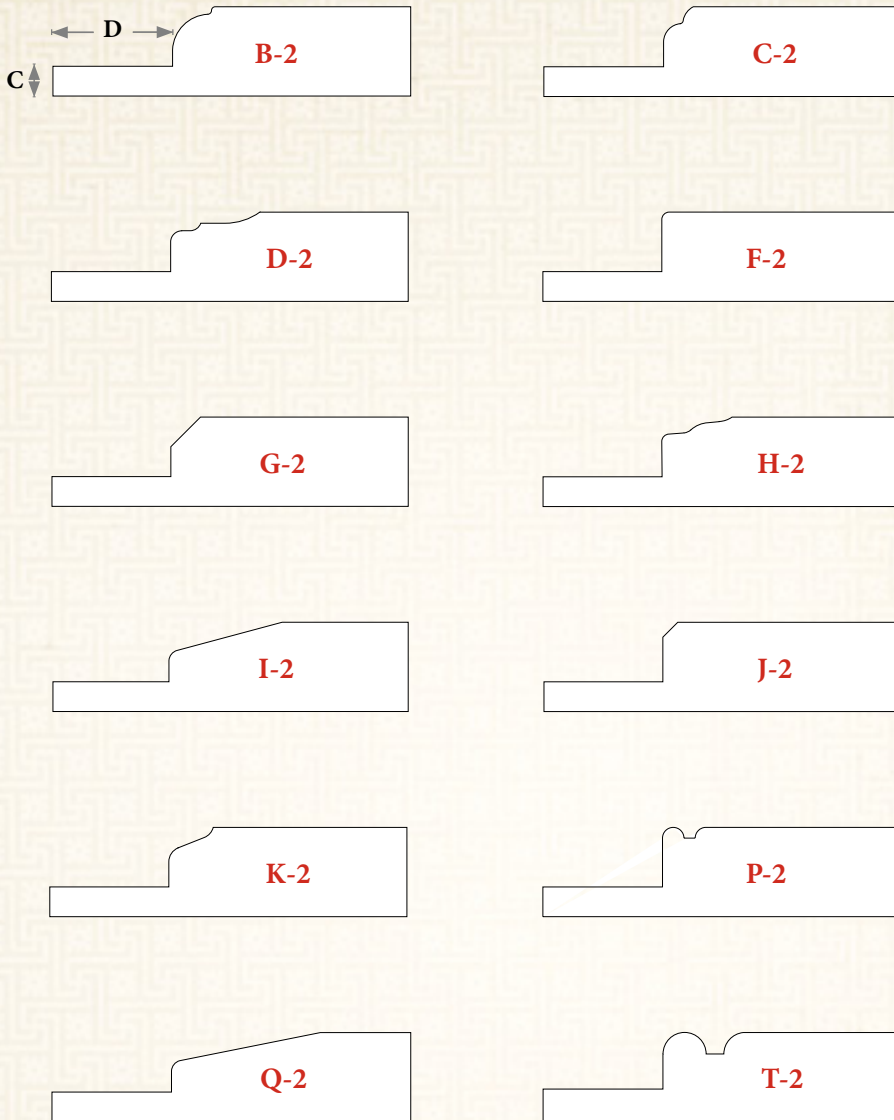

Portes verrières

Mullions doors

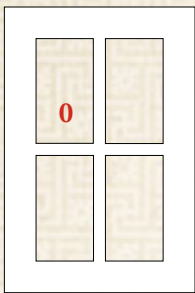

0
Carré
Square

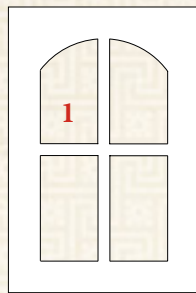

1
Romain
Roman

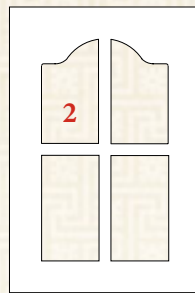

2
Cathédrale
Cathedral

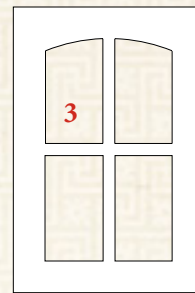

3
Arqué
Arch

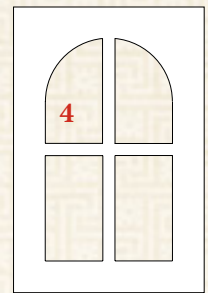

4
Demi-cercle
Half circle

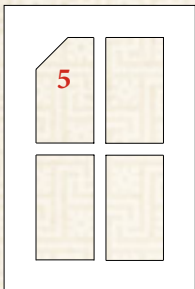

5
Pentagone gauche
Pentagon left

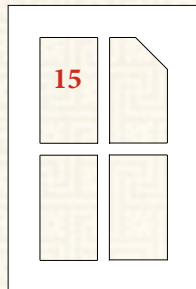

15
Pentagone droite
Pentagon right

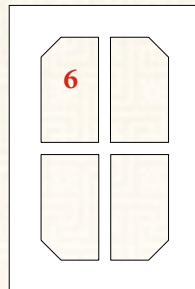

6
Octogone
Octagon

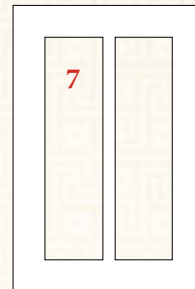

7
Double
Double

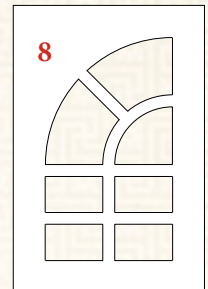

8
Quart de cercle gauche
Quarter circle left

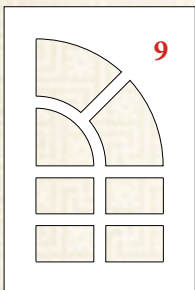

9
Quart de cercle droite
Quarter circle right

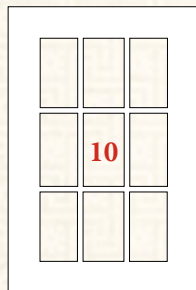

10
9 carreaux égaux
9 windows even spaced

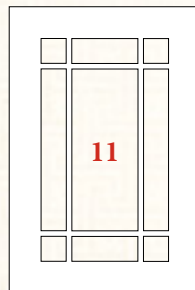

11
Antique 9 carreaux
Country 9 windows

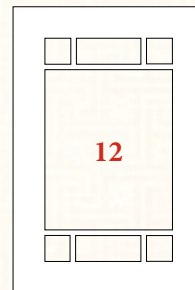

12
Antique 7 carreaux
Country 7 windows

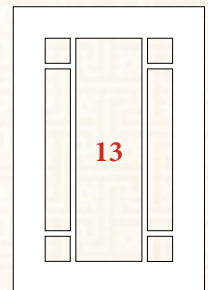

13
Antique 7 carreaux
Country 7 windows

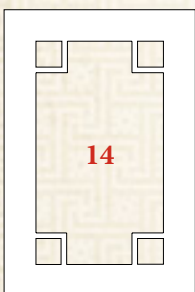

14
Antique 5 carreaux
Country 5 windows

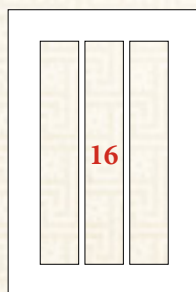

16
3 carreaux égaux
3 even windows

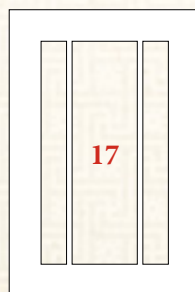

17
3 carreaux inégaux
3 uneven windows

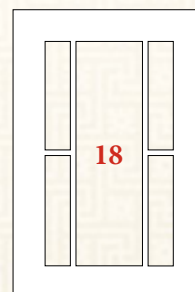

18
5 carreaux
5 windows

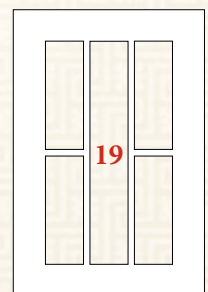

19
5 carreaux
5 windows



12 carreaux égaux
12 even windows

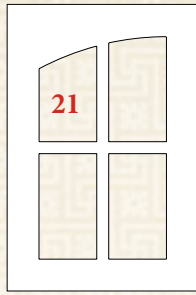

Demi-romain gauche
Half roman left

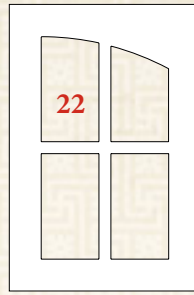

Demi-romain droite
Half roman right

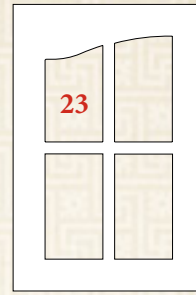

Demi-cathédrale gauche
Half cathedral left

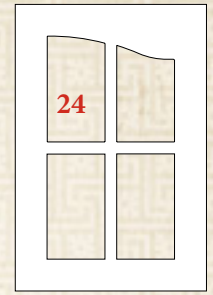

Demi-cathédrale droite
Half cathedral right

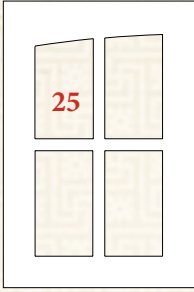

Demi-arcqué gauche
Half arch left

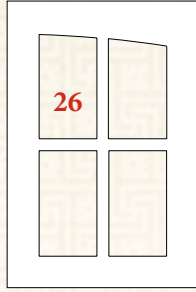

Demi-arcqué droite
Half arch right

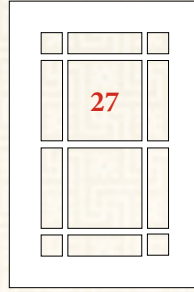

12 carreaux
12 windows



empilé de 2 à 6 carreaux
28
2 to 6 stacked windows

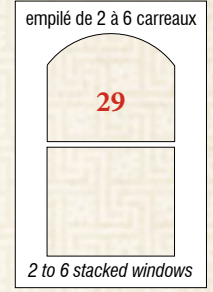

empilé de 2 à 6 carreaux
29
2 to 6 stacked windows

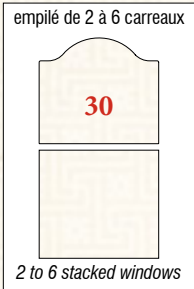

empilé de 2 à 6 carreaux
30
2 to 6 stacked windows
Empilé cathédrale
Cathedral stacked

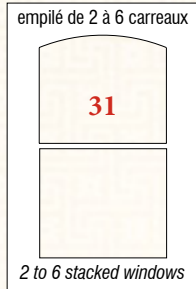

empilé de 2 à 6 carreaux
31
2 to 6 stacked windows
Empilé arcqué
Arch stacked

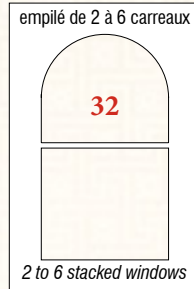

empilé de 2 à 6 carreaux
32
2 to 6 stacked windows
Empilé demi-cercle
Half circle stacked

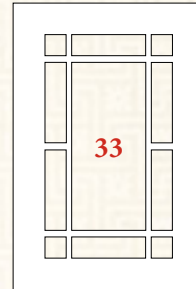

33
11 carreaux
11 windows

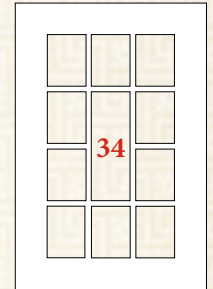

34
11 carreaux
11 windows

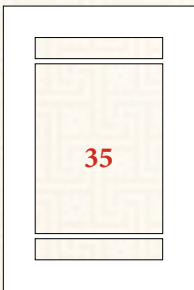

35
3 carreaux
3 windows

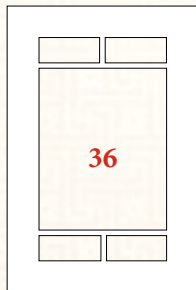

36
5 carreaux
5 windows

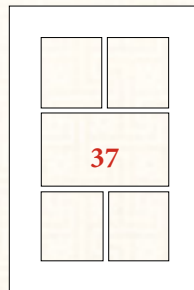

37
5 carreaux
5 windows

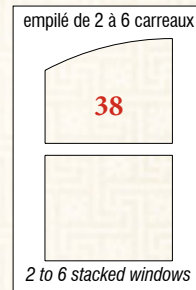

empilé de 2 à 6 carreaux
38
2 to 6 stacked windows
Demi-romain gauche
Half roman left

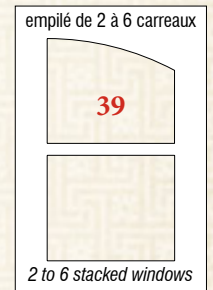

empilé de 2 à 6 carreaux
39
2 to 6 stacked windows
Demi-romain droite
Half roman right

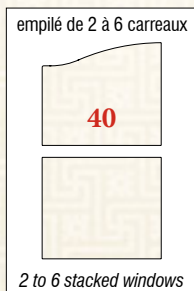

empilé de 2 à 6 carreaux
40
2 to 6 stacked windows
Demi-cathédrale gauche
Half cathedral left

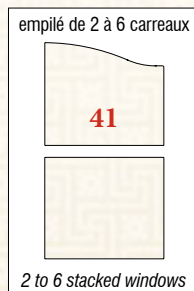

empilé de 2 à 6 carreaux
41
2 to 6 stacked windows
Demi-cathédrale droite
Half cathedral right

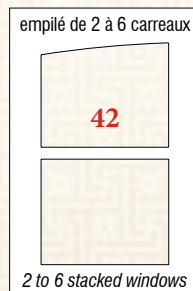

empilé de 2 à 6 carreaux
42
2 to 6 stacked windows
Demi-arcqué gauche
Half arch left

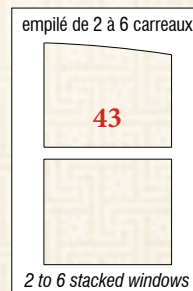

empilé de 2 à 6 carreaux
43
2 to 6 stacked windows
Demi-arcqué droite
Half arch right

Portes verrières – Modèles spéciaux

Millions doors – Special models

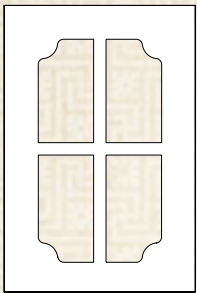

2220

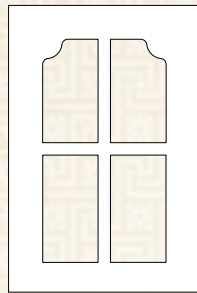

2221

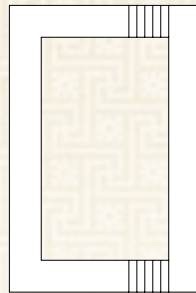

2280

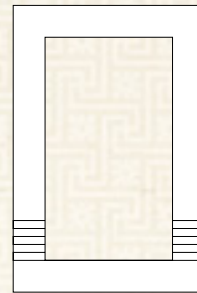

2010

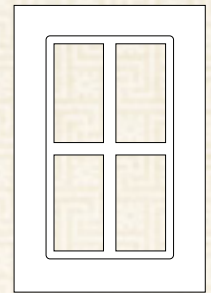

3090

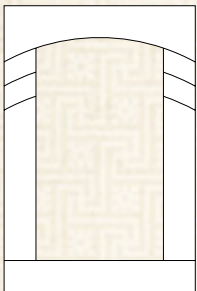

3140

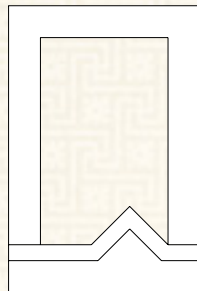

3150

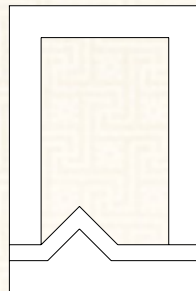

3160

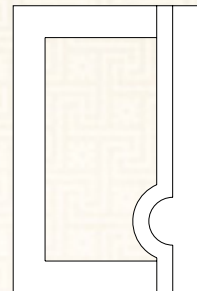

3170

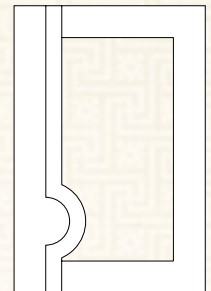

3180

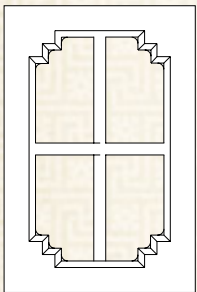

4420

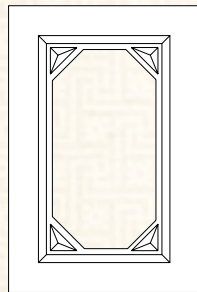

4430

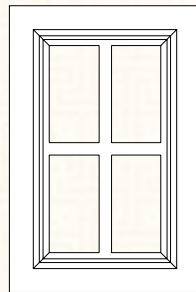

7700

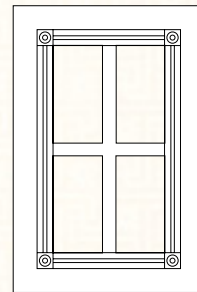

7720-8800
Rosettes
Rosettes

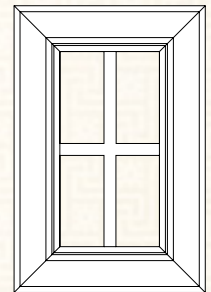

7750-7760-7770
8820-8840

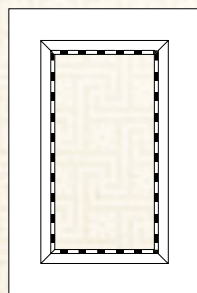

8850
Moulure torsadée
Roped moulding

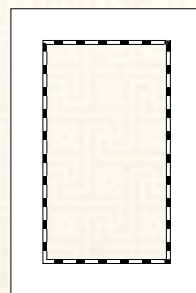

8860
1/4" torsade
1/4" rope

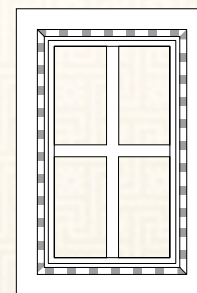

8870
1/2" torsade
1/2" rope

Panneaux multiples

Multiple panels

Un panneau à motifs multiples permet de combiner jusqu'à 6 portes et verrières dans un seul panneau. Un panneau peut être horizontal ou vertical. De la même façon, on peut créer un panneau pour des électroménagers et fours encastrés. Laissez libre cours à votre imagination !

A multiple panel allows combination of up to 6 doors and glass doors in a single panel. A panel can be horizontal or vertical. In the same way, we can create a panel for appliances and oven frames. Let your imagination run!

Exemple d'un arrangement horizontal combinant les styles 8 et 9.
Example of horizontal setting combining styles 8 and 9.

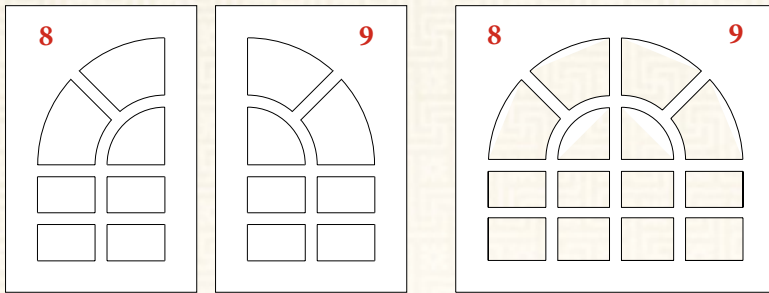

Exemple d'un arrangement vertical de trois verrières de styles 2, 7 et 0 et de deux portes de style 0.

Example of vertical setting of 3 mullion doors, styles 2, 7 and 0, and of two doors, style 0.

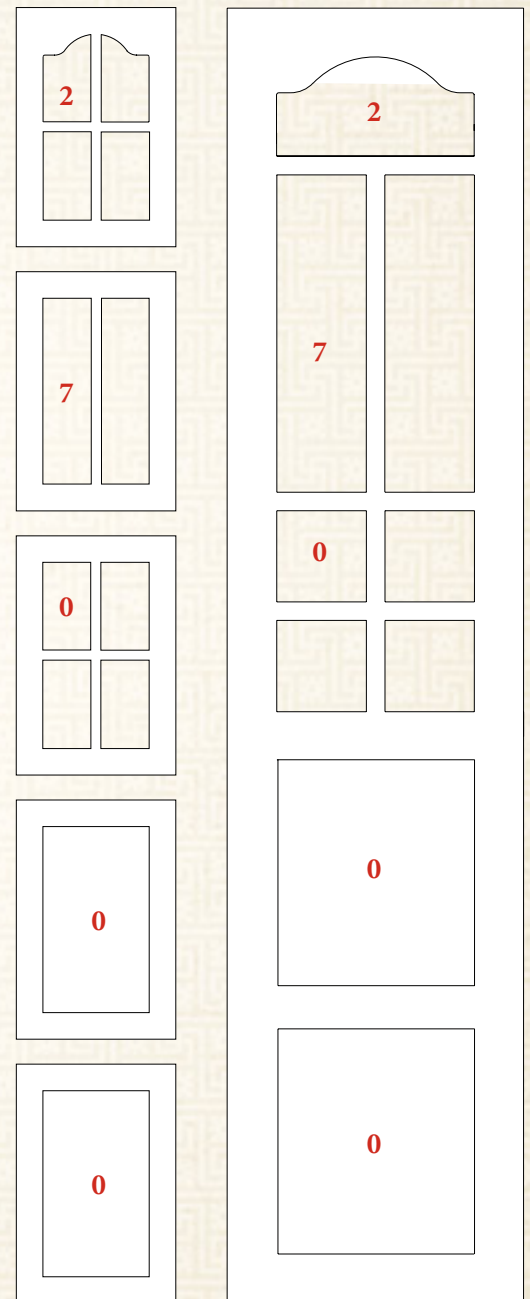

Exemple d'un arrangement horizontal de 4 portes de styles 8, 0 et 9.
Example of horizontal setting of 4 doors, combining styles 8, 0 and 9.

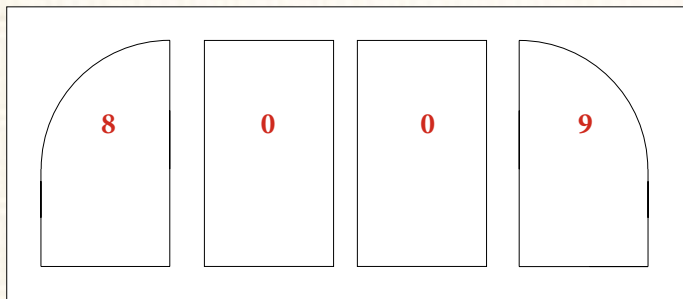

Exemple : Cadre four
Example: Oven frame

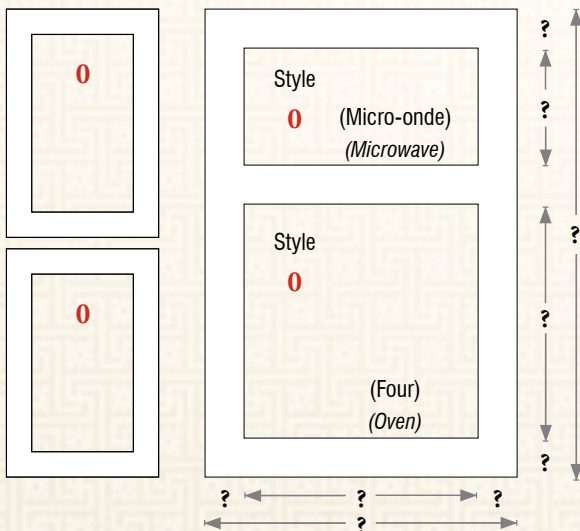

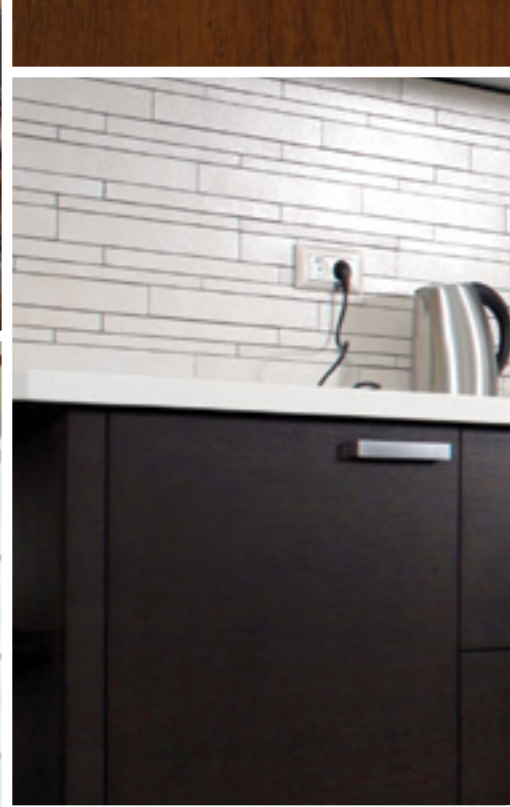

Beauté, durabilité, qualité !
Beauty, durability, quality!

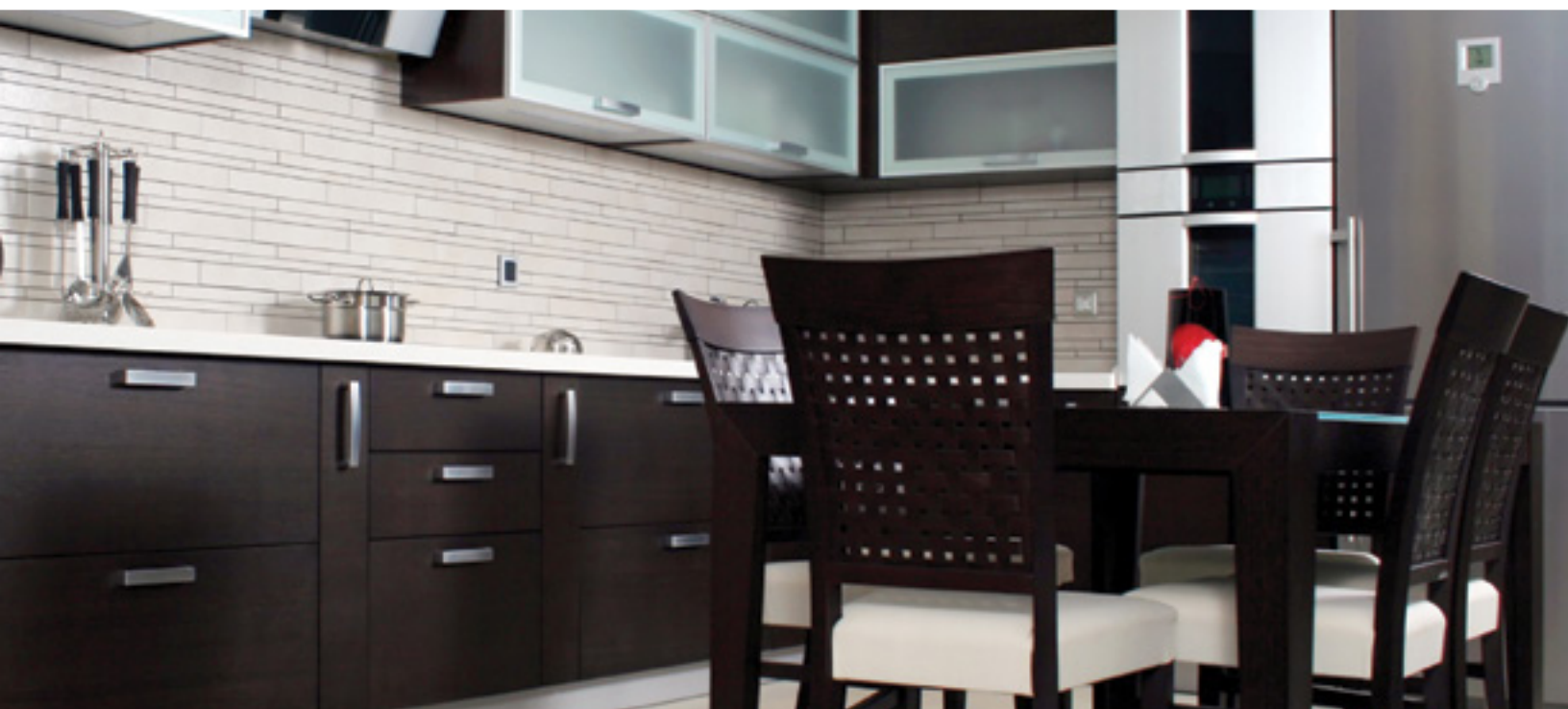

série
1000
series

THERMOFORM

Spécial
Special

1000



1000
Porte
Door



1000
Porte
Door



1000
Porte
Door



1000
Porte
Door

 Profil intérieur - *Inside profile*



 Profils extérieurs - *Edge profiles*

A	B	C	D	E	F	G	H	I	J	K	M	N	P	Q	T
---	---	---	---	---	---	---	---	---	---	---	---	---	---	---	---

 Panneaux d'appareils électroménagers - *Appliance panels*

B-2	C-2	D-2	F-2	G-2	H-2	I-2	J-2	K-2	P-2	Q-2	T-2
-----	-----	-----	-----	-----	-----	-----	-----	-----	-----	-----	-----

 Options - *Options*

LG	VG	VL	DVL	GRIFFE FINGER PULL
		3080	4020	

 Disponible pour ce modèle - *Available for this model*



série
2000
series

THERMOFORM

Modèle
Model

220

Styles Styles

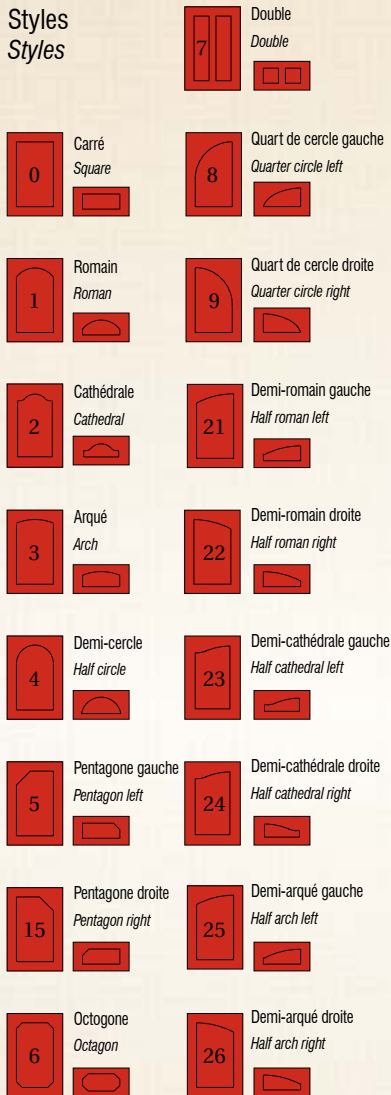

Profils extérieurs - Edge profiles

A B C D E F G H I J K M N P Q T

Panneaux d'appareils électroménagers - Appliance panels

B-2 C-2 D-2 F-2 G-2 H-2 I-2 J-2 K-2 P-2 Q-2 T-2

Options - Options

LG VG VL DVL GRIFFE
FINGER PULL

Disponible pour ce modèle - Available for this model

2200
Porte
Door



Profil intérieur - Inside profile



Quelques possibilités - Some possibilities



2202-2200
Panneaux multiples
Multiple panels



2201
Porte
Door



2200
Verrières
Mullions



2201
Verrières
Mullions



2202
Porte
Door



2200
Façade-tiroir
Drawer-facade



2201
Façade-tiroir
Drawer-facade



2202
Façade-tiroir
Drawer-facade

POUR CONNAÎTRE TOUTES LES POSSIBILITÉS, CONSULTEZ LES PAGES : - TO KNOW ABOUT ALL POSSIBILITIES, REFER TO PAGES:

Verrières - Glass doors 12-13-14 Panneaux multiples - Multiple panels 15 Couleurs • Finis - Colors • Finishes 146-147-148-149

Modèle
Model

223

Styles Styles

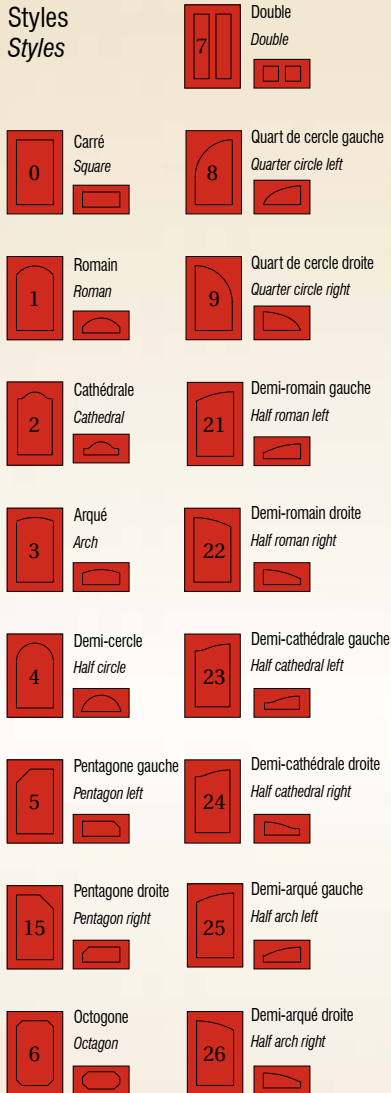

Profils extérieurs - Edge profiles

A B C D E F G H I J K M N P Q T

Panneaux d'appareils électroménagers - Appliance panels

B-2 C-2 D-2 F-2 G-2 H-2 I-2 J-2 K-2 P-2 Q-2 T-2

Options - Options

LG VG VL DVL GRIFFE
FINGER PULL

Disponible pour ce modèle - Available for this model



2230
Porte
Door

Profil intérieur - Inside profile

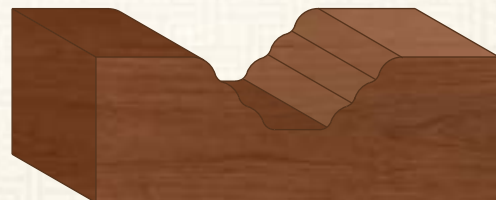

Quelques possibilités - Some possibilities



2232-2230
Panneaux multiples
Multiple panels



2231
Porte
Door



2230
Façade-tiroir
Drawer-facade



2231
Façade-tiroir
Drawer-facade



2232
Façade-tiroir
Drawer-facade



2232
Porte
Door



2230
Verrières
Mullions



2231
Verrières
Mullions

POUR CONNAÎTRE TOUTES LES POSSIBILITÉS, CONSULTEZ LES PAGES : - TO KNOW ABOUT ALL POSSIBILITIES, REFER TO PAGES:

146-147-148-149

Couleurs • Finis • Finishes

15

Panneaux multiples - Multiple panels

12-13-14

Verrières - Glass doors

Modèle
Model

224

Styles Styles

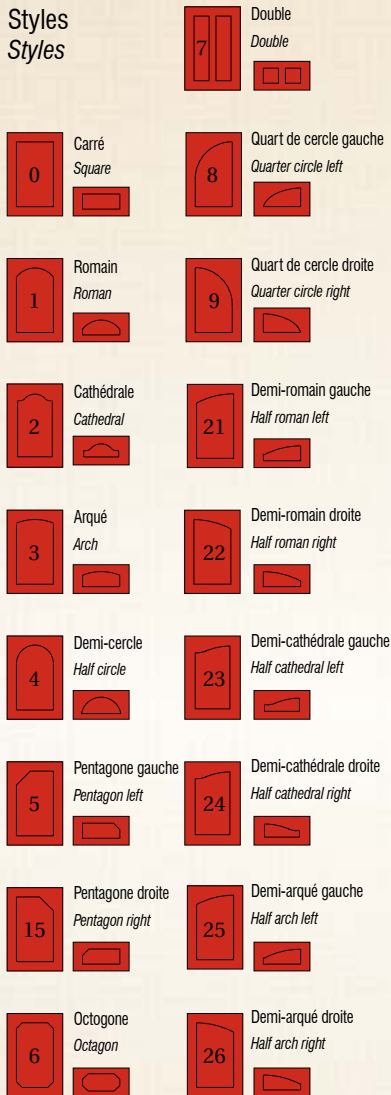

Profils extérieurs - Edge profiles

A B C D E F G H I J K M N P Q T

Panneaux d'appareils électroménagers - Appliance panels

B-2 C-2 D-2 F-2 G-2 H-2 I-2 J-2 K-2 P-2 Q-2 T-2

Options - Options

LG VG VL DVL **GRIFFE**
FINGER PULL

Disponible pour ce modèle - Available for this model

2240
Porte
Door



Profil intérieur - Inside profile

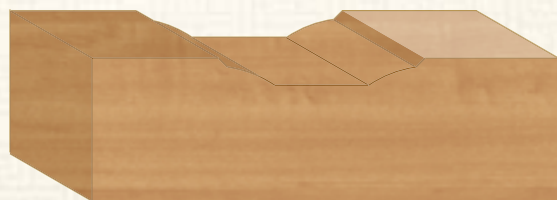

Quelques possibilités - Some possibilities



2242-2240
Panneaux multiples
Multiple panels



2241
Porte
Door



2240
Verrières
Mullions



2241
Verrières
Mullions



2242
Porte
Door



2240
Façade-tiroir
Drawer-facade



2241
Façade-tiroir
Drawer-facade



2242
Façade-tiroir
Drawer-facade

POUR CONNAÎTRE TOUTES LES POSSIBILITÉS, CONSULTEZ LES PAGES : - TO KNOW ABOUT ALL POSSIBILITIES, REFER TO PAGES:

146-147-148-149

Couleurs • Finis • Finishes

15

Panneaux multiples - Multiple panels

12-13-14

Verrières - Glass doors

Modèle
Model

227

Styles
Styles

- 7

Double
Double
- 0

Carré
Square
- 1

Romain
Roman
- 2

Cathédrale
Cathedral
- 3

Arqué
Arch
- 4

Demi-cercle
Half circle
- 5

Pentagone gauche
Pentagon left
- 15

Pentagone droite
Pentagon right
- 6

Octogone
Octagon
- 8

Quart de cercle gauche
Quarter circle left
- 9

Quart de cercle droite
Quarter circle right
- 21

Demi-romain gauche
Half roman left
- 22

Demi-romain droite
Half roman right
- 23

Demi-cathédrale gauche
Half cathedral left
- 24

Demi-cathédrale droite
Half cathedral right
- 25

Demi-arqué gauche
Half arch left
- 26

Demi-arqué droite
Half arch right

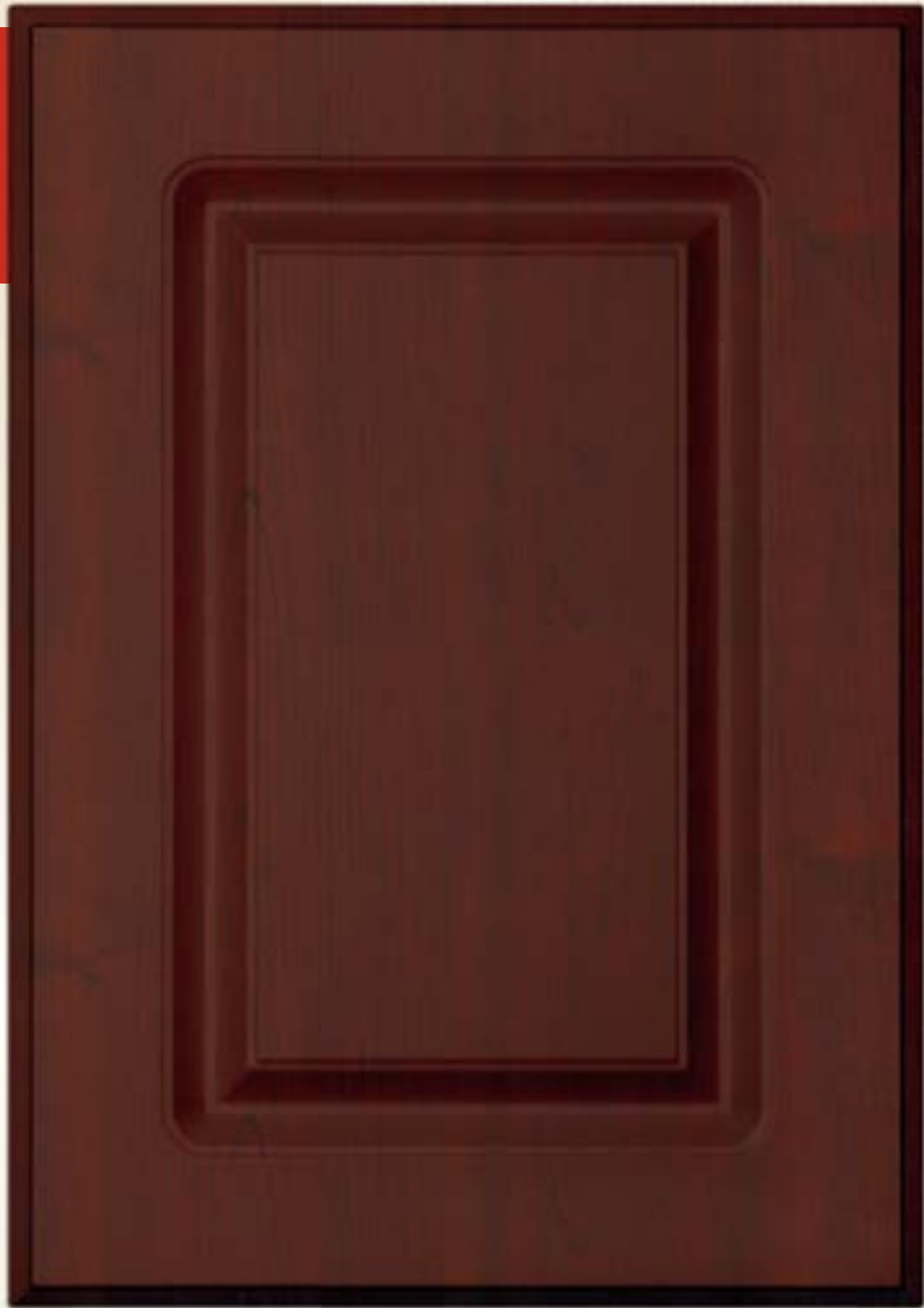

2270
Porte
Door

Profils extérieurs - Edge profiles

- | | | | | | | | | | | | | | | | |
|---|---|---|---|---|---|---|---|---|---|---|---|---|---|---|---|
| A | B | C | D | E | F | G | H | I | J | K | M | N | P | Q | T |
|---|---|---|---|---|---|---|---|---|---|---|---|---|---|---|---|

Panneaux d'appareils électroménagers - Appliance panels

- | | | | | | | | | | | | |
|-----|-----|-----|-----|-----|-----|-----|-----|-----|-----|-----|-----|
| B-2 | C-2 | D-2 | F-2 | G-2 | H-2 | I-2 | J-2 | K-2 | P-2 | Q-2 | T-2 |
|-----|-----|-----|-----|-----|-----|-----|-----|-----|-----|-----|-----|

Options - Options

- | | | | | |
|----|----|----|-----|-----------------------|
| LG | VG | VL | DVL | GRIFFE
FINGER PULL |
|----|----|----|-----|-----------------------|

Profil intérieur - Inside profile

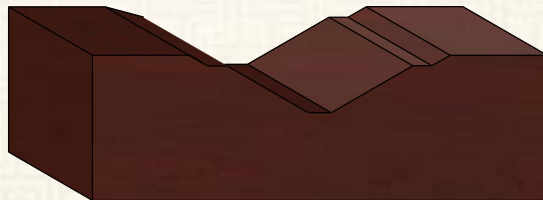

Disponible pour ce modèle - Available for this model

Quelques possibilités - Some possibilities



2273-2270

Panneaux multiples
Multiple panels



2273

Porte
Door



2271

Façade-tiroir
Drawer-facade



2272

Façade-tiroir
Drawer-facade



2273

Façade-tiroir
Drawer-facade



2272

Porte
Door



2270

Verrières
Mullions



2271

Verrières
Mullions

POUR CONNAÎTRE TOUTES LES POSSIBILITÉS, CONSULTEZ LES PAGES : - TO KNOW ABOUT ALL POSSIBILITIES, REFER TO PAGES:

Verrières - Glass doors

12-13-14

Panneaux multiples - Multiple panels

15

Couleurs • Finis • Finishes

146-147-148-149

Spécial
Special

2010



2010

Façade-tiroir
Drawer-facade



3030

Porte
Door



3010

Façade-tiroir
Drawer-facade

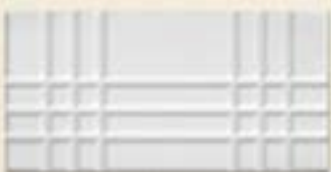

3050

Façade-tiroir
Drawer-facade

2010

Porte
Door



■ Profil intérieur - *Inside profile*

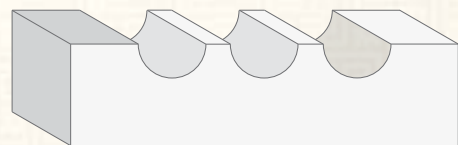

■ Profils extérieurs - *Edge profiles*

A B C D E F G H I J K M N P Q T

■ Panneaux d'appareils électroménagers - *Appliance panels*

B-2 C-2 D-2 F-2 G-2 H-2 I-2 J-2 K-2 P-2 Q-2 T-2

■ Options - *Options*

LG VG VL DVL **GRIFFE
FINGER PULL**

■ Disponible pour ce modèle - *Available for this model*

Spécial
Special

2280

2280

Porte
Door



2280

Façade-tiroir
Drawer-facade



3040

Porte
Door



3020

Façade-tiroir
Drawer-facade

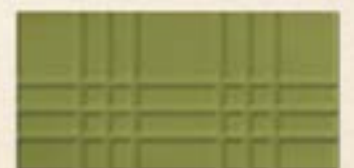

3060

Façade-tiroir
Drawer-facade

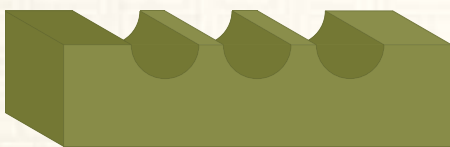

Profil intérieur - *Inside profile*

Profils extérieurs - *Edge profiles*

A B C D E F G H I J K M N P Q T

Panneaux d'appareils électroménagers - *Appliance panels*

B-2 C-2 D-2 F-2 G-2 H-2 I-2 J-2 K-2 P-2 Q-2 T-2

Options - *Options*

LG VG VL DVL **GRIFFE**
FINGER PULL

Disponible pour ce modèle - *Available for this model*



Beauté, durabilité, qualité !
Beauty, durability, quality!

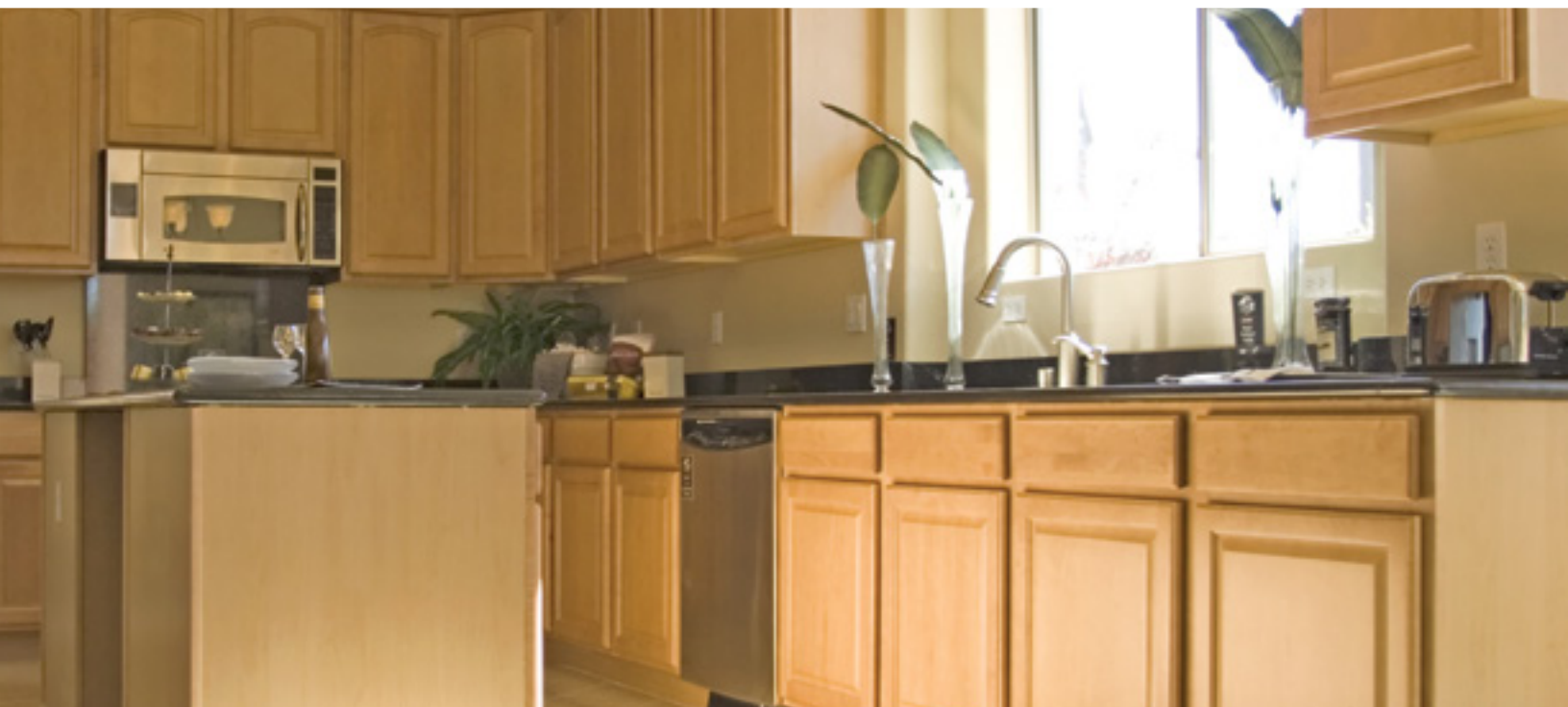

série
3000
series

THERMOFORM

Modèle
Model

330

Styles Styles

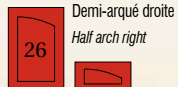
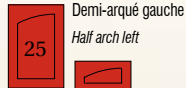
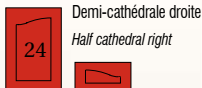
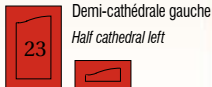
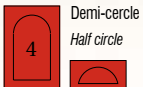
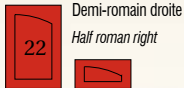
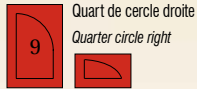
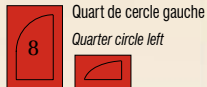
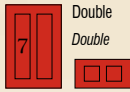

3300
Porte
Door

Profils extérieurs - Edge profiles

A B C D E F G H I J K M N P Q T

Panneaux d'appareils électroménagers - Appliance panels

B-2 C-2 D-2 F-2 G-2 H-2 I-2 J-2 K-2 P-2 Q-2 T-2

Options - Options

LG VG VL DVL GRIFFE
FINGER PULL

Disponible pour ce modèle - Available for this model

Profil intérieur - Inside profile

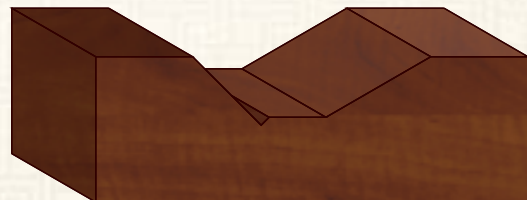

Quelques possibilités - Some possibilities



3301
Porte
Door



3300
Verrières
Mullions



3301
Verrières
Mullions



3302
Porte
Door



3300
Façade-tiroir
Drawer-facade



3301
Façade-tiroir
Drawer-facade



3308
Panneaux multiples
Multiple panels

3300

3300

3309

POUR CONNAÎTRE TOUTES LES POSSIBILITÉS, CONSULTEZ LES PAGES : - TO KNOW ABOUT ALL POSSIBILITIES, REFER TO PAGES:

146-147-148-149

Couleurs • Finis • Finishes

15

Panneaux multiples - Multiple panels

12-13-14

Verrières - Glass doors

Modèle
Model

331

Styles Styles

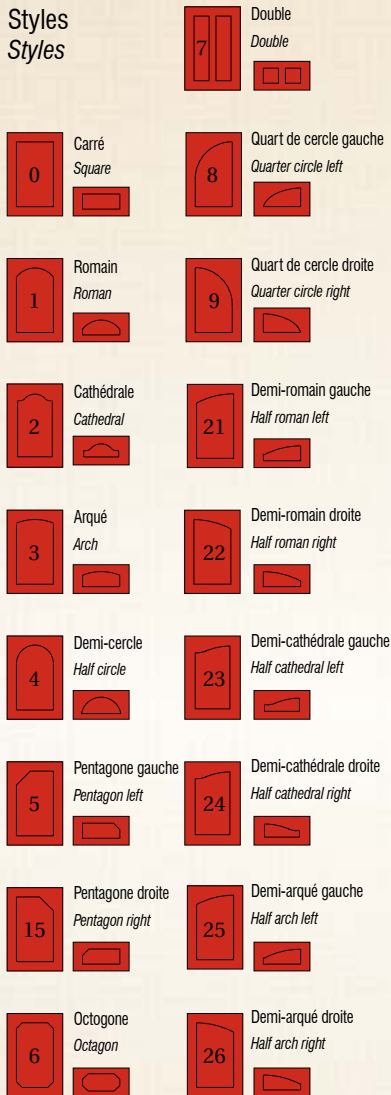

Profils extérieurs - Edge profiles

A B C D E F G H I J K M N P Q T

Panneaux d'appareils électroménagers - Appliance panels

B-2 C-2 D-2 F-2 G-2 H-2 I-2 J-2 K-2 P-2 Q-2 T-2

Options - Options

LG VG VL DVL **GRIFFE**
FINGER PULL

Disponible pour ce modèle - Available for this model



3310
Porte
Door

Profil intérieur - Inside profile

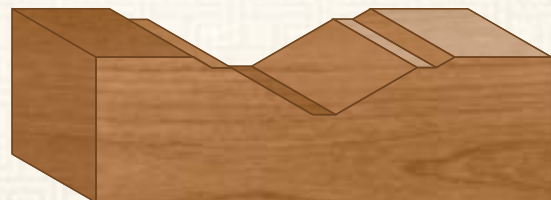

Quelques possibilités - Some possibilities



3312-3310
Panneaux multiples
Multiple panels



3310
Façade-tiroir
Drawer-facade



3311
Porte
Door



3311
Verrières
Mullions



3311
Façade-tiroir
Drawer-facade



3310
Verrières
Mullions



3312
Porte
Door



3312
Façade-tiroir
Drawer-facade

POUR CONNAÎTRE TOUTES LES POSSIBILITÉS, CONSULTEZ LES PAGES : - TO KNOW ABOUT ALL POSSIBILITIES, REFER TO PAGES:

Verrières - Glass doors 12-13-14 Panneaux multiples - Multiple panels 15 Couleurs • Finis • Finishes 146-147-148-149

Modèle
Model

332

Styles Styles

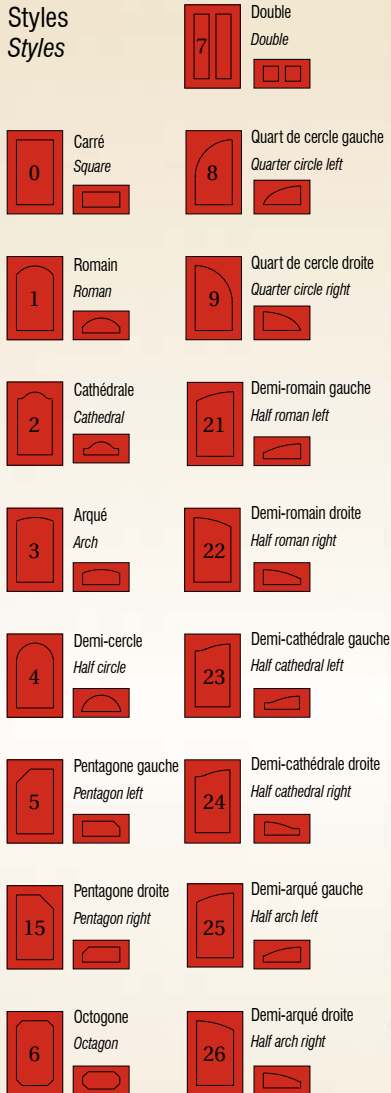

3320
Porte
Door

Profils extérieurs - Edge profiles

A B C D E F G H I J K M N P Q T

Panneaux d'appareils électroménagers - Appliance panels

B-2 C-2 D-2 F-2 G-2 H-2 I-2 J-2 K-2 P-2 Q-2 T-2

Options - Options

LG VG VL DVL GRIFFE
FINGER PULL

Profil intérieur - Inside profile



Disponible pour ce modèle - Available for this model

■ Quelques possibilités - *Some possibilities*



3322-3320

Panneaux multiples
Multiple panels



3321

Porte
Door



3320

Façade-tiroir
Drawer-facade



3321

Façade-tiroir
Drawer-facade



3322

Façade-tiroir
Drawer-facade



3322

Porte
Door



3320

Verrières
Mullions



3321

Verrières
Mullions

POUR CONNAÎTRE TOUTES LES POSSIBILITÉS, CONSULTEZ LES PAGES : - TO KNOW ABOUT ALL POSSIBILITIES, REFER TO PAGES:

Verrières - *Glass doors*

12-13-14

Panneaux multiples - *Multiple panels*

15

Couleurs • Finis • *Colors • Finishes*

146-147-148-149

Modèle
Model

335

Styles Styles

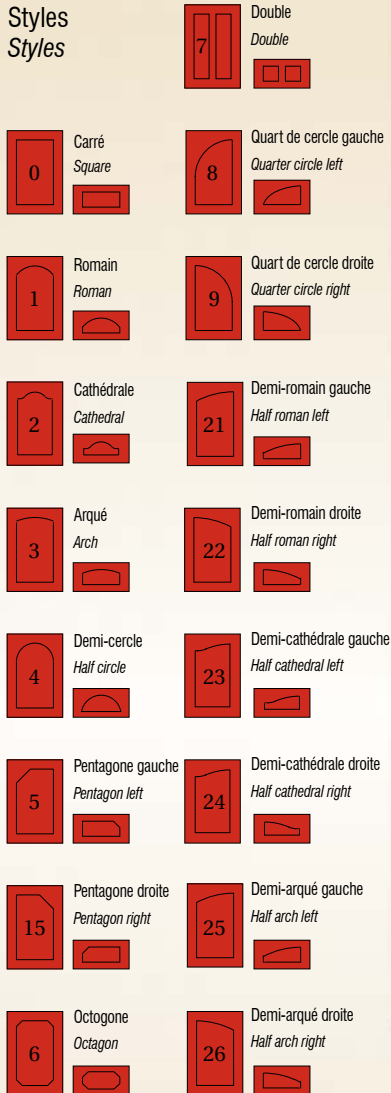

Profils extérieurs - Edge profiles

A B C D E F G H I J K M N P Q T

Panneaux d'appareils électroménagers - Appliance panels

B-2 C-2 D-2 F-2 G-2 H-2 I-2 J-2 K-2 P-2 Q-2 T-2

Options - Options

LG VG VL DVL GRIFFE
FINGER PULL

Disponible pour ce modèle - Available for this model



3350
Porte
Door

Profil intérieur - Inside profile



Quelques possibilités - Some possibilities



3351
Porte
Door



3350
Verrières
Mullions



3351
Verrières
Mullions



3352
Porte
Door



3350
Façade-tiroir
Drawer-facade



3351
Façade-tiroir
Drawer-facade



3350
Panneaux multiples
Multiple panels

POUR CONNAÎTRE TOUTES LES POSSIBILITÉS, CONSULTEZ LES PAGES : - TO KNOW ABOUT ALL POSSIBILITIES, REFER TO PAGES:

146-147-148-149

Couleurs • Finis • Finishes

15

Panneaux multiples - Multiple panels

12-13-14

Verrières - Glass doors

Modèle
Model

336

Styles
Styles

- 7

Double
Double
- 0

Carré
Square
- 1

Romain
Roman
- 2

Cathédrale
Cathedral
- 3

Arqué
Arch
- 4

Demi-cercle
Half circle
- 5

Pentagone gauche
Pentagon left
- 15

Pentagone droite
Pentagon right
- 6

Octogone
Octagon
- 8

Quart de cercle gauche
Quarter circle left
- 9

Quart de cercle droite
Quarter circle right
- 21

Demi-romain gauche
Half roman left
- 22

Demi-romain droite
Half roman right
- 23

Demi-cathédrale gauche
Half cathedral left
- 24

Demi-cathédrale droite
Half cathedral right
- 25

Demi-arqué gauche
Half arch left
- 26

Demi-arqué droite
Half arch right

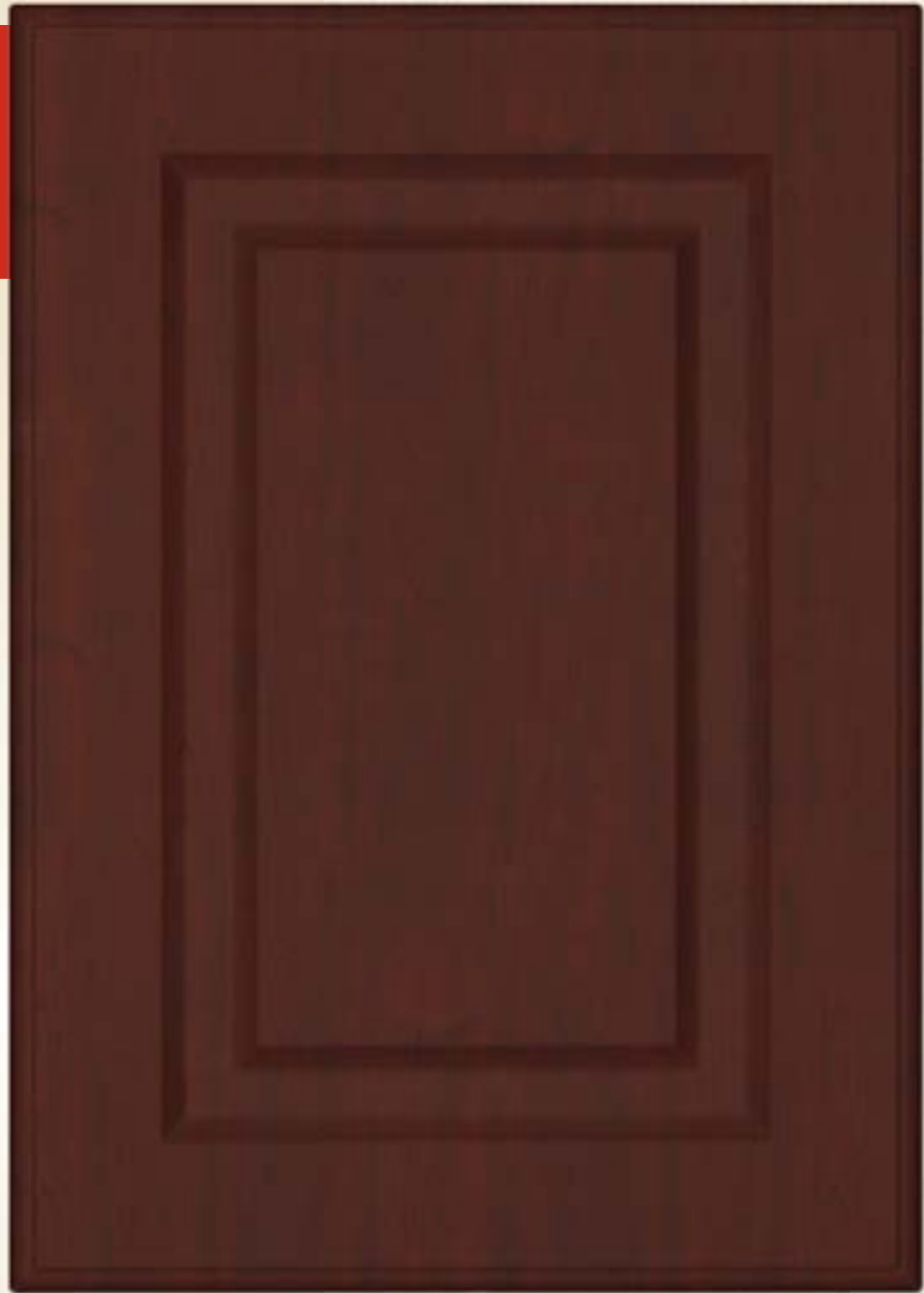

3360
Porte
Door

Profils extérieurs - Edge profiles

- | | | | | | | | | | | | | | | | |
|---|---|---|---|---|---|---|---|---|---|---|---|---|---|---|---|
| A | B | C | D | E | F | G | H | I | J | K | M | N | P | Q | T |
|---|---|---|---|---|---|---|---|---|---|---|---|---|---|---|---|

Panneaux d'appareils électroménagers - Appliance panels

- | | | | | | | | | | | | |
|-----|-----|-----|-----|-----|-----|-----|-----|-----|-----|-----|-----|
| B-2 | C-2 | D-2 | F-2 | G-2 | H-2 | I-2 | J-2 | K-2 | P-2 | Q-2 | T-2 |
|-----|-----|-----|-----|-----|-----|-----|-----|-----|-----|-----|-----|

Options - Options

- | | | | | |
|----|----|----|-----|-----------------------|
| LG | VG | VL | DVL | GRIFFE
FINGER PULL |
|----|----|----|-----|-----------------------|

Disponible pour ce modèle - Available for this model

Profil intérieur - Inside profile

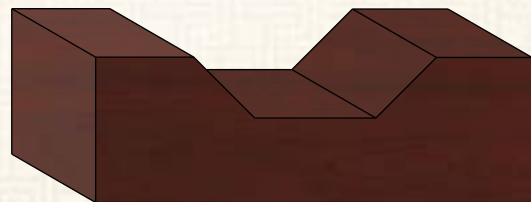

Quelques possibilités - Some possibilities



3361
Porte
Door



3360
Verrières
Mullions



3361
Verrières
Mullions



3362
Porte
Door



3360
Façade-tiroir
Drawer-facade

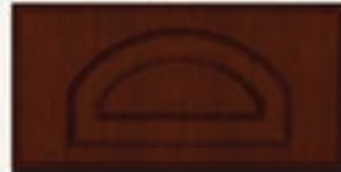

3361
Façade-tiroir
Drawer-facade



3360
Panneaux multiples
Multiple panels

POUR CONNAÎTRE TOUTES LES POSSIBILITÉS, CONSULTEZ LES PAGES : - TO KNOW ABOUT ALL POSSIBILITIES, REFER TO PAGES:

146-147-148-149

Couleurs • Finis • Finishes

15

Panneaux multiples - Multiple panels

12-13-14

Verrières - Glass doors

Modèle
Model

337

Styles Styles

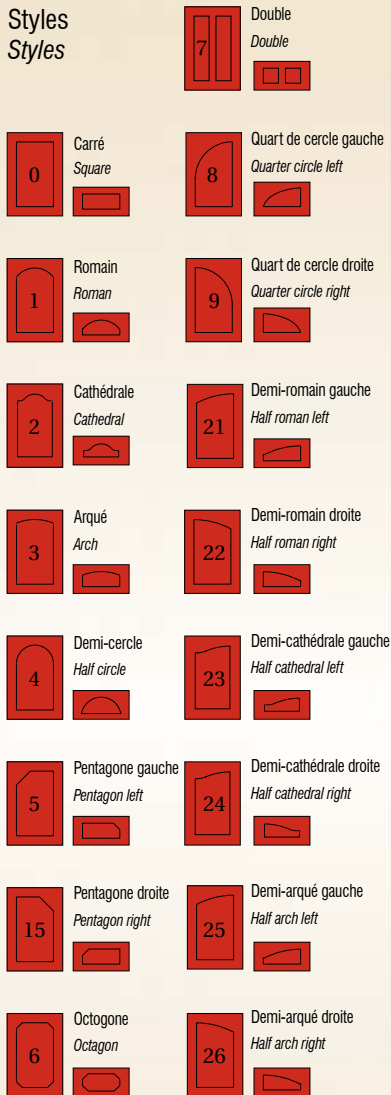

Profils extérieurs - Edge profiles

A B C D E F G H I J K M N P Q T

Panneaux d'appareils électroménagers - Appliance panels

B-2 C-2 D-2 F-2 G-2 H-2 I-2 J-2 K-2 P-2 Q-2 T-2

Options - Options

LG VG VL DVL GRIFFE
FINGER PULL

Disponible pour ce modèle - Available for this model

3370
Porte
Door



Profil intérieur - Inside profile

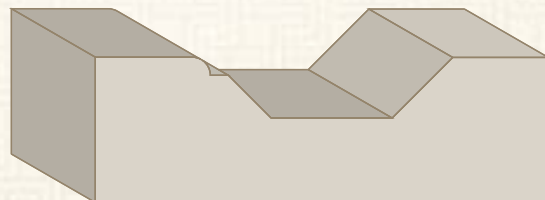

Quelques possibilités - Some possibilities



3372-3370
Panneaux multiples
Multiple panels



3371
Porte
Door



3370
Façade-tiroir
Drawer-facade



3371
Façade-tiroir
Drawer-facade



3372
Façade-tiroir
Drawer-facade



3372
Porte
Door



3370
Verrières
Mullions



3371
Verrières
Mullions

POUR CONNAÎTRE TOUTES LES POSSIBILITÉS, CONSULTEZ LES PAGES : - TO KNOW ABOUT ALL POSSIBILITIES, REFER TO PAGES:

146-147-148-149

Couleurs • Finis - Colors • Finishes

15

Panneaux multiples - Multiple panels

12-13-14

Verrières - Glass doors

Modèle
Model

338



3380
Porte
Door

Styles Styles

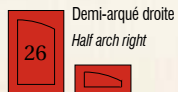
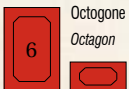
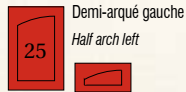
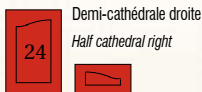
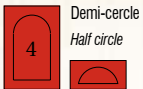
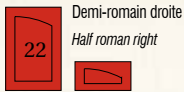
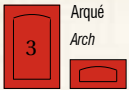
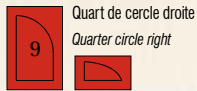
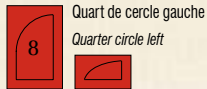
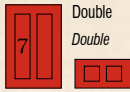

Profils extérieurs - Edge profiles

A B C D E F G H I J K M N P Q T

Panneaux d'appareils électroménagers - Appliance panels

B-2 C-2 D-2 F-2 G-2 H-2 I-2 J-2 K-2 P-2 Q-2 T-2

Options - Options

LG VG VL DVL GRIFFE
FINGER PULL

Profil intérieur - Inside profile

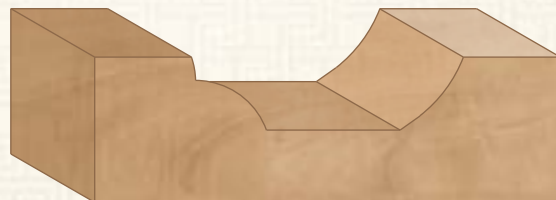

Disponible pour ce modèle - Available for this model

Quelques possibilités - Some possibilities



3382-3380
Panneaux multiples
Multiple panels



3380
Façade-tiroir
Drawer-facade



3381
Porte
Door



3381
Verrières
Mullions



3381
Façade-tiroir
Drawer-facade



3380
Verrières
Mullions



3382
Porte
Door



3382
Façade-tiroir
Drawer-facade

POUR CONNAÎTRE TOUTES LES POSSIBILITÉS, CONSULTEZ LES PAGES : - TO KNOW ABOUT ALL POSSIBILITIES, REFER TO PAGES:

146-147-148-149

Couleurs • Finis • Finishes

15

Panneaux multiples - Multiple panels

12-13-14

Verrières - Glass doors

Modèle
Model

339



3390
Porte
Door

Styles Styles

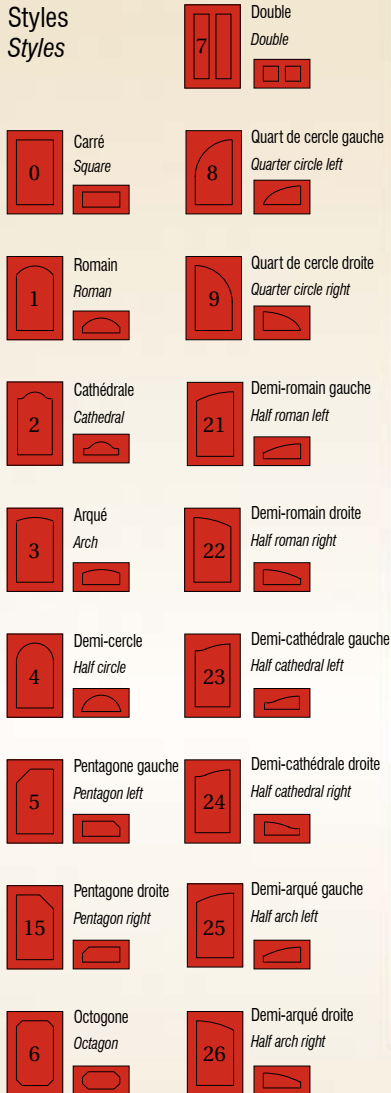

Profils extérieurs - Edge profiles

A B C D E F G H I J K M N P Q T

Panneaux d'appareils électroménagers - Appliance panels

B-2 C-2 D-2 F-2 G-2 H-2 I-2 J-2 K-2 P-2 Q-2 T-2

Options - Options

LG VG VL DVL GRIFFE
FINGER PULL

Disponible pour ce modèle - Available for this model

Profil intérieur - Inside profile

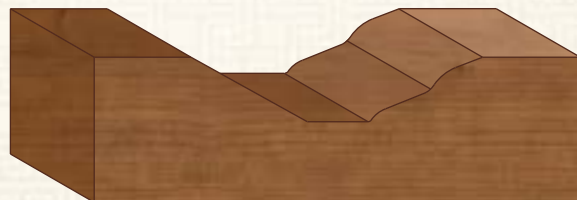

■ Quelques possibilités - *Some possibilities*



3391
Porte
Door



3392
Verrières
Mullions



3395
Verrières
Mullions



3392
Porte
Door



3390
Façade-tiroir
Drawer-facade



3391
Façade-tiroir
Drawer-facade



3390
Panneaux multiples
Multiple panels

POUR CONNAÎTRE TOUTES LES POSSIBILITÉS, CONSULTEZ LES PAGES : - TO KNOW ABOUT ALL POSSIBILITIES, REFER TO PAGES:

146-147-148-149

Couleurs • Finis • Finishes

15

Panneaux multiples - Multiple panels

12-13-14

Verrières - Glass doors

Modèle
Model

340



3400
Porte
Door

Styles Styles

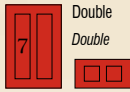

Double
Double



Carré
Square

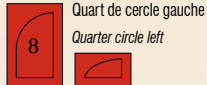

Quart de cercle gauche
Quarter circle left



Romain
Roman

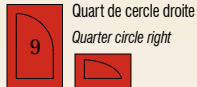

Quart de cercle droite
Quarter circle right



Cathédrale
Cathedral



Demi-romain gauche
Half roman left



Arqué
Arch

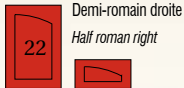

Demi-romain droite
Half roman right

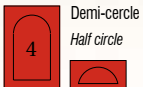

Demi-cercle
Half circle

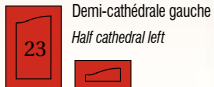

Demi-cathédrale gauche
Half cathedral left



Pentagone gauche
Pentagon left

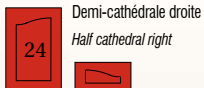

Demi-cathédrale droite
Half cathedral right



Pentagone droite
Pentagon right

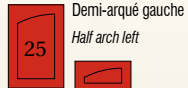

Demi-arqué gauche
Half arch left



Octogone
Octagon

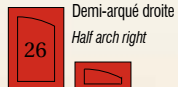

Demi-arqué droite
Half arch right

Profils extérieurs - Edge profiles

A B C D E F G H I J K M N P Q T

Panneaux d'appareils électroménagers - Appliance panels

B-2 C-2 D-2 F-2 G-2 H-2 I-2 J-2 K-2 P-2 Q-2 T-2

Options - Options

LG VG VL DVL **GRIFFE**
FINGER PULL

Profil intérieur - Inside profile



Disponible pour ce modèle - Available for this model

Quelques possibilités - Some possibilities



3402-3400
Panneaux multiples
Multiple panels



3401
Porte
Door



3400
Façade-tiroir
Drawer-facade



3401
Façade-tiroir
Drawer-facade



3402
Façade-tiroir
Drawer-facade



3402
Porte
Door



3400
Verrières
Mullions



3401
Verrières
Mullions

POUR CONNAÎTRE TOUTES LES POSSIBILITÉS, CONSULTEZ LES PAGES : - TO KNOW ABOUT ALL POSSIBILITIES, REFER TO PAGES:

Verrières - Glass doors

12-13-14

Panneaux multiples - Multiple panels

15

Couleurs • Finis • Finishes

146-147-148-149

Spécial
Special

3070

■ Profil intérieur - *Inside profile*



■ Profils extérieurs - *Edge profiles*

A B C D E F G H I J K M N P Q T

■ Panneaux d'appareils électroménagers - *Appliance panels*

B-2 C-2 D-2 F-2 G-2 H-2 I-2 J-2 K-2 P-2 Q-2 T-2

■ Options - *Options*

GRIFFE
FINGER PULL

■ Disponible pour ce modèle - *Available for this model*



3070

Porte
Door

Spécial
Special

3090

■ Profil intérieur - *Inside profile*

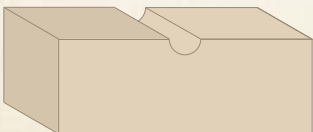

■ Profils extérieurs - *Edge profiles*

A B C D E F G H I J K M N P Q T

■ Panneaux d'appareils électroménagers - *Appliance panels*

B-2 C-2 D-2 F-2 G-2 H-2 I-2 J-2 K-2 P-2 Q-2 T-2

■ Options - *Options*

GRIFFE
FINGER PULL

■ Disponible pour ce modèle - *Available for this model*



3090

Porte
Door

3080

Porte
Door



Spécial
Special

3080

Profil intérieur - *Inside profile*



Profils extérieurs - *Edge profiles*

A B C D E F G H I J K M N P Q T

Panneaux d'appareils électroménagers - *Appliance panels*

B-2 C-2 D-2 F-2 G-2 H-2 I-2 J-2 K-2 P-2 Q-2 T-2

GRIFFE
FINGER PULL

Options - *Options*

Disponible pour ce modèle - *Available for this model*

3140

Porte
Door



Spécial
Special

3140

Profil intérieur - *Inside profile*

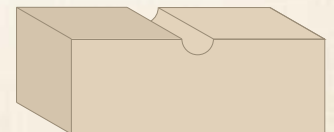

Profils extérieurs - *Edge profiles*

A B C D E F G H I J K M N P Q T

Panneaux d'appareils électroménagers - *Appliance panels*

B-2 C-2 D-2 F-2 G-2 H-2 I-2 J-2 K-2 P-2 Q-2 T-2

GRIFFE
FINGER PULL

Options - *Options*

Disponible pour ce modèle - *Available for this model*

Spécial
Special

3100

■ Profil intérieur - *Inside profile*



■ Profils extérieurs - *Edge profiles*

A B C D E F G H I J K M N P Q T

■ Panneaux d'appareils électroménagers - *Appliance panels*

B-2 C-2 D-2 F-2 G-2 H-2 I-2 J-2 K-2 P-2 Q-2 T-2

■ Options - *Options*

GRIFFE
FINGER PULL

■ Disponible pour ce modèle - *Available for this model*



3100

Porte
Door

Spécial
Special

3120

■ Profil intérieur - *Inside profile*

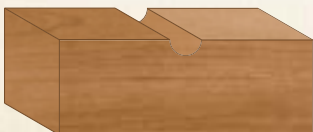

■ Profils extérieurs - *Edge profiles*

A B C D E F G H I J K M N P Q T

■ Panneaux d'appareils électroménagers - *Appliance panels*

B-2 C-2 D-2 F-2 G-2 H-2 I-2 J-2 K-2 P-2 Q-2 T-2

■ Options - *Options*

GRIFFE
FINGER PULL

■ Disponible pour ce modèle - *Available for this model*



3120

Porte
Door

3110

Porte
Door



Spécial
Special

3110

Profil intérieur - *Inside profile*



Profils extérieurs - *Edge profiles*

A	B	C	D	E	F	G	H	I	J	K	M	N	P	Q	T
---	---	---	---	---	---	---	---	---	---	---	---	---	---	---	---

Panneaux d'appareils électroménagers - *Appliance panels*

B-2	C-2	D-2	F-2	G-2	H-2	I-2	J-2	K-2	P-2	Q-2	T-2
-----	-----	-----	-----	-----	-----	-----	-----	-----	-----	-----	-----



Options - *Options*

Disponible pour ce modèle - *Available for this model*

3130

Porte
Door



Spécial
Special

3130

Profil intérieur - *Inside profile*

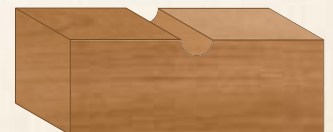

Profils extérieurs - *Edge profiles*

A	B	C	D	E	F	G	H	I	J	K	M	N	P	Q	T
---	---	---	---	---	---	---	---	---	---	---	---	---	---	---	---

Panneaux d'appareils électroménagers - *Appliance panels*

B-2	C-2	D-2	F-2	G-2	H-2	I-2	J-2	K-2	P-2	Q-2	T-2
-----	-----	-----	-----	-----	-----	-----	-----	-----	-----	-----	-----



Options - *Options*

Disponible pour ce modèle - *Available for this model*

Spécial
Special

3150

■ Profil intérieur - *Inside profile*



■ Profils extérieurs - *Edge profiles*

A B C D E F G H I J K M N P Q T

■ Panneaux d'appareils électroménagers - *Appliance panels*

B-2 C-2 D-2 F-2 G-2 H-2 I-2 J-2 K-2 P-2 Q-2 T-2

■ Options - *Options*

GRIFFE
FINGER PULL

■ Disponible pour ce modèle - *Available for this model*



3150

Porte
Door

Spécial
Special

3170

■ Profil intérieur - *Inside profile*



■ Profils extérieurs - *Edge profiles*

A B C D E F G H I J K M N P Q T

■ Panneaux d'appareils électroménagers - *Appliance panels*

B-2 C-2 D-2 F-2 G-2 H-2 I-2 J-2 K-2 P-2 Q-2 T-2

■ Options - *Options*

GRIFFE
FINGER PULL

■ Disponible pour ce modèle - *Available for this model*



3170

Porte
Door

3160

Porte
DoorSpécial
Special

3160

Profil intérieur - *Inside profile*Profils extérieurs - *Edge profiles*

A B C D E F G H I J K M N P Q T

Panneaux d'appareils électroménagers - *Appliance panels*

B-2 C-2 D-2 F-2 G-2 H-2 I-2 J-2 K-2 P-2 Q-2 T-2

GRIFFE
FINGER PULLOptions - *Options*Disponible pour ce modèle - *Available for this model*

3180

Porte
DoorSpécial
Special

3180

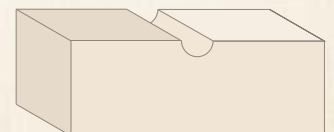
Profil intérieur - *Inside profile*Profils extérieurs - *Edge profiles*

A B C D E F G H I J K M N P Q T

Panneaux d'appareils électroménagers - *Appliance panels*

B-2 C-2 D-2 F-2 G-2 H-2 I-2 J-2 K-2 P-2 Q-2 T-2

GRIFFE
FINGER PULLOptions - *Options*Disponible pour ce modèle - *Available for this model*



Beauté, durabilité, qualité !
Beauty, durability, quality!

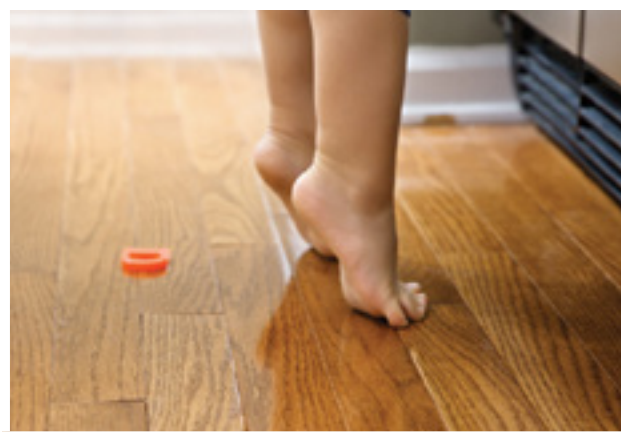

série
4000
series

THERMOFORM

Modèle
Model

440

Styles Styles

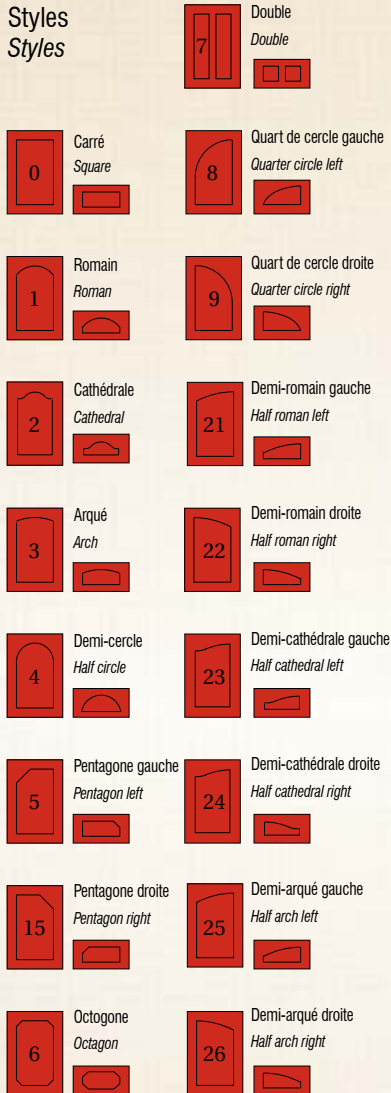

4400
Porte
Door

Profils extérieurs - Edge profiles

A B C D E F G H I J K M N P Q T

Panneaux d'appareils électroménagers - Appliance panels

B-2 C-2 D-2 F-2 G-2 H-2 I-2 J-2 K-2 P-2 Q-2 T-2

Options - Options

LG VG VL DVL GRIFFE
FINGER PULL

Profil intérieur - Inside profile

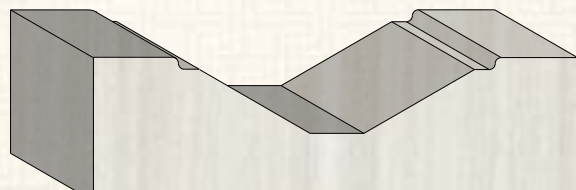

Disponible pour ce modèle - Available for this model

■ Quelques possibilités - *Some possibilities*



4402-4400

Panneaux multiples
Multiple panels



4400

Façade-tiroir
Drawer-facade



4401

Porte
Door



44031

Verrières
Mullions



4401

Façade-tiroir
Drawer-facade



4400

Verrières
Mullions



4402

Porte
Door



4402

Façade-tiroir
Drawer-facade

POUR CONNAÎTRE TOUTES LES POSSIBILITÉS, CONSULTEZ LES PAGES : - TO KNOW ABOUT ALL POSSIBILITIES, REFER TO PAGES:

Verrières - *Glass doors*

12-13-14

Panneaux multiples - *Multiple panels*

15

Couleurs • Finis - *Colors • Finishes*

146-147-148-149

Modèle
Model

441

Styles Styles

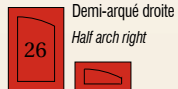
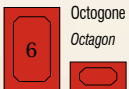
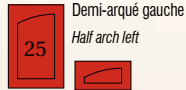
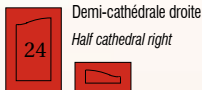
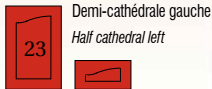
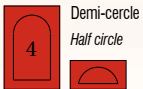
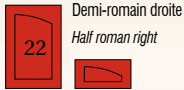
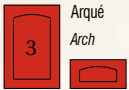
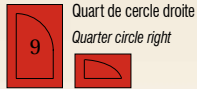
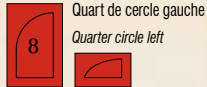
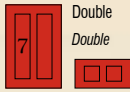

4410
Porte
Door

Profils extérieurs - Edge profiles

A B C D E F G H I J K M N P Q T

Panneaux d'appareils électroménagers - Appliance panels

B-2 C-2 D-2 F-2 G-2 H-2 I-2 J-2 K-2 P-2 Q-2 T-2

Options - Options

LG VG VL DVL GRIFFE
FINGER PULL

Disponible pour ce modèle - Available for this model

Profil intérieur - Inside profile

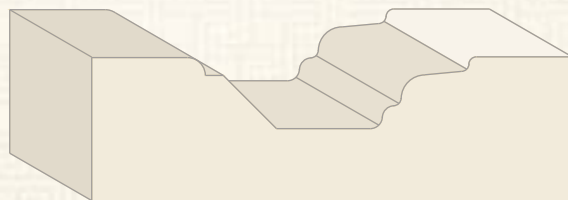

Quelques possibilités - Some possibilities



4411
Porte
Door



4410
Verrières
Mullions



4413
Verrières
Mullions



4412
Porte
Door



4410
Façade-tiroir
Drawer-facade



4411
Façade-tiroir
Drawer-facade



4418
Panneaux multiples
Multiple panels

4410

4410

4419

POUR CONNAÎTRE TOUTES LES POSSIBILITÉS, CONSULTEZ LES PAGES : - TO KNOW ABOUT ALL POSSIBILITIES, REFER TO PAGES:

146-147-148-149

Couleurs • Finis • Finishes

15

Panneaux multiples - Multiple panels

12-13-14

Verrières - Glass doors

Modèle
Model

447

Styles Styles

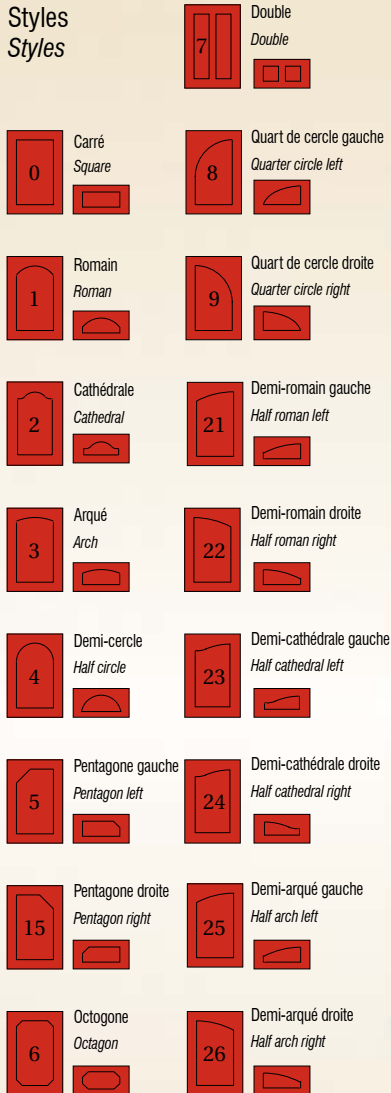

Profils extérieurs - Edge profiles

A B C D E F G H I J K M N P Q T

Panneaux d'appareils électroménagers - Appliance panels

B-2 C-2 D-2 F-2 G-2 H-2 I-2 J-2 K-2 P-2 Q-2 T-2

Options - Options

LG VG VL DVL GRIFFE
FINGER PULL

Disponible pour ce modèle - Available for this model



4470
Porte
Door

Profil intérieur - Inside profile



■ Quelques possibilités - *Some possibilities*



4472-4470

Panneaux multiples
Multiple panels



4471

Porte
Door



4470

Façade-tiroir
Drawer-facade



4471

Façade-tiroir
Drawer-facade



4472

Façade-tiroir
Drawer-facade



4472

Porte
Door



4470

Verrières
Mullions



4471

Verrières
Mullions

POUR CONNAÎTRE TOUTES LES POSSIBILITÉS, CONSULTEZ LES PAGES : - TO KNOW ABOUT ALL POSSIBILITIES, REFER TO PAGES:

Verrières - *Glass doors*

12-13-14

Panneaux multiples - *Multiple panels*

15

Couleurs • Finis • *Colors • Finishes*

146-147-148-149

Modèle
Model

448

Styles Styles

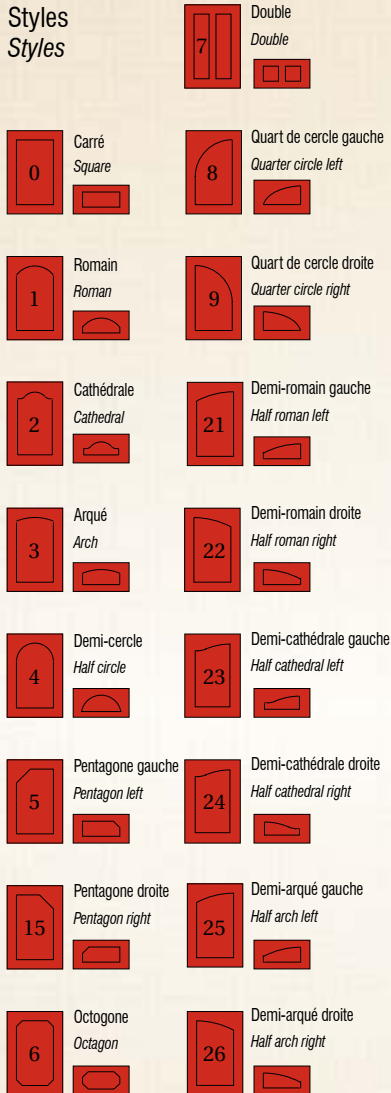

4480
Porte
Door

Profils extérieurs - Edge profiles

A B C D E F G H I J K M N P Q T

Panneaux d'appareils électroménagers - Appliance panels

B-2 C-2 D-2 F-2 G-2 H-2 I-2 J-2 K-2 P-2 Q-2 T-2

Options - Options

LG VG VL DVL GRIFFE
FINGER PULL

Profil intérieur - Inside profile

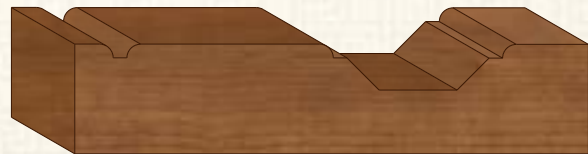

Disponible pour ce modèle - Available for this model

Quelques possibilités - Some possibilities



4482-4480
Panneaux multiples
Multiple panels



4481
Porte
Door



4480
Verrières
Mullions



4481
Verrières
Mullions



4482
Porte
Door



4480
Façade-tiroir
Drawer-facade



4481
Façade-tiroir
Drawer-facade



4482
Façade-tiroir
Drawer-facade

POUR CONNAÎTRE TOUTES LES POSSIBILITÉS, CONSULTEZ LES PAGES : - TO KNOW ABOUT ALL POSSIBILITIES, REFER TO PAGES:

146-147-148-149

Couleurs • Finis • Finishes

15

Panneaux multiples - Multiple panels

12-13-14

Verrières - Glass doors

Modèle
Model

449



4490
Porte
Door

Styles
Styles

- 7

Double
Double
- 0

Carré
Square
- 8

Quart de cercle gauche
Quarter circle left
- 1

Romain
Roman
- 9

Quart de cercle droite
Quarter circle right
- 2

Cathédrale
Cathedral
- 21

Demi-romain gauche
Half roman left
- 3

Arqué
Arch
- 22

Demi-romain droite
Half roman right
- 4

Demi-cercle
Half circle
- 23

Demi-cathédrale gauche
Half cathedral left
- 5

Pentagone gauche
Pentagon left
- 24

Demi-cathédrale droite
Half cathedral right
- 15

Pentagone droite
Pentagon right
- 25

Demi-arqué gauche
Half arch left
- 6

Octogone
Octagon
- 26

Demi-arqué droite
Half arch right

Profils extérieurs - Edge profiles

- A
- B
- C
- D
- E
- F
- G
- H
- I
- J
- K
- M
- N
- P
- Q
- T

Panneaux d'appareils électroménagers - Appliance panels

- B-2
- C-2
- D-2
- F-2
- G-2
- H-2
- I-2
- J-2
- K-2
- P-2
- Q-2
- T-2

Options - Options

- LG
- VG
- VL
- DVL
- GRIFFE
FINGER PULL

Disponible pour ce modèle - Available for this model

Profil intérieur - Inside profile



■ Quelques possibilités - *Some possibilities*



4492-4490

Panneaux multiples
Multiple panels



4491

Porte
Door



4490

Façade-tiroir
Drawer-facade



4491

Façade-tiroir
Drawer-facade



4492

Façade-tiroir
Drawer-facade



4492

Porte
Door



4490

Verrières
Mullions



4491

Verrières
Mullions

POUR CONNAÎTRE TOUTES LES POSSIBILITÉS, CONSULTEZ LES PAGES : - TO KNOW ABOUT ALL POSSIBILITIES, REFER TO PAGES:

Verrières - *Glass doors*

12-13-14

Panneaux multiples - *Multiple panels*

15

Couleurs • Finis • *Colors • Finishes*

146-147-148-149

Spécial
Special

4010

■ Profil intérieur - *Inside profile*



■ Profils extérieurs - *Edge profiles*

A B C D E F G H I J K M N P Q T

■ Panneaux d'appareils électroménagers - *Appliance panels*

B-2 C-2 D-2 F-2 G-2 H-2 I-2 J-2 K-2 P-2 Q-2 T-2

■ Options - *Options*

GRIFFE
FINGER PULL

■ Disponible pour ce modèle - *Available for this model*



4010

Porte
Door

Spécial
Special

4420

■ Profil intérieur - *Inside profile*



■ Profils extérieurs - *Edge profiles*

A B C D E F G H I J K M N P Q T

■ Panneaux d'appareils électroménagers - *Appliance panels*

B-2 C-2 D-2 F-2 G-2 H-2 I-2 J-2 K-2 P-2 Q-2 T-2

■ Options - *Options*

GRIFFE
FINGER PULL

■ Disponible pour ce modèle - *Available for this model*



4420

Porte
Door

4020

Porte
DoorSpécial
Special

4020

Profil intérieur - *Inside profile*Profils extérieurs - *Edge profiles*

A B C D E F G H I J K M N P Q T

Panneaux d'appareils électroménagers - *Appliance panels*

B-2 C-2 D-2 F-2 G-2 H-2 I-2 J-2 K-2 P-2 Q-2 T-2

GRIFFE
FINGER PULLOptions - *Options*Disponible pour ce modèle - *Available for this model*

4430

Porte
DoorSpécial
Special

4430

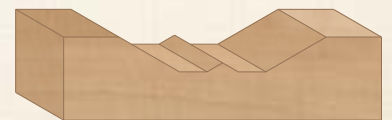
Profil intérieur - *Inside profile*Profils extérieurs - *Edge profiles*

A B C D E F G H I J K M N P Q T

Panneaux d'appareils électroménagers - *Appliance panels*

B-2 C-2 D-2 F-2 G-2 H-2 I-2 J-2 K-2 P-2 Q-2 T-2

GRIFFE
FINGER PULLOptions - *Options*Disponible pour ce modèle - *Available for this model*



Beauté, durabilité, qualité !
Beauty, durability, quality!



série
5000
series

THERMOFORM

SHAKER

Modèle
Model

535



5350

Façade-tiroir
Drawer-facade

5350

Panneaux multiples
Multiple panels

5350

Porte
Door

■ Profil intérieur - *Inside profile*



■ Profils extérieurs - *Edge profiles*

A B C D E F G H I J K M N P Q T

■ Panneaux d'appareils électroménagers - *Appliance panels*

B-2 C-2 D-2 F-2 G-2 H-2 I-2 J-2 K-2 P-2 Q-2 T-2

■ Options - *Options*

LG VG VL DVL GRIFFE
FINGER PULL

■ Disponible pour ce modèle - *Available for this model*

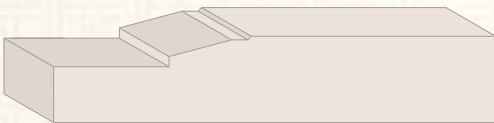
Modèle
Model**539** **SHAKER****5390**Porte
Door**5390**Façade-tiroir
Drawer-facadeProfil intérieur - *Inside profile*Profils extérieurs - *Edge profiles*

A	B	C	D	E	F	G	H	I	J	K	M	N	P	Q	T
---	---	---	---	---	---	---	---	---	---	---	---	---	---	---	---

Panneaux d'appareils électroménagers - *Appliance panels*

B-2	C-2	D-2	F-2	G-2	H-2	I-2	J-2	K-2	P-2	Q-2	T-2
-----	-----	-----	-----	-----	-----	-----	-----	-----	-----	-----	-----

Options - *Options*

LG	VG	VL	DVL	GRIFFE FINGER PULL
----	----	----	-----	-----------------------

Disponible pour ce modèle - *Available for this model***5390**Panneaux multiples
Multiple panels

Styles Styles

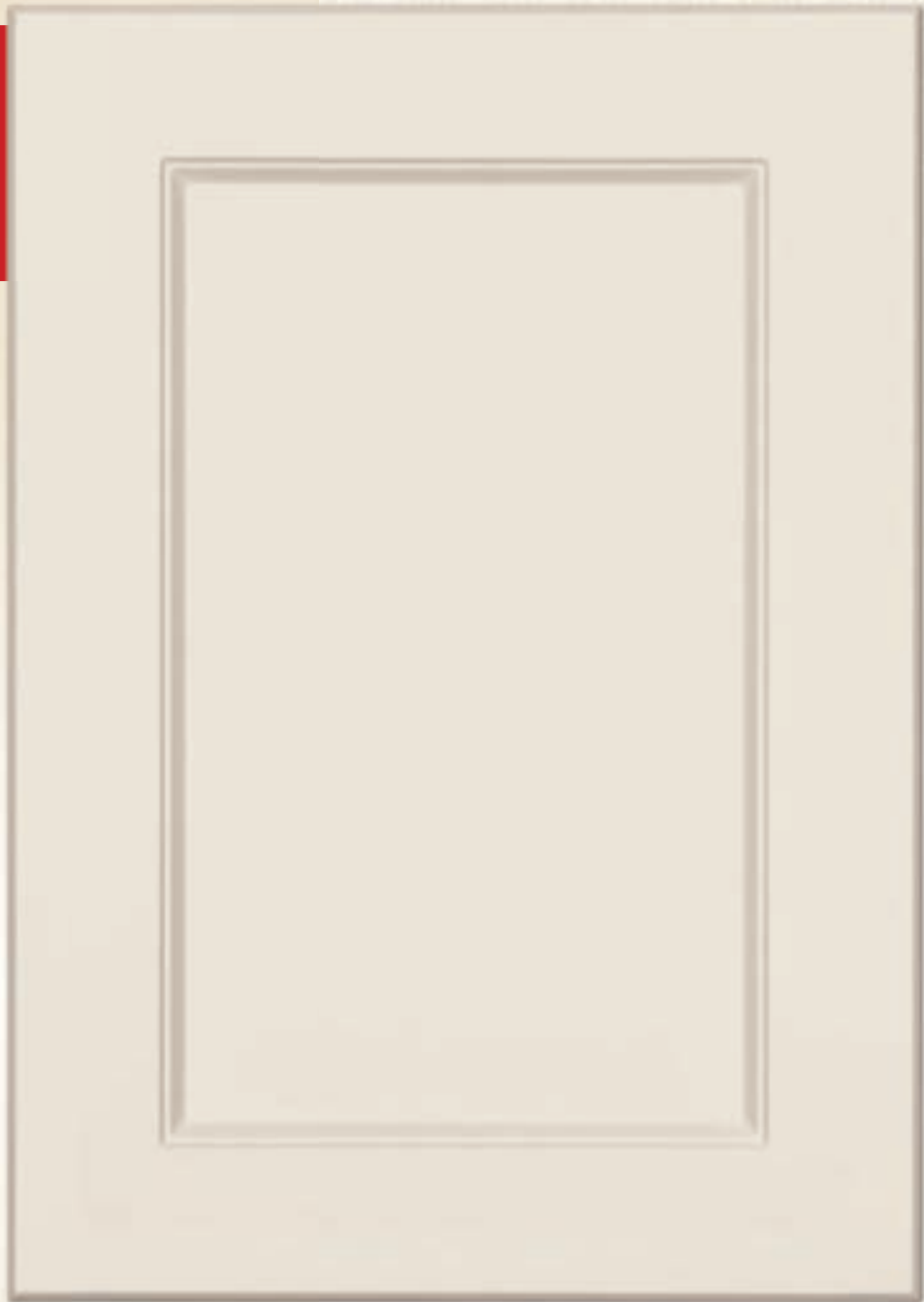
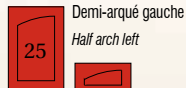
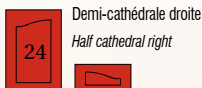
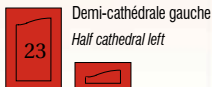
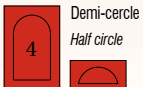
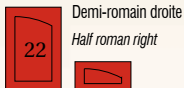
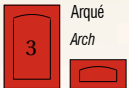
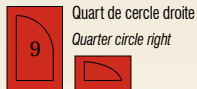
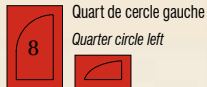
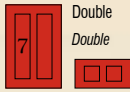

5510
Porte
Door

Profils extérieurs - Edge profiles

A B C D E F G H I J K M N P Q T

Panneaux d'appareils électroménagers - Appliance panels

B-2 C-2 D-2 F-2 G-2 H-2 I-2 J-2 K-2 P-2 Q-2 T-2

Options - Options

LG	VG	VL	DVL	GRIFFE FINGER PULL
		554	664	

Disponible pour ce modèle - Available for this model

Profil intérieur - Inside profile

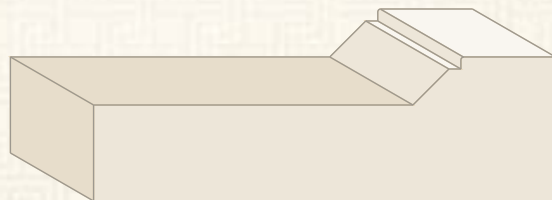

Quelques possibilités - Some possibilities



5511
Porte
Door



5510
Verrières
Mullions



5511
Verrières
Mullions



5512
Porte
Door

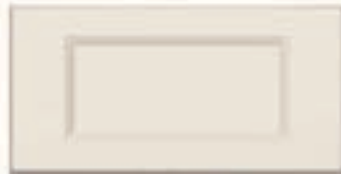

5510
Façade-tiroir
Drawer-facade



5511
Façade-tiroir
Drawer-facade



5510
Panneaux multiples
Multiple panels

POUR CONNAÎTRE TOUTES LES POSSIBILITÉS, CONSULTEZ LES PAGES : - TO KNOW ABOUT ALL POSSIBILITIES, REFER TO PAGES:

146-147-148-149

Couleurs • Finis • Finishes

15

Panneaux multiples - Multiple panels

12-13-14

Verrières - Glass doors

Styles Styles

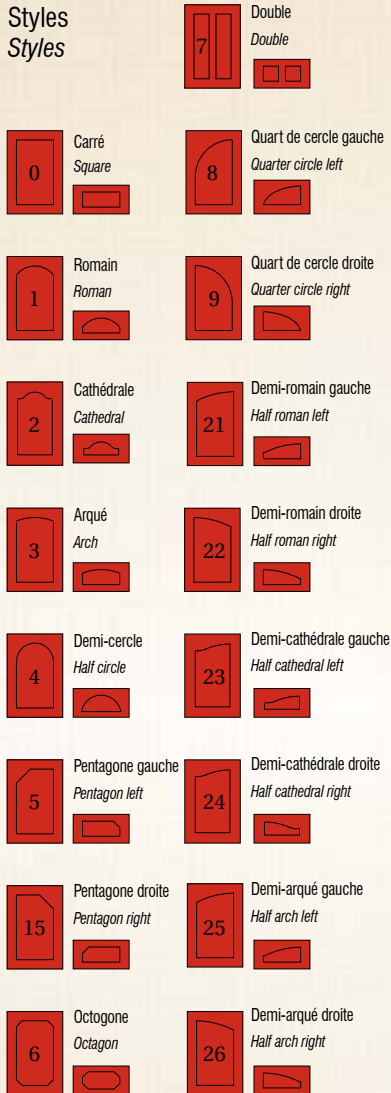

5520
Porte
Door



Profils extérieurs - Edge profiles

A B C D E F G H I J K M N P Q T

Panneaux d'appareils électroménagers - Appliance panels

B-2 C-2 D-2 F-2 G-2 H-2 I-2 J-2 K-2 P-2 Q-2 T-2

Options - Options

LG	VG	VL	DVL	GRIFFE FINGER PULL
		555	655	

Profil intérieur - Inside profile



Disponible pour ce modèle - Available for this model

Quelques possibilités - Some possibilities



5522-5520
Panneaux multiples
Multiple panels

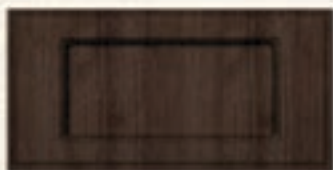

5520
Façade-tiroir
Drawer-facade



5521
Porte
Door



5522
Verrières
Mullions



5521
Façade-tiroir
Drawer-facade



5520
Verrières
Mullions



5522
Porte
Door



5522
Façade-tiroir
Drawer-facade

POUR CONNAÎTRE TOUTES LES POSSIBILITÉS, CONSULTEZ LES PAGES : - TO KNOW ABOUT ALL POSSIBILITIES, REFER TO PAGES:

146-147-148-149

Couleurs • Finis • Finishes

15

Panneaux multiples - Multiple panels

12-13-14

Verrières - Glass doors

Styles Styles

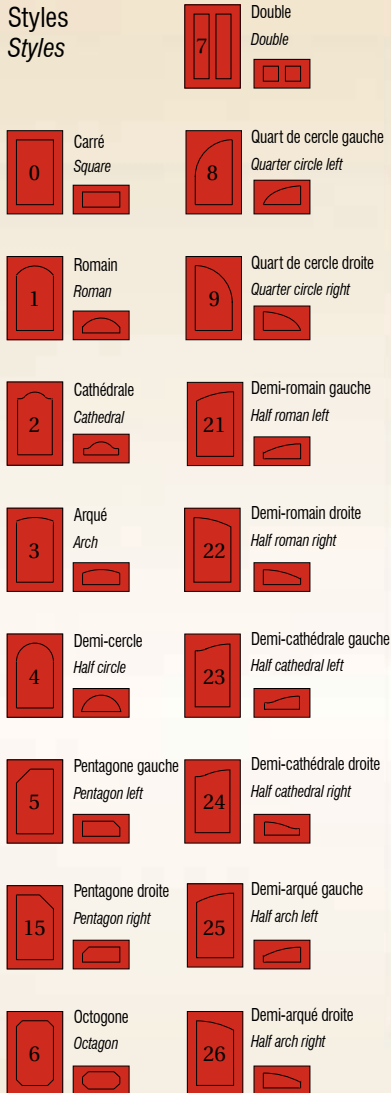

Profils extérieurs - Edge profiles

A	B	C	D	E	F	G	H	I	J	K	M	N	P	Q	T
---	---	---	---	---	---	---	---	---	---	---	---	---	---	---	---

Panneaux d'appareils électroménagers - Appliance panels

B-2	C-2	D-2	F-2	G-2	H-2	I-2	J-2	K-2	P-2	Q-2	T-2
-----	-----	-----	-----	-----	-----	-----	-----	-----	-----	-----	-----

Options - Options

LG	VG	VL	DVL	GRIFFE FINGER PULL
		556	666	

Disponible pour ce modèle - Available for this model

5530
Porte
Door



■ Quelques possibilités - *Some possibilities*



5532-5530
Panneaux multiples
Multiple panels



5531
Porte
Door



5530
Façade-tiroir
Drawer-facade



5531
Façade-tiroir
Drawer-facade



5532
Façade-tiroir
Drawer-facade



5532
Porte
Door



5530
Verrières
Mullions



5531
Verrières
Mullions

POUR CONNAÎTRE TOUTES LES POSSIBILITÉS, CONSULTEZ LES PAGES : - TO KNOW ABOUT ALL POSSIBILITIES, REFER TO PAGES:

Verrières - *Glass doors*

12-13-14



































Panneaux multiples - *Multiple panels*

15

Couleurs • Finis - *Colors • Finishes*

146-147-148-149

■ Styles
Styles

- | | | |
|--|--|---|
|  7 | Double
Double |  |
|  0 | Carré
Square |  |
|  8 | Quart de cercle gauche
Quarter circle left |  |
|  1 | Romain
Roman |  |
|  9 | Quart de cercle droite
Quarter circle right |  |
|  2 | Cathédrale
Cathedral |  |
|  21 | Demi-romain gauche
Half roman left |  |
|  3 | Arqué
Arch |  |
|  22 | Demi-romain droite
Half roman right |  |
|  4 | Demi-cercle
Half circle |  |
|  23 | Demi-cathédrale gauche
Half cathedral left |  |
|  5 | Pentagone gauche
Pentagon left |  |
|  24 | Demi-cathédrale droite
Half cathedral right |  |
|  15 | Pentagone droite
Pentagon right |  |
|  25 | Demi-arqué gauche
Half arch left |  |
|  6 | Octogone
Octagon |  |
|  26 | Demi-arqué droite
Half arch right |  |



5540
Porte
Door

■ Profils extérieurs - Edge profiles

- | | | | | | | | | | | | | | | | |
|---|---|---|---|---|---|---|---|---|---|---|---|---|---|---|---|
| A | B | C | D | E | F | G | H | I | J | K | M | N | P | Q | T |
|---|---|---|---|---|---|---|---|---|---|---|---|---|---|---|---|

■ Panneaux d'appareils électroménagers - Appliance panels

- | | | | | | | | | | | | |
|-----|-----|-----|-----|-----|-----|-----|-----|-----|-----|-----|-----|
| B-2 | C-2 | D-2 | F-2 | G-2 | H-2 | I-2 | J-2 | K-2 | P-2 | Q-2 | T-2 |
|-----|-----|-----|-----|-----|-----|-----|-----|-----|-----|-----|-----|

■ Options - Options

LG	VG	VL	DVL	GRIFFE FINGER PULL
		554	664	

■ Disponible pour ce modèle - Available for this model

■ Profil intérieur - Inside profile

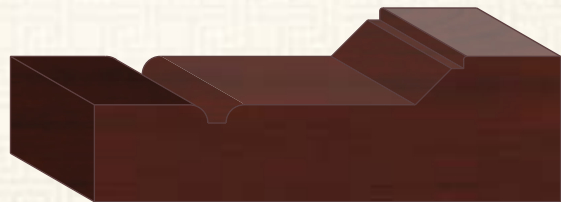

Quelques possibilités - Some possibilities



5541
Porte
Door



5540
Verrières
Mullions



5541
Verrières
Mullions



5542
Porte
Door

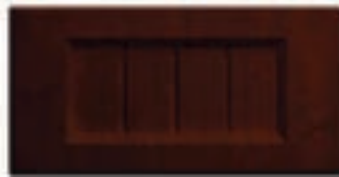

5540
Façade-tiroir
Drawer-facade

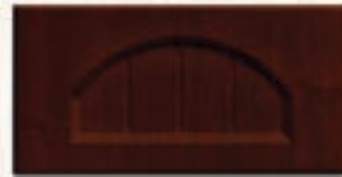

5541
Façade-tiroir
Drawer-facade

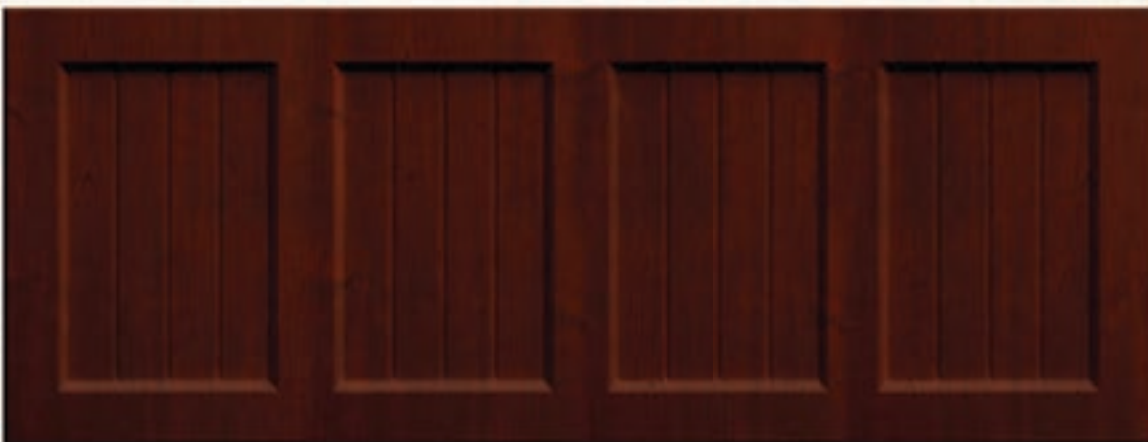

5540
Panneaux multiples
Multiple panels

POUR CONNAÎTRE TOUTES LES POSSIBILITÉS, CONSULTEZ LES PAGES : - TO KNOW ABOUT ALL POSSIBILITIES, REFER TO PAGES:

146-147-148-149

Couleurs • Finis • Finishes

15

Panneaux multiples - Multiple panels

12-13-14

Verrières - Glass doors

■ Styles
Styles

- 7

Double
Double

- 0

Carré
Square

- 8

Quart de cercle gauche
Quarter circle left

- 1

Romain
Roman

- 9

Quart de cercle droite
Quarter circle right

- 2

Cathédrale
Cathedral

- 21

Demi-romain gauche
Half roman left

- 3

Arqué
Arch

- 22

Demi-romain droite
Half roman right

- 4

Demi-cercle
Half circle

- 23

Demi-cathédrale gauche
Half cathedral left

- 5

Pentagone gauche
Pentagon left

- 24

Demi-cathédrale droite
Half cathedral right

- 15

Pentagone droite
Pentagon right

- 25

Demi-arqué gauche
Half arch left

- 6

Octogone
Octagon

- 26

Demi-arqué droite
Half arch right





5550
Porte
Door

■ Profils extérieurs - Edge profiles

- | | | | | | | | | | | | | | | | |
|---|---|---|---|---|---|---|---|---|---|---|---|---|---|---|---|
| A | B | C | D | E | F | G | H | I | J | K | M | N | P | Q | T |
|---|---|---|---|---|---|---|---|---|---|---|---|---|---|---|---|

■ Panneaux d'appareils électroménagers - Appliance panels

- | | | | | | | | | | | | |
|-----|-----|-----|-----|-----|-----|-----|-----|-----|-----|-----|-----|
| B-2 | C-2 | D-2 | F-2 | G-2 | H-2 | I-2 | J-2 | K-2 | P-2 | Q-2 | T-2 |
|-----|-----|-----|-----|-----|-----|-----|-----|-----|-----|-----|-----|

■ Options - Options

LG	VG	VL	DVL	GRIFFE FINGER PULL
		555	665	

■ Disponible pour ce modèle - Available for this model

■ Profil intérieur - Inside profile



Quelques possibilités - Some possibilities



5552-5550
Panneaux multiples
Multiple panels



5551
Porte
Door



5550
Façade-tiroir
Drawer-facade



5551
Façade-tiroir
Drawer-facade

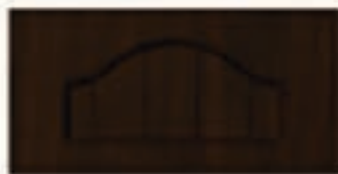

5552
Façade-tiroir
Drawer-facade



5552
Porte
Door



5550
Verrières
Mullions



5552
Verrières
Mullions

POUR CONNAÎTRE TOUTES LES POSSIBILITÉS, CONSULTEZ LES PAGES : - TO KNOW ABOUT ALL POSSIBILITIES, REFER TO PAGES:

Verrières - Glass doors

12-13-14











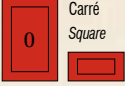

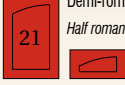

Panneaux multiples - Multiple panels

15

Couleurs • Finis • Finishes

146-147-148-149

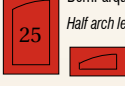
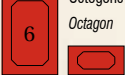
■ Styles
Styles

- | | |
|---|--|
|  | 7
Double
Double |
|  | 0
Carré
Square |
|  | 8
Quart de cercle gauche
Quarter circle left |
|  | 1
Romain
Roman |
|  | 9
Quart de cercle droite
Quarter circle right |
|  | 2
Cathédrale
Cathedral |
|  | 21
Demi-romain gauche
Half roman left |
|  | 3
Arqué
Arch |
|  | 22
Demi-romain droite
Half roman right |
|  | 4
Demi-cercle
Half circle |
|  | 23
Demi-cathédrale gauche
Half cathedral left |
|  | 5
Pentagone gauche
Pentagon left |
|  | 24
Demi-cathédrale droite
Half cathedral right |
|  | 15
Pentagone droite
Pentagon right |
|  | 25
Demi-arqué gauche
Half arch left |
|  | 6
Octogone
Octagon |
|  | 26
Demi-arqué droite
Half arch right |



5560
Porte
Door

■ Profils extérieurs - Edge profiles

- | | | | | | | | | | | | | | | | |
|---|---|---|---|---|---|---|---|---|---|---|---|---|---|---|---|
| A | B | C | D | E | F | G | H | I | J | K | M | N | P | Q | T |
|---|---|---|---|---|---|---|---|---|---|---|---|---|---|---|---|

■ Panneaux d'appareils électroménagers - Appliance panels

- | | | | | | | | | | | | |
|-----|-----|-----|-----|-----|-----|-----|-----|-----|-----|-----|-----|
| B-2 | C-2 | D-2 | F-2 | G-2 | H-2 | I-2 | J-2 | K-2 | P-2 | Q-2 | T-2 |
|-----|-----|-----|-----|-----|-----|-----|-----|-----|-----|-----|-----|

■ Options - Options

LG	VG	VL	DVL	GRIFFE FINGER PULL
		556	666	

■ Profil intérieur - Inside profile

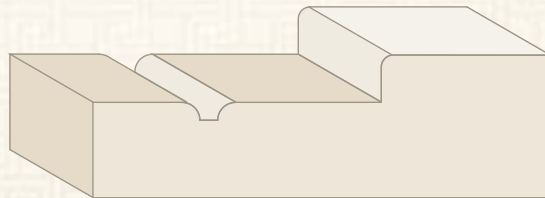

■ Disponible pour ce modèle - Available for this model

Quelques possibilités - Some possibilities



5562-5560
Panneaux multiples
Multiple panels



5561
Porte
Door



5560
Verrières
Mullions



5561
Verrières
Mullions



5562
Porte
Door



5560
Façade-tiroir
Drawer-facade



5561
Façade-tiroir
Drawer-facade



5562
Façade-tiroir
Drawer-facade

POUR CONNAÎTRE TOUTES LES POSSIBILITÉS, CONSULTEZ LES PAGES : - TO KNOW ABOUT ALL POSSIBILITIES, REFER TO PAGES:

146-147-148-149

Couleurs • Finis • Finishes

15

Panneaux multiples - Multiple panels

12-13-14

Verrières - Glass doors

Styles Styles

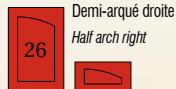
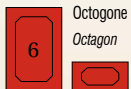
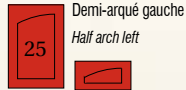
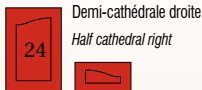
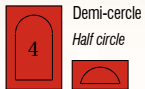
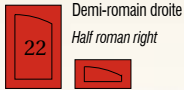
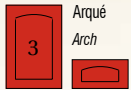
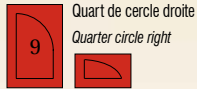
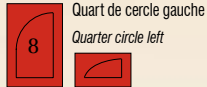
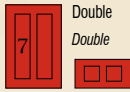

5570
Porte
Door

Profils extérieurs - Edge profiles

A B C D E F G H I J K M N P Q T

Panneaux d'appareils électroménagers - Appliance panels

B-2 C-2 D-2 F-2 G-2 H-2 I-2 J-2 K-2 P-2 Q-2 T-2

Options - Options

LG	VG	VL	DVL	GRIFFE FINGER PULL
		668	780	

Disponible pour ce modèle - Available for this model

Profil intérieur - Inside profile



Quelques possibilités - Some possibilities



5571
Porte
Door



5570
Verrières
Mullions



5571
Verrières
Mullions



5572
Porte
Door



5570
Façade-tiroir
Drawer-facade



5571
Façade-tiroir
Drawer-facade



5570
Panneaux multiples
Multiple panels

POUR CONNAÎTRE TOUTES LES POSSIBILITÉS, CONSULTEZ LES PAGES : - TO KNOW ABOUT ALL POSSIBILITIES, REFER TO PAGES:

146-147-148-149

Couleurs • Finis • Finishes

15

Panneaux multiples - Multiple panels

12-13-14

Verrières - Glass doors

Modèle
Model

558

Styles
Styles

- 7

Double
Double
- 0

Carré
Square
- 1

Romain
Roman
- 2

Cathédrale
Cathedral
- 3

Arqué
Arch
- 4

Demi-cercle
Half circle
- 5

Pentagone gauche
Pentagon left
- 15

Pentagone droite
Pentagon right
- 6

Octogone
Octagon
- 8

Quart de cercle gauche
Quarter circle left
- 9

Quart de cercle droite
Quarter circle right
- 21

Demi-romain gauche
Half roman left
- 22

Demi-romain droite
Half roman right
- 23

Demi-cathédrale gauche
Half cathedral left
- 24

Demi-cathédrale droite
Half cathedral right
- 25

Demi-arqué gauche
Half arch left
- 26

Demi-arqué droite
Half arch right



5580
Porte
Door

Profils extérieurs - Edge profiles

- | | | | | | | | | | | | | | | | |
|---|---|---|---|---|---|---|---|---|---|---|---|---|---|---|---|
| A | B | C | D | E | F | G | H | I | J | K | M | N | P | Q | T |
|---|---|---|---|---|---|---|---|---|---|---|---|---|---|---|---|

Panneaux d'appareils électroménagers - Appliance panels

- | | | | | | | | | | | | |
|-----|-----|-----|-----|-----|-----|-----|-----|-----|-----|-----|-----|
| B-2 | C-2 | D-2 | F-2 | G-2 | H-2 | I-2 | J-2 | K-2 | P-2 | Q-2 | T-2 |
|-----|-----|-----|-----|-----|-----|-----|-----|-----|-----|-----|-----|

Options - Options

- | | | | | |
|----|----|----|-----|-----------------------|
| LG | VG | VL | DVL | GRIFFE
FINGER PULL |
|----|----|----|-----|-----------------------|

Disponible pour ce modèle - Available for this model

Profil intérieur - Inside profile

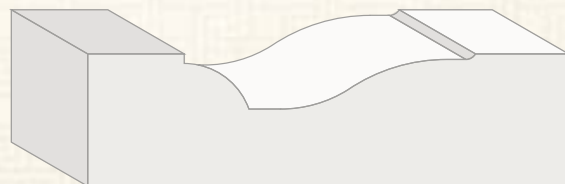

■ Quelques possibilités - *Some possibilities*



5582-5580
Panneaux multiples
Multiple panels



5581
Porte
Door



5580
Façade-tiroir
Drawer-facade



5581
Façade-tiroir
Drawer-facade



5582
Façade-tiroir
Drawer-facade



5582
Porte
Door



5580
Verrières
Mullions



5581
Verrières
Mullions

POUR CONNAÎTRE TOUTES LES POSSIBILITÉS, CONSULTEZ LES PAGES : - TO KNOW ABOUT ALL POSSIBILITIES, REFER TO PAGES:

Verrières - *Glass doors*

12-13-14

Panneaux multiples - *Multiple panels*

15

Couleurs • Finis • *Colors • Finishes*

146-147-148-149

Modèle
Model

559

Styles Styles

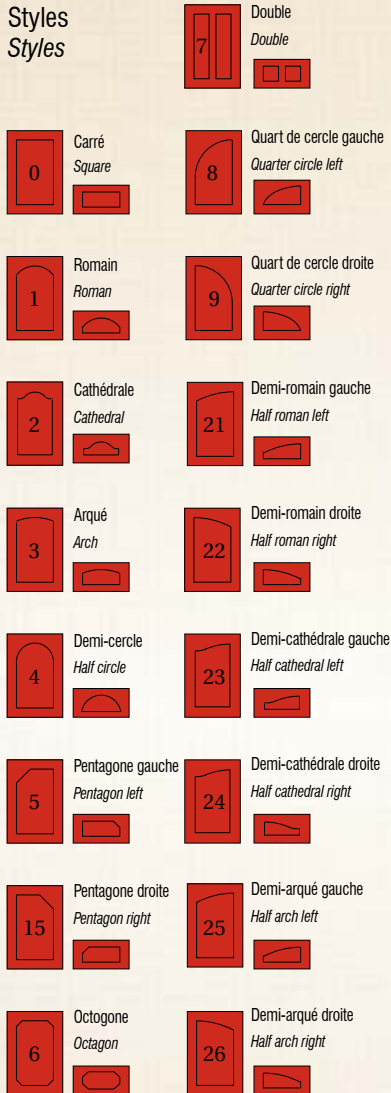

Profils extérieurs - Edge profiles

A B C D E F G H I J K M N P Q T

Panneaux d'appareils électroménagers - Appliance panels

B-2 C-2 D-2 F-2 G-2 H-2 I-2 J-2 K-2 P-2 Q-2 T-2

Options - Options

LG VG VL DVL GRIFFE
FINGER PULL

Disponible pour ce modèle - Available for this model



5590
Porte
Door

Profil intérieur - Inside profile

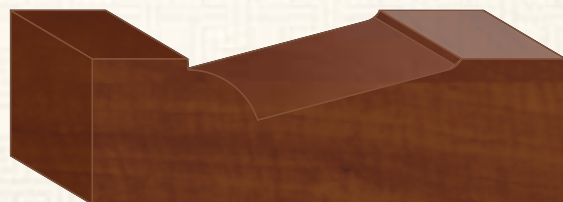

Quelques possibilités - Some possibilities



5592-5590
Panneaux multiples
Multiple panels



5591
Porte
Door

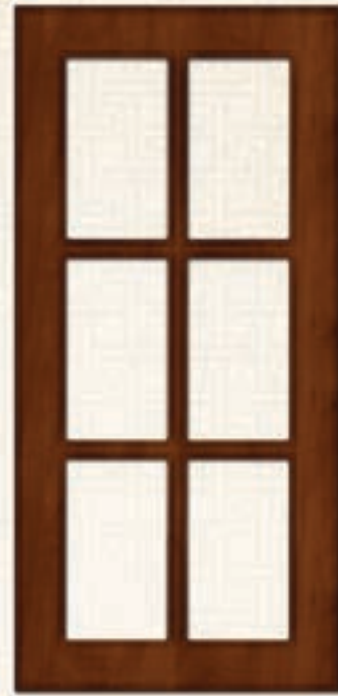

5590
Verrières
Mullions



5591
Verrières
Mullions



5592
Porte
Door



5590
Façade-tiroir
Drawer-facade



5591
Façade-tiroir
Drawer-facade



5592
Façade-tiroir
Drawer-facade

POUR CONNAÎTRE TOUTES LES POSSIBILITÉS, CONSULTEZ LES PAGES : - TO KNOW ABOUT ALL POSSIBILITIES, REFER TO PAGES:

Verrières - Glass doors 12-13-14 Panneaux multiples - Multiple panels 15 Couleurs • Finis - Colors • Finishes 146-147-148-149

Spécial
Special

5710



5710

Façade-tiroir
Drawer-facade



5710

Verrières
Mullions



5710

Porte
Door

■ Profil extérieur - Edge profile

V

■ Options - Options

GRIFFE
FINGER PULL

■ Profil intérieur - Inside profile



Offert tel qu'illustré seulement - épaisseur 3/4"

Comes as shown only - thickness 3/4"

■ Disponible pour ce modèle - Available for this model

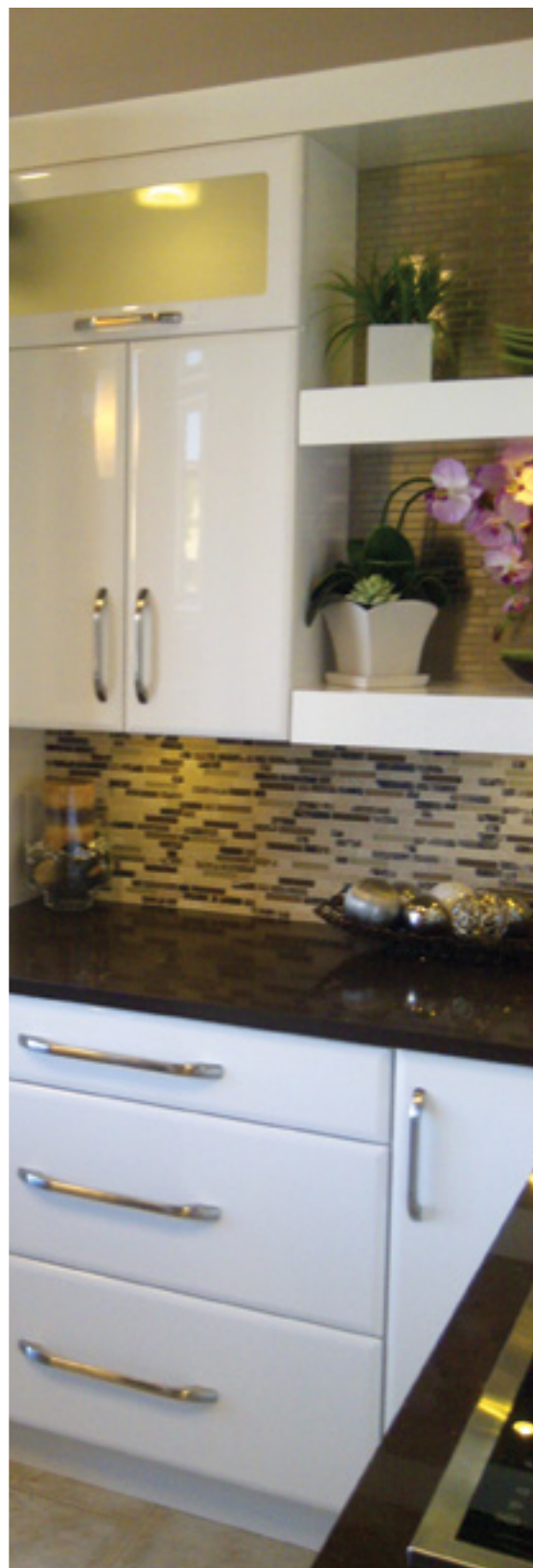



Beauté, durabilité, qualité !
Beauty, durability, quality !













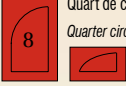

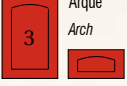

série
6000
series

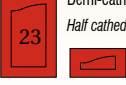
THERMOFORM

664

■ Styles
Styles

- | | |
|--|---|
|  <p>7 Double
Double</p> |  <p>0 Carré
Square</p> |
|  <p>1 Romain
Roman</p> |  <p>8 Quart de cercle gauche
Quarter circle left</p> |
|  <p>2 Cathédrale
Cathedral</p> |  <p>9 Quart de cercle droite
Quarter circle right</p> |
|  <p>3 Arqué
Arch</p> |  <p>21 Demi-romain gauche
Half roman left</p> |
|  <p>4 Demi-cercle
Half circle</p> |  <p>22 Demi-romain droite
Half roman right</p> |
|  <p>5 Pentagone gauche
Pentagon left</p> |  <p>23 Demi-cathédrale gauche
Half cathedral left</p> |
|  <p>15 Pentagone droite
Pentagon right</p> |  <p>24 Demi-cathédrale droite
Half cathedral right</p> |
|  <p>6 Octogone
Octagon</p> |  <p>25 Demi-arqué gauche
Half arch left</p> |
| |  <p>26 Demi-arqué droite
Half arch right</p> |



6640
Porte
Door

■ Profils extérieurs - Edge profiles

- | | | | | | | | | | | | | | | | |
|---|---|---|---|---|---|---|---|---|---|---|---|---|---|---|---|
| A | B | C | D | E | F | G | H | I | J | K | M | N | P | Q | T |
|---|---|---|---|---|---|---|---|---|---|---|---|---|---|---|---|

■ Panneaux d'appareils électroménagers - Appliance panels

- | | | | | | | | | | | | |
|-----|-----|-----|-----|-----|-----|-----|-----|-----|-----|-----|-----|
| B-2 | C-2 | D-2 | F-2 | G-2 | H-2 | I-2 | J-2 | K-2 | P-2 | Q-2 | T-2 |
|-----|-----|-----|-----|-----|-----|-----|-----|-----|-----|-----|-----|

■ Options - Options

LG	VG	VL	DVL	GRIFFE FINGER PULL
		554	664	

■ Profil intérieur - Inside profile

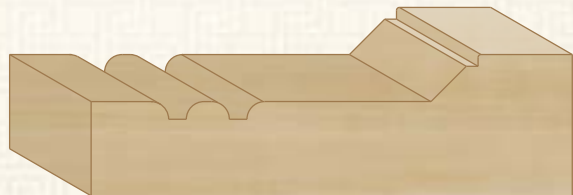

■ Disponible pour ce modèle - Available for this model

Quelques possibilités - Some possibilities



6641
Porte
Door



6640
Verrières
Mullions



6641
Verrières
Mullions



6642
Porte
Door



6641
Façade-tiroir
Drawer-facade



6642
Façade-tiroir
Drawer-facade



6640
Panneaux multiples
Multiple panels

POUR CONNAÎTRE TOUTES LES POSSIBILITÉS, CONSULTEZ LES PAGES : - TO KNOW ABOUT ALL POSSIBILITIES, REFER TO PAGES:

146-147-148-149

Couleurs • Finis - Colors • Finishes

15

Panneaux multiples - Multiple panels

12-13-14

Verrières - Glass doors

665

Styles
Styles

- 7

Double
Double
- 0

Carré
Square
- 1

Romain
Roman
- 2

Cathédrale
Cathedral
- 3

Arqué
Arch
- 4

Demi-cercle
Half circle
- 5

Pentagone gauche
Pentagon left
- 15

Pentagone droite
Pentagon right
- 6

Octogone
Octagon
- 8

Quart de cercle gauche
Quarter circle left
- 9

Quart de cercle droite
Quarter circle right
- 21

Demi-romain gauche
Half roman left
- 22

Demi-romain droite
Half roman right
- 23

Demi-cathédrale gauche
Half cathedral left
- 24

Demi-cathédrale droite
Half cathedral right
- 25

Demi-arqué gauche
Half arch left
- 26

Demi-arqué droite
Half arch right



6650
Porte
Door

Profils extérieurs - Edge profiles

- | | | | | | | | | | | | | | | | |
|---|---|---|---|---|---|---|---|---|---|---|---|---|---|---|---|
| A | B | C | D | E | F | G | H | I | J | K | M | N | P | Q | T |
|---|---|---|---|---|---|---|---|---|---|---|---|---|---|---|---|

Panneaux d'appareils électroménagers - Appliance panels

- | | | | | | | | | | | | |
|-----|-----|-----|-----|-----|-----|-----|-----|-----|-----|-----|-----|
| B-2 | C-2 | D-2 | F-2 | G-2 | H-2 | I-2 | J-2 | K-2 | P-2 | Q-2 | T-2 |
|-----|-----|-----|-----|-----|-----|-----|-----|-----|-----|-----|-----|

Options - Options

LG	VG	VL	DVL	GRIFFE FINGER PULL
		555	665	

Profil intérieur - Inside profile

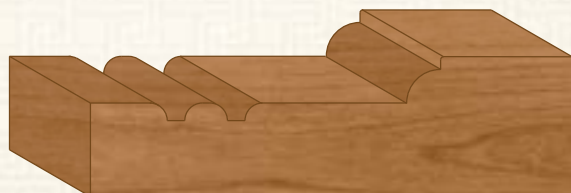

Disponible pour ce modèle - Available for this model

Quelques possibilités - Some possibilities



6652-6650
Panneaux multiples
Multiple panels



6651
Porte
Door



6650
Façade-tiroir
Drawer-facade



6651
Façade-tiroir
Drawer-facade



6652
Façade-tiroir
Drawer-facade



6652
Porte
Door



6650
Verrières
Mullions



6652
Verrières
Mullions

POUR CONNAÎTRE TOUTES LES POSSIBILITÉS, CONSULTEZ LES PAGES : - TO KNOW ABOUT ALL POSSIBILITIES, REFER TO PAGES:

Verrières - Glass doors

12-13-14

Panneaux multiples - Multiple panels

15

Couleurs • Finis • Finishes

146-147-148-149



666

Styles
Styles

- 



7

Double
Double

- 



0

Carré
Square

- 



8

Quart de cercle gauche
Quarter circle left

- 



1

Romain
Roman

- 



9

Quart de cercle droite
Quarter circle right

- 



2

Cathédrale
Cathedral

- 



21

Demi-romain gauche
Half roman left

- 



3

Arqué
Arch

- 



22

Demi-romain droite
Half roman right

- 



4

Demi-cercle
Half circle

- 



23

Demi-cathédrale gauche
Half cathedral left

- 



5

Pentagone gauche
Pentagon left

- 



24

Demi-cathédrale droite
Half cathedral right

- 



15

Pentagone droite
Pentagon right

- 



25

Demi-arqué gauche
Half arch left

- 

6

Octogone
Octagon

- 

26

Demi-arqué droite
Half arch right





6660
Porte
Door

Profils extérieurs - Edge profiles

- | | | | | | | | | | | | | | | | |
|---|---|---|---|---|---|---|---|---|---|---|---|---|---|---|---|
| A | B | C | D | E | F | G | H | I | J | K | M | N | P | Q | T |
|---|---|---|---|---|---|---|---|---|---|---|---|---|---|---|---|

Panneaux d'appareils électroménagers - Appliance panels

- | | | | | | | | | | | | |
|-----|-----|-----|-----|-----|-----|-----|-----|-----|-----|-----|-----|
| B-2 | C-2 | D-2 | F-2 | G-2 | H-2 | I-2 | J-2 | K-2 | P-2 | Q-2 | T-2 |
|-----|-----|-----|-----|-----|-----|-----|-----|-----|-----|-----|-----|

Options - Options

- | | | | | |
|----|----|-----|-----|-----------------------|
| LG | VG | VL | DVL | GRIFFE
FINGER PULL |
| | | 556 | 666 | |

Profil intérieur - Inside profile

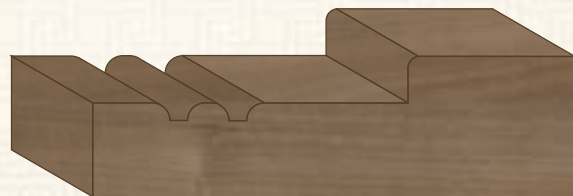

Disponible pour ce modèle - Available for this model

Quelques possibilités - Some possibilities



6662-6660
Panneaux multiples
Multiple panels



6661
Porte
Door



6660
Verrières
Mullions



6661
Verrières
Mullions



6662
Porte
Door

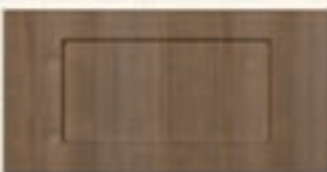

6660
Façade-tiroir
Drawer-facade



6661
Façade-tiroir
Drawer-facade



6662
Façade-tiroir
Drawer-facade

POUR CONNAÎTRE TOUTES LES POSSIBILITÉS, CONSULTEZ LES PAGES : - TO KNOW ABOUT ALL POSSIBILITIES, REFER TO PAGES:

Verrières - Glass doors

12-13-14

Panneaux multiples - Multiple panels

15

Couleurs • Finis • Finishes







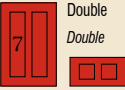
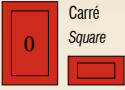

146-147-148-149

SHAKER

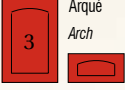
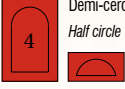
Modèle
Model

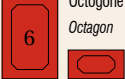
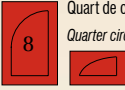
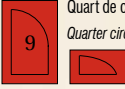
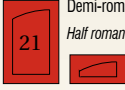
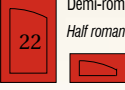
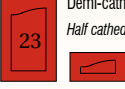
668

Styles Styles

- 
7 Double
Double
- 
0 Carré
Square
- 
1 Romain
Roman
- 
2 Cathédrale
Cathedral
- 
3 Arqué
Arch
- 
4 Demi-cercle
Half circle
- 
5 Pentagone gauche
Pentagon left
- 
15 Pentagone droite
Pentagon right
- 
6 Octogone
Octagon
- 
8 Quart de cercle gauche
Quarter circle left
- 
9 Quart de cercle droite
Quarter circle right
- 
21 Demi-romain gauche
Half roman left
- 
22 Demi-romain droite
Half roman right
- 
23 Demi-cathédrale gauche
Half cathedral left
- 
24 Demi-cathédrale droite
Half cathedral right
- 
25 Demi-arqué gauche
Half arch left
- 
26 Demi-arqué droite
Half arch right



6680
Porte
Door

Profils extérieurs - Edge profiles

A B C D E F G H I J K M N P Q T

Panneaux d'appareils électroménagers - Appliance panels

B-2 C-2 D-2 F-2 G-2 H-2 I-2 J-2 K-2 P-2 Q-2 T-2

Options - Options

LG	VG	VL	DVL	GRIFFE FINGER PULL
		668	780	

Disponible pour ce modèle - Available for this model

Profil intérieur - Inside profile

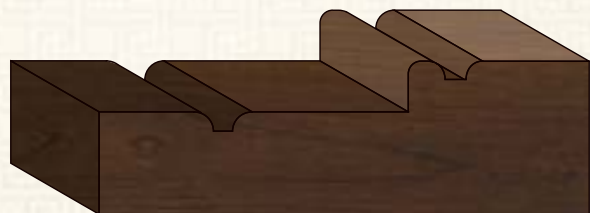

Quelques possibilités - Some possibilities



6681
Porte
Door



6680
Verrières
Mullions



6681
Verrières
Mullions



6682
Porte
Door



6680
Façade-tiroir
Drawer-facade



6681
Façade-tiroir
Drawer-facade

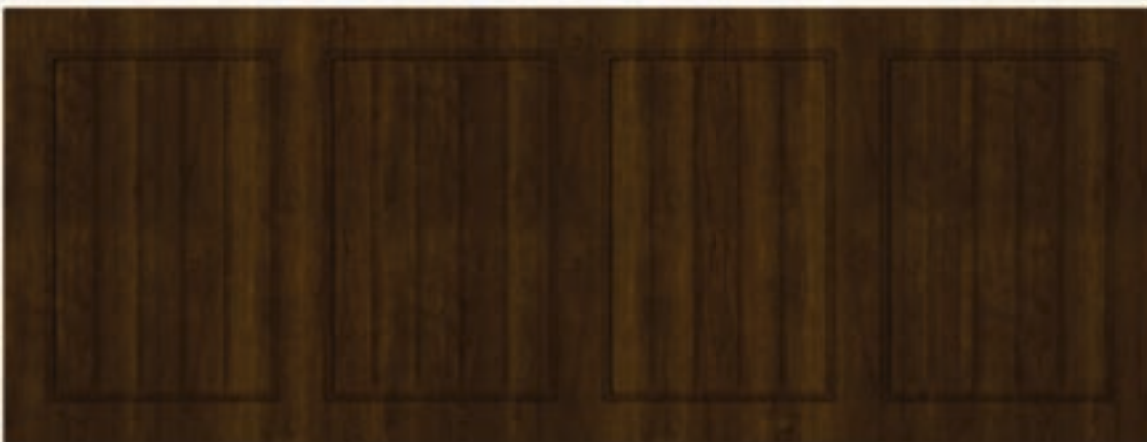

6680
Panneaux multiples
Multiple panels

POUR CONNAÎTRE TOUTES LES POSSIBILITÉS, CONSULTEZ LES PAGES : - TO KNOW ABOUT ALL POSSIBILITIES, REFER TO PAGES:

Verrières - Glass doors

12-13-14

Panneaux multiples - Multiple panels

15

Couleurs • Finis • Finishes

146-147-148-149



Beauté, durabilité, qualité !
Beauty, durability, quality!



série
7000
series

THERMOFORM

SHAKER

Modèle
Model

780



7800
Porte
Door

- Styles**
Styles
- 7** Double
Double
 - 0** Carré
Square
 - 1** Romain
Roman
 - 2** Cathédrale
Cathedral
 - 3** Arqué
Arch
 - 4** Demi-cercle
Half circle
 - 5** Pentagone gauche
Pentagon left
 - 15** Pentagone droite
Pentagon right
 - 6** Octogone
Octagon
 - 8** Quart de cercle gauche
Quarter circle left
 - 9** Quart de cercle droite
Quarter circle right
 - 21** Demi-romain gauche
Half roman left
 - 22** Demi-romain droite
Half roman right
 - 23** Demi-cathédrale gauche
Half cathedral left
 - 24** Demi-cathédrale droite
Half cathedral right
 - 25** Demi-arqué gauche
Half arch left
 - 26** Demi-arqué droite
Half arch right

Profils extérieurs - Edge profiles

- | | | | | | | | | | | | | | | | |
|---|---|---|---|---|---|---|---|---|---|---|---|---|---|---|---|
| A | B | C | D | E | F | G | H | I | J | K | M | N | P | Q | T |
|---|---|---|---|---|---|---|---|---|---|---|---|---|---|---|---|

Panneaux d'appareils électroménagers - Appliance panels

- | | | | | | | | | | | | |
|-----|-----|-----|-----|-----|-----|-----|-----|-----|-----|-----|-----|
| B-2 | C-2 | D-2 | F-2 | G-2 | H-2 | I-2 | J-2 | K-2 | P-2 | Q-2 | T-2 |
|-----|-----|-----|-----|-----|-----|-----|-----|-----|-----|-----|-----|

Options - Options

LG	VG	VL	DVL	GRIFFE FINGER PULL
		668	780	

Profil intérieur - Inside profile

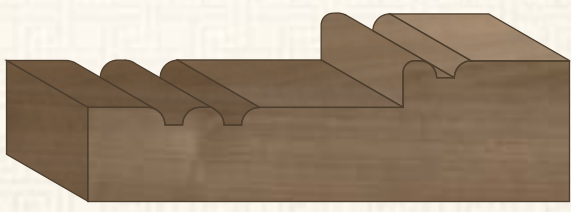

Disponible pour ce modèle - Available for this model

Quelques possibilités - Some possibilities



7802-7800
Panneaux multiples
Multiple panels



7801
Porte
Door



7800
Façade-tiroir
Drawer-facade



7801
Façade-tiroir
Drawer-facade



7802
Façade-tiroir
Drawer-facade



7802
Porte
Door



7800
Verrières
Mullions



7801
Verrières
Mullions

POUR CONNAÎTRE TOUTES LES POSSIBILITÉS, CONSULTEZ LES PAGES : - TO KNOW ABOUT ALL POSSIBILITIES, REFER TO PAGES:

Verrières - Glass doors

12-13-14

Panneaux multiples - Multiple panels

15

Couleurs • Finis • Finishes

146-147-148-149

SHAKER

Spécial
Special

7660

7660

Façade-tiroir
Drawer-facade

7660

Panneaux multiples
Multiple panels

7660

Porte
Door

■ Profil intérieur - *Inside profile*



■ Profils extérieurs - *Edge profiles*

A	B	C	D	E	F	G	H	I	J	K	M	N	P	Q	T
---	---	---	---	---	---	---	---	---	---	---	---	---	---	---	---

■ Panneaux d'appareils électroménagers - *Appliance panels*

B-2	C-2	D-2	F-2	G-2	H-2	I-2	J-2	K-2	P-2	Q-2	T-2
-----	-----	-----	-----	-----	-----	-----	-----	-----	-----	-----	-----

■ Options - *Options*

LG	VG	VL	DVL	GRIFFE FINGER PULL
----	----	----	-----	-----------------------

■ Disponible pour ce modèle - *Available for this model*

7680

7680

Porte
Door

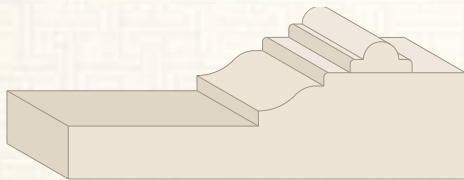
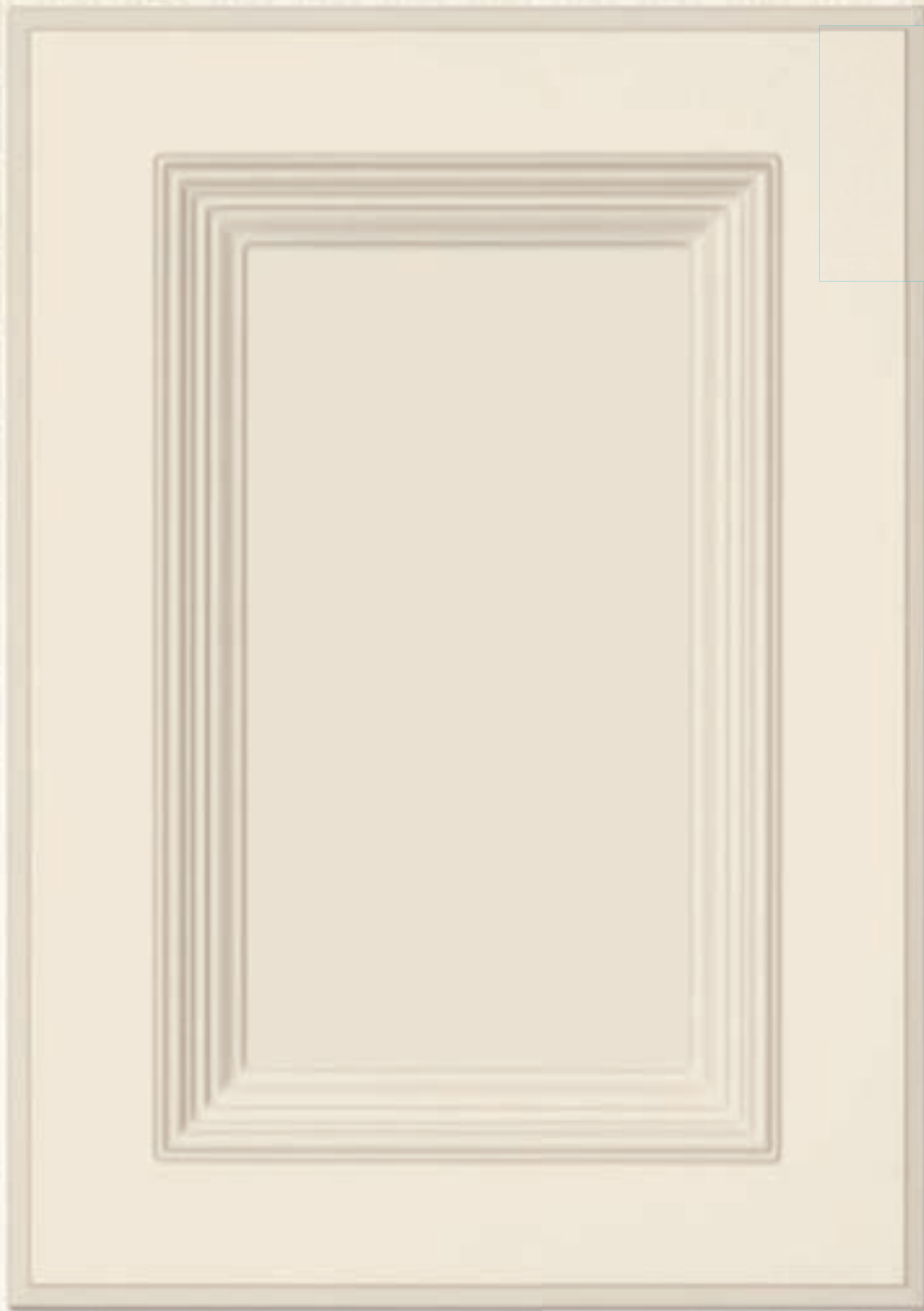

Profil intérieur - *Inside profile*

Profils extérieurs - *Edge profiles*

A B C D E F G H I J K M N P Q T

Panneaux d'appareils électroménagers - *Appliance panels*

B-2 C-2 D-2 F-2 G-2 H-2 I-2 J-2 K-2 P-2 Q-2 T-2

Options - *Options*

LG	VG	VL	DVL	GRIFFE FINGER PULL
		8680	8690	

Non disponible dans les finis lustrées et les couleurs suivantes : 61, 104, 132 et 162.

Not available in glossy finishes and in these colors: 61, 104, 132 et 162.

Disponible pour ce modèle - *Available for this model*

7680

Panneaux multiples
Multiple panels

7680

Façade-tiroir
Drawer-facade

Spécial
Special

7700



7700

Façade-tiroir
Drawer-facade



7700

Panneaux multiples
Multiple panels



7700

Porte
Door

■ Profil intérieur - *Inside profile*

■ Profils extérieurs - *Edge profiles*

A B C D E F G H I J K M N P Q T

■ Panneaux d'appareils électroménagers - *Appliance panels*

B-2 C-2 D-2 F-2 G-2 H-2 I-2 J-2 K-2 P-2 Q-2 T-2

■ Options - *Options*

LG VG VL DVL GRIFFE
FINGER PULL

■ Disponible pour ce modèle - *Available for this model*

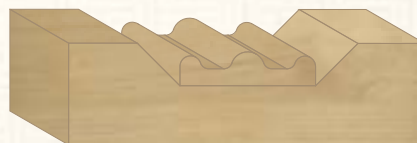

Spécial
Special

7720

7720

Porte
Door

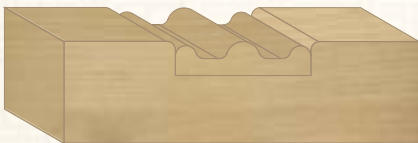

Profil intérieur - *Inside profile*

Profils extérieurs - *Edge profiles*

A B C D E F G H I J K M N P Q T

Panneaux d'appareils électroménagers - *Appliance panels*

B-2 C-2 D-2 F-2 G-2 H-2 I-2 J-2 K-2 P-2 Q-2 T-2

Options - *Options*

LG VG VL DVL GRIFFE
FINGER PULL

Disponible pour ce modèle - *Available for this model*

7720

Panneaux multiples
Multiple panels



7720

Façade-tiroir
Drawer-facade

Spécial
Special

7750



7750

Façade-tiroir
Drawer-facade



7750

Panneaux multiples
Multiple panels



7750

Porte
Door

■ Profil intérieur - *Inside profile*



■ Profils extérieurs - *Edge profiles*

A	B	C	D	E	F	G	H	I	J	K	M	N	P	Q	T
---	---	---	---	---	---	---	---	---	---	---	---	---	---	---	----------

■ Panneaux d'appareils électroménagers - *Appliance panels*

B-2	C-2	D-2	F-2	G-2	H-2	I-2	J-2	K-2	P-2	Q-2	T-2
-----	-----	-----	-----	-----	-----	-----	-----	-----	-----	-----	------------

■ Options - *Options*

LG	VG	VL	DVL	GRIFFE FINGER PULL
----	----	-----------	------------	-----------------------

■ Disponible pour ce modèle - *Available for this model*

Spécial
Special

7760

7760

Porte
Door



Profil intérieur - *Inside profile*

Profils extérieurs - *Edge profiles*

A	B	C	D	E	F	G	H	I	J	K	M	N	P	Q	T
---	---	---	---	---	---	---	---	---	---	---	---	---	---	---	----------

Panneaux d'appareils électroménagers - *Appliance panels*

B-2	C-2	D-2	F-2	G-2	H-2	I-2	J-2	K-2	P-2	Q-2	T-2
-----	-----	-----	-----	-----	-----	-----	-----	-----	-----	-----	------------

Options - *Options*

LG	VG	VL	DVL	GRIFFE FINGER PULL
----	----	-----------	------------	-----------------------

Disponible pour ce modèle - *Available for this model*

7760

Panneaux multiples
Multiple panels



7760

Façade-tiroir
Drawer-facade

Spécial
Special

7770



7770

Façade-tiroir
Drawer-facade



7770

Panneaux multiples
Multiple panels

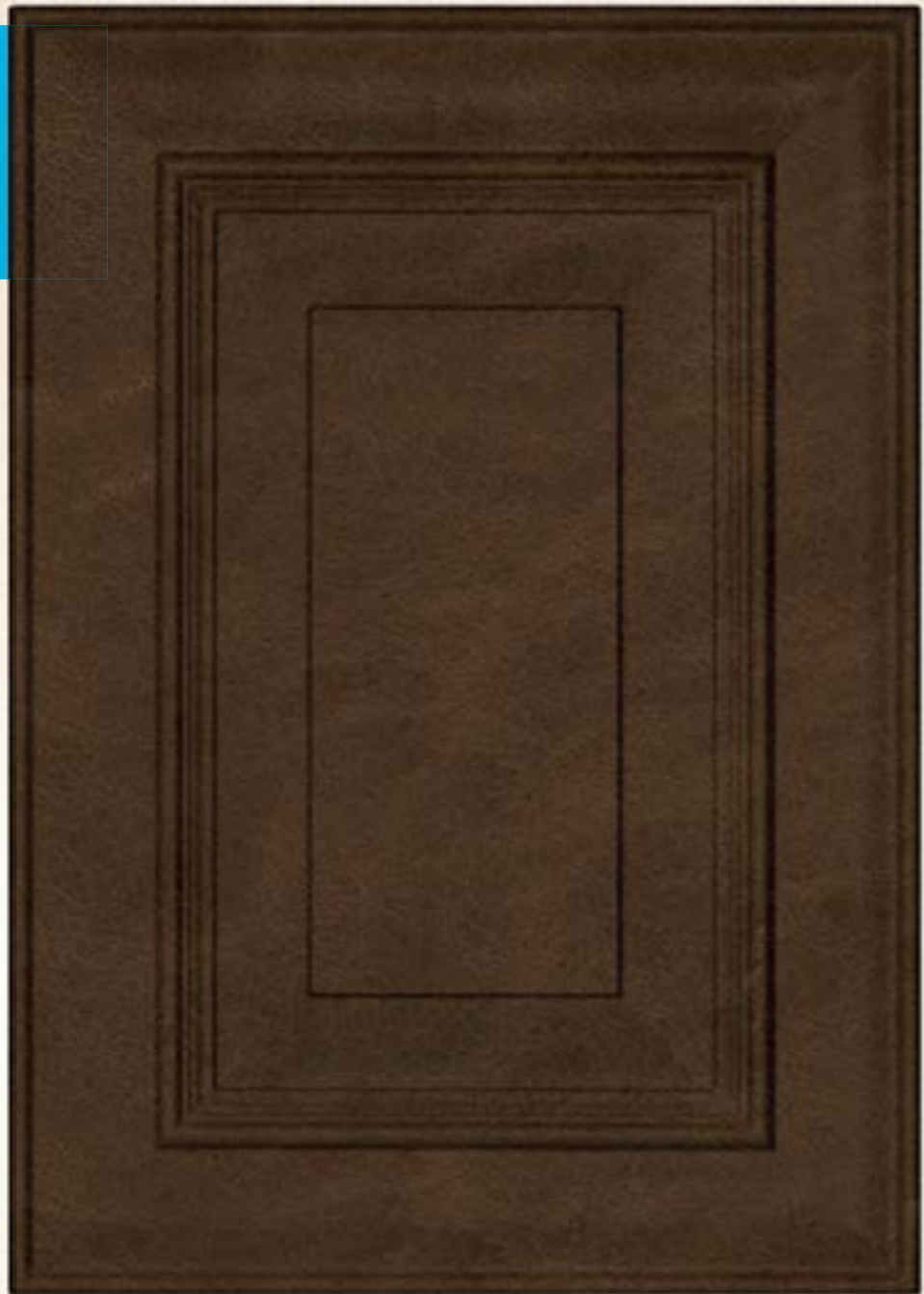

7770

Porte
Door

■ Profil intérieur - *Inside profile*



■ Profils extérieurs - *Edge profiles*

A	B	C	D	E	F	G	H	I	J	K	M	N	P	Q	T
---	---	---	---	---	---	---	---	---	---	---	---	---	---	---	----------

■ Panneaux d'appareils électroménagers - *Appliance panels*

B-2	C-2	D-2	F-2	G-2	H-2	I-2	J-2	K-2	P-2	Q-2	T-2
-----	-----	-----	-----	-----	-----	-----	-----	-----	-----	-----	------------

■ Options - *Options*

LG	VG	VL	DVL	GRIFFE FINGER PULL
----	----	-----------	------------	-----------------------

■ Disponible pour ce modèle - *Available for this model*



série
8000
series

THERMOFORM

SHAKER

Spécial
Special

8680



8680

Façade-tiroir
Drawer-facade

8680

Panneaux multiples
Multiple panels

8680

Porte
Door

■ Profil intérieur - *Inside profile*

■ Profils extérieurs - *Edge profiles*

A	B	C	D	E	F	G	H	I	J	K	M	N	P	Q	T
---	---	---	---	---	---	---	---	---	---	---	---	---	---	---	---

■ Panneaux d'appareils électroménagers - *Appliance panels*

B-2	C-2	D-2	F-2	G-2	H-2	I-2	J-2	K-2	P-2	Q-2	T-2
-----	-----	-----	-----	-----	-----	-----	-----	-----	-----	-----	-----

■ Options - *Options*

LG	VG	VL	DVL	GRIFFE FINGER PULL
8680				8690

■ Disponible pour ce modèle - *Available for this model*

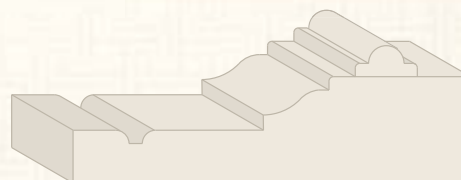

Non disponible dans les finis lustrées et les couleurs
suivantes : 61, 104, 132 et 162.

*Not available in glossy finishes and in these colors:
61, 104, 132 and 162.*

Spécial
Special

SHAKER

8800

8800

Porte
Door



Profil intérieur - *Inside profile*

Profilis extérieurs - *Edge profiles*

A B C D E F G H I J K M N P Q T

Panneaux d'appareils électroménagers - *Appliance panels*

B-2 C-2 D-2 F-2 G-2 H-2 I-2 J-2 K-2 P-2 Q-2 T-2

Options - *Options*

LG VG VL DVL GRIFFE
FINGER PULL

Disponible pour ce modèle - *Available for this model*

8800

Panneaux multiples
Multiple panels



8800

Façade-tiroir
Drawer-facade

SHAKER

Spécial
Special

8820



8820

Façade-tiroir
Drawer-facade

8820

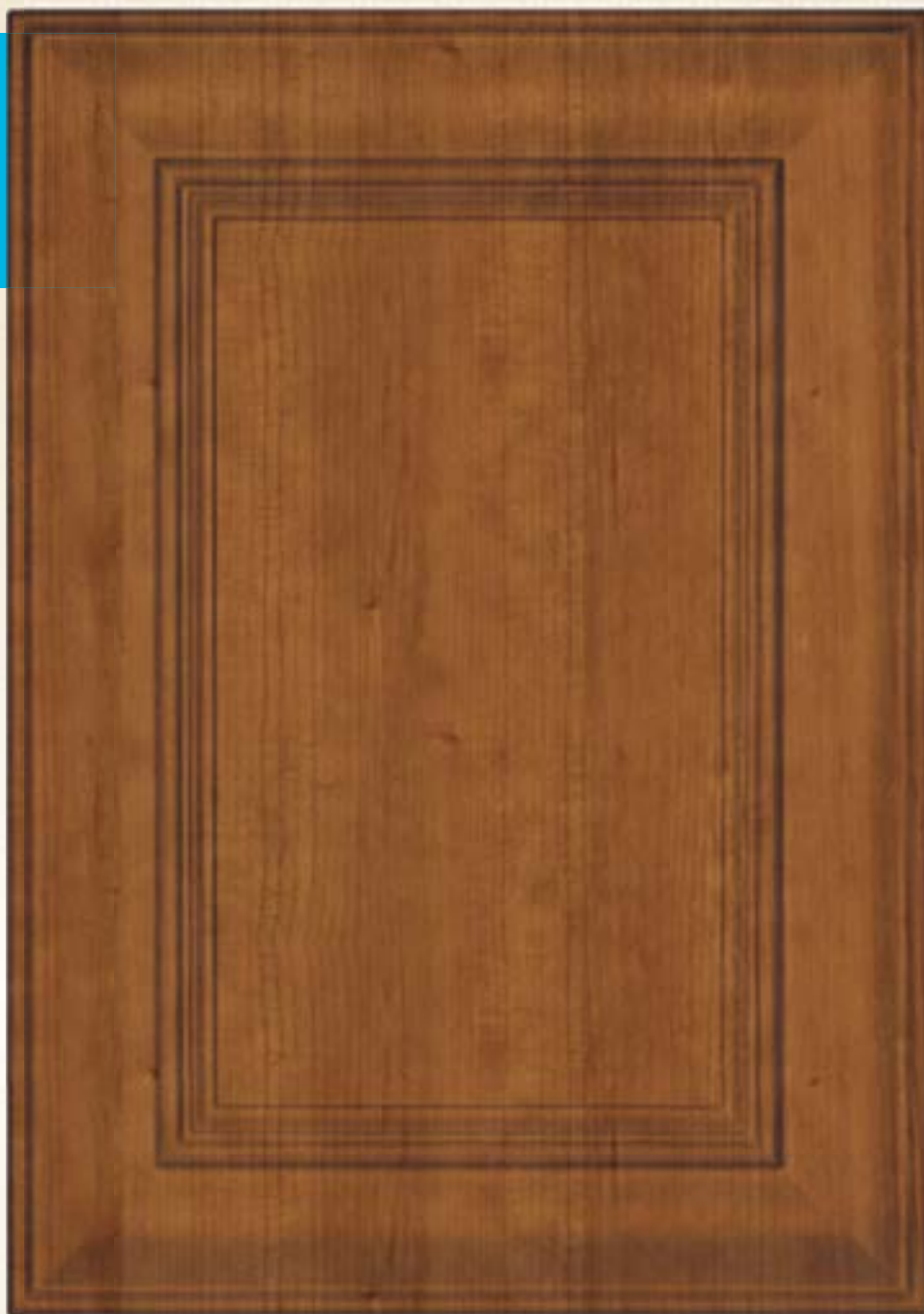
Panneaux multiples
Multiple panels

8820

Porte
Door

■ Profil intérieur - *Inside profile*



■ Profils extérieurs - *Edge profiles*

A	B	C	D	E	F	G	H	I	J	K	M	N	P	Q	T
---	---	---	---	---	---	---	---	---	---	---	---	---	---	---	----------

■ Panneaux d'appareils électroménagers - *Appliance panels*

B-2	C-2	D-2	F-2	G-2	H-2	I-2	J-2	K-2	P-2	Q-2	T-2
-----	-----	-----	-----	-----	-----	-----	-----	-----	-----	-----	------------

■ Options - *Options*

LG	VG	VL	DVL	GRIFFE FINGER PULL
		8830	8840	

■ Disponible pour ce modèle - *Available for this model*

Spécial
Special

SHAKER

8830

8830

Porte
Door



Profil intérieur - Inside profile

Profils extérieurs - Edge profiles

A	B	C	D	E	F	G	H	I	J	K	M	N	P	Q	T
---	---	---	---	---	---	---	---	---	---	---	---	---	---	---	----------

Panneaux d'appareils électroménagers - Appliance panels

B-2	C-2	D-2	F-2	G-2	H-2	I-2	J-2	K-2	P-2	Q-2	T-2
-----	-----	-----	-----	-----	-----	-----	-----	-----	-----	-----	------------

Options - Options

LG	VG	VL	DVL	GRIFFE FINGER PULL
		8830	8840	

Disponible pour ce modèle - Available for this model

8830

Panneaux multiples
Multiple panels



8830

Façade-tiroir
Drawer-facade

8840



8840

Façade-tiroir
Drawer-facade



8840

Panneaux multiples
Multiple panels

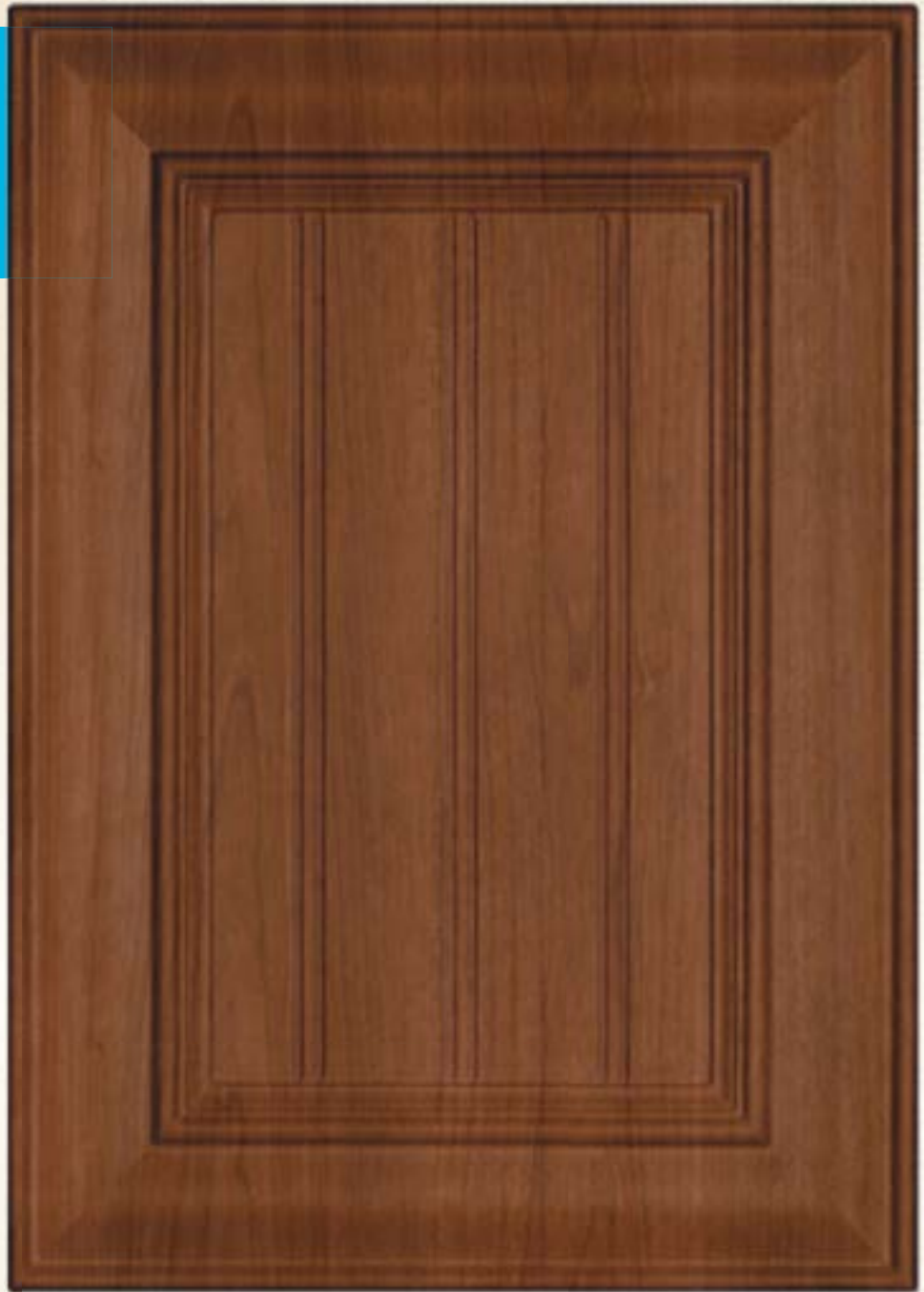

8840

Porte
Door

Profil intérieur - Inside profile



Profils extérieurs - Edge profiles

A	B	C	D	E	F	G	H	I	J	K	M	N	P	Q	T
---	---	---	---	---	---	---	---	---	---	---	---	---	---	---	---

Panneaux d'appareils électroménagers - Appliance panels

B-2	C-2	D-2	F-2	G-2	H-2	I-2	J-2	K-2	P-2	Q-2	T-2
-----	-----	-----	-----	-----	-----	-----	-----	-----	-----	-----	-----

Options - Options

LG	VG	VL	DVL	FINGER PULL
		8830	8840	

Disponible pour ce modèle - Available for this model

Spécial
Special

SHAKER

8850

8850

Porte
Door

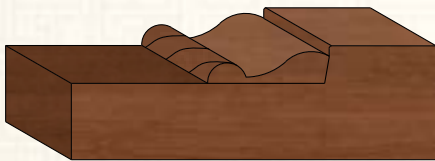

Profil intérieur - *Inside profile*

Profils extérieurs - *Edge profiles*

A B C D E F G H I J K M N P Q T

Panneaux d'appareils électroménagers - *Appliance panels*

B-2 C-2 D-2 F-2 G-2 H-2 I-2 J-2 K-2 P-2 Q-2 T-2

Options - *Options*

LG VG VL DVL GRIFFE
FINGER PULL

Disponible pour ce modèle - *Available for this model*

8850

Panneaux multiples
Multiple panels



8850

Façade-tiroir
Drawer-facade

SHAKER

Spécial
Special

8860



8860

Façade-tiroir
Drawer-facade

8860

Panneaux multiples
Multiple panels

8860

Porte
Door

■ Profil intérieur - *Inside profile*



■ Profils extérieurs - *Edge profiles*

A	B	C	D	E	F	G	H	I	J	K	M	N	P	Q	T
---	---	---	---	---	---	---	---	---	---	---	---	---	---	---	---

■ Panneaux d'appareils électroménagers - *Appliance panels*

B-2	C-2	D-2	F-2	G-2	H-2	I-2	J-2	K-2	P-2	Q-2	T-2
-----	-----	-----	-----	-----	-----	-----	-----	-----	-----	-----	-----

■ Options - *Options*

LG	VG	VL	DVL	GRIFFE FINGER PULL
----	----	----	-----	-----------------------

■ Disponible pour ce modèle - *Available for this model*

Spécial
Special

8870

8870

Porte
Door

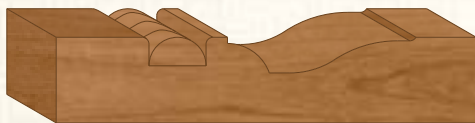

Profil intérieur - *Inside profile*

Profils extérieurs - *Edge profiles*

A B C D E F G H I J K M N P Q T

Panneaux d'appareils électroménagers - *Appliance panels*

B-2 C-2 D-2 F-2 G-2 H-2 I-2 J-2 K-2 P-2 Q-2 T-2

Options - *Options*

LG VG VL DVL GRIFFE
FINGER PULL

Disponible pour ce modèle - *Available for this model*

8870

Panneaux multiples
Multiple panels



8870

Façade-tiroir
Drawer-facade



8980

Façade-tiroir
Drawer-facade

8980

Panneaux multiples
Multiple panels

8980

Porte
Door

■ Profil intérieur - *Inside profile*



■ Profils extérieurs - *Edge profiles*

A	B	C	D	E	F	G	H	I	J	K	M	N	P	Q	T
---	---	---	---	---	---	---	---	---	---	---	---	---	---	---	---

■ Panneaux d'appareils électroménagers - *Appliance panels*

B-2	C-2	D-2	F-2	G-2	H-2	I-2	J-2	K-2	P-2	Q-2	T-2
-----	-----	-----	-----	-----	-----	-----	-----	-----	-----	-----	-----

■ Options - *Options*

LG	VG	VL	DVL	GRIFFE FINGER PULL
----	----	----	-----	-----------------------

■ Disponible pour ce modèle - *Available for this model*



Acces-
soires
-series

THERMOFORM

Mouleurs 45° - 120"

45° mouldings - 120"

2431

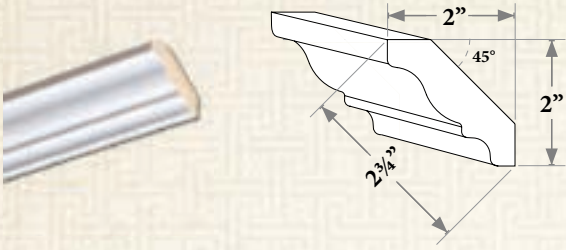

2432

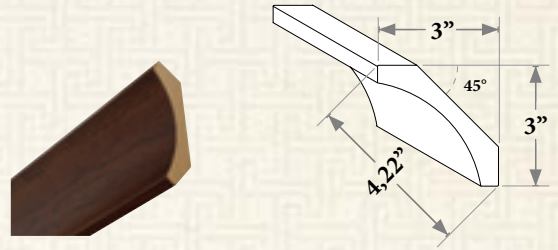

2441

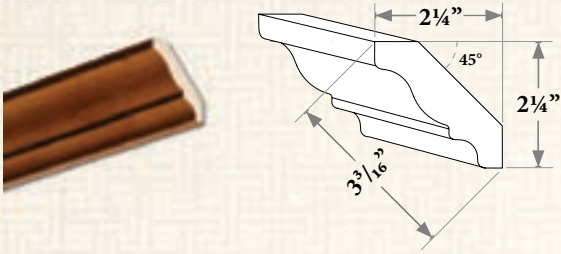

2442

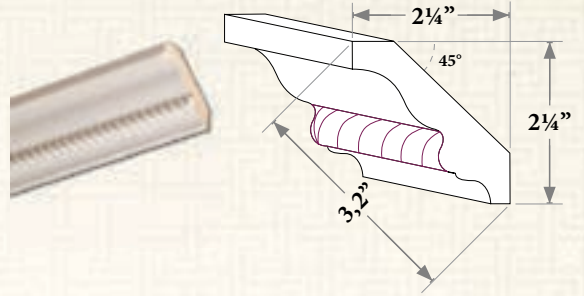

2443

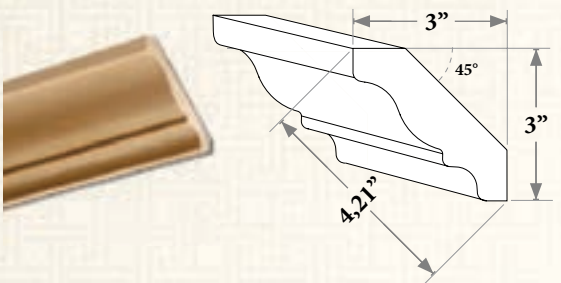

2444

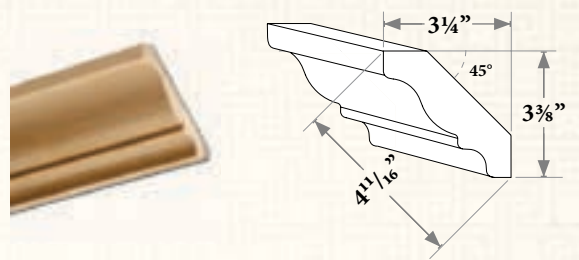

2445

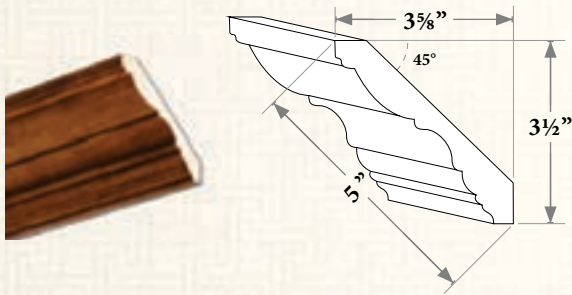

2447

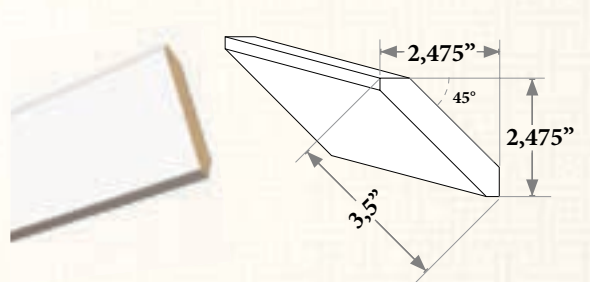

Mouleurs de tête - 120"

Head mouldings - 120"

2401

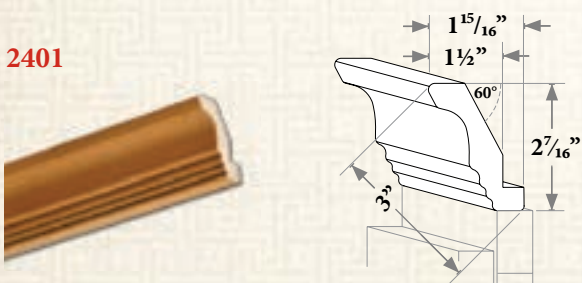

2405

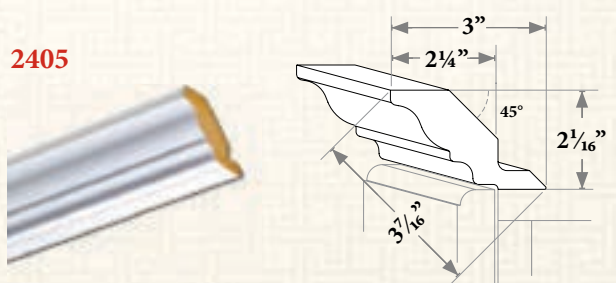

2411

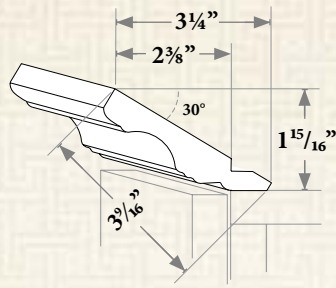

2421

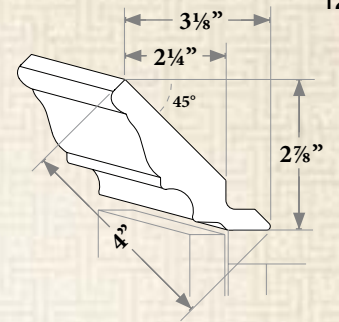

2422

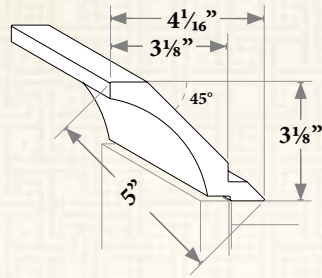

2428

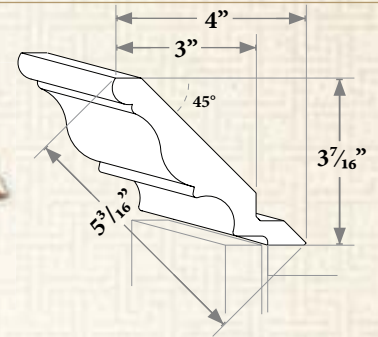

2446

Moulure coloniale de 5" sans insertion.
 Conçue pour recevoir carreau 2505 ou
 torsade 2626, voir 2448 et 2450.
 5" colonial moulding without
 insertion. Made to receive square
 2505 or rope 2626, refer to 2448
 and 2450.

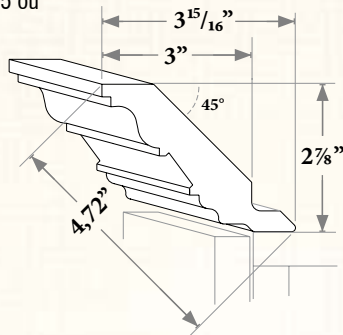

2448

Moulure coloniale de 5" combinée avec
 la torsade 2626 représentée en rose.
 5" colonial moulding combined
 with rope 2626 shown in pink.

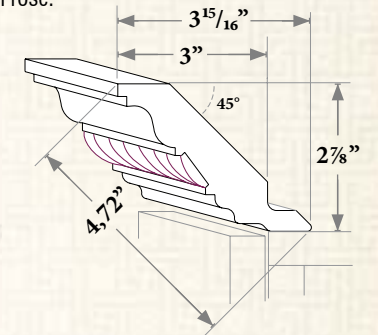

2450

Moulure coloniale de 5" combinée
 avec carreau 2505, représentée
 en rose.
 5" colonial moulding combined
 with square 2505, shown in pink.

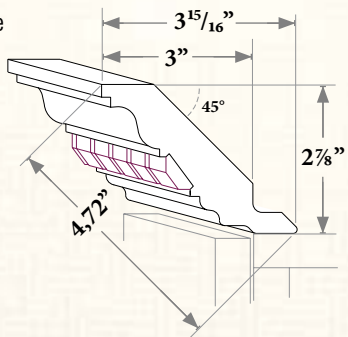

2453

Moulure coloniale de 6" sans insertion.
 6" colonial moulding without insertion.

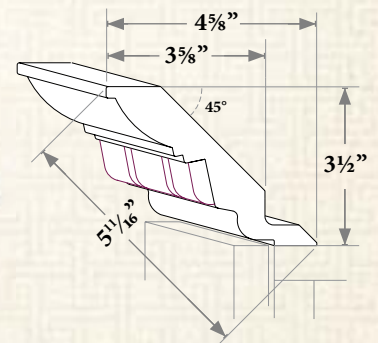

2465

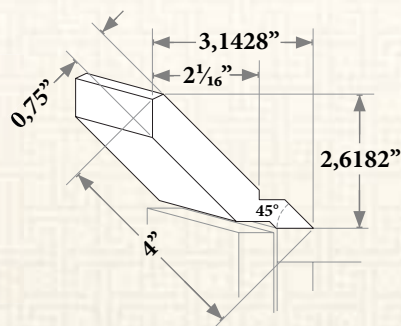

2456

Moulure coloniale de 6" combinée avec dentelle 2501, représentée en rose.
 6" colonial moulding combined with dentil 2501, shown in pink.

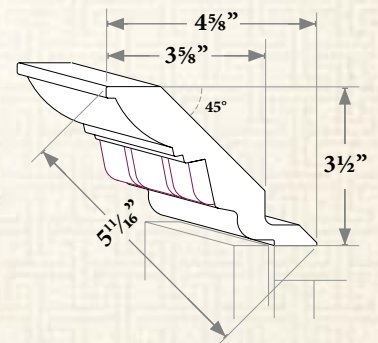

Mouleurs diverses

Miscellaneous mouldings

2480

Plinthe
Baseboard
5 1/4" x 3/4" x 120"

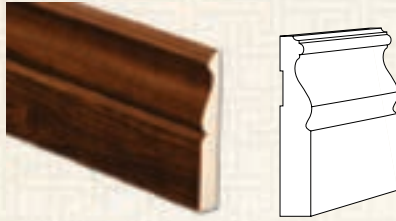

2481

Cadrage
Door frame
2 1/2" x 3/4" x 120"

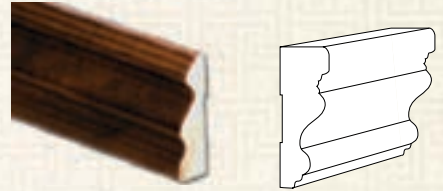

2483

Cadrage
Door frame
3 1/8" x 3/4" x 120"

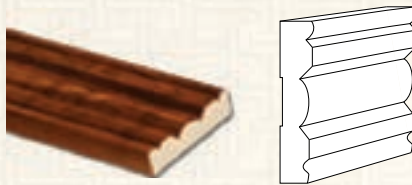

2485

Cimaise
Chair rail
2 1/2" x 1" x 120"

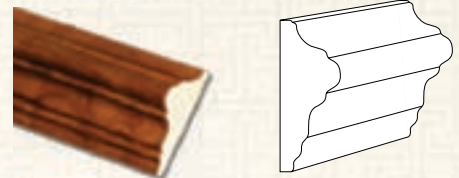

2486

Décorative
Decorative
1 11/16" x 0,70" x 120"

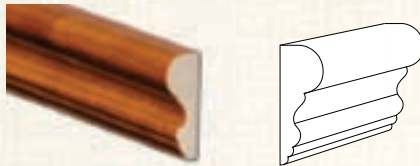

2487

Cimaise
Chair rail
1 1/2" x 1 1/2" x 120"

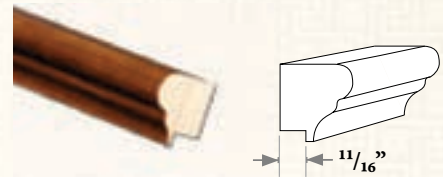

2491

Décorative
Decorative
1" x 1 1/2" x 120"



2493

Moustiquaire
Screen moulding
3/4" x 0,33" x 96"



Mouleurs de finition - 96"

Trim mouldings - 96"

2471

Gorge
Cove

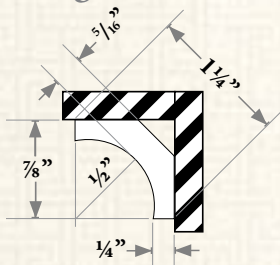

2473

Coin 90°
Corner

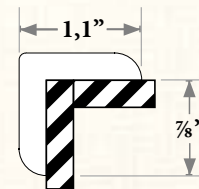

2474

Arrêt de porte
Scribe

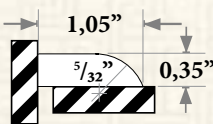

2476

Quart de rond
Quarter round

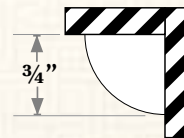

2478

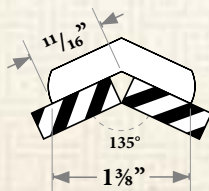

2479

Couvre-joint
Batten

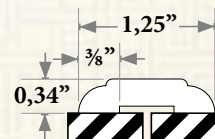

Bull-Nose – 120”

Bull-Nose – 120”

2461

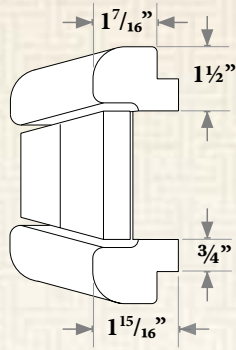

Mouluures dentelles et sculptées – 96”

Dentil and carved mouldings – 96”

2501

Dentelle
Dentil
3/8" x 1"

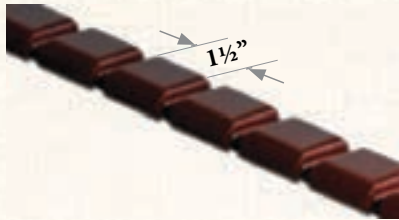

2505

Carreau
Square
1/4" x 0,9"



2510

Feuille
Leaf
7/32" x 1"



2515

Torsadée
Roped moulding
7/32" x 1"



2626

Torsade
Rope
1 1/16" x 5/16"



Cache-luminaire mouluré – 3" X 108"

Moulded valance – 3" X 108"

2835

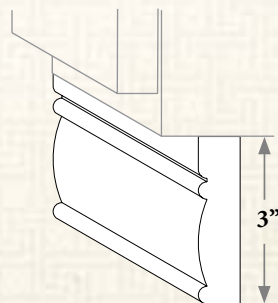

Cache-luminaires – 3" X 108". Disponible dans tous les profils extérieurs.

Light valances – 3" X 108". Available in all edge profiles.

2801

Profil extérieur A
Edge profile A

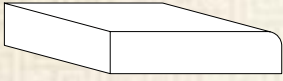

2817

Profil extérieur I
Edge profile I

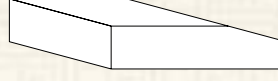

2803

Profil extérieur B
Edge profile B

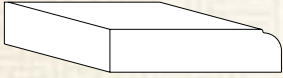

2819

Profil extérieur J
Edge profile J



2805

Profil extérieur C
Edge profile C

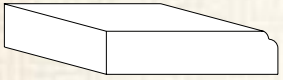

2821

Profil extérieur K
Edge profile K

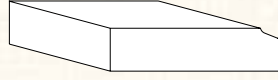

2807

Profil extérieur D
Edge profile D

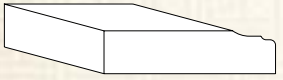

2825

Profil extérieur M
Edge profile M

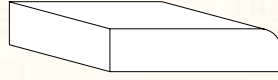

2809

Profil extérieur E
Edge profile E

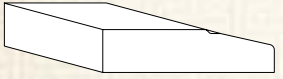

2827

Profil extérieur N
Edge profile N

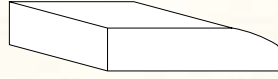

2811

Profil extérieur F
Edge profile F



2829

Profil extérieur P
Edge profile P

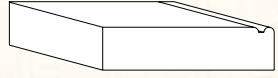

2813

Profil extérieur G
Edge profile G



2831

Profil extérieur Q
Edge profile Q

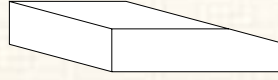

2815

Profil extérieur H
Edge profile H

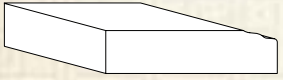

2833

Profil extérieur T
Edge profile T

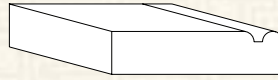

Pilastres flûtés – Sur mesure. Hauteur maximale 108”

Fluted fillers – Custom made. Maximum height 108”

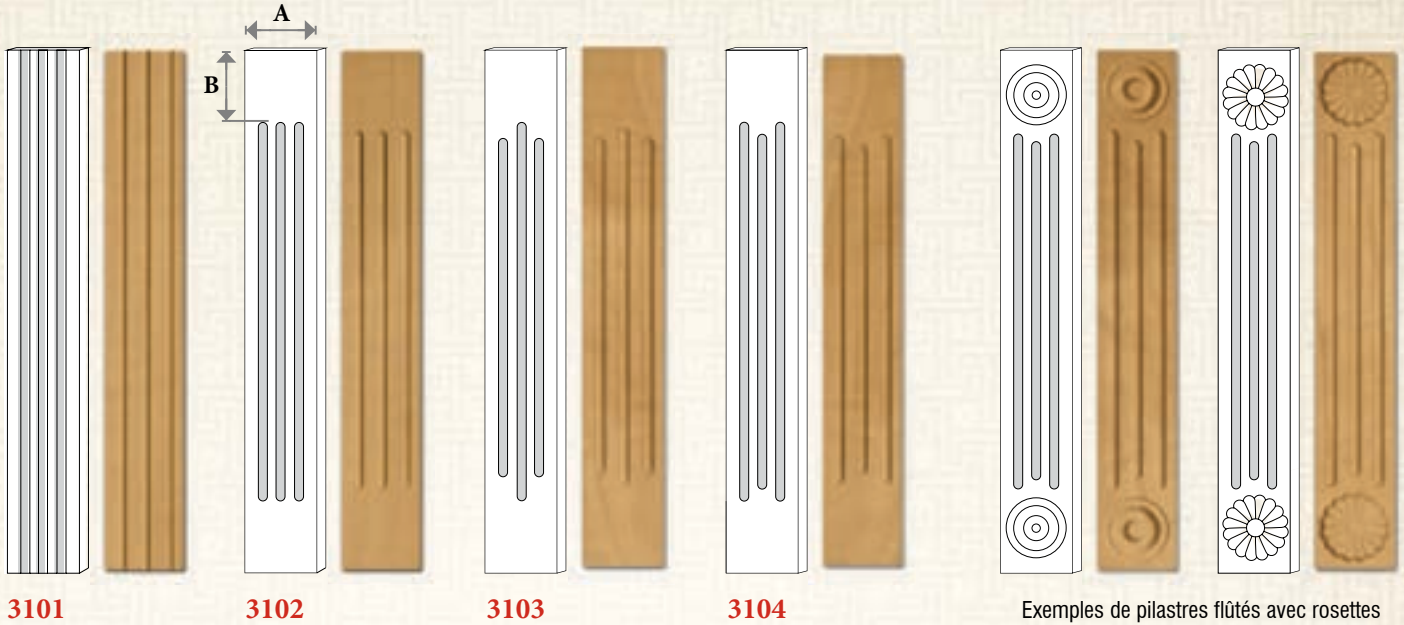

3101

3102

3103

3104

Exemples de pilastres flûtés avec rosettes machinées et avec arabesques.

Examples of fluted fillers with rosettes and with appliqués.

Frais additionnel si les mesures **A** et **B** sont différentes. /
Additional charge if **A** and **B** measurement are différent.

Rosettes

Rosettes

Rosettes carrées 7/8” – *Square rosettes 7/8”*



3131

7/8” x 3” x 3”

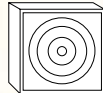

3132

7/8” x 3 1/2” x 3 1/2”

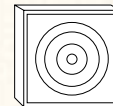

3133

7/8” x 4 1/4” x 4 1/4”

Rosettes machinées – *Routed rosettes*



RD111

2 3/8”



RD112

2 7/8”



RD113

3 1/4”

Rosettes appliquées – *Applied rosettes*



D105

1 1/2”



D110

2 1/2”

Pour connaître toutes les possibilités, consultez les pages des Arabesques.

To find out all possibilities, refer to Appliqués pages.

Socles et colonnes décoratives

Base blocks and decorative columns

3137

Colonne décorative
Decorative column
1 3/8" x 96"

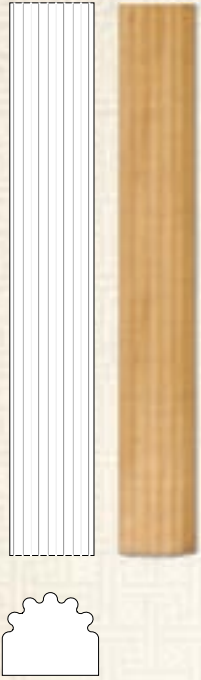

3136

Socle d'ajustement
Adjustment block
1 5/8" x 7 1/2"

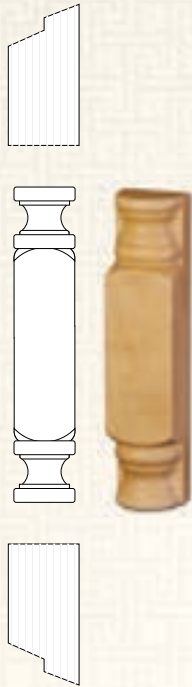

3135

Socle de base
Base block
1 5/8" x 6 7/8"

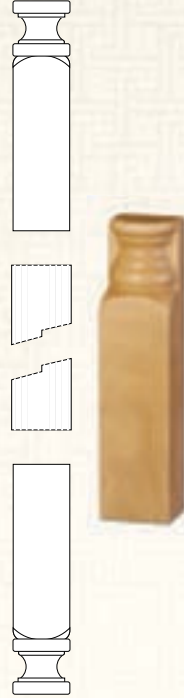

3134

Colonial
Socle de base
Base for filler & frame
7/8" x 3 1/2" x 8 3/4"

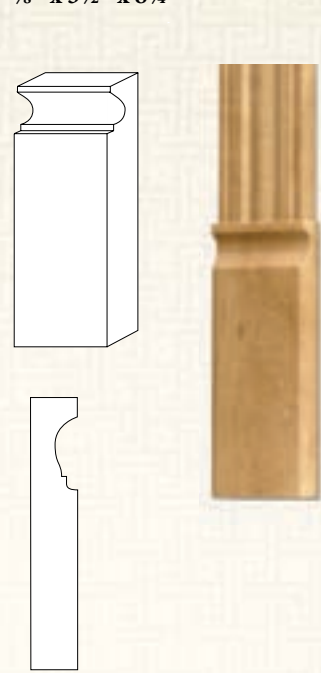

Supports

Brackets

4835

Gauche
Left

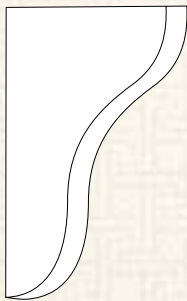

4836

Droite
Right

Support simple, sur mesure
Basic bracket, custom sizes
3/4"

4837

Gauche
Left

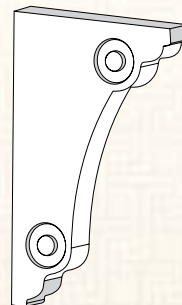

4838

Droite
Right

Support orné, sur mesure
Designer bracket, custom sizes
3/4"



Chapiteaux décoratifs

Decorative corbels



4831
Chapiteau décoratif
Decorative corbel
7" x 3" x 1 3/8"

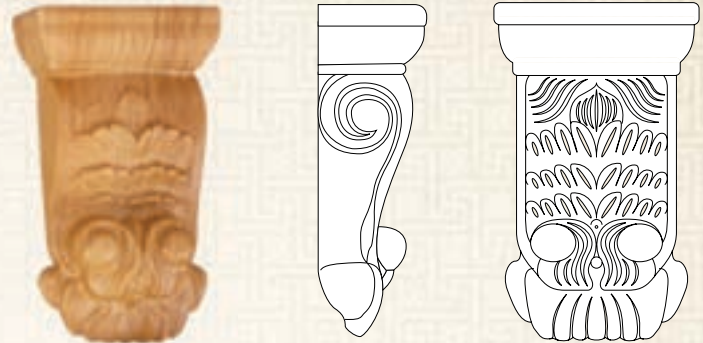

4833
Chapiteau décoratif
Decorative corbel
6" x 3 3/8" x 1 1/2"

Cantonnières – Sur mesure

Valances – Custom made

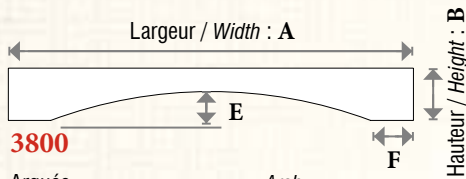

3800

Arquée

Arch



3801

Cathédrale

Cathedral



3802

Coloniale

Colonial



3809

Arquée double

Arch Double



3810

Cathédrale ondulée

Cathedral Wave



3811

Coloniale double

Colonial Double



4800 Minimum A = 15" Minimum B = 6"

Poisson

Fish



4820 Minimum A = 6" Minimum B = 6"

Losange

Diamonds

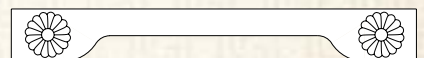

Exemple de cantonnière avec arabesques :
Example of valance with appliqués:



Possibilité d'ajouter des arabesques, des rosettes appliquées ou machinées sur les cantonnières.

Add appliqués, routed or applied rosettes on your valances.

Arabesques

Appliqués



D105

1 ½"



D110

2 ½"



D115

2 ¾" x 1 ¾"



D120

3 ⅝" x 1 ⅞"



D125

4 ¼" x 2 ¼"



D130

3" x 2 ⅛"



D135

3 ½" x 2"



D140

3 ⅝" x 1 ⅞"



D145

4 ⅞" x 3"



D150

2" x 2"



D155

3 ¼" x 3 ¼"



D160

5 ⅞" x 4 ⅞"



D165

9 ¾" x 1 ⅜"



D175

1 ⅜" x 5 ¼"



D185

6" x 2 ½"



D170

9 ¾" x 2 ⅛"



D180

1 ¾" x 14 ⅛"



D190
5 5/8" x 2 7/8"



D195
9" x 2 1/2"



D200
10 1/2" x 2 5/8"



D205
10 5/8" x 3 1/2"



D210
11 5/8" x 2 3/8"



D215
12" x 2 1/4"



D220
14 1/8" x 4 3/8"



D225
16 11/16" x 3 7/16"



D230
17 7/8" x 3 1/2"



D235
18 7/8" x 5 1/4"



D240
5 3/8" x 1 3/4"



D245
5 1/8" x 2 1/8"



D250
10 1/4" x 2"



D275
3 1/2" x 3 1/2"



D295
2 3/4" x 3"



D280
1 3/4" x 5 5/16"



D810
3 3/4" x 3 3/4" x 7/32"



D285
6" x 6"



D290
5 1/2" x 5 1/2"



D815
41" x 1 3/4"



Porte à angles – Trois angles possibles : 30°, 45° et 90°

Angle doors – Three possible angles: 30°, 45° and 90°

Les portes à angles de Thermoform ont un joint solide, invisible et étanche. Seul le MDF est coupé, alors que le PVC reste intact. Vous pouvez combiner profil intérieur, profil extérieur et fini de votre choix.

Thermoform angle doors have a strong, invisible and waterproof seam. Only the MDF is cut out, while the PVC remains intact. Freely combine inside and edge profiles and finish of your choice.

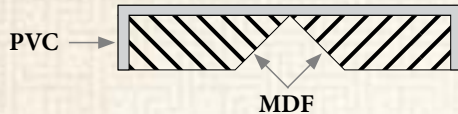

Porte à deux angles – 45°

Two angle doors – 45°

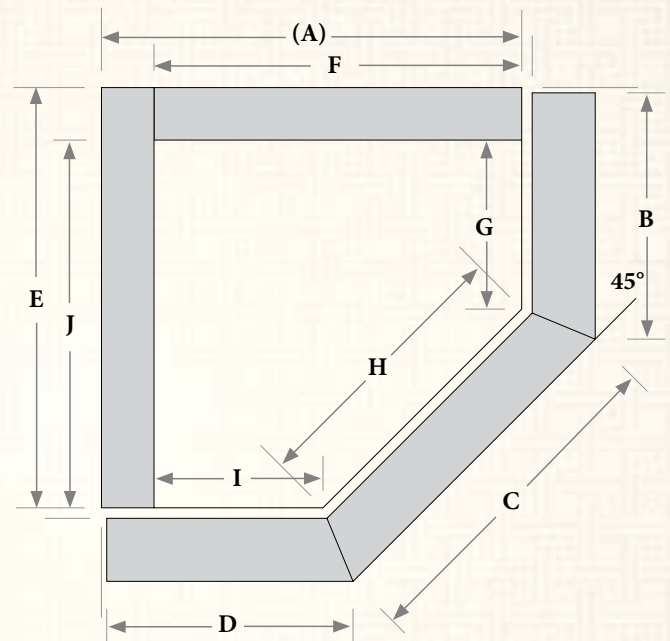

A = grandeur standard du caisson A = standard cabinet size

A	4"	5"	6"	7"	8"	9"	10"	11"	12"	12.25"	18"
B	2.579"	3.069"	3.559"	4.049"	4.540"	5.030"	5.520"	6.010"	6.500"	6.622"	9.441"
C	3.159"	3.880"	4.601"	5.322"	6.043"	6.764"	7.485"	8.206"	8.927"	9.108"	13.254"
D	2.579"	3.069"	3.559"	4.049"	4.540"	5.030"	5.520"	6.010"	6.500"	6.622"	9.441"
E	4"	5"	6"	7"	8"	9"	10"	11"	12"	12.25"	18"
F	3.375"	4.375"	5.375"	6.375"	7.375"	8.375"	9.375"	10.375"	11.375"	11.625"	17.375"
G	1.654"	2.144"	2.364"	3.124"	3.615"	4.105"	4.595"	5.085"	6.200"	5.698"	8.516"
H	2.434"	3.155"	3.876"	4.597"	5.318"	6.039"	6.760"	7.481"	8.202"	8.383"	12.529"
I	1.654"	2.144"	2.364"	3.124"	3.615"	4.105"	4.595"	5.085"	6.200"	5.698"	8.516"
J	3.375"	4.375"	5.375"	6.375"	7.375"	8.375"	9.375"	10.375"	11.375"	11.625"	17.375"
B+C+D	8.22"	9.94"	11.15"	13.37"	15.07"	16.79"	18.51"	20.21"	21.93"	22.36"	32.36"

Porte à trois angles – 30°

Three angle doors – 30°

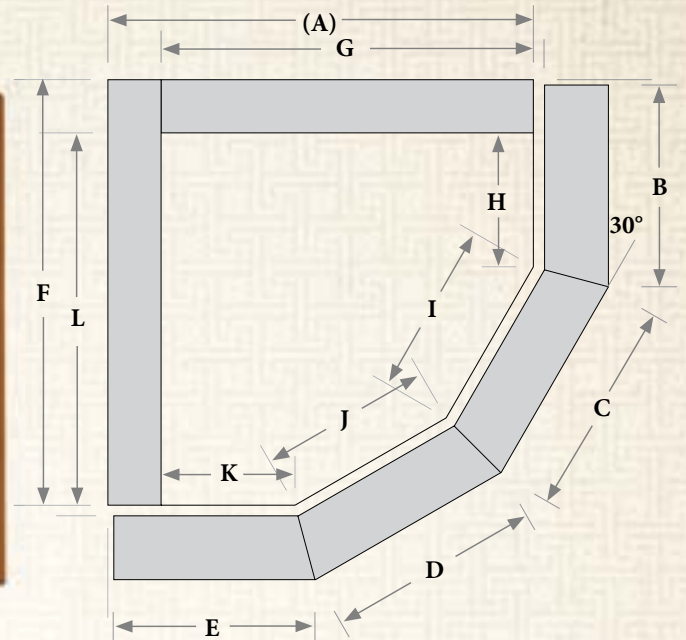

A = grandeur standard du caisson A = standard cabinet size									
A	5"	6"	7"	8"	9"	10"	11"	12"	12.125"
B	2.371"	2.785"	3.199"	3.614"	4.028"	4.442"	4.856"	5.270"	5.322"
C	2.519"	2.948"	3.377"	3.806"	4.235"	4.663"	5.092"	5.521"	5.575"
D	2.519"	2.948"	3.377"	3.806"	4.235"	4.663"	5.092"	5.521"	5.575"
E	2.371"	2.785"	3.199"	3.614"	4.028"	4.442"	4.856"	5.270"	5.322"
F	5"	6"	7"	8"	9"	10"	11"	12"	12.125"
G	4.375"	5.375"	6.375"	7.375"	8.375"	9.375"	10.375"	11.375"	11.500"
H	1.574"	1.988"	2.402"	2.817"	3.231"	3.645"	4.059"	4.474"	4.525"
I	2.050"	2.479"	2.908"	3.337"	3.766"	4.195"	4.623"	5.052"	5.106"
J	2.050"	2.479"	2.908"	3.337"	3.766"	4.195"	4.623"	5.052"	5.106"
K	1.574"	1.988"	2.402"	2.817"	3.231"	3.645"	4.059"	4.474"	4.525"
L	4.375"	5.375"	6.375"	7.375"	8.375"	9.375"	10.375"	11.375"	11.500"
B+C+D+E	9.78"	11.47"	13.15"	14.84"	16.53"	18.21"	19.90"	21.58"	21.87"

Dimensions spéciales sur commande. *Special size to order.*

Non disponible en MDF seulement. *Not available in MDF only.*

Porte à un ou deux angles – Trois angles possibles : 30°, 45° et 90°

One or two angle doors – Three possible angles: 30°, 45° and 90°



Coins à rayon de 3 pouces

3 inch radius corners

Flûté ou uni, dimensions sur mesure disponibles.

Fluted or plain, custom sizes available.

Mur à construction simple Single wall construction

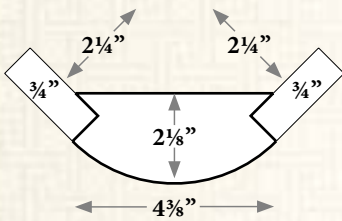
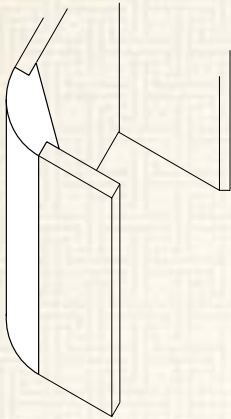

Mur à construction double Double wall construction

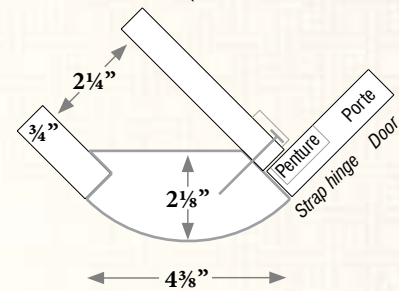
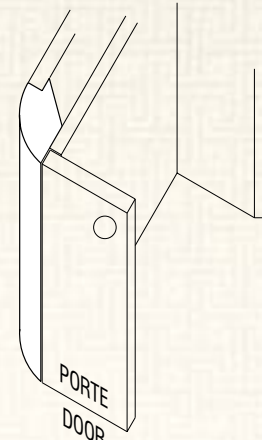

3501
Uni - Plain
96"

3503
Uni - Plain
31 1/2"

3505
Uni - Plain
96"

3506
Uni - Plain
31 1/2"

3502
Flûté - Fluted
96"

3504
Flûté - Fluted
31 1/2"

3507
Flûté - Fluted
96"

3508
Flûté - Fluted
31 1/2"



Mouleurs pour coins à rayon de 3 pouces

3 inch radius corner mouldings

Ces mouleurs peuvent être combinées à la moulure standard #2405 (voir page 125)

May be combined with standard moulding #2405 (see page 125).

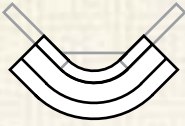

3535

Extérieur
Outside



3545

Intérieur
Inside

Tablettes de coin

Corner shelves



3956

Droite
Right



3950

Gauche
Left



3958

Droite
Right



3952

Gauche
Left

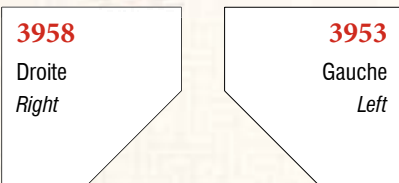

3953

Gauche
Left

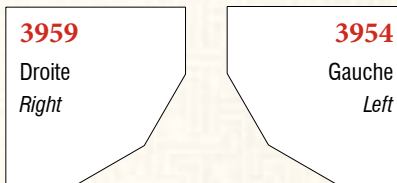

3959

Droite
Right

3954

Gauche
Left



Casiers à bouteilles - Diamètre de 4"

Wine racks - 4" diameter

MINIMUMS

A = 3" B = 5" 1/2 C = 7" 3/8 D = 10" 1/4
 E = 12" 5/8 F = 13" 3/4 G = 14" 1/4

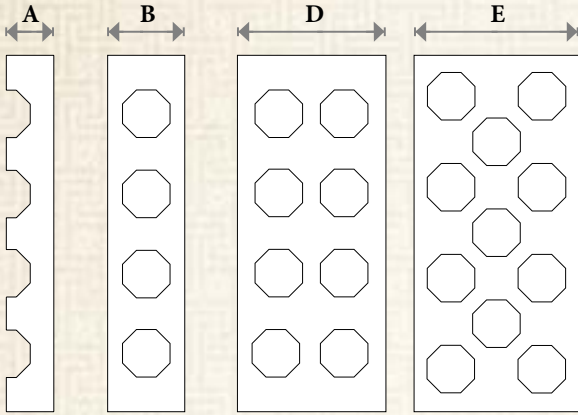

3701 **3702** **3702** **3703**
 Octogone Octogone Octogone Octogone
 Octagon Octagon Octagon Octagon

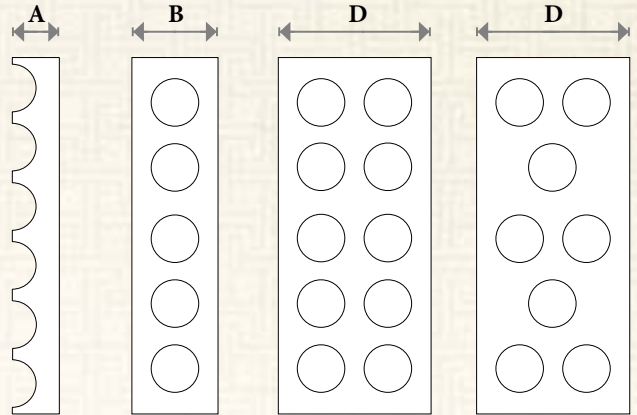

3711 **3712** **3712** **3713**
 Cercle Cercle Cercle Cercle
 Circle Circle Circle Circle

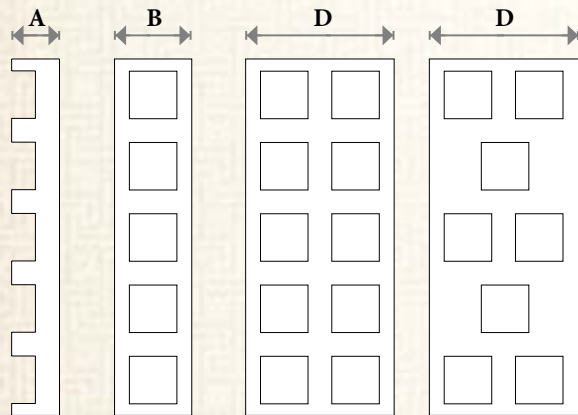

3721 **3722** **3722** **3723**
 Carré Carré Carré Carré
 Square Square Square Square

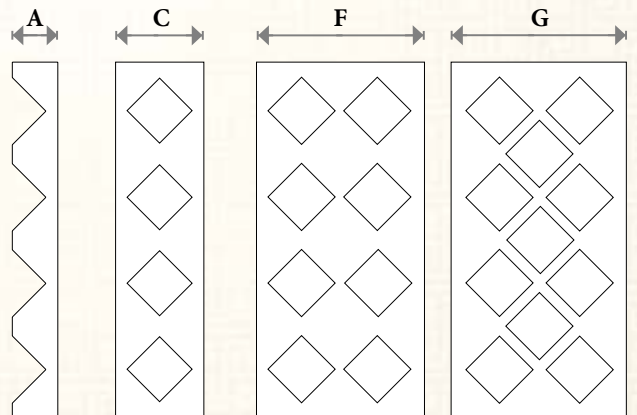

3731 **3732** **3732** **3733**
 Losange Losange Losange Losange
 Diamond Diamond Diamond Diamond



Colonnes

Note : non disponible en MDF seulement.
 Note: not available in MDF only.

Columns

Sans joint apparent en surface. Les profils intérieurs de nos portes peuvent être reproduits dans les colonnes, si les dimensions le permettent. Des flûtes également peuvent être choisies comme motifs, et même des arabesques montées en appliqué.

Seamless on the surface. Inside profiles may be reproduced on columns if sizes allow. Flutes may also be chosen as patterns, even appliqués may be set.

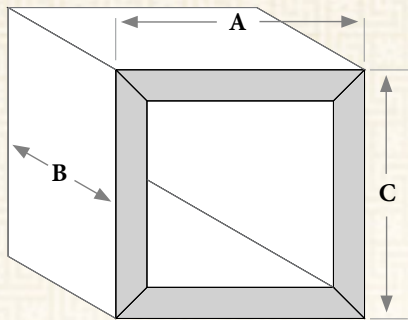

4900
 Colonne
 Column

Carré
 Square
 A = Largeurs disponibles
 Available sizes
 2 1/2" - 3" - 4" - 5" - 6" - 7" - 8"
 B = Hauteur (max.108")
 Height (max. 108")
 C = Longueur
 Length

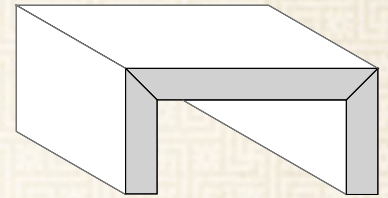

4901
 Demi-colonne
 Half column

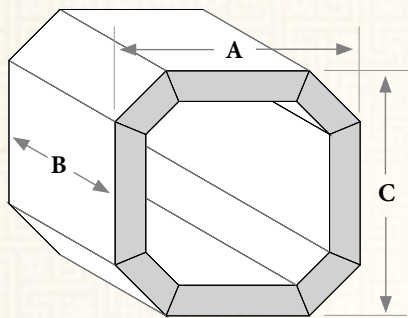

4910
 Colonne
 Column

Octogone irrégulier
 Irregular Octagon
 A = Largeurs disponibles
 Available sizes
 3" - 4" - 5" - 6" - 7" - 8" - 9" - 10"
 B = Hauteur (max.108")
 Height (max. 108")
 C = Longueur
 Length

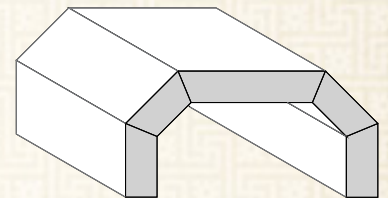

4911
 Demi-colonne
 Half column

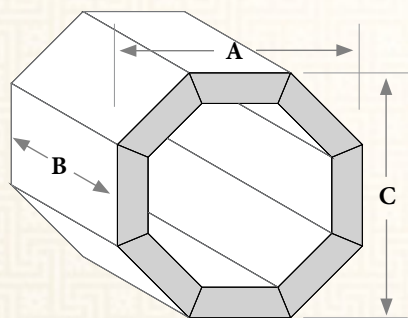

4920
 Colonne
 Column

Octogone
 Octagon
 A = Largeurs disponibles
 Available sizes
 3" - 4" - 5" - 6" - 7" - 8" - 9" - 10"
 B = Hauteur (max.108")
 Height (max. 108")
 C = Longueur
 Length

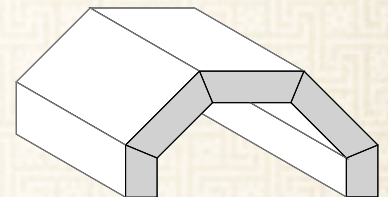

4921
 Demi-colonne
 Half column

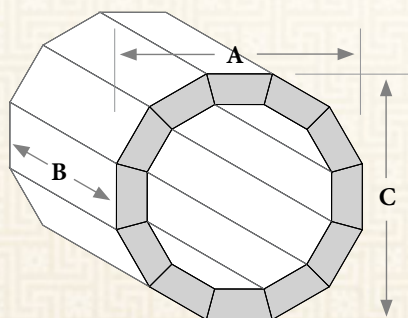

4930
 Colonne
 Column

Dodécagone
 Dodecagon
 A = Largeurs disponibles
 Available sizes
 3" - 4" - 5" - 6" - 7" - 8" - 9" - 10"
 B = Hauteur (max.108")
 Height (max. 108")
 C = Longueur
 Length

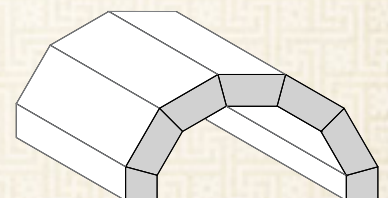

4931
 Demi-colonne
 Half column

Feuilles polymères, Thermolam et Polylam

Polymer sheets, Thermolam and Polylam

Disponible dans toutes nos couleurs.

Available in all our colors.

Feuilles polymères

Largeur moyenne de 51", longueur sur mesure (minimum 24").

Polymer sheets

51" average width, length as requested (24" minimum).

2921

Feuilles polymères préencollées

Polymer pre-glued sheets

2925

48" x 96"

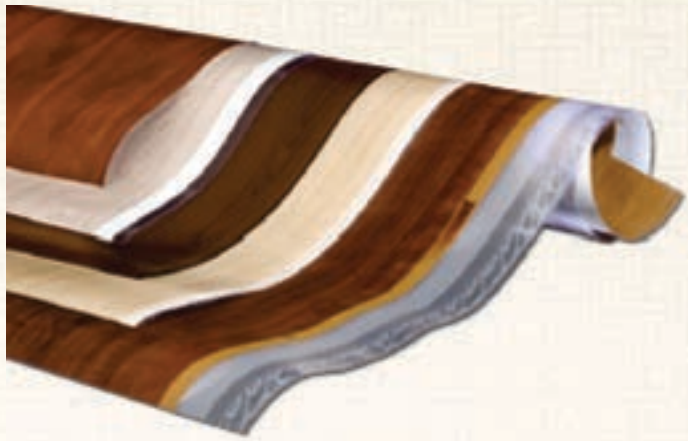

Thermolam

Feuilles polymères avec endos phénolique.

Épaisseur de 1/32".

Thermolam

Polymer sheets on phenolic backing.

Thickness 1/32".

2931

48" x 96"

2932

48" x 120"



Polylam

Feuilles polymères avec endos polymère.

Épaisseur de 1/32".

Polylam

Polymer sheets on polymer backing.

Thickness 1/32".

2935

48" x 108"

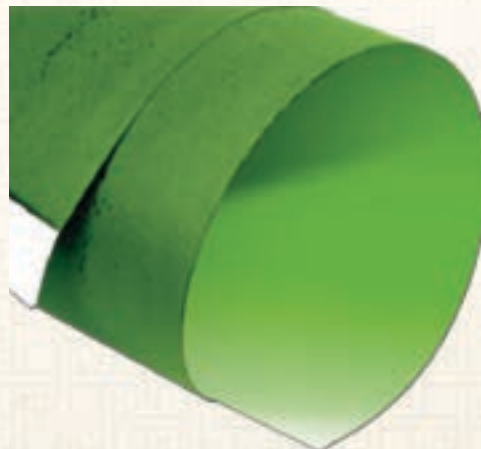

Panneaux de particules et de MDF

Particle and MDF boards

3901

Panneaux de particules
Polymère/Dos mélamine blanc
Dimensions : 4' x 8'
Épaisseur : 5/8"

Particle boards

Polymer / White melamine backing
Size: 4' x 8' Thickness: 5/8"

3902

Panneaux de particules
Polymère/Polymère 2 côtés
Dimensions : 4' x 8'
Épaisseur : 5/8"

Particle boards

Polymer / Two-face Polymer
Size: 4' x 8' Thickness: 5/8"

3903

Panneaux de MDF
Polymère/Dos mélamine blanc
Dimensions : 4' x 8'
Épaisseur : 3/4"

MDF boards

Polymer / White melamine backing
Size: 4' x 8' Thickness: 3/4"

3904

Panneaux de MDF
Polymère/Dos mélamine de couleur
Dimensions : 4' x 8'
Épaisseur : 3/4"

MDF boards

Polymer / Color melamine backing
Size: 4' x 8' Thickness: 3/4"

3905

Panneaux de MDF
Polymère/Polymère 2 côtés
Dimensions : 4' x 8'
Épaisseur : 3/4"

MDF boards

Polymer / Two-face Polymer
Size: 4' x 8' Thickness: 3/4"

3906

Panneaux de MDF
Polymère/Dos mélamine blanc
Dimensions : 4' x 9'
Épaisseur : 3/4"

MDF boards

Polymer / White melamine backing
Size: 4' x 9' Thickness: 3/4"

3907

Panneaux de MDF
Polymère/Dos mélamine de couleur
Dimensions : 4' x 9'
Épaisseur : 3/4"

MDF boards

Polymer / Color melamine backing
Size: 4' x 9' Thickness: 3/4"

3933

Panneaux de particules
Polymère/Dos mélamine érable
Dimensions : 4' x 8'
Épaisseur : 5/8"

Particle boards

Polymer / Maple Melamine backing
Size: 4' x 8' Thickness: 5/8"

3941

Panneaux de particules
Polymère/Dos mélamine blanc
Dimensions : 4' x 9'
Épaisseur : 5/8"

Particle boards

Polymer / White melamine backing
Size: 4' x 9' Thickness: 5/8"

3908

Panneaux de MDF
Polymère/Polymère 2 côtés
Dimensions : 4' x 9'
Épaisseur : 3/4"

MDF boards

Polymer / Two-face Polymer
Size: 4' x 9' Thickness: 3/4"

3909

Panneaux de MDF
Polymère/Dos mélamine blanc
Dimensions : 4' x 8'
Épaisseur : 5/8"

MDF boards

Polymer / White melamine backing
Size: 4' x 8' Thickness: 5/8"

3912

Panneaux de MDF
Polymère/Dos mélamine blanc
Dimensions : 4' x 10'
Épaisseur : 5/8"

MDF boards

Polymer / White melamine backing
Size: 4' x 10' Thickness: 5/8"

3913

Panneaux de MDF
Polymère/Dos MDF brut
Dimensions : 4' x 8'
Épaisseur : 1/8"

MDF boards

Polymer / Raw MDF backing
Size: 4' x 8' Thickness: 1/8"

3914

Panneaux de MDF
Polymère/Dos MDF brut
Dimensions : 4' x 8'
Épaisseur : 1/4"

MDF boards

Polymer / Raw MDF backing
Size: 4' x 8' Thickness: 1/4"

3942

Panneaux de particules
Polymère/Polymère 2 côtés
Dimensions : 4' x 9'
Épaisseur : 5/8"

Particle boards

Polymer / Two-face Polymer
Size: 4' x 9' Thickness: 5/8"

3996

Panneaux de particules sans formaldéhyde
Polymère/Dos mélamine blanc
Dimensions : 4' x 8'
Épaisseur : 5/8"

Formaldehyde-Free Particle boards

Polymer / White melamine backing
Size: 4' x 8' Thickness: 5/8"

3915

Panneaux de MDF
Polymère/Polymère 2 côtés
Dimensions : 4' x 8'
Épaisseur : 1/4"

MDF boards

Polymer / Two-face Polymer
Size: 4' x 8' Thickness: 1/4"

3916

Panneaux de MDF
Polymère/Polymère 2 côtés
Dimensions : 4' x 8'
Épaisseur : 1/8"

MDF boards

Polymer / Two-face Polymer
Size: 4' x 8' Thickness: 1/8"

3925

Panneaux de MDF
Polymère/Polymère 2 côtés
Dimensions : 4' x 8'
Épaisseur : 5/8"

MDF boards

Polymer / Two-face Polymer
Size: 4' x 8' Thickness: 5/8"

3929

Panneaux de MDF
Polymère/Dos mélamine blanc
Dimensions : 4' x 9'
Épaisseur : 5/8"

MDF boards

Polymer / White melamine backing
Size: 4' x 9' Thickness: 5/8"

3935

Panneaux de MDF
Polymère/Polymère 2 côtés
Dimensions : 4' x 10'
Épaisseur : 5/8"

MDF boards

Polymer / Two-face Polymer
Size: 4' x 10' Thickness: 5/8"

3997

Panneaux de particules sans formaldéhyde
Polymère/Polymère 2 côtés
Dimensions : 4' x 8'
Épaisseur : 5/8"

Formaldehyde-Free Particle boards

Polymer / Two-face Polymer
Size: 4' x 8' Thickness: 5/8"

3939

Panneaux de MDF
Polymère/Polymère 2 côtés
Dimensions : 4' x 9'
Épaisseur : 5/8"

MDF boards

Polymer / Two-face Polymer
Size: 4' x 9' Thickness: 5/8"

3945

Panneaux de MDF
Polymère/Dos mélamine blanc
Dimensions : 4' x 10'
Épaisseur : 3/4"

MDF boards

Polymer / White melamine backing
Size: 4' x 10' Thickness: 3/4"

3946

Panneaux de MDF
Polymère/Polymère 2 côtés
Dimensions : 4' x 10'
Épaisseur : 3/4"

MDF boards

Polymer / Two-face Polymer
Size: 4' x 10' Thickness: 3/4"

3998

Panneaux de MDF
Polymère/Dos MDF
Dimensions : 4' x 8'
Épaisseur : 1"1/4

MDF boards

Polymer / MDF backing
Size: 4' x 8' Thickness: 1"1/4

3999

Panneaux de MDF
Polymère/Polymère 2 côtés
Dimensions : 4' x 8'
Épaisseur : 1"1/4

MDF boards

Polymer / Two-face Polymer
Size: 4' x 8' Thickness: 1"1/4

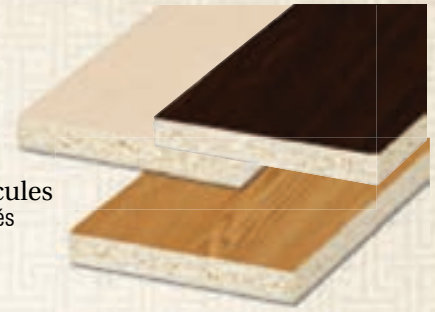

Abattants, déflecteurs de chaleur, bandes de chant

Tambours, heat deflectors, edge strips

Disponible dans toutes nos couleurs.

Available in all our colors.

2900

Abattants à lamelles

Sur mesure

Épaisseur $\frac{3}{16}$ "

Latte $\frac{1}{2}$ "

Latte de poignée $1\frac{1}{2}$ "

Decorative Tambours

Custom made

Thickness $\frac{3}{16}$ "

Board $\frac{1}{2}$ "

Board for handle $1\frac{1}{2}$ "



MDF : non disponible / *not available*

3922

Déflecteurs de chaleur stainless
Stainless heat deflectors

$\frac{1}{16}$ " x 2" x $30\frac{3}{16}$ "



3924

Protecteurs de chaleur en plastique
Plastic heat protectors

$\frac{5}{8}$ " x $29\frac{15}{16}$ "

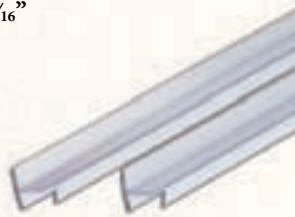

3940

Protecteurs pour cache luminaire
Heat shields for light valance

Coin : $\frac{1}{2}$ " x 96"

Corner : $\frac{1}{2}$ " x 96"

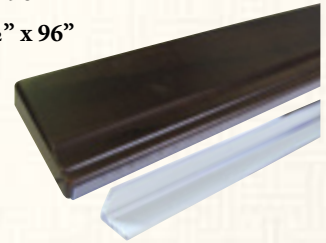

Pour utilisation avec de la colle contact ou du ruban à double face adhésive. / *For use with contact cement or double sided tape.*

4102

Bandes de chant polymères
Polymer edge strips

$\frac{7}{8}$ " x 150'

4112

Ruban à double face adhésive
Double Side Tape

1" x 180'



Pour application à la main. / *For hand application.*

4103

Bandes de chant polyester encollées
Preglued polyester edge strips

$\frac{3}{4}$ " x 250'

Pour utilisation avec une plaqueuse seulement. / *For use with an edger only.*

4105

Bandes de chant en PVC

PVC edge strips

$\frac{15}{16}$ " x 600'

Épaisseur /
Thickness: 0,5 mm

4117

Bandes de chant en PVC

PVC edge strips

$\frac{15}{16}$ " x 300'

Épaisseur /
Thickness: 0,5 mm

4118

Bandes de chant en PVC

PVC edge strips

$\frac{15}{16}$ " x 150'

Épaisseur /
Thickness: 0,5 mm

À utiliser avec une plaqueuse à colle chaude 380°F (195°C)
To be used with hot adhesive binder. 380°F (195°C)

Recommandations

Prévention contre dommages par la chaleur

Cuisinières, fours et appareils de cuisson de tous genres

Pour protéger les portes installées près d'appareils de cuisson tels que cuisinières et fours, y compris les appareils de ventilation avant et les fours encastrés, nous recommandons l'installation de déflecteurs en acier inoxydable disposés en parfait alignement avec les portes ou tiroirs. Le déflecteur sert d'écran de protection contre tout excès de chaleur lors de la cuisson, ainsi que contre toute chaleur radiante et à convection associée au mode de cuisson « broil » ou au dispositif autonettoyant dont plusieurs fours sont munis.

Petits appareils portatifs

Il faut agir avec précaution lorsqu'on se sert de grille-pain, de mini-fours ou de tous genres d'appareils de cuisson portatifs générant soit chaleur soit vapeur, afin d'éviter que portes ou tiroirs ne soient soumis à des chaleurs excessives.

Éclairage

Les sources d'éclairage puissantes devraient être installées à bonne distance de tous les produits polymères.

Note

Les produits soumis à des températures de plus de 85 °C (185 °F) sont exclus de la garantie.

Entretien

Ne jamais se servir d'un solvant ou d'un abrasif, mais d'un savon et d'un linge doux.

Recommendations

Heat damage prevention

Base Ovens, Cook Tops and appliances generating heat

To protect doors installed near kitchen appliances such as base ovens, including cook tops with front exhaust vents and wall mounted ovens, we recommend installation of stainless steel heat deflectors mounted flush with doors and drawer fronts. Deflectors provide a barrier to shield heat from baking and cooking, from radiant and convective heat associated with broiling or with the use of self-cleaning features many ovens are equipped with.

Counter top Appliances

Care must be taken when using toasters, toaster ovens or any portable grills and other heat or steam generating appliances to ensure that upper wall doors are not subjected to excessive temperatures.

Lighting

Intense lighting sources must be installed away from any polymer products.

Note

The Warranty does not cover products exposed to temperatures over 85 °C (185 °F).

Maintenance

Never use a solvent or any abrasive substance. Soft soap and cloth only.

Couleurs • Finis

Colors • Finishes

En raison du procédé d'impression, les couleurs illustrées peuvent différer.
Toujours vérifier avec les échantillons fournis.

Because of the printing process, colors shown may differ.
Always verify with samples provided.

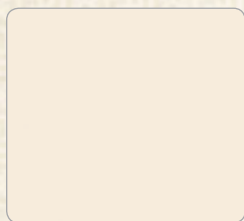

03
Blanc Antique Lustré
Antique White Gloss

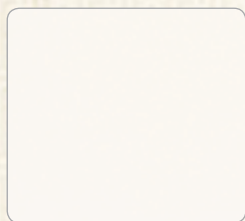

04
Blanc Lustré
White Gloss

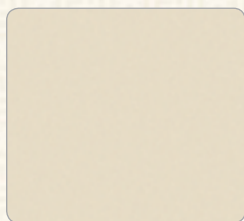

09
Amande
Almond

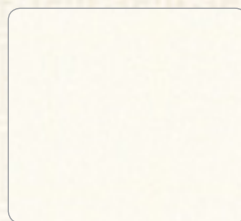

10
Blanc Cristal
White Crystal

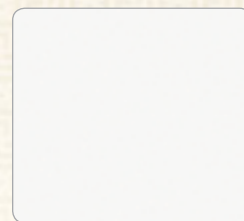

12
Blanc Neige Satiné
Snow White Silk

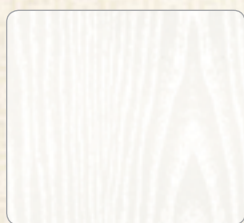

13
Blanc Frêne Arctique
Arctic White Ash

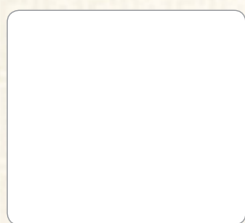

34
Blanc Lustré 949
White Gloss 949



38
Noir
Black



57
Flamme D'été
Summer Flame



58
Poirier Chocolat
Chocolate Pear

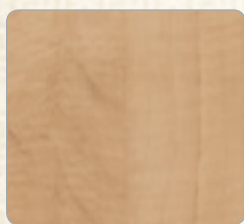

59
Secret
Secret

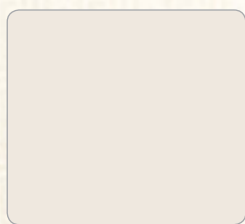

61
Blanc Antique Satiné
Antique White Silk

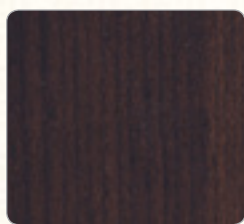

62
Érable Cayenne
Cayenne Maple



63
Érable Porto
Porto Maple

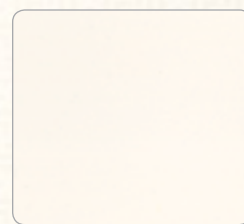

65
Blanc 949
949 White

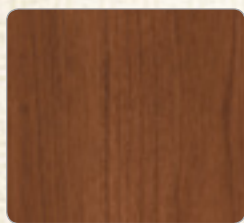

69
Cerisier Bourbon
Bourbon Cherry

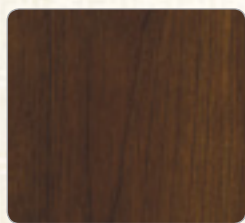

70
Cerisier Chocolat
Choco Cherry

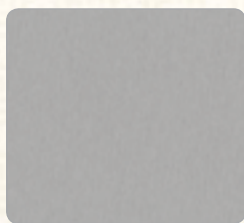

71
Stainless Brossé
Brushed Stainless



72
Cerisier Brun Rhum
Dark Rhum Cherry

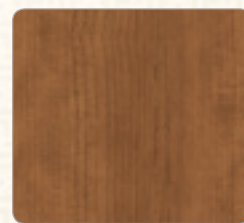

74
Cerisier Rustique
Rustic Cherry



77
Coquille D'oeuf
Eggshell White

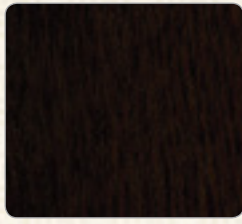

78
Wenge Italien
Italian Wenge



79
Cerisier Tabac
Tobacco Cherry



80
Rouge Lustré
Red Gloss



81
Noir Lustré
Black Gloss



82
Zèbra Lustré
Zebra Gloss



83
Bleu Métallique Lustré
Blue Metallic Gloss



84
Vert Métallique Lustré
Green Metallic Gloss



85
Acier Lustré
Steel Gloss



86
Rouge Vin Lustré
Wine Red Gloss



87
Cerisier Shiraz
Jubilee Cherry



90
Blanc Frosty Lustré
Frosty White Gloss



96
Gris Charbon Lustré
Charcoal Gloss



97
Poirier Choco Texturé
Textured Choco Pear



99
Tuxedo-2
Tuxedo-2

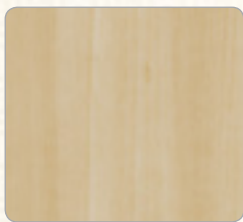

102
Érable Lustré
Maple Gloss



103
Wenge
Wenge

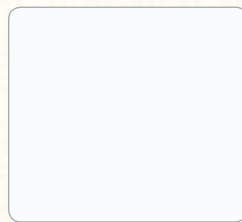

104
Satin-X
Satin-X



105
Blanc Arctique Rubané
Ribbon Arctic



108
Dolce Vita
Dolce Vita

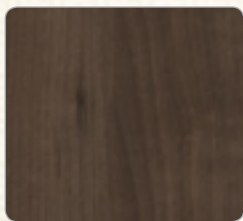

109
CopaCabana
CopaCabana



114
Frêne Linéaire
Linear Ash



115
Wenge Sculpté
Sculpted Wenge

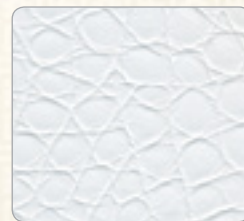

116
Blanc Alligator
Alligator White

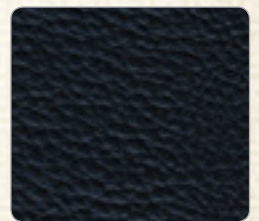

117
Cuir Noir
Black Leather

Couleurs • Finis

Colors • Finishes

En raison du procédé d'impression, les couleurs illustrées peuvent différer.
Toujours vérifier avec les échantillons fournis.

Because of the printing process, colors shown may differ.
Always verify with samples provided.



118
Noir Grain Bois
Black Wood Grain



119
Wenge Lustré
Wenge Gloss



122
Érable Classic
Classic Maple

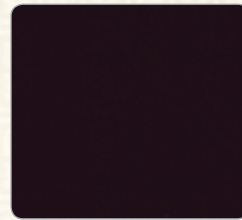

124
Pourpre Lustré
Purple Gloss

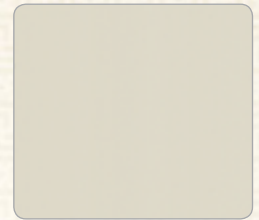

132
Blanc Givré
Frosty White

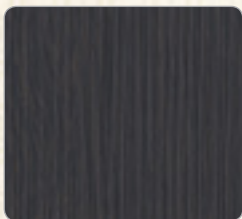

133
Chêne Melinga Gris
Oak Melinga Grey

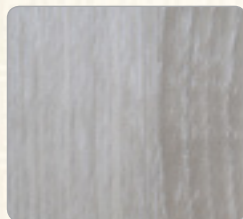

134
Messina
Messina



135
Bamboo des Îles
Island Bamboo

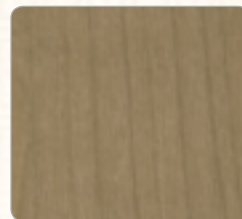

137
Érable Soyeux
Silken Maple



138
Noyer Foncé
Dark Walnut

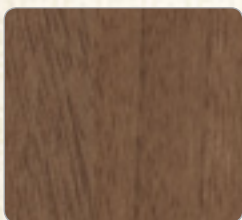

140
Noyer Majestueux
Majestic Walnut

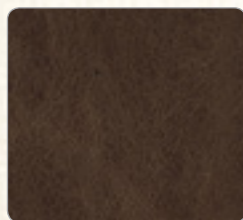

141
Cuir Brun
Brown Leather

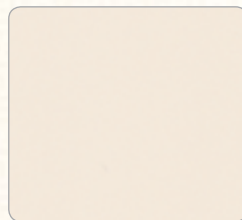

142
Blanc Antique
Antique White Mat

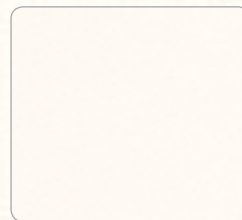

143
Frosty 1573-6
Frosty 1573-6

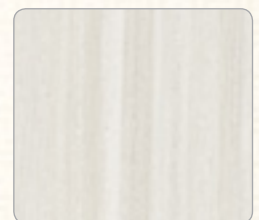

144
Blanc Chocolat
Chocolate White

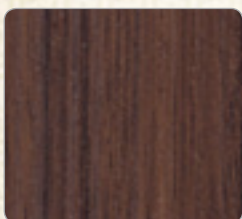

145
Lait au Chocolat
Milk Chocolate

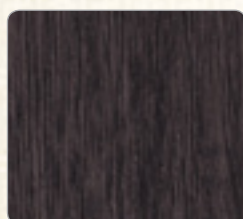

146
Chêne Queenston
Queenston Oak

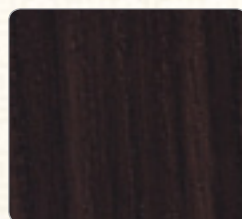

147
Chocolat Noir
Dark Chocolate

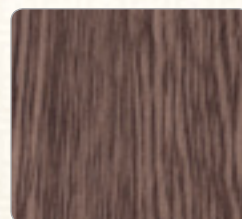

148
Chêne Ambassadeur
Ambassador Oak

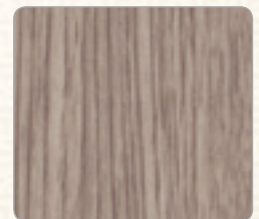

149
Chêne Milltown
Milltown Oak



152
Portobello-2
Portobello-2



153
Pin Argenté
Pewter Pine



154
Pin Praline
Praline Pine



156
Melèze Cappuccino
Cappuccino Larch



157
Largo Noir
Black Largo



158
Blanc Bois Lustré
White Wood H.G.



160
Mélinga Blanc
Melinga White



161
Mélinga Noir
Melinga Black

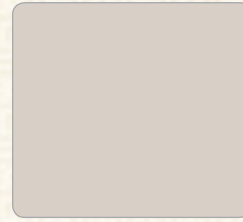

162
Gris Saule
Willow Grey



164
Velours Noir
Black Velvet



165
Noce Secchia
Noce Secchia

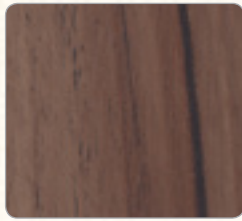

166
Noce Vettore
Noce Vettore



167
Noyer Authentique
Authentic Walnut



170
Gris Pâle Lustré
Light Grey HG



171
Brun Congo Lustré
Congo Brown HG



172
Gris Foncé Lustré
Dark Grey HG



174
Velours Gris
Grey Velvet



175
Gris Saule Lustré
Willow Grey H.G.

LES DÉCORS LES PLUS BEAUX, ET LES PLUS « VERTS » !

Thermoform se soucie de l'environnement et tient à contribuer à sa protection et à son respect. Thermoform prend soin de choisir des fournisseurs qui observent les standards élevés établis par le CARB (California Air Resources Board) qui prévalent dans l'industrie du meuble et du bâtiment.

Une porte est essentiellement composée de deux matières premières: le polymère, son revêtement esthétique, et le MDF (fibre de pin), qui forme le cœur de la porte.

Le polymère est manufacturé sans émission polluante qui entre dans une fabrication, également sans aucune émission polluante, par un procédé d'adhésion à base d'eau. Le polymère est recyclé à 100 %. Les résidus de production sont mis en ballots pour être acheminés vers un centre de recyclage.

Le MDF est un produit entièrement fabriqué de particules de bois recyclé ou récupéré, amalgamées dans une préparation de résine, pouvant ne pas contenir d'urée-formaldéhyde. Cette fibre à densité moyenne certifiée EPP (Environmentally Preferable Product) respecte les normes et exigences qui permettent d'accumuler des points LEED (Leadership in Energy & Environmental Design) et des crédits sur le bâtiment écologique GBC (Green Building Council).

WHERE BEAUTIFUL DECORS MEET GREEN THINKING!

Thermoform cares about the environment and contributes in protecting and respecting it. Thermoform carefully chooses suppliers adhering to the high standards of CARB (California Air Resources Board), standards regarded as the leading norm in the furniture and building industry.

A door is basically made of two main components: polymer, for the aesthetic coating shell and MDF (pine fibre), for the core structure.

Polymer is manufactured without polluting emission which enters production, also with water-based adhesive with no polluting emissions. The polymer is 100% recycled. Production residues are put in bundles to be transported to a recycling centre.

MDF is made of 100% recycled or salvaged wood particles, amalgamated using a preparation of resin, that can be urea formaldehyde free. This EPP (Environmentally Preferable Product) certified medium-density fiberboard is certified to respect the standards and requirements that allow for collecting LEED (Leadership in Energy & Environmental Design) points and GBC (Green Building Council) environmental building credits.



Garantie 12 ans

Thermoform offre une garantie de 12 ans, valable à compter de la date d'achat, en cas de vice de fabrication qui se traduirait par le décollement de ses produits thermoplastifiés. Par la présente garantie, Thermoform s'engage exclusivement à remplacer les produits polymères viciés. Le remplacement des produits viciés ne prolonge ni n'institue une nouvelle période de garantie. Cette garantie ne s'applique pas :

- à la détérioration attribuable à l'usure normale;
- à la détérioration attribuable à un usage abusif ou à un usage ou à un entretien inapproprié;
- à la détérioration attribuable à une installation inadéquate;
- à la détérioration attribuable aux accidents et à la négligence;
- à la détérioration attribuable à la proximité d'une source de chaleur excessive;
- à la détérioration résultant d'altérations ou de réparations conduites par du personnel n'appartenant pas à la compétence de **Thermoform**.

Cette garantie ne s'étend ni aux coûts de transport, d'installation ou de main d'œuvre, ni autres indirects ou incidents liés au remplacement du produit polymère vicié, ni à la perte de jouissance ou autres dommages ou inconvénients. Il faut présenter une preuve d'achat. Aucun distributeur, représentant ou mandataire n'est habilité à prolonger ou à étendre la présente garantie.

Les produits sont remplacés selon le modèle, le profil, le fini, les dimensions et les quantités de la production d'origine. Toute modification reste entièrement à la discrétion de **Thermoform**. Selon la disponibilité des produits au moment du remplacement, certaines substitutions peuvent s'imposer. Les feuilles polymères et bandes de chant sont exclues de la garantie.

12-Year Warranty

Thermoform's polymer products are covered under a 12-year warranty in effect from the date of purchase, against manufacturing defects resulting in delamination. Under this warranty, Thermoform will exclusively replace defective polymer products. Such replacement does not renew or extend the warranty time period. This warranty does not apply to:

- damage due to daily wear and tear;*
- damage due to abusive use or improper use or maintenance;*
- damage resulting from incorrect installation;*
- damage due to accidents or negligence;*
- damage due to exposure to excessive heat sources;*
- damage resulting from alterations or repairs not conducted by qualified **Thermoform** personnel.*

This warranty does not cover transportation, installation or labour costs or other costs resulting directly or indirectly from the replacement of defective products, or any damages, detriments or prejudices. Proof of purchase must be provided. Coverage under this warranty may not be extended or prolonged by any distributors, representatives or agents.

*Products are replaced according to model, profile, finish, dimensions and quantities of original production. Modifications are entirely at **Thermoform's** discretion. According to product availability at time of replacement, substitutions may be necessary. Polymer sheets and edges are excluded from this warranty.*

Porte monopièce
Garantie 12 ans !

Monopiece Door
12-Year Warranty!

Rendez-vous sur
notre site Internet
pour consulter tous
nos catalogues
et nos nouveautés.



Visit our website
to see all of our
catalogs and
our news!

www.thermoform.net



THERMOFORM

Composantes d'armoires polymères | Polymer Cupboard Components

970, rue Théophile-St-Laurent, Nicolet (Québec) Canada J3T 1B4

T : 819 293-8899

F : 819 293-4110 | 1 800 203-9036

www.thermoform.net

Chez Thermoform, nous nous soucions de
l'environnement. C'est pourquoi nous sommes fiers
d'offrir des produits faits de matières
recyclées à 97 %. En achetant les
produits Thermoform, vous contribuez
au maintien d'un milieu sain.



Thermoform cares about the environment.
That's why we are proudly offering products
97% made from recycled materials.
When buying Thermoform products you
help maintain a healthy environment.