



# Highways Safety Solutions

[www.glasdon.com](http://www.glasdon.com)

Highways Bollards	3-19
Sign Carrying Bollards	20-27
Recycled Material Bollards	28-30
Road Safety Signs	31-34
Road Safety Vergeposts	35-43
Gateway Sign Carriers	44-47
Other Road Safety Products	48-49
Fixing Options	50-52
High Performance Materials	53
Photo Gallery	54-59

## Passively Safe

Passively safe street furniture is designed to minimise the severity of injury to occupants of a vehicle that collides with it. The European Standard BS EN 12767 defines a universal test that establishes the performance of a passively safe roadside structure.

The performance rating is displayed in the following format:

The first number indicates the class impact speed in kph: 50, 70 or 100kph. Tests are conducted with a small (900kg) car in a head-on, frontal impact.

The two letters represent the energy absorbed by the structure: High energy absorbing (HE) support structures slow the vehicle considerably on impact; Low energy (LE) structures measurably slow the vehicle but pose a much lower risk of injury to its occupants; Non-energy absorbing (NE) structures have negligible or nil effect on the speed of the vehicle.

The final number represents the occupant safety level and is based on the Acceleration Severity Index (ASI) and Theoretical Head Impact Velocity (THIV) scales, according to European Standard BS EN 1317-1. The available levels are 1-4, where Level 4 represents the safest and Level 1 the most dangerous.

Glasdon passively safe highways products are tested by accredited independent specialists at MIRA and TRL.

Where testing has been conducted, the performance rating will be clearly shown on the page.



# Highways Bollards

Glasdon have been designing and manufacturing bollards for more than 40 years. Our versatile road safety solutions are used all over the highways and byways of the United Kingdom, and we like to think we have a product for every application. With a variety of traditional and modern styles, in rigid Durapol® material and flexible Impactapol® material and also a wide choice of fixing options to suit your requirements.



## Advanced Neopolitan™ 150 Bollard

### DESIGN FEATURES

- Available as a self-righting Rebound bollard or rigid Durapol® material model.
- Choice of two fixing options - LockFast™ Socket System or permanent below-ground extended base fixing.
- Large 150mm reflective top patches.
- Larger 40mm lower reflector catches dipped headlights.
- Individual reflectors offer enhanced drive-through performance.
- LockFast Socket allows quick and easy bollard top replacement.
- Optional socket blanking cap available.

### SPECIFICATIONS

Height above ground:	925mm
Maximum diameter:	200mm
Socket depth below ground:	350mm
Extended base depth below ground:	300mm

*\*Rebound Impactapol model only.*



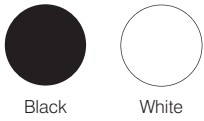

**MATERIAL & COLOUR OPTIONS**

Bollard: Passively safe Impactapol® material or rigid Durapol material

LockFast Socket: Durapol material.

Durapol material and Passively Safe Rebound Impactapol material: Black, White.

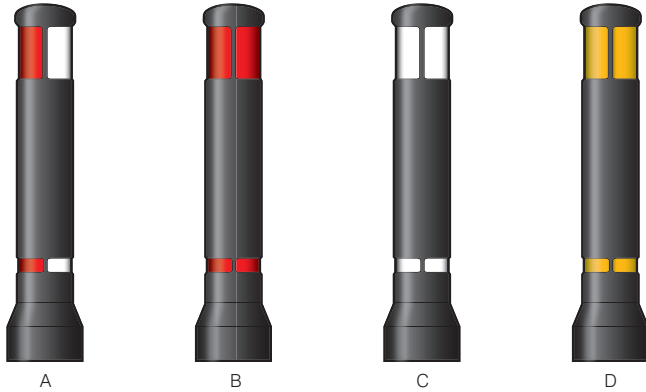

**OPTIONAL BANDING**

A. 2 x 150mm and 2 x 40mm Red/White retroreflective patches\*

B. 2 x 150mm and 2 x 40mm Red retroreflective patches\*

C. 2 x 150mm and 2 x 40mm White retroreflective patches\*

D. 2 x 150mm and 2 x 40mm Amber retroreflective patches\*

\*All retroreflective materials meet the requirements in table NA1 of BS EN 12899-1:2007 Fixed Vertical Road Signs.

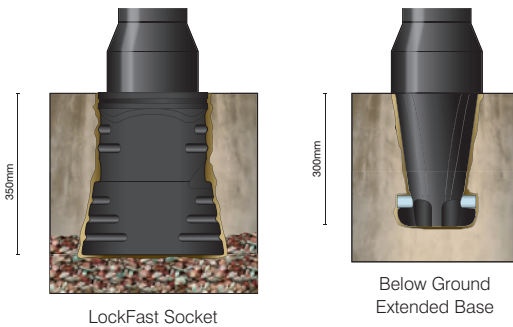

**FIXING OPTIONS**

Durapol material and Passively Safe Rebound Impactapol material: LockFast Socket, Below Ground Extended Base.





## ■ Glasdon Manchester™ Bollard

### DESIGN FEATURES

- Available as a self-righting Rebound bollard or rigid Durapol® material model.
- Never requires painting - unlike cast iron equivalents.
- A fraction of the weight of a metal bollard - can be installed by one person.
- Existing cast iron bollards can be replaced over time to save cost.
- Recessed areas for retroreflective or decorative banding.
- LockFast™ Socket allows quick and easy bollard top replacement.
- Optional socket blanking cap available

### SPECIFICATIONS

Height above ground:	1005mm
Maximum diameter:	220mm
Socket depth below ground:	350mm
Extended base depth below ground:	300mm

\*Rebound Impactapol model only.





Black

### MATERIAL & COLOUR OPTIONS

Bollard: Passively safe Impactapol® material or rigid Durapol material.

LockFast Socket: Durapol material.

Durapol material and Passively Safe Rebound Impactapol material: Black.

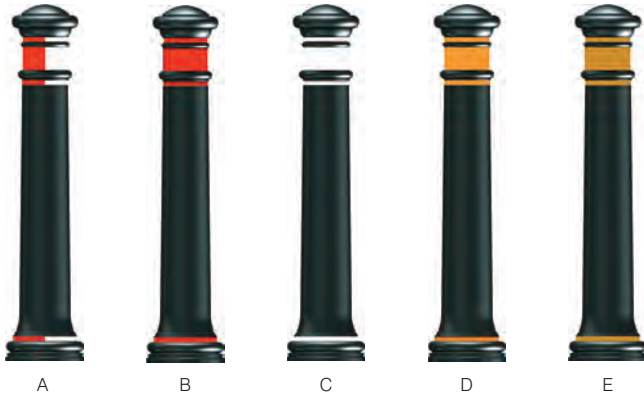

### OPTIONAL BANDING

A. 1 x 63mm and/or up to 3 x 12mm Red/White retroreflective bands\*

B. 1 x 63mm and/or up to 3 x 12mm Red retroreflective bands\*

C. 1 x 63mm and/or up to 3 x 12mm White retroreflective bands\*

D. 1 x 63mm and/or up to 3 x 12mm Amber retroreflective bands\*

E. 1 x 63mm and/or up to 3 x 12mm Gold Decorative bands

\*All retroreflective materials meet the requirements in table NA1 of BS EN 12899-1:2007 Fixed Vertical Road Signs.

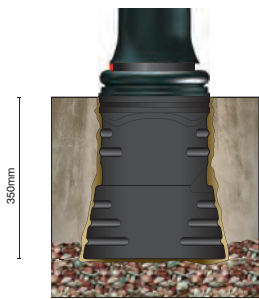

LockFast Socket

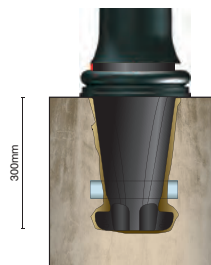

Below Ground  
Extended Base

### FIXING OPTIONS

Durapol material and Passively Safe Rebound Impactapol material: LockFast Socket, Below Ground Extended Base.





## Neopolitan™ 150 Bollard

### DESIGN FEATURES

- Available as a self-righting Rebound bollard or rigid Durapol® material model.
- Recessed areas for retroreflective or decorative banding.
- Wide range of fixing options available.
- Optional socket blanking cap available.

### SPECIFICATIONS

Height above ground:	925mm
(socketed/extended base/guardsman models)	1005mm
(bolt-down)	200mm
Maximum diameter:	500mm
Socket depth below ground:	420mm
Extended base depth below ground:	745mm
Guardsman™ fixing depth below ground:	311mm
Bridgeman™ fixing depth below ground:	75mm
Bolt-down fixing depth:	320mm
Adjustable depth concrete-in anchors	
maximum depth:	

\*Rebound Impactapol model only.





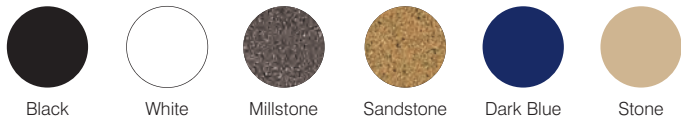

#### MATERIAL & COLOUR OPTIONS

Bollard: Passively safe Impactapol® material or rigid Durapol material.

Socket: Durapol material.

Durapol Material: Black, White, Millstone, Sandstone, Dark Blue, Stone.

Passively Safe Rebound Impactapol Material: Black, White.

(Some colours are subject to a minimum order quantity. Please telephone our Sales Office for details.)

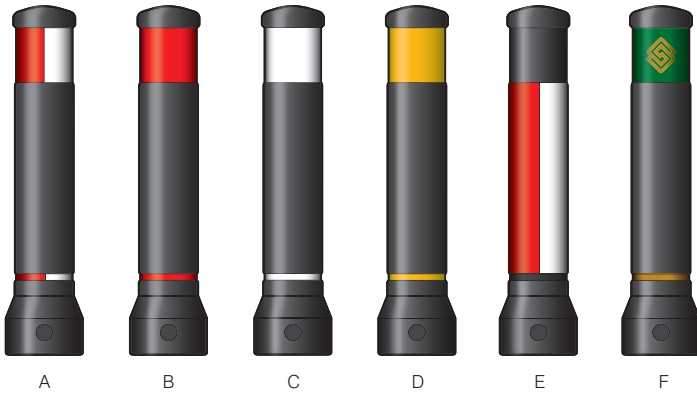

#### OPTIONAL BANDING

A. 1 x 150mm and 1 x 20mm Red/White retroreflective bands\*

B. 1 x 150mm and 1 x 20mm Red retroreflective bands\*

C. 1 x 150mm and 1 x 20mm White retroreflective bands\*

D. 1 x 150mm and 1 x 20mm Amber retroreflective bands\*

E. 1 x 485mm Red/White, Red, White or Amber body sleeve (3 x 150mm bands are available for use with Rebound model)\*

F. 1 x 150mm and 1 x 20mm decorative bands

150mm band is ideal for personalisation with your crest, logo or message.

\*All retroreflective materials meet the requirements in table NA1 of BS EN 12899-1:2007 Fixed Vertical Road Signs.

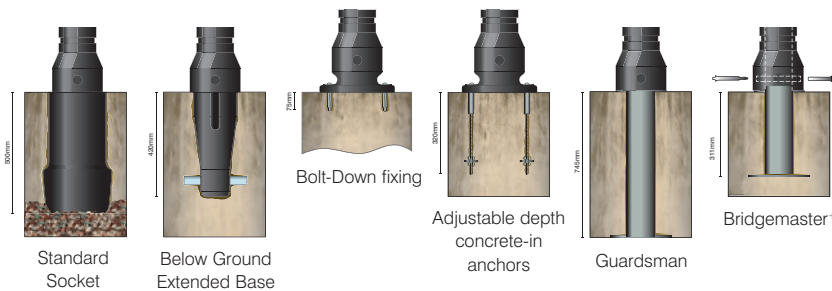

#### FIXING OPTIONS

Durapol material: Standard Socket, Below Ground Extended Base, Bolt-Down fixing, Adjustable depth concrete-in anchors, Guardsman, Bridgemaster.

Passively Safe Rebound Impactapol material: Below Ground Extended Base, Bolt-Down fixing, Adjustable depth concrete-in anchors.

\*Please note: Bridgemaster fixing is available in Black Durapol material only.





## 600mm High Neopolitan™ 150 Bollard

### DESIGN FEATURES

- Designed for improved visibility at junctions.
- Available as a self-righting Rebound bollard or a rigid Durapol® material model.
- Recessed areas for retroreflective or decorative banding.
- Co-ordinates with Neopolitan 150 and Neopolitan 20 Bollards

### SPECIFICATIONS

Height above ground:	612mm
Maximum diameter:	200mm
Bolt-down fixing depth:	75mm
Adjustable depth concrete-in anchors maximum depth:	320mm

*\*Rebound Impactapol model only.*



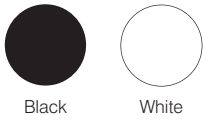

Black

White

### MATERIAL & COLOUR OPTIONS

Bollard: Passively safe Impactapol® material or rigid Durapol material  
 Durapol material and Passively Safe Rebound Impactapol material: Black, White.

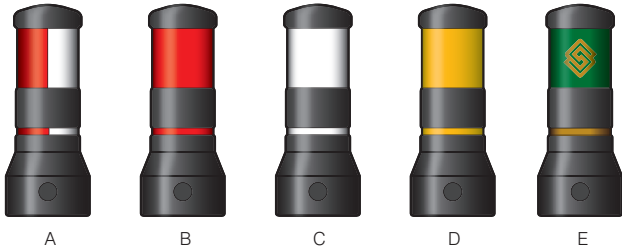

### OPTIONAL BANDING

- A. 1 x 150mm and 1 x 20mm Red/White retroreflective bands\*
- B. 1 x 150mm and 1 x 20mm Red retroreflective bands\*
- C. 1 x 150mm and 1 x 20mm White retroreflective bands\*
- D. 1 x 150mm and 1 x 20mm Amber retroreflective bands\*
- E. 1 x 150mm and 1 x 20mm decorative bands

150mm band is ideal for personalisation with your crest, logo or message.

\*All retroreflective materials meet the requirements in table NA1 of BS EN 12899-1:2007 Fixed Vertical Road Signs.

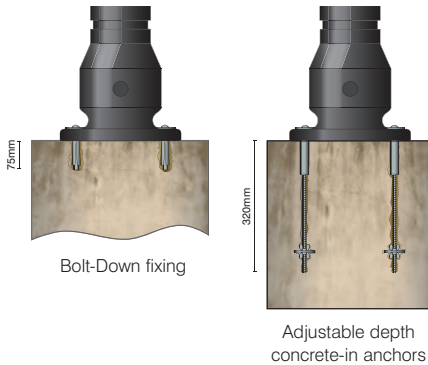

### FIXING OPTIONS

Durapol material and Passively Safe Rebound Impactapol material:  
 Bolt-Down fixings, Adjustable depth concrete-in anchors.





## Neopolitan™ 20 Bollard

### DESIGN FEATURES

- Available as a self-righting Rebound bollard or rigid Durapol® material model.
- Recessed areas for retroreflective or decorative banding.
- Wide range of fixing options available.
- Optional socket blanking cap available.

### SPECIFICATIONS

Height above ground:	925mm
Maximum diameter:	200mm
Socket depth below ground:	500mm
Extended base depth below ground:	420mm
Guardsman™ fixing depth below ground:	745mm
Bridgmaster™ fixing depth below ground:	300mm
Bolt-down fixing depth:	95mm
Adjustable depth concrete-in anchors maximum depth:	250mm

\*Rebound Impactapol model only.





**MATERIAL & COLOUR OPTIONS**

Bollard: Passively safe Impactapol® material or rigid Durapol material.

Socket: Durapol material.

Durapol material: Black, White, Millstone, Sandstone, Dark Blue, Stone.

Passively Safe Rebound Impactapol material: Black, White.

(Some colours are subject to a minimum order quantity. Please telephone our Sales Office for details.)

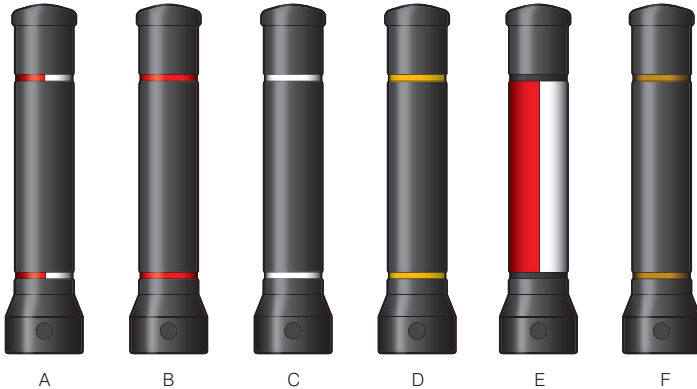

**OPTIONAL BANDING**

A. 2 x 20mm Red/White retroreflective bands\*

B. 2 x 20mm Red retroreflective bands\*

C. 2 x 20mm White retroreflective bands\*

D. 2 x 20mm Amber retroreflective bands\*

E. 1 x 485mm Red/White, Red, White or Amber body sleeve (3 x 150mm bands are available for use with Rebound model)\*

F. 2 x 20mm Gold decorative bands

\*All retroreflective materials meet the requirements in table NA1 of BS EN 12899-1:2007 Fixed Vertical Road Signs.

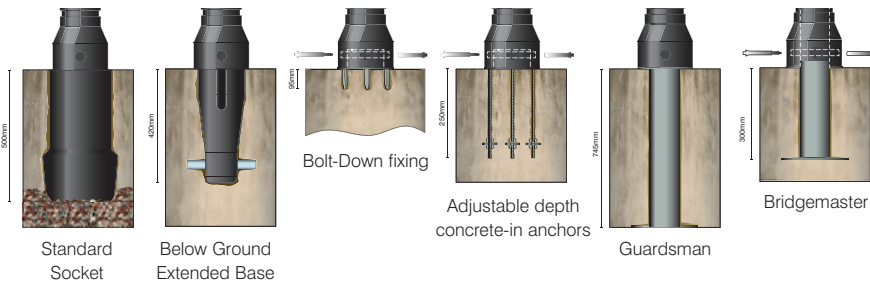

**FIXING OPTIONS**

Durapol material: Standard Socket, Below Ground Extended Base, Bolt-Down fixing, Adjustable depth concrete-in anchors, Guardsman, Bridgemaster.

Passively Safe Rebound Impactapol material: Below Ground Extended Base.





## Admiral™ Bollard

### DESIGN FEATURES

- Available as a self-righting Rebound bollard or rigid Durapol® material model.
- 80mm (Rigid) or 150mm (Rebound) banding recess.
- Optional socket blanking cap available.

### SPECIFICATIONS

Height above ground:	936mm
Maximum diameter:	198mm
Socket depth below ground:	500mm
Extended base Impactapol® model depth below ground:	300mm
Extended base Durapol® model depth below ground:	430mm

\*Rebound Impactapol model only.



Glasdon focus on Highly Visible Junction Marker Bollards for Somerset County Council.

### What the Customer says:

"Somerset County Council have found the Admiral junction marker to be a useful tool in their armoury, as part of integrated route treatment works in rural locations. It has been effective in reducing road accident casualties and gives drivers enhanced information on road layouts and potential hazards."

Mr Nick Cowling, Team Leader Accident Data and Engineering, Somerset.



**MATERIAL & COLOUR OPTIONS**

Bollard: Passively safe Impactapol material or rigid Durapol material.

Socket: Durapol material.

Durapol material: Black, White, Millstone, Sandstone, Aircraft Grey, Stone.

Passively Safe Rebound Impactapol material: Black, White.

(Some colours are subject to a minimum order quantity. Please telephone our Sales Office for details.)

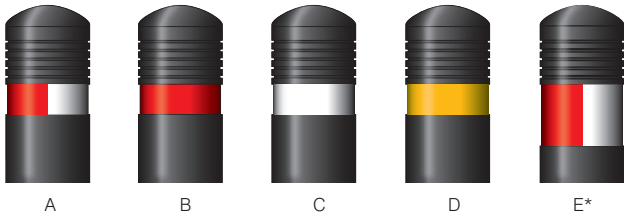

**OPTIONAL BANDING**

A. 1 x 80mm Red/White retroreflective band#

B. 1 x 80mm Red retroreflective band#

C. 1 x 80mm White retroreflective band#

D. 1 x 80mm Amber retroreflective band#

E. 1 x 150mm Red/White, Red, White or Amber retroreflective band#

#All retroreflective materials meet the requirements in table NA1 of BS EN 12899-1:2007 Fixed Vertical Road Signs.

\* Available with the self-righting Rebound model only.

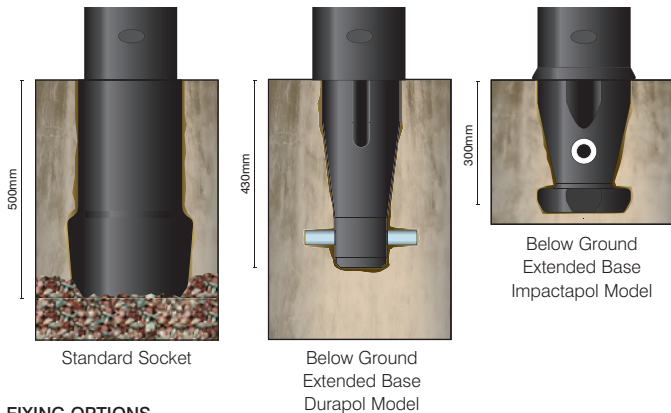

**FIXING OPTIONS**

Durapol material: Standard Socket, Below Ground Extended Base.

Passively Safe Rebound Impactapol material: Below Ground Extended Base.





## ■ Victory™ Bollard

### DESIGN FEATURES

- Available as a self-righting Rebound bollard or rigid Durapol® material model.
- Never requires painting - unlike cast iron equivalents.
- A fraction of the weight of a metal bollard - can be installed by one person.
- Recessed areas for retroreflective or decorative banding.
- Optional socket blanking cap available.

### SPECIFICATIONS

Height above ground:	967mm
Maximum diameter:	200mm
Socket depth below ground:	500mm
Extended base depth below ground:	420mm

\*Rebound Impactapol model only.







Black

### MATERIAL & COLOUR OPTIONS

Bollard: Passively safe Impactapol® material or rigid Durapol material.  
Socket: Durapol material  
Durapol material and Passively Safe Rebound Impactapol material: Black.

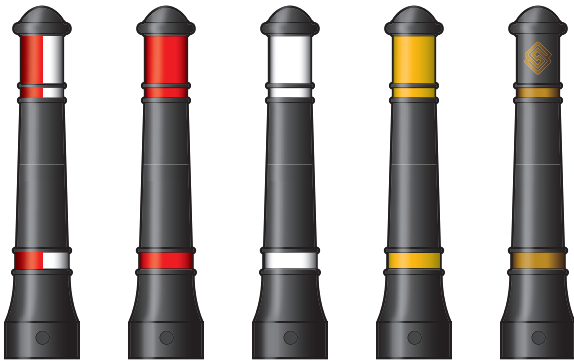

A

B

C

D

E

### OPTIONAL BANDING

- A. 1 x 125mm and/or 1 x 20mm and/or 1 x 38mm Red/White retroreflective bands\*
- B. 1 x 125mm and/or 1 x 20mm and/or 1 x 38mm Red retroreflective bands\*
- C. 1 x 125mm and/or 1 x 20mm and/or 1 x 38mm White retroreflective bands\*
- D. 1 x 125mm and/or 1 x 20mm and/or 1 x 38mm Amber retroreflective bands\*
- E. 1 x 125mm and/or 1 x 20mm and/or 1 x 38mm Gold decorative bands  
125mm band is ideal for personalisation with your crest, logo or message.

\*All retroreflective materials meet the requirements in table NA1 of BS EN 12899-1:2007 Fixed Vertical Road Signs.

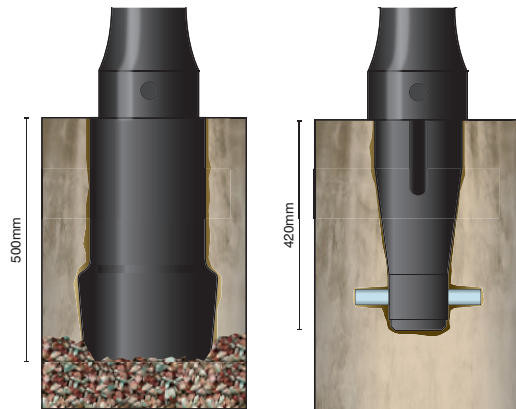

500mm

420mm

Standard Socket

Below Ground  
Extended Base

### FIXING OPTIONS

Durapol material: Standard Socket, Below Ground Extended Base.  
Passively Safe Rebound Impactapol material: Below Ground Extended Base.





## Jubilee™ Bollard

### DESIGN FEATURES

- Available as a self-righting Rebound bollard or rigid Durapol® material model.
- Never requires painting - unlike cast iron equivalents.
- A fraction of the weight of a metal bollard - can be installed by one person.
- Versatile banding options.
- Optional socket blanking cap available.

### SPECIFICATIONS

Height above ground:	942mm
Maximum diameter:	190mm
Socket depth below ground:	500mm
Extended base depth below ground:	420mm

\*Rebound Impactapol model only.





Black

### MATERIAL & COLOUR OPTIONS

Bollard: Passively safe Impactapol® material or rigid Durapol material.  
Socket: Durapol material  
Durapol material and Passively Safe Rebound Impactapol material: Black.

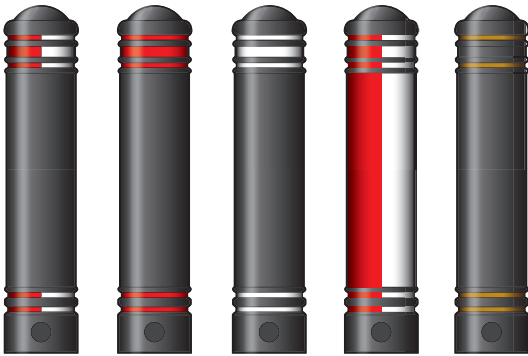

A B C D E

### OPTIONAL BANDING

- A. 4 x 12mm and/or 1 x 27mm Red/White retroreflective bands\*
- B. 4 x 12mm and/or 1 x 27mm Red retroreflective bands\*
- C. 4 x 12mm and/or 1 x 27mm White retroreflective bands\*
- D. 1 x 580mm Red/White, Red, White or Amber body sleeve, 4 x 12mm and 1 x 27mm retroreflective bands\*
- E. 4 x 12mm Gold decorative bands.

\*All retroreflective materials meet the requirements in table NA1 of BS EN 12899-1:2007 Fixed Vertical Road Signs.

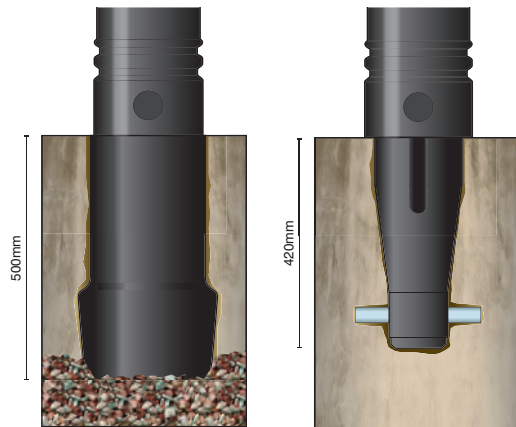

Standard Socket

Below Ground  
Extended Base

### FIXING OPTIONS

Durapol material: Standard Socket, Below Ground Extended Base.  
Passively Safe Rebound Impactapol material: Below Ground Extended Base.



Highways Bollards

# Sign Carrying Bollards

Warn, inform and protect road users, cyclists and pedestrians with Glasdon sign carrying bollards. Perfect for marking dedicated cycle paths and shared routes.

Rigid and rebound models are available to co-ordinate with our range of Neopolitan Bollards.



## Infomaster™ Bollard

### DESIGN FEATURES

- Rigid Durapol® material construction.
- Optimum height for drivers.
- Narrow footprint takes up minimal space on the pavement.
- Double-sided signface helps to reduce cost.
- Recessed signface deters vandalism.
- Easily re-sited.

### SPECIFICATIONS

Height above ground: 1196mm  
 Width: 370mm  
 Sign face dimensions: 308mm x 248mm  
 Bolt-down fixing depth: 75mm  
 Adjustable depth concrete-in anchors maximum depth: 320mm



Black



Millstone

### MATERIAL & COLOUR OPTIONS

Durapol material in Black, Millstone.

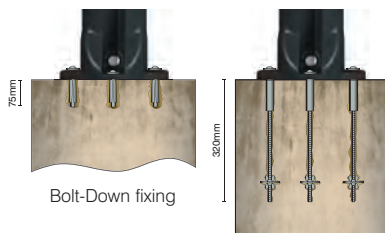

Bolt-Down fixing

Adjustable depth concrete-in anchors



### OPTIONAL SIGNFACES

Available single or double sided and with optional side reflectors. Infomaster can be used for a range of applications, please see above for examples. Disabled Badge Holder signface available as a standard sign price option. Other non-standard signfaces are available, to discuss your requirements please telephone our sales office on 01253 600411.

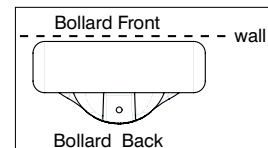

### SIGNFACE ORIENTATION

If Infomaster is to be sited against a building/wall please specify that the signface is for the back of the bollard.

### FIXING OPTIONS

Bolt-Down fixing, Adjustable depth concrete-in anchors.



## Ensign™ Bollard

### DESIGN FEATURES

- Rigid Durapol® material construction.
- Wide range of signface options.
- Recessed areas for retroreflective or decorative banding.
- Optional socket blanking cap available.

### SPECIFICATIONS

Height above ground:	1120mm
(socketed)	
(bolt-down)	1206mm
Width:	338mm
Maximum stem diameter:	200mm
Sign face diameter:	300mm
Socket depth below ground:	500mm
Extended base depth below ground:	420mm
Bolt-down fixing depth:	75mm
Adjustable depth concrete-in anchors maximum depth:	320mm



**MATERIAL & COLOUR OPTIONS**

Bollard: Rigid Durapol material.

Socket: Durapol material.

Durapol material: Black, White, Millstone, Dark Blue\*, Aircraft Grey.

(Some colours are subject to a minimum order quantity. Please telephone our Sales Office for details.)

\*Dark Blue colour option only available with the Standard Socket or Below Ground Extended Base fixings

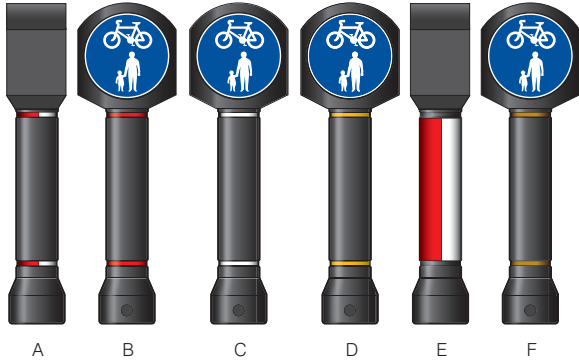

**OPTIONAL BANDING**

A. 2 x 20mm Red/White retroreflective bands\*

B. 2 x 20mm Red retroreflective bands\*

C. 2 x 20mm White retroreflective bands\*

D. 2 x 20mm Amber retroreflective bands\*

E. 1 x 485mm Red/White, Red, White or Amber body sleeve

F. 2 x 20mm Gold decorative bands

\*All retroreflective materials meet the requirements in table NA1 of BS EN 12899-1:2007 Fixed Vertical Road Signs.

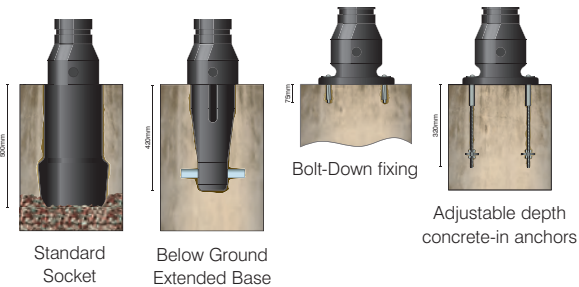

**FIXING OPTIONS**

Durapol material: Standard Socket, Below Ground Extended Base, Bolt-Down fixing, Adjustable depth concrete-in anchors.

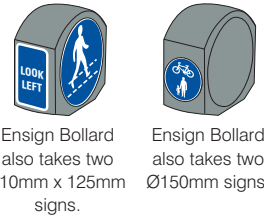

Ensign Bollard also takes two 210mm x 125mm signs.

Ensign Bollard also takes two Ø150mm signs.



Sign Carrying Bollards

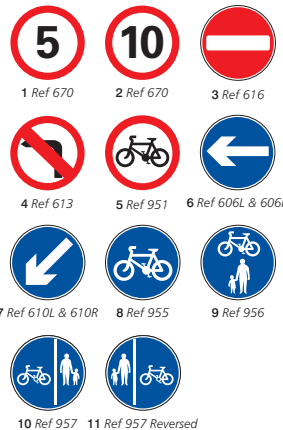

**STANDARD PRICE SIGN OPTIONS**

1. Max. Speed Limit (5mph)
2. Max. Speed Limit (10mph)
3. No Entry
4. No Left Turn
5. Cycles Prohibited
6. Turn Left or Right
7. Keep Left or Right
8. Cycle Route
9. Cycle/Pedestrians Only
10. Cycle/Pedestrians Only "Route Marked"
11. Cycle/Pedestrians Only "Route Marked" reversed



## Mini Ensign™ Bollard

### DESIGN FEATURES

- Available as a self-righting Rebound bollard or rigid Durapol® material model.
- Illuminated rebound model available.
- Wide range of signface options.
- Recessed areas for retroreflective or decorative banding.
- Optional socket blanking cap available.

### SPECIFICATIONS

Height above ground:	1010mm
(socketed)	1087mm
(bolt-down)	200mm
Maximum diameter:	150mm
Sign face diameter:	500mm
Socket depth below ground:	420mm
Extended base depth below ground:	75mm
Bolt-down fixing depth:	320mm
Adjustable depth concrete-in anchors maximum depth:	226mm
Sublite fixing minimum depth below-ground:	

\*Rebound Impactapol model only.





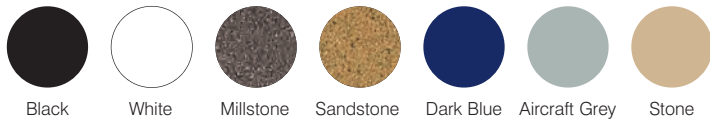

**MATERIAL & COLOUR OPTIONS**

Bollard: Passively safe Impactapol® material or rigid Durapol material.

Socket: Durapol material.

Durapol material: Black, White, Millstone, Sandstone, Dark Blue, Aircraft Grey, Stone.

Passively Safe Rebound Impactapol material: Black, White. Mini Ensign illuminated rebound bollard is only available in White.

(Some colours are subject to a minimum order quantity. Please telephone our Sales Office for details.)

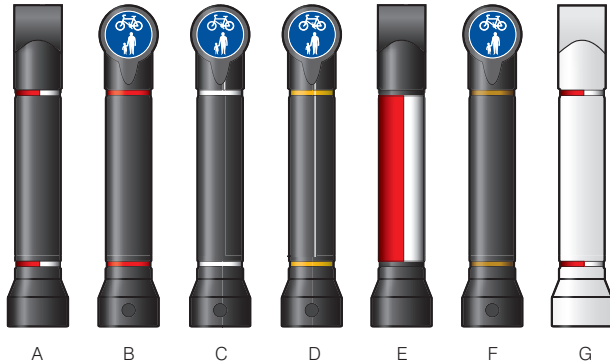

**OPTIONAL BANDING**

- A. 2 x 20mm Red/White retroreflective bands\*
- B. 2 x 20mm Red retroreflective bands\*
- C. 2 x 20mm White retroreflective bands\*
- D. 2 x 20mm Amber retroreflective bands\*
- E. 1 x 485mm Red/White, Red, White or Amber body sleeve (3 x 150mm bands are available for use with Mini Ensign Rebound models.)\*

- F. 2 x 20mm Gold decorative bands
- G. 2 x 20mm Red/White translucent retroreflective bands (for use with Mini Ensign illuminated rebound bollard)

\*All retroreflective materials meet the requirements in table NA1 of BS EN 12899-1:2007 Fixed Vertical Road Signs.

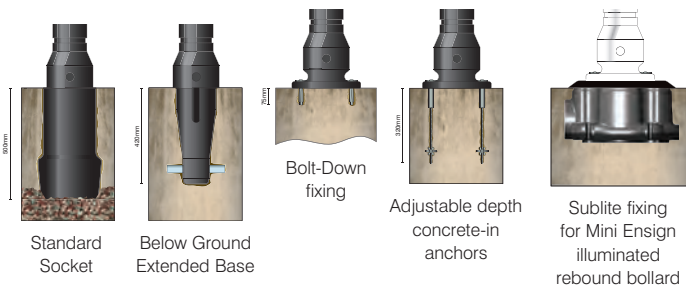

**FIXING OPTIONS**

Durapol material: Standard Socket, Below Ground Extended Base, Bolt-Down fixing, Adjustable depth concrete-in anchors.

Passively Safe Rebound Impactapol material: Below Ground Extended Base, Bolt-Down fixing, Adjustable depth concrete-in anchors, Sublite fixing for Mini Ensign illuminated rebound bollard.



**MINI ENSIGN ILLUMINATED BOLLARD**

White Mini Ensign illuminated rebound bollard with Red/White translucent retroreflective bands.

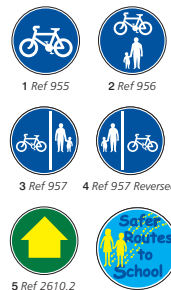

**STANDARD PRICE SIGN OPTIONS**

1. Cycle Route
2. Cycle/Pedestrians Only
3. Cycle/Pedestrians Only "Route Marked"
4. Cycle/Pedestrians Only "Route Marked" reversed
5. Waymark

Sign carrying bollards are also suitable for personalisation with safer routes to schools or your crest, logo or message. Please phone 01253 600411 for more information.



## Cyclemaster™ Bollard

### DESIGN FEATURES

- Available as a self-righting Rebound bollard or rigid Durapol® material model.
- Wide range of 150mm or 125 x 210mm vandal-resistant signface options.
- Can display up to 6 signfaces on front and rear (3 per side).
- Fluorescent yellow retroreflective panels provide high visibility by day and by night.
- Recessed areas for retroreflective panels.
- Optional side reflectors angled for increased visibility.
- Socket fixing allows quick and easy bollard top replacement.

### SPECIFICATIONS

Height above ground:	1000mm
Width:	216mm
Socket depth below ground:	306mm
Extended base depth below ground:	256mm
Bolt-down fixing depth:	75mm
Adjustable depth concrete-in anchors maximum depth:	320mm
Fixed depth concrete-in anchors maximum depth:	250mm



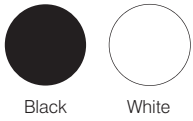

Black White

### MATERIAL & COLOUR OPTIONS

Bollard: Rebound Impactapol® material or rigid Durapol material.  
 Socket: Durapol material.  
 Durapol material and Rebound Impactapol material: Black, White.

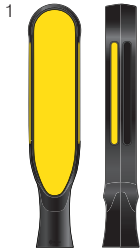

#### OPTION 1 REFLECTORS

1 x Fluorescent Yellow retroreflective front panel  
 2 x Fluorescent Yellow retroreflective side panels

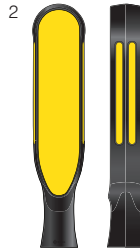

#### OPTION 2 REFLECTORS

1 x Fluorescent Yellow retroreflective front panel  
 4 x Fluorescent Yellow retroreflective side panels



#### OPTION 3 REFLECTORS

1 x Fluorescent Yellow retroreflective front panel  
 1 x Fluorescent Yellow retroreflective back panel  
 4 x Fluorescent Yellow retroreflective side panels

### RETROREFLECTIVE PATCH OPTIONS

All retroreflective materials meet the requirements in table NA1 of BS EN 12899-1:2007 Fixed Vertical Road Signs.

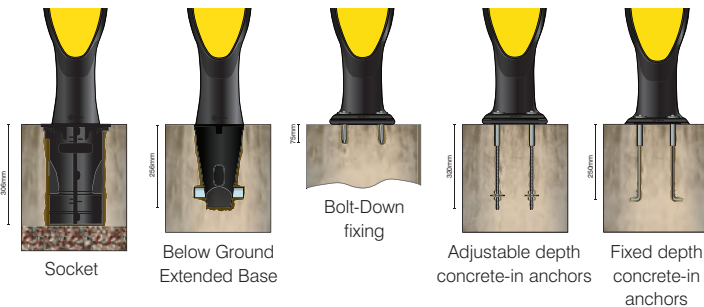

### FIXING OPTIONS

Durapol material and Impactapol material: Socket, Below Ground Extended Base, Bolt-down fixing, Adjustable depth concrete-in anchors, Fixed depth concrete-in anchors.

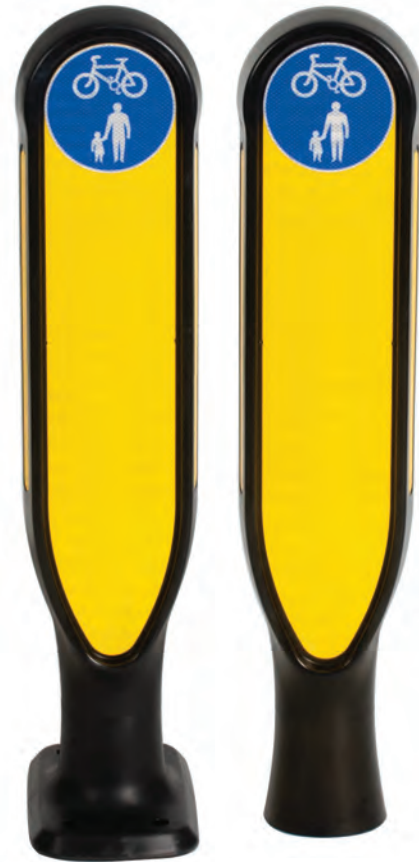

Sign Carrying Bollards



1 Ref 955



2 Ref 956



3 Ref 957



4 Ref 957 Reversed



5 Ref 610L & 6106R



6 Ref 606L & 606R



7 Ref 606 Straight Ahead



8 Ref 2602.2

### STANDARD PRICE SIGN OPTIONS

Cyclenmaster bollard has the option to carry up to 3 signs on each side.

- |   |                         |
|---|-------------------------|
| 1. Cycle Route                                    | 5. Keep Left or Right   |
| 2. Cycle/Pedestrians Only                         | 6. Turn Left or Right   |
| 3. Cycle/Pedestrians Only "Route Marked"          | 7. Straight Ahead       |
| 4. Cycle/Pedestrians Only "Route Marked" reversed | 8. Numbered Cycle Route |
- Other non-standard signfaces are available, please contact our sales office for information.

# Recycled Material Bollards



Enviropol® recycled plastic material is manufactured predominantly from post-consumer plastics. By balancing these uncontaminated recycled waste materials, the result is a remarkably versatile product with many applications and benefits. Enviropol material will not chip or rust, is easy to clean and never needs painting.

Buffer™ Bollard is manufactured from 100% recycled rubber tyres and is pressure moulded to create a strong, hard-wearing, weatherproof material.



## Buffer™ Bollard

### DESIGN FEATURES

- Available in two heights - 600mm or 900mm.
- Reinforcing tube allows bollard to be flexible yet resilient.
- Recessed area for retroreflective or decorative banding.
- Made from 100% recycled rubber tyres.

### SPECIFICATIONS

Height above ground:	600mm or 900mm
Maximum diameter:	248mm
Extended base depth below ground:	300mm
Bolt-down fixing depth:	95mm
Adjustable depth concrete-in anchors:	250mm



Black



Green

### MATERIAL & COLOUR OPTIONS

Bollard: 100% recycled rubber car tyres in Black, Green.

Reinforcing tube: Galvanised mild steel.

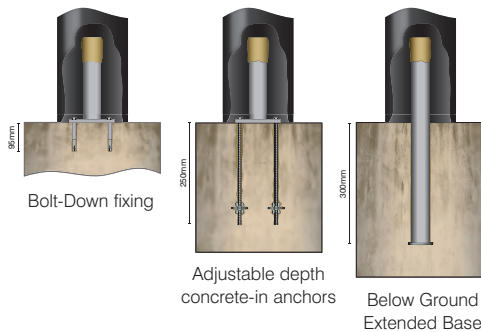

### FIXING OPTIONS

Bolt-Down fixing, Adjustable depth concrete-in anchors, Below Ground Extended Base.

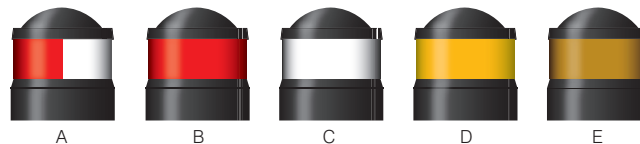

### OPTIONAL BANDING

- 1 x 75mm Red/White retroreflective band\*
- 1 x 75mm Red retroreflective band\*
- 1 x 75mm White retroreflective band\*
- 1 x 75mm Amber retroreflective band\*
- 1 x 75mm Gold decorative band.

Ideal for personalisation with your crest, logo or message.

\*All retroreflective materials meet the requirements in table NA1 of BS EN 12899-1:2007 Fixed Vertical Road Signs.



## Enviropol® Bollard

### DESIGN FEATURES

- Available with a flat or round top.
- Recessed area for retroreflective or decorative banding.
- Made from 100% recycled material.
- Below-ground extended base fixing.

### SPECIFICATIONS

Height above ground: 1000mm  
 Maximum diameter: 150mm  
 Depth below ground: 500mm



Black

### MATERIAL & COLOUR OPTIONS

Bollard: 100% recycled Enviropol® material in Black.

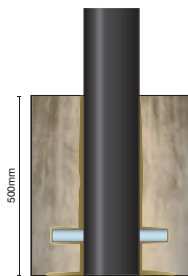

Below Ground  
Extended Base

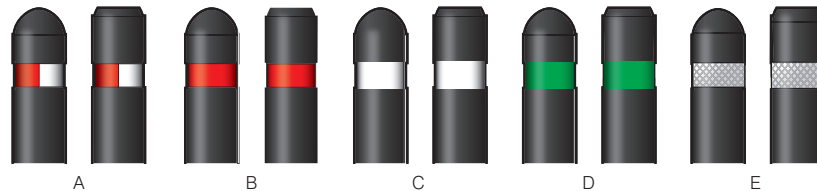

### OPTIONAL BANDING

- A. 1 x 80mm Red/White retroreflective band\*
- B. 1 x 80mm Red retroreflective band\*
- C. 1 x 80mm White retroreflective band\*

- D. 1 x 80mm Green decorative band
- E. 1 x 80mm Silver decorative band

### FIXING OPTIONS

Below Ground Extended Base.

\*All retroreflective materials meet the requirements in table NA1 of BS EN 12899-1:2007 Fixed Vertical Road Signs.

# Road Safety Signs



For use on bends and roundabouts, the Glasdon Chevroflex Ultra™ chevron boards meet passive safety standards, are proven to prevent accidents and cut costs by outperforming traditional metal board and post chevron signs.

Chevroflex Ultra chevron boards are passively safe to BS EN 12767 for roundabouts and highlighting hazards on rural roads. Manufactured with Impactaflex™ material, they offer superior rigidity and resilience combined with class-leading recovery performance after a drive-through collision.



## Chevroflex Ultra™ Sign System

### DESIGN FEATURES

- Certified passively safe to Performance Standard NE3/100.
- Highly visible wall effect - offers a clear indication ahead of a bend or hazard in the road.
- Easy to install socket for quick and simple sign replacement.
- Three standard sizes of chevron - 400mm, 600mm or 800mm.
- Modular socket design allows for unlimited number of chevrons.
- Available as left-hand bend, right-hand bend, a roundabout unit with a statute-compliant 606 signface or a sight screen.
- Available with or without high-visibility border.
- AutoCAD model specifications available for all products.

### MATERIAL AND COLOUR OPTIONS

- Uprights: Impactaflex™ material
- Socket: Galvanised steel
- Uprights: Black.
- Hi-Vis surround: Yellow or Yellow/Green





**1** Specify the size of your chevrons and the number of chevrons.

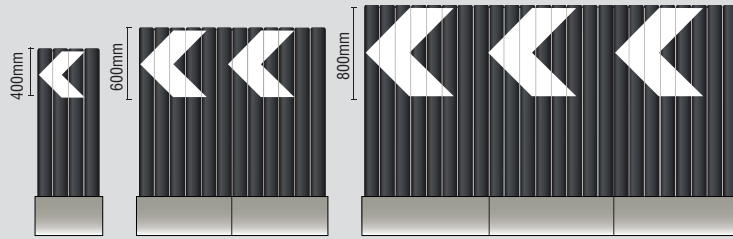

**2** Specify the configuration of your chevrons - left hand bend, right hand bend, roundabout (with statute-compliant 606 sign face)

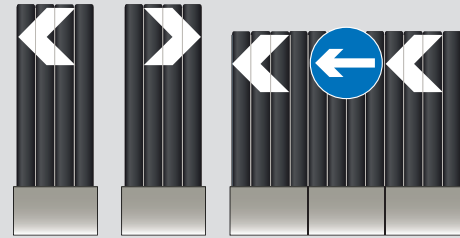

left hand bend

right hand bend

roundabout (with statute-compliant 606 sign face)

**3** Choose with or without high visibility border -

Chevroflex Ultra with Hi-Vis surround is available with two different coloured borders, yellow/green and yellow. Made in Avery Dennison fluorescent Diamond Grade material, it is highly visible and reflective from a distance.\*

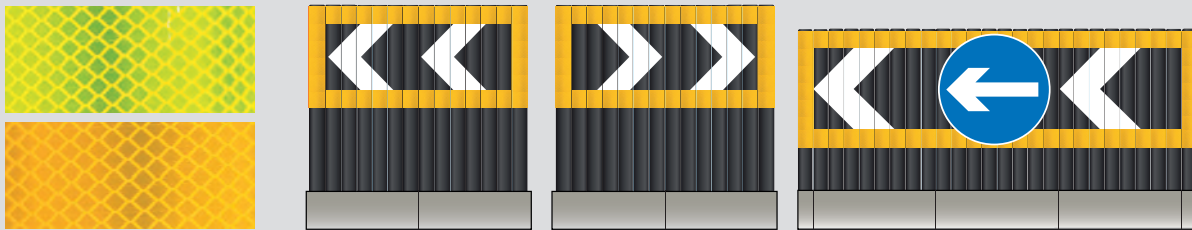

\*All retroreflective materials supplied by Glasdon UK are as recommended in table NA1 of the National Annex of BS EN 12899-1:2007 Fixed Vertical Road Signs.

**4** For roundabouts choose 606 directional arrows.

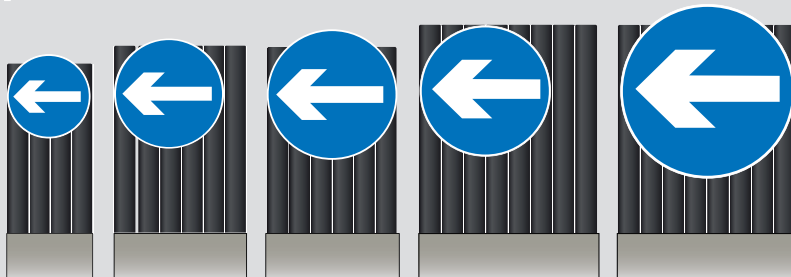

600mm 606 for use on 400mm roundabouts

750mm 606 for use on 600mm roundabouts

900mm 606 for use on 600mm roundabouts

900mm 606 for use on 800mm roundabouts

1200mm 606 for use on 800mm roundabouts

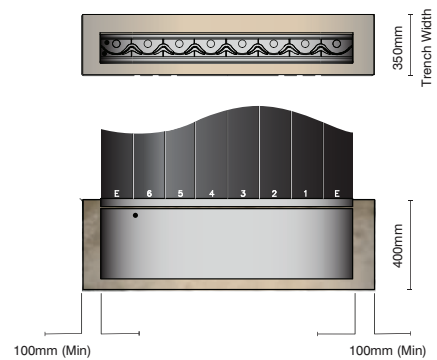

**FIXING**

The trench for the sockets should be 400mm deep, 350mm wide and 200mm longer than the overall length of the Chevroflex Ultra Sign.

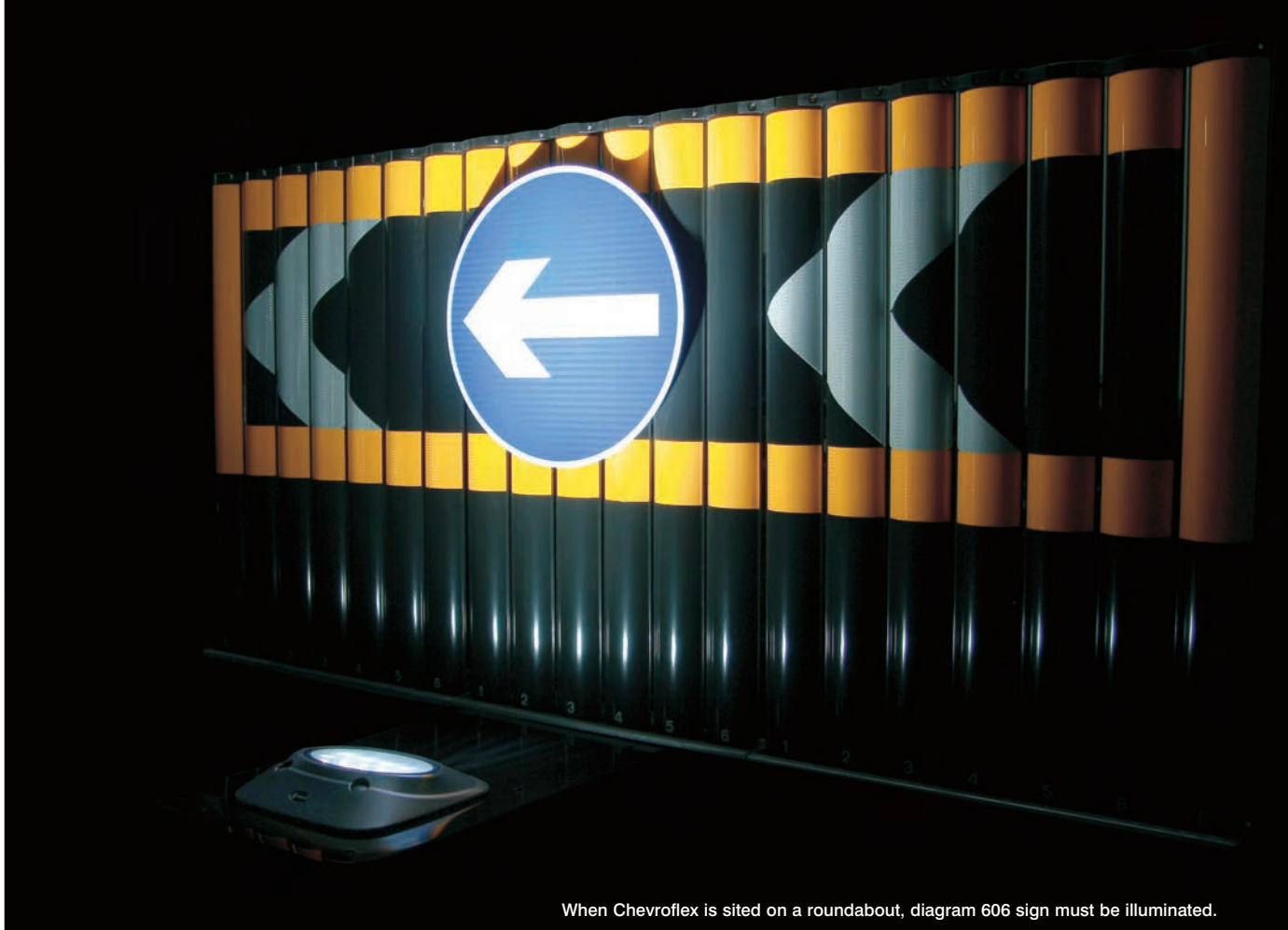

When Chevreflex is sited on a roundabout, diagram 606 sign must be illuminated.

## Sublite Lumino™ Led Uplighter

### DESIGN FEATURES

- Flush ground uplighter removes the potential impact hazard created by a traditional post-mounted downlighter.
- Low energy and low maintenance - only 11w power consumption.
- Highly resilient: 100% recycled Durapol® material IP67 rated.
- Versatile: Hinged LED plate allows adjustment after installation.
- Designed to withstand accidental drive-over.

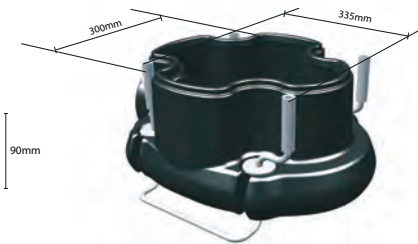

# Road Safety Vergeposts

Glasdon hazard marker posts are ideal delineators for highlighting road layouts in urban traffic environments and bends on rural or trunk roads.

The Vergemaster RX™ Marker Post, is a passively safe verge marker with a wide-angle reflector and a range of fixing options to suit any terrain. For urban environments, the heavy duty, passively safe Hazardmaster™ Marker Post is robustly designed to withstand repeated wheel-over collisions.



## Vergemaster RX™ Marker Post

### DESIGN FEATURES

- Passively safe Reflexapol™ material construction.
- Extended base fixing model successfully tested to Performance Standard NE4/100 by TRL.
- Two arced microprismatic Impactalight™ material reflectors increase reflective performance and viewing angles for clear delineation by day and night.

### SPECIFICATIONS

Height above ground:	920mm
(extended base/stake type)	886mm
(bolt-down):	167mm
Maximum diameter:	350mm
Extended base depth below ground:	523mm
Stake type depth below ground:	100mm
Bolt-down depth below ground:	320mm
Adjustable depth concrete-in anchors	
depth below ground:	

\*Below Ground Extended Base model only.



## MATERIAL OPTIONS

Marker post: Reflexapol™ material

Fixing stake: Pressure-treated timber

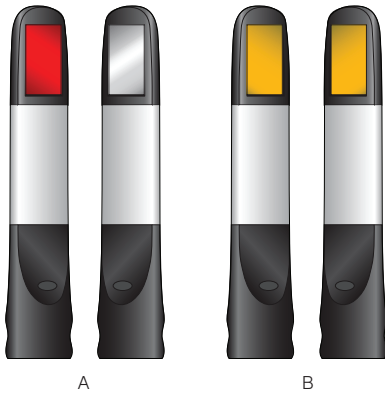

A

B

## VERGEMASTER REFLECTOR OPTIONS

A. Red & White

B. Amber & Amber

\*All retroreflective materials meet the requirements in table NA1 of BS EN 12899-1:2007 Fixed Vertical Road Signs.

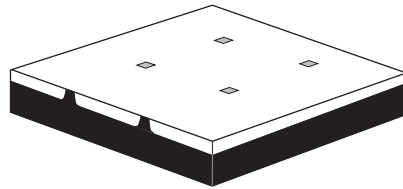

## MOULDED-IN WHITE BAND SECTION OF MATERIAL

Integral white bands fused to the post with heat and compression.

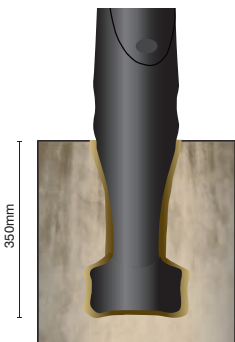

Below Ground  
Extended Base

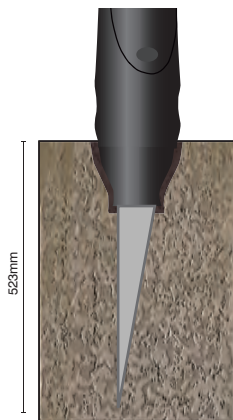

Below Ground Stake Type

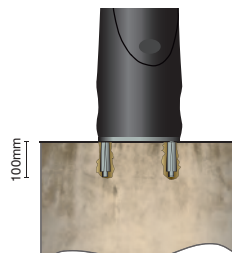

Bolt-Down fixing

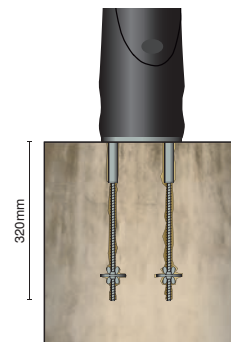

Adjustable depth  
concrete-in anchors

## FIXING OPTIONS

Below Ground Extended Base, Below Ground Stake Type, Bolt-Down fixing, Adjustable depth concrete-in anchors





## Flexmaster™ Marker Post

### DESIGN FEATURES

- Manufactured from highly durable Ultraflex™ material that will withstand multiple vehicle impacts.
- White band and reflector provide maximum visibility.
- Standard fixing can be installed in soft ground without the need for excavation. Advanced fixing provides a socket that allows the post to be easily removed and reinstated without ground works.
- Offers infinite possibilities for low-maintenance, high-visibility signage.

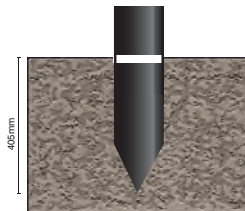

Standard Fixing Option

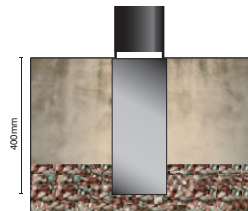

Advanced Fixing Option (socketed)

### FIXING OPTIONS

- Standard Fixing Option
- Advanced Fixing Option (socketed)

### SPECIFICATIONS

- Height above ground: 905mm
- Height above ground layby variant: 600mm, 500mm or 480mm
- Width: 150mm
- Standard fixing depth below ground: 405mm
- Advanced fixing depth below ground: 400mm

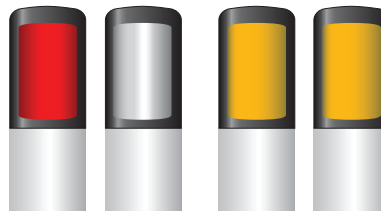

Red & White

Amber & Amber

### FLEXMASTER REFLECTOR OPTIONS

\*All retroreflective materials meet the requirements in table NA1 of BS EN 12899-1:2007 Fixed Vertical Road Signs.

### MATERIAL OPTIONS

- Marker post: Ultraflex™ material.
- Advanced socket fixing: Galvanised steel.



### OTHER APPLICATIONS

The versatility of the Flexmaster system offers infinite possibilities for low maintenance, high visibility signage.

To discuss your requirements please telephone our highways safety sales team on 01253 600411



## Hazardmaster™ Marker Post

### DESIGN FEATURES

- Passively safe Impactapol® material construction for the highest risk areas.
- Successfully tested to Performance Standard NE4/100 by TRL.
- Substantial, robust marker post.
- Two large retroreflectors provide maximum visibility.

### SPECIFICATIONS

Height above ground: 910mm  
 Maximum diameter: 150mm  
 Depth below ground: 300mm

### MATERIAL OPTIONS

Marker post: Impactapol material

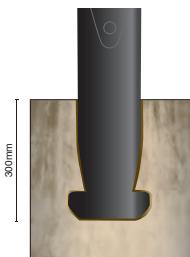

Below Ground  
Extended Base

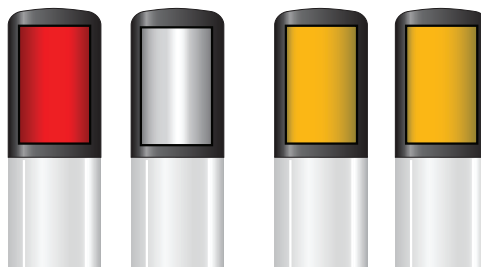

Red & White

Amber & Amber

### HAZARDMASTER REFLECTOR OPTIONS

\*All retroreflective materials meet the requirements in table NA1 of BS EN 12899-1:2007 Fixed Vertical Road Signs.



### FIXING OPTIONS

Below Ground Extended Base.



## Edgeline™ Bollard

### DESIGN FEATURES

- Available as a self-righting Rebound bollard or rigid Durapol® material model.
- Recessed area for decorative or retroreflective banding (due to the low height of the bollard this is not approved for highways use).
- Co-ordinates with Neopolitan™ Bollards.

### SPECIFICATIONS

Height above ground: 510mm  
 Maximum diameter: 140mm  
 Depth below ground: 276mm

### MATERIAL AND COLOUR OPTIONS

Rigid Bollard: Durapol material in Black, White, Millstone, Sandstone, Granite.  
 Rebound Bollard: Impactapol® material in Black.



Black

White



Millstone



Sandstone



Granite

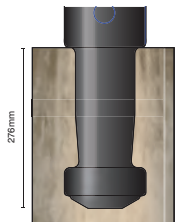

Below Ground  
Extended Base

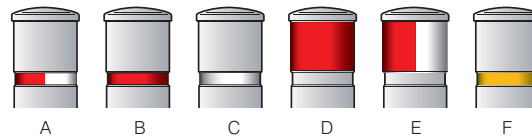

### OPTIONAL BANDING

- A. 1 x 19mm Red/White retroreflective band.\*
- B. 1 x 19mm Red retroreflective band.\*
- C. 1 x 19mm White retroreflective band.\*
- D. 1 x 98mm Red or White retroreflective band.\*
- E. 1 x 98mm Rebound Red/White HIP band.\*
- F. 1 x 19mm Gold decorative band.

### FIXING OPTIONS

Below Ground  
Extended Base.

\*All retroreflective materials meet the requirements in table NA1 of BS EN 12899-1:2007 Fixed Vertical Road Signs.







## Edgemaster™ 20 Post

### DESIGN FEATURES

- Recessed area for decorative or retroreflective banding (due to the low height of the post this is not approved for highways use).
- Ground level marker ensures the bollard is installed correctly.

### SPECIFICATIONS

Height above ground: 490mm  
 Maximum diameter: 105mm  
 Depth below ground: 340mm

### MATERIAL AND COLOUR OPTIONS

Post: Durapol® material in White.



White

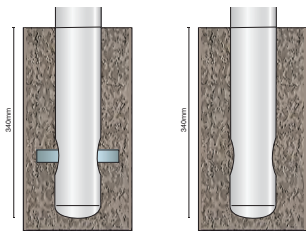

Below Ground Extended Base with optional ground fixing peg

Below Ground Extended Base without ground fixing peg

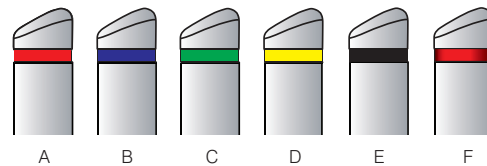

### OPTIONAL BANDING

- 1 x 20mm Red decorative band.
- 1 x 20mm Blue decorative band.
- 1 x 20mm Green decorative band.
- 1 x 20mm Amber decorative band.
- 1 x 20mm Black decorative band.
- 1 x 20mm Red retroreflective band.\*

\*All retroreflective materials meet the requirements in table NA1 of BS EN 12899-1:2007 Fixed Vertical Road Signs.

### FIXING OPTIONS

Below Ground Extended Base with optional ground fixing peg, Below Ground Extended Base without ground fixing peg





## Glenwood™ 150 Post

### DESIGN FEATURES

- Manufactured from Everwood™ material, which has a unique realistic timber grain effect.
- Lightweight and easy to install.
- Moulded-in saw grooves enable the post to be easily cut down to the desired height. Height options are 1000mm, 830mm and 500mm.
- Recessed area for retroreflective banding.
- 100mm vandal-resistant signfaces.

### SPECIFICATIONS

Height above ground: 500mm, 830mm or 1000mm  
 Width: 150mm  
 Depth below ground: 450mm to 650mm

### MATERIAL AND COLOUR OPTIONS

Post: Everwood material in White, Light Oak, Dark Oak.

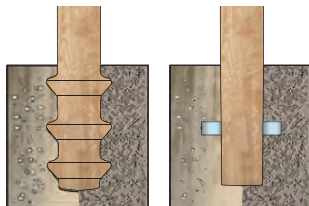

Below Ground  
Extended Base

Below Ground with  
Fixing Peg

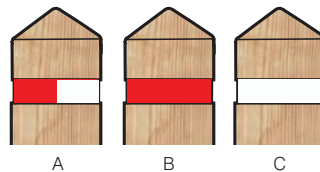

### OPTIONAL BANDING

- A. 1 x 37mm Red/White retroreflective band\*  
 B. 1 x 37mm Red retroreflective band\*  
 C. 1 x 37mm White retroreflective band\*

\*All retroreflective materials meet the requirements in table NA1 of BS EN 12899-1:2007 Fixed Vertical Road Signs.



Ref 955



Ref 956



Ref 957



Ref 957 Reversed

### OPTIONAL STANDARD SIGNFACES\*

\*Other non-standard signfaces are available, please contact our sales office for information.





## Glenwood™ 170 Post & Glenwood™ 170 Signhead Post

### DESIGN FEATURES

- Two models available - Glenwood 170 Post and Glenwood 170 Signhead Post for displaying 150mm signs on all four sides.
- Manufactured from Everwood™ Material, which has a unique realistic timber grain effect.
- Lightweight and easy to install.
- Recessed area for retroreflective banding.
- 150mm vandal-resistant signfaces.

### SPECIFICATIONS

Height above ground (Glenwood 170 Post):	1000mm
(Glenwood 170 Signhead Post):	1093mm
Width: 170mm	
Socketed depth below ground:	355mm
Extended base depth below ground:	315mm

### MATERIAL AND COLOUR OPTIONS

Post: Everwood material in Light Oak, Dark Oak.  
Glenwood socket: Durapol® material.



### FIXING OPTIONS

Glenwood Socket  
Below Ground Extended Base

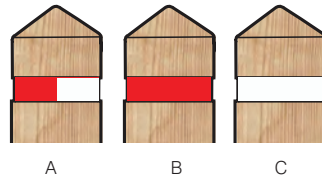

### OPTIONAL BANDING

- A. 1 x 37mm Red/White retroreflective band\*
- B. 1 x 37mm Red retroreflective band\*
- C. 1 x 37mm White retroreflective band\*

\*All retroreflective materials supplied by Glasdon UK are as recommended in table NA1 of the National Annex of BS EN 12899-1:2007 Fixed Vertical Road Signs.

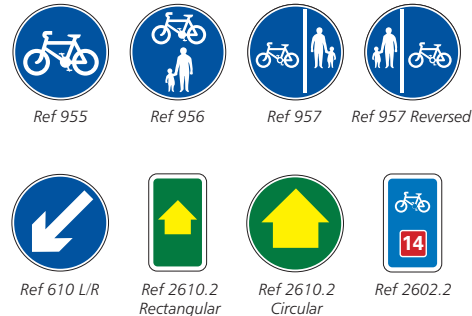

### OPTIONAL STANDARD SIGNFACES\*

\*Other non-standard signfaces are available, please contact our sales office for information.



# Gateway Sign Carriers

Unlike recycled PVC units on the market, the Glasdon Gateway is integrally strong – no need for dangerous steel reinforcing poles.

We've been working with county councils and highway contractors all over the UK to supply personalised entrance features for villages, communities and parish councils.



## ■ Glasdon Gateway

### DESIGN FEATURES

- A low maintenance, long-lasting alternative to traditional wooden sign carriers.
- Hundreds of combinations of designs with various colours, slats, widths and heights available - contact us for more information.
- 600mm speed limit signs are available as a standard kit for the Glasdon Gateway. Signs include National Speed Limit, 30MPH, 40MPH and 50MPH.

### SPECIFICATIONS

Height:	1800mm (1300mm above ground) or 2300mm (1800mm above ground).
Ornate model height:	2300mm
Width:	960mm, 1500mm, 2000mm.
Ornate model width:	1690mm
Post Width:	160mm

### MATERIAL AND COLOUR OPTIONS

Posts/slats: Everwood™ Material in White, Light Oak, Dark Oak.  
 Fixing bolts: Stainless steel.  
 Sufave mount bracket: 5mm Galvanised mild steel.

# Gateway Sign Carriers



**1 Specify the colour:**  
 Light Oak or Dark Oak for a wood effect, or white for maximum visibility.

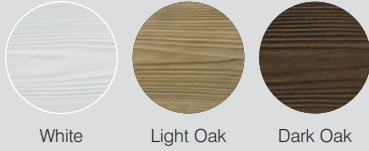

White Light Oak Dark Oak

**2 Specify the width -**  
 Standard options 960mm, 1500mm or 2000mm.

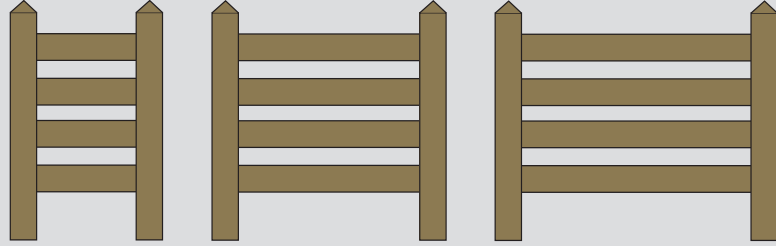

Width: 960mm, 1500mm or 2000mm  
 Ornate model width: 1690mm

**3 Specify how many slats:**  
 We can supply Glasdon Gateway with between one and four slats, with an optional crossbar for a traditional farm gate appearance.

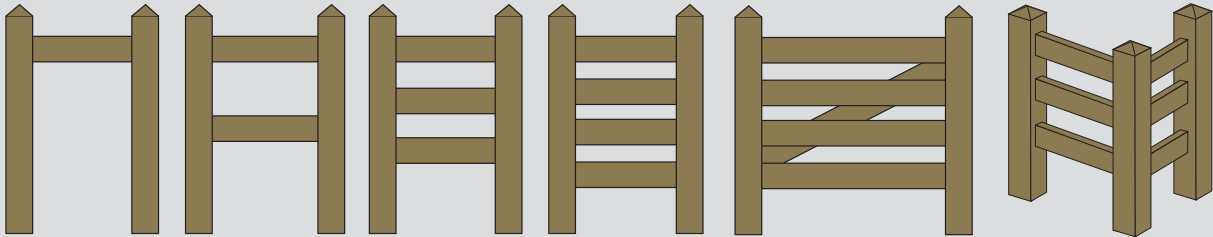

Number of Slats: Available with 1, 2, 3 or 4 slats.

Crossbar: Creates a traditional farm gate appearance.

L-Shaped: For a striking visual impact.

**4 Choose a height:** Standard options are 1800mm (1300mm above ground) or 2300mm (1800mm above ground)  
 Ornate model height: 2300mm

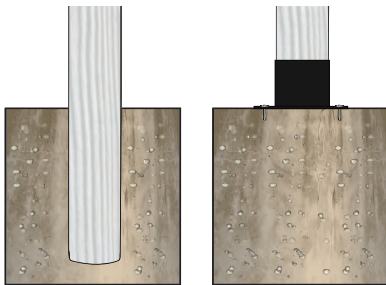

Below Ground  
 Extended Base

Surface Mount Kit

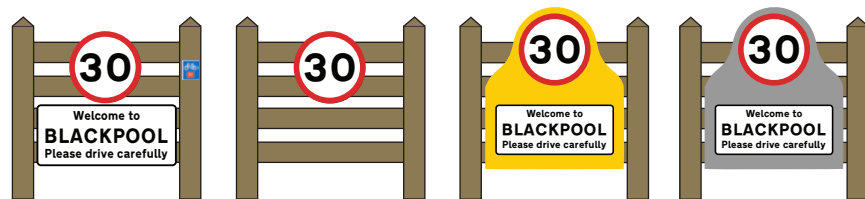

**EXAMPLE SIGNAGE OPTIONS**

Glasdon Gateway is supplied flat pack with comprehensive instructions for easy assembly. Attaching your existing signage to the product is a simple job, or we can supply a sign made to your specification. If you're not sure about the dimensions of Gateway you need, we can recommend the right size based on the measurements of the sign you want to display - contact us for more information.

**FIXING OPTIONS**

- Below Ground Extended Base
- Surface Mount Kit

# Other Road Safety Products



Pooling water can be dangerous to road users and the standing water can penetrate the road structure, causing severe damage, particularly on rural roads where there are generally fewer drains. In freezing conditions ice is created and expands creating cracks and pot holes in the road surface. Pot holes can create a major hazard and are very time consuming and costly to repair.

The Drainagemaster™ Drainage Grip is a lightweight, moulded highway drainage product that offers a more efficient solution to draining water from the road's surface.





## Drainagemaster™ Drainage Grip

### DESIGN FEATURES

- Efficiently channels running and pooling water from rural road surfaces into a parallel drainage ditch.
- Robust side ridges allow vehicles to drive over the unit without damage.
- Quick and easy to install.
- Requires minimal maintenance - the wide, smooth surface discourages the build-up of debris and is easily cleared with a shovel or brush.
- Reflective patches are available so the unit can be easily located for maintenance checks.
- An extension channel is also available.
- For quantities over 5 please contact our sales office for the best prices.

### SPECIFICATIONS

Width: 762mm Depth: 900mm Maximum height: 155mm

### MATERIAL OPTIONS

Drainagemaster: Durapol® material Ground pegs: Polypropylene.



# Fixing Options & Materials

With a choice of up to seven different fixing methods, there is sure to be one that is right for your application.

Our highways safety products are made from a range of high performance materials and undergo stringent checks to ensure durability and best value.

Glasdon has ISO9001:2015 and ISO4001:2015 accreditation, which underlines our commitment to quality.

# LockFast™ Socket System

The LockFast™ Socket System is the first Glasdon socket compatible with passively safe Impactapol® material bollards. The square shape prevents twisting during an impact and is easy to pave around. Bollards are quick and easy to remove and replace, making them ideal for permanent, semi-permanent, or temporary applications. The socket will absorb the impact of most collisions, leaving the surrounding surfaces undamaged.

## SAFETY NOTICE:

If the removal of a bollard creates a safety hazard, we strongly recommend the purchase of a socket blanking cap, which features a slip resistant finish.

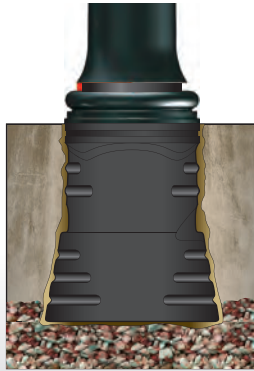

NEW Glenwood™ Socket System also available for the Glenwood™ 170 Post & Glenwood™ 170 Signhead Post.

Locking Blanking Cap



Temporary Blanking Cap

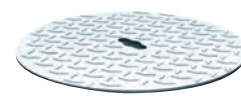

Moulded-in product code aids correct bollard top replacement.

Square shape prevents twisting during a drive through and is easy to pave around.

Moulded-in arrow and logo aids correct installation.

Made from Durapol® material, a proven corrosion-resistant and impact-resistant material and fully recyclable after its long service life.

Anchor points help to prevent uprooting.

Flat base - much easier to level.



Galvanised mild steel blanking plate removes trip hazard and aids installation.



Only 350mm deep for quicker installation.

The first Glasdon socketed bollard proven passively safe to Performance Standard NE4/100.



**PASSED**  
at 100 Km/h  
(62mph) ✓

## Standard Socket System

Glasdon socketed bollards are quick and easy to remove and replace, making them ideal for permanent, semi-permanent, or temporary applications. The socket will absorb the impact of most collisions, leaving the surrounding surfaces undamaged.

**SAFETY NOTICE:**

If the removal of a bollard creates a safety hazard, we strongly recommend the purchase of a socket blanking cap, which features a slip resistant finish.

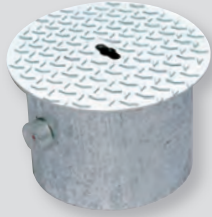

Locking Blanking Cap



## Below-Ground Extended Base

The extended base and horizontal ground fixing peg of the bollard are secured in concrete for permanent installation.

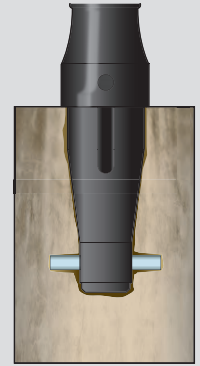

## Bolt-Down Fixing

Bolt-down fixings allow a bollard to be installed in under 8 minutes on existing concrete sub-surfaces. This provides a permanent fixing point with a flush ground finish which eliminates trip hazards if the bollard is removed. Bolt-down fixing is ideal for use where a below-ground installation is restricted or impossible.



## Fixed Depth Concrete-in Anchors

The two-piece fixed depth concrete-in anchors are suitable for a fresh concrete sub-surface, providing additional anchorage and a permanent fixing point. Available with Durapol® material and Impactapol® material bollards. For use in a minimum depth of 250mm.

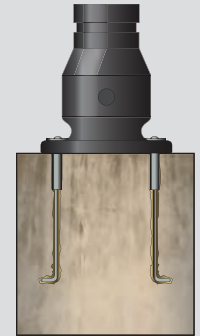

## Adjustable Depth Concrete-in Anchors

For additional anchorage and to provide a permanent fixing point use bolt-down fixings with adjustable depth concrete in anchors. Adjustable depth concrete-in anchors can be used anywhere a fresh concrete sub-surface can be laid, creating a flush ground finish which eliminates trip hazards if the bollard is removed.

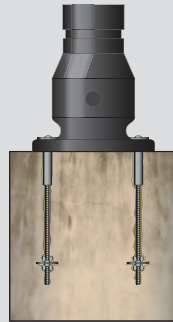

## Bridgemaster™ Fixing

Ideal for bridges, this fixing can be used where there is an insufficient depth for a socketed bollard, or when there is not a suitable concrete surface/area to bolt-down.

A galvanised steel reinforcing tube extends 300mm below ground level, providing an integral root for superb strength and anchorage.

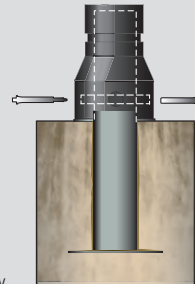

## Guardzman™ Anti-Ram Raid Bollard Fixing

A galvanised steel reinforcing tube extends 745mm below ground level, providing an integral root for superb strength and impact resistance. This tube is then filled with concrete. The bollard top is securely attached with hidden coupling bolts. Guardsman bollards are an excellent security feature and have been shown in tests to stop an unladen van dead at speeds of up to 30mph.



## High Performance Materials

Glasdon bollards are manufactured from a range of high performance materials and undergo stringent checks to ensure durability and best value. Glasdon has ISO 9001:2015 and ISO 14001:2015 accreditation, underlining our commitment to quality.

### Durapol® Material

A strong, lightweight material that offers a number of advantages over traditional materials. Durapol material is self coloured, which means it will never need painting and scratches will not show. The material is totally corrosion-free so it will not chip or rust, and is vandal resistant.



Durapol Material



Other Material

### Passively Safe Impactapol® Material

A flexible material with excellent recovery performance, meaning it will return to its original shape following a drive-through collision. Impactapol material products reduce maintenance budgets in vulnerable locations by continuing to perform to statutory requirements even after repeated impacts. Impactapol material offers all the additional benefits of Durapol material – it is self-coloured and totally corrosion-free.



Impactapol Material



Other Material

Impactaflex™ material has been specially developed by Glasdon to provide new Chevreflex Ultra with superior rigidity and resilience, and offers exceptional recovery performance after a drive-through collision. *(Chevreflex Ultra see page 31-33)*

Reflexapol™ polymer is specially engineered for long service life in exposed locations. It has good recovery properties and will never need painting. *(Vergemaster RX see page 36-37)*

Ultraflex™ polymer is formulated to withstand harsh environments and has enhanced flexibility and extensibility properties offering good recovery performance after vehicular impact. *(Flexmaster see page 38)*

Enviropol® recycled plastic material is manufactured predominantly from post-consumer plastics. By balancing these uncontaminated recycled waste materials, the result is a remarkably versatile product with many applications and benefits. Enviropol material will not chip or rust, is easy to clean and never needs painting. *(Enviropol see page 30)*



Buffer™ Bollard is manufactured from 100% recycled rubber tyres and is pressure moulded to create a strong, hard-wearing, weatherproof material. *(Buffer see page 29)*



Everwood™ material is a realistic timber grain polymer, which requires minimal maintenance. Everwood is vandal and weather resistant, will not rot, warp or crack. *(Glasdon Gateway and Glenwood see page 42-47)*

# Photo Gallery

Our customers often approach us to help solve unique problems, and we are always happy to help. Have a look at some of our road safety products at work.

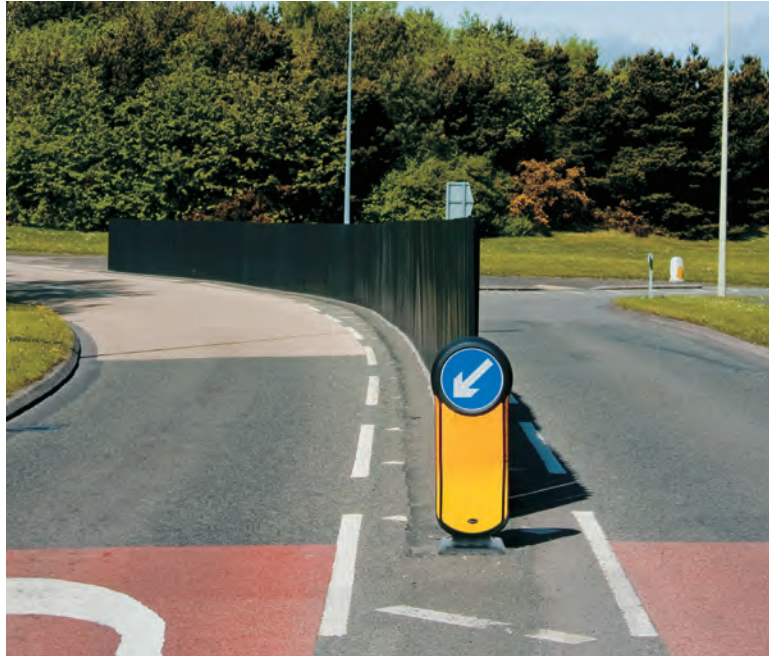
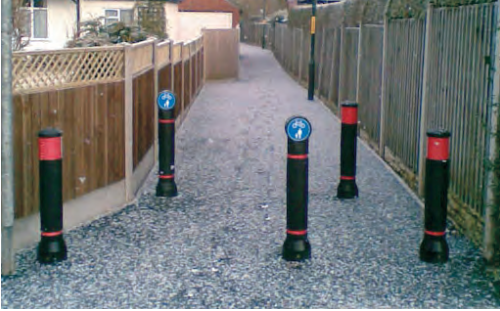













**Cyclmaster™ Bollard**  
A high visibility cycle route marking bollard for displaying signs on the front and rear.

Need Help? Find the most popular product for **YOUR** industry.

Industries

Indoor Litter Bins / Outdoor Litter Bins



Indoor Recycling Bins / Outdoor Recycling Bins



**Free Delivery**

\*within mainland UK and Northern Ireland

EXCELLENT SERVICE



5.0/5.0 - 80 ratings

Jul. 2019 Verified by LiveChat

[www.glasdon.com](http://www.glasdon.com)

Visit our website to see our full range of Passively Safe products. Downloadable product literature, case studies and video clips are also available. Model specifications are available on all products in PDF, .DWG (Auto CAD) or .DXF formats.



**Glasdon U.K. Limited**

Local Government Highways Division  
Preston New Road  
BLACKPOOL  
Lancashire  
FY4 4UL

Tel: (01253) 600411

Fax: (01253) 792558

E-mail: [hs@glasdon-uk.co.uk](mailto:hs@glasdon-uk.co.uk)

Web: [www.glasdon.com](http://www.glasdon.com)

**Glasdon**, Admiral, Advanced Neopolitan, Bridgemaster, Buffer, Chevrolflex Ultra, Cyclmaster, Drainagemaster, Durapol, Edgeliner, Edgemaster, Ensign, Enviro-pol, Everwood, Flexmaster, Glasdon Manchester, Glenwood, Guardsman, Hazardmaster, Impactflex, Impactlight, Impactpol, Infomaster, Jubilee, LockFast, Mini Ensign, Neopolitan, Reflexapol, Sublite Lumino, Ultraflex, Vergemaster RX and Victory are trademarks or registered trademarks of GLASDON Group or its subsidiaries in the UK and other countries.



Certificate Number 16750  
ISO9001, ISO14001, ISO45001