

VERSAILLES



EST. 1959

ELITE
LEATHER
COMPANY

VERSAILLES|122

STANDARD FEATURES:

LOOSE SEAT CUSHION AND BACK
PILLOW

HIGH DENSITY FOAM SEATS

WOOD LEGS AVAILABLE ON FINISH:

NATURAL
WALNUT
JAVA
FRENCH GREY
COFFEE BEAN
BLACK
ASH

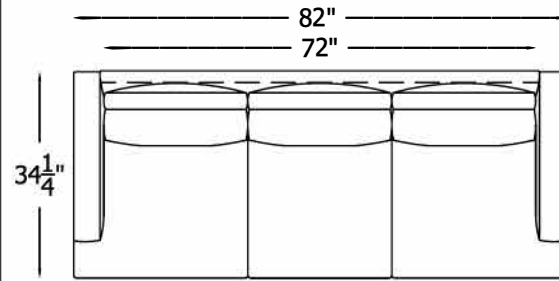
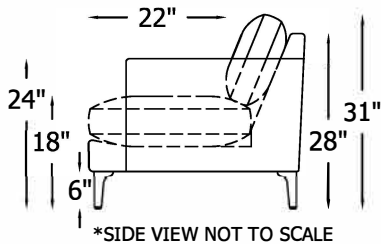
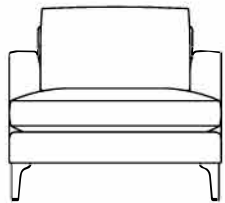

F184-122-1 (FABRIC)
L184-122-1 (LEATHER)
SOFA

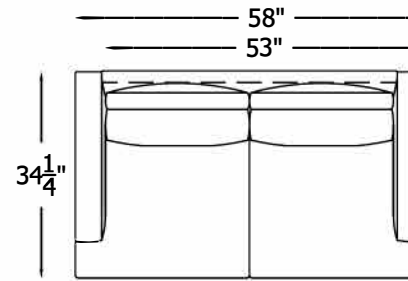

F160-122-1 (FABRIC)
L160-122-1 (LEATHER)
LOVESEAT

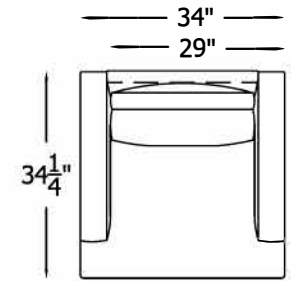

F114-122-1 (FABRIC)
L114-122-1 (LEATHER)
CHAIR

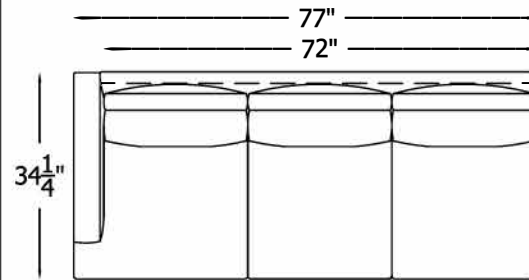

F176-122L-1 (FABRIC)
L176-122L-1 (LEATHER)
LEFT ARM SOFA (*AVAILABLE AS A RIGHT)

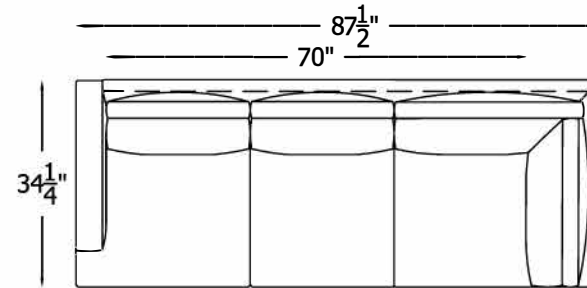

F183-122L-1 (FABRIC)
L183-122L-1 (LEATHER)
LEFT ARM SOFA W/RETURN (*AVAILABLE AS A RIGHT)

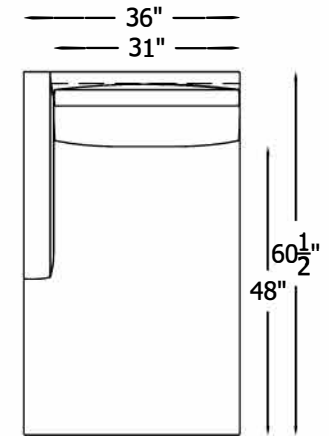

F146-122L-1 (FABRIC)
L146-122L-1 (LEATHER)
LEFT ARM CHAISE (*AVAILABLE AS A RIGHT)

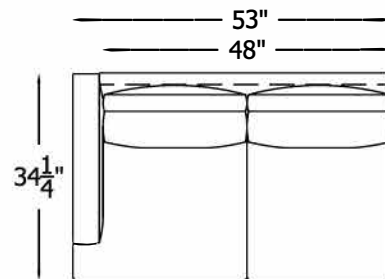

F156-122L-1 (FABRIC)
L156-122L-1 (LEATHER)
LEFT ARM LOVESEAT (*AVAILABLE AS A
RIGHT)

EST. 1959

ELITE LEATHER COMPANY

SCALE: 3/8" = 1'-0". L OR R REFER TO LEFT- OR RIGHT- FACING, AS DETERMINED BY FACING THE PIECE.

ELITE LEATHER COMPANY RESERVES THE RIGHT TO CHANGE DIMENSIONS AND PRODUCTS OFFERED. A MORE RECENT SCHEMATIC MAY BE AVAILABLE FOR THIS COLLECTION. TO SEE THE MOST CURRENT SCHEMATIC AVAILABLE, VISIT WWW.ELITELEATHER.COM.

THIS SCHEMATIC IS CURRENT AS OF 08/2017