

ASTON ROW

DATED: May 6, 2015

Developer:

Algra Bros. Developments (Lynn) Ltd.
and **Lynn Joint Venture**

Address for Service:
c/o 33832 South Fraser Way
Abbotsford, B.C.
V2S 2C5

Business Address:
5848 Sappers Way
Chilliwack, B.C.
V2R 0G7

Agent:
Shantell Owens / Sutton Showplace Realty
5848 Sappers Way
Chilliwack, B.C.
V2R 0G7
Phone: (604) 798-6169
Fax: (604) 769-4091
team@algrabros.com

This Disclosure Statement has been filed with the Superintendent of Real Estate, but neither the Superintendent, nor any other authority of the government of the Province of British Columbia, has determined the merits of any statement contained in the Disclosure Statement, or whether the Disclosure Statement contains a misrepresentation or otherwise fails to comply with the requirements of the Real Estate Development Marketing Act. It is the responsibility of the developer to disclose plainly all material facts, without misrepresentation.

This Disclosure Statement relates to a development property that is not yet completed. Please refer to section 7.2 for information on the purchase agreement. That information has been drawn to the attention of _____ and _____ who have confirmed that fact by initialling in the space provided here:

--	--

This is a Phase Disclosure Statement filed pursuant to the *Real Estate Development Marketing Act*.

RIGHT OF RESCISSION

Under Section 21 of the *Real Estate Development Marketing Act*, the purchaser or lessee of a development unit may rescind (cancel) the contract of purchase and sale or contract to lease by serving written notice on the developer or the developer's brokerage, within 7 days after the later of the date the contract was entered into or the date the purchaser or lessee received a copy of the Disclosure Statement.

A purchaser may serve a notice of rescission by delivering a signed copy of the notice in person or by registered mail to:

- (a) the developer at the address shown in the disclosure statement received by the purchaser;
- (b) the developer at the address shown in the purchaser's purchase agreement;
- (c) the developer's brokerage, if any, at the address shown in the disclosure statement received by the purchaser; or
- (d) the developer's brokerage, if any, at the address shown in the purchaser's purchase agreement.

The developer must promptly place purchasers' deposits with a brokerage, lawyer or notary public who must place the deposits in a trust account in a savings institution in British Columbia. If a purchaser rescinds their purchase agreement in accordance with the Act and regulations, the developer or the developer's trustee must promptly return the deposit to the purchaser.

**Policy Statement 5
Early Marketing – Development Approval**

- a. The estimated date, as disclosed in the disclosure statement, for the issuance of a building permit, is 9 months or less from the date the developer filed the disclosure statement with the superintendent;
- b. The developer markets the proposed development units under the disclosure statement for a period of no more than 9 months from the date the disclosure statement was filed with the superintendent, unless an amendment to the disclosure statement that sets out particulars of the issued building permit is filed with the superintendent during that period. The developer must also either:
 - (i) prior to the expiry of the 9 month period, file with the superintendent an amendment to the disclosure statement that sets out particulars of the issued building permit; or
 - (ii) upon the expiry of the 9 month period, immediately cease marketing the development and confirm in a written undertaking to the superintendent that all marketing of the development has ceased and will not resume until after the necessary amendment has been filed, failing which a cease marketing or other order may be issued by the superintendent to the developer without further notice.

Additionally, the developer must provide written notice without delay to the superintendent if, during the 9 month period, all units in the development property being marketed under this Policy Statement are sold or the developer has decided not to proceed with the development.

- c. Any purchase agreement used by the developer, with respect to any development unit offered for sale or lease before the purchaser's receipt of an amendment to the disclosure statement that sets out particulars of the issued building permit, contains the following provisions:
 - (i) The purchaser may cancel the purchase agreement for a period of seven days after receipt of an amendment to the disclosure statement that sets out particulars of the issued building permit if the layout or size of the applicable development unit, the construction of a major common facility, including a recreation centre or clubhouse, or the general layout of the development, is materially changed by the issuance of the building permit;
 - (ii) If an amendment to the disclosure statement that sets out particulars of an issued building permit is not received by the purchaser within 12 months after the initial disclosure statement was filed, the purchaser may at his or her option cancel the purchase agreement at any time after the end of that 12 month period until the required amendment is received by the purchaser, at which time the purchaser may cancel the purchase agreement for a period of seven days after receipt of that amendment only if the layout or size of the applicable development unit, the construction of a major common facility, including a recreation centre or clubhouse, or the general layout of the development, is materially changed by the issuance of the building permit;
 - (iii) The amount of the deposit to be paid by a purchaser who has not yet received an amendment to the disclosure statement that sets out particulars of an issued building permit is no more than 10% of the purchase price; and
 - (iv) All deposits paid by a purchaser, including interest earned if applicable, will be returned promptly to the purchaser upon notice of cancellation from the purchaser.

**POLICY STATEMENT 6
ADEQUATE ARRANGEMENTS – UTILITIES AND SERVICES**

- a. The estimated date for obtaining a satisfactory financing commitment, as disclosed in the disclosure statement, is 9 months or less from the date the developer filed the disclosure statement with the superintendent;
- b. The developer markets the proposed development units under the disclosure statement for a period of no more than 9 months from the date the disclosure statement was filed with the superintendent, unless an amendment to the disclosure statement that sets out particulars of a satisfactory financing commitment is filed with the superintendent during that period. The developer must also either:
 - (i) prior to the expiry of the 9 month period, file with the superintendent an amendment to the disclosure statement that sets out particulars of a satisfactory financing commitment; or
 - (ii) upon the expiry of the 9 month period, immediately cease marketing the development and confirm in a written undertaking to the superintendent that all marketing of the development has ceased and will not resume until after the necessary amendment has been filed, failing which a cease marketing or other order may be issued by the superintendent to the developer without further notice.

Additionally, the developer must provide written notice without delay to the superintendent if, during the 9 month period, all units in the development property being marketed under this Policy Statement are sold or the Developer has decided not to proceed with the development.

- c. Any purchase agreement used by the developer, with respect to any development unit offered for sale or lease before the purchaser's receipt of an amendment to the disclosure statement that sets out particulars of a satisfactory financing commitment, contains the following terms:
 - (i) If an amendment to the disclosure statement that sets out particulars of a satisfactory financing commitment is not received by the purchaser within 12 months after the initial disclosure statement was filed, the purchaser may at his or her option cancel the purchase agreement at any time after the end of that 12 month period until the required amendment is received by the purchaser;
 - (ii) The amount of the deposit to be paid by a purchaser who has not yet received an amendment to the disclosure statement that sets out particulars of a satisfactory financing commitment is no more than 10% of the purchase price; and
 - (iii) All deposits paid by a purchaser, including interest earned if applicable, will be returned promptly to the purchaser upon notice of cancellation from the purchaser.

DISCLOSURE STATEMENT INDEX

Right of Rescission.....	2
Early Marketing – Development Approval (Policy Statement 5).....	3
Adequate Arrangements – Utilities and Services (Policy Statement 6).....	4
Exhibit List	5
1. The Developer.....	7
2. General Description	9
General Description of Development.....	9
Permitted Use.....	10
Phasing.....	10
3. Strata Information	11
Unit Entitlement	11
Voting.....	11
Common Property & Facilities.....	11
Limited Common Property	11
Bylaws.....	11
Parking.....	13
Furnishings & Equipment.....	14
Budget.....	14
Utilities & Services.....	15
Strata Management Contracts	15
Insurance	15
Rental Disclosure Statement.....	16
4. Title and Legal Matters.....	16
Legal Description.....	16
Ownership.....	16
Existing Encumbrances & Legal Notations.....	17
Proposed Encumbrances.....	17
Outstanding or Contingent Litigation or Liabilities	17
Environmental Matters.....	18
5. Construction and Warranties	18
Construction Dates.....	18
Warranties.....	18
Previously Occupied Building.....	18
6. Approvals and Financing.....	19
Developmental Approval.....	19
Construction Financing.....	19
7. Miscellaneous.....	19
Deposits.....	19
Purchase Agreement.....	19
Developer's Commitments.....	22
Other Material Facts	22
Execution by Developer.....	23
Solicitor's Certificate.....	30

LIST OF EXHIBITS

<i>Exhibit A</i>	Proposed Strata Plans
<i>Exhibit B</i>	Zoning ~ Medium Density Townhouse Zone (RM45)
<i>Exhibit C</i>	Form P Phased Strata Plan Declaration
<i>Exhibit D</i>	Proposed Form V Schedule of Unit Entitlement
<i>Exhibit E</i>	Proposed Bylaw Changes
<i>Exhibit F</i>	Proposed Budget
<i>Exhibit G</i>	Rental Disclosure Statement
<i>Exhibit H</i>	Proposed Contract of Purchase and Sale

1. The Developer:

1.1 The Developer

QKKD Properties Limited having a registered and records office address of #900, 1175 Douglas Street, Victoria, B.C., V8W 2E1, is a company registered in the Corporate Registry under No. BC0931208 on January 26, 2012 (hereinafter called "QKKD"). 0987575 B.C. Ltd. having a registered and records office address of #1500, 13450 – 102nd Avenue, Surrey, B.C., V3T 5X3 is a company registered in the Corporate Registry under No. BC0987575 on December 6, 2013 (hereinafter called "0987575"). Algra Capital Corp. having a registered and records office address of #201, 33832 South Fraser Way, Abbotsford, B.C., V2S 2C5 is a company registered in the Corporate Registry under No. BC0985847 on November 18, 2013 (hereinafter called "Algra Capital"). QKKD, 0987575 and Algra Capital have agreed to form and constitute Lynn Joint Venture and are the beneficial owners of the Lands. Algra Bros. Developments (Lynn) Ltd. (hereinafter called "Lynn") is the registered owner of the Lands (as hereinafter defined). Algra Bros. Developments (Lynn) Ltd. having an office address of 5848 Sappers Way, Chilliwack, B.C., V2R 0G7 is a company registered in the Corporate Registry under No. BC0977131 on August 6, 2013. QKKD, 0987575 and Algra Capital have irrevocably appointed Algra Bros. Developments (Lynn) Ltd. to act as the registered owner of the Development, the Lands and the Strata Lots and as its lawful agent with full power and authority to enter Purchase Agreements as hereinafter defined, together with any amendments thereto and to execute and deliver such other documents as are contemplated by the Purchase Agreements, as the binding obligation of the Developer, all as QKKD, 0987575 and Algra Capital shall think fit in its absolute discretion. QKKD, 0987575, Algra Capital and Lynn are hereinafter collectively referred to as the "Developer".

1.2 Purpose and Assets

Algra Bros. Developments (Lynn) Ltd. was established specifically for the purpose of acting as registered owner of the Lands as hereinbefore defined and as nominee and agent for QKKD, 0987575 and Algra Capital. Algra Bros. Developments (Lynn) Ltd. and Lynn Joint Venture do not hold any assets other than the development property itself.

1.3 Registered and Records Office

The registered and records address of QKKD Properties Limited is #900, 1175 Douglas Street, Victoria, B.C., V8W 2E1. The registered and records address of 0987575 B.C. Ltd. is #1500, 13450 – 102nd Avenue, Surrey, B.C., V3T 5X3. The registered and records address of Algra Capital Corp. is #201, 33832 South Fraser Way, Abbotsford, B.C., V2S 2C5. The registered and records address of Algra Bros. Developments (Lynn) Ltd. is #201, 33832 South Fraser Way, Abbotsford, B.C., V2S 2C5.

1.4 Director Information

The Directors of QKKD Properties Limited are Moon J. Cho, Gordon E. Cho and Grant C. Cho. The Directors of 0987575 B.C. Ltd. are Robert Miller and Laurie Ross. The Directors of Algra Capital Corp. are Philip Edward Algra, Peter Terry Algra and David James Algra. The Directors of Algra Bros. Developments (Lynn) Ltd. are David James Algra, Philip Edward Algra, Grant Caesar Cho and Laurie Ross.

1.5.1 Background, Conflicts of Interest for Developer, Directors, Officers and Principal Holders

To the best of the Developer's knowledge, this is the third development of QKKD Properties Limited. Moon J. Cho, Gordon E. Cho and Grant C. Cho being the directors and officers, have previously developed property in Chilliwack.

Also, to the best of the Developer's knowledge, this is the third development of 0987575 B.C. Ltd. Robert Miller, being one of the directors of 0987575 B.C. Ltd. has developed property for over 46 years which includes single family and multi-family developments in the lower mainland. Laurie Ross, being one of the directors of 0987575 B.C. Ltd. has developed property for over 40 years which includes multi-family developments in Abbotsford, Chilliwack, Maple Ridge, Langley, Surrey and White Rock.

Also, to the best of the Developer's knowledge, this is the third development of Algra Capital Corp. Philip Edward Algra, being one of the directors of Algra Capital Corp. has developed property for over 9 years which includes single family and multi-family developments in Kent, Agassiz, Chilliwack, Abbotsford and Langley. Peter Terry Algra, being one of the directors of Algra Capital Corp. has developed property for over 9 years which includes single family and multi-family developments in Kent, Agassiz, Chilliwack, Abbotsford and Langley. David James Algra, being one of the directors of Algra Capital Corp. has developed property for over 9 years which includes single family and multi-family developments in Kent, Agassiz, Chilliwack, Abbotsford and Langley.

Also, to the best of the Developer's knowledge this is the first development of Algra Bros. Developments (Lynn) Ltd. David James Algra, being one of the directors of Algra Capital Corp. has developed property for over 9 years which includes single family and multi-family developments in Kent, Agassiz, Chilliwack, Abbotsford and Langley. Philip Edward Algra, being one of the directors of Algra Capital Corp. has developed property for over 9 years which includes single family and multi-family developments in Kent, Agassiz, Chilliwack, Abbotsford and Langley. Grant Caesar Cho, being a director of Algra Bros. Developments (Lynn) Ltd. has previously developed property in Chilliwack. Laurie Ross, being one of the directors of Algra Bros. Developments (Lynn) Ltd. has developed property for over 40 years which includes multi-family developments in Abbotsford, Chilliwack, Maple Ridge, Langley, Surrey and White Rock.

- 1.5.2 To the best of the Developer's knowledge neither the Developer, nor any principal holder of the Developer nor any director or officer of the Developer or principal holder have been subject to any penalties or sanctions imposed by a court or regulatory authority relating to the sale, lease, promotion or management of real estate or securities, or to lending money secured by a mortgage of land, or to arranging, administering or dealing in mortgages of land, or to theft or fraud, within the last ten (10) years.
- 1.5.3 To the best of the Developer's knowledge neither the Developer, nor any principal holder of the Developer nor any director or officer of the Developer or principal holder have been declared bankrupt or made a voluntary assignment into bankruptcy, made a proposal under any legislation relating to bankruptcy or insolvency or has been subject to or instituted any proceedings, arrangement or compromise with creditors or had a receiver, receiver manager or trustee appointed to hold their assets, within the last five (5) years.
- 1.5.4 To the best of the Developer's knowledge neither any director, officer or principal holder of the Developer nor any director or officer of the principal holder have, within the last five (5) years, been an officer, director or principal holder of a developer that:
- (a) has been subject to any penalties or sanctions imposed by a court or regulatory authority relating to the sale, lease, promotion or management of real estate or securities, or to lending money secured by a mortgage of land, or to arranging, administering or dealing in mortgages of land, or to theft or fraud; and
 - (b) has been declared bankrupt or made a voluntary assignment into bankruptcy, made a proposal under any legislation relating to bankruptcy or insolvency or has been subject to or instituted any proceedings, arrangement or compromise with creditors or had a receiver, receiver manager or trustee appointed to hold its assets.
- 1.6 There are no existing or potential conflicts of interest among the Developer, manager, any directors, officers or principal holders of the Developer and manager, any directors or officers of the principal holders nor any other party providing good or services to the developer, manager or holders of the development units in connection with the development that might reasonably be expected to affect the purchaser's purchase decision.

2. General Description

2.1 General Description of the Development:

The development will consist of 46 residential townhouse units (the "Strata Lots") to be built in four (4) phases. Each Strata Lot will be located in an attached 2 or 3-storey wood framed building with garage parking. All units will be constructed and marketed for sale or lease by the Developer. The development will be located at 33460 Lynn Avenue, Abbotsford, B.C. The Strata Lots will be owned individually and each strata lot will be located in one of 8 multi-unit buildings. The 3-storey townhouses will have attached garage with additional surface parking and the 2-storey townhouses will have a

basement which includes a separate garage building. Subject to the encumbrances referred to in Sections 4.3, each of the owners of the Strata Lots will also be entitled to a proportionate share of the common property (the "Common Property") of the Development, other common facilities, and other assets of the Strata Corporation, which the owners of the Strata Lots will own as tenants-in-common. The proposed layout of the Development and the dimensions and location of the Strata Lots are set out in the Proposed Plans which is attached hereto as Exhibit "A". Actual Strata Lots as constructed may vary somewhat from what is depicted on the Proposed Strata Plans.

2.2 Permitted Use:

All of the Lots in the Development are intended for residential use. There are no restrictions on use except as may be imposed by the City of Abbotsford pursuant to its zoning and other bylaws applicable to the Lands. The property is zoned 420 – Medium Density Townhouse Zone (RM45). A copy the Zoning Bylaw RM45 is attached hereto as Exhibit "B". For further information on zoning requirements and permissible uses please contact the City of Abbotsford (Planning & Development Department), 32315 South Fraser Way, Abbotsford, B.C., V2T 1W7 Phone: (604) 864-5510 www.abbotsford.ca.

2.3 Phasing:

This development is part of a phased strata plan and will consist of 46 strata lots in four (4) phases as follows:

Phase	General Type of Residence	Total Units
Phase 1 (Buildings 5, 6)	Seven 3-storey townhouse units with attached garage, Five 2-storey with basement townhouse units with separate garage building	12 units
Phase 2 (Buildings 7, 8)	Seven 3-storey townhouse units with attached garage, Four 2-storey with basement townhouse units with separate garage building	11 units
Phase 3 (Buildings 3, 4)	Seven 3-storey townhouse units with attached garage, Five 2-storey with basement townhouse units with separate garage building	12 units
Phase 4 (Buildings 1, 2)	Seven 3-storey townhouse units with attached garage, Four 2-storey with basement townhouse units with separate garage building	11 units

As a result of the City of Abbotsford's approval process, the proposed Form P Phased Strata Plan Declaration has been approved by the approving officer and is attached hereto as Exhibit "C". The Developer intends to market all the Strata Lots in all four phases but currently only Phase One and Phase Two. The Phased Strata Plan Declaration sets the dates for the Developer to elect to proceed with each phase; however the Developer is entitled not to proceed with subsequent phases. There are no common facilities included in the Development.

3. Strata Information

3.1 Unit Entitlement

The Developer has chosen the calculation of the unit entitlement to be the habitable area of the strata lot, in square metres, rounded to the nearest whole number as determined by a British Columbia Land Surveyor. The proposed Form V Schedule of Unit Entitlement is set out in Exhibit "D". Unit Entitlement figure indicates the share of an owner in the common property, common facilities and other assets of the strata corporation. It is also the figure used to determine the owner's contribution toward the common expenses.

3.2 Voting

Voting Rights refers to the number of votes allotted to each strata lot. For this development each strata lot will have one vote. The Developer does not intend to file a Form W, as this is not a mixed-use development.

3.3 Common Property & Facilities

The Common Property of the Development will include the following which will be located generally as indicated in Exhibit "A": sidewalks, garbage areas, grassed and landscaped areas, housing for electrical and mechanical. There are no common facilities included in the development.

3.4 Limited Common Property

The Developer may designate on the strata plan each deck, patio and yard adjacent to a strata lot as limited common property for that particular strata lot. The Developer may also designate on the strata plan, surface parking stalls as limited common property for particular Strata Lot. The Strata Corporation is responsible for maintaining all common property, including limited common property; however under Section 72(2)(a) of the *Strata Property Act*, the Strata Corporation may, by bylaw, make owners responsible for the repair and maintenance of limited common property which they use. See section 3.5 for bylaw amendment.

3.5 Bylaws

The bylaws of the Strata Corporation shall be those contained in the *Strata Property Act*, as amended by the changes to the Bylaws set out in Exhibit "E" attached hereto. The significant changes to the Bylaws are as follows:

Use of property

- 3(1) *An owner, tenant, occupant or visitor must not use a strata lot, the common property or common assets in a way that:*
- (a) causes a nuisance or hazard to another person,*
 - (b) causes unreasonable noise,*
 - (c) unreasonably interferes with the rights of other persons to use and enjoy the common property, common assets or another strata lot,*
 - (d) is illegal, or*
 - (e) is contrary to a purpose for which the strata lot or common property is intended as shown expressly or by necessary implication on or by the strata plan.*
- (2) *An owner, tenant, occupant or visitor may not cause damage, other than reasonable wear and tear, to the common property, common assets or those parts of a strata lot which the strata corporation must repair and maintain under these bylaws or insure under section 149 of the Act.*
- (3) *An owner, tenant, occupant or visitor must ensure that all animals are leashed or otherwise secured when on the common property or on land that is a common asset.*
- (4) *An owner, tenant, occupant must not keep any pets on a strata lot other than one or more of the following:*
- (a) a reasonable number of fish or other small aquarium animals;*
 - (b) a reasonable number of small caged mammals;*
 - (c) up to 2 caged birds;*
 - (d) up to 3 pets consisting of not more than two dogs or not more than two cats over the age of 6 months;*
- (5) *Pet owners are responsible for immediate removal of all pet waste which is left anywhere on the common property or public sidewalks or boulevards adjoining the property.*
- (6) *Pet owners will be required to pay a \$20.00 clean up fee to the landscaping maintenance company for any pet waste which is left on a strata lot during weekly scheduled lawn maintenance days.*
- (7) *Owners are responsible for any damages caused by their pets or the pets of their tenants or guests.*
- (8) *Owners will be required to pay a \$10.00 clean up fee to the landscaping maintenance company for any personal items which are left on the strata lot during weekly scheduled lawn maintenance days.*

Repair and maintenance of property by Strata Corporation

8 The strata corporation must repair and maintain all of the following:

- (a) common assets of the strata corporation;*
- (b) common property that has not been designated as limited common property;*
- (c) limited common property, but the duty to repair and maintain it is restricted to:*
 - (i) repair and maintenance that in the ordinary course of events occurs less often than once a year, and*

(ii) *the following, no matter how often the repair or maintenance ordinarily occurs:*

- (A) *the structure of a building;*
- (B) *the exterior of a building;*
- (C) *chimneys, stairs, balconies and other things attached to the exterior of a building;*
- (D) *doors, windows and skylights on the exterior of a building or that front on the common property;*
- (E) *fences, railings and similar structures that enclose patios, balconies and yards;*
- (F) *mowing, fertilization and aerating of rear limited common property strata lot yards;*
- (G) *clean up of leaves, branches and other landscape debris in front limited common property strata lot yards;*

(d) *a strata lot in a strata plan that is not a bare land strata plan, but the duty to repair and maintain it is restricted to:*

- (i) *the structure of a building;*
- (ii) *the exterior of a building,*
- (iii) *chimneys, stairs, balconies and other things attached to the exterior of a building,*
- (iv) *doors, windows and skylights on the exterior of a building or that front on the common property, and*
- (v) *fences, railings and similar structures that enclose patios, balconies and yards*

Miscellaneous Rules

- 31 (1) *An owner shall not install any heating, ventilation or air conditioning devices ("hvac") in any window of any strata lot. Should the developer make provisions for future installation of hvac, such hvac must be installed in an area predetermined by the developer. An owner must have the hvac unit and all associated piping and wiring be similar in size to hvac units already installed by the developer. An owner must have the hvac unit installed by a certified professional.*

3.6 Parking

Each of the 2-storey with basement townhouses will contain a separate double car garage building for parking which will form part of that particular strata lot. There will be 8 visitor stalls designated as common property. The 3-storey townhouse units contain an attached single car garage and additional surface parking which may be designated on the strata plan as limited common property. The Developer, in its sole discretion, may allocate additional parking stalls for the exclusive use of individual strata lot owners, on such terms as the Developer may determine, using one or more of the following methods:

- (a) *designation on the strata plan as limited common property, upon filing of the strata plan;*
- (b) *designation on the strata plan as limited common property, subsequent to filing of the strata plan but before the first annual general meeting of*

the strata corporation in accordance with section 258 of the *Strata Property Act*;

- (c) partial assignments of rights under a lease entered into prior to the filing of the strata plan;
- (d) partial assignments of rights of the Developer with respect to individual parking stalls that may be allocated as limited common property for a strata lot to be owned and controlled by the Developer; or
- (e) such other method as the Developer may determine.

In designating such additional parking stalls, the owner developer is not required to act with a view to the best interests of the strata corporation, but must act honestly and in good faith and exercise the care, diligence and skill of a reasonably prudent person in comparable circumstances. Such a designation of additional parking stalls does not require approval by a resolution at an annual or special general meeting. On this basis, the Developer hereby reserves the right to allocate to any of the strata lots within the development additional parking stalls and to designate such parking stalls as limited common property of the strata corporation or otherwise, up to the first annual general meeting after the filing of the strata plan.

3.7 Furnishings and Equipment

The following equipment/furnishings will be included in the purchase of each Strata Lot: refrigerator, range, dishwasher, washer and dryer. The above items will not be encumbered except to the extent of any mortgage registered in the Land Title Office and any general security agreement filed under the *Personal Property Security Act*. Any filings under the *Personal Property Security Act* will be released upon payment in full of the construction mortgage by the Developer. Any manufacturer's warranty for appliances and equipment whether located in the Strata Lots or in the Common Property will be passed on to the Purchaser or the Strata Corporation, as the case may be if and to the extent permitted by such warranty. The services available to the Development include electricity, water, sewer, natural gas (some strata lots), fire protection, access, garbage collection, cable, telephone and internet. Charges for these services and utilities are explained in paragraphs 3.9.

3.8 Budget

An estimated budget for a typical full year of operating expenses of the Strata Corporation is attached as Exhibit "F". Pursuant to section 7 of the *Strata Property Act*, the Developer must pay the Strata Corporation's expenses up to the end of the month in which there is the first conveyance of a Strata Lot to a purchaser. Pursuant to section 14 of the *Act*, after that month and before the first annual budget takes effect, if the Strata Corporation's expenses exceed the estimated expenses in the interim budget, then the Developer must pay the excess to the Strata Corporation. In addition to paying the amount of the excess expenses, where those excess expenses are more than 10% or more than 20% of

the amounts estimated in the interim budget, section 3.1(1) of the Regulations requires the Developer to pay to the Strata Corporation a further amount equal to two times (if the excess is more than 10%) or three times (if the excess is more than 20%) of the amount of the excess. The allocation of strata fees is based on the unit entitlement of each strata lot. None of the contributions to the operating fund are based upon sections, type of strata lot or limited common property. Common Area utilities and other expenses related to the common property are paid by the Strata Corporation. Such expenses are included in the estimated Budget, attached as Exhibit "F", and their cost will be prorated to the owners of the Strata Lots and included in the monthly assessments.

3.9 Utilities and Services

This development is not located outside a municipality. Each Strata Lot owner will be responsible for real property taxes for his/her Strata Lot. Real property taxes are levied by and payable to the City of Abbotsford. Electricity, water, hydro, natural gas, satellite and telephone will be separately metered or assessed to each Strata Lot and they are not included in the estimated Budget set out in Exhibit "F". Purchasers must make the appropriate application to set up accounts for these services for each Strata Lot. Common Area utilities and other expenses related to the common property are paid by the Strata Corporation. Such expenses are included in the estimated Budget, attached as Exhibit "F", and their cost will be prorated to the owners of the Strata Lots and included in the monthly assessments.

3.10 Strata Management Contracts

The Developer intends to cause the Strata Corporation to enter into a management agreement with Teamwork Property Management Ltd. with respect to the control, management and administration of the Common Property. The Management Agreement may be terminated prior to the end of the term, in accordance with the provisions of the *Strata Property Act*.

3.11 Insurance

Developer Coverage

The Developer will place, at the time of commencement of construction, the following insurance coverage with respect to the Development:

- (i) A commercial general liability insurance policy with a completed operations extension; and
- (ii) A builder's risk broad form policy for revolving course of construction insurance for the period up to completion of the Development.

Strata Corporation Coverage

The Developer will obtain the following insurance coverage in the name of the Strata Corporation:

- (a) full replacement insurance on:
- (i) common property;
 - (ii) common assets;
 - (iii) buildings shown on the strata plan; and
 - (iv) fixtures which are installed on the strata lot by the developer as part of the original construction. Fixtures are defined as "items attached to a building, including floor and wall coverings and electrical and plumbing fixtures, but does not include, if they can be removed without damage to the building, refrigerators, stoves, dishwashers, microwaves, washers, dryers, or other items".
- The above noted property will be insured against "major perils" which are defined as "fire, lightning, smoke, windstorm, hail, explosion, water escape, strikes, riots or civil commotion, impact by aircraft and vehicles, vandalism and malicious acts".
- (b) liability insurance to insure the Strata Corporation against property damage and bodily injury, in an amount of not less than \$2,000,000.00.

Purchaser's Coverage

A Purchaser of a Strata Lot will be responsible for insuring the contents of his or her Strata Lot and obtaining liability insurance with respect to his Strata Lot.

3.12 Rental Disclosure Statement

Under Section 139 of the *Strata Property Act*, a developer must disclose to any Purchaser an intention to lease Strata Lots in order to ensure that such Strata Lots may be leased in the future. A rental disclosure statement has been filed with the Superintendent of Real Estate concurrently with the filing of this Disclosure Statement and a copy is attached as Exhibit "G".

4. Title and Legal Matters

4.1 Legal Description

The legal description of the developmental property is:
 PID: 029-441-358
 Parcel 1 Section 16 Township 16 New Westminster District Plan EPP44781

4.2 Ownership

Title is in the name of Algra Bros. Developments (Lynn) Ltd. (Incorporation No. 0977131).

4.3 Existing Encumbrances and Legal Notations

Legal Notations:

- (i) This title may be affected by a permit under Part 26 of the *Local Government Act*, See CA4132488;

Charges, Liens and Interests:

- (i) Mortgage No. CA3941894 in favour of First West Credit Union which will be discharged from the title of each strata lot upon receipt of net sale proceeds;
- (ii) Assignment of Rents No. CA3941895 in favour of First West Credit Union which will be discharged from the title of each strata lot upon receipt of net sale proceeds;
- (iii) Covenant No. CA4084843 in favour of the City of Abbotsford for private garbage collection;
- (iv) Priority Agreement No. CA4084844 granting Covenant No. CA4084843 priority over Mortgage No. CA3941894 and Assignment of Rents No. CA3941895;
- (v) Statutory Right of Way No. CA4352605 in favour FortisBC Energy Inc.

4.4 Proposed Encumbrances

The Developer intends to create and enter into an easement agreement for reciprocal shared access for the phases.

No further encumbrances, covenants, or liens are proposed or anticipated to be registered or filed in respect to the Development other than easements, restrictive covenants, dedications and rights-of-way and other rights or restrictions in favour of B.C. Hydro, Telus, utilities, communications suppliers, public authorities, municipalities or any other applicable government authority or public or private utility with respect to provision of utilities to the Development or in connection with approval of the subdivision, development, construction and occupation of the Land, the Development, and the Strata Lots.

4.5 Outstanding or Contingent Litigation or Liabilities

There is no outstanding or anticipated litigation or liability in respect of the Development or against the Developer which may affect the Strata Corporation or Strata Lot owners.

4.6 Environmental Matters

To the best of the Developer's knowledge, the land on which the Development is being constructed does not lie within an area which may be subject to flooding. The Developer is not aware of any dangers connected with the development property in respect of the condition of the soil or subsoil. The Developer is not aware of any other environmental issues affecting the development property.

5. Construction and Warranties

5.1 Construction Dates

For the purpose of this section:

"commencement of construction" means the date of commencement of excavation in respect of construction of an improvement that will become part of a development unit within the development property and where there is no excavation it means the date of commencement of construction of an improvement that will become part of a development unit within the development property;

"completion of construction" means the first date that a development unit within the development property may be lawfully occupied, even if such occupancy has been authorized on a provisional or conditional basis;

"estimated date range" means a date range, not exceeding three months, for the commencement of construction or the completion of construction;

Construction of the Development commenced on or about December 15, 2014. The Developer estimates the date range for the completion of construction to be approximately September 15, 2016 - December 15, 2016.

5.2 Warranties

Home warranty coverage for the Development, including the individual Strata Lots, will be covered by Travelers Guarantee Company of Canada for a period of 10 years for structural defects, 5 years for defects in the building envelope, including those resulting in water penetration, and 2 years for defects in workmanship.

This warranty will be offered pursuant to the requirements of the *Homeowners Protection Act*.

5.3 Previously Occupied Building

Not Applicable

6. Approvals and Financing

6.1 Development Approval

A Development Permit No. 1941 was issued by the City of Abbotsford on December 8, 2014 approving the application for development. Under Division 2 Part 2 of the *Real Estate Development Marketing Act*, a developer must not market a strata lot or leasehold unit unless the appropriate municipal or other government authority has issued a building permit in relation to the strata lot or leasehold unit. The Developer was issued a building permit for the construction of Phase One from the City of Abbotsford. The Developer is aware that he may offer the strata lots for sale under this disclosure statement for a period of no longer than nine months from the date of this disclosure statement unless an amendment is accepted by the Superintendent of Real Estate during that time setting out the issued building permits. A copy of the proposed Contract of Purchase and Sale including Policy Statement 5 (Early Marketing) terms and conditions is attached hereto as Exhibit "H".

6.2 Construction Financing

The Developer has obtained unconditional financing from a lender for the purpose of constructing the strata lots for Phase One only. Accordingly, this disclosure statement is filed under the provisions of Policy Statement 6. The Developer is aware that he may offer the strata lots for sale under this disclosure statement for a period of no longer than nine months from the date of this disclosure statement unless an amendment is accepted by the Superintendent of Real Estate during that time setting out the particulars of a satisfactory financing commitment. A copy of the proposed Contract of Purchase and Sale including Policy Statement 6 (Adequate Arrangements – Utilities and Services) terms and conditions is attached hereto as Exhibit "H".

7. Miscellaneous

7.1 Deposits

Purchasers' deposits and all money received from purchasers shall be held in trust by the law office of Rosborough & Company in accordance with the terms of the Contract of Purchase and Sale and in the manner required by the *Real Estate Marketing Development Act*.

7.2 Purchase Agreement

7.2.1 A copy of the proposed Contract of Purchase and Sale is attached hereto as Exhibit "H".

Termination:

7.2.2 The purchase agreement provides in Paragraph 3. *Terms and Conditions* that the purchase and sale of the property includes terms and is subject to items listed in the addendum. Each condition, if so indicated is for the sole benefit of the party indicated. Unless each condition is waived or declared fulfilled by written notice given by the

party to the other party on or before the date specified for each condition, the contract will be terminated thereupon and the deposit returnable in accordance with the Real Estate Development Marketing Act.

The purchase agreement further provides in Paragraph 12 *Time* that time will be of the essence hereof and unless the balance of the cash payment is paid and such formal agreements to pay the balance as may be necessary is entered into on or before the completion date, the seller may, at the seller's option, terminate the contract and in such event the amount paid by the buyer will be non-refundable and absolutely forfeited to the seller in accordance with the Real Estate Development Marketing Act on account of damages without prejudice to the seller's other remedies.

The purchase agreement provides in Paragraph 2 *Deposits* (see Addendum Page 5 of 11) that if the buyer fails to complete the purchase of the property through no fault of the seller, or if the buyer fails to pay the deposit or any portion thereof when due, then the seller may, at the seller's option, terminate the contract in which case the buyer absolutely forfeits the deposit to the seller and the buyer and the seller hereby irrevocably authorize and instruct the seller's solicitor to release the deposit from trust and pay it to the seller.

The purchase agreement further provides in the Addendum, paragraph labelled (Policy Statement 6) on Page 9 of 11 that Pursuant to Policy Statement 6 (Adequate Arrangements – Utilities and Services) issued by the Superintendent of Real Estate, a developer may file a Disclosure Statement and market strata lots prior to obtaining a satisfactory financing commitment, provided that an amendment to the Disclosure Statement disclosing the particulars of a satisfactory financing commitment is filed with the superintendent within nine months from the developer filing the original Disclosure Statement and subject to the following conditions: (a) if an amendment to the Disclosure Statement that sets out particulars of a satisfactory financing commitment is not received by the Buyer within 12 months after the initial Disclosure Statement was filed, the Buyer may at his or her option cancel the Contract at any time after the end of that 12 month period until the required amendment is received by the Buyer; (b) the amount of the deposit to be paid by a Buyer who has not yet received an amendment to the Disclosure Statement that sets out particulars of a satisfactory financing commitment is no more than 10% of the purchase price; and (c) all deposits paid by a Buyer, including interest earned if applicable, will be returned promptly to the Buyer upon notice of cancellation from the Buyer.

The purchase agreement further provides in the Addendum, paragraph labelled (Policy Statement 5) on Page 9 of 11 that pursuant to Policy Statement 5 (Early Marketing – Development Approval) issued by the Superintendent of Real Estate, a developer may file a disclosure statement and market strata lots prior to obtaining a building permit, provided that an amendment to the disclosure statement disclosing the particulars of the issued building permit is

filed with the superintendent within nine (9) months from the developer filing the original disclosure statement and subject to the following conditions: (a) The Buyer may cancel the Contract for a period of seven days after receipt of an amendment to the Disclosure Statement that sets out particulars of the issued building permit if the layout or size of the applicable development unit, the construction of a major common facility, including a recreation centre or clubhouse, or the general layout of the development, is materially changed by the issuance of the building permit; (b) If an amendment to the Disclosure Statement that sets out particulars of an issued building permit is not received by the Buyer within 12 months after the initial Disclosure Statement was filed, the Buyer may at his or her option cancel the Contract at any time after the end of that 12 month period until the required amendment is received by the Buyer, at which time the Buyer may cancel the Contract for a period of seven days after receipt of that amendment only if the layout or size of the applicable development unit, the construction of a major common facility, including a recreation centre or clubhouse, or the general layout of the development, is materially changed by the issuance of the building permit; (c) The amount of the deposit to be paid by a Buyer who has not yet received an amendment to the Disclosure Statement that sets out particulars of an issued building permit is no more than 10% of the purchase price; and (d) all deposits paid by a Buyer, including interest earned if applicable, will be returned promptly to the Buyer upon notice of cancellation from the Buyer.

Extension:

- 7.2.3 The purchase agreement provides in the Addendum, first paragraph on Page 7 of 11 that the Seller reserves the right to extend the completion, possession and adjustment dates up to 180 days if deemed necessary by the Seller to complete and receive an occupancy permit for the home. The Seller is required to give at least 60 days notice to the Buyer before the completion date, should the Seller be required to extend the completion, possession and adjustment dates.

There is no provision in the purchase agreement for the developer or purchaser to require or refuse an extension or whether the developer should seek a fee or increase the purchase price in order to agree to an extension.

Assignment:

- 7.2.4 There is no provision in the purchase agreement that provides for assignment of the purchase agreement. There is no provision in the purchase agreement for the developer to refuse to allow an assignment or seek a fee in order to agree to an assignment.

Interest on Deposits:

7.2.5 There is no provision in the purchase agreement for the Buyer or the Seller (Developer) to receive interest on the deposit monies.

7.3 Developer's Commitments

The Development will include normal clearing to permit construction, excavation and landscaping of the Development, and will include the planting of grassed areas, trees, and shrubs around the buildings.

7.4 Other Material Facts

There are no material contracts affecting the Development binding upon the Developer and/or Strata Corporation other than as set out in this Disclosure Statement.

There will be no rental pool involved in the Development.

Section 22 of the *Real Estate Development Marketing Act* provides that every purchaser who is entitled to receive this Disclosure Statement is deemed to have relied on any false or misleading statement of a material fact contained in this Disclosure Statement, if any, and any omission to state a material fact. The developer, its directors and any person who has signed or authorized the filing of this Disclosure Statement are liable to compensate the purchaser for any misrepresentation, subject to any defences available under section 22 of the Act.

The foregoing statements disclose, without misrepresentation, all material facts relating to the Development referred to above, as required by the *Real Estate Development Marketing Act* of British Columbia, as of May 6, 2015.

Algra Capital Corp.

Per:

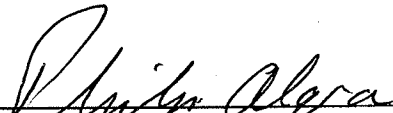
Philip Edward Algra (Authorized Signatory)

Dated: May 6, 2015

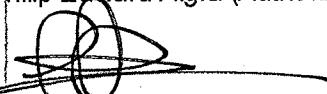
Peter Terry Algra (Authorized Signatory)

Dated: May 6, 2015

David James Algra (Authorized Signatory)

Dated: May 6, 2015

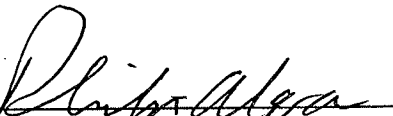
Philip Edward Algra

Dated: May 6, 2015

Peter Terry Algra

Dated: May 6, 2015

David James Algra

Dated: May 6, 2015

0987575 B.C. Ltd.

Per:

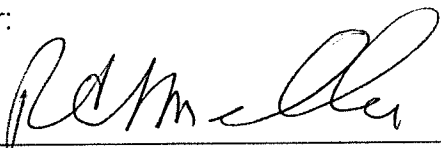
Robert Miller (Authorized Signatory)

Dated: May 6, 2015

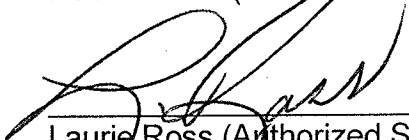
Laurie Ross (Authorized Signatory)

Dated: May 6, 2015

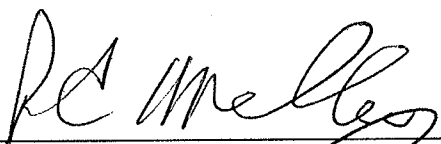
Robert Miller

Dated: May 6, 2015

Laurie Ross

Dated: May 6, 2015

QKKD Properties Limited

Per:

Moon J. Cho (Authorized Signatory)

Dated: *May 6, 2015*

Gordon E. Cho (Authorized Signatory)

Dated:

Grant C. Cho (Authorized Signatory)

Dated: *May 6, 2015*

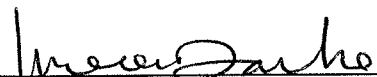
Moon J. Cho

Dated: *May 6, 2015*

Gordon E. Cho

Dated:

Grant C. Cho

Dated: *May 6, 2015*

QKKD Properties Limited

Per:

Moon J. Cho (Authorized Signatory)

Dated:



Gordon E. Cho (Authorized Signatory)

Dated: *May 6, 2015*

Grant C. Cho (Authorized Signatory)

Dated:

Moon J. Cho

Dated:

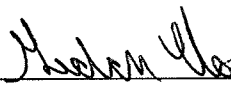

Gordon E. Cho

Dated: *May 6, 2015*

Grant C. Cho

Dated:

Algra Bros. Developments (Lynn) Ltd.
Per:

David James Algra (Authorized Signatory)

Dated:

Philip Edward Algra (Authorized Signatory)

Dated:



Grant Caesar Cho (Authorized Signatory)

Dated: *May 6, 2015*

Laurie Ross (Authorized Signatory)

Dated:

David James Algra

Dated:

Philip Edward Algra

Dated:



Grant Caesar Cho

Dated: *May 6, 2015*

Laurie Ross

Dated:

Algra Bros. Developments (Lynn) Ltd.

Per:



Dave James Algra (Authorized Signatory)

Dated: May 6, 2015

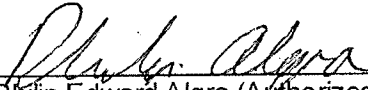

Philip Edward Algra (Authorized Signatory)

Dated: May 6, 2015

Grant Caesar Cho (Authorized Signatory)

Dated:

Laurie Ross (Authorized Signatory)

Dated:

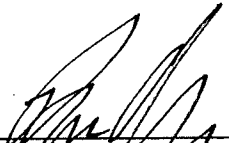

Dave James Algra

Dated: May 6, 2015

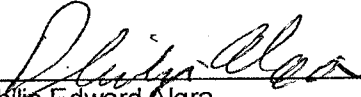

Philip Edward Algra

Dated: May 6, 2015

Grant Caesar Cho

Dated:

Laurie Ross

Dated:

Algra Bros. Developments (Lynn) Ltd.
Per:

David James Algra (Authorized Signatory)

Dated:

Philip Edward Algra (Authorized Signatory)

Dated:

Grant Caesar Cho (Authorized Signatory)

Dated:



Laurie Ross (Authorized Signatory)

Dated:

May 6, 2015

David James Algra

Dated:

Philip Edward Algra

Dated:

Grant Caesar Cho

Dated:

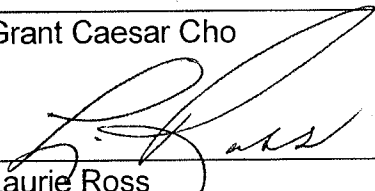

Laurie Ross

Dated:

May 6, 2015

SOLICITOR'S CERTIFICATE

IN THE MATTER of the *Real Estate
Development Marketing Act* and the Disclosure
Statement of **Algra Bros. Developments (Lynn) Ltd.** and
Lynn Joint Venture

For Property legally described as:
City of Abbotsford
PID: 029-441-358
Parcel 1 Section 16 Township 16
New Westminster District Plan EPP44781

I, Conrad Warkentin, Barrister and Solicitor, a member of the Law Society of the Province of British Columbia, having read over the above-described Disclosure Statement dated the 6th day of May, 2015, made any required investigations in public offices, and reviewed same with the Developer therein named, hereby certify that the facts contained in Paragraphs 4.1, 4.2 and 4.3 are correct.

DATED at the City of Abbotsford,
in the Province of British Columbia,
this 6th day of May, 2015.



Conrad Warkentin

Exhibit "A"
Proposed Plans

PROPOSED PLAN OF
33460 LYNN AVENUE,
ABBOTSFORD, BC

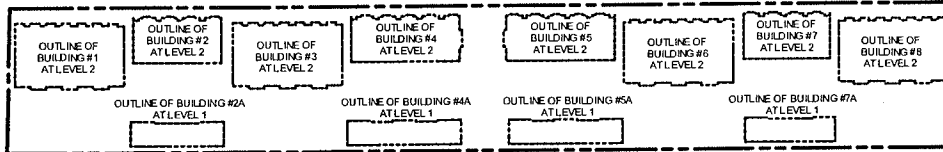

OVERALL SITE PLAN

SCALE: 1:2000

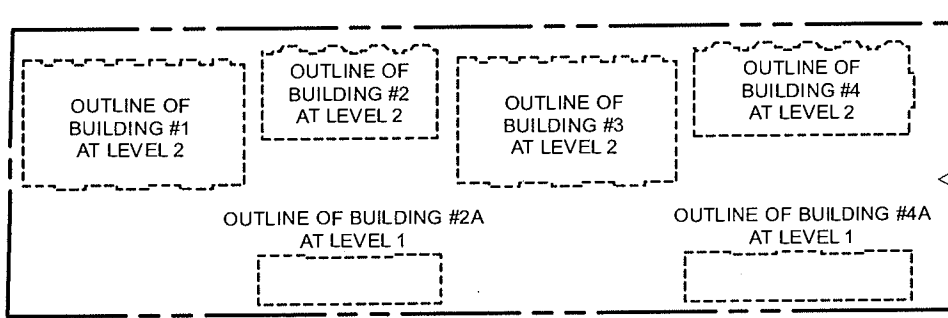

WEST HALF OF SITE

SCALE: 1:1000

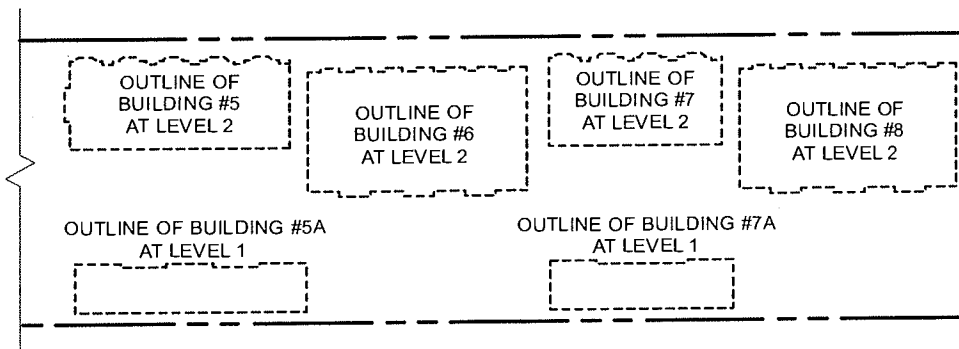

EAST HALF OF SITE

SCALE: 1:1000



FLOOR PLANS

BUILDING 2 - BASEMENT
STRATA LOTS 8 - 11

LEGEND

- m² DENOTES SQUARE METRES
- SL 6 DENOTES STRATA LOT
- ELEC DENOTES ELECTRICAL
- MECH DENOTES MECHANICAL
- G DENOTES GARAGE
- Ⓢ DENOTES GENERAL COMMON PROPERTY
- ⑤ DENOTE LIMITED COMMON PROPERTY FOR INDICATED SL

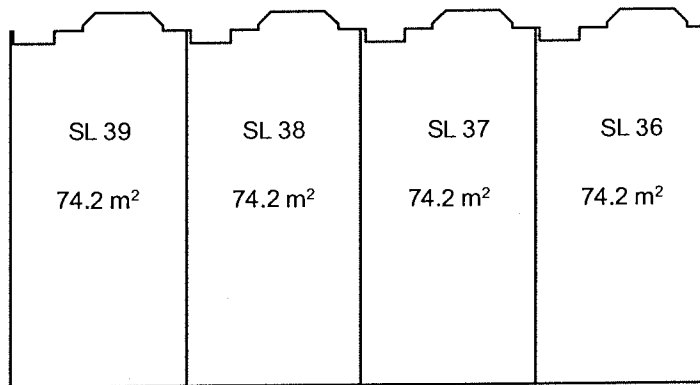

SCALE 1 : 250

FLOOR PLANS

BUILDING 4 - BASEMENT
STRATA LOTS 8 - 11

LEGEND

- m² DENOTES SQUARE METRES
- SL 6** DENOTES STRATA LOT
- ELEC DENOTES ELECTRICAL
- MECH DENOTES MECHANICAL
- G DENOTES GARAGE
- ⊙ DENOTES GENERAL COMMON PROPERTY
- Ⓟ DENOTES LIMITED COMMON PROPERTY FOR INDICATED SL

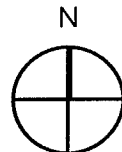
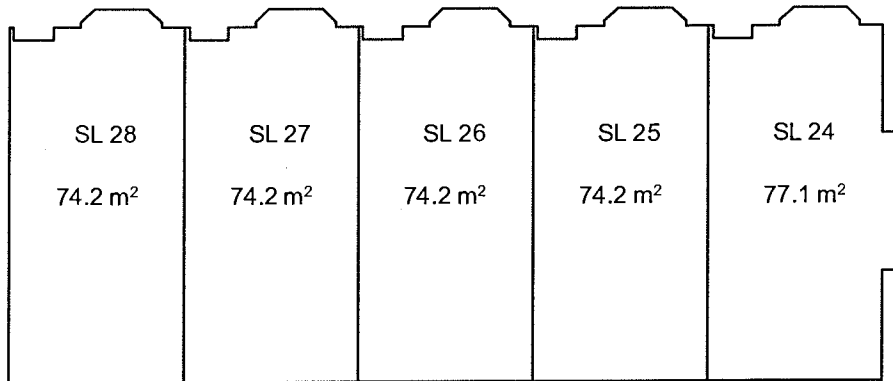

SCALE 1 : 250

FLOOR PLANS

BUILDING 5 - BASEMENT
STRATA LOTS 24 - 28

SHEET 4 OF 25

LEGEND

- m² DENOTES SQUARE METRES
- SL 6 DENOTES STRATA LOT
- ELEC DENOTES ELECTRICAL
- MECH DENOTES MECHANICAL
- G DENOTES GARAGE
- ⊙ DENOTES GENERAL COMMON PROPERTY
- ⑤ DENOTE LIMITED COMMON PROPERTY FOR INDICATED SL

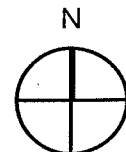
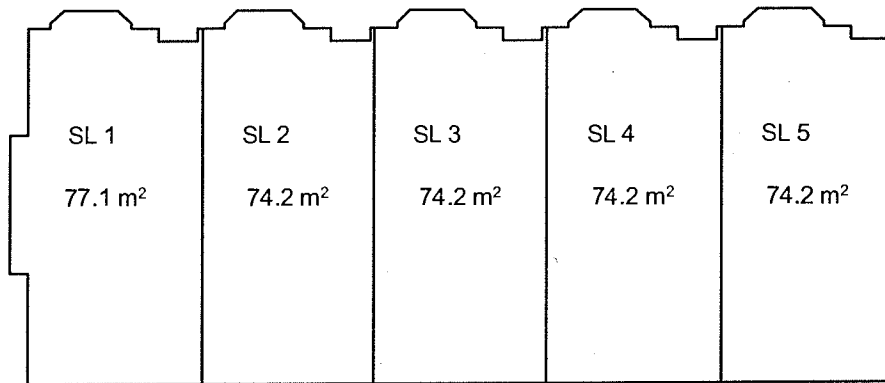

SCALE 1:250

FLOOR PLANS

BUILDING 7 - BASEMENT
STRATA LOTS 36 - 39

LEGEND

- m² DENOTES SQUARE METRES
- SL 6 DENOTES STRATA LOT
- ELEC DENOTES ELECTRICAL
- MECH DENOTES MECHANICAL
- G DENOTES GARAGE
- ⊙ DENOTES GENERAL COMMON PROPERTY
- ⑤ DENOTE LIMITED COMMON PROPERTY FOR INDICATED SL

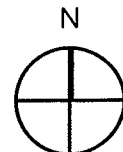
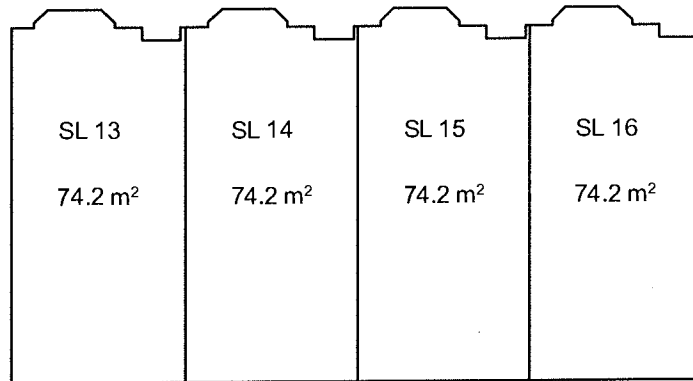

SCALE 1 : 250

FLOOR PLANS

BUILDING 1 - GROUND LEVEL
STRATA LOTS 1 - 7

LEGEND

- m² DENOTES SQUARE METRES
- SL 6 DENOTES STRATA LOT
- P DENOTES PATIO
- Y DENOTES YARD
- ⊙ DENOTES GENERAL COMMON PROPERTY
- ⊕ DENOTES LIMITED COMMON PROPERTY FOR INDICATED SL

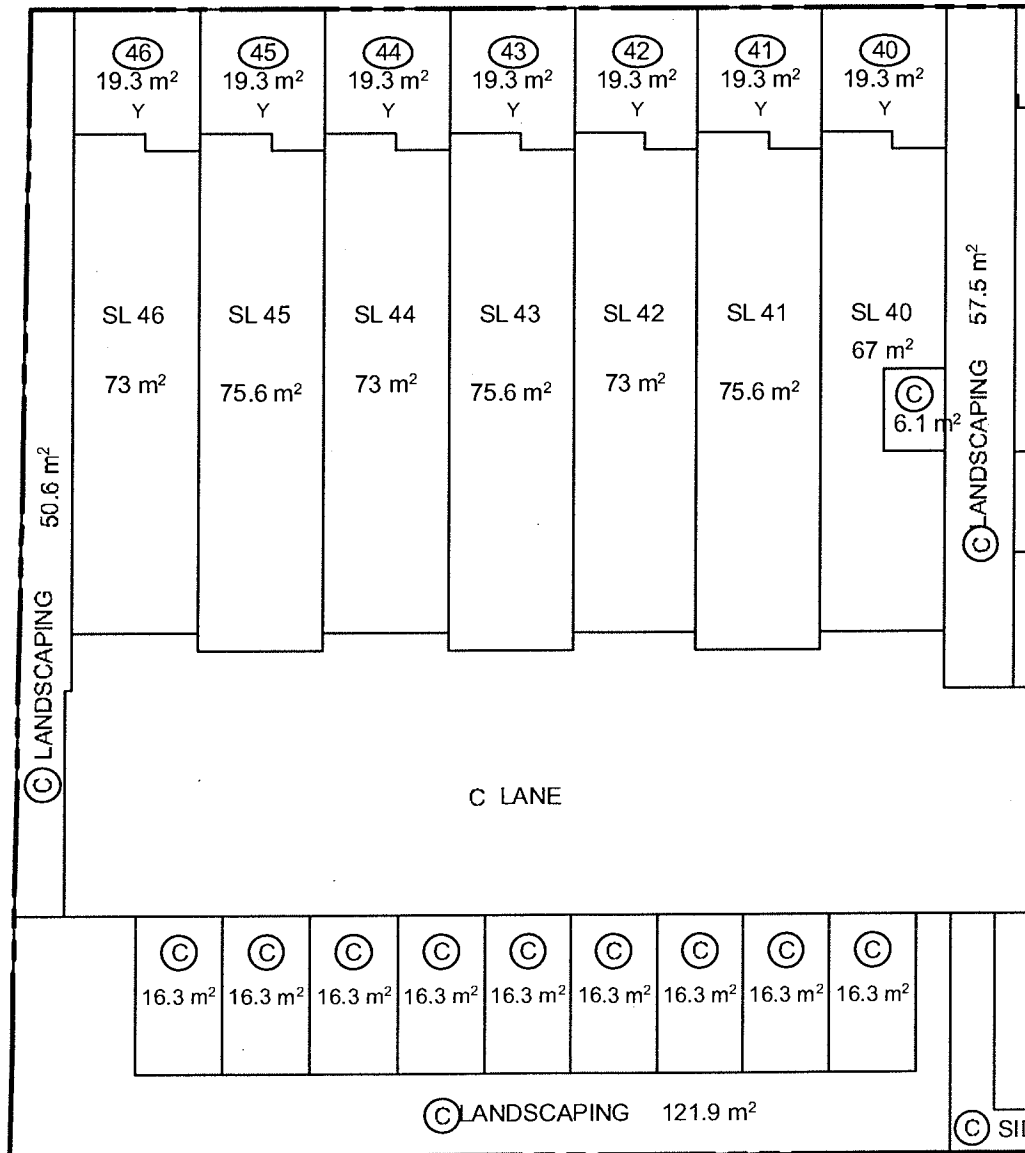

SCALE 1 : 250

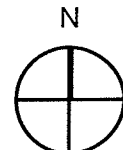

FLOOR PLANS

BUILDING 2 - GROUND LEVEL
STRATA LOTS 8 - 11

LEGEND

- m² DENOTES SQUARE METRES
- SL 6 DENOTES STRATA LOT
- P DENOTES PATIO
- Y DENOTES YARD
- ⊙ DENOTES GENERAL COMMON PROPERTY
- Ⓟ DENOTE LIMITED COMMON PROPERTY FOR INDICATED SL

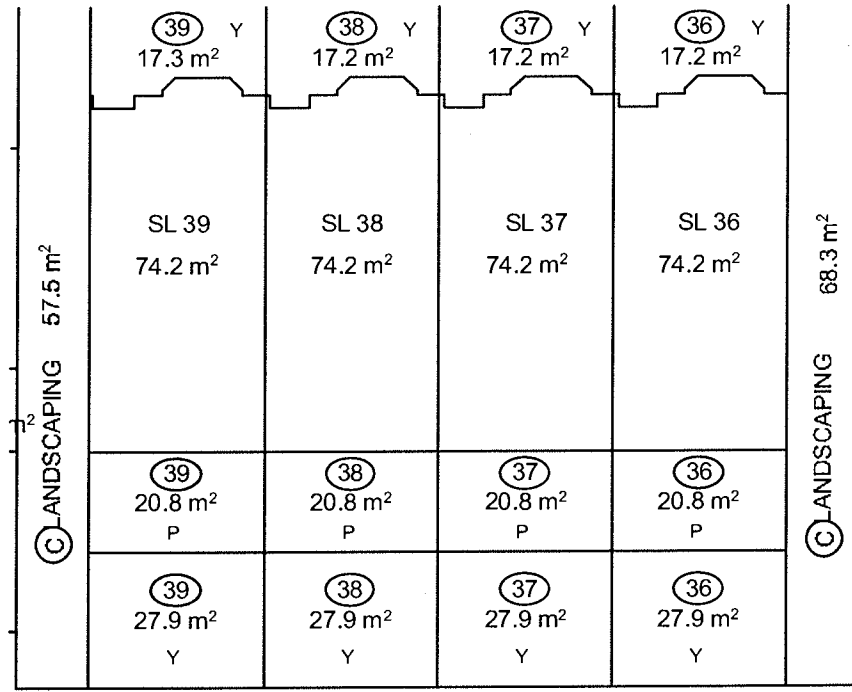

⊙ LANE

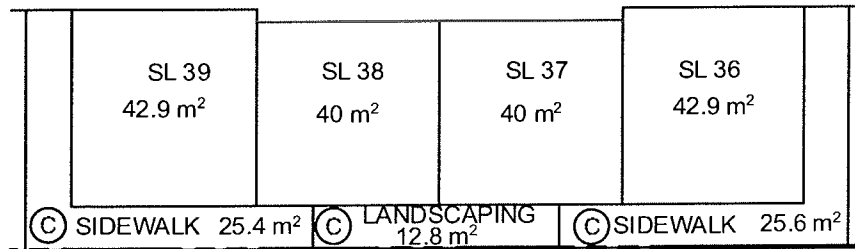

SCALE 1 : 250

FLOOR PLANS

BUILDING 3 - GROUND LEVEL
STRATA LOTS 12 - 18

LEGEND

- m² DENOTES SQUARE METRES
- SL 6 DENOTES STRATA LOT
- P DENOTES PATIO
- Y DENOTES YARD
- ⊙ DENOTES GENERAL COMMON PROPERTY
- ⊕ DENOTES LIMITED COMMON PROPERTY FOR INDICATED SL

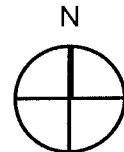
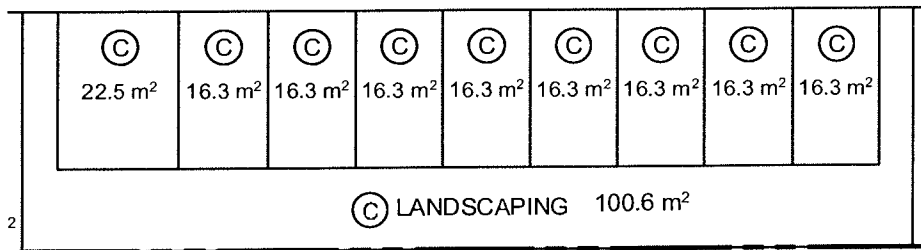
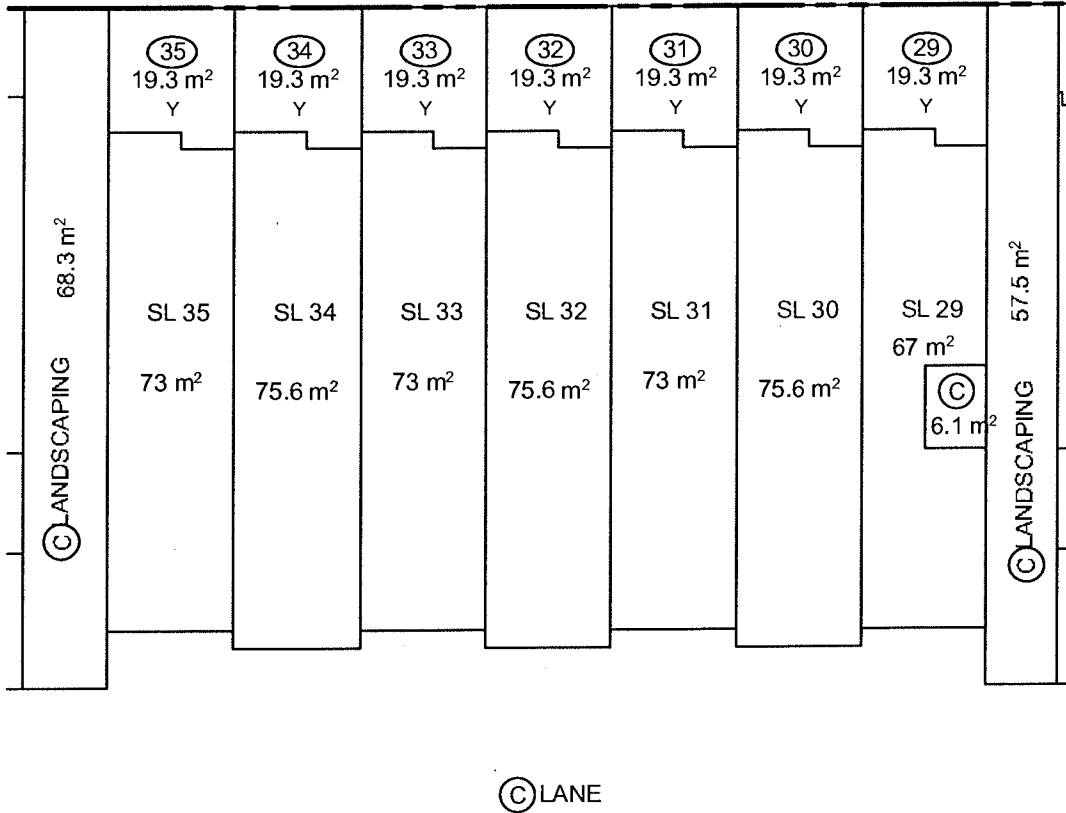

SCALE 1 : 250

FLOOR PLANS

BUILDING 4 - GROUND LEVEL
STRATA LOTS 19 - 23

LEGEND

- m² DENOTES SQUARE METRES
- SL 6 DENOTES STRATA LOT
- P DENOTES PATIO
- Y DENOTES YARD
- ⊙ DENOTES GENERAL COMMON PROPERTY
- Ⓟ DENOTES LIMITED COMMON PROPERTY FOR INDICATED SL

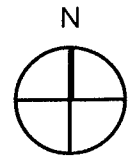
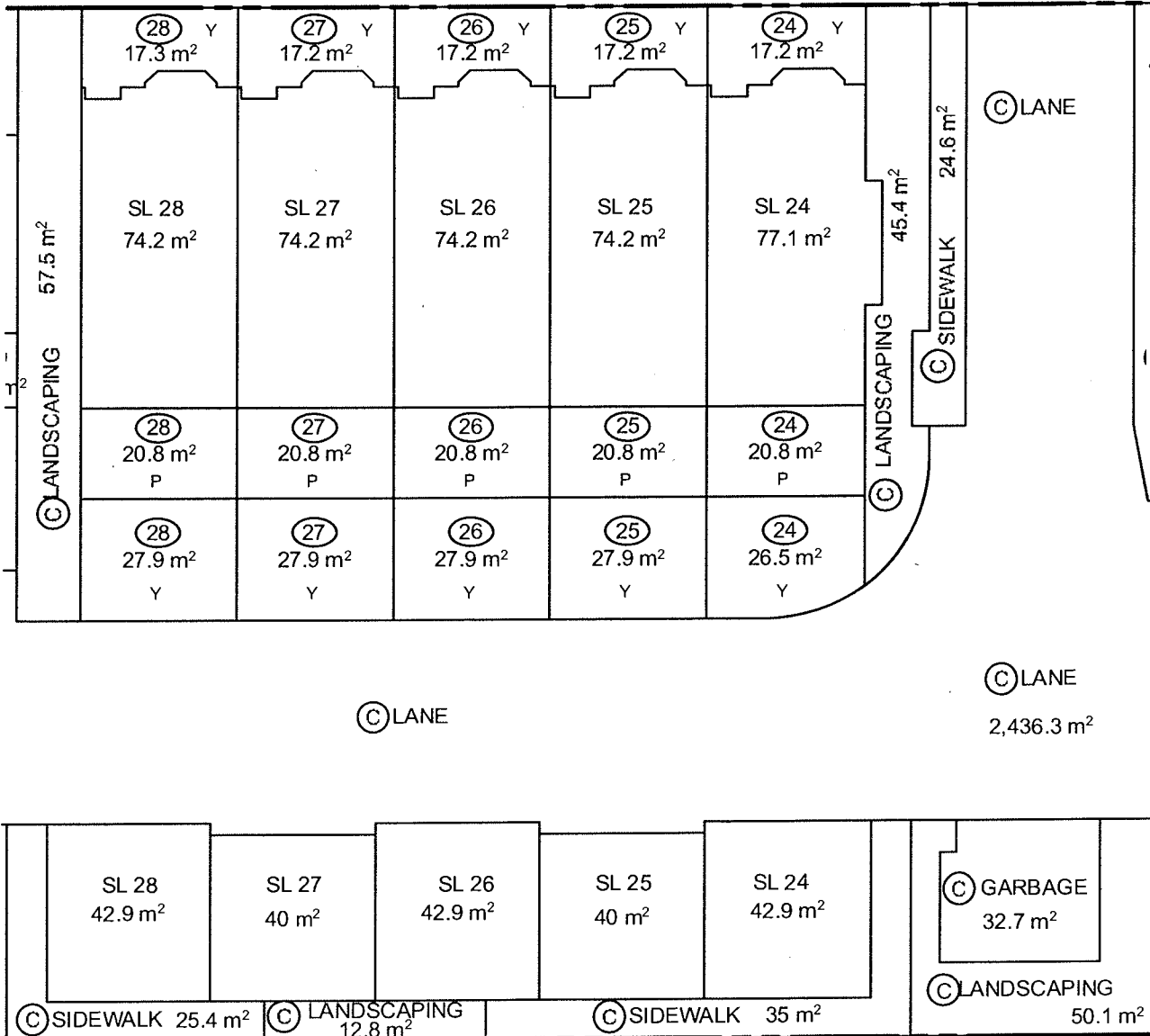

SCALE 1 : 250

FLOOR PLANS

BUILDING 5 - GROUND LEVEL
STRATA LOTS 24 - 28

LEGEND

- m² DENOTES SQUARE METRES
- SL 6 DENOTES STRATALOT
- P DENOTES PATIO
- Y DENOTES YARD
- Ⓢ DENOTES GENERAL COMMON PROPERTY
- Ⓣ DENOTES LIMITED COMMON PROPERTY FOR INDICATED SL

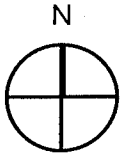
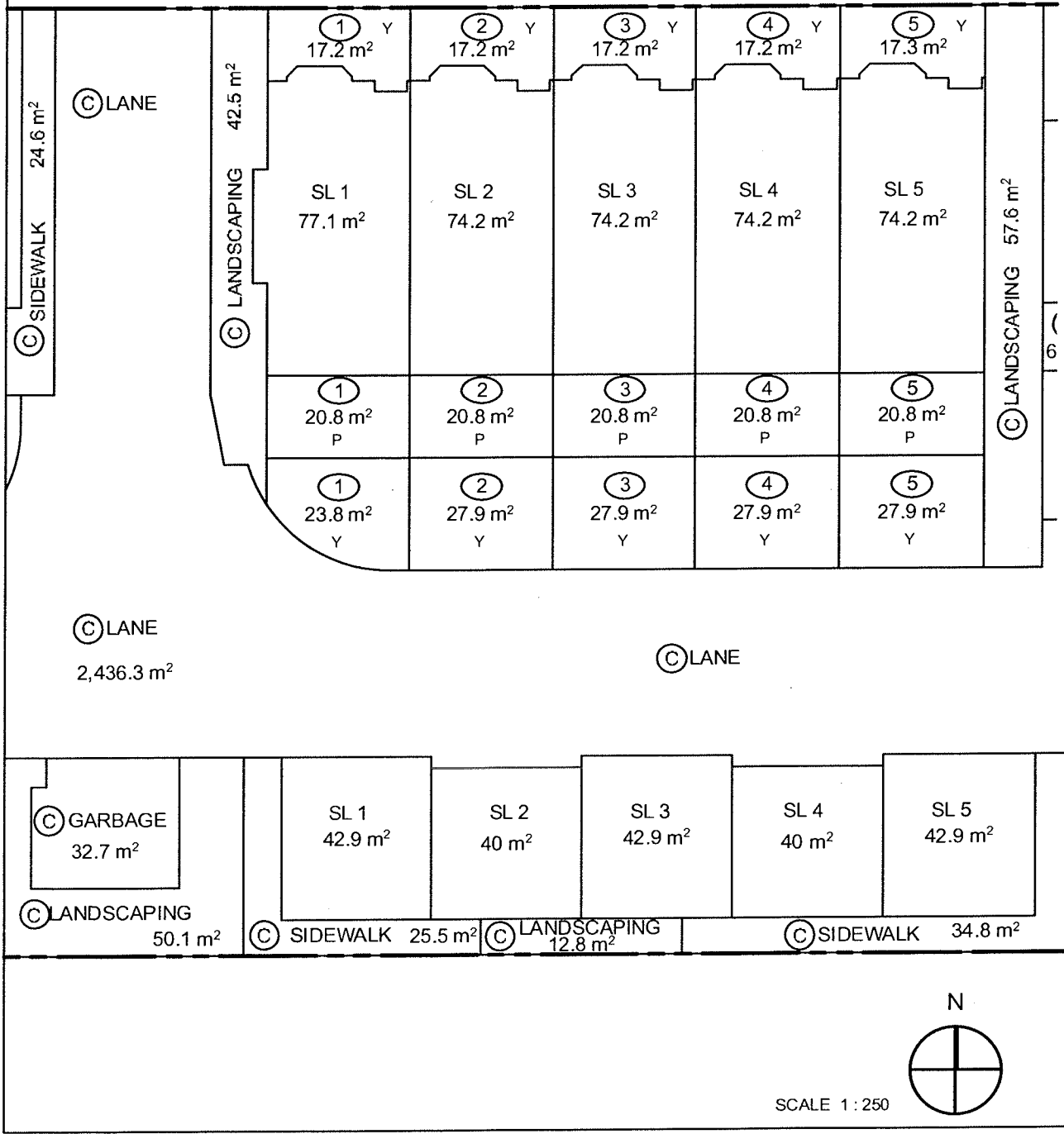

SCALE 1 : 250

FLOOR PLANS

BUILDING 6 - GROUND LEVEL
STRATA LOTS 29 - 35

LEGEND

- m² DENOTES SQUARE METRES
- SL 6 DENOTES STRATA LOT
- P DENOTES PATIO
- Y DENOTES YARD
- ⊙ DENOTES GENERAL COMMON PROPERTY
- ⊕ DENOTES LIMITED COMMON PROPERTY FOR INDICATED SL

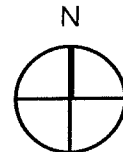
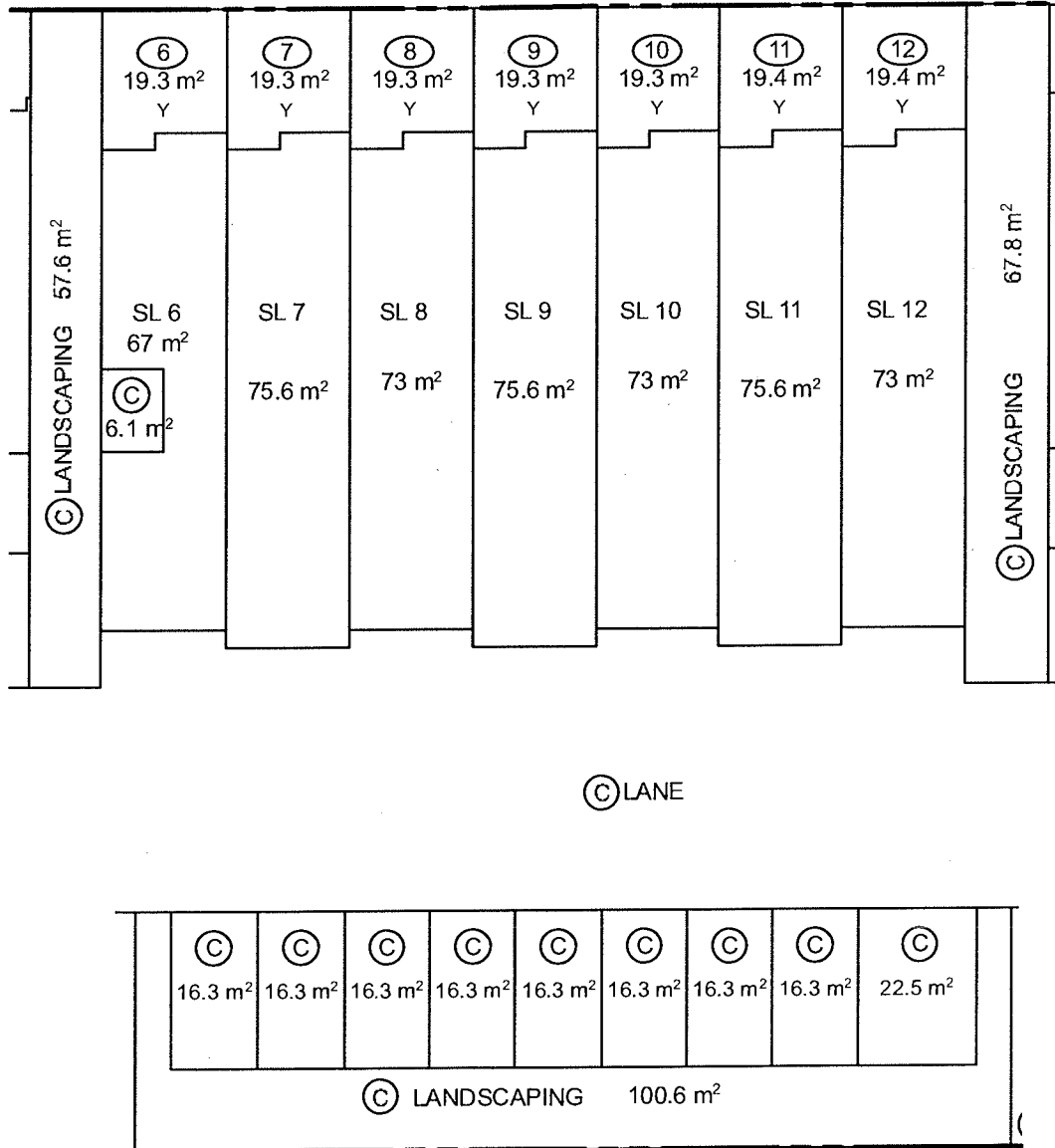

SCALE 1 : 250

FLOOR PLANS

BUILDING 7 - GROUND LEVEL
STRATA LOTS 36 - 39

LEGEND

- m² DENOTES SQUARE METRES
- SL 6 DENOTES STRATA LOT
- P DENOTES PATIO
- Y DENOTES YARD
- Ⓢ DENOTES GENERAL COMMON PROPERTY
- Ⓣ DENOTES LIMITED COMMON PROPERTY FOR INDICATED SL

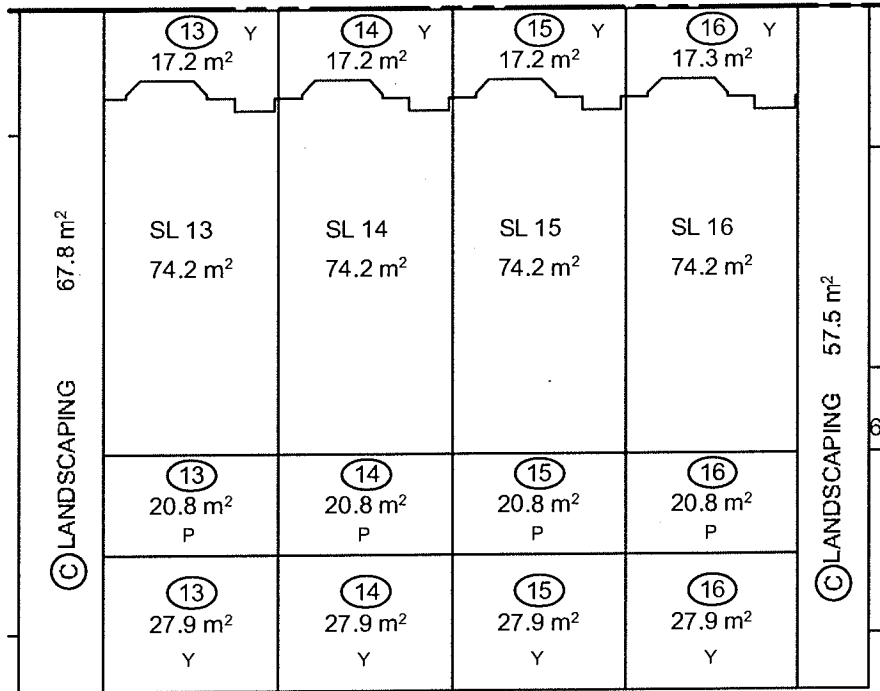

Ⓢ LANE

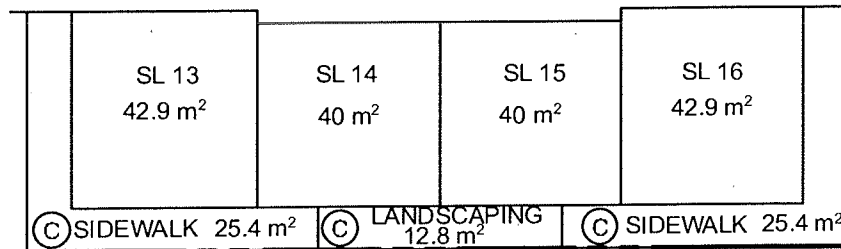

SCALE 1 : 250

FLOOR PLANS

BUILDING 8 - GROUND LEVEL
STRATA LOTS 40 - 46

LEGEND

- m² DENOTES SQUARE METRES
- SL 6 DENOTES STRATA LOT
- P DENOTES PATIO
- Y DENOTES YARD
- Ⓢ DENOTES GENERAL COMMON PROPERTY
- Ⓣ DENOTES LIMITED COMMON PROPERTY FOR INDICATED SL

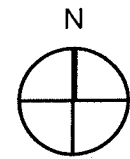
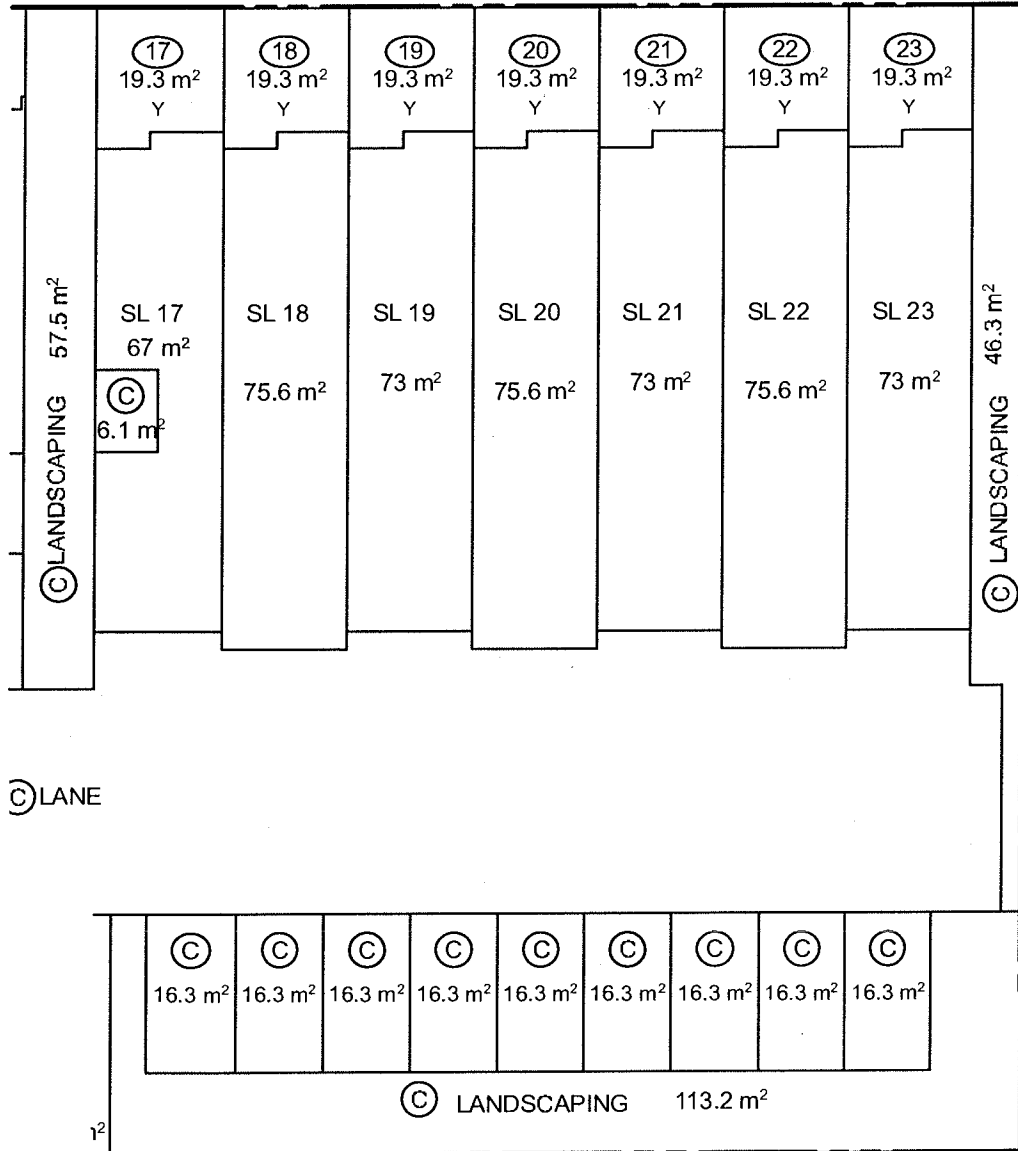

SCALE 1:250

FLOOR PLANS

BUILDING 1 - LEVEL 2
STRATA LOTS 1 - 7

LEGEND

- m² DENOTES SQUARE METRES
- SL 6 DENOTES STRATA LOT
- D DENOTES DECK
- ⑤ DENOTE LIMITED COMMON PROPERTY FOR INDICATED SL

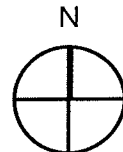
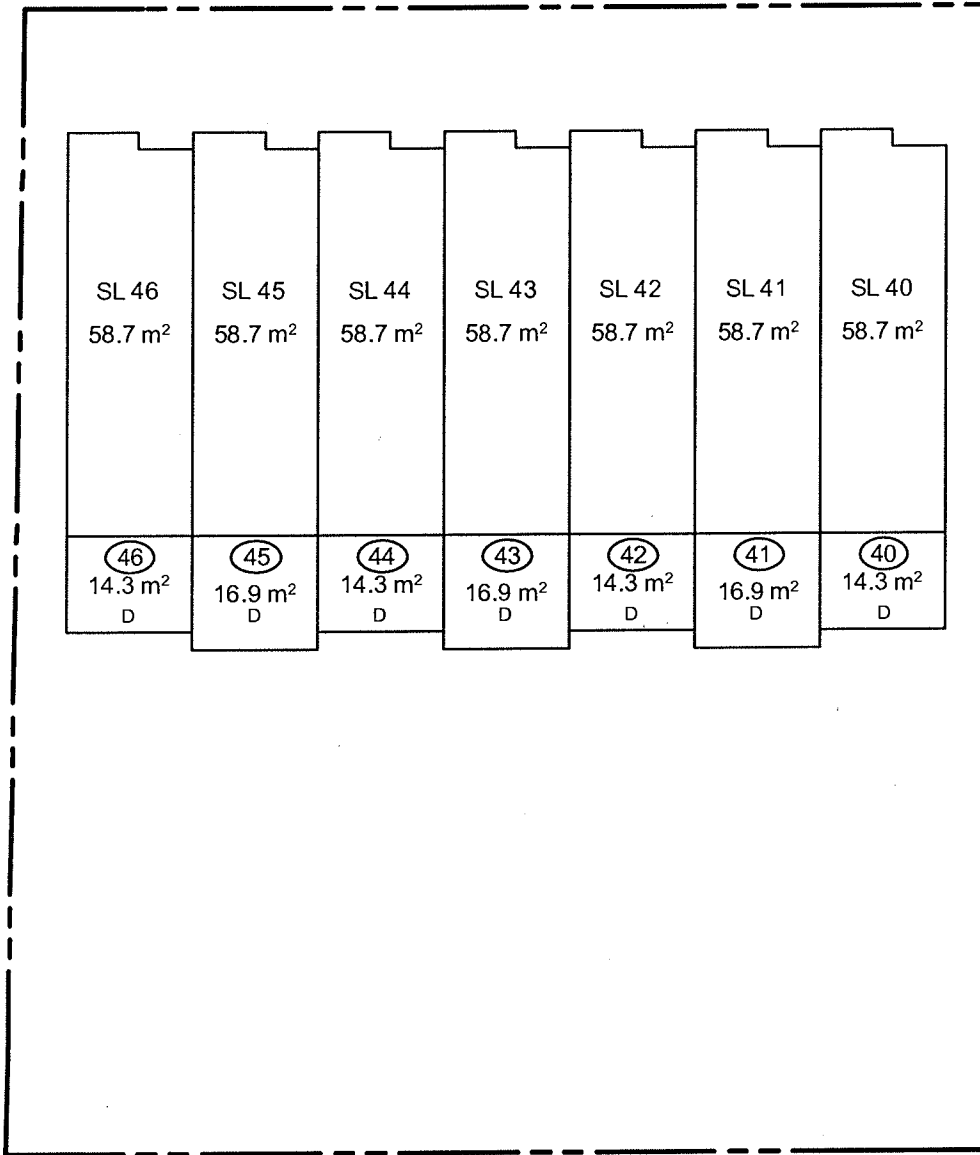

SCALE 1 : 250

FLOOR PLANS

BUILDING 2 - LEVEL 2
STRATA LOTS 8 - 11

SHEET 15 OF 25

LEGEND

- m² DENOTES SQUARE METRES
- SL 6 DENOTES STRATALOT
- D DENOTES DECK
- Ⓢ DENOTE LIMITED COMMON PROPERTY FOR INDICATED SL

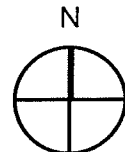
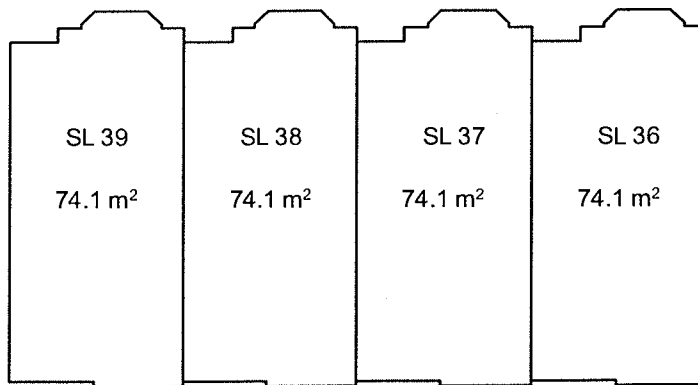

SCALE 1:250

FLOOR PLANS

BUILDING 3 - LEVEL 2
STRATA LOTS 12 - 18

LEGEND

- m² DENOTES SQUARE METRES
- SL 6 DENOTES STRATA LOT
- D DENOTES DECK
- ⑤ DENOTE LIMITED COMMON PROPERTY FOR INDICATED SL

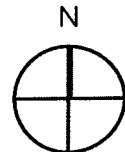
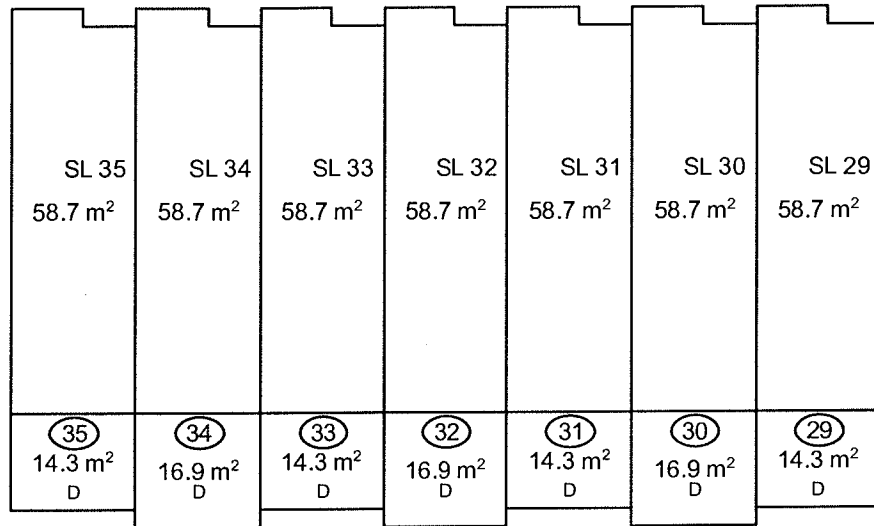

SCALE 1:250

FLOOR PLANS

BUILDING 4 - LEVEL 2
STRATA LOTS 19 - 23

LEGEND

- m² DENOTES SQUARE METRES
- SL 6 DENOTES STRATA LOT
- D DENOTES DECK
- ⑤ DENOTE LIMITED COMMON PROPERTY FOR INDICATED SL

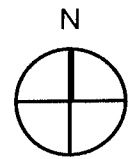
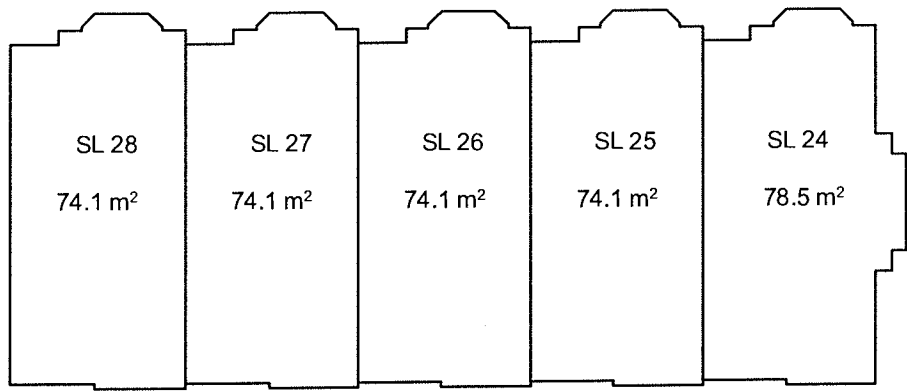

SCALE 1 : 250

FLOOR PLANS

BUILDING 5 - LEVEL 2
STRATA LOTS 24 - 28

LEGEND

- m² DENOTES SQUARE METRES
- SL 6 DENOTES STRATA LOT
- D DENOTES DECK
- ⑤ DENOTE LIMITED COMMON PROPERTY FOR INDICATED SL

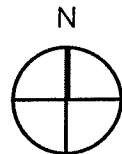
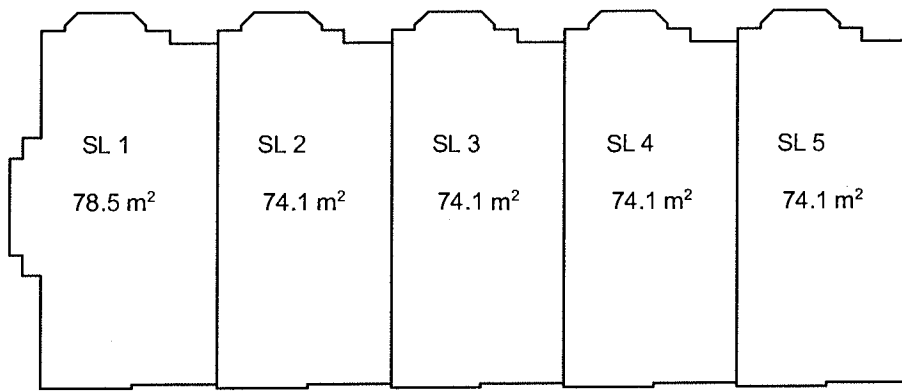

SCALE 1 : 250

FLOOR PLANS

BUILDING 6 - LEVEL 2
STRATA LOTS 29 - 35

LEGEND

- m² DENOTES SQUARE METRES
- SL 6 DENOTES STRATA LOT
- D DENOTES DECK
- ⑤ DENOTE LIMITED COMMON PROPERTY FOR INDICATED SL

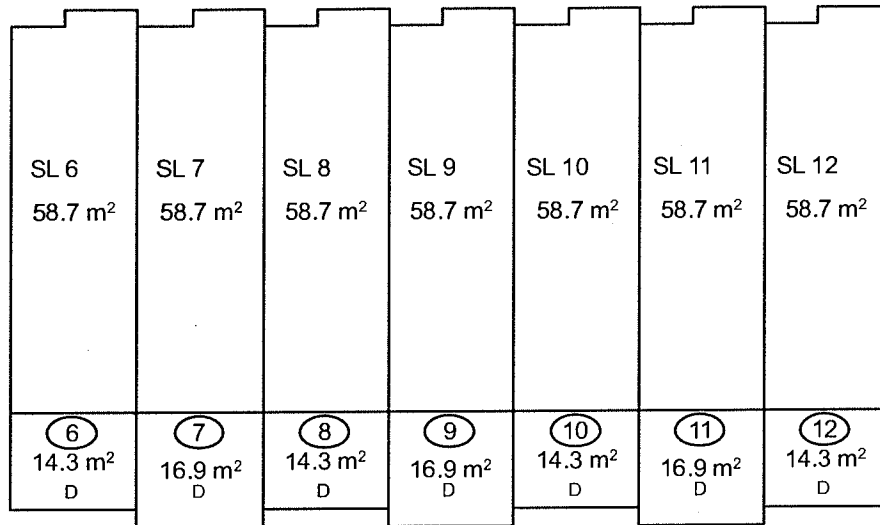

SCALE 1 : 250

FLOOR PLANS

BUILDING 7 - LEVEL 2
STRATA LOTS 36 - 39

LEGEND

- m² DENOTES SQUARE METRES
- SL 6 DENOTES STRATA LOT
- ◻ DENOTES DECK
- ⑤ DENOTE LIMITED COMMON PROPERTY FOR INDICATED SL

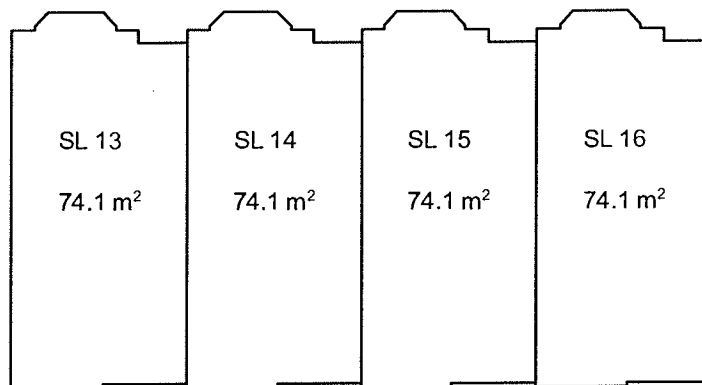

SCALE 1 : 250

FLOOR PLANS

BUILDING 8 - LEVEL 2
STRATA LOTS 40 - 46

LEGEND

- m² DENOTES SQUARE METRES
- SL 6 DENOTES STRATALOT
- DENOTES DECK
- ⑤ DENOTE LIMITED COMMON PROPERTY FOR INDICATED SL

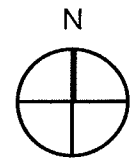
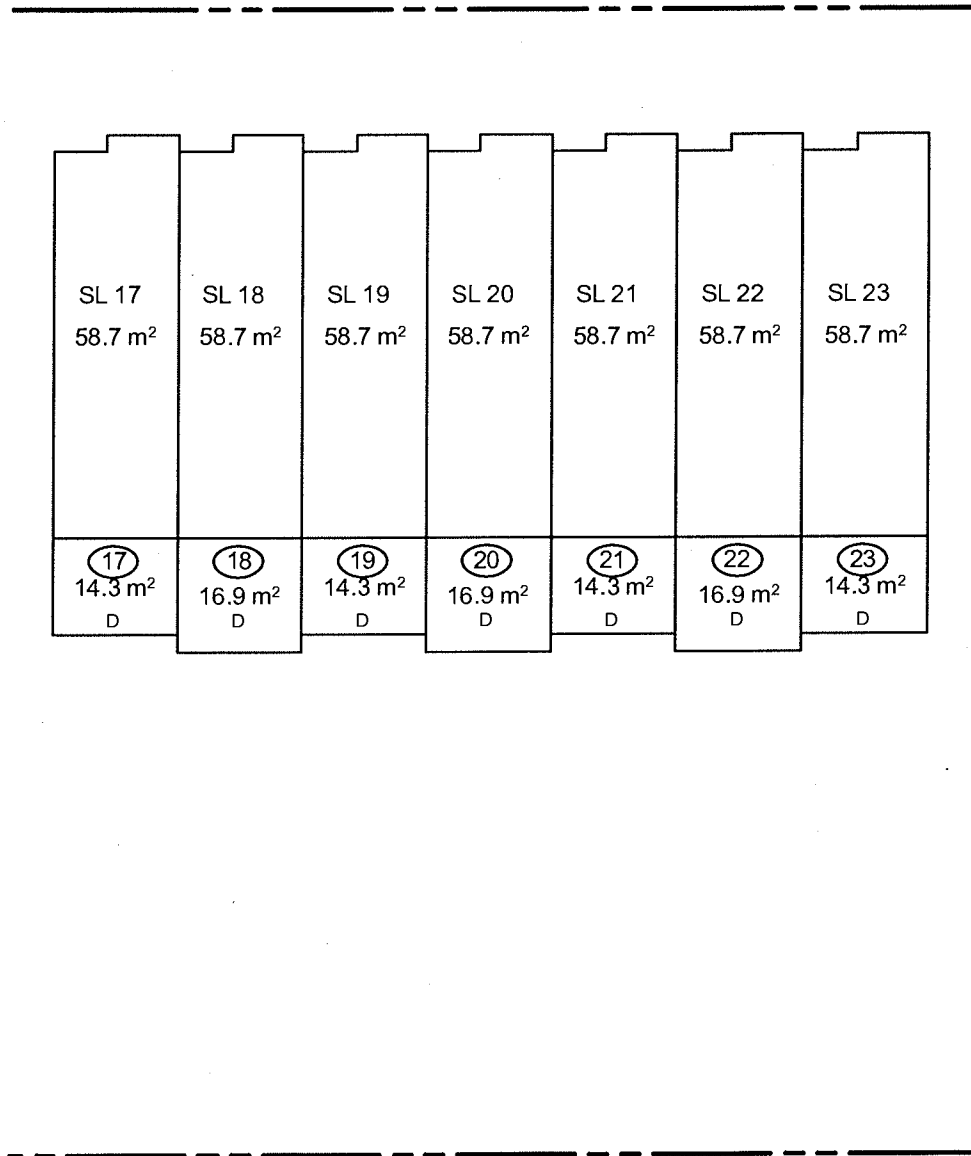

SCALE 1:250

FLOOR PLANS

BUILDING 1 - LEVEL 3
STRATA LOTS 1 - 7

LEGEND

- m² DENOTES SQUARE METRES
- SL 6 DENOTES STRATA LOT
- D DENOTES DECK
- ⑤ DENOTE LIMITED COMMON PROPERTY FOR INDICATED SL

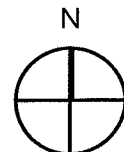
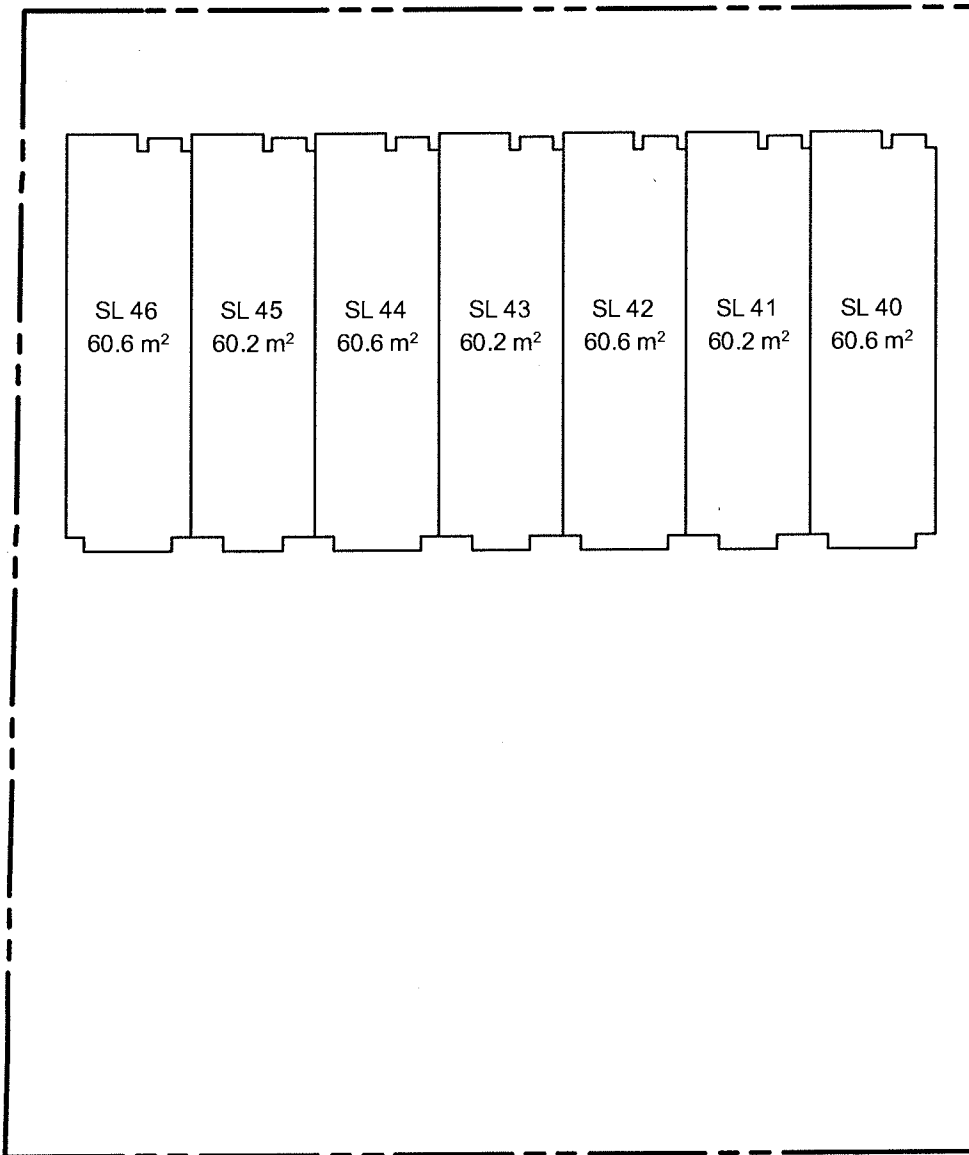

SCALE 1:250

FLOOR PLANS

BUILDING 3 - LEVEL 3
STRATALOTS 12 - 18

LEGEND

- m² DENOTES SQUARE METRES
- SL 6 DENOTES STRATA LOT
- D DENOTES DECK
- ⑤ DENOTE LIMITED COMMON PROPERTY FOR INDICATED SL

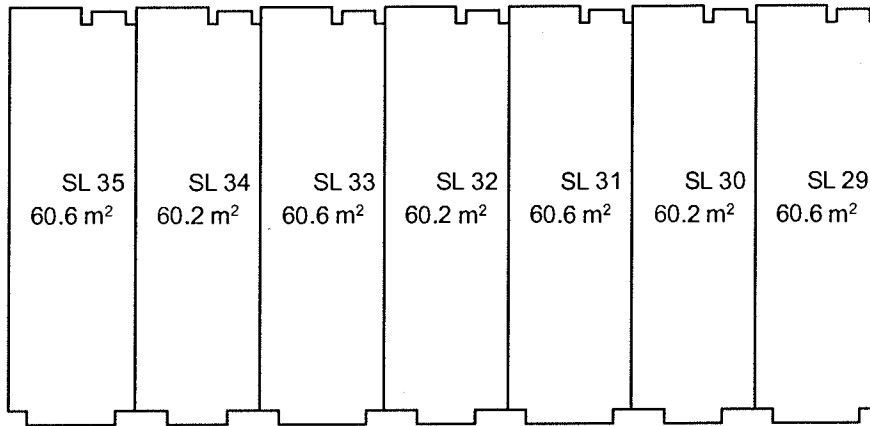

SCALE 1:250

FLOOR PLANS

BUILDING 6 - LEVEL 3
STRATA LOTS 29 - 35

LEGEND

- m² DENOTES SQUARE METRES
- SL 6 DENOTES STRATA LOT
- D DENOTES DECK
- ⑤ DENOTE LIMITED COMMON PROPERTY FOR INDICATED SL

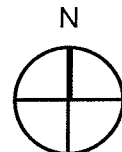
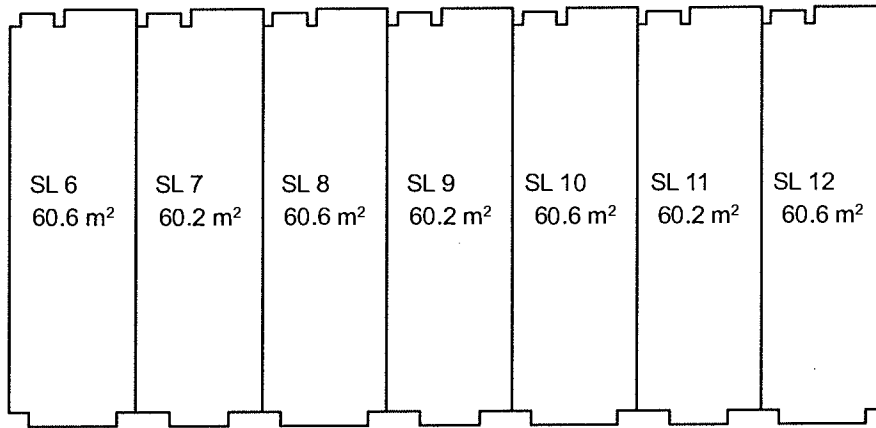

SCALE 1 : 250

FLOOR PLANS

BUILDING 8 - LEVEL 3
STRATA LOTS 40 - 46

LEGEND

- m² DENOTES SQUARE METRES
- SL 6 DENOTES STRATA LOT
- D DENOTES DECK
- ⑤ DENOTE LIMITED COMMON PROPERTY FOR INDICATED SL

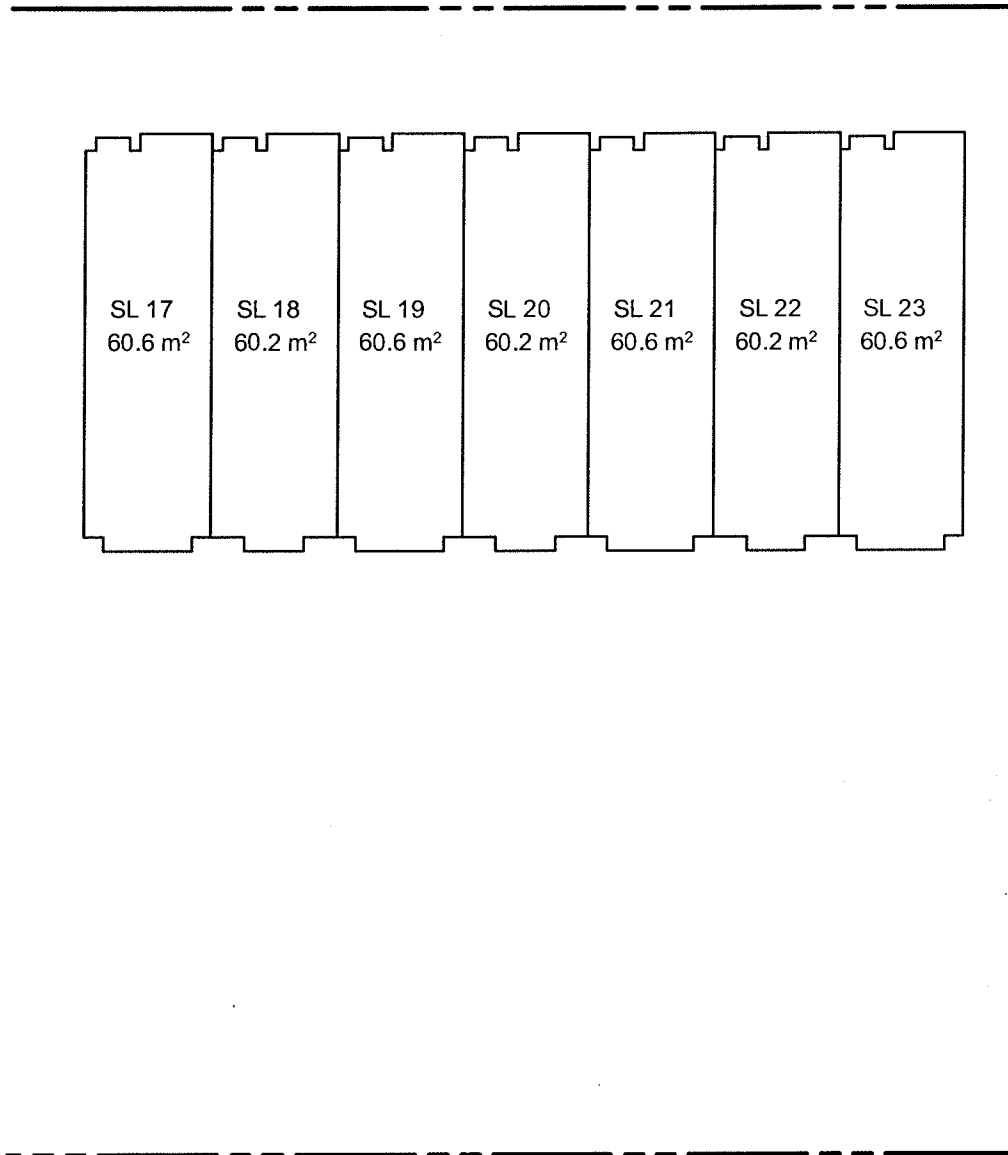

SCALE 1:250

Exhibit "B"
Zoning ~ Medium Density Townhouse Zone (RM45)

420 – Medium Density Townhouse Zone (RM45)

RM45

Intent: To accommodate townhouse developments at medium densities, up to 45 units per hectare

420.1 Permitted Uses

Permitted Uses Table for RM45 Zone	
Principal Uses	
.1	Townhouse
Accessory Uses	
.2	Boarding
.3	Home Occupation – Level 1

420.2 Site Specific Permitted Uses

n/a

420.3 Development Regulations

Development Regulations Table for RM45 Zone	
Column I	Column II
.1 Density (maximum)	a. Dwelling units per hectare – 45
.2 Minimum setbacks (front lot line)	a. Principal Building – 6.0 m, except 3.0 m where a dwelling unit fronts a street b. Accessory Building or Structure – 6.0 m
.3 Minimum setbacks (all other lot lines)	a. Principal Building – 4.5 m, except 1.8 m from an interior lot line shared with an RS lot where the dwelling unit fronts a street b. Accessory Building or Structure – 4.5m, except 1.0 m from a rear or interior lot line
.4 Height (maximum)	a. Principal Building – 9.5 m or three storeys, whichever is less b. Accessory Building or Structure – 4.5 m
.5 Lot coverage (maximum)	a. 40%

420.4 Landscaping and Off-Street Parking

Refer to sections 140 and 150 for requirements pertaining to landscaping and off-street parking.

420.5 Conditions of Use

- .1 A portion of any lot used for a Townhouse use shall be provided as common outdoor amenity area, in the amount of 3.0 m² per dwelling unit, and shall not be located within the required setbacks. For the purposes of this section, common outdoor amenity area means an area or areas:
 - a. available for all residents of the principal buildings;
 - b. having no dimension less than 6.0 m or slope greater than 5%; and
 - c. providing for pedestrian amenities, greenery, recreational space, and other leisure activities normally carried out outdoors.

Exhibit "C"
Form P Phased Strata Plan Declaration

Strata Property Act

FORM P
PHASED STRATA PLAN DECLARATION
(Sections 221, 222)

I, Dave Algra, one of the directors of **Algra Bros. Developments (Lynn) Ltd.** (Incorporation No. 0977131) (hereinafter called the "Company") of 5848 Sappers Way, Chilliwack, B.C., V2R 0G7 hereby declare:

- 1 That the Company intends to create a strata plan by way of phased development of the following land which the Company owns:

PID: 029-441-358

Parcel 1 Section 16 Township 16 New Westminster District Plan EPP44781

- 2 That the plan of development is as follows:

(a) The development comprises of four (4) phases each to be filed consecutively starting with Phase 1. There are no common facilities included in the development.

(b) A sketch plan is attached hereto and shows:

- (i) all the land included in the phased strata plan;
- (ii) the present parcel boundaries;
- (iii) the approximate boundaries of each phase;
- (iv) the approximate location of the common facilities;

(c) The estimated date for the beginning of construction and completion of construction of each phase is as below:

Phase	Estimated Beginning of Construction	Estimated Completion Date of Construction
Phase 1	December 15, 2014	July 15, 2015
Phase 2	June 15, 2015	December 15, 2015
Phase 3	November 15, 2015	May 15, 2016
Phase 4	June 15, 2016	December 15, 2016

(d) The unit entitlement of each phase and the total unit entitlement of the completed development is as follows:

Phase	Total Unit Entitlement of Phase
Phase 1	2,472
Phase 2	2,239
Phase 3	2,472
Phase 4	2,239
Total Unit Entitlement of Completed Development:	9,422

(e) The development will consist of 46 units as follows:

Phase	General Type of Residence	Total Units
Phase 1 (Buildings 5, 6)	Seven 3-storey townhouse units with attached garage, Five 2-storey with basement townhouse units with separate garage building	12 units
Phase 2 (Buildings 7, 8)	Seven 3-storey townhouse units with attached garage, Four 2-storey with basement townhouse units with separate garage building	11 units
Phase 3 (Buildings 3, 4)	Seven 3-storey townhouse units with attached garage, Five 2-storey with basement townhouse units with separate garage building	12 units
Phase 4 (Buildings 1, 2)	Seven 3-storey townhouse units with attached garage, Four 2-storey with basement townhouse units with separate garage building	11 units

3. The Company shall elect to proceed with each phase on or by the following dates:

Phase	Date
Phase 1	July 15, 2016
Phase 2	December 15, 2016
Phase 3	May 15, 2017
Phase 4	December 15, 2017

Algra Bros. Developments (Lynn) Ltd.

Per:

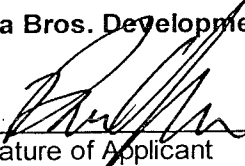

 Signature of Applicant

Date of approval: **APR 30/15**

Signature of Approving Officer
 City of Abbotsford

Exhibit "D"
Proposed Form V Schedule of Unit Entitlement

Strata Property Act

FORM V

SCHEDULE OF UNIT ENTITLEMENT

(Sections 245(a), 246, 264)

Re: Proposed Strata Plan EPS2708 Being a Strata plan of Parcel 1 Section 16 Township 16
NWD Plan EPP44781

029-441-358

Phase 1: Strata Plan EPS2708

Complete and file only the applicable form of schedule.

STRATA PLAN CONSISTING ENTIRELY OF RESIDENTIAL STRATA LOTS

The unit entitlement for each residential strata lot is one of the following [*check appropriate box*], as set out in the following table:

- (a) the habitable area of the strata lot, in square metres, rounded to the nearest whole-number as determined by a British Columbia land surveyor as set out in section 246(3)(a)(i) of the *Strata Property Act*.

Certificate of British Columbia Land Surveyor

I, Devon Pallmann, a British Columbia land surveyor,
certify that the following table reflects the habitable area of
each residential strata lot.

Date: March 30, 2015

Devon
Pallmann

Signature

FH7L64

Digitally signed by Devon
Pallmann FH7L64
DN: c=CA, cn=Devon Pallmann
FH7L64, o=BC Land Surveyor,
ou=Verify ID at www.juricert.com/
LKUP.cfm?id=FH7L64
Date: 2015.03.30 15:47:45 -07'00'

OR

- (b) a whole number that is the same for all of the residential strata lots as set out in section 246(3)(a)(ii) of the *Strata Property Act*.

OR

- (c) a number that is approved by the Superintendent of Real Estate in accordance with section 246(3)(a)(iii) of the *Strata Property Act*.

Signature of Superintendent of Real Estate

Strata Lot No.	Sheet No.	Habitable Area in m ²	Unit Entitlement	%* of Total Unit Entitlement**
1	4, 10, 18	232.7	233	
2	4, 10, 18	222.5	223	
3	4, 10, 18	222.5	223	
4	4, 10, 18	222.5	223	
5	4, 10, 18	222.5	223	
6	11, 19, 24	186.3	186	
7	11, 19, 24	194.5	195	
8	11, 19, 24	192.3	192	
9	11, 19, 24	194.5	195	
10	11, 19, 24	192.3	192	
11	11, 19, 24	194.5	195	
12	11, 19, 24	192.3	192	
Total number of lots in Phase 1: 12			Total unit entitlement for Phase 1: 2,472	

* expression of percentage is for informational purposes only and has no legal effect

** not required for a phase of a phased strata plan

Date: _____

Signature of Owner Developer

Signature of Superintendent of Real Estate (if submitted under section 264 of the Act)

Strata Property Act

FORM V

SCHEDULE OF UNIT ENTITLEMENT

(Sections 245(a), 246, 264)

Re: Proposed Strata Plan EPS2708 Being a Strata plan of Parcel 1 Section 16 Township 16
NWD Plan EPP44781 EXCEPT: Strata Plan EPS2708

029-441-358

Phase 2: Strata Plan EPS2708

Complete and file only the applicable form of schedule.

STRATA PLAN CONSISTING ENTIRELY OF RESIDENTIAL STRATA LOTS

The unit entitlement for each residential strata lot is one of the following [*check appropriate box*], as set out in the following table:

- (a) the habitable area of the strata lot, in square metres, rounded to the nearest whole number as determined by a British Columbia land surveyor as set out in section 246(3)(a)(i) of the *Strata Property Act*.

Certificate of British Columbia Land Surveyor

I, Devon Pallmann, a British Columbia land surveyor,
certify that the following table reflects the habitable area of
each residential strata lot.

Date: March 30, 2015

Signature _____ **Devon Pallmann**
FH7L64

Digitally signed by Devon Pallmann
FH7L64
DN: c=CA, cn=Devon Pallmann
FH7L64, o=BC Land Surveyor,
@bc.verifyid.at/www.juricert.com/
LKIP.cfm?id=FH7L64
Date: 2015.03.30 16:16:01 -0700

OR

- (b) a whole number that is the same for all of the residential strata lots as set out in section 246(3)(a)(ii) of the *Strata Property Act*.

OR

- (c) a number that is approved by the Superintendent of Real Estate in accordance with section 246(3)(a)(iii) of the *Strata Property Act*.

Signature of Superintendent of Real Estate

Strata Lot No.	Sheet No.	Habitable Area in m ²	Unit Entitlement	%* of Total Unit Entitlement**
13	5, 12, 20	222.5	223	
14	5, 12, 20	222.5	223	
15	5, 12, 20	222.5	223	
16	5, 12, 20	222.5	223	
17	13, 21, 25	186.3	186	
18	13, 21, 25	194.5	195	
19	13, 21, 25	192.3	192	
20	13, 21, 25	194.5	195	
21	13, 21, 25	192.3	192	
22	13, 21, 25	194.5	195	
23	13, 21, 25	192.3	192	
Total number of lots in Phase 2: 11			Total unit entitlement for Phase 2: 2,239	

* expression of percentage is for informational purposes only and has no legal effect

** not required for a phase of a phased strata plan

Date: _____

Signature of Owner Developer

Signature of Superintendent of Real Estate (if submitted under section 264 of the Act)

Strata Property Act

FORM V

SCHEDULE OF UNIT ENTITLEMENT

(Sections 245(a), 246, 264)

Re: Proposed Strata Plan EPS2708 Being a Strata plan of Parcel 1 Section 16 Township 16
NWD Plan EPP44781 EXCEPT: Strata Plan EPS2708

029-441-358

Phase 3: Strata Plan EPS2708

Complete and file only the applicable form of schedule.

STRATA PLAN CONSISTING ENTIRELY OF RESIDENTIAL STRATA LOTS

The unit entitlement for each residential strata lot is one of the following [check appropriate box], as set out in the following table:

- (a) the habitable area of the strata lot, in square metres, rounded to the nearest whole number as determined by a British Columbia land surveyor as set out in section 246(3)(a)(i) of the *Strata Property Act*.

Certificate of British Columbia Land Surveyor

I, Devon Pallmann, a British Columbia land surveyor,
certify that the following table reflects the habitable area of
each residential strata lot.

Date: March 30, 2015

Signature

Devon

Pallmann

FH7L64

Digitally signed by Devon
Pallmann FH7L64
DN: c=CA, cn=Devon Pallmann
FH7L64, o=BC Land Surveyor,
e=Verify ID at
www.julien.com/LKJP.cfm?
id=FH7L64
Date: 2015.03.30 16:16:39 -07'00

OR

- (b) a whole number that is the same for all of the residential strata lots as set out in section 246(3)(a)(ii) of the *Strata Property Act*.

OR

- (c) a number that is approved by the Superintendent of Real Estate in accordance with section 246(3)(a)(iii) of the *Strata Property Act*.

Signature of Superintendent of Real Estate

Strata Lot No.	Sheet No.	Habitable Area in m ²	Unit Entitlement	%* of Total Unit Entitlement**
24	3, 9, 17	232.7	233	
25	3, 9, 17	222.5	223	
26	3, 9, 17	222.5	223	
27	3, 9, 17	222.5	223	
28	3, 9, 17	222.5	223	
29	8, 16, 23	186.3	186	
30	8, 16, 23	194.5	195	
31	8, 16, 23	192.3	192	
32	8, 16, 23	194.5	195	
33	8, 16, 23	192.3	192	
34	8, 16, 23	194.5	195	
35	8, 16, 23	192.3	192	
Total number of lots in Phase 3: 12			Total unit entitlement for Phase 3: 2,472	

* expression of percentage is for informational purposes only and has no legal effect

** not required for a phase of a phased strata plan

Date: _____

Signature of Owner Developer

Signature of Superintendent of Real Estate (if submitted under section 264 of the Act)

Strata Property Act

FORM V

SCHEDULE OF UNIT ENTITLEMENT

(Sections 245(a), 246, 264)

Re: Proposed Strata Plan EPS2708 Being a Strata plan of Parcel 1 Section 16 Township 16
NWD Plan EPP44781 EXCEPT: Strata Plan EPS2708

29-441-358

Phase 4: Strata Plan EPS2708

Complete and file only the applicable form of schedule.

STRATA PLAN CONSISTING ENTIRELY OF RESIDENTIAL STRATA LOTS

The unit entitlement for each residential strata lot is one of the following [*check appropriate box*], as set out in the following table:

- (a) the habitable area of the strata lot, in square metres, rounded to the nearest whole number as determined by a British Columbia land surveyor as set out in section 246(3)(a)(i) of the *Strata Property Act*.

Certificate of British Columbia Land Surveyor

I, Devon Pallmann, a British Columbia land surveyor,
certify that the following table reflects the habitable area of
each residential strata lot.

Date: March 30, 2015

Signature

Devon

Pallmann

FH7L64

Digitally signed by Devon
Pallmann FH7L64
DN: cn=CA, cn=Devon Pallmann,
FH7L64, o=BC Land Surveyor,
ou=Verify ID at
www.bclscert.com/LKUP.cfm?
id=FH7L64,
Date: 2015.03.30 16:17:08 -07'00'

OR

- (b) a whole number that is the same for all of the residential strata lots as set out in section 246(3)(a)(ii) of the *Strata Property Act*.

OR

- (c) a number that is approved by the Superintendent of Real Estate in accordance with section 246(3)(a)(iii) of the *Strata Property Act*.

Signature of Superintendent of Real Estate

Strata Lot No.	Sheet No.	Habitable Area in m ²	Unit Entitlement	%* of Total Unit Entitlement**
36	2, 7, 15	222.5	223	
37	2, 7, 15	222.5	223	
38	2, 7, 15	222.5	223	
39	2, 7, 15	222.5	223	
40	6, 14, 22	186.3	186	
41	6, 14, 22	194.5	195	
42	6, 14, 22	192.3	192	
43	6, 14, 22	194.5	195	
44	6, 14, 22	192.3	192	
45	6, 14, 22	194.5	195	
46	6, 14, 22	192.3	192	
Total number of lots in Phase 4: 11			Total unit entitlement for Phase 4: 2,239	

- * expression of percentage is for informational purposes only and has no legal effect
- ** not required for a phase of a phased strata plan

Date: _____

Signature of Owner Developer

Signature of Superintendent of Real Estate (if submitted under section 264 of the Act)

Exhibit "E"
Proposed Bylaw Changes

Strata Property Act

FORM Y OWNER DEVELOPERS' NOTICE OF DIFFERENT BYLAWS

(Section 245(d); Regulations section 14.6(2))

Re: Strata Plan EPS ____ being a strata plan of PID: 029-441-358 Parcel 1 Section 16 Township 16 New Westminster District Plan EPP44781

The following or attached bylaws differ from the Standard Bylaws to the *Strata Property Act*, permitted by section 120 of the Act:

Use of property

- 3(1) An owner, tenant, occupant or visitor must not use a strata lot, the common property or common assets in a way that:
 - (a) causes a nuisance or hazard to another person,
 - (b) causes unreasonable noise,
 - (c) unreasonably interferes with the rights of other persons to use and enjoy the common property, common assets or another strata lot,
 - (d) is illegal, or
 - (e) is contrary to a purpose for which the strata lot or common property is intended as shown expressly or by necessary implication on or by the strata plan.
- (2) An owner, tenant, occupant or visitor may not cause damage, other than reasonable wear and tear, to the common property, common assets or those parts of a strata lot which the strata corporation must repair and maintain under these bylaws or insure under section 149 of the Act.
- (3) An owner, tenant, occupant or visitor must ensure that all animals are leashed or otherwise secured when on the common property or on land that is a common asset.
- (4) An owner, tenant, occupant must not keep any pets on a strata lot other than one or more of the following:
 - (a) a reasonable number of fish or other small aquarium animals;
 - (b) a reasonable number of small caged mammals;
 - (c) up to 2 caged birds;
 - (d) up to 3 pets consisting of not more than two dogs or not more than two cats over the age of 6 months;
- (5) Pet owners are responsible for immediate removal of all pet waste which is left anywhere on the common property or public sidewalks or boulevards adjoining the property.

- (6) Pet owners will be required to pay a \$20.00 clean up fee to the landscaping maintenance company for any pet waste which is left on a strata lot during weekly scheduled lawn maintenance days.
- (7) Owners are responsible for any damages caused by their pets or the pets of their tenants or guests.
- (8) Owners will be required to pay a \$10.00 clean up fee to the landscaping maintenance company for any personal items which are left on the strata lot during weekly scheduled lawn maintenance days.

Repair and maintenance of property by Strata Corporation

8 The strata corporation must repair and maintain all of the following:

- (a) common assets of the strata corporation;
- (b) common property that has not been designated as limited common property;
- (c) limited common property, but the duty to repair and maintain it is restricted to:
 - (i) repair and maintenance that in the ordinary course of events occurs less often than once a year, and
 - (ii) the following, no matter how often the repair or maintenance ordinarily occurs:
 - (A) the structure of a building;
 - (B) the exterior of a building;
 - (C) chimneys, stairs, balconies and other things attached to the exterior of a building;
 - (D) doors, windows and skylights on the exterior of a building or that front on the common property;
 - (E) fences, railings and similar structures that enclose patios, balconies and yards;
 - (F) mowing, fertilization and aerating of rear limited common property strata lot yards;
 - (G) clean up of leaves, branches and other landscape debris in front limited common property strata lot yards;
- (d) a strata lot in a strata plan that is not a bare land strata plan, but the duty to repair and maintain it is restricted to:
 - (i) the structure of a building;
 - (ii) the exterior of a building,
 - (iii) chimneys, stairs, balconies and other things attached to the exterior of a building,
 - (iv) doors, windows and skylights on the exterior of a building or that front on the common property, and
 - (v) fences, railings and similar structures that enclose patios, balconies and yards

Miscellaneous Rules

- 31 (1) An owner shall not install any heating, ventilation or air conditioning devices ("hvac") in any window of any strata lot. Should the developer make provisions for future installation of hvac, such hvac must be installed in an area predetermined by the developer. An owner must have the hvac unit and all associated piping and wiring be similar in size to hvac units already installed by the developer. An owner must have the hvac unit installed by a certified professional.

Date: _____, 2015

Signature of Owner Developer

Exhibit "F"
Proposed Budget

BUDGET

PREPARED FOR:

Aston Row
Lynn Ave
Abbotsford BC

Algra Brothers / Developer

PREPARED BY:

Teamwork Property Management Ltd.
#105 - 34143 Marshall Road
Abbotsford, BC V2S 1L8
Tel: (604) 854-1734

	Phase 1	Phase 2	Phase 3	Phase 4
	12 Units	11 Units	12 Units	11 Units
TOTAL UNITS	12 Units	23 Units	35 Units	46 Units
INCOME				
Strata Fees	<u>18,628.22</u>	<u>35,704.10</u>	<u>54,332.32</u>	<u>71,408.19</u>
TOTAL INCOME	18,628.22	35,704.10	54,332.32	71,408.19
GENERAL EXPENSES				
Insurance	7,052.35	13,517.00	20,569.35	27,034.00
Insurance Appraisal	65.22	125.00	190.22	250.00
Administration	260.87	500.00	760.87	1,000.00
Management	2,073.60	3,974.40	6,048.00	7,948.80
Bank Charges	26.09	50.00	76.09	100.00
Professional / Legal	259.57	497.50	757.07	995.00
Warranty Inspection	521.74	1,000.00	<u>1,521.74</u>	<u>2,000.00</u>
TOTAL GENERAL EXPENSES	10,259.43	19,663.90	29,923.33	39,327.80
BUILDING EXPENSES				
Repairs & Maintenance	521.74	1,000.00	1,521.74	2,000.00
Landscaping	5,760.00	11,040.00	16,800.00	22,080.00
Hydro - Electricity	130.43	250.00	380.43	500.00
Water	130.43	250.00	380.43	500.00
Refuse Removal	469.57	900.00	1,369.57	1,800.00
Snow Removal	<u>365.22</u>	<u>700.00</u>	<u>1,065.22</u>	<u>1,400.00</u>
TOTAL BUILDING EXPENSES	7,377.39	14,140.00	21,517.39	28,280.00
Contingency Reserve Fund	<u>881.84</u>	<u>1,690.20</u>	<u>2,572.04</u>	<u>3,380.39</u>
TOTAL EXPENSES	18,518.66	35,494.10	54,012.75	70,988.19
NET INCOME	109.57	210.00	319.57	420.00

ASTON ROW

67,607.80

3,380.39

70,988.19

Operating Fund

Contingency Fund

Strata Fees Total

Unit	S.L. #	U/E Ent	Operating Fund	Contingency Fund	Strata Fees
1	46	192	114.82	5.74	120.56
2	45	195	116.61	5.83	122.45
3	44	192	114.82	5.74	120.56
4	43	195	116.61	5.83	122.45
5	42	192	114.82	5.74	120.56
6	41	195	116.61	5.83	122.45
7	40	186	111.23	5.56	116.79
8	39	223	133.36	6.67	140.03
9	38	223	133.36	6.67	140.03
10	37	223	133.36	6.67	140.03
11	36	223	133.36	6.67	140.03
12	35	192	114.82	5.74	120.56
13	34	195	116.61	5.83	122.45
14	33	192	114.82	5.74	120.56
15	32	195	116.61	5.83	122.45
16	31	192	114.82	5.74	120.56
17	30	195	116.61	5.83	122.45
18	29	186	111.23	5.56	116.79
19	28	223	133.36	6.67	140.03
20	27	223	133.36	6.67	140.03
21	26	223	133.36	6.67	140.03
22	25	223	133.36	6.67	140.03
23	24	233	139.34	6.97	146.31
		4711			2,958.16

Total Unit Entitlement	9,421
Total Monthly Fees	5,915.68
Total Annual Fees	70,988.19

Unit	S.L. #	U/E Ent	Operating Fund	Contingency Fund	Strata Fees
24	1	233	139.34	6.97	146.31
25	2	223	133.36	6.67	140.03
26	3	223	133.36	6.67	140.03
27	4	223	133.36	6.67	140.03
28	5	223	133.36	6.67	140.03
29	6	186	111.23	5.56	116.79
30	7	195	116.61	5.83	122.45
31	8	192	114.82	5.74	120.56
32	9	195	116.61	5.83	122.45
33	10	192	114.82	5.74	120.56
34	11	194	116.02	5.80	121.82
35	12	192	114.82	5.74	120.56
36	13	223	133.36	6.67	140.03
37	14	223	133.36	6.67	140.03
38	15	223	133.36	6.67	140.03
39	16	223	133.36	6.67	140.03
40	17	186	111.23	5.56	116.79
41	18	195	116.61	5.83	122.45
42	19	192	114.82	5.74	120.56
43	20	195	116.61	5.83	122.45
44	21	192	114.82	5.74	120.56
45	22	195	116.61	5.83	122.45
46	23	192	114.82	5.74	120.56
		4710			2,957.53

Exhibit "G"
Rental Disclosure Statement

Strata Property Act
Form J
(am. B.C. Reg 312/2009, s.8.)
RENTAL DISCLOSURE STATEMENT
(Section 139)

Re: PID: 029-441-358 Parcel 1 Section 16 Township 16 New Westminster District Plan EPP44781

This Rental Disclosure Statement is:

√ the first Rental Disclosure Statement filed in relation to the above-noted strata plan

a changed Rental Disclosure Statement filed under section 139(4) of the *Strata Property Act*, and the original Rental Disclosure Statement filed in relation to the above-noted strata plan was filed on _____.

1. The development described above includes 46 residential strata lots.
2. The residential strata lots described below are rented out by the owner developer as of the date of this statement and the owner developer intends to rent out each strata lot until the date set out opposite its description.

Description of Strata Lot	Date Rental Period Expires

*Section 143(2) of the *Strata Property Act* provides that, if this Rental Disclosure Statement is filed after December 31, 2009, a bylaw that prohibits or limits rentals will not apply to a strata lot described in this table until the date set out in the table opposite the description of the strata lot, whether or not the strata lot is conveyed before that date.

3. In addition to the number of residential strata lots rented out by the owner developer as of the date of this statement, the owner developer reserves the right to rent out a further 46 residential strata lots, as described below, until the date set out opposite each strata lot's description.

Description of Strata Lot	Date Rental Period Expires
Strata Lot 1	May 1, 2115
Strata Lot 2	May 1, 2115
Strata Lot 3	May 1, 2115
Strata Lot 4	May 1, 2115
Strata Lot 5	May 1, 2115

Strata Lot 6	May 1, 2115
Strata Lot 7	May 1, 2115
Strata Lot 8	May 1, 2115
Strata Lot 9	May 1, 2115
Strata Lot 10	May 1, 2115
Strata Lot 11	May 1, 2115
Strata Lot 12	May 1, 2115
Strata Lot 13	May 1, 2115
Strata Lot 14	May 1, 2115
Strata Lot 15	May 1, 2115
Strata Lot 16	May 1, 2115
Strata Lot 17	May 1, 2115
Strata Lot 18	May 1, 2115
Strata Lot 19	May 1, 2115
Strata Lot 20	May 1, 2115
Strata Lot 21	May 1, 2115
Strata Lot 22	May 1, 2115
Strata Lot 23	May 1, 2115
Strata Lot 24	May 1, 2115
Strata Lot 25	May 1, 2115
Strata Lot 26	May 1, 2115
Strata Lot 27	May 1, 2115
Strata Lot 28	May 1, 2115
Strata Lot 29	May 1, 2115
Strata Lot 30	May 1, 2115
Strata Lot 31	May 1, 2115
Strata Lot 32	May 1, 2115
Strata Lot 33	May 1, 2115
Strata Lot 34	May 1, 2115
Strata Lot 35	May 1, 2115
Strata Lot 36	May 1, 2115
Strata Lot 37	May 1, 2115
Strata Lot 38	May 1, 2115
Strata Lot 39	May 1, 2115
Strata Lot 40	May 1, 2115
Strata Lot 41	May 1, 2115
Strata Lot 42	May 1, 2115
Strata Lot 43	May 1, 2115
Strata Lot 44	May 1, 2115
Strata Lot 45	May 1, 2115
Strata Lot 46	May 1, 2115

*Section 143(2) of the *Strata Property Act* provides that, if this Rental Disclosure Statement is filed after December 31, 2009, a bylaw that prohibits or limits rentals will not apply to a strata lot described in this table until the date set out in the table opposite the description of the strata lot, whether or not the strata lot is conveyed before that date.

4. There is no bylaw of the strata corporation that restricts the rental of strata lots.

Date: May 6/15

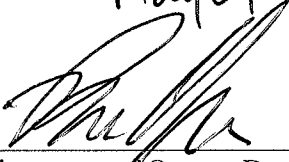
A handwritten signature in black ink, appearing to be 'D. M. S.', written over a horizontal line.

Signature of Owner Developer

Exhibit "H"
Proposed Contract of Purchase and Sale



CONTRACT OF PURCHASE AND SALE

BROKERAGE: Sutton Showplace Realty (2015) DATE: _____
 ADDRESS: _____ PC: _____ PHONE: _____
 PREPARED BY: Shantell Owens MLS® NO: _____

SELLER: <u>Algra Bros Developments (Lynn) Ltd.</u>	BUYER: _____
SELLER: _____	BUYER: _____
ADDRESS: <u>5848 Sappers Way, Chilliwack BC V2R 0G7</u>	ADDRESS: _____
_____ PC: _____	_____ PC: _____
PHONE: <u>604-798-6169</u>	PHONE: _____
RESIDENT OF CANADA <input checked="" type="checkbox"/> NON-RESIDENT OF CANADA <input type="checkbox"/>	OCCUPATION: _____
as defined under the <i>Income Tax Act</i> .	

PROPERTY:

33460 Lynn Avenue

UNIT NO.	ADDRESS OF PROPERTY
<u>Abbotsford</u>	<u>V2S 1E3</u>
CITY/TOWN/MUNICIPALITY	POSTAL CODE

PID	OTHER PID(S)
<u>SL</u>	<u>Parcel 1 Section 16 Township 16 NWD Plan EPP44781</u>
LEGAL DESCRIPTION	

The Buyer agrees to purchase the Property from the Seller on the following terms and subject to the following conditions:

1. **PURCHASE PRICE:** The purchase price of the Property will be _____
 _____ DOLLARS \$ _____ (Purchase Price)

2. **DEPOSIT:** A deposit of \$ _____ which will form part of the Purchase Price, will be paid **within 24 hours of acceptance** unless agreed as follows:
 SEE ADDENDUM

~~All monies paid pursuant to this section (Deposit) will be paid in accordance with section 10 or by uncertified cheque except as otherwise set out in this section 2 and will be delivered in trust to Rosborough & Co and held in trust in accordance with the provisions of the *Real Estate Services Act*. In the event the Buyer fails to pay the Deposit as required by this Contract, the Seller may, at the Seller's option, terminate this Contract. The party who receives the Deposit is authorized to pay all or any portion of the Deposit to the Buyer's or Seller's conveyancer (the "Conveyancer") without further written direction of the Buyer or Seller, provided that: (a) the Conveyancer is a Lawyer or Notary; (b) such money is to be held in trust by the Conveyancer as stakeholder pursuant to the provisions of the *Real Estate Services Act* pending the completion of the transaction and not on behalf of any of the principals to the transaction; and (c) if the sale does not complete, the money should be returned to such party as stakeholder or paid into Court.~~

--	--	--	--

INITIALS

PROPERTY ADDRESS

3. **TERMS AND CONDITIONS:** The purchase and sale of the Property includes the following terms and is subject to the following conditions:
SEE ATTACHED ADDENDUM

Each condition, if so indicated is for the sole benefit of the party indicated. Unless each condition is waived or declared fulfilled by written notice given by the benefiting party to the other party on or before the date specified for each condition, this Contract will be terminated thereupon and the Deposit returnable in accordance with the *Real Estate Services Act* ^{development marketing}

4. **COMPLETION:** The sale will be completed on _____, yr. _____ (Completion Date) at the appropriate Land Title Office.

5. **POSSESSION:** The Buyer will have vacant possession of the Property at _____ m. on _____, yr. _____ (Possession Date) OR, subject to the following existing tenancies, if any:

6. **ADJUSTMENTS:** The Buyer will assume and pay all taxes, rates, local improvement assessments, fuel utilities and other charges from, and including, the date set for adjustments, and all adjustments both incoming and outgoing of whatsoever nature will be made as of _____, yr. _____ (Adjustment Date).

7. **INCLUDED ITEMS:** The Purchase Price includes any buildings, improvements, fixtures, appurtenances and attachments thereto, and all blinds, awnings, screen doors and windows, curtain rods, tracks and valances, fixed mirrors, fixed carpeting, electric, plumbing, heating and air conditioning fixtures and all appurtenances and attachments thereto as viewed by the Buyer at the date of inspection, INCLUDING:
SEE ATTACHED ADDENDUM

BUT EXCLUDING: _____

8. **VIEWED:** The Property and all included items will be in substantially the same condition at the Possession Date as when viewed by the Buyer on New Construction _____, yr. _____

9. **TITLE:** Free and clear of all encumbrances except subsisting conditions, provisos, restrictions exceptions and reservations, including royalties, contained in the original grant or contained in any other grant or disposition from the Crown, registered or pending restrictive covenants and rights-of-way in favour of utilities and public authorities, existing tenancies set out in Clause 5, if any, and except as otherwise set out herein.

10. **TENDER:** Tender or payment of monies by the Buyer to the Seller will be by certified cheque, bank draft, cash or Lawyer's/Notary's or real estate brokerage's trust cheque.

11. **DOCUMENTS:** All documents required to give effect to this Contract will be delivered in registrable form where necessary and will be lodged for registration in the appropriate Land Title Office by 4 pm on the Completion Date.

INITIALS

PROPERTY ADDRESS

12. **TIME:** Time will be of the essence hereof, and unless the balance of the cash payment is paid and such formal agreements to pay the balance as may be necessary is entered into on or before the Completion Date, the Seller may, at the Seller's option, terminate this Contract, and, in such event, the amount paid by the Buyer will be non-refundable and absolutely forfeited to the Seller in accordance with the *Real Estate Services Act*, on account of damages, without prejudice to the Seller's other remedies.

Development Marketing

13. **BUYER FINANCING:** If the Buyer is relying upon a new mortgage to finance the Purchase Price, the Buyer, while still required to pay the Purchase Price on the Completion Date, may wait to pay the Purchase Price to the Seller until after the transfer and new mortgage documents have been lodged for registration in the appropriate Land Title Office, but only if, before such lodging, the Buyer has: (a) made available for tender to the Seller that portion of the Purchase Price not secured by the new mortgage, and (b) fulfilled all the new mortgagee's conditions for funding except lodging the mortgage for registration, and (c) made available to the Seller, a Lawyer's or Notary's undertaking to pay the Purchase Price upon the lodging of the transfer and new mortgage documents and the advance by the mortgagee of the mortgage proceeds pursuant to the Canadian Bar Association (BC Branch) (Real Property Section) standard undertakings (the "CBA Standard Undertakings").

14. **CLEARING TITLE:** If the Seller has existing financial charges to be cleared from title, the Seller, while still required to clear such charges, may wait to pay and discharge existing financial charges until immediately after receipt of the Purchase Price, but in this event, the Seller agrees that payment of the Purchase Price shall be made by the Buyer's Lawyer or Notary to the Seller's Lawyer or Notary, on the CBA Standard Undertakings to pay out and discharge the financial charges, and remit the balance, if any, to the Seller.

15. **COSTS:** The Buyer will bear all costs of the conveyance and, if applicable, any costs related to arranging a mortgage and the Seller will bear all costs of clearing title.

16. **RISK:** All buildings on the Property and all other items included in the purchase and sale will be, and remain, at the risk of the Seller until 12:01 am on the Completion Date. After that time, the Property and all included items will be at the risk of the Buyer.

17. **PLURAL:** In this Contract, any reference to a party includes that party's heirs, executors, administrators, successors and assigns; singular includes plural and masculine includes feminine.

18. **REPRESENTATIONS AND WARRANTIES:** There are no representations, warranties, guarantees, promises or agreements other than those set out in this Contract and the representations contained in the Property Disclosure Statement if incorporated into and forming part of this Contract, all of which will survive the completion of the sale.

19. **PERSONAL INFORMATION:** The Buyer and the Seller hereby consent to the collection, use and disclosure by the Brokerages and by the managing broker(s), associate broker(s) and representative(s) of those Brokerages (collectively the "Licensee(s)") described in Clause 20, the real estate boards of which those Brokerages and Licensees are members and, if the Property is listed on a Multiple Listing Service®, the real estate board that operates the Multiple Listing Service®, of personal information about the Buyer and the Seller:

- A. for all purposes consistent with the transaction contemplated herein;
- B. if the Property is listed on a Multiple Listing Service®, for the purpose of the compilation, retention and publication by the real estate board that operates the Multiple Listing Service® and other real estate boards of any statistics including historical Multiple Listing Service® data for use by persons authorized to use the Multiple Listing Service® of that real estate board and other real estate boards;
- C. for enforcing codes of professional conduct and ethics for members of real estate boards; and
- D. for the purposes (and to the recipients) described in the brochure published by the British Columbia Real Estate Association entitled *Working With a REALTOR®*.

--	--	--	--

INITIALS

PROPERTY ADDRESS

20. AGENCY DISCLOSURE: The Seller and the Buyer acknowledge having received, read and understood the brochure published by the British Columbia Real Estate Association entitled Working With a REALTOR® and acknowledge and confirm as follows:

A. the Seller has an agency relationship with

DESIGNATED AGENT/LICENSEE who is licensed in relation to BROKERAGE

B. the Buyer has an agency relationship with

DESIGNATED AGENT/LICENSEE who is licensed in relation to BROKERAGE

C. the Buyer and the Seller have consented to a limited dual agency relationship with

Shantell Owens

DESIGNATED AGENT/LICENSEE

who is/are licensed in relation to Landmark Realty Chilliwack Ltd BROKERAGE

having signed a Limited Dual Agency Agreement dated

If only (A) has been completed, the Buyer is acknowledging no agency relationship. If only (B) has been completed, the Seller is acknowledging no agency relationship.

21. ACCEPTANCE IRREVOCABLE (Buyer and Seller): The Seller and the Buyer specifically confirm that this Contract of Purchase and Sale is executed under seal. It is agreed and understood that the Seller's acceptance is irrevocable, including without limitation, during the period prior to the date specified for the Buyer to either:

- A. fulfill or waive the terms and conditions herein contained; and/or
B. exercise any option(s) herein contained.

22. THIS IS A LEGAL DOCUMENT. READ THIS ENTIRE DOCUMENT AND INFORMATION PAGE BEFORE YOU SIGN.

23. OFFER: This offer, or counter-offer, will be open for acceptance until o'clock m. on yr. (unless withdrawn in writing with notification to the other party of such revocation prior to notification of its acceptance), and upon acceptance of the offer, or counter-offer, by accepting in writing and notifying the other party of such acceptance, there will be a binding Contract of Purchase and Sale on the terms and conditions set forth.

X WITNESS BUYER SEAL PRINT NAME

X WITNESS BUYER SEAL PRINT NAME

24. ACCEPTANCE: The Seller (a) hereby accepts the above offer and agrees to complete the sale upon the terms and conditions set out above, (b) agrees to pay a commission as per the Listing Contract, and (c) authorizes and instructs the Buyer and anyone acting on behalf of the Buyer or Seller to pay the commission out of the proceeds of sale and forward copies of the Seller's Statement of Adjustments to the Cooperating/Listing Brokerage, as requested forthwith after completion.

Seller's acceptance is dated yr.

X WITNESS SELLER SEAL Algra Bros Developments (Lynn) PRINT NAME

X WITNESS SELLER SEAL PRINT NAME

CONTRACT OF PURCHASE AND SALE ADDENDUM

MLS® NO.:

DATE:

PAGE 5 of 11 PAGES

33460 Lynn Avenue Abbotsford V2S 1E3

RE: ADDRESS

SL _____ Parcel 1 Section 16 Township 16 NWD Plan EPP44781

LEGAL DESCRIPTION:

PID OTHER PID(S)

FURTHER TO THE CONTRACT OF PURCHASE AND SALE DATED.....

MADE BETWEEN AS BUYER, AND

Algra Bros Developments (Lynn) Ltd. AS SELLER AND COVERING

THE ABOVE-MENTIONED PROPERTY, THE UNDERSIGNED HEREBY AGREE AS FOLLOWS:

DEPOSITS: The Buyer will pay a non-refundable deposit equal to \$ _____ (the "Deposit") upon removing all subject clauses of this Contract.

The Deposit will be paid by way of certified cheque or bank draft. The Buyer will pay the Deposit to the law firm of Rosborough & Company (the "Seller's Solicitor"), in trust, and the Deposit will be held in accordance with the Real Estate Development Marketing Act (British Columbia) pending the completion of the transaction. The Deposit will be dealt with by the Seller's Solicitor as follows:

- (a) when received, the Deposit will be deposited into a non-interest bearing trust account;
- (b) if the Buyer completes the purchase of the Property on the terms and conditions of this Contract, then the Deposit will be applied to the Purchase Price and be paid to the Seller;
- (c) if the Buyer fails to complete the purchase of the Property through no fault of the Seller, or if the Buyer fails to pay the Deposit, or any portion thereof, when due; then the Seller may, at the Seller's option, terminate this Contract, in which case the Buyer absolutely forfeits the Deposit to the Seller and the Buyer and the Seller hereby irrevocably authorize and instruct the Seller's Solicitor to release the Deposit from trust and pay it to the Seller; and
- (d) if the Seller fails to complete the sale of the Property through no fault of the Buyer, then the Deposit will be paid to the Buyer and the Buyer will have no further claims against the Seller.

The payment of any funds to the Seller pursuant to this Section 2 will not be deemed to be all inclusive liquidated damages, and will not preclude any further claims or remedies by the Seller against the Buyer.

<u>X</u> WITNESS	_____	BUYER	_____	SEAL	_____	PRINT NAME
<u>X</u> WITNESS	_____	BUYER	_____	SEAL	_____	PRINT NAME
<u>X</u> WITNESS	_____	SELLER	_____	SEAL	<u>Algra Bros Developments (Lynn) L</u>	PRINT NAME
<u>X</u> WITNESS	_____	SELLER	_____	SEAL	_____	PRINT NAME

*PREC represents Personal Real Estate Corporation

Trademarks are owned or controlled by The Canadian Real Estate Association (CREA) and identify real estate professionals who are members of CREA (REALTOR®) and/or the quality of services they provide (MLS®).

CONTRACT OF PURCHASE AND SALE ADDENDUM

MLS® NO.:

DATE:

 PAGE 6 of 11 PAGES

33460 Lynn Avenue	Abbotsford	V2S 1E3
RE: ADDRESS		
SL _____ Parcel 1 Section 16 Township 16 NWD Plan EPP44781		
LEGAL DESCRIPTION:		
PID _____ OTHER PID(S) _____		

FURTHER TO THE CONTRACT OF PURCHASE AND SALE DATED _____
 MADE BETWEEN _____ AS BUYER, AND
Algra Bros Developments (Lynn) Ltd. _____ AS SELLER AND COVERING
 THE ABOVE-MENTIONED PROPERTY, THE UNDERSIGNED HEREBY AGREE AS FOLLOWS:

****It is a fundamental term of this contract that the Seller must have finished all work, and delivered to the Buyer by the Completion Date, an unconditional Municipal/City Occupancy Certificate or other satisfactory to the Buyer that construction is finished.**

****The Buyer and an authorized representative of the Seller will jointly conduct a walk-through inspection of the property no later than 4 days before the Completion Date. The Parties will, immediately after completion of the walk-through inspection, complete a deficiency list mutually agreed upon items that are to be remedied by the Seller (the "Deficiency List"). The Deficiency List, which will form part of the contract, will identify the deficiencies and include a mutually agreed upon value for each of the deficiencies to be remedied. Both parties will sign, date and retain a copy of the Deficiency List. The quality of work and materials used to correct the deficiencies will be equal to or better than that of the Algra Bros showhome on Lynn Avenue. In the event that the deficiencies are not rectified 1 day prior to the Completion Date, the Buyer's conveyancer will hold back from the sale proceeds the amount specified for any uncorrected deficiency until all the deficiencies specified on the Deficiency List are completed, and will place this hold back in the Buyer's conveyancer's trust account.**

****The Seller agrees that if the conveyance of the Property has completed and any of the deficiencies have not been corrected, the Buyer's conveyancer will retain the specified hold back until the Seller corrects the deficiencies, which shall not be later than 120 days after the Completion Date. The Seller agrees that if the deficiencies have not been corrected by the later date, the Buyer's conveyancer may release the balance of the hold back to the Buyer and the Buyer may correct the deficiencies himself/herself.**

****Any dispute concerning the identification and pricing of deficiencies, the rectification of the deficiencies, and release of the holdback will be settled by: "arbitration under the British Columbia Commercial Arbitration Act" at the expense of (the Buyer, the Seller, or both).**

X WITNESS	BUYER	SEAL	PRINT NAME
X WITNESS	BUYER	SEAL	PRINT NAME
X WITNESS	SELLER	SEAL	Algra Bros Developments (Lynn) L PRINT NAME
X WITNESS	SELLER	SEAL	PRINT NAME

*PREC represents Personal Real Estate Corporation

Trademarks are owned or controlled by The Canadian Real Estate Association (CREA) and identify real estate professionals who are members of CREA (REALTOR®) and/or the quality of services they provide (MLS®).

CONTRACT OF PURCHASE AND SALE ADDENDUM

MLS® NO.:

DATE:

33460 Lynn Avenue

Abbotsford

V2S 1E3

RE: ADDRESS

SL Parcel 1 Section 16 Township 16 NWD Plan EPP44781

LEGAL DESCRIPTION:

PID

OTHER PID(S)

FURTHER TO THE CONTRACT OF PURCHASE AND SALE DATED.....

MADE BETWEEN..... AS BUYER, AND

Algra Bros Developments (Lynn) Ltd. AS SELLER AND COVERING

THE ABOVE-MENTIONED PROPERTY, THE UNDERSIGNED HEREBY AGREE AS FOLLOWS:

**The Seller reserves the right to extend the completion, possession, and adjustment dates up to 180 days if deemed necessary by the Seller to complete and receive an occupancy permit for the home. The Seller is required to give at least 60 days notice to the Buyer before the completion date, should the Seller be required to extend the completion, possession, and adjustment dates.

**The Buyer acknowledges and accepts that on Completion the Buyer will receive title containing, in addition to any encumbrance referred to in Clause 9 (TITLE) of this contract: 1.any non-financial charge, and 2.any financial charge payable to a utility on its right of way restrictive covenant, easement or other interest set out in the copy of the title search results that is attached to and forms part of this contract

**The Seller represents and warrants that the Seller is duly licensed pursuant to the Homeowner Protection Act and that the mandatory warranty insurance pursuant to that Act is in place. It is a fundamental term of this contract that the mandatory warranty insurance coverage required pursuant to the Homeowner Protection Act be provided.

X
WITNESS

BUYER

SEAL

PRINT NAME

X
WITNESS

BUYER

SEAL

PRINT NAME

X
WITNESS

SELLER

SEAL

Algra Bros Developments (Lynn) L
PRINT NAME

X
WITNESS

SELLER

SEAL

PRINT NAME

*PREC represents Personal Real Estate Corporation

Trademarks are owned or controlled by The Canadian Real Estate Association (CREA) and identify real estate professionals who are members of CREA (REALTOR®) and/or the quality of services they provide (MLS®).

CONTRACT OF PURCHASE AND SALE ADDENDUM

MLS® NO.:

DATE:

PAGE 8 of 11 PAGES

33460 Lynn Avenue

Abbotsford

V2S 1E3

RE: ADDRESS

SL Parcel 1 Section 16 Township 16 NWD Plan EPP44781

LEGAL DESCRIPTION:

PID

OTHER PID(S)

FURTHER TO THE CONTRACT OF PURCHASE AND SALE DATED.....

MADE BETWEEN AS BUYER, AND

Algra Bros Developments (Lynn) Ltd. AS SELLER AND COVERING

THE ABOVE-MENTIONED PROPERTY, THE UNDERSIGNED HEREBY AGREE AS FOLLOWS:

****Value Added Taxes -** The Purchase Price does not include any value added taxes, including, without limitation, GST, HST or Transition Tax (collectively "VAT"). The Buyer will pay all VAT payable in respect of the purchase in addition to the Purchase Price. The Seller agrees to credit to the Buyer the full amount of any VAT New Housing Rebate (the "Rebate") available under the Excise Tax Act or similar legislation provided that the Buyer: (a) qualifies for the Rebate; and (b) provides to the Seller before the Completion Date, an executed copy of a prescribed VAT New Housing Rebate Applicationform for purposes of claiming the Rebate and assigning it to the Seller as well as any other documentation reasonably required by the Seller in connection with the assignment and claim. Notwithstanding the foregoing, the Seller reserves the right to refuse to credit all or any portion of the Rebate claimed by the Buyer if the Seller has reason to believe that the Buyer is not entitled to the Rebate or that the Rebate amount claimed by the Buyer exceeds the Rebate to which the Buyer is entitled. By delivering an executed copy of a prescribed VAT New Housing Rebate Application form to the Seller, the Buyer warrants that the Buyer is eligible for the Rebate. If the Seller credits the Buyer with the amount of the Rebate and the Canada Revenue Agency disallows all or any part of the Rebate, the Buyer will, upon receiving a written demand from the Seller, reimburse such disallowed amounts to the Seller together with any interest, penalty or other amount payable by the Seller as a result of such disallowance.

Lien Holdback - The Buyer will holdback from the sale proceeds, as a builders lien hold-back under the Builders Lien Act, an amount equal to 7% of the net purchase price for 55 days after the date the occupancy certificate is issued for the home. The Sellers solicitor will place the hold-back in an interest-bearing trust account with interest accruing to the benefit of the Seller.

The Buyer acknowledges having received and having had an opportunity to read the developer's Disclosure Statement.

 X
WITNESS

BUYER

SEAL

PRINT NAME

 X
WITNESS

BUYER

SEAL

PRINT NAME

 X
WITNESS

SELLER

SEAL

 Algra Bros Developments (Lynn) L
PRINT NAME

 X
WITNESS

SELLER

SEAL

PRINT NAME

*PREC represents Personal Real Estate Corporation

Trademarks are owned or controlled by The Canadian Real Estate Association (CREA) and identify real estate professionals who are members of CREA (REALTOR®) and/or the quality of services they provide (MLS®).

CONTRACT OF PURCHASE AND SALE ADDENDUM

MLS® NO.:

DATE:

PAGE 9 of 11 PAGES

33460 Lynn Avenue Abbotsford V2S 1E3

RE: ADDRESS

SL _____ Parcel 1, Section 16 Township 16 NWD Plan EPP44781

LEGAL DESCRIPTION:

PID OTHER PID(S)

FURTHER TO THE CONTRACT OF PURCHASE AND SALE DATED

MADE BETWEEN AS BUYER, AND





Algra Bros Developments (Lynn) Ltd. AS SELLER AND COVERING

THE ABOVE-MENTIONED PROPERTY, THE UNDERSIGNED HEREBY AGREE AS FOLLOWS:

(Policy Statement 6): Pursuant to Policy Statement 6 (Adequate Arrangements - Utilities and Services) issued by the Superintendent of Real Estate, a developer may file a Disclosure Statement and market strata lots prior to obtaining a satisfactory financing commitment, provided that an amendment to the Disclosure Statement disclosing the particulars of a satisfactory financing commitment is filed with the superintendent within nine (9) months from the developer filing the original Disclosure Statement and subject to the following conditions:

- (a) If an amendment to the Disclosure Statement that sets out particulars of a satisfactory financing commitment is not received by the Buyer within 12 months after the initial Disclosure Statement was filed, the Buyer may at his or her option cancel this Contract at any time after the end of that 12 month period until the required amendment is received by the Buyer;
- (b) The amount of the deposit to be paid by a Buyer who has not yet received an amendment to the Disclosure Statement that sets out particulars of a satisfactory financing commitment is no more than 10% of the purchase price; and
- (c) All deposits paid by a Buyer, including interest earned if applicable, will be returned promptly to the Buyer upon notice of cancellation from the Buyer.

(Policy Statement 5): Pursuant to Policy Statement 5 (Early Marketing - Development Approval) issued by the Superintendent of Real Estate, a developer may file a disclosure statement and market strata lots prior to obtaining a building permit, provided that an amendment to the disclosure statement disclosing the particulars of the issued building permit is filed with the superintendent within nine (9) months from the developer filing the original disclosure statement and subject to the following conditions:

<u>X</u>	_____	<u>BUYER</u>		_____
WITNESS				PRINT NAME
<u>X</u>	_____	<u>BUYER</u>		_____
WITNESS				PRINT NAME
<u>X</u>	_____	<u>SELLER</u>		<u>Algra Bros Developments (Lynn) L</u>
WITNESS				PRINT NAME
<u>X</u>	_____	<u>SELLER</u>		_____
WITNESS				PRINT NAME

*PREC represents Personal Real Estate Corporation
 Trademarks are owned or controlled by The Canadian Real Estate Association (CREA) and identify real estate professionals who are members of CREA (REALTOR®) and/or the quality of services they provide (MLS®).

CONTRACT OF PURCHASE AND SALE ADDENDUM

MLS® NO.:

DATE:

PAGE 10 of 11 PAGES

33460 Lynn Avenue Abbotsford V2S 1E3

RE: ADDRESS

SL _____ Parcel 1 Section 16 Township 16 NWD Plan EPP44781

LEGAL DESCRIPTION:

PID OTHER PID(S)





FURTHER TO THE CONTRACT OF PURCHASE AND SALE DATED

MADE BETWEEN AS BUYER, AND

Algra Bros Developments (Lynn) Ltd. AS SELLER AND COVERING

THE ABOVE-MENTIONED PROPERTY, THE UNDERSIGNED HEREBY AGREE AS FOLLOWS:

- (a) The Buyer may cancel this Contract for a period of seven days after receipt of an amendment to the Disclosure Statement that sets out particulars of the issued building permit if the layout or size of the applicable development unit, the construction of a major common facility, including a recreation centre or clubhouse, or the general layout of the development, is materially changed by the issuance of the building permit;
- (b) If an amendment to the Disclosure Statement that sets out particulars of an issued building permit is not received by the Buyer within 12 months after the initial Disclosure Statement was filed, the Buyer may at his or her option cancel this Contract at any time after the end of that 12 month period until the required amendment is received by the Buyer, at which time the Buyer may cancel this Contract for a period of seven days after receipt of that amendment only if the layout or size of the applicable development unit, the construction of a major common facility, including a recreation centre or clubhouse, or the general layout of the development, is materially changed by the issuance of the building permit;
- (c) The amount of the deposit to be paid by a Buyer who has not yet received an amendment to the Disclosure Statement that sets out particulars of an issued building permit is no more than 10% of the purchase price; and
- (d) All deposits paid by a Buyer, including interest earned if applicable, will be returned promptly to the Buyer upon notice of cancellation from the Buyer.

<u>X</u>	_____	_____		_____
WITNESS		BUYER		PRINT NAME
<u>X</u>	_____	_____		_____
WITNESS		BUYER		PRINT NAME
<u>X</u>	_____	_____		Algra Bros Developments (Lynn) L
WITNESS		SELLER		PRINT NAME
<u>X</u>	_____	_____		_____
WITNESS		SELLER		PRINT NAME

*PREC represents Personal Real Estate Corporation
 Trademarks are owned or controlled by The Canadian Real Estate Association (CREA) and identify real estate professionals who are members of CREA (REALTOR®)
 and/or the quality of services they provide (MLS®).

CONTRACT OF PURCHASE AND SALE ADDENDUM

MLS® NO.:

DATE:

PAGE 11 of 11 PAGES

33460 Lynn Avenue Abbotsford V2S 1E3

RE: ADDRESS

SL _____ Parcel 1 Section 16 Township 16 NWD Plan EPP44781

LEGAL DESCRIPTION:

PID _____ OTHER PID(S) _____





FURTHER TO THE CONTRACT OF PURCHASE AND SALE DATED _____

MADE BETWEEN _____ AS BUYER, AND

Algra Bros Developments (Lynn) Ltd. AS SELLER AND COVERING

THE ABOVE-MENTIONED PROPERTY, THE UNDERSIGNED HEREBY AGREE AS FOLLOWS:

1. Subject to the Buyer receiving and approving independent legal advice regarding this contract on or before _____ . This subject is for the sole benefit of the Buyer.
2. Subject to the Buyer receiving Value Added Tax advice in regards to this transaction on or before _____ . This subject is for the sole benefit of the Buyer.
3. Subject to the Buyer receiving and approving a specification book for the construction of the home to be built on or before _____ . This subject is for the sole benefit of the Buyer.
4. Subject to the Buyer having received approval and being satisfied with financing for the subject property at suitable rates and terms on or before _____ . This condition is for the sole benefit of the Buyer.

<u>X</u>	_____	_____		_____
WITNESS		BUYER		PRINT NAME
<u>X</u>	_____	_____		_____
WITNESS		BUYER		PRINT NAME
<u>X</u>	_____	_____		<u>Algra Bros Developments (Lynn) L</u>
WITNESS		SELLER		PRINT NAME
<u>X</u>	_____	_____		_____
WITNESS		SELLER		PRINT NAME

*PREC represents Personal Real Estate Corporation
 Trademarks are owned or controlled by The Canadian Real Estate Association (CREA) and identify real estate professionals who are members of CREA (REALTOR®) and/or the quality of services they provide (MLS®).