



PT1401

Key Features:

- Stainless Steel Interior & Exterior
- Designed To Operate In 43°C Ambient
- Built-In Air Rear Duct For Even Temperature Distribution
- R290 Hydrocarbon Refrigerant
- Zero ODP Injected Polyurethane Insulation - 90mm
- 2 / +10°C Refrigerator Temperature Range
- Electronic Controller With Easy Read LCD Screen
- Hot Gas Defrost
- Door Locks Fitted As Standard
- Rifle Bore Coated Evaporators
- Ergonomic Flush Door Handle
- Gastronorm Shelving System - Anti Tilt Slides
- Hi / Lo Audio Visual Temperature Alarms
- Condensing Unit Safety System To Protect Compressor From Blocked Condensers
- Self Closing Doors
- Heavy Duty Brake & Swivel Castors
- Waste Heat Recovery Condensate Vaporiser System

Precision's durable all stainless steel top mount cabinets have been designed to provide commercial caterers with reliable, energy and cost efficient refrigerated storage solutions. Proudly made in the UK, these GN2/1 cabinets are capable of meeting the highest demands of commercial kitchens all around the world.



PT601

Options:

- Extra Std Nylon Coated Shelves / Slides - GN2/1
- Stainless Steel Shelves / Slides - GN2/1
- Extra Shelf / Pan Slides
- 600 x 400 Bakery Racking - 20 Pairs Of Slides / Door
- Fish Shelving - 8 x GN2/1 - 100mm Deep - Stainless Steel Pans & Slides per section with Slime Trays
- Stainless Steel Back
- Left Hand Hung Door
- Adjustable Legs
- Remote - Excludes Condensing Unit But Includes R404a Expansion and Solenoid Valve (Fitted)

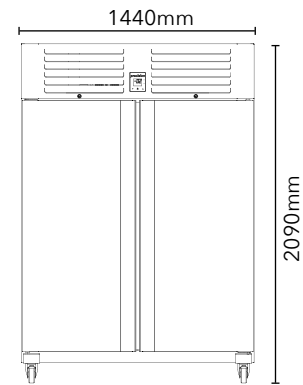
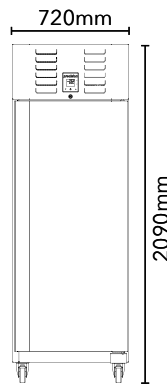
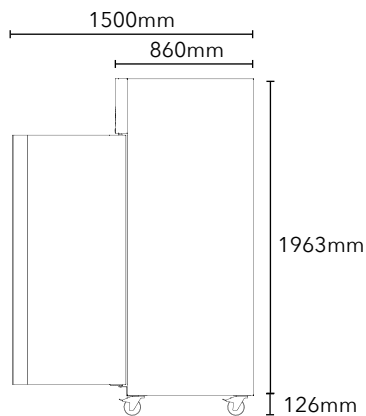

Model	MPT601	LPT601	MPT1401	LPT1401
Type	Refrigerator	Freezer	Refrigerator	Freezer
Material	ST/ST Int/Ext	ST/ST Int/Ext	ST/ST Int/Ext	ST/ST Int/Ext
Shelf Size	GN2/1	GN2/1	GN2/1	GN2/1
Number of Shelves	4	4	8	8
Max Number of Shelves (100mm Spacing)	14	14	28	28
Temperature Range	-2 / +10°C	-18 / -22°C	-2 / +10°C	-18 / -22°C
Exterior WxDxH (mm)	720x860x2090	720x860x2090	1440x860x2090	1440x860x2090
Net Usable Volume (litres)	454	454	928	928
Weight (KG)	138	146	210	230
Refrigerant / GWP	R290 /3	R290 /3	R290 /3	R290 /3
Refrigeration Watts (+45°C Condensing)	373	449	964	728
Evaporating Temp	-10°C	-30°C	-10°C	-30°C
Heat Rejection Watts	560	674	1446	1092
Noise Output (dBa)	66	69	73	76
Power	230 / 50 / 1	230 / 50 / 1	230 / 50 / 1	230 / 50 / 1
Running Amps	1.7	3.5	4.6	5.5
Energy Consumption / 24hrs - kWh*	1.25	4.95	2.56	10.65
Energy Consumption / Year (AEC) - kWh*	456	1807	934	3887
Energy Efficiency Class*	B	C	C	D

*Tested to EN16825 Climate Test Class 4 - M1 Classification Test for Refrigerators / L1 Classification Test for Freezers

We are constantly innovating and improving our products. Please always check our website for the most up-to-date version of this spec sheet