



Shelters

www.glasdon.com

Cycle Storage	3-19
Aero™ Cycle Shelter.....	4-5
Aero™ Corral Compound.....	6-7
Bi-Store™ Cycle Shelter.....	8-9
Corral™ Cycle Compound.....	10-11
Echelon™ Cycle Shelter.....	12-13
Bi-Port™ Cycle Shelter.....	14-15
Modus™ Cycle Locker.....	16-17
Cyclone™ Cycle Stand.....	18-19
Multi-Purpose Shelters & Canopies	20-35
Carleton™ Shelter.....	21-23
Heritage Shelter.....	24-27
Modus™ Shelter.....	28-29
Carleton 50™ Smoking Shelter.....	30-32
Carleton™ Canopy.....	33
Eclipse™ Canopy.....	34-35
Optional Features for Smoking Applications	36
High Performance Materials & Product Testing	37
Photo Gallery	38-39

Design Process

From ideas ... to real world solutions

New product development has been a defining element throughout our history.

The nature of our products is such that they must be designed to resist the numerous challenges faced within the urban landscape. All products are designed and built to ISO 9001 QA standards and certified by structural stability and stress analysis as appropriate.



We make it our top priority to only use materials in our products that offer the highest resistance to the effects of weather and vandalism.

We continuously enhance our product range and pave the way in the market by introducing unique products.

Working together with our innovative design team, we want to provide real world solutions, tailored to meeting your needs.



U.K. REGISTER OF PRE-QUALIFIED CONTRACTORS SERVICES



Certificate Number 16750
ISO9001, ISO14001

Visit our website

www.glasdon.com



Cycle Storage

Provide cover and security with the Glasdon range of bike shelters and motorcycle storage. From contemporary styled shelters to enclosed steel-framed compounds, we'll have an outdoor bike storage solution that meets your requirements.



■ Aero™ Cycle Shelter

DESIGN FEATURES

- Provides storage for up to 10 bicycles.
- Curved design helps natural fall-off of rain and snow.
- Durapol Material ends will not rot, chip or rust.
- Air gap at rear means less litter getting trapped in the shelter.
- Never needs painting.
- Tested in a wind tunnel at winds of up to 60mph - no damage.
- 8 fixing points provide stability and reduce ground leverage.
- Optional PETG end panels provide added weather protection.
- Choice of cycle parking options - 8 or 10 place 'toast rack' cycle hoops, or individual Sheffield cycle stands.
- Supplied fully assembled ready for immediate fixing to a prepared concrete base.

DELIVERY

Delivered fully assembled for immediate base fixing by the customer. If site access is restricted Aero can be delivered in kit form and assembled by Glasdon at an additional cost.

INSTALLATION

Aero cycle shelter is supplied ready for immediate surface fixing on to concrete using the expanding anchor bolts supplied. The minimum base size required is 4400 x 2000mm. The base should be flat, level and a minimum thickness of 200mm concrete on to hardcore.

AVAILABILITY

Usually within 4-6 weeks of order.

MODELS

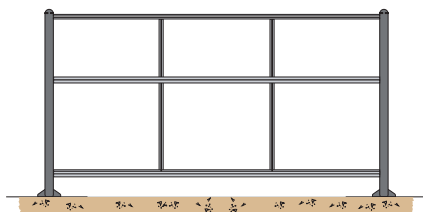

AE001 – Shelter only for Motorcycles
AE201 – Shelter only for Motorcycles with side windows kit

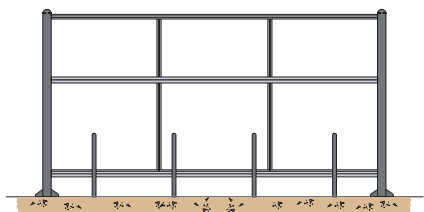

AE080 – 8 place galvanised toast rack
AE085 – 8 place toast rack with Armortec® coating
AE280 – 8 place galvanised toast rack with side windows kit
AE285 – 8 place toast rack with Armortec® coating with side windows kit

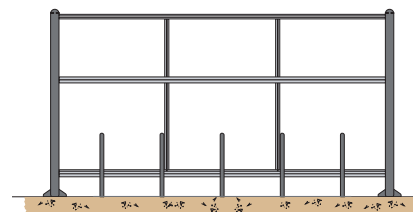

AE100 – 10 place galvanised toast rack
AE105 – 10 place toast rack with Armortec® coating
AE210 – 10 place galvanised toast rack with side windows kit
AE215 – 10 place toast rack with Armortec® coating with side windows kit

SPECIFYING

1. Decide whether cycles or motorcycles are to be stored.
2. For cycles, select from 8 place toast rack, 10 place toast rack or individual Sheffield Cycle Stands (optional feature). For motorcycles, select shelter only.
3. For cycles, specify either Galvanised or Armortec coating.
4. Specify with or without side windows kit.

DIMENSIONS

FRONT ELEVATION

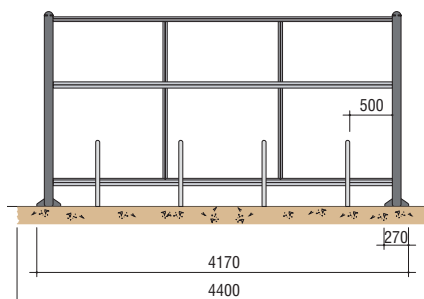

SIDE ELEVATION

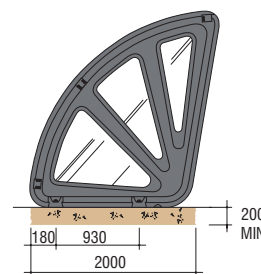

MODEL SH2 SHEFFIELD CYCLE STANDS

Model SH2A

Surface fixing to concrete

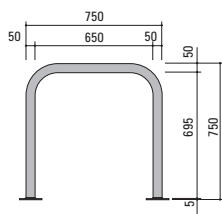

Model SH2B

Setting into concrete pockets

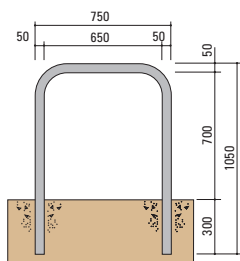

8 PLACE TOAST RACK

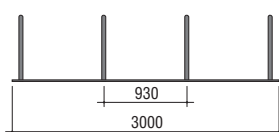

10 PLACE TOAST RACK

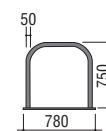
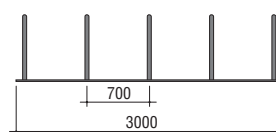

TECHNICAL INFORMATION

COLOURS

Self-coloured Durapol Material ends:

Anthracite Grey. (RAL 7016)

Cladding: Clear.

Roof skeleton: Natural Anodised Aluminium.

CONSTRUCTION

Ends

Durapol® material.

Framework

Natural Anodised Aluminium

Cladding

4mm high-impact PETG thermoplastic glazing.

Joining Plates

Steel with Armortec® coating.

Cycle Stand

Steel with Armortec® coating or Galvanised steel.

OPTIONAL FEATURES

SIDE WINDOWS KIT

Improved protection for either one end or both ends of the shelter. Standard kit contains 6 windows to cover both ends as standard. Side windows allow clear visibility to see inside the shelter.

PERSONALISATION

Personalisation is available on the rear and side glazing panels, please contact our sales office for details.



Aero™ Corral Compound

DESIGN FEATURES

- Provides storage for up to 20 bicycles.
- Consists of two Aero™ cycle shelters joined by an Armortec® coated steel framework to give excellent weather protection and security.
- Front gate and back frame is clad with UV protected polycarbonate panels.
- Central roof structure is clad with UV protected polycarbonate panels.
- Bolt lock supplied as standard.
- Choice of cycle parking options – 2 x 8 or 10 place 'toast rack' cycle hoops.

DELIVERY

Aero Corral is delivered as two assembled Aero Shelters and a separate kit containing the front gate, back panel and roof to form the compound. This will be assembled on site by Glasdon. If site access is restricted, the Aero Shelters can also be delivered in kit form and assembled on site by Glasdon at an additional cost.

INSTALLATION

Once assembled, Aero Corral Compound is ready for immediate surface fixing on to a concrete foundation using the expanding anchor bolts supplied. The minimum base size required is 6004 x 4532mm. The base should be flat, level and a minimum thickness of 200mm concrete on to hardcore.

AVAILABILITY

Usually within 6-8 weeks of order.

MODELS

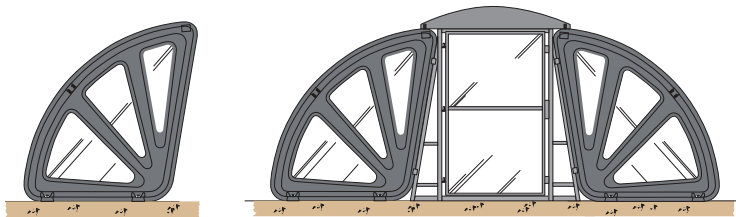

AE201 X 2 - Shelter only with side windows kit and AE400 - Aero Corral Kit

SPECIFYING

1. Decide whether cycles or motorcycles are to be stored.
2. For cycles, select 8 place toast rack, 10 place toast rack or individual Sheffield Cycle Stands (optional feature).
3. For cycles, specify either Galvanised or Armortec coating.
4. Aero Corral Compound is specified with 2 individual shelters being positioned front-to-front.
5. Specify the Aero Corral kit to link into a cycle compound.

DIMENSIONS

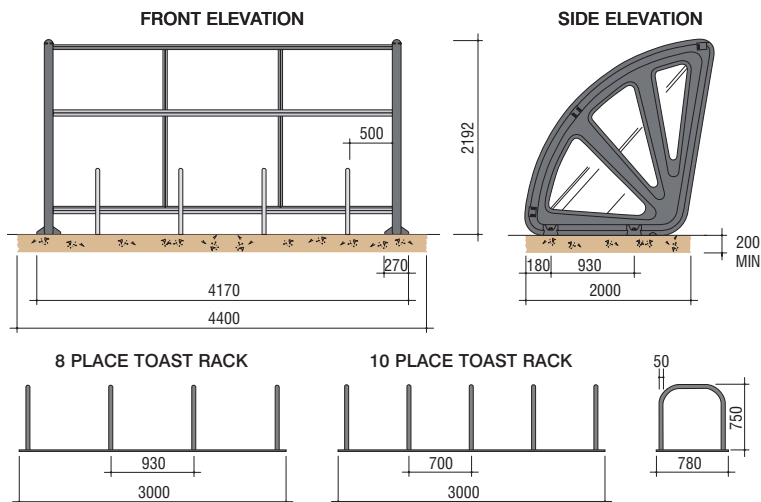

TECHNICAL INFORMATION

COLOURS

Self-coloured Durapol Material ends:

Anthracite Grey. (RAL 7016)

Cladding: Clear.

Roof skeleton: Natural Anodised Aluminium.

Front gate and back frame: Anthracite Grey.

CONSTRUCTION

Ends

Durapol® material.

Framework

Natural Anodised Aluminium.

Front Gate and Back Frame

Steel with Armortec® coating.

Cladding on Aero

4mm high-impact PETG thermoplastic glazing.

Cladding on front gate and back frame

3mm polycarbonate panels.

Roof

4mm UV protected polycarbonate panels.

Joining Plates

Steel with Armortec® coating.

Cycle Stand

Steel with Armortec® coating or Galvanised steel.

OPTIONAL FEATURES

GATE LOCK

Fixing mount kit available for a range of lock mechanisms, please contact our sales office for details.

PERSONALISATION

Personalisation is available on the rear and side glazing panels, please contact our sales office for details.



Bi-Store™ Cycle Shelter

DESIGN FEATURES

- Stores bicycles or motorcycles.
- Bicycle storage options available with choice of 5 place rings, 8 place hoops or 10 place rings.
- Choice of blue or grey plastic-coated steel or clear thermoplastic cladding.
- Supplied ready for immediate fixing to a prepared concrete base.
- All orders are delivered to site as pre-assembled shelters and offloaded with a vehicle crane ready for immediate base fixing to a prepared thickness of at least 200mm on a hardcore foundation.

DELIVERY

Delivered fully assembled for immediate base fixing by the customer. If site access is restricted Bi-Store can be delivered in kit form and assembled by Glasdon at an additional cost.

INSTALLATION

Bi-Store Shelter is supplied ready for immediate surface fixing on to concrete using the expanding anchor bolts supplied. The minimum base size required is 3800 x 2400mm. The prepared concrete base should be flat, level and a minimum thickness of 200mm on to hardcore.

AVAILABILITY

Usually within 4-6 weeks of order.

MODELS

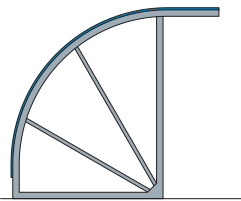

SHELTER ONLY
for Motorcycles

RH601 – Plastic-coated steel
RG651 – Clear thermoplastic

SHELTER ONLY Shelter with no racking, ideal for motorcycle storage.

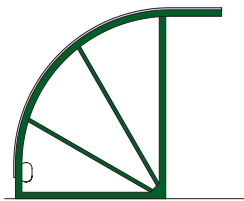

5 PLACE RINGS
for Cycles

RH615 – Plastic-coated steel
RG665 – Clear thermoplastic

RINGS Cycle Shelter with front wheel rings, are extremely popular for use in semi-secure areas.

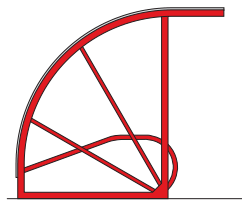

8 PLACE HOOPS
for Cycles

RH628 – Plastic-coated steel
RG678 – Clear thermoplastic

HOOPS Cycle Shelter with hoops, allow the frame and both wheels to be secured using proprietary security devices for maximum theft-protection in any situation.

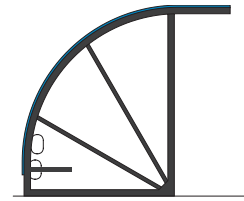

10 PLACE RINGS
for Cycles

RH630 – Plastic-coated steel
RG680 – Clear thermoplastic

SPECIFYING

1. Decide whether cycles or motorcycles are to be stored.
2. For cycles, select from either the ring or hoop models. For motorcycles, select shelter only.
3. Specify the type of cladding required, i.e. plastic-coated steel or clear thermoplastic.
4. Specify optional end cladding panels if required.
5. Specify the weather-face colour required for plastic-coated steel, i.e. Blue or Grey.

DIMENSIONS

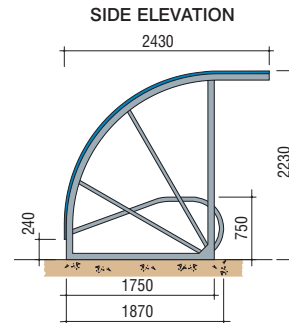
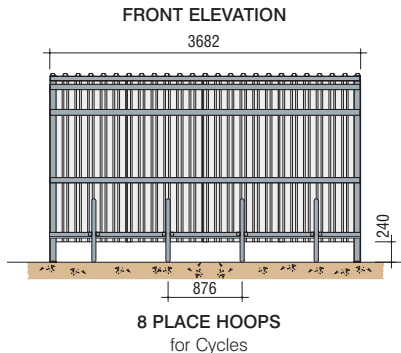

TECHNICAL INFORMATION

COLOURS

Framework

Grey BS 4800 (00.A.09)
Green RAL 6005
Red RAL 3020
Black RAL 9005
Alternative colours are available upon request at an additional cost.

Cladding

Plastic-coated steel

The weather-face is available in a choice of:
nearest equivalent
Ocean Blue BS 4800 (18.C.39)
Goosewing Grey BS 4800 (10.A.05)
Alternative colours are available at additional cost. The reverse-face is always Light Grey.

Thermoplastic

Clear

CONSTRUCTION

Framework

Steel with Armortec® coating.

Cladding

Plastic-coated steel

Profiled, hot-dipped galvanised steel panels with an embossed plastic coating to the weather-face and a protective paint finish to the reverse-face.

Thermoplastic

4mm high-impact thermoplastic glazing.
Protects against UVA and UVB radiation.

OPTIONAL FEATURES

END CLADDING PANELS

Plastic-coated steel

Clear thermoplastic
Extra weather protection can be provided to each of the standard models by the addition of cladding panels to either one or both ends of the shelter.

DIMENSIONS

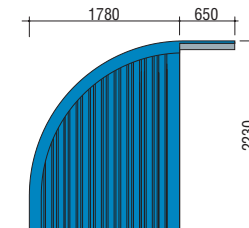



Corral™ Cycle Compound

DESIGN FEATURES

- Stores bicycles and motorcycles.
- Multiple units can be connected together to create potentially unlimited secure cycle storage.
- Optional end cladding offers additional weather protection.
- Roof link panel with clear thermoplastic glazing available to fully enclose the compound.
- Choice of blue or grey plastic-coated steel or clear thermoplastic cladding.
- Available with choice of 5 place rings, 8 place hoops or 10 place rings per half-compound - choices can be mixed and matched.
- Supplied ready for immediate fixing to a prepared concrete base.

DELIVERY

Corral Cycle Compound is delivered as assembled Bi-Store Shelters and a separate kit containing the front gate, back panel and roof (if required) to form the compound. This will be assembled on site by Glasdon. If site access is restricted, the shelters can also be delivered in kit form and assembled on site by Glasdon at an additional cost.

INSTALLATION

Corral Compound is supplied as individual pre-assembled shelters ready for bolting together and surface fixing on to a concrete foundation using the expanding anchor bolts supplied. The prepared concrete base should be flat, level and a minimum thickness of 200mm on to hardcore. The minimum base size required will vary according to the layout of the compound - please contact our sales office for details.

AVAILABILITY

Usually within 4-6 weeks of order.

MODELS

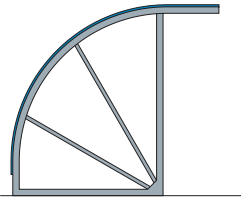

SHELTER ONLY
for Motorcycles

LH601 – Plastic-coated steel
LG651 – Clear thermoplastic

SHELTER ONLY Shelter with no racking, ideal for motorcycle storage.

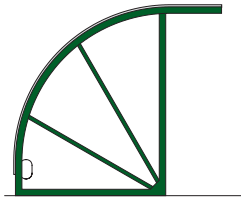

5 PLACE RINGS
for Cycles

LH615 – Plastic-coated steel
LG665 – Clear thermoplastic

RINGS Cycle Shelter with front wheel rings, are extremely popular for use in semi-secure areas.

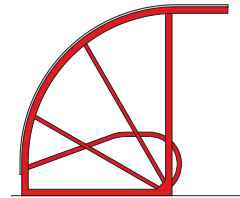

8 PLACE HOOPS
for Cycles

LH628 – Plastic-coated steel
LG678 – Clear thermoplastic

HOOPS Cycle Shelter with hoops, allow the frame and both wheels to be secured using proprietary security devices for maximum theft-protection in any situation.

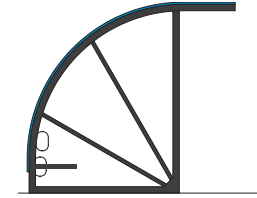

10 PLACE RINGS
for Cycles

LH630 – Plastic-coated steel
LG680 – Clear thermoplastic

SPECIFYING

- Decide whether cycles or motorcycles are to be stored.
- For cycles select from either the ring or hoop models. For motorcycles, select shelter only.
- Corral Compound is specified with a minimum of 2 individual shelters being positioned front-to-front. The total quantity of shelters should always be in a multiple of 2.
- Specify the type of cladding required, i.e. plastic-coated steel or clear thermoplastic.
- Specify optional end cladding and roof link panels as required.
- Select optional vertically-barred gates and panels as required.
- Specify the weather-face colour required for plastic-coated steel, i.e. Blue or Grey.

DIMENSIONS

FRONT ELEVATION

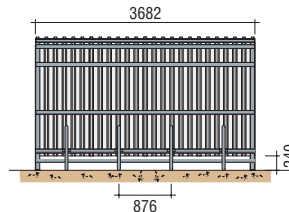

8 PLACE HOOPS
for Cycles

SIDE ELEVATION

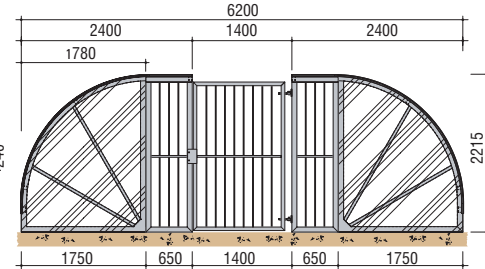

TECHNICAL INFORMATION

COLOURS

Framework And Gates

Grey BS 4800 (00.A.09)
Green RAL 6005
Red RAL 3020
Black RAL 9005
Alternative colours are available upon request at additional cost.

Cladding

Plastic-coated steel

The weather-face is available in a choice of: nearest equivalent Ocean Blue BS 4800 (18.C.39) Goosewing Grey BS 4800 (10.A.05)
Alternative colours are available at additional cost. The reverse-face is always Light Grey.

Thermoplastic

Clear

CONSTRUCTION

Framework And Gates

Steel with Armortec coating.

Cladding

Plastic-coated steel

Profiled, hot-dipped galvanised steel panels with an embossed plastic coating to the weather-face and a protective paint finish to the reverse-face.

Thermoplastic

4mm high-impact thermoplastic glazing.
Protects against UVA and UVB radiation.

OPTIONAL FEATURES

END CLADDING PANELS

Plastic-coated steel

Clear thermoplastic

Extra weather protection can be provided to each of the standard models by the addition of cladding panels to either one or both ends of the shelter.

GATES

The addition of vertically-barred single gates and infill panels to either one or both ends of the compound provides extra security. The gates have a padlock facility.

DIMENSIONS

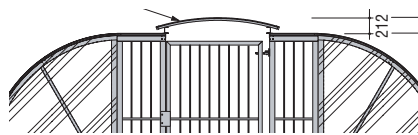
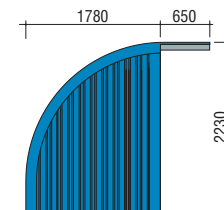

ROOF LINK

The roof link panel offers additional weather protection and security by linking the opposite sides of the shelter. Available with clear thermoplastic glazing.





Echelon™ Cycle Shelter

DESIGN FEATURES

- Standard model is pre-assembled with rivnuts fitted into Armortec® coated holes to prevent corrosion of steel frame.
- Provides storage for up to 10 bicycles.
- Curved design helps natural fall-off of rain and snow.
- Steel frame with 3mm thick Armortec® coating to ensure long service life and low maintenance.
- Standard model supplied fully assembled using Hi-Ab vehicle, ready for immediate fixing to a prepared concrete base.
- Built to withstand strong winds and harsh weather conditions - tested by a structural engineer.
- 4 x 12mm thick adjustable feet with 3 fixing points in each to provide stability and reduce ground leverage.
- UV protected 3mm polycarbonate cladding.
- Optional polycarbonate end cladding provide added weather protection, requires self assembly using pre-drilled holes.
- Choice of cycle parking options - 8 or 10 place 'toast rack' cycle hoops, or individual Sheffield cycle stands. (see pg 5 for details)

DELIVERY

Standard model delivered fully assembled for immediate base fixing by the customer.

INSTALLATION

Echelon cycle shelter is supplied ready for immediate surface fixing on to concrete using the self-tapping anchor bolts supplied. The minimum base size required is 4115 x 2285mm. The base should be flat, level and a minimum thickness of 200mm concrete on to hardcore.

AVAILABILITY

Usually within 4-6 weeks of order.

MODELS

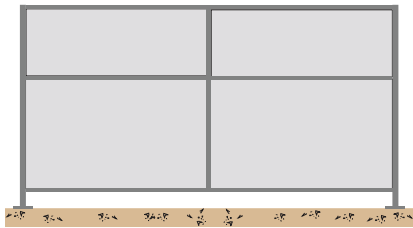

- EC001** – Shelter only for Motorcycles
EC006 – Shelter only for Motorcycles with end cladding on both sides
EC011L/ EC011R – Shelter only for Motorcycles with end cladding on either left or right side

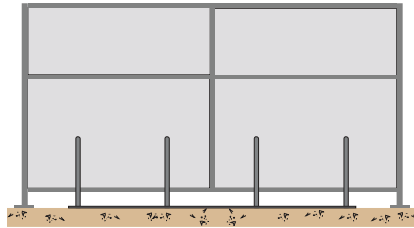

- EC002** – 8 place galvanised toast rack
EC003 – 8 place toast rack with Armortec® coating
EC007 – 8 place galvanised toast rack with end cladding on both sides
EC008 – 8 place toast rack with Armortec® coating with end cladding on both sides
EC012L/ EC012R – 8 place galvanised toast rack with end cladding on either left or right side
EC013L/ EC013R – 8 place toast rack with Armortec® coating with end cladding on either left or right side

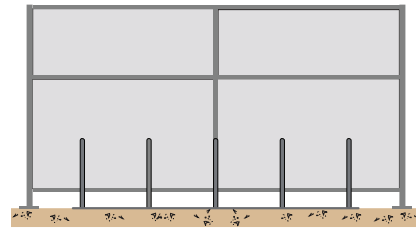

- EC004** – 10 place galvanised toast rack
EC005 – 10 place toast rack with Armortec® coating
EC009 – 10 place galvanised toast rack with end cladding on both sides
EC010 – 10 place toast rack with Armortec® coating with end cladding on both sides
EC014L/ EC014R – 10 place galvanised toast rack with end cladding on either left or right side
EC015L/ EC015R – 10 place toast rack with Armortec® coating with end cladding on either left or right side

SPECIFYING

- Decide whether cycles or motorcycles are to be stored.
- For cycles, select from 8 place toast rack, 10 place toast rack or individual Sheffield Cycle Stands (optional feature see pg 5 for details). For motorcycles, select shelter only.
- For cycles, specify either Galvanised or Armortec coating.
- Specify with or without end cladding.

TECHNICAL INFORMATION

COLOURS

Framework
 Anthracite Grey
Cladding
 Clear

CONSTRUCTION

Framework
 Steel with Armortec® coating
Cladding
 Polycarbonate.

DIMENSIONS

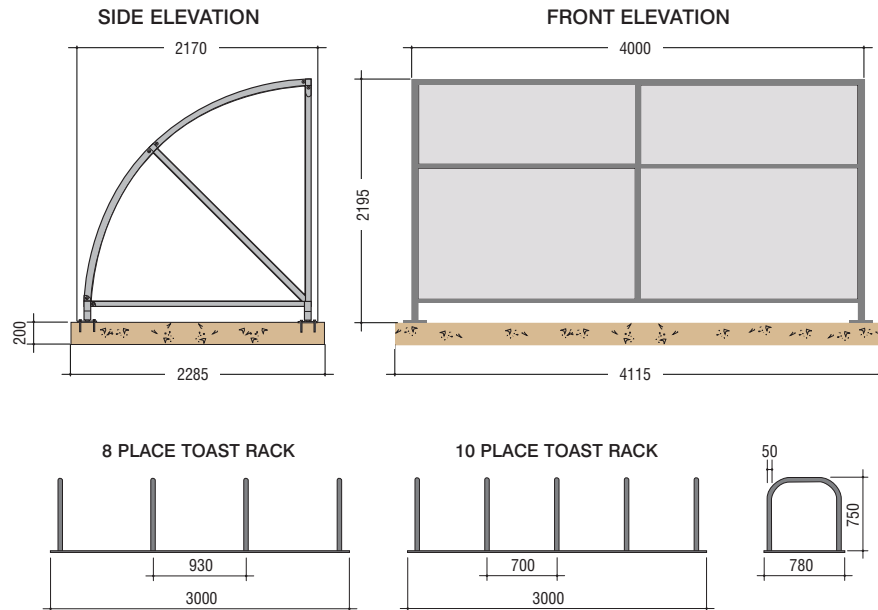

OPTIONAL FEATURES

END CLADDING PANELS

Extra weather protection can be provided to the standard model by the addition of cladding panels to either one or both ends of the shelter.

INDIVIDUAL SHEFFIELD CYCLE STANDS



■ Bi-Port™ Cycle Shelter

DESIGN FEATURES

- Stores bicycles or motorcycles.
- Available as a shelter only or with 8 place hoops for securing standard bicycles.
- Clear thermoplastic cladding provides strength and weather resistance.
- Available in a choice of 4 framework colours.
- Delivered fully assembled ready for immediate installation by our customers.

DELIVERY

Delivered in assembled form for installation by the customer.

INSTALLATION

Bi-Port Shelters are supplied ready for immediate surface fixing on to concrete using the expanding anchor bolts supplied. The minimum base size required is 4300 x 2400mm. The prepared concrete base should be flat, level and a minimum thickness of 200mm on to hardcore.

AVAILABILITY

Usually within 4-6 weeks of order.



MODELS

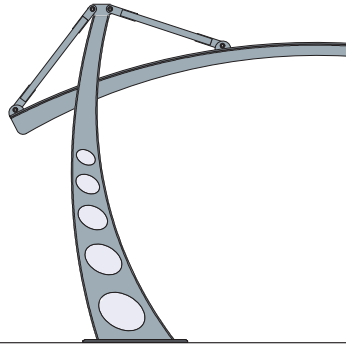

SHELTER ONLY
for Motorcycles
PG551

Shelter Only Shelter with no racking, ideal for motorcycle storage.

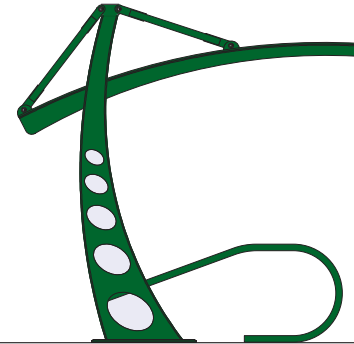

8 PLACE HOOPS
for Cycles
PG578

Hoops Cycle Shelter with hoops, allow the frame and both wheels to be secured using proprietary security devices for maximum theft-protection in any situation.

SPECIFYING

1. Decide whether cycles or motorcycles are to be stored.
2. For cycles select the hoop model. For motorcycles, select shelter only.
3. Specify the frame colour required, i.e. Grey, Green, Red or Black.

TECHNICAL INFORMATION

COLOURS

Framework

Grey BS 4800 (00.A.09)
Green RAL 6005
Red RAL 3020

Black RAL 9005

Alternative colours are available upon request at additional cost.

Cladding

Thermoplastic
Clear

CONSTRUCTION

Framework

Steel with Armortec coating.

Cladding

Thermoplastic
4mm high-impact thermoplastic glazing.
Protects against UVA and UVB radiation.

DIMENSIONS

SIDE ELEVATION

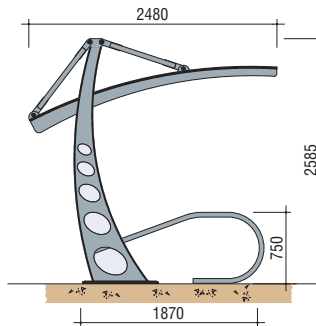

8 PLACE HOOPS
for Cycles

FRONT ELEVATION

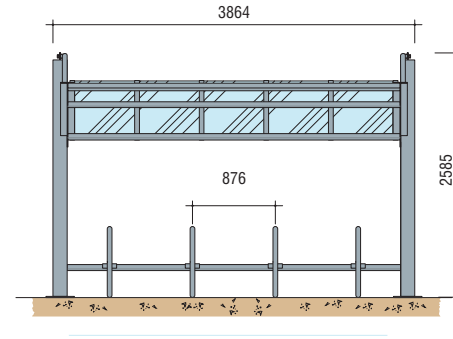

8 PLACE HOOPS
for Cycles



Modus™ Cycle Locker

DESIGN FEATURES

- Secures one bike per locker.
- Robust, theft-resistant design.
- Requires minimal maintenance.
- Environmentally friendly - 100% recycled wall panels and roof.
- Highly secure T-handle lock.
- Internal locking base track allows bicycles to be locked inside the unit for a second line of theft defence.
- Vandal, impact and weather resistant.
- Minimum two units required in a bank.
- Supplied fully assembled ready for immediate fixing to a prepared concrete base.

DELIVERY

In assembled form for installation by the customer.

INSTALLATION

The minimum base size should be 50mm greater than the overall length and width shown. Assuming no suitable existing surface, the base is to be a minimum of 125mm concrete on to hardcore. The base should be flat, level and square. Base fixing is accomplished using the expansion anchor bolts supplied. Five 10mm holes for ground fixing are to be drilled in the concrete base through pre-drilled holes in the locker plinth to a minimum depth of 120mm. One 12mm x 120mm (minimum depth) hole is to be drilled for base track fixing bolt.

AVAILABILITY

Usually within 6-8 weeks of order.

EXAMPLE LAYOUTS

Wedge shape locker allows formations to suit your environment.

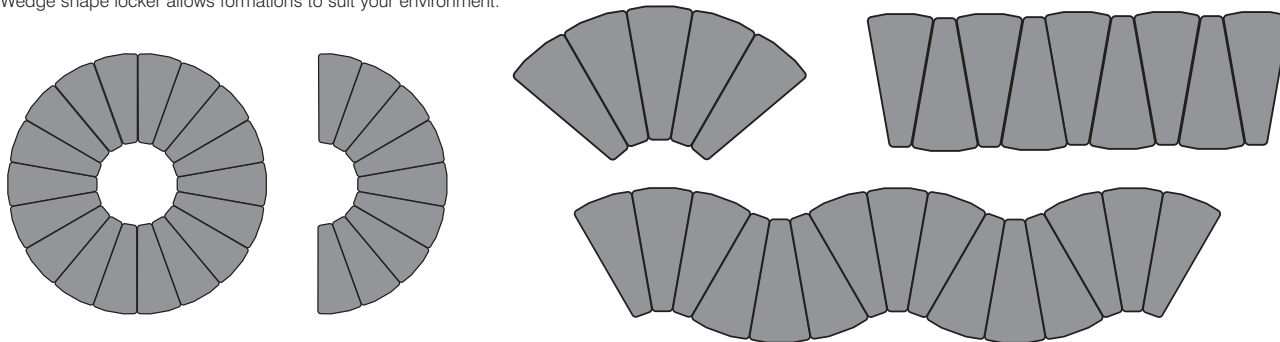

SPECIFYING

1. Decide how many cycles will be stored.
2. Decide the layout formation of the lockers.

DIMENSIONS

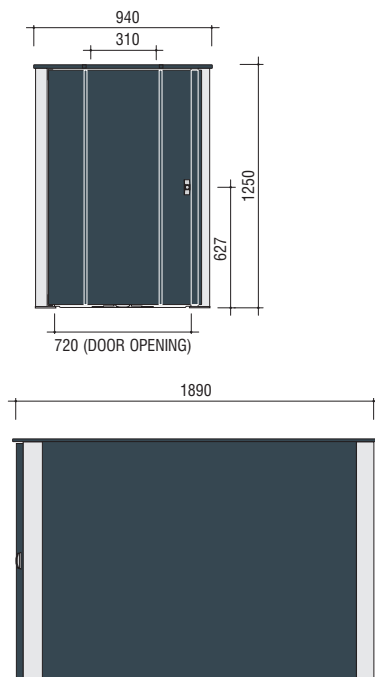

OPTIONAL FEATURES

PERSONALISATION OPTIONS

Your own logo or artwork can be used to personalise Modus cycle locker. Vinyl graphics can be applied to the door or wall panels.



1. With thanks to Steve Bennett, www.wikimedia.org
2. With thanks to johnthescone, www.flickr.com
3. Photographer: William James, with thanks to City of Toronto Archives.

TECHNICAL INFORMATION

COLOURS

Ecoboard™ Material Side Panels Dark Grey
Roof Black
Door Anthracite Grey
Framework Silver

Alternative colours are available subject to minimum order quantity. Please telephone our sales office for details.

CONSTRUCTION

Ecoboard™ Material Side Panels: Recycled polyethylene.
Framework: Vandalex® material.
Roof: 100% recycled Durapol® material.
Door & Wheel Guide: Steel with Armortec® coating.
Door Number Plaque: Stainless steel.



■ Cyclone™ Cycle Stand

DESIGN FEATURES

- Requires no groundwork and can be installed in minutes.
- Features a self-coloured plinth made from Durapol® Material with a hoop for two bicycles made from either stainless steel or steel with Armortec® Coating.
- Each plinth is filled with sand ballast for extra weight to help prevent any unauthorised movement. For added security, concealed fixing points allow for permanently bolting down to a concrete base or paving slabs.
- Designed with a wedge-shaped base plinth that allows for the formation of various layouts. Tamper-resistant linking brackets are used for securing each Cyclone Stand together.

DELIVERY

Delivered as an individual unit ready-filled with sand ballast for offloading by Glasdon. Fitting of linking brackets and base fixing is then undertaken by our customers.

INSTALLATION

Cyclone Stands are delivered as individual units (ready filled with sand ballast) for offloading by Glasdon. Subject to adequate access on site, Glasdon can usually manoeuvre each Cyclone to its final location at the time of delivery. Fitting of linking brackets and base fixing etc. is then undertaken by the customer.

AVAILABILITY

Usually within 3-4 weeks of order.

EXAMPLE LAYOUTS



LINEAR
6 stands



CURVE
6 stands



SEMI-CIRCLE
6 stands

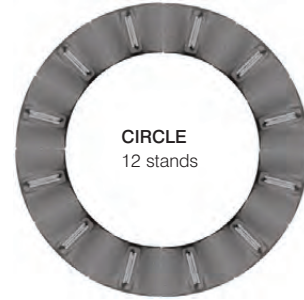

CIRCLE
12 stands

SPECIFYING

1. Decide how many cycles will be stored.
2. Decide the layout formation of the stands.

DIMENSIONS

Note: the leading edge of a Cyclone base plinth should always be positioned at least 400mm away from any existing wall or structure to give sufficient room for the bicycle wheel.

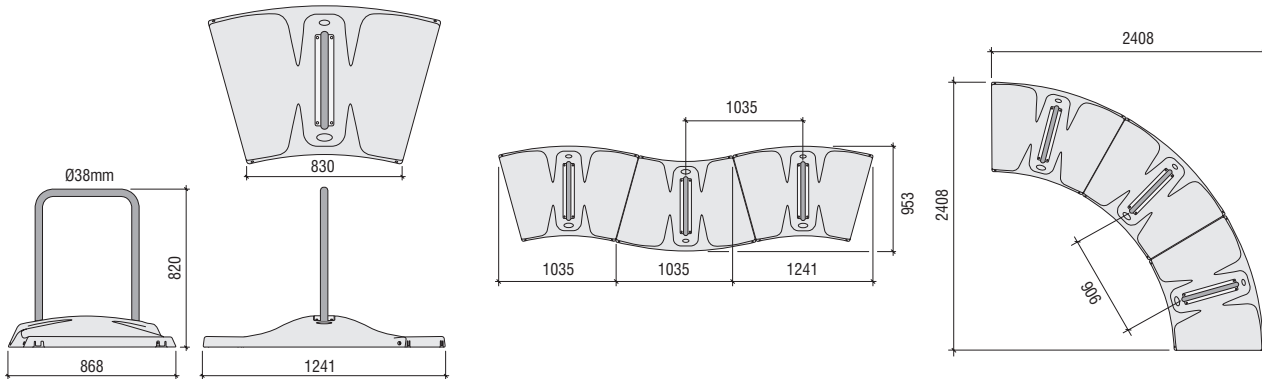

TECHNICAL INFORMATION

COLOURS

Base Plinth:

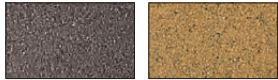

Millstone

Sandstone

Hoop

Anthracite Grey or Stainless Steel

CONSTRUCTION

Base Plinth: Durapol® material.

Cycle Hoop: Mild steel with Armortec® coating.

Fixings Cover Plate: Stainless steel.

WEIGHTS

Without sand ballast: 15kg

With sand ballast: 92kg



Multi-Purpose Shelters & Canopies

Whatever your application, we've got a multi-purpose shelter or canopy that will fit your brief. From waiting shelters and on-site safety fire assembly points to ATM machine canopies, Glasdon offer versatile solutions for the outdoor cover you need to provide.



Carleton™ Shelter

DESIGN FEATURES

- 9 standard layouts.
- 3 roof styles.
- Flat roof models available as self-assembly shelters.
- Panels available in toughened glass, thermoplastic glazing or blank GRP in a choice of colours.
- Fully assembled form normally delivered within 4-6 weeks of order.



For public transport applications our range of Carleton shelters can be adapted in size and configuration to meet the needs of disabled people, in accordance with the relevant Department for Transport guidelines.

SELF-ASSEMBLY SHELTER PATENT NUMBER GB2429468

For multiple roll-out programmes, remote locations and sites with restricted access, Carleton models up to a size of 3 bay x 1 bay with flat roofs can be supplied in self-assembly form for quick and simple assembly by the customer. Comprehensive assembly instructions and a DVD are provided.

AVAILABILITY

Usually within 4-6 weeks of order.

Flat roof models up to a size of 3 bay x 1 bay can be supplied in self-assembly form.

MODELS

2 BAY LONG x 1 BAY WIDE
Nominal Dimensions
2180mm long x 1115mm wide

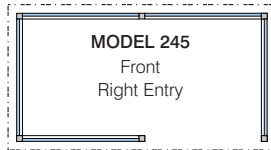
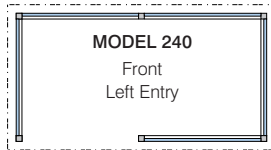
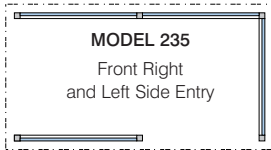
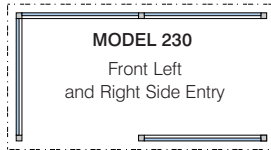
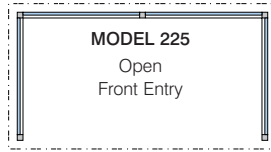
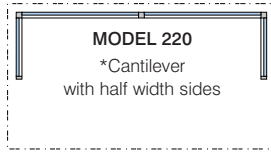

3 BAY LONG x 1 BAY WIDE
Nominal Dimensions
3245mm long x 1115mm wide

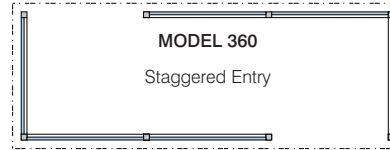
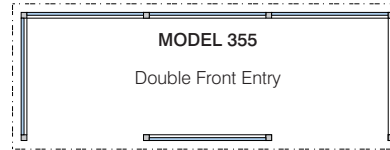
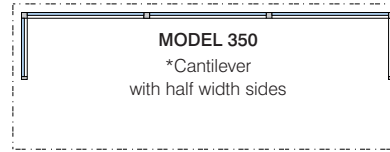

ROOF STYLES

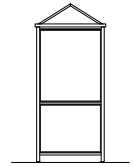
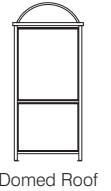
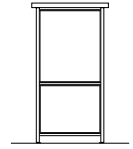

*Cantilever models 220 & 350 are only suitable for setting into concrete pockets below ground.

SPECIFYING

- Select the model which best suits the application, eg. 2 bay with front right entry - model 245.
- Select the roof style required. All Carleton flat roof models up to 3 bay x 1 bay can be supplied in self-assembly form. Comprehensive assembly instructions are provided.
- Specify whether the shelter is:
 - Frame with toughened glass upper and lower panels.
 - Frame with thermoplastic glazed upper and lower panels.
 - Frame with toughened glass upper and blank lower panels.
 - Frame with thermoplastic glazed upper and blank lower panels.
 - Frame with any combination of glass, thermoplastic and blank upper and lower panels.
- Select the colour scheme (if required).
- Carleton shelters are normally ordered in sketch plan form with panel selections and optional features identified as applicable.

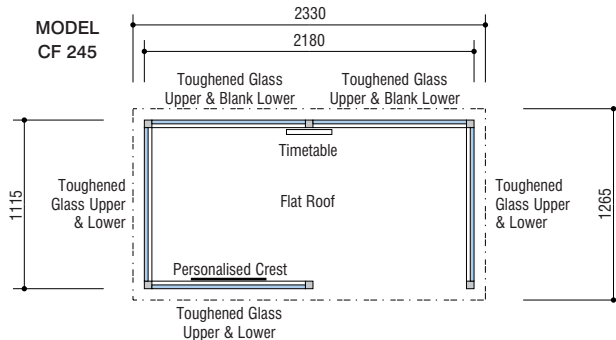

OPTIONAL FEATURES



SEATING

GRP perch seat incorporated into lower blank panel.



PERSONALISATION

Your logo, crest or name can be etched on to the inside surface of glass panels. All we require from you is your personalisation graphic.



TIMETABLE BOARD

Aluminium with Armortec coating display board, with thermoplastic glazing, fixed to intermediate mullions.

LIGHTING

Comprising of external-quality fluorescent luminaire and dusk to dawn sensor switch all wired in surface-mounted steel conduit to a terminal box at low level.

Final site connection and fusing by the customer.

DIMENSIONS

1 BAY WIDE FLAT ROOF ELEVATION

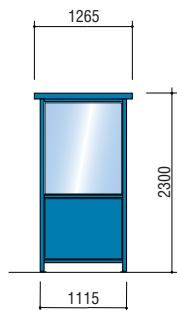

1 BAY WIDE PITCHED ROOF ELEVATION

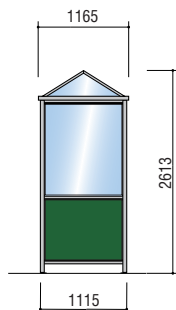

1 BAY WIDE DOMED ROOF ELEVATION

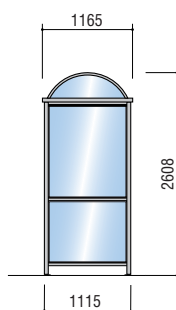

3 BAY LONG FLAT ROOF ELEVATION

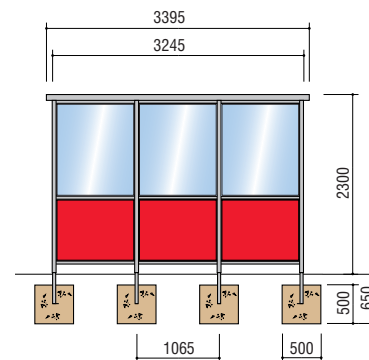

INSTALLATION

Carleton shelter is supplied with adjustable spigoted legs for base fixing or setting into concrete pockets below ground.

METHOD

1. BASE FIXING TO A LEVEL CONCRETE BASE.

Ensure the shelter is correctly aligned prior to drilling through the pre-drilled holes in the base plate and inserting the M10 x 90mm expanding anchor bolts supplied. The concrete base should be a minimum thickness of 125mm on to hardcore.

2. FIXING TO AN UNEVEN OR SLOPING CONCRETE BASE.

Set the shelter down and adjust the spigoted legs as appropriate prior to aligning and base fixing (as in Method 1 above). Adjustment is in 20mm steps up to 100mm (see drawing). The concrete base should be a minimum thickness of 125mm on to hardcore.

3. SETTING INTO CONCRETE POCKETS BELOW GROUND.

Whilst the shelter is elevated, lower the spigoted legs into extended position to provide a 400mm leg projection and set into concrete pockets as appropriate.

SPIGOT LEG

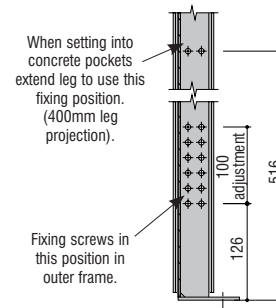

TECHNICAL INFORMATION

COLOURS

Framework

Natural anodised aluminium.

Armortec coating on the framework is available at additional cost.

ROOF

Flat

Alaska Grey RAL 7000

(nearest equivalent BS 4800 18.B.21).

Domed & Pitched

Clear PETG

Blank Panels

Choice of BS 4800 colours for internal and external faces:

Green 14.C.39

Light Grey 00.A.05

Red 04.E.53

Seat

Light Grey BS 4800 (00.A.05) as standard with choice of external colour from above

Timetable Board

Black with Armortec coating

Any external/internal colour combination from the blank panel colours above can be chosen at no additional cost.

Any other BS 4800 colours are available at a nominal additional cost.

CONSTRUCTION

Standard Framework

Vertical 50mm x 50mm anodised aluminium section.

Horizontal 38mm x 38mm anodised aluminium section.

Self-Assembly Framework

Vertical 56mm x 56mm anodised aluminium jointed section.

Horizontal 38mm x 38mm anodised aluminium section.

Roof

Flat: 0.5mm pre-finished steel external skin, 32mm high-density foam core, 0.5mm pre-finished steel internal skin.

Domed & Pitched: 3mm tinted high-impact thermoplastic sheet.

Glazed Panels

Standard choices of:

6mm toughened glass.

6mm clear high-impact thermoplastic sheet.

Alternative Glazing

Tinted or textured glass & high-impact thermoplastic sheet is available to special order.

Blank Panels

6mm textured GRP sheet.

Timetable Board

Aluminium case with Armortec coating.

770mm high x 320mm wide.



Heritage Shelter

DESIGN FEATURES

- 7 standard layouts.
- Panels available in toughened glass, thermoplastic glazing or blank GRP in a choice of colours.
- Manufactured from low-maintenance materials.
- Supplied ready for immediate fixing to a prepared concrete base.



For public transport applications our range of Heritage shelters can be adapted in size and configuration to meet the needs of disabled people, in accordance with the relevant Department for Transport guidelines.

DELIVERY

Delivered fully assembled for simple installation by the customer, Heritage shelter can be either fixed or set below ground..

AVAILABILITY

Usually within 6-8 weeks of order.

MODELS

Heritage shelter consists of an aluminium with Armortec coating framework, glazing and blank GRP panels in a choice of four standard colours, a decorative moulding to each blank panel which is highlighted in a gold colour and a GRP over-roof in a standard Light Grey colour.

2 BAY LONG x 1 BAY WIDE
Nominal Dimensions
2180mm long x 1115mm wide

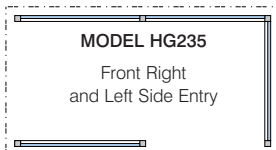
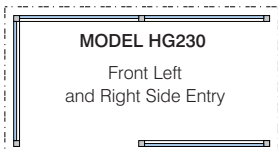
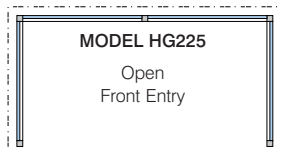

3 BAY LONG x 1 BAY WIDE
Nominal Dimensions
3245mm long x 1115mm wide

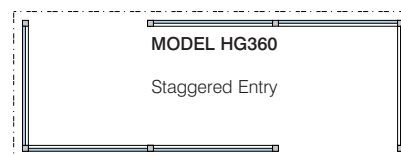
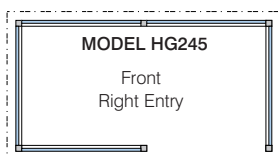
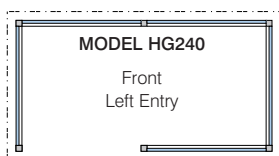
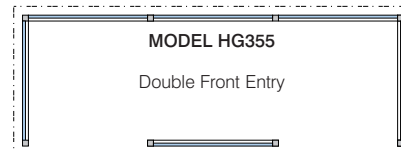

SPECIFYING

1. Select the model which best suits the application, eg. 2 bay with front right and left side entry - model 235.
2. Specify whether the shelter is:
 - a) Frame with toughened glass upper and lower panels.
 - b) Frame with thermoplastic glazed upper and lower panels.
 - c) Frame with toughened glass upper and blank lower panels.
 - d) Frame with thermoplastic glazed upper and blank lower panels.
 - e) Frame with any combination of glass, thermoplastic and blank upper and lower panels.
3. Select the colour scheme required.
4. Heritage shelters are normally ordered in sketch plan form with panel selections and optional features identified as applicable.

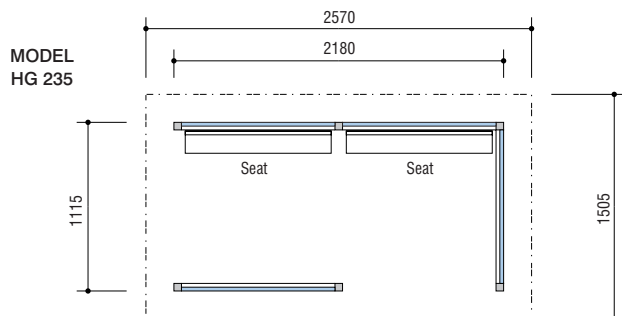

Toughened glass upper and blank lower panels in Maroon colour RAL 3003 with Gold decorative relief

OPTIONAL FEATURES



SEATING

GRP perch seat incorporated into lower blank panel.



PERSONALISATION

Your logo, crest or name can be etched on to the inside surface of glass panels. All we require from you is your personalisation graphic.



TIMETABLE BOARD

Aluminium with Armortec coating display board, with thermoplastic glazing, fixed to intermediate mullions.

LIGHTING

Comprising of external-quality fluorescent luminaire and dusk to dawn sensor switch all wired in surface-mounted steel conduit to a terminal box at low level.

Final site connection and fusing by the customer.

DIMENSIONS

1 BAY WIDE ELEVATION

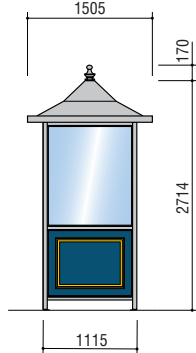

2 BAY LONG ELEVATION

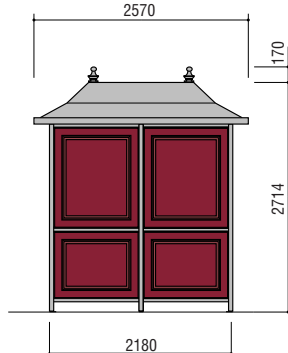

3 BAY LONG ELEVATION

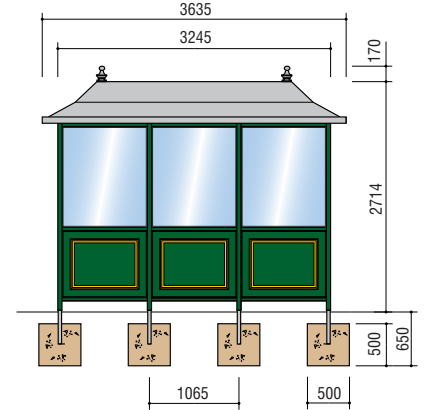

INSTALLATION

Heritage shelter is supplied with adjustable spigoted legs for base fixing or setting into concrete pockets below ground.

METHOD

1. BASE FIXING TO A LEVEL CONCRETE BASE.

Ensure the shelter is correctly aligned prior to drilling through the pre-drilled holes in the base plate and inserting the M10 x 90mm expanding anchor bolts supplied. The concrete base should be a minimum thickness of 125mm on to hardcore.

2. FIXING TO AN UNEVEN OR SLOPING CONCRETE BASE.

Set the shelter down and adjust the spigoted legs as appropriate prior to aligning and base fixing (as in Method 1 above). Adjustment is in 20mm steps up to 100mm (see drawing). The concrete base should be a minimum thickness of 125mm on to hardcore.

3. SETTING INTO CONCRETE POCKETS BELOW GROUND.

Whilst the shelter is elevated, lower the spigoted legs into extended position to provide a 400mm leg projection and set into concrete pockets as appropriate.

SPIGOT LEG

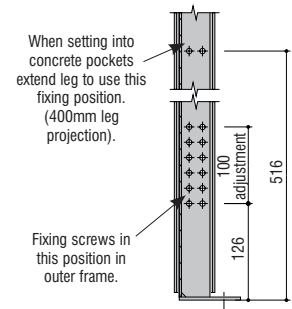

TECHNICAL INFORMATION

COLOURS

Framework

Armortec coating in a choice of:

- Maroon RAL 3003
- Black RAL 9005
- Dark Green RAL 6005
- Dark Blue RAL 5003

ROOF

Flat

Alaska Grey RAL 7000 to internal face and Light Grey BS 4800 (18.B.25) to external face

Blank Panels

Choice of:

- Maroon RAL 3003
- Black RAL 9005
- Dark Green RAL 6005
- Dark Blue RAL 5003

Decorative moulding highlighted in Gold.

Seat

Choice of:

- Maroon RAL 3003
- Black RAL 9005
- Dark Green RAL 6005
- Dark Blue RAL 5003
- Grey BS 4800 (18.B.21)

Timetable Board

Black case

CONSTRUCTION

Framework

Vertical 50mm x 50mm aluminium section.
Horizontal 38mm x 38mm aluminium section.

Roof

Comprising of 33mm thick composite panel with pre-finished steel internal face and GRP over-roof.

Glazed Panels

Standard choices of:
6mm toughened glass.
6mm clear high-impact thermoplastic sheet.

Alternative Glazing

Tinted or textured glass & high-impact thermoplastic sheet is available to special order.

Blank Panels

6mm GRP with textured internal face and smooth semi-gloss external face with decorative moulding.

Timetable Board

Aluminium case with Armortec coating.
Display area measures 720 x 270mm.

CO-ORDINATING PRODUCTS

Glasdon Heritage Shelter can be co-ordinated with Heritage Buildings, Litter Bins and Bollards within the full Glasdon product range.





Modus™ Shelter

DESIGN FEATURES

- Available in 2 sizes - 770 Model or 1280 Model.
- Normally delivered fully assembled - flat-pack delivery is available for sites with restricted access.
- Robust double-skinned roof.

DELIVERY & INSTALLATION

Delivered fully assembled for immediate base fixing by the customer. If site access is restricted Modus can be delivered in kit form and assembled by Glasdon at an additional cost. Modus can also be supplied as a self-assembly kit for multiple roll-out programmes or sites with restricted access.

AVAILABILITY

Usually within 3-4 weeks of order (subject to quantity).



Modus™ Smoking Shelter

Modus features reduced height panels to provide 50% open wall area, for full compliance with UK Smoking Shelter legislation. Smoking area signage is available as an optional feature (see right for details). Modus smoking shelter can also be supplied with Ashmount™ or Ashmount SG® cigarette bins fitted to the Ecoboard panels. Please contact our sales office for details.

OPTIONAL FEATURES

SIGNAGE

A Durapol® material signage panel can be fixed to the shelter roof, which can be fitted with a polycarbonate graphic or left blank to allow graphics to be attached at a later date.

A Smoking area graphic is available. Personalised signage to suit a particular application can also be supplied.

DURAPOL BLANK PANEL

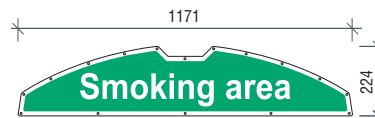
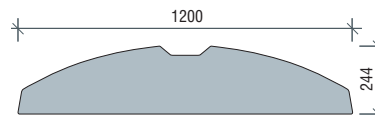

PERCH SEATING

Modus Shelter (770 & 1280 Standard Models only*) can be fitted with Carleton™ perch seats.

Shelters can be fitted with 1 no. perch seat 1200 to the rear panel, or 1 no. perch seat 600 to each of the side panels.

* Not suitable for Modus smoking shelters because of the reduced height lower panels.

BLANK REAR PANEL

The rear glazing panel can be replaced with an Ecoboard panel if Modus is to be located against a wall.

TRANSPARENT ROOF

Ideal for use in car parks which use solar-powered ticket machines.



TECHNICAL INFORMATION

COLOURS

Vandalex® Material Extrusions (Frame)

Silver

Durapol® Material Roof

Anthracite Grey

Ecoboard™ Panelling

Dark Grey

Spigot Legs

Anthracite Grey

Glazing

Clear

Durapol® Material Blank Signage Panel

Light Grey

CONSTRUCTION

Vandalex® Material Extrusions (Frame):

Anodised aluminium*.

Durapol® Material Roof:

Self-coloured polymer.

Ecoboard™ Panelling:

Recycled polyethylene.

Spigot Legs:

Mild steel with Armortec® coating*.

Glazing:

5mm PETG.

Durapol® Material Glazing Strips:

Self-coloured polymer.

Durapol® Material Blank Signage Panel:

Self-coloured polymer.

DIMENSIONS

MODUS 770 & 1280

Front Elevation

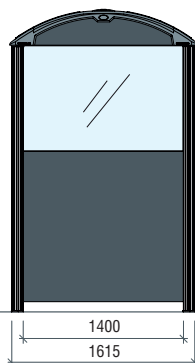

MODUS 770

Side Elevation

1085

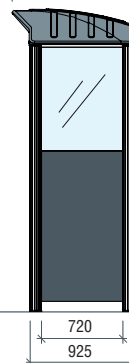

MODUS 1280

Side Elevation

1415

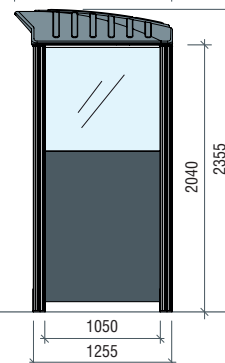

* The frame extrusions and spigot legs contain recycled aluminium/steel



Carleton 50™ Smoking Shelter

DESIGN FEATURES

- Excellent weather protection provided by perimeter roof canopy.
- Choice of flat, curved and pitched roof styles.
- Colour choice offers harmonisation with surroundings and corporate themes.
- Low-maintenance materials for a cost-effective solution.
- Optional lighting for improved visibility during dark winter months.
- Cigarette bins for effective control of litter and perch seating are also available.
- Delivered in assembled form or as a self-assembly kit for sites with restricted access.

SELF-ASSEMBLY SHELTER PATENT NUMBER GB2429468

For multiple roll-out programmes, remote locations and sites with restricted access, Carleton 50 flat roof models indicated with an asterisk (*) can be supplied in self-assembly form for quick and simple assembly by the customer. Comprehensive assembly instructions and a DVD are provided.

AVAILABILITY

Usually within 4-6 weeks of order.

MODELS

ROOF LINE = - - - - -

2 BAY LONG x 1 BAY WIDE

Roof - Nominal Overall Dimensions 2800mm long x 1735mm wide
 Walls - Nominal Overall Dimensions 2180mm long x 1115mm wide



2 BAY LONG x 2 BAY WIDE

Roof - Nominal Overall Dimensions 2800mm long x 2800mm wide
 Walls - Nominal Overall Dimensions 2180mm long x 2180mm wide

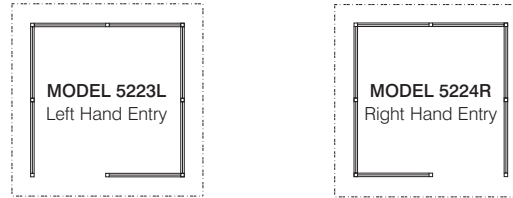

3 BAY LONG x 1 BAY WIDE

Roof - Nominal Overall Dimensions 3865mm long x 1735mm wide
 Walls - Nominal Overall Dimensions 3245mm long x 1115mm wide

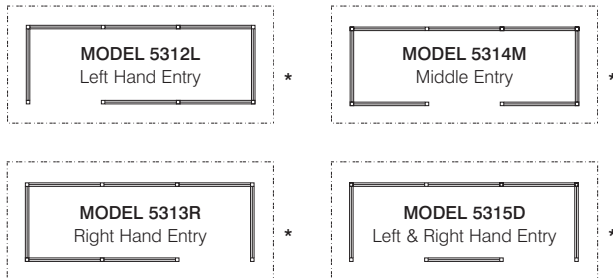

3 BAY LONG x 2 BAY WIDE

Roof - Nominal Overall Dimensions 3865mm long x 2800mm wide
 Walls - Nominal Overall Dimensions 3245mm long x 2180mm wide

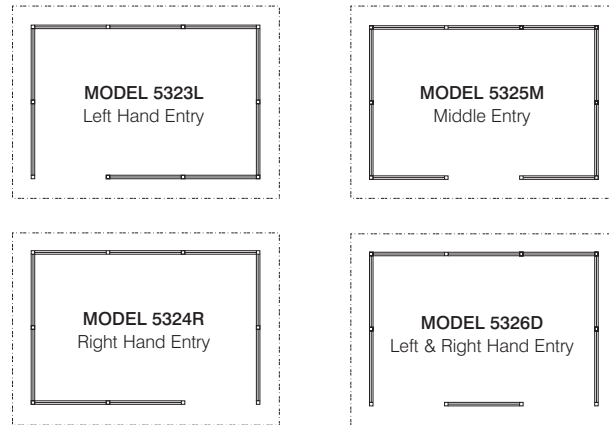

TECHNICAL INFORMATION

COLOURS

Framework

Natural anodised aluminium
 Coloured framework with Armortec® coating is available at an additional cost.

Roof (Flat)

Alaska Grey RAL 7000 nearest equivalent BS 4800 (18.B.21)

Roof (Curved and Pitched)

Clear PETG

Glazing

Clear glazing. Tinted glazing is available at additional cost.

Blank panels

A standard choice of the three BS 4800 colours:
 Green (14.C.39)
 Light Grey (00.A.05)
 Red (04.E.53)
 Any other BS 4800 colour can be chosen at additional cost.

Perch Seat

Light Grey RAL 9006

CONSTRUCTION

Framework

Vertical 50mm x 50mm anodised aluminium section.
 Horizontal 38mm x 38mm anodised aluminium section.

Roof (Flat)

Comprising of 33mm thick composite panel with 0.5mm pre-finished steel external skin, 32mm high-density foam core and 0.5mm pre-finished steel internal skin.

Roof (Curved and Pitched)

3mm high-impact thermoplastic sheet.

Glazing

6mm toughened glass.
 High-impact thermoplastic sheet is available at additional cost.

Blank panels

6mm textured GRP sheet.

Perch Seat

Armortec coated extruded aluminium seat pan and aluminium plate ends.

TYPICAL EXAMPLE

- Model 5315D as shown on sketch below with curved roof, toughened glass panels and natural anodised frames
- 2 no. Ashmount cigarette-disposal units
- 3 no. Smoking area signs

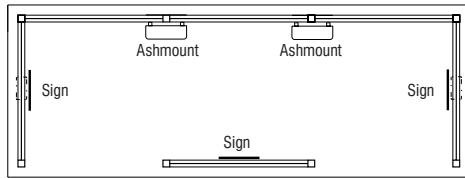

COLOURS

Carleton 50 smoking shelter is supplied as standard with natural anodised aluminium framework, clear panel glazing and a choice of standard colours for blank panels. To match existing architecture choose the coloured framework with Armortec coating, tinted panel glazing and non-standard colour blank panels. Please contact our sales office for details.

SIZE AND LAYOUT

In addition to the standard models shown, Carleton 50 smoking shelter can be manufactured in other sizes and layouts to meet your specific requirements. Please contact our sales office for details.

OPTIONAL FEATURES

See page 36 for optional features available with the Carleton 50 Smoking Shelter.

INSTALLATION

Carleton 50 smoking shelter is supplied with spigoted legs to enable them to be either base fixed or set into concrete pockets below ground.

METHODS

1. BASE FIXING TO A LEVEL CONCRETE BASE.

Ensure the shelter is correctly aligned prior to drilling through the pre-drilled holes in the base plate and inserting the M10 x 90mm expanding anchor bolts supplied.

The concrete base should be a minimum thickness of 125mm on to hardcore.

2. FIXING TO AN UNEVEN OR SLOPING CONCRETE BASE.

Set the shelter down and adjust the spigoted legs as appropriate prior to aligning and base fixing. Adjustment is in 20mm steps up to 100mm (see drawing).

The concrete base should be a minimum thickness of 125mm on to hardcore.

3. SETTING INTO CONCRETE POCKETS BELOW GROUND.

Whilst the shelter is elevated, lower the spigoted legs into extended position to provide a 400mm leg projection and set into concrete pockets as appropriate.

TYPICAL SPIGOT LEG DETAIL

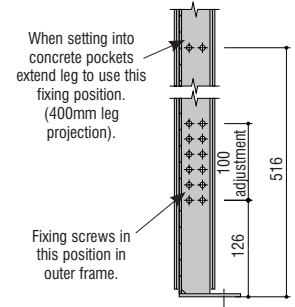

DIMENSIONS

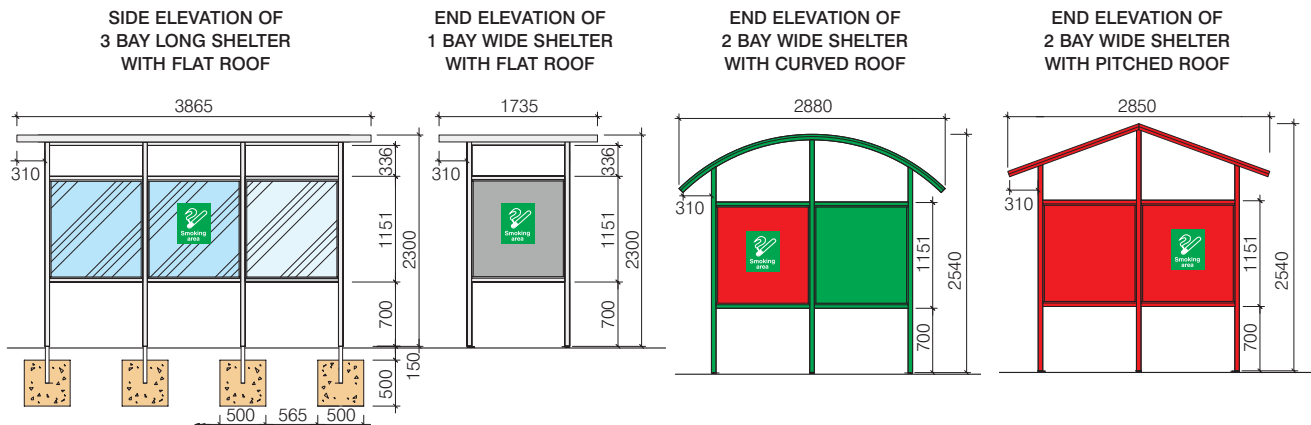



DIMENSIONS

LENGTH

Model 1400
1400mm Length
Model 2800
2800mm Length
Model 4200
4200mm Length

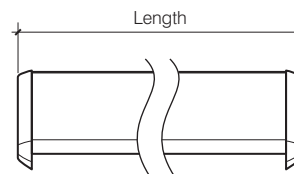

The recommended height to the top of each canopy above ground is 2485mm

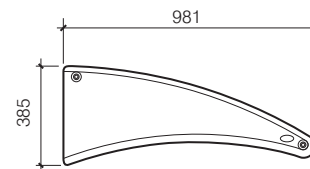

OPTIONAL FEATURES

See page 36 for optional features available with the Carleton Canopy.

TECHNICAL INFORMATION

COLOURS

Cast ends Silver
Connector tubes Silver
Roof Bronze tinted

CONSTRUCTION

Cast ends: Recycled cast aluminium with Armortec coating.
Connector tubes: Aluminium extrusion with Armortec coating.
Roof: Twin-walled polycarbonate sheet.

WEIGHTS

Model 1400: 24kg
Model 2800: 41kg
Model 4200: 58kg

MODELS

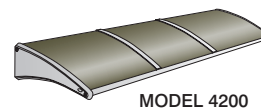
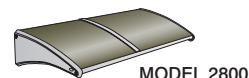

Carleton™ Canopy

DESIGN FEATURES

- Contemporary, stylish design.
- 3 standard models in lengths of 1400mm, 2800mm and 4200mm.
- 100% recycled cast aluminium framework.
- High quality Armortec® Coating for low maintenance and long-term durability.
- Wall-mounting installation.
- Twin-walled polycarbonate sheet for added strength.
- Curved design helps natural fall-off of rain and snow.
- Carleton Canopies are supplied with wall fixings suitable for general brickwork that is in good condition. If in any doubt please seek professional advice.
- **Carleton Smokers' Station** also available - a complete package that provides a smoking shelter, cigarette bin, perch seat and smoking signage to create a designated smoking area for your employees or students, and is ideal for workplaces and universities.

INSTALLATION

Carleton canopies are supplied with wall fixings suitable for general brickwork that is in good condition. Fixing must be carried out by a competent person. Please note that due to the various forms of wall materials and construction available, it is recommended that professional advice is sought should any doubt exist regarding fixing arrangements.

AVAILABILITY

Usually within 3-4 weeks of order.
Delivered fully assembled for immediate wall mounting by the customer.



Eclipse™ Canopy

DESIGN FEATURES

- Simple and stylish one-piece design.
- Curved design helps natural fall-off of rain and snow.
- Manufactured using Durapol® Material.
- Choice of four standard colours.
- Black model contains recycled material.
- Choice of wall or post mounting fixings - posts available for surface fixing or concreting in.
- **Eclipse Smokers' Station** also available - a complete package that provides a smokers canopy, cigarette bin, perch seat and smoking signage to create a designated smoking area outside your business or workplaces.

INSTALLATION

Delivered ready for immediate installation by the customer. Full installation and mounting instructions are provided. Wall mounted Eclipse canopy is supplied with wall fixings suitable for general brickwork that is in good condition. Fixing must be carried out by a competent person. Please note that due to the various forms of wall materials and construction available, it is recommended that professional advice is sought should any doubt exist regarding fixing arrangements.

DELIVERY

Usually within 3-4 weeks of order.



Eclipse™ Back-to-Back Canopy

Eclipse Back-to-Back Canopy is an economical way to provide partial weather protection. Ideal for outdoor waiting areas, Eclipse Canopy has a stylish curved design that prevents rain and snow build-up, and it is available in a choice of four standard colours. The unit is supplied with steel posts with an Armortec® Coating for maximum durability. Eclipse Canopies are delivered ready for mounting/installation by our customers

MODELS

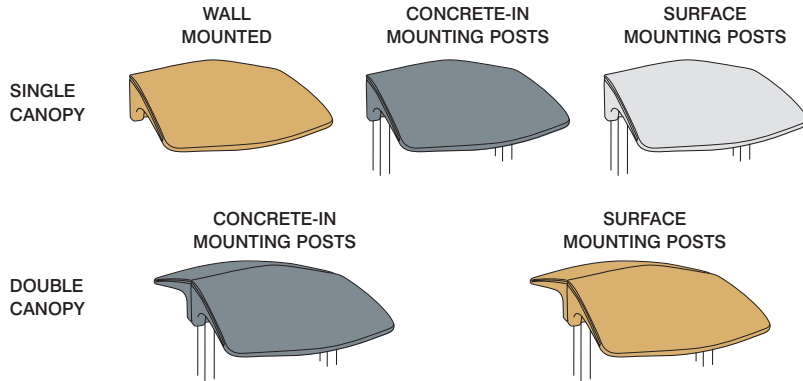

TECHNICAL INFORMATION

COLOURS

Canopy:

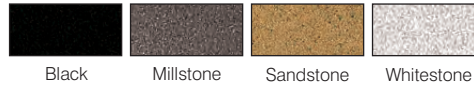

MATERIALS

Canopy: Durapol® material

Mounting Posts: Mild Steel with Armortec® coating.

WEIGHTS

Single Canopy: 17kg

Surface Mounted Posts (for single canopy): 21kg

Surface Mounted Posts (for back-to-back canopies): 26kg

OPTIONAL FEATURES

See page 36 for optional features available with the Eclipse Canopy.



DIMENSIONS

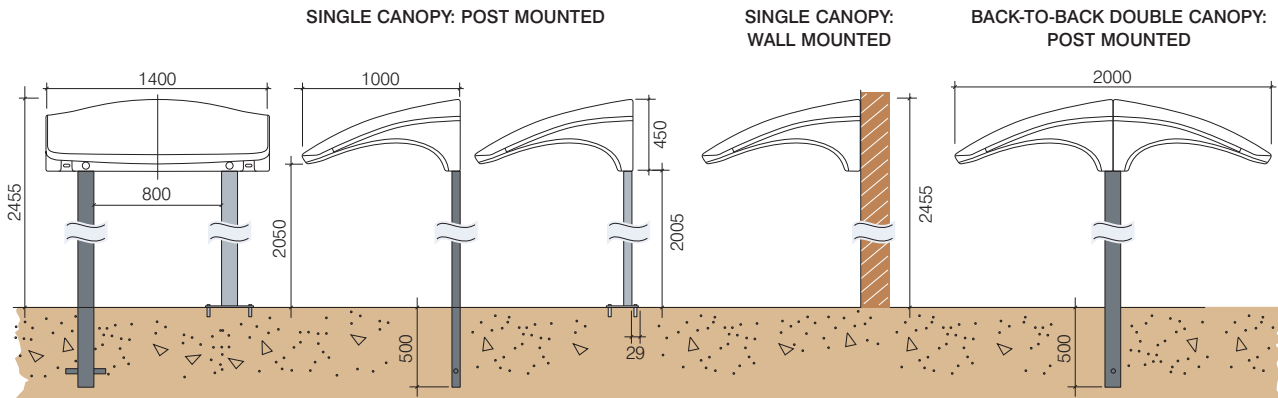

Concrete-in mounting posts Surface mounting posts

Cigarette Bins

Within our collection of cigarette bins we offer free standing or wall mounted ashtrays. We also supply litter and cigarette waste bins with separate liners for safer collection of both smoking and non-smoking waste.



**ASHMOUNT™
CIGARETTE BIN**
3 Litre wall mounted unit



**ASHMOUNT™
CIGARETTE BIN**
1.5 Litre wall mounted unit



**ASHMOUNT SG®
CIGARETTE BIN**
Wall mounted unit



**ASHGUARD™
CIGARETTE BIN**
Floor standing unit in stainless steel.



**ASHGUARD™
CIGARETTE BIN**
Floor standing unit in dark grey.



**ASHGUARD SG®
CIGARETTE BIN**
Floor standing unit with apertures on both sides



**INTEGRO CITY™
CIGARETTE & LITTER BIN**
Easy to use litter/ash bin



**INTEGRO™
CIGARETTE BIN**
Larger capacity litter/ash bin

Seating

Ergonomically-designed perch seat manufactured from aluminium with Armortec coating.



Lighting

FOR USE WITH CARLETON 50 SMOKING SHELTER

Comprising of external-quality fluorescent luminaire and PIR sensor switch all wired in surface-mounted conduit to a terminal box at low level. Final connection and fusing by others.

- 1 bay wide shelter - 1 no. luminaire
- 2 bay wide shelter - 2 no. luminaires

Signs

FREE OF CHARGE WHEN FACTORY-FITTED TO A CARLETON 50 SMOKING SHELTER.

Self-adhesive Smoking area signs.
See page opposite for options available.



Glasdon High Performance Materials

Glasdon products are manufactured from high performance materials and undergo stringent quality checks to ensure durability and best value. We have accreditation with ISO 9001:2015, underlining our commitment to provide quality products.

Throughout this brochure reference is made to the following materials:

Armortec® corrosion resistant coating is specially formulated to extend the life of Glasdon metal products and components used externally.

Durapol® material is a polymer formulated to withstand extremes of temperature and is impact-tested in our Quality Assurance Laboratory as part of our BS EN ISO 9001:2015 test procedure. Durapol® material will not chip or rust, is easy to clean and never needs painting.

Ecoboard™ material is manufactured using a combination of virgin polymer and post consumer plastic waste to create a very robust and strong panel. Ecoboard™ material will not chip or rust, is easy to clean and never needs painting.

Vandalex® material is an aluminium alloy engineered to produce a high modulus of elasticity, which offers increased impact absorption properties. Its anodised finish will not rust, is easy to clean and never needs painting.

All Glasdon products manufactured from Durapol® material, Vandalex® material and Stainless steel can be recycled at the end of their service life.

Ongoing Quality

Our products performance doesn't end here

All products go through a rigorous process of testing to ensure that they are fit for purpose. We place great emphasis on material selection, efficient manufacturing and we never sacrifice quality for price.

WIND TUNNEL TESTING AT MIRA

Tested in the MIRA wind tunnel, Aero Cycle Shelter withstood speeds up to 60mph (Gale Force) and remained completely undamaged.



Smoking Area Signs

Workplaces are required by law to display 'No Smoking' signs in or on any premises affected by the ban.

Sign variants 1, 2, 3 and 4 can be supplied as either an A4 polycarbonate plaque or an A4 vinyl sticker. The polycarbonate plaques are rear printed to protect the sign face from impacts or scratches, and are weather, UV and vandal-resistant. The vinyl stickers are durable and hard wearing and are suitable for indoor use. Sign variant 5 is available as a front and rear printed 88mm diameter sticker, which is ideal for mounting on glass where the sign is required to be viewed from both sides.

1 Smoking Area Sign



For use in designated Smoking Areas.

2 Legal Sign for Scotland



Conforms to Scottish smoking sign legislation for displaying at entrances to smoke-free premises.

3 No Smoking Sign



For general use around smoke-free premises.

4 Legal Sign for England and Northern Ireland



Conforms to English and Northern Ireland smoking sign legislation for displaying at entrances to smoke-free premises.

5 No Smoking Sign



For displaying in smoke-free vehicles and ideal for use on glass doors throughout smoke-free premises.





Photo Gallery

We've been making Shelters for over 30 years.



1982



1988



1993



2015

Indoor Litter Bins / Outdoor Litter Bins



Indoor Recycling Bins / Outdoor Recycling Bins



Free Delivery
*within mainland UK and Northern Ireland

EXCELLENT SERVICE



5.0/5.0 - 38 ratings

Sep. 2017 Verified by LiveChat

www.glasdon.com



Glasdon
Glasdon U.K. Limited

Preston New Road
BLACKPOOL
Lancashire
FY4 4UL
United Kingdom

Tel: (01253) 600410

Fax: (01253) 792558

E-mail: sales@glasdon-uk.co.uk

Web: www.glasdon.com

More detailed literature is available for many of our products. Please contact our Sales Office on 01253 600410 with your enquiry.

 **Glasdon**, Aero, Armortec, Ashguard, Ashguard SG, Ashmount, Ashmount SG, Bi-Store, Carleton, Carleton 50, Corral, Cyclone, Durapol, Echelon, Eclipse, EcoBoard, Integro, Integro City, Modus and Vandalex are trademarks or registered trademarks of GLASDON GROUP or its subsidiaries in the UK and other countries.