

Racing & Performance

P R O D U C T S



2017 CATALOG

TABLE OF CONTENTS

About The Company	3
Startek Starters	4
Flexplates	6
Torque Converters	8
Applications 11	
Transmissions	12
Shift Improvement Kits 16	
Automatic Shifters	20
Buyers Guide 20	
Hammer Shifter 23	
Quicksilver 24	
Megashifter 26	
Pro Stick 28	
Pro Ratchet 30	
Street Bandit 31	
Pro Bandit 32	
Manual Shifters	34
Hi-Tek Cooling Products	39
Coolers 40	
Transmission Pans 44	
Differential Covers 45	
Accessories	46
Shift 46	
Transmission 52	
Apparel 58	
Warranty	59

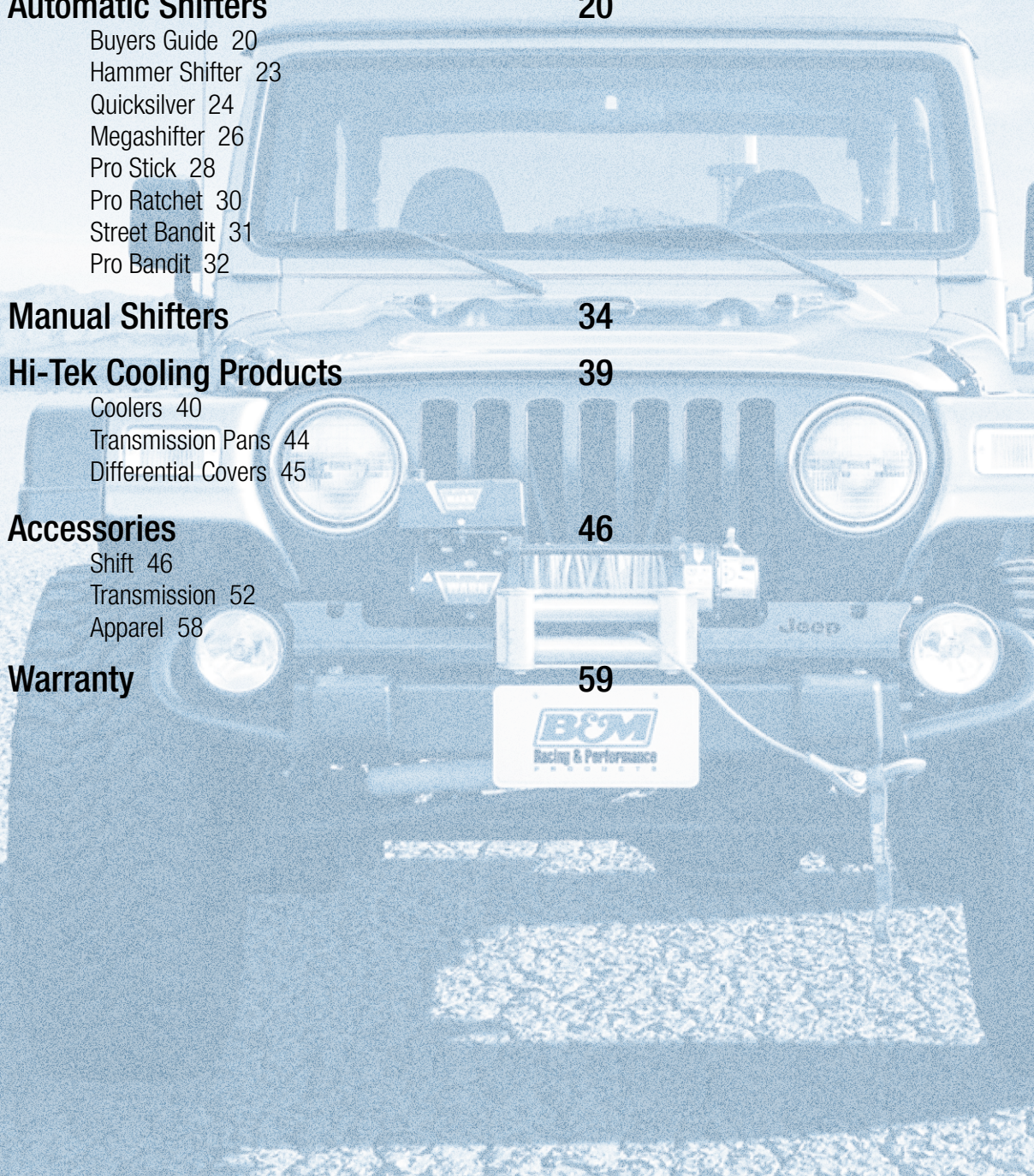

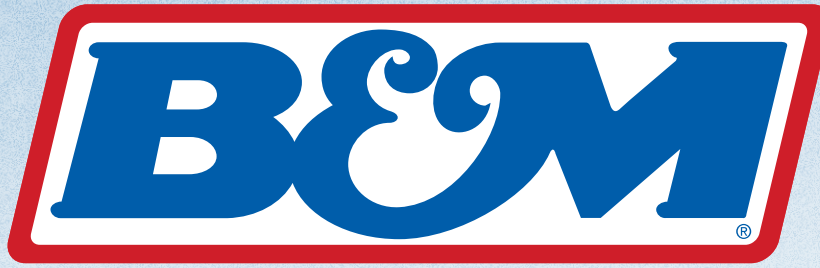

Racing & Performance

P R O D U C T S

A COMPANY OF FIRSTS SINCE 1953

Since the very early 1950's, B&M has been at the vanguard of the growing automotive after-market. Racers themselves, B&M's founders identified the needs of local racers and street performance enthusiasts, and developed products to fill those needs. As the industry grew so did B&M. And as racers went faster, B&M developed products to help them break the records they just set.

In the 50's it was B&M who came up with the idea of using a performance reinforced Hydramatic for racing. In the 60s it was B&M who developed shifters to go along with it, and later in the decade came race converters. In the 70s, B&M introduced shift and transmission improving kits – always constantly refining and expanding existing product lines.

If you've ever raced a vehicle, or driven a hot rod with an automatic transmission, high stall torque converter, an after-market automatic shifter, or performance enhancing shifting kit, thank B&M. From Trick Shift performance ATF to reverse pattern valve bodies, 1.80 gear sets to cool canisters, the list of firsts goes on and on...

It's this tradition that keeps moving B&M to identify and develop what the performance enthusiast needs. As racing and street performance has spread globally, B&M has taken it's extensive knowledge and experience and applied it to the needs of racers, everyday drivers and hobbyists around the world.

Keep looking to B&M to continue to be amongst the very first to identify vehicle needs in the global automotive after-market, supplying enthusiasts and racers what they need.

STARTEK™ STARTERS



HIGH TORQUE, REDUCED WEIGHT

The new B&M StarTek starter is designed to provide high torque and power in a wide range of demanding applications. With 4.5:1 reduction gears coupled to a high power 300 Amp motor, hard starting becomes a thing of the past. The StarTek uses an ultra-high strength pinion gear, billet aluminum mounting flange, sealed ball bearings, and dual winding solenoid to ensure maximum reliability. For most applications, the StarTek body can be clocked in different positions relative to the main mounting block. This ensures you have the most clearance possible between your starter and other engine components. These starters are dyno tested in-house to make sure they meet B&M's high standards for quality and performance.

Billet Aluminum Mounting Flange // 4.5:1 Gear Reduction Ratio for Maximum Torque //

High Performance 300 Amp Motor // Ultra High Strength Pinion Gear // Designed for

Higher Compression and Blown Engines // Dual Winding Solenoid for Lower Engagement

Current Draw // Indexable Mounting Positions

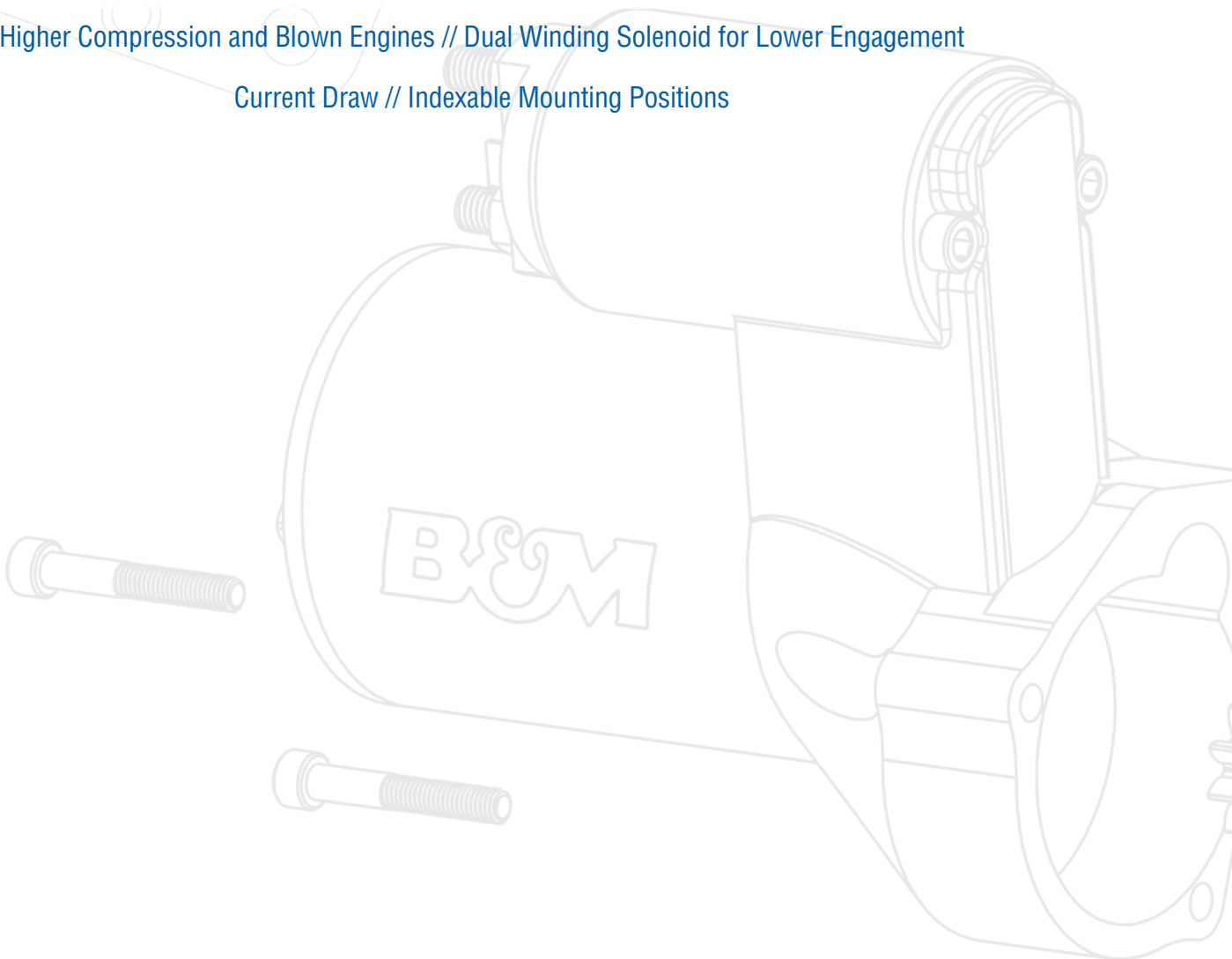



18:1 MAXIMUM COMPRESSION



UP TO 30% WEIGHT SAVINGS* SPACE SAVING DESIGN

*Due to the large amount of possible applications for every starter, not all applicable OEM starters have been compared

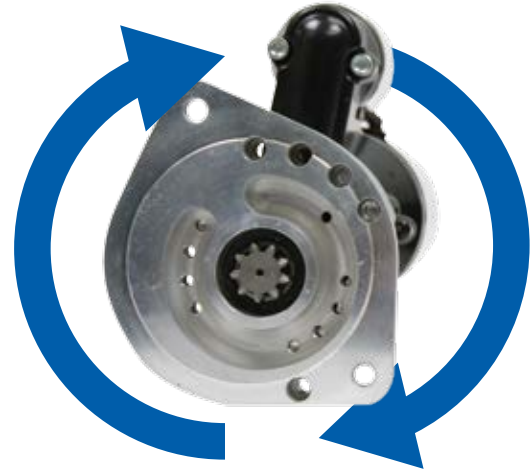

CLOCKABLE MOUNTING POSITIONS*

*Except on Chrysler Applications

APPLICATION	NOTES	CLOCKING POSITIONS	PART NUMBER
Small Block Ford, 289, 302, 351W, 5.0L	Ring Gear Teeth: 157, 164 Ring Gear Depth: 3/4" Register Diameter: 4.084"	Four	77100
Small Block Ford, 289, 302, 351W, 5.0L - 4-speed Manual	Ring Gear Teeth: 164 Ring Gear Depth: 3/8" Register Diameter: 4.130"	Four	77101
Ford V8, 351C, 351M, 400, 429, 460	Ring Gear Depth: 5/8" - 11/16"	Two	77102
Big Block Ford FE - 390, 427, 428	Ring Gear Depth: 11/16" - 3/4"	Three	77103
Small Block & Big Block GM Straight Mount	Ring Gear Teeth: 153, 168	Three	77104
Small Block & Big Block GM Staggered Mount	Ring Gear Teeth: 168	Three	77105
GM LS1-LS7 Engines (NOT GTO)	Will not fit GTO	Three	77106
Chrysler Big Block and Small Block, 318 - 440		No clocking	77107

FLEXPLATES



SFI APPROVED & HIGH QUALITY REPLACEMENTS

With automatic equipped cars, it can be easy to forget that all of your engine's torque is transferred through a flexplate before reaching the torque converter and transmission. That's a lot of force! If you have a performance vehicle fitted with an automatic transmission, one of the most prudent modifications you can make is installing a quality flexplate. B&M's Flexplates are designed to handle high levels of torque in both street and racing applications. Our SFI approved plates, featuring .150" thick steel center sections and double welded ring gears, are some of the strongest available. Whether you have a mild street set up and are simply looking for a high quality flexplate at an excellent price, or are pushing the limits in all out competition and need SFI approvals, B&M has the right flexplate for you.

- Quality flexplates for both street (non-SFI) & racing (SFI) applications
- SFI spec 29.1 Approved flexplates are legal for applicable nhra and ihra classes
- SFI flexplates include certification sticker and engraving
- Double welded ring gears on all SFI approved flexplates
- SFI flexplates are an excellent choice for heavy duty, non-racing applications such as towing
- Direct bolt-in components



FLEXPLATE APPLICATIONS

MAKE	BLOCK	CID	YEAR	BALANCE	RING GEAR	BOLT CIRCLE	PART #	
CHEVROLET STANDARD SFI FLEXPLATES								
Chevrolet	Small	exc.400	'55-'85	Internal	168	Dual	10-3/4 & 11-1/2"	20230
Chevrolet	Small	exc.400	'55-'85	Internal	153	Single	10-3/4	20237
Chevrolet	Small	400	55-85	External	168	Dual	10-3/4" or 11-1/2"	20232
Chevrolet	Small		'86-'97	External	153	Single	10-3/4"	20238
Chevrolet	Small		'86-'97	External	168	Dual	10-3/4 & 11-1/2"	20239
Chevrolet	Big	exc.454	To '90	Internal	168	Dual	10-3/4 & 11-1/2"	20230
Chevrolet	Big	454	To '90	External	168	Dual	10-3/4 & 11-1/2"	20233
Chevrolet	LS Motors		'97+ up	Internal	168		11.50"	20340
CHRYSLER STANDARD SFI FLEXPLATES								
Chrysler	Small	340 w/TF 727	'71-'76	External	No	Dual	10" & 11-1/8"	10235
Chrysler	Small	360 w/TF 904	'71-'92	External	No	Single	10"	10239
Chrysler	Small	360 w/TF 727	'71-'92	External	No	Dual	10" & 11-1/8"	10236
Chrysler	Big	3833 w/TF 727	'71+ up	External	No	Dual	10" & 11-1/8"	10237
Chrysler	Big	4003 w/TF 727	'71+ up	External	No	Dual	10" & 11-1/8"	10237
Chrysler	Big	4403 w/TF 727	'71+ up	External	No	Dual	10" & 11-1/8"	10237
Chrysler		w/TF 727	'62+ up	Internal	No	Dual	10" & 11-1/8"	10230 ¹
Chrysler		w/TF 904	'62+ up	Internal	No	Single	10"	10231 ²
Chrysler		w/TF 727	'62+ up	Internal	No	Single	10"	10231 ²
Note: These B&M externally balanced Chrysler engine flexplates must be used when changing converters on an externally balanced engine.								
FORD NON-SFI REPLACEMENT FLEXPLATES								
Ford	Small	289-302 w/C4	'68-'81	28.2	157		10-1/2"	50236
Ford	Small	289-351C w/C4	'68-'81	28.2	164		11.4"	50237
Ford	Small	302 w/AOD	'82-'95	50.0	164		11.4"	50238
Ford	Small	302 w/C4	'82-'95	50.0	157		10-1/2"	50239 ³
Ford	Small	289-351 w/C4		Internal	157		10-1/2"	50246 ⁴

(1) Six-Bolt Crank. (2) Eight-Bolt Crank (3) Special Application 50.0 in. oz. External balance with 157 tooth ring gear (4) Special Application for Internally balanced small block Ford Engines with 157 tooth ring gear

TORQUE CONVERTERS



Higher Stall, Higher Torque

WHY DO I NEED A B&M TORQUE CONVERTER?

The reason for considering a B&M Torque Converter boils down to performance. Higher stall speed is the key. A higher stall converter allows the vehicle to accelerate better from a dead stop and may provide tire-smoking performance.

B&M offers a wide range of performance torque converters to fit almost every need. All B&M converters are precision engineered, spin balanced and pressure tested. The B&M environmental drivetrain development lab is a key tool used in the development of every converter designed by the engineering staff. Precision engineered, tested and the success at the track provides proof that B&M Torque Converters are the finest you can buy.

WHAT SHOULD I EXPECT FROM A PERFORMANCE TORQUE CONVERTER?

Strength and durability is an additional benefit if the converter is properly engineered. Furnace brazing is used to strengthen the converter internally for high performance, racing and heavy-duty applications.

WHAT IS STALL SPEED?

Stall speed numbers are listed primarily to rate the converter's performance level. Typically, the number assigned, 2000, 2400, 3000 etc, lets you know what to expect from the converter. If a 2400 is selected, you should be able to flash stall the converter to about 2400 RPM.

This should provide anywhere from 500 to 1000 more RPM to launch, or accelerate, the vehicle from a dead stop, as compared to the stock converter in the vehicle. This increase should substantially improve the acceleration capability of the vehicle. Lighter cars, 2800 lbs and under, typically stalls a little lower than the above mentioned numbers, therefore you should choose a converter with a higher stall number for optimum performance.

HOW DOES THE ENGINE'S CAMSHAFT AFFECT THE TORQUE CONVERTER'S PERFORMANCE?

The camshaft will affect the torque curve of the engine, which will affect the performance of the converter. For example if your 350 CID engine produces 230 lb.ft. of torque at 2400 rpm, a B&M HoleShot 2000 Converter will produce 2000 rpm stall speed. If you install a 268-degree cam into this engine you will raise the torque curve and at 2400 rpm your engine will produce less torque. Thus the 2000 stall converter will only stall at 1800 or less. However with this new cam the engine will make much more power above 3000 rpm. Keep in mind when the torque curve of the engine is raised you will need more stall speed in the converter to allow the vehicle to accelerate at low rpm (below 3000). A good rule of thumb for advertised cam durations up to 248 degrees, a 2000 or 2400 stall converter is a good choice. Advertised cam durations up to 268 degrees, a 2400 or 3000 stall converter is a good choice. Advertised cam durations over 272 degrees, a 3000 to 3600 stall converter is a must.



NITROUS HOLESHOT™

RATED UP TO 700 HP & 550 FT-LBS

With the addition of anti-balloon plates, the Nitrous HoleShot is the strongest of the B&M street converter line. These converters will take the “instant hit” abuse of plate-type nitrous systems, and are also tough enough to handle the high power and torque of big cubic inch crate engines. All Nitrous HoleShot converters are completely balanced with full furnace brazed impeller and turbine, heavy duty needle type thrust bearings, new turbine hubs and anti-balloon plates, these are serious converters for serious performance street cars. Listed converters are NOT to be used in trans-brake applications.

WARNING: High-stall converters can build extra heat. B&M recommends installing a supplementary transmission oil cooler to control this extra heat, as well as a transmission temperature gauge to monitor the temperature of the transmission oil. Please see B&M cooling systems.

- Furnace brazed impeller and turbine
- New precision steel pump drive tube
- New heavy duty needle bearings used instead of thrust washers
- New springs and rollers in stator
- Dual pattern drive lugs on some GM HoleShots
- New turbine hub
- Anti-balloon plates



HOLESHOT™

RATED UP TO 600 HP & 500 FT-LBS

The B&M HoleShot converters are an excellent choice for improving acceleration and increasing drivetrain strength in virtually any street machine. An added benefit of a HoleShot high stall converter is when a higher duration camshaft is used, the engine idle is greatly improved when stopped in gear. These high quality balanced converters come standard with full furnace brazed impeller and turbine, heavy duty needle type thrust bearings, and new turbine hubs. Please note: If your vehicle has a large displacement engine or power adders such as nitrous, the B&M Nitrous HoleShot is a better choice.

*Note: Engines smaller than 350 cubic inches may not achieve indicated stall speeds. Listed converters are NOT to be used in transbrake applications.

- Furnace brazed impeller and turbine
- New precision steel pump drive tube
- Dual pattern drive lugs on some GM HoleShots
- New turbine hub
- New springs and rollers in stator
- New heavy duty needle bearings used instead of thrust washers





TRAVELER™

RATED UP TO 600 HP & 500 FT-LBS

B&M's Traveler converters are designed for use in heavy duty applications such as motor homes and tow vehicles. The slightly higher stall speed helps to get the heavy vehicle moving, without sacrificing normal highway operation. The minor 300 RPM increase on stall speed is also helpful in keeping transmission oil temperature lower, when compared to normal high stall converters. The Traveler is stronger than a stock converter as well, through the use of new pump drive tubes, needle bearings where equipped on the original model, and new thrust washers. These units are manufactured to B&M's specifications for long, trouble-free operation. Please note: Traveler converters are not to be used with a transbrake.

*WARNING: High stall converters can build extra heat. B&M recommends installing a supplementary transmission oil cooler to control this extra heat, as well as a transmission temperature gage to monitor the temperature of the transmission oil. Please see B&M cooling systems.

- Furnace brazed impeller and turbine fins – (not spot brazed)
- New precision steel pump drive tube
- Pressure tested
- Heavy duty needle thrust bearings between stator and turbine
- New thrust washer between turbine and cover
- Fully balanced



TORKMASTER™

RATED UP TO 350 HP & 350 FT-LBS

TorkMaster – High stall performance at an incredible value. These converters are excellent all-around performance street converters. Even without a highly modified engine, these converters will give you better acceleration through a higher stall speed, allowing the engine to develop more torque at the time of initial acceleration. These quality assembled converters are put together with new pump drive tubes, needle bearings were equipped on the original model, and new thrust washers. Please note: TorkMaster converters are not recommended for higher performance big blocks or super charged engines. Stall speed listings are based on an engine producing 230 ft.lb. of torque at 2,500 RPM. More torque at 2,500 RPM will give you greater than rated stall speed, less torque at 2,500 RPM will give you less than rated stall speed. TorkMaster converters are not to be used with a transbrake.

Note: Engines smaller than 350 cubic inches may not achieve indicated stall speeds. Listed converters are NOT to be used in transbrake applications.

- Highest quality “value priced” street performance converters available
- New precision steel pump drive tube
- Needle bearings where factory equipped
- New thrust washer between turbine and cover

CONVERTER APPLICATIONS

TRANSMISSION APPLICATION	Nitrous HoleShot 2400	Nitrous HoleShot 3000	Nitrous HoleShot 3600	HoleShot 2000	HoleShot 2400	HoleShot 3000	HoleShot 3600	Tork Master 2000	Tork Master 2400	Tork Master 3000	Traveler
GM '62-'73 POWERGLIDE					70411						
GM '65-'91 TH400, TH425, TH3754	20480	20481	20482	20416 ⁴	20412 ⁴	20413	20425	20400 ⁴	20404	20402	
GM '68-'81 TH350, TH375B6 (Will not fit TH350C)	20480	20481	20482	20416 ⁴	20412 ⁴	20413	20425	20400 ⁴	20404	20402	30423
GM '84-'93 TH700R4 30 spline (All cars & trucks)				70417 ⁶	70419 ⁶	70421 ⁷		70420 ⁶	70418 ⁶		70422 ⁶
GM '93-'96 4L60E 30 spline (V8s only)				70417 ¹⁰	70419 ¹⁰			70420 ¹⁰	70418 ¹⁰		70422 ¹⁰
GM '97-'04 4L60E Camaro & Firebird w/LS1				70440	70441	70442					
GM '91+ 4L80E (Not intended for diesel engines)							70434				70431
Chrysler '67-'81 Torqueflite A727 1&6					10415 ⁹	10425 ⁹		10416	10417 ⁹		
Ford '66-'91 C6 with 332, 352, 360, 390, 406, 427, 428, 429 CID with 1.848" crank pilot ³					40412						
Ford '71-'91 C6 w/289, 302, 351C, 351M, 351W, 400M, 460 CID with 1.375" crank pilot					40422 [*]	40442 [*]		40427 [*]			
Ford '70-'82 step case C4 with 10.5" bolt circle, 26 spline input shaft, 1.375" crank pilot	50449		50447	50448	50416	50436			50441	50442	
Ford '80-'92 AOD with 11.4" bolt circle, 1.375" crank pilot. Won't fit AODE/4R70W (See below)		40474		40472	40430 ²			40437 ⁸	40438 ⁸		
AODE					50402	50403					
Ford '66-'69 step case C4 with 10.5" bolt circle, 24 spline input shaft, 1.375 crank pilot					50412						

Engines smaller than 350 CID may not achieve stall speed indicated. Converters listed on this chart are not to be used in Transbrake applications. Stall speed listings are based on engine producing 230 lb. ft. of torque @ 2,500 rpm. If your engine produces more torque at 2,500 rpm stall speed may be higher. If your engine produces less torque you'll get less stall speed.

HoleShot vs. TorkMaster: HoleShots are furnace brazed and include more sophisticated bearings. Consequently they are able to withstand much more torque and horsepower. TorkMasters are great values for most small block applications except supercharged and nitrous engines. HoleShots or Nitrous HoleShots should be used in all 450 lb. ft. torque applications, all blown and nitrous applications.

Stall Speed: Very mild street cars will use a 2,000 rpm stall speed unit. Most street driven performance cars with 350 lb. ft. of torque or more need a 2,400 rpm unit. Cars with more radical small blocks (500 lb. ft. of torque at 4,500 rpm or higher) will need a 3,000 rpm converter. The more torque the motor puts out, the higher the resulting stall speed will be. Therefore most street performance big blocks like 2,400 rpm rated converters as they generally achieve 2,600-2,800 rpm.

Car Weight: Street rods generally do better with a 2,400 rpm converter even with a mild motor due to the vehicle's very lightweight. A 2,000

rpm converter will tend to require too much braking effort while idling, whereas the 2,400 rpm unit will be comfortable and still efficient.

1. B&M Chrysler Converters when used with an externally balanced engine require a B&M Flexplate.
2. Specially designed non-lockup converter, so that no input shaft change or transmission modification is required.
3. GM vehicles with variable-pitch trans (some '65-'67 Olds, Buick & Cadillac) must have pump and input shaft changed to fixed-pitch design to use B&M converter.
4. Requires small (10-3/4") bolt circle flexplate or dual pattern flexplate.
5. Will not fit lock-up converter or clutch converter models.
6. V-8's only, retains lockup feature. Can be run as lockup or non-lockup. This converter won't fit V6 or 4 cyl. (exc. 4.3L V6).
7. Non-lockup converter which requires transmission modifications. Parts and instructions are included
8. Standard lockup feature retained. AOD 'split path' feature retained.
9. Has 10" bolt circle.
10. Retains lockup feature.

* 1.375" crank pilot only

STARTERS

TRANSMISSIONS

FLEXPLATES

TORQUE CONVERTERS

AUTOMATIC SHIFTERS

MANUAL SHIFTERS

COOLING PRODUCTS

ACCESSORIES

TRANSMISSIONS



QUALITY SHIFTS EVERY TIME

Who would you trust with your car's performance? The drive-by-night transmission business or the company with over 60 years of experience in building and racing automatic transmissions? B&M may not be building the mighty Hydrotstick anymore, but the experience and skills gained at the race track with race proven results ensure B&M is still delivering the best performance automatic transmissions on the market. B&M offers two transmission choices based on your specific application.

STREET/STRIP TRANSMISSIONS

B&M's Street/Strip Transmission is a complete ready to run unit (less converter) for high performance street and mild strip use. These transmissions provides firm shifts, upgraded components and rebuilding tricks that only comes with years of experience. These transmissions all retain a standard shift pattern and are the best transmissions available today for Street/Strip use. We strongly recommend protecting your investment by adding a Super Cool transmission cooler with new B&M transmission installations.

CHRYSLER 727 TRANSMISSION

STREET/STRIP SERIES

The 727 Street/Strip Transmission has been built for performance minded enthusiasts who want a stronger more reliable transmission for their vehicle. The pump has been rebuilt to B&M specs, the factory friction plates have been replaced with high performance friction plates that can handle the increased load supplied by performance engines. In turn this extends clutch life and offers more holding power and less slippage resulting in better performance through the gears. The factory valve body has been recalibrated to B&M specifications for optimal line pressure and shift points. And the list of mods goes on. We strongly recommend protecting your investment by adding a SuperCooler transmission cooler with all new B&M transmission installations.

#111212

Fits 1967 to 1979 Chrysler, Dodge Plymouth with a A727 automatic transmission and a 361 to 440 CID engine using a non lock-up converter. Has 18-3/8 inch tailshaft and 6-1/2 inch separation on top bell housing bolts



- 2.45:1 first gear ratio, 1.45:1 second gear
- Rebuilt Performance Pump Assembly
- All New High Performance Friction Plates
- New Special Belleville Spring
- Five Clutch Direct Drum
- New Low Roller Clutch
- B&M 5.0 Servo Lever
- Four Pinion Front Carrier
- Fully Recalibrated Valve Body
- Max 500 HP / 450 lb ft Torque

GM TH350/TH400 TRANSMISSION

STREET/STRIP SERIES

We take each TH350/TH400 and make numerous improvements that have been well thought out and made for optimal performance in mind with these transmissions. The pumps have all been rebuilt to B&M specs. We tossed out the factory friction plates and replaced them with our high performance friction plates. Not only will this improve performance, but the clutches will last longer due to reduced slippage. We also replaced the intermediate roller clutches, new thrust bearings and races. New thrust bearings and races reduce the possibility of lateral movement of components resulting in less failure and better reliability. And the list of mods goes on and on. We strongly recommend protecting your investment by adding a transmission cooler with all new B&M transmission installations.

#113001

GM Turbo-Hydramatic 350 Street/Strip automatic transmission for 2 wheel drive models. 450 Hp maximum/ 400 TQ.

#112002

GM Turbo-Hydramatic 400 Street/Strip automatic transmission for use with large 1.875 Spicer yoke for 2 wheel drive models. 600 Hp maximum/ 550 TQ



- 2:52 1st gear, 1:52 2nd gear (TH350)
- 2:48 1st gear, 1:48 2nd gear (TH400)
- Extra Wide Direct Drum Bushing (TH350)
- Machined Forward & Direct Pistons (TH350)
- New Kickdown Band with Welded Anchors
- New Intermediate & Low Roller Clutches (TH350)
- All New High Performance Friction Plates Thrust Bearings & Races
- Adjustable Modulator, Detent Control Link with New Breather & Filter
- Fully Recalibrated Valve Body
- Hardened Intermediate Outer Race (TH350)
- Dual Piston Apply Feature on 2-3 Shift to Increase Torque Capacity (TH350) (TH350) Max 450 HP / 400 lb ft Torque - (TH400) Max 600 HP / 550 lb ft Torque

GM TH700/4L60 TRANSMISSION

STREET/STRIP SERIES

The 4L60 Street/Strip transmission is suitable for use behind engines producing up to 500 HP and 450 ft-lb of torque, which covers most small blocks and mild big blocks! It features a low first gear ratio and overdrive 4th, making it a very desirable unit. It also features several new components, along with a rebuilt front pump, governor with a new gear and a Corvette 2-4 servo assembly just to name a few. With a freshly rebuilt pump, your rest assured your new transmission has the proper oil flow rate and pressures. Can be used with Lock Up Control Unit. See B&M Lock Up Controllers on page ?

#117101

Fits 1984 and newer GM Turbo-Hydramatic 700R4 4L60 (not electronic shift model) Street/Strip automatic transmission with 30 Tooth splined converter. For 2 wheel drive models. No Corvette or 60 degree angled V6 models.



- 3:06 1st gear ratio, 1:63 2nd, 1:1 3rd & .70 OD ratio
- Corvette 2-4 Servo Assembly
- Fully Recalibrated Valve Body
- New Overdrive Sprag Assembly
- Rebuilt Performance Pump & Governor with new gear
- All new B&M High Performance Friction Plates
- New Thrust Washer kit, Races, Thrust Bearings & 2-4 Band
- High Performance Reaction Carrier Assembly
- Heavy Duty Sunshell
- Max 500 HP / 450 lb ft Torque

GM 4L60E TRANSMISSION

STREET/STRIP SERIES

The Street/Strip GM 4L60E is a must have for those wanting a high performance overdrive transmission. The years of experience and skills that B&M has gained at the track have been applied to these transmissions. Several parts have been replaced to assure optimal performance including replacing the factory friction plates with high performance friction plates, along with a rebuilt performance pump to assure optimum flow rate even in demanding conditions. A chrome transmission pan is installed to contain the fluid, but is aesthetically pleasing as well. The list goes on and on, which makes the Street/Strip GM 4L60E transmissions a very desirable unit. We strongly recommend protecting your investment by adding a SuperCooler transmission cooler with all new B&M transmission installations.

#117308

Fits 1998 and newer GM 4L60E (electronic shift model) 2 wheel drive Street/Strip automatic transmission. For use on LS type engines. Does not replace 4L60 (manual shift model)



- Beast Sunshell
- Reinforced Input Drum
- "Billet" Corvette 4th Gear Servo
- All New Solenoids & Wiring Harness
- 29 Element Dual Cage Sprag
- Fully Recalibrated Valve Body
- All New High Performance Friction Plates
- 8 Count 3-4 Friction Pack with Koleen Steels
- Chrome Standard Depth Transmission Pan
- Max 550 HP / 450 lb ft Torque

GM 4L80E TRANSMISSION

STREET/STRIP SERIES

The B&M Street/Strip GM 4L80E transmissions features all of the same high performance components found in other B&M transmissions including high performance friction materials, all new gaskets and seals and the unit is fully tested. Along with all the new parts installed, the factory valve body has been recalibrated to B&M specifications for optimal line pressure and shift schedule. The Street/Strip GM 4L80E Transmission has been built to handle up to 800 horsepower! We can proudly say that it is quite capable of receiving the fierce amount of power that your engine has to deliver. We strongly recommend protecting your investment by adding a SuperCooler transmission cooler with all new B&M transmission installations.

#118002

Fits GM 1997 and up models. Can be used with HGM Compushift Controller for transplant applications.



- 34 Element Intermediate Sprag
- High Energy Intermediate Band
- New Overdrive Sprag Assembly
- New Low Roller Assembly
- All New High Performance Friction Plates
- Fully Recalibrated Valve Body
- Rebuilt Performance Pump Assembly
- Steel Forward Hub
- Max 800 HP / 650 lb ft of Torque

FORD C-6 TRANSMISSION

STREET/STRIP SERIES

The Ford C-6 Street/Strip transmission comes with new internal components with high performance in mind. The odds of this transmission being mounted in a truck or behind a large cubic inch engine, is quite high. That is why we have replaced the factory friction plates with our high performance friction plates, a new adjustable modulator which relays engine load to the transmission so it can shift properly. With an adjustable modulator, you can raise or lower the line pressure, and even adjust shift points. This transmission is equipped with all kinds of new parts so it's one less thing you have to worry about when modifying the drivetrain in your vehicle. We strongly recommend protecting your investment by adding a SuperCooler transmission cooler with all new B&M transmission installations.

#114202

Fits 1970 to 1989 Ford C6 Street/Strip automatic transmission. For use on 289 cid, 302 cid, 351 Cleveland and 351 Windsor engines. For 2 wheel drive models.

#114002

Fits 1966 to 1976 Ford C6 Street/Strip automatic transmission. For use on 390, 427 and 428 CID engine. 13-1/2" tailshaft.



- 2.46:1 first gear ratio, 1.46:1 second gear
- Rebuilt Performance Pump Assembly and Governor
- All New High Performance Friction Plates
- New Intermediate Flex Band
- New Low Roller Clutch with Lube Hole in Inner Race
- New High Performance Adjustable Modulator
- New Belleville Spring
- Fully Recalibrated Valve Body
- Max 600 HP / 550 lb ft of Torque

FORD AOD TRANSMISSION

STREET/STRIP SERIES

Our Ford AOD Street/Strip transmissions have been modified specifically for 1980-1993 Mustangs. Whether you are driving on the street or track, this transmission will prove to be a well modified upgrade for your Mustang. The factory friction plates have been removed, and replaced with high performance friction plates, a new lower roller clutch and more. Aside from the hand full of new parts installed in this transmission, the AOD Street/Strip transmission also comes with a rebuilt front pump and governor which assures that your new transmission has the proper oil flow rate and pressure. We strongly recommend protecting your investment by adding a SuperCooler transmission cooler with all new B&M transmission installations.

#114501

Fits 1980 to 1993 Ford Mustangs with 2 wheel drive and an AOD automatic transmission. For use on 289 cid, 302 cid, 351 Cleveland, and 351 Windsor engines.

#114102

Fits Ford, Lincoln and Mercury 1966 to 1989 with a C6 automatic transmission and a 429, 460, 351M, 400 CID engine. Has 13-1/2 inch tailshaft and 7-3/4 inch separation of top bell housing bolts.



- 2.40:1 first gear ratio, 1.47:1 second gear, .67:1 OD
- Rebuilt Performance Pump Assembly and Governor
- Comes w/ B&M Shift Lever or stock Mustang Lever for use in Late Model Mustangs
- All New High Performance Friction Plates
- New Overdrive Band
- New Low Roller Clutch with Lube Hole in Inner Race
- New Transmission Filter
- Fully Recalibrated Valve Body
- Max 500 HP / 450 lb ft Torque



SHIFT IMPROVEMENT KITS

FOR AUTOMATIC TRANSMISSIONS

Here at B&M, we find the term “slush box” extremely offensive when used in the context of an automatic transmission. If those two words are a fitting description of the shift quality in your vehicle, we are here to help. B&M offers a range of kits that will give your automatic transmission anything from a subtle improvement all the way to that race-car quality shift which B&M transmission’s are famous for.

B&M’s Transmission Kits modify an automatic transmission’s shift timing in order to increase shift firmness and in turn improve durability. This is because many OEM’s allow far

too much shift overlap in their transmissions. With too much overlap comes not only that dreaded, disconnected, “Slushy” feeling when driving, but also decreased efficiency and durability because of excess heat.

With a B&M Transmission Kit, you can reduce this overlap period, which has several benefits: Not only is the shifting action improved, but because less slippage is occurring you can notice improvements in city fuel economy. Finally, with less heat being generated by the transmission itself, there is less stress on the seals and clutches within the transmission, improving reliability.

SHIFT IMPROVER KIT

The B&M Shift Improver Kit is the easiest way to gain the performance you want out of your automatic transmission. With this kit you can choose between two modes of performance: Heavy Duty, or Street/Strip. The Shift Improver Kit is B&M’s most economical and simplest to install kit – all you need are some hand tools! In the space of an afternoon, you can turn your transmission into a B&M tuned performer.

TRANSPAK

The next step above B&M’s Shift Improver Kit is the TransPak. The TransPak has all the features found in the Shift Improver Kit, plus it provides additional manual control capabilities to the driver (GM TH 400, 350, Ford C-6 & Chrysler Torqueflite only.) Most stock automatic transmissions won’t downshift into low gear above 15 MPH, and automatically upshift at a predetermined speed no matter what gear you’re in. With the TransPak, you can downshift at any speed, and you can hold the transmission in first gear to any speed you want! A TransPak will allow you the control to do everything from rev-out a modified engine for maximum performance, to hold a tow vehicle in low gear while descending a grade.

TRANSKIT

60 years of transmission knowledge packed into a very small box! If you have the time, we’ve got the parts to transform your automatic transmission into a relative of the mighty Hydrostick. This is our top of the line transmission kit, and comes with full instructions on how to assemble your transmission to B&M specifications (part numbers 20229, 30229, 50231, and 10229 only.) These kits also include special directions on modifying your case, pump, and other components to provide you with all the science and knowledge gained from every specialty B&M transmission since 1953.

SHIFTPLUS

Electronic controls can be a double-edged sword — on one side, they make it very easy to change the attributes of a system without taking it apart, but the other side is that without extremely specialized knowledge and equipment they are impossible to change. B&M’s Shiftplus is here to help! The Shiftplus control box electronically recalibrates your transmission’s hydraulic system, reducing both slippage and heat. This improves the shift quality of your vehicle and also extends transmission life! The best part is that all of this takes place without ever having to remove the transmission pan or valve body. Every Shiftplus kit comes with a switch that allows the driver to control the mode of the transmission, choosing between stock or performance modes.



SHIFT IMPROVER APPLICATIONS

CHEVROLET, BUICK, OLDS, PONTIAC, GMC	
'88-'94 TH400 (3L80)	20261
'65-'87 TH400, 375 & M40	20260
'68-'81 TH350, 375B & M38 (For TH350C use TransPak #30235)	30262
'82-'93 TH700-R4/4L60	70239*
'93-'06 4L60E	70360*

*Separator plate not included.

SHIFT IMPROVER KIT

Performance made easy! The B&M Shift Improver Kit is a simple and affordable way to get the performance you have always wanted from your transmission. Choose between two configurations: Heavy Duty, or Street/Strip. With some simple hand tools and an afternoon, you can have 60 years of performance tuning built into your transmission. B&M transmission performance has never been so attainable.

STAGE 1. HEAVY DUTY

Firm, positive shifts without loss of passenger comfort for improved performance in all street vehicles. Recommended for normal passenger vehicles and tow vehicles.

STAGE 2. STREET/STRIP

Provides positive shifts for high performance street use or competitive events. This configuration is for the enthusiast who wants hard, fast shifts.

- Recalibrate your transmission's shift timing
- Select the configuration that best suits your application
- Provides well appointed, crisp shifts
- Eliminates excessive shift overlap
- Less wear and tear on your transmission's clutches and bands

SHIFT IMPROVER APPLICATIONS (continued)

FORD, LINCOLN, MERCURY	
'67-'91 C6	40262
'80-'92 AOD	40263
'67-'69 C4	50260
'70-'82 C4	50262
'92-'95 AODE/4R70W	40264
'96-'99 4R70W	40266
'89-'97 E40D	10025
CHRYSLER, DODGE, PLYMOUTH	
'66-'70 TF A727	10226
'71-'77 TF A727	10225
'66-'77 TF A904 w/6 cyl. engine	10226
'68-'70 TF A904 w/V-8 engine	10226
'71-'77 TF A904 w/V-8 engine	10225

B&M MASTER RACING OVERHAUL KIT

Includes all OEM gaskets, seals, bushings, and high performance friction materials for a complete high performance or racing overhaul. Note: transbrake body gaskets/components and installation instructions are not included.

- Complete high performance or racing transmission overhaul
- Includes only OEM valvebody gaskets
- Instructions not included
- Great for rebuilding
- Sold as a kit

GM TRANSMISSIONS	PART NUMBER
GM Powerglide Master Racing Overhaul Kit	21040
GM TH400 Master Racing Overhaul Kit	21041
GM TH350 Master Racing Overhaul Kit	21042





B&M TRANSPAK™

The next step up from the Shift Improver Kit is the TransPak. It has all the features in the Shift Improver Kit plus it provides additional driver manual control (GM TH400, 350, Ford C-6 & Chrysler Torqueflite only). Most stock automatic transmissions won't downshift into low gear above 15 mph, and automatically upshift at a predetermined speed no matter what gear you're in. With the TransPak, you can downshift at any speed, and you can hold the transmission in first gear to any speed you want! This is an asset when you've got a modified engine, and you want additional RPMs, are towing a trailer, or driving heavy loads downhill.

STAGE 1. HEAVY DUTY

For street rods, passenger vehicles, or heavy duty use. Firmer shift feel as compared to stock, but not harsh. Improves transmission performance and life dramatically without loss of comfort. Retains normal automatic operation when in drive.

STAGE 2. HIGH PERFORMANCE STREET

For maximum performance street use. All of the same features as the Heavy Duty configuration, but with faster shifts. Retains normal automatic operation when in drive.

- Performance calibration and shift timing
- Select the configuration that best suits your application
- Improves transmission life by reducing heat
- Additional manual control provided for lower gears

TRANSPAK APPLICATIONS

CHEVROLET, BUICK, OLDS, PONTIAC, GMC

'82-'93 TH700R4 (4L60)	70235
'65-'87 TH400, 375, and M40	20228
'68-'81 TH350, 375B, and M38	30228
'80-'86 TH350C	30235
'93-'04 4L60E	70365

FORD, LINCOLN, MERCURY

'80-'92 AOD (except '92 & later w/electronic shift)	40227
'67-'91 C6	40228
'70-'82 C4	50229

CHRYSLER, DODGE, PLYMOUTH

'66-'77 A727 & A904	10228
'78-'96 TF 727, 518, 46RH & 47RH	10227
'78-'96 TF 904, 999, 32RH, 42RH & 500	10227



B&M TRANSKIT™

If you've got the time, we've got what you need! This kit allows you to perform a complete transmission refresh, plus upgrade to full B&M specifications! The kit contains parts and instructions that put 60 years of automatic transmission knowledge to work - for you. *Special instructions include how to modify your case, pump, and other components to get top level performance. This ensures that you have all the tips and tricks built in to your transmission right from the start.

Even if you have limited experience with automatic transmissions, rest assured all the required information is included to completely rebuild your transmission into a real performer.

*Note – Does not include 70233

- Same quality components used in a B&M Street/Strip transmission
- Includes B&M TransPak modification components
- Includes all the necessary parts to convert your valve body to a full B&M manual/automatic valve body
- Refresh your entire transmission, improve shift action with key modifications along the way
- B&M high performance friction materials
- Drain plug kit included

TRANSKIT APPLICATIONS

CHEVROLET, BUICK, OLDS, PONTIAC, GMC	
'87-'93 TH700R4 (not for 4L60E)	70233
'65-'87 TH400, 375 & M40	20229
'68-'81 TH350, 375B & M38	30229
'96+ 4L80E	70227
FORD, LINCOLN, MERCURY	
'70-'82 C4	50231
CHRYSLER, DODGE, PLYMOUTH	
'70-'77 TF A727	10229
'78-'79 TF A727 w/non lock-up conv.	10229



B&M SHIFTPLUS™

B&M's ShiftPlus electronically recalibrates your transmission by reducing shift overlap, the time it takes shifting from one gear to the next, and also gives a quicker more positive upshift.. This dramatically improves the shift quality of your vehicle, making driving much more enjoyable. Also, firmer shifts reduce slippage and associated heat, increasing the reliability of your transmission. The best part of ShiftPlus is you can easily achieve all of this without disassembling your transmission!

#70380

GM Rear wheel drive & 4WD trans code MT1 or M30 (RPO code found on sticker in glove box) '93-'98 Suburban, Tahoe, Blazer (C/K, S/T), pickup (C&K) 1500, 2500, 3500, Impala, Camaro, Firebird & '94-'98 Corvette (will not fit '99 & later vehicles)

#70381

Ford RWD & 4WD trans code D, E, P, U, H, L & V (found on plate on driver door post) '97 Expedition/Navigator, '95-'97 Explorer, '95-'97 pickup, F-150, F-250, '94-'97 F-350, '94-'97 Mustang, Thunderbird & Cougar, '93-'97 Lincoln Mark VIII (will not fit '97 & later vehicles)

- Electronically recalibrate your automatic transmission!
- Reduces slippage and heat
- Install without removing the transmission pan or valve body
- Transfer between stock and performance modes with the flip of a switch
- 50 state emissions legal

AUTOMATIC SHIFTERS



BUYERS GUIDE

	FEATURES	STARSHIFTER	Z-GATE	UNIMATIC	SPORT	QUICKSILVER	MEGSHIFTER	HAMMER	PRO RATCHET	PRO STICK	STEALTH PRO RATCHET	PRO BANDIT	STREET BANDIT
	Ratchet	X				X	X	X	X		X		
	Gated		X							X		X	X
	Detent	X		X	X								
	Console Mount					X	X	X					
	Reverse Lockout (Lift Stick)					X							
	Reverse Lockout (Trigger Operated)	X	X				X	X	X	X	X	X	X
	Reverse Pattern Manual Valve Bodied Transmissions					X*	X*		X	X	X	X	X
	Interchangeable Gate Plate									X		X	X
	Lighted Gear Indicator		X		X	X	X	X					
MAKE	TRANSMISSION TYPE												
GM	Powerglide (w/ Manual Valve Body)								X	X	X	X	X
	TH200	X	X	X	X	X	X	X	X	X	X	X*	X
	TH250	X	X	X	X	X	X	X	X	X	X	X*	X
	TH350	X	X	X	X	X	X	X	X	X	X	X*	X
	TH400	X	X	X	X	X	X	X	X	X	X	X*	X
	700R4			X	X	X	X	X	X	X*	X	X*	X
	200-4R/200R4			X	X	X	X	X	X	X*	X	X*	X
	4L60							X					
	4L60E			X*	X*	X*	X*		X*		X*	X*	X*
	4L65E			X*	X*	X*	X*		X*		X*	X*	X*
	4L80E				X*	X*		X*		X			
	4L85E				X*	X*		X*		X			
Ford	C4	X	X	X	X	X	X	X	X	X	X	X*	X
	C6	X	X	X	X	X	X	X	X	X	X	X*	X
	AOD			X*	X*	X*	X*	X*	X*	X*	X*		
	AODE & 4R70W			X*	X*	X*	X*	X*	X*	X*	X*		
	E40D & 4R100			X*	X*	X*	X*	X*	X*	X*	X*		
Chrysler	A727 ('66 & later)	X	X	X	X	X	X	X	X	X	X	X*	X
	A904 ('66 & later)	X	X	X	X	X	X	X	X	X	X	X*	X

*May require additional B&M parts for indicated applications.

Gated – Manually select gear with trigger or lever to gated location

Ratchet – Slapstick style shifter (i.e. bang shifter forward or backward to engage gears)

Detent – Similar to OEM style shifter

Console Mount – Mounts inside of factory console (ratchet style shifters only)

Reverse Lockout – Prevents going into reverse by accident, have to disengage safety lock to engage reverse gear

Reverse Manual Pattern – For transmissions where forward gears are in reverse (1-2-3 vs. 3-2-1 forward gears when going from park to reverse to neutral to forward gear). Primarily used for drag racing

Interchangeable Gate Plates – For converting to 2, 3, or 4-speed transmission types (Pro Stick and Bandit shifters only)



UNIMATIC™

SPORTSHIFTER™

STARTERS

TRANSMISSIONS

FLEXPLATES

TORQUE CONVERTERS

AUTOMATIC SHIFTERS

MANUAL SHIFTERS

COOLING PRODUCTS

ACCESSORIES



#80775 UNIMATIC™



#80776 SPORTSHIFTER™

#80775 UNIMATIC™

One of the easiest shifters to operate and install, the Unimatic shifter was designed to look just like a manual 4-speed when installed. Although, not a “race” shifter by any means, this unit is just as durable and trouble-free as the top-of-the-line B&M race shifters which is why this shifter and all B&M shifters are backed by a Lifetime Limited Warranty.

- Smooth and simple to operate detent shifting
- Stylish chrome stick and black plastic T-handle
- Includes polymer shifter boot, boot trim ring, neutral safety switch, and a 5' shift cable
- All necessary brackets and levers are included to fit listed transmission applications including most popular 3 & 4-speed automatic transmissions (some additional parts may be required for other transmission applications)

TRANSMISSION MAKE	TRANSMISSION MODEL
GM	TH400, 350, 250, 200, 700R4, 200-4R, 4L60E*, and 4L65E*
Ford	C4, C6, AOD*, AODE*, 4R70W, E40D*, and 4R100*
Chrysler	A727 and A904 (1966 and later)

*4L60E & 4L65E with PRNDL switch require accessory kit #70499. AOD requires #40496 installation kit. AODE & 4R70W requires #40504 installation kit. E40D & 4R100 requires #40505 installation kit.

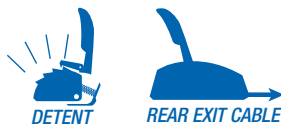

#80776 SPORTSHIFTER™

The SportShifter may be a low-cost alternative to B&M's top-of-the-line MegaShifter, but performs as if it were twice the price! Utilizing a simple to operate detent action between first, second, high, and neutral, it features an illuminated gear indicator, black T-handle, neutral safety switch, backup light switch, and flat aluminum stick.

- Smooth and simple to operate detent shifting
- Includes backup light switch, neutral safety switch, illuminated gear indicator, black plastic T-handle, 5' shift cable, and all necessary brackets and levers are included to fit listed applications (some additional parts may be required for other transmission applications.)
- Stout shifter base shroud that can be trimmed to fit a multitude of floor contours and tunnel shapes

TRANSMISSION MAKE	TRANSMISSION MODEL
GM	TH400, 350, 250, 200, 700R4, 200-4R, 4L60E*, 4L65E*, 4L80E*, and 4L85E*
Ford	C4, C6, AOD*, AODE*, 4R70W, E40D*, and 4R100*
Chrysler	A727 and A904 (1966 and later)

*4L60E & 4L65E with PRNDL switch require accessory kit #70499. AOD requires #40496 installation kit. AODE & 4R70W requires #40504 installation kit. E40D & 4R100 requires #40505 installation kit.



STARSHIFTER™

Z-GATE™

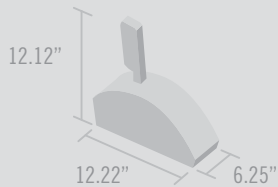

#80675 STARSHIFTER

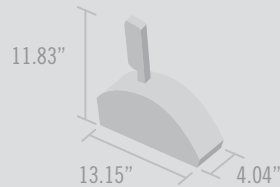

#80681 Z-GATE

#80675 STARSHIFTER™

The StarShifter is the perfect blend of form and function at a reasonable price while still giving you the option for the same ratchet-action and meets NHRA/IHRA reverse lockout requirements. In normal shift mode, the StarShifter operates as a straight-line detent shifter. But drop the shifter into low gear, lift the trigger up and pull the stick back to convert to ratchet-action. Now you can bang the stick forward through the gears without missing a gear.

- One-hand/one-step reverse lockout operation that meets NHRA/IHRA requirements
- Includes backup light switch, neutral safety switch, mechanical gear indicator, polished T-handle, a 5' shift cable and all necessary brackets and levers to fit listed transmission applications
- Fits certain 3-speed transmissions only (cannot be used on 4-speed, TH700R4, TH200-4R, AOD, AODE, or reverse pattern manual valve bodied transmissions)

TRANSMISSION MAKE	TRANSMISSION MODEL
GM	TH400, 350, 250, 200
Ford	C4 and C6
Chrysler	A727 and A904 (1966 and later)

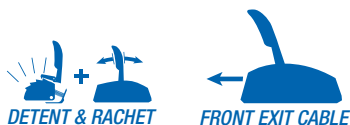

#80681 Z-GATE™

Sometimes the best design is the simplest one and the Z-Gate shifter is a great example. With the fewest moving parts of any of the automatic shifters in the B&M shifter-line, the Z-Gate shifter and its patented internal "Z" shaped gate system eliminates the possibility of over-shifting and missing gears. Fewer moving parts mean less possibility of failure and with many of the same great features of the higher priced shifters – you can't go wrong!

- Smooth gate shifting
- One-hand/one-step reverse lockout operation that meets NHRA/IHRA requirements
- Includes backup light switch, neutral safety switch, illuminated gear indicator, a 5' shift cable, and all necessary brackets and levers are included to fit listed transmission applications
- Fits certain 3-speed transmissions only (cannot be used on 4-speed automatics or reverse pattern manual valve bodied transmissions.)

TRANSMISSION MAKE	TRANSMISSION MODEL
GM	TH400, 350, 250, 200
Ford	C4 and C6
Chrysler	A727 and A904 (1966 and later)

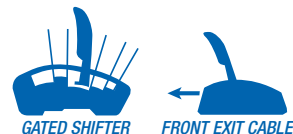

HAMMER

The Hammer shifter may just be the most comfortable automatic shifter you can buy. The unique design easily fits small to large hands and provides the appropriate wrist angle. The multi-position trigger is spoon-shaped for easy operation in a multitude of grip positions. The result is a shifter which is perfect for all new-generation vehicles and street rods where style is not just form, but function.



#80885 HAMMER

#80885 HAMMER CONSOLE

#80885 HAMMER

- Quick & easy to operate with smooth ratchet-action shifting
- Includes internal backup light switch, internal neutral safety switch, illuminated gear position indicator, Hammerhead T-handle and 5' cable
- Stout shifter base shroud that can be trimmed to fit a multitude of floor contours and tunnel shapes
- Can be used with reverse pattern valve bodies

TRANSMISSION MAKE	TRANSMISSION MODEL
GM	TH400, 350, 250, 200, 700R4, 200R4, 4L80E*, and 4L85E*
Ford	C4,C6, AOD*, AODE*, 4R70W*, E40D*, and 4R100*
Chrysler	A727 and A904 (1966 and later)

*4L80E & 4L85E with PRNDL switch require accessory kit #75498. AOD requires #40496 installation kit. AODE & 4R70W require #40504 installation kit. E40D & 4R100 require #40505 installation kit.



RATCHET ACTION



FRONT EXIT CABLE

#81002/81001 HAMMER CONSOLE

- Quick & easy to operate with smooth, ratchet-action shifting
- Short throw ratchet action reduces shift time
- Includes internal backup light switch, internal neutral safety switch, illuminated gear position indicator, and Hammer T-handle
- Works with stock automatic transmission shifter cable for easy install
- Direct console fit and direct OEM shifter replacement



RATCHET ACTION



REAR EXIT CABLE

#81001 FITS '94-'04 MUSTANG

TRANSMISSION MAKE	TRANSMISSION MODEL
Ford	AOD and C4

*C4 requires part number 81020 installation kit. Uses factory cable.

#81002 FITS '87-'93 MUSTANG

TRANSMISSION MAKE	TRANSMISSION MODEL
Ford	AOD and C4

*C4 requires part number 81020 installation kit. Uses factory cable.

STARTERS

TRANSMISSIONS

FLEXPLATES

TORQUE CONVERTERS

AUTOMATIC SHIFTERS

MANUAL SHIFTERS

COOLING PRODUCTS

ACCESSORIES

QUICKSILVER™

Originally designed to be a clean triggerless and bootless shifter, the QuickSilver shifter smoothly ratchets through the forward gears all the way through to the neutral position with a sharp, uncluttered look that is reminiscent of many manual transmissions. Simply lift the stick while in drive to access reverse and park. Lift again to move from park to the forward gears – it is that simple! Shifting is smooth, easy, and safe with the QuickSilver shifter.



#80683 QUICKSILVER™



#81125 QUICKSILVER™ CONSOLE

#80683 QUICKSILVER™

- Stylish chrome stick, knob, and top plate/housing
- One-hand/one-step reverse lockout operation that meets NHRA/IHRA requirements
- Includes backup light switch, neutral safety switch, illuminated gear indicator, chrome knob with insert, and a 5' shift cable, and all necessary brackets and levers are included to fit listed transmission applications including most popular 3 & 4 speed automatic transmissions
- Works with forward and reverse patterns

TRANSMISSION MAKE	TRANSMISSION MODEL
GM	TH400, 350, 250, 200, 700R4, 200-4R, 4L60E*, 4L65E*, 4L80E*, 4L85E*
Ford	C4, C6, AOD*, AODE*, 4R70W*, E40D*, and 4R100*
Chrysler	A727 and A904 (1966 and later)

*4L60E, 4L65E, 4L80E, and 4L85E with PRNDL switch require accessory kit #70499. AOD requires #40496 installation kit. AODE & 4R70W require #40504 installation kit. E40D & 4R100 require #40505 installation kit.



#81125 QUICKSILVER CONSOLE

'68-'72 CHEVELLE/EL CAMINO

- Direct console fit and direct OEM shifter replacement (does not fit 1967 console)
- One-hand/one-step reverse lockout operation that meets NHRA/IHRA requirements
- Includes backup light switch, neutral safety switch, illuminated gear indicator, chrome knob, a 5' shift cable, and all necessary brackets and levers are included to fit listed transmission applications which include most popular 3 and 4 speed automatic transmission applications
- Works with forward and reverse patterns

TRANSMISSION MAKE	TRANSMISSION MODEL
GM	TH400, 350, 700R4, 4L60, 4L60E, 4L65E, 4L80E and 4L85E

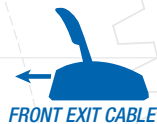



#81025 QUICKSILVER™ CONSOLE



#80688 QUICKSILVER™ CONSOLE

#81025 QUICKSILVER™ CONSOLE

'68-'69 CAMARO

- Direct console fit and direct OEM shifter replacement (does not fit 1967 console)
- One-hand/one-step reverse lockout operation that meets NHRA/IHRA requirements
- Includes backup light switch, neutral safety switch, illuminated gear indicator, chrome knob, a 5' shift cable, and all necessary brackets and levers are included to fit listed transmission applications which include most popular 3 and 4 speed automatic transmission applications
- Works with forward and reverse patterns

TRANSMISSION MAKE	TRANSMISSION MODEL
GM	TH400, 350, 700R4, 4L60, 4L60E, 4L65E, 4L80E and 4L85E



RATCHET ACTION



FRONT EXIT CABLE

#80688 QUICKSILVER™ CONSOLE

'73-'81 CAMARO AND '70-'81 FIREBIRD

- Smooth ratchet shifting
- Stylish chrome stick, knob, and top plate/housing
- One-hand/one-step reverse lockout operation that meets NHRA/IHRA requirements
- Direct console fit and direct OEM shifter replacement
- Includes illuminated gear indicator, chrome knob
- Works with forward and reverse patterns

TRANSMISSION MAKE	TRANSMISSION MODEL
GM	TH400, 350, 700R4, 4L60, 4L60E, 4L65E, 4L80E and 4L85E



RATCHET ACTION



FRONT EXIT CABLE

MEGASHIFTER™

By far B&M's most popular shifter design in form and function, the MegaShifter has become an American icon in the hot rod and racing industry. All due to its smooth ratcheting shift action, positive "impossible-to-miss-a-gear" shifting and its classic race look. The MegaShifter is always one of the first performance parts a driving enthusiast installs into his or her hot rod, truck, muscle car and race car.

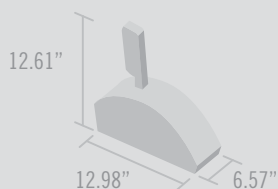

#80690 MEGASHIFTER™

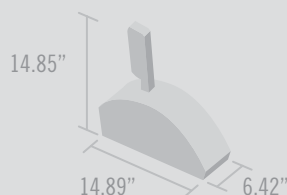

#80680 LIGHT TRUCK MEGASHIFTER™

#80690 MEGASHIFTER™

- Stylish chrome stick, handle, trigger and plate with smooth ratchet shifting
- One-hand/one-step reverse lockout operation that meets NHRA/IHRA requirements
- Includes backup light switch, neutral safety switch, illuminated gear indicator, polished T-handle, a 5' shift cable, and all necessary brackets and levers are included to fit listed transmission applications which include most popular 3 and 4-speed automatic transmission applications
- Stout shifter base shroud that can be trimmed to fit a multitude of floor contours and tunnel shapes

TRANSMISSION MAKE	TRANSMISSION MODEL
GM	TH400, 350, 250, 200, 700R4, 200-4R, 4L60E*, and 4L65E*
Ford	C4,C6, AOD*, AODE*, 4R70W*, E40D*, and 4R100*
Chrysler	A727 and A904 (1966 and later)

*4L60E & 4L65E with PRNDL switch require accessory kit #70499. AOD requires #40496 installation kit. AODE & 4R70W require #40504 installation kit. E40D & 4R100 require #40505 installation kit.



RATCHET ACTION



FRONT EXIT CABLE

#80680 LIGHT TRUCK MEGASHIFTER™

- Stylish chrome stick, handle, trigger and plate with smooth ratchet shifting
- Taller base for trucks and tall bench seat applications
- One-hand/one-step reverse lockout operation that meets NHRA/IHRA requirements
- Includes backup light switch, neutral safety switch, illuminated gear indicator, polished T-handle, a 5' shift cable, and all necessary brackets and levers are included to fit listed transmission applications which include most popular 3 and 4-speed automatic transmission applications

TRANSMISSION MAKE	TRANSMISSION MODEL
GM	TH400, 350, 250, 200, 700R4, 200-4R, 4L60E*, and 4L65E*
Ford	C4,C6, AOD*, AODE*, 4R70W*, E40D*, and 4R100*
Chrysler	A727 and A904 (1966 and later)

*4L60E & 4L65E with PRNDL switch require accessory kit #70499. AOD requires #40496 installation kit. AODE & 4R70W require #40504 installation kit. E40D & 4R100 require #40505 installation kit.



RATCHET ACTION



FRONT EXIT CABLE

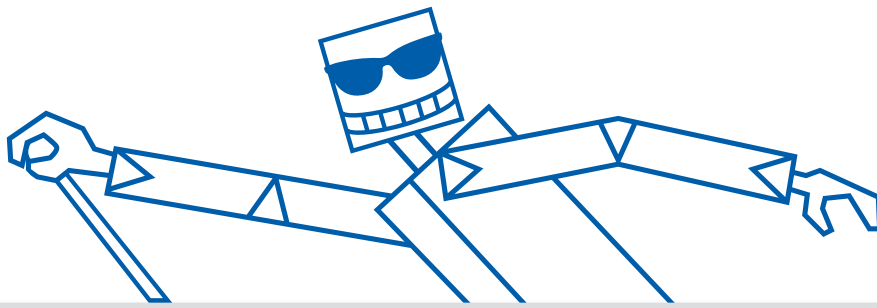

#81035 MEGASHIFTER™ CONSOLE



#80694/80692 MEGASHIFTER™ CONSOLE

#81035 MEGASHIFTER™ CONSOLE

'68-'69 CAMARO

- Direct console fit and direct OEM shifter replacement (does not fit 1967 console)
- Smooth ratchet shifting
- One-hand/one-step reverse lockout operation that meets NHRA/IHRA requirements
- Includes backup light switch, neutral safety switch, illuminated gear indicator, polished T-handle, a 5' shift cable, and all necessary brackets and levers are included to fit listed transmission applications.

TRANSMISSION MAKE	TRANSMISSION MODEL
GM	TH400, 350, 700R4, 4L60, 4L60E, and 4L65E



#80694/80692 MEGASHIFTER™ CONSOLE

'73-'92 CAMARO AND '70-'92 FIREBIRD

- Direct console fit and direct OEM shifter replacement
- Smooth ratchet shifting
- One-hand/one-step reverse lockout operation that meets NHRA/IHRA requirements
- Includes backup light switch, neutral safety switch, illuminated gear indicator, polished T-handle, a 5' shift cable, and all necessary brackets and levers are included to fit listed transmission applications.

GEN 2 CAMARO/FIREBIRD #80694

Fits 1973 to 1981 Chevrolet Camaro and 1970 to 1981 Pontiac Firebird's.

TRANSMISSION MAKE	TRANSMISSION MODEL
GM	TH400, 350, 200, 700R4, 4L60, 4L60E, and 4L65E



GEN 3 Camaro/Firebird #80692

Fits 1982 to 1992 Chevrolet Camaro and Pontiac Firebirds. Does not fit 1988 to 1992 Firebird Formula model.

TRANSMISSION MAKE	TRANSMISSION MODEL
GM	TH400, 350, 200, 700R4, 4L60, 4L60E, and 4L65E

PRO STICK

B&M's original hardcore race shifter, the Pro Stick is purely about function and dependability. This solid and durable shifter has been made to take the abuse of adrenaline-filled racing. B&M is so confident that this shifter will outlast a lifetime of racing, that the B&M Pro Stick (as all B&M shifters) is backed by a Lifetime Limited Warranty. Whether you're air solenoid, CO2 or just manual shifting this shifter can handle the job!

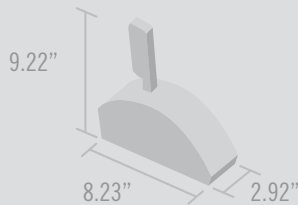

#80702 PRO STICK FOR POWERGLIDE



#80704/80706 PRO STICK-ALUMINUM COVER

#80702/80704/80706 PRO STICK

- Billet aluminum stick, heat-treated/hardened 2-speed gate plate, and plate steel base
- One-hand/one-step reverse lockout operation that meets NHRA/IHRA requirements
- Meets NHRA & IHRA reverse lockout requirements
- Interchangeable gate plate system easily allows the install of various B&M gate plates for most popular 2, 3, and 4-speed automatic transmissions including reverse patterns (sold separately)



#80702 PRO STICK FOR POWERGLIDE WITHOUT COVER

TRANSMISSION MAKE	TRANSMISSION MODEL
GM	1962-1973 Powerglide automatic

#80704 PRO STICK FOR POWERGLIDE WITH COVER

TRANSMISSION MAKE	TRANSMISSION MODEL
GM	1962-1973 Powerglide automatic

#80706 PRO STICK-ALUMINUM COVER

TRANSMISSION MAKE	TRANSMISSION MODEL
GM	TH400, 350, 250, 200, 700R4, 200-4R, 4L80E*, and 4L85E*
Ford	C4,C6, AOD*, AODE*, 4R70W*, E40D*, and 4R100*
Chrysler	A727 and A904 (1966 and later)

*4L80E and 4L85E equipped with a PRNDL switch will need the optional accessory kit #75498. TH700R4, 200-4R, 4L80E, and 4L85E require a 4-speed gate plate #80712. Ford C4, C6. AOD requires #40496 installation kit. Ford AODE & 4R70W require installation kit #40504. Ford E40D & 4R100 require installation kit #40505.



#81041 MAGNUM GRIP FOR POWERGLIDE



#81041 MAGNUM GRIP-ALUMINUM COVER



#81052 MAGNUM GRIP STEALTH PRO STICK

#81040/81041/81052 MAGNUM GRIP PRO STICK

#81041 MAGNUM GRIP PRO STICK-ALUMINUM COVER

TRANSMISSION MAKE	TRANSMISSION MODEL
GM	TH400, 350, 250, 200, 700R4, 200-4R, 4L80E*, and 4L85E*
Ford	C4,C6, AOD*, AODE*, 4R70W*, E40D*, and 4R100*
Chrysler	A727 and A904 (1966 and later)

*4L80E and 4L85E equipped with a PRNDL switch will need the optional accessory kit #75498. TH700R4, 200-4R, 4L80E, and 4L85E require a 4-speed gate plate #80712. Ford C4, C6, and AOD (AOD requires #40496 installation kit. Ford AODE & 4R70W requires installation kit #40504. Ford E40D & 4R100 requires installation kit #40505). Chrysler 1966 and later Torqueflite A727 and A904.

#81041 MAGNUM GRIP PRO STICK FOR POWERGLIDE

TRANSMISSION MAKE	TRANSMISSION MODEL
GM	1962-1973 Powerglide automatic

#81052 MAGNUM GRIP STEALTH PRO STICK

TRANSMISSION MAKE	TRANSMISSION MODEL
GM	TH400, 350, 250, 200, 700R4, 200-4R, 4L80E*, and 4L85E*
Ford	C4,C6, AOD*, AODE*, 4R70W*, E40D*, and 4R100*
Chrysler	A727 and A904 (1966 and later)

*4L80E and 4L85E equipped with a PRNDL switch will need the optional accessory kit #75498. TH700R4, 200-4R, 4L80E, and 4L85E require a 4-speed gate plate #80712. AOD requires #40496 installation kit. Ford AODE & 4R70W require installation kit #40504. Ford E40D & 4R100 requires installation kit #40505.

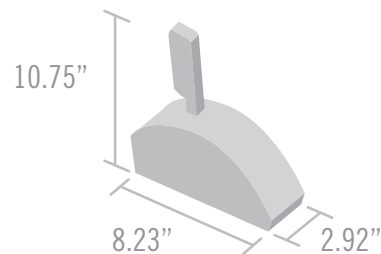

PRO RATCHET

This is the ultimate professional race shifter. If you're looking for a stout, easy to operate shifter; designed, developed and refined by the company that invented race shifters, the Pro Ratchet is the top of the hill. Its no-nonsense style and myriad of features speaks volumes to its functionality. This shifter is the leading choice for 3 & 4-speed transmissions as well as Powerglides!

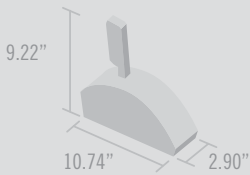

#80840/80842 PRO RATCHET

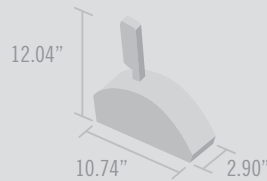

#81120 MAGNUM GRIP STEALTH PRO RATCHET

#80840/80842 PRO RATCHET

- Easiest shift unit to "double-shift" with an air, CO2, or electric shift solenoid
- One-hand/one-step reverse lockout operation that meets NHRA/IHRA requirements
- Precision ratchet action works with either standard or reverse pattern valve bodies
- Includes internal backup light switch, internal neutral safety switch, gear position indicator, forward pattern gear indicator, reverse pattern gear indicator, white knob, and 5' super duty race cable

#80840

Fits 1962 to 1973 GM Powerglide automatic race transmissions

#80842

TRANSMISSION MAKE	TRANSMISSION MODEL
GM	TH400, 350, 250, 200, 700R4, 200-4R, 4L60E*, and 4L65E*
Ford	C4,C6, AOD*, AODE*, 4R70W*, E40D*, and 4R100*
Chrysler	A727 and A904 (1966 and later)

*4L60E and 4L65E equipped with a PRNDL switch will need optional accessory kit #75498. AOD requires #40496 installation kit. Ford AODE & 4R70W require #40504 installation kit. Ford E40D & 4R200 require #40505 installation kit.



#81120 MAGNUM GRIP STEALTH PRO RATCHET

TRANSMISSION MAKE	TRANSMISSION MODEL
GM	TH400, 350, 250, 200, 700R4, 200-4R, 4L60E*, and 4L65E*
Ford	C4,C6, AOD*, AODE*, 4R70W*, E40D*, and 4R100*
Chrysler	A727 and A904 (1966 and later)

*4L60E and 4L65E equipped with a PRNDL switch you will need installation kit #75498. AOD requires 40496 installation kit. Ford AODE & 4R70W require #40504 installation kit. Ford E40D & 4R200 require #40505 installation kit.

STREET BANDIT

The ultimate shifter for automatic transmission equipped street vehicles! Whether you're building a street rod or a high-tech street machine, the Street Bandit is the pro's choice. The Street bandit has all the same features as the "Pro Bandit" line of shifters including race-proven durability and smooth positive gate shifting. Perfect for custom or high-tech interior design, the narrow lightweight styling will fit right into any interior!

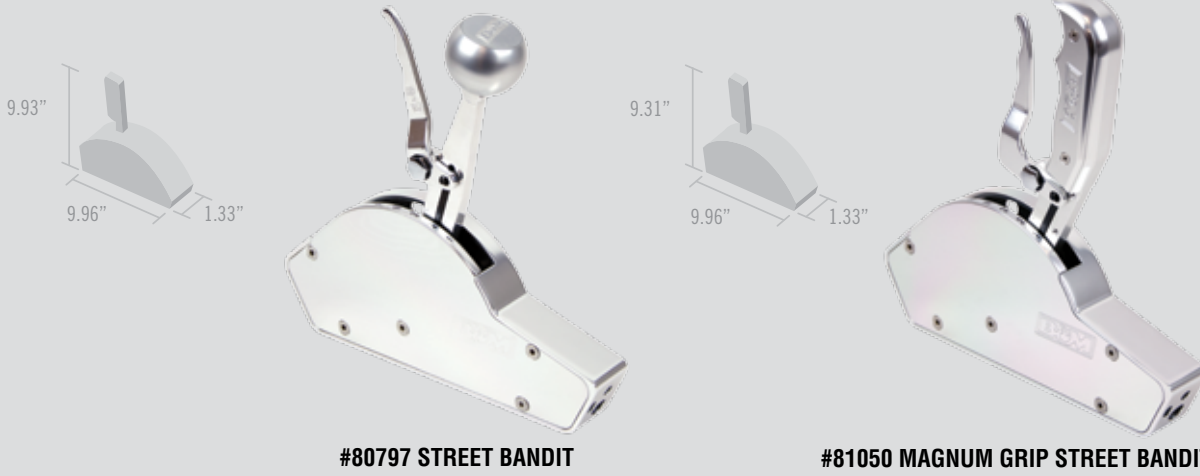

#80797 STREET BANDIT

#81050 MAGNUM GRIP STREET BANDIT

#80797 STREET BANDIT

- Solid positive gate shifting
- Billet 6061-T6 aluminum stick, knob, knob insert, & housing that are polished & anodized
- Includes internal backup light switch, internal neutral safety switch, and a 4' rear exit cable
- Interchangeable gate plate system easily allows the install of various B&M gate plates for most popular 2, 3, and 4-speed automatic transmissions including reverse patterns (sold separately)



TRANSMISSION MAKE	TRANSMISSION MODEL
GM	TH400, 350, 250, 200, 700R4, 200-4R (4L60E and 4L65E w/o PRNDL switch)
Ford	C4,C6
Chrysler	A727 and A904 (1966 and later)

#81050 MAGNUM GRIP STREET BANDIT

TRANSMISSION MAKE	TRANSMISSION MODEL
GM	TH400, 350, 250, 200 (4L60E and 4L65E w/o PRNDL switch)
Ford	C4,C6
Chrysler	A727 and A904 (1966 and later)

STARTERS

TRANSMISSIONS

FLEXPLATES

TORQUE CONVERTERS

AUTOMATIC SHIFTERS

MANUAL SHIFTERS

COOLING PRODUCTS

ACCESSORIES

PRO BANDIT RACE

Milled from a 7-pound block of billet 6061-T6 aluminum, the award-winning Pro Bandit shifter features an easy to operate gate type mechanism. Designed by B&M's factory race team drivers and engineers this masterpiece of shifting perfection is made for rear engine dragsters and includes an 8' super duty race cable, B&M P/G pro lever, Quick Disconnect, and cable extension (CO2 or electric solenoid may be used on this shifter for a P/G transmission).

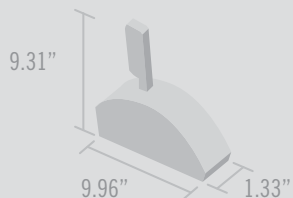

#80793 PRO BANDIT RACE



#81112 STEALTH PRO BANDIT RACE

#80793/81112 PRO BANDIT RACE

- Heat-treated/hardened gate plate & internal working components
- Ultra-slim footprint to fit in tight spaces
- Meets NHRA & IHRA reverse lockout requirements
- Includes 8' super duty rear exit race cable, B&M P/G pro lever, Quick Disconnect and cable extension
- Mounting location for CO2 cylinder ram (B&M #80883)

#80793 PRO BANDIT RACE

Billet 6061-T6 aluminum stick & housing that are polished & anodized

TRANSMISSION MAKE	TRANSMISSION MODEL
GM	1962-1973 Powerglide automatic

#81112 PRO BANDIT RACE

Same as Pro Bandit Race with added black finish.

TRANSMISSION MAKE	TRANSMISSION MODEL
GM	1962-1973 Powerglide automatic



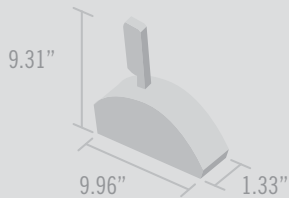
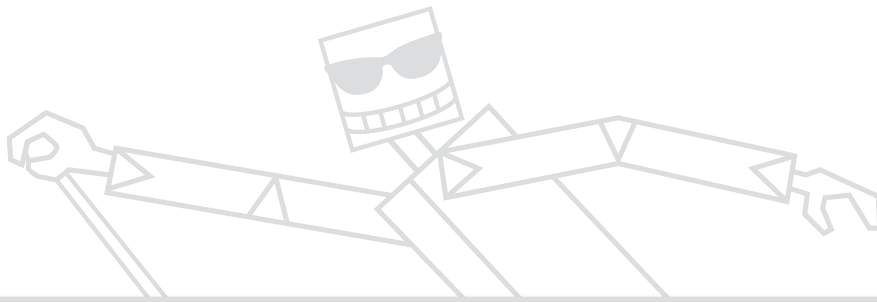

#80793 MAGNUM GRIP PRO BANDIT RACE

#81113 MAGNUM GRIP STEALTH PRO BANDIT RACE

#81045/ 81113 MAGNUM GRIP PRO BANDIT RACE

- Heat-treated/hardened gate plate & internal working components
- Ultra-slim footprint to fit in tight spaces
- Meets NHRA & IHRA reverse lockout requirements
- Includes 8' super duty rear exit race cable, B&M P/G pro lever, Quick Disconnect, and cable extension
- Mounting location for CO2 cylinder ram (B&M #80883)

#81045 MAGNUM GRIP PRO BANDIT RACE

Billet 6061-T6 aluminum Magnum Grip stick & housing that are polished & anodized

TRANSMISSION MAKE	TRANSMISSION MODEL
GM	1962-1973 Powerglide automatic

#81113 MAGNUM GRIP STEALTH PRO BANDIT RACE

"Stealth" black military specification anodized finish

TRANSMISSION MAKE	TRANSMISSION MODEL
GM	1962-1973 Powerglide automatic



STARTERS

TRANSMISSIONS

FLEXPLATES

TORQUE CONVERTERS

AUTOMATIC SHIFTERS

MANUAL SHIFTERS

COOLING PRODUCTS

ACCESSORIES

MANUAL TRANSMISSION PRECISION SPORTSHIFTERS



SHORTER THROW, BETTER FEEL

B&M manual shifters follow a strict yet simple philosophy in design. B&M uses the very best materials in the most effective mechanisms to provide simple, yet elegant shifting solutions. Stainless Steel, anodized aluminum, and ultra-high strength materials are used in the design when and where necessary. Each vehicle is evaluated individually with performance as the goal and the shifter is designed for optimum shift throw and balance with seating position, clutch travel, and effort to make a shifter that enhances your driving experience.

#45114 AUDI & VOLKSWAGEN MODELS



The B&M Precision SportShifter feels solid in the palm of your hand, one of the many reasons why it is a great choice for the Audi A3, VW New Beetle, Golf, GTi, and Jetta. This shifter comes completely assembled with pivot bearing and a Stainless Steel stick for precision control, solid engagement, and long-term durability. This product does not require any cable adjustments! Use that time saved and spend it cruising around town with your new B&M Precision SportShifter!

- Engineered for precision shifts
- 25% shift throw reduction
- Anodized billet aluminum pivot ball
- 303 Stainless stick
- Billet aluminum lock out collar
- CNC-machined Delrin® knob with aluminum engraved insert
- Direct bolt on installation

*Fits 2000-2004 Audi A3, 2000-2005 Volkswagen Beetle, Cabrio & Golf, 2004-2005 Volkswagen 3.2L R32 6 speed, 2000-2005 Volkswagen Jetta/Bora, 1999-2004 Seat Ibiza/Cupra, 1998-2004 Skoda Octavia

#45126 BMW 3 SERIES & 5 SERIES



We've taken the existing B&M design and simplified it further for your BMW. Although the installation is easier, the durability you've come to expect from B&M has been retained. Shift throw has been moderately reduced and tolerances have been tightened up to offer a superbly functioning shifter.

- Engineered for precision shifts
- Dampened pivot cup with self lubricating spherical pivot ball
- 20-25% shift throw reduction
- Counter balanced to reduce effort
- 2 piece 416 Stainless Steel & aluminum stick
- Isolated two piece stick minimizes audible vibration
- German made polymer T-500 lower pivot bushings

*Fits 1984-2006 BMW 3 Series, E30, E36 & E46, 1987-2006 M3, 1996-2002 5 Series, E39 & M5 models



#45052 1993-2002 CAMARO & FIREBIRD

FITS 1993-2002 CAMARO & PONTIAC FIREBIRD W/ V8 & 6 SPEED T56 TRANSMISSIONS

B&M Precision SportShifters substantially shorten the shifter throw in your late model Camaro. Machined from 303 Stainless Steel and 6061-T6 aluminum, these shifters are made for precision shifts. They are made to last, too!

- Engineered for precision shifts
- 30% shift throw reduction
- Spherical glass filled composite main pivot bearing
- 303S Stainless stick
- 6061-T6 Billet aluminum base
- Adjustable neutral stick position



#45034 2008-2013 CORVETTE C6 & Z06

FITS 08-14 CHEVROLET CORVETTES: C6 & Z06 MODELS - DOES NOT FIT GRAND SPORT MODEL

The B&M Precision SportsShifter for C6 Corvette's, feature precision engineered throw reduction combined with ultra-durable components resulting in positive, highly responsive shifts that will have you asking yourself, "why didn't I upgrade my Corvette shifter sooner?" With the countless hours spent in designing and testing, you can be sure these shifters will match your high demand for quality and the shifting performance your Corvette deserves!

- Engineered for precision shifts
- 33% shift throw reduction
- Accepts factory knob
- Stainless Steel lower stick
- No modifications to factory trim needed



#45044 1997-2007 CORVETTE C5, C6 & Z06

FITS 1997-2007 CHEVROLET CORVETTES INCLUDING C5, C6 AND Z06 MODELS

The Corvette is considered to be the longest running, continually produced sports car in the world. You deserve perfect shifts... and your Corvette deserves a B&M Precision SportShifter! This shifter features precision engineered throw reduction combined with ultra durable components. The B&M Precision SportShifter provides positive, highly responsive shifts that will have you wondering why this upgrade wasn't performed sooner. With the countless hours spent in designing and testing, you can be sure these shifters will match the high performance of your Corvette!

- Engineered for precision shifts
- 33% shift throw reduction
- Accepts factory knob
- Fully isolated upper stick
- Stainless Steel lower stick
- No modifications to factory trim needed



**COMING
NOVEMBER
2016**

#45195 JEEP JK SHIFTER

FITS '07-'16 JEEP JK WRANGLER

#45048 JEEP WRANGLER

FITS '99-'04 JEEP WRANGLER

The “original SUV” needs some love too. B&M puts the “sport” back in the SUV with this rendition of the Precision SportShifter for the TJ platform built between '99 to '04. Professional, durable, and dependable. Just like the Wrangler.

- Engineered for Precision Shifts
- Shift throw reduced for quicker shifts
- 303 Stainless steel stick
- CNC Machined aluminum base
- Spherical glass filled nylon pivot ball
- Direct bolt on installation
- Fits NV3550 transmissions



#45059 JEEP WRANGLER

FIT '90-'98 JEEP WRANGLER

The “original SUV” needs some love too. B&M puts the “sport” back in the SUV with this rendition of the Precision SportShifter for the TJ platform built between '90 to '98. Professional, durable, and dependable. Just like the Wrangler.

- Engineered for Precision Shifts
- Shift throw reduced for quicker shifts
- 303 Stainless steel stick
- CNC Machined aluminum base
- Spherical glass filled nylon pivot ball
- Direct bolt on installation
- Fits AXI5 transmissions





#45070 PRO RIPPER™

'83-'04 FORD MUSTANG

In the late 1980's, Ford had plans to change the Mustang platform from RWD to FWD. The Pro Ripper Shifter for the Mustang would not be what it is today if that plan was to materialize. The Pro Ripper shifter for the Mustang is our top-of-the-line shifter providing smooth, precise shifts along with shorter throws. The 3 piece top stick can be mounted on either side, forward or backwards, up or down, for virtually unlimited adjustability. This allows the stick to be set in the most comfortable ergonomic position for the individual driver. Quick, comfortable, and smooth shifting is the result when you combine superior materials with superb engineering design.

- Engineered for precision shifts
- 35% shift throw reduction
- Spherical glass filled composite main pivot bearing
- CNC-machined Stainless Steel stick assembly
- Fully adjustable stick design
- Stainless Steel collar
- Transmission fill plug in base
- Adjustable centering spring preload

*Fits 1983 to 2004 Ford Mustang with T5 with overdrive or T45 transmission



#45047 CIVIC, CRX, DEL SOL & INTEGRA

This Precision SportShifter retains the factory style main bearing pivot and stick bends, but uses B&M's original weighted design for balanced short-throw shifting.

- Engineered for precision shifts
- 28-30% shift throw reduction
- 303 Stainless Steel stick
- Stick has factory bend
- Accepts factory knob
- Direct bolt on installation
- Weighted and balanced design

#45075 CIVIC, CRX, DEL SOL & INTEGRA

Original B&M straight Stainless Steel stick design.

Fit 1990-2001 Acura Integra, 1988-2000 Honda Civic, 1988-1992 Honda CRX, 1993-1997 Honda Del Sol



#45163 350/370Z & G35 & G37

When Nissan unveiled their new interpretation of the "Z" brand, B&M was one of the first to offer an improved Precision SportShifter for the 350Z, 370Z, and Infiniti's G35 and G37. A perfect companion for a legendary nameplate, the B&M shifter tightens up the factory tolerances and provides a sportier feel to the action between gates. This is a must have for any Nissan 350/370Z or Infiniti G35/37 enthusiast with a 6-speed manual transmission!

- Engineered for precision shifts
- 33% shift throw reduction
- Spherical pivot bearing
- Fully isolated design
- 303 Stainless Steel lower stick
- CNC-machined aluminum and Delrin® base
- Accepts factory knob

*Fits 2003-2009 Nissan 350Z / 370Z & 2003-2009 Infiniti G35 / G37



#45088 NISSAN 180SX & 200SX

The Nissan 180, 200, 240sx, and Skyline are widely popular in the world of drifting. Vehicles like these should have a shifter with all of the features a performance minded driver requires. It has many of the key features found in race shifters including a Stainless Steel stick assembly, internal centering springs, a CNC machined aluminum base, and a spherical glass filled composite main pivot bearing.

- Engineered for precision shifts
- 40% shift throw reduction
- Spherical glass filled composite main pivot bearing
- 303 Stainless Steel stick
- CNC machined aluminum base
- Accepts factory knob

*Fits 1988-1999 Nissan 180SX & 200SX JDM Models // 1988-1999 Nissan 240SX w/ SR20/RB20 naturally aspirated 1991-1994 Nissan Pulsar GTiR // Nissan Skyline models w/ RB20 naturally aspirated



#45043 2004-2006 PONTIAC GTO

This Precision SportShifter has all of the features a performance minded driver requires for his or her Pontiac GTO (Gran Turismo Omologato). It has many of the key features found in race shifters including a Stainless Steel stick assembly, a CNC-machined aluminum base, and a glassfilled nylon pivot ball. It even has an adjustable upper stick, allowing for different mounting options to center the stick for the most comfortable position. Countless hours on CAD (Computer-Aided Design), coupled with a short throw in mind, has resulted in an extraordinarily precise shifting system.

- Engineered for precision shifts
- 37% shift throw reduction
- Spherical glass filled composite main pivot bearing
- 303S Stainless Steel stick
- CNC-machined aluminum base
- Direct bolt on installation

*Fits all 2004 to 2006 Pontiac GTO models



#45135 PORSCHE BOXSTER, CAYMAN & 911

Did you know that B&M was a supplier to Porsche AG worldwide, and that this exact shifter was used on the factory team GT3 cup cars? You can now take advantage of that very same shifter technology for your Porsche. This B&M Precision SportShifter is engineered to Porsche's strict specifications, developed specifically for the mighty 911s, Boxsters, and Caymans!

- Engineered for precision shifts
- 25-33% shift throw reduction
- Precision needle main bearing
- 416 Heat treated billet Stainless Steel stick
- 7075-T6 Billet aluminum pivot carrier
- Counter-balanced to reduce shift effort
- Adjustable neutral stick position
- Bolt on installation

*Fits 2005-2011 Porsche 911, Boxster/Boxster S (997/987), 1998-2004 Porsche 911 (996) 1996-2004 Porsche Boxster/Boxster S (986), 2005-2012 Porsche Cayman/Cayman S (987110/987120)



HI-TEK COOLING PRODUCTS

RUN COOLER, LAST LONGER

B&M COOLING SYSTEMS FOR AUTOMATIC TRANSMISSIONS

Power generates heat. This fundamental truth is important to keep in mind when increasing the capabilities of your vehicle. Proper oil temperature is the key to both reliability and performance in several key automotive systems, whether it's the engine, transmission, differential, or even power steering.

With a B&M cooler properly set up in your vehicle, you have 60 years of automotive engineering and knowledge looking after whatever component it's attached to. These coolers will serve as protection against failure, whether you're simply traveling to your next destination or racing to the finish line. Here are some of the highlights of B&M coolers:

LIGHTWEIGHT, ALL ALUMINUM CONSTRUCTION

Being an excellent conductor, aluminum naturally fills the role of a heat exchanger extremely well. Through the exclusive use of aluminum in all B&M cooler products, the size of the cooling systems can be kept at a minimum, thus reducing weight while retaining high strength and durability.

STACKED PLATE DESIGN

Most B&M cooling systems are of the compact and highly durable stacked plate design. A stacked plate design offers an extremely rigid structure to prevent vibration induced cracks in even the most demanding racing applications. The internal geometry of the plates has been arranged to maximize cooling surface area while offering minimum resistance to fluid flow – a true recipe for ultimate efficiency. The inherent resilience of these coolers makes them ideal for external installations where the cooler may be exposed to the elements, such as dirt, rocks, or debris that could strike the cooler at speed. The compact nature of the design also allows for installation in small and less accessible areas of the vehicle.

FIN AND PLATE DESIGN

Fin and plate cooler design draws from the durability of the stacked plate cooler and combines it with the heat exchanging efficiency of a fin and tube design. This combination yields the ultimate in cooling efficiency and reliability. Fin and plate coolers can typically offer a 25%-30% improvement in cooling capacity over similarly sized fin and tube coolers, and are incredibly tough. B&M's "Hi-Tek" line of coolers offers this technology.

PRESSURE TESTED FOR REAL-WORLD APPLICATIONS

All B&M cooling systems are pressure tested up to 200 PSI to ensure high quality for real world applications. The ability of the entire line up of B&M's coolers to withstand these rigorous tests comes from their oven-brazed construction. A SuperCooler does not leave the factory unless it meets some of the highest standards in the industry.

MOUNTING BRACKETS BUILT RIGHT INTO THE COOLER

B&M SuperCoolers have mounting brackets built in to the external structure of the assembly, allowing for ease of installation and versatile mounting options. While other coolers may require you to build a convoluted bracket to fit, the built in mounting points of B&M's coolers integrate the strength of the entire assembly into the mounts, saving you time and making easy work of installation.

These are just some of the benefits of B&M's line up of coolers; please see each individual system for more features and technical data.

B&M SUPERCooler

AUTOMATIC TRANSMISSION COOLERS

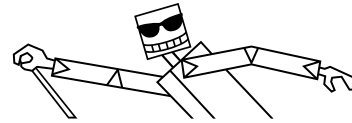

- Stacked plate design
- Low pressure drop
- All aluminum construction
- Oven brazed assembly
- Efficient and effective design
- Includes install kit
- 3/8" xtended barb fittings provide improved hose and clamp contact

Your transmission's greatest ally! A B&M SuperCooler is built using all aluminum components and is furnace brazed; these stamped plate coolers are some of the most effective heat exchanging devices available. Don't worry if your application is particularly harsh, these sturdy coolers will efficiently cool your transmission while putting up with all sorts of things thrown at them. This is the beauty of the stacked plate design—these coolers are strong enough to do their job in harm's way.

An additional feature of the SuperCooler is the "Low Pressure Drop" design of the core of the cooler. When cold automatic transmission fluid encounters the cooler, an amount bypasses the stacked plate core because of the fluids higher viscosity, allowing it to directly return to the transmission. This is beneficial in that the transmission is allowed to reach operating temperature more quickly, especially in cold climate areas. As the fluid warms up it acts as its own thermostat, the lowering of viscosity allows more fluid to be passed through the core, thus regulating the temperature. B&M's line up of SuperCoolers are truly a unified front in the battle of optimum transmission temperature!

DIMENSIONS	BTU RATING	PART NUMBER
11"x5-3/4"x3/4"	9800 BTU	70255
11"x7-1/4"x3/4"	13,000 BTU	70268
11"x5-3/4"x1-1/2"	14,400 BTU	70264



B&M SUPERCOOLER

AUTOMATIC RACE & UNIVERSAL COOLERS



- ATF, engine oil, differential oil, or even power steering fluid compatible
- Stacked plate design
- Larger capacity than standard SuperCoolers, making them ideal for racing and heavy duty applications
- Oven brazed, all aluminum construction
- Pressure tested to 200 PSI
- 1/2" NPT fittings – easily adapted to any fittings

If you have a system or component that needs cooling, B&M's Universal and Race SuperCoolers can handle it! Like our transmission coolers, B&M's Universal and Race SuperCoolers are all aluminum and furnace brazed, featuring a stacked plate design. With larger capacities available and built-in 1/2" NPT fittings, these heat exchangers are up to the task of virtually any application. With strong, durable, and lightweight cores, these coolers have seen duty in a myriad of applications: RV's and tow vehicles, circle track racing, road racing, off-road, even monster trucks and rock crawling! These teams and individuals know when you need an efficient cooler you can place anywhere, B&M is the place to start.

Perhaps you need all this performance, but in a more attractive package? In addition to the three sizes of the standard black SuperCoolers, B&M also offers two sizes of Polished SuperCoolers, with all the same great features that have made our heat exchangers so popular.

STANDARD BLACK		
DIMENSIONS	BTU RATING	PART NUMBER
11"x5-3/4"x1-1/2"	15,000 BTU	70273
11"x8"x1-1/2"	20,500 BTU	70266
11"x11"x1-1/2"	29,200 BTU	70274

SILVER		
DIMENSIONS	BTU RATING	PART NUMBER
11"x 2-3/4"x1-1/2"	7,500 BTU	70265
11"x 8-1/2"x1-1/2"	20,500 BTU	70272



STARTERS

TRANSMISSIONS

FLEXPLATES

TORQUE CONVERTERS

AUTOMATIC SHIFTERS

MANUAL SHIFTERS

COOLING PRODUCTS

ACCESSORIES

B&M SUPERCOOLERS ENGINE OIL & AUTOMATIC TRANSMISSION COOLERS



Replacement Temp Sensor
part #70200

The newest of the B&M high performance heat exchangers, the cooling system is the top of the line. With the addition of a high output, automatically actuated electric fan, these coolers can be placed in tighter spaces where less natural air flow is available. The fin and plate cores on these coolers are the strongest and most efficient of B&M's line up. With the thermal switch keeping an eye on your fluid temperature and kicking the fan on whenever it reaches 175° F or higher, you can focus on the most important task – driving with confidence.

These coolers are suitable for automatic transmission fluid, engine oil, differential fluid, and power steering fluid. Like B&M's Race and Universal SuperCoolers, Hi-Tek coolers have seen duty in RV's and tow vehicles, circle track racing, road racing, off-road, even monster trucks and rock crawling. High capacity cooling in a compact package that's a snap to mount in confined spaces: This is B&M's cooler.

- Ideal for the toughest cooling applications
- Fin and plate construction
- Includes 12 volt, high output fan
- Included thermal switch activates fan at 175 degree F
- Pressure tested to 200 PSI
- 1/2" NPT fittings – easily adapted to an fittings

STANDARD BLACK					
DIMENSIONS	FAN DIA.	FAN CFM	FAN AMPS	WEIGHT	PART NUMBER
13-1/2" x 9" x 3-1/2"	9-1/2" dia.	500 CFM	6 amps	7lbs	70297
10" x 7-1/2" x 4"	7" dia.	350 CFM	6 amps	5 lbs	70298

B&M SUPERCOOLER ENGINE OIL COOLER KIT



#70270 ENGINE OIL COOLER KIT

The same proven design as the B&M Transmission SuperCooler, but packaged with all components required for keeping your GM V8's oil at the proper temperature. Without an oil cooler, high loads and high engine speeds can raise the oil's temperature to the point of break down, causing significant engine damage. Protect your engine's vitals with this easy to install kit! Includes mounting hardware, filter adapter, hoses, fittings, and easy to follow instructions.

- Kit can be used on all GM V8 engines with recessed oil filters
- Excellent for towing, heavy duty applications, and hot conditions
- Efficient stacked plate design
- Pressure tested to 200 PSI
- 1/2" NPT fittings – easily adapted to an fittings

SUPERCooler

APPLICATION GUIDE

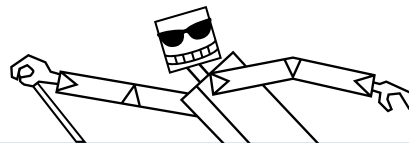

AUTOMATIC TRANSMISSION FLUID COOLING		
TORQUE CONVERTER STALL RANGE	PUSH-ON FITTINGS	FOR USE WITH BRAIDED LINE & AN FITTINGS
Stock stall converter	70255	
2000 stall converter	70268	
2400 stall converter	70268	70273
3000 stall converter	70264	70266
3500+ stall converter		70266 or 70274
STREET RODS		
Small Blocks naturally aspirated cruisers		70265*
Blown Small Blocks & Big Blocks		70272* or 70298
STREET MACHINES & MUSCLE CARS		
SMALL BLOCK—LESS THAN 3200 LBS		
2000 stall converter		70255 or 70268
2400 stall converter		70268 or 70273
3000 stall converter		70264 or 70266
3500+ stall converter		70266 or 70274
SMALL BLOCK—GREATER THAN 3200 LBS		
2000 stall converter		70268
2400 stall converter		70264 or 70273
3000 stall converter		70264 or 70266
3500+ stall converter		70266 or 70274
BIG BLOCK—LESS THAN 3200 LBS		
2000 stall converter		70268
2400 stall converter		70264 or 70273
3000 stall converter		70264 or 70266
3500+ stall converter		70266 or 70274
BIG BLOCK—GREATER THAN 3200 LBS		
2000 stall converter		70264
2400 stall converter		70264 or 70273
3000 stall converter		70266 or 70274
3500+ stall converter		70274 or 70298
DRAG RACING		
Dragster—Bracket Racing & Super Class Racing		70266 or 70272*
Door Car—Bracket Racing & Super Class Racing		70266 or 70272*
Blown or Nitrous Injected		70266, 70274 or 70297
ROAD RACING (DETERMINED BY MOUNTING LOCATION)		
Engine Oil Cooler		70266, 70274 or 70297
Differential Cooler		70266, 70274 or 70297
Manual Gearbox		70273 or 70266
Automatic Transmission		70266 or 70298
CIRCLE TRACK (DETERMINED BY MOUNTING LOCATION)		
Engine Oil Cooler		70266, 70274 or 70297
Differential Cooler		70266, 70274 or 70297
Manual Gearbox		70273 or 70266
Automatic Transmission		70266 or 70298
OFF-ROAD VEHICLES		
4WD Automatic Transmission		70264 or 70266
Rock Crawling & Trail Riding—Automatic Transmission		70297
Rock Crawling & Trail Riding—Power Steering		70273 or 70298
Desert Racing—Automatic Transmission		70266 or 70297
Short Course Racing—Automatic Transmission		70274 or 70297
TOWING		
Pickup with small trailer or boat (10,000 GVW total)		70268
Pickup with trailer or boat (14,000 GVW total)		70264
Pickup or 5th Wheel with trailer & motorhomes (18,000 GVW total)		70266
Pickup or 5th Wheel with trailer & motorhomes (Over 18,000 GVW total)		70297

* Polished cooler.

STARTERS

TRANSMISSIONS

FLEXPLATES

TORQUE CONVERTERS

AUTOMATIC SHIFTERS

MANUAL SHIFTERS

COOLING PRODUCTS

ACCESSORIES

HI-TEK AUTOMATIC TRANSMISSION PANS



CAST ALUMINUM DEEP TRANSMISSION PANS

Excessive heat can kill a transmission quickly. One of the best and easiest ways to help dissipate that excess heat from a transmission is by installing a B&M cast aluminum deep pan. The extra fluid capacity, multiple cooling fins, and greater heat transfer of aluminum all combine to make the B&M cast aluminum transmission pan a functional solution to keep your transmission running cool. Whether you're racing, towing, off-roading, or just an enthusiastic driver in warmer weather – keeping your transmission cool is essential to its continued operation and longevity. In addition, this easy to install pan includes a drain plug to make fluid changes simple and less messy and all necessary hardware.

- Multiple cooling fins for greater heat dissipation
- Thick durable cast aluminum construction
- CNC machined mounting surface, bolts holes, and ports
- No modifications to dipstick required
- Easy installation with easy-to-follow instructions
- Lifetime Limited Warranty
- Includes drain plug, temperature sensor ports, and all necessary mounting hardware



CHROME PLATED STEEL DEEP PANS

B&M's chrome plated steel deep pans help protect your transmission and look great doing so. Added transmission fluid capacity equates to greater capacity to dissipate damaging heat from the transmission. The added drain plug makes subsequent transmission fluid changes a breeze and it's all wrapped up in a durable and attractive chrome plated finish.

- Durable steel construction and chrome plated finish
- No modifications to dipstick required
- Includes drain plug and all necessary mounting hardware
- Easy installation with easy-to-follow instructions
- Lifetime Limited Warranty
- Most use OE Filter. *Use B&M filter replacement part #10288



APPLICATION	CAPACITY GAINS	DESCRIPTION	PART NUMBER
TF727/ 518&618/48RE Cummins	4 quarts	Cast Deep - Aluminum	10280
TH400	2 quarts	Cast Deep - Aluminum	20280
TH400	2 quarts	Chrome - Steel	20289
*TH350	3 quarts	Cast Deep - Aluminum	30280
*TH350	3 quarts	Chrome - Steel	30289
4L60 and 4L60E	3 quarts	Cast Deep - Aluminum	70260
*Powerglide	2 quarts	Cast Deep - Aluminum	70280
700R4	3 quarts	Chrome - Steel	70289
4L80E	3 quarts	Cast Deep - Aluminum	70295
*C6	2 quarts	Cast Deep - Aluminum	40281
AOD/AODE/ and 4R70W	3 quarts	Cast Deep - Aluminum	40291
Ford, E4OD, 5R100, 4R100	3.5 quarts	Cast Deep - Aluminum	40295
*C4 Transmission	2 quarts	Cast Deep - Aluminum	50281
NAG-1	3 quarts	Cast Deep - Aluminum	10300
6L80E ¹ Car	1.8 quarts	Cast Deep - Aluminum	70391
COMING SOON! 6L80E Truck	-	Cast Deep - Aluminum	70392
COMING SOON! AB60 Transmission	-	Cast Deep - Aluminum	70393

1. Designed specifically for Camaro SS applications. May fit other vehicles. Check for proper clearance and fitment.

Note: Most use OE filter. *Use B&M Filter Replacement part #10288

CAST ALUMINUM DIFFERENTIAL COVERS

Don't let our diff cover's rugged good looks fool you. It was designed with several features you just won't find on factory equipped diff covers. Like being cast from T6 Aluminum for added strength and durability, large external fins for cooling and increased fluid capacity to also help dissipate heat. And we didn't stop there, we added load bolts to help support the bearing caps from deflection, incorporated a magnetic drain plug for servicing and milled the B&M logo in the cover for bragging rights. Now that's a differential cover you can be proud to say you own!

- Solid cast aluminum finned construction for strength & improved heat transfer
- Load bolts provide additional support to bearing caps
- Additional fluid capacity improves cooling
- Fill plug and magnetic drain plug ease servicing
- Includes Stainless Steel mounting hardware



APPLICATION	PART # ALUMINUM FINISH	PART # BLACK FINISH
DANA 30 10 BOLT (FRONT)	10310	11310
DANA 35 10 BOLT	10311	11311
DANA 44 10 BOLT	10312	11312
DANA 60-70 10 BOLT	10314	11314
DANA 80 10 BOLT	10315	11315
FORD 8.8 10 BOLT	40297	41297
FORD 9.75" 12 BOLT	40298	41298
GM 8.2" 10 BOLT B.O.P.	70503	--
GM 8.2"/8.5"/8.6 R.G.10 BOLT	70502	71502
GM 8.875" R.G. 12 BOLT (CAR)	70500	--
GM 8.875" R.G. 12 BOLT (TRUCK)	70504	71504
GM 10.5" 14 BOLT	70501	71501
GM 9.5" 14 BOLT	70505	71505
AAM 11.5" 14 BOLT		11317
AAM 10.5 14 Bolt		11316
FORD Sterling 10.25/10.5 12 BOLT		41299
CHRYSLER 9.25" 12 BOLT	10306	11306



NODULAR IRON DIFFERENTIAL COVERS

Introducing B&M Racing's new Nodular Iron Differential Covers, designed with the serious Off-Roader in mind. Features include, super strong nodular iron construction, compact profile for clearing suspension components, durable black powder coated finish, a magnetic dip stick to monitor gear oil level and a magnetic drain plug to help catch metal particles during abuse. Available for Dana 30 and Dana 44 differentials which come standard on all 2007-up Jeep Wranglers, and Rubicon's that have Dana 44's front and rear.

APPLICATION	PART #
DANA 33 10 BOLT	12310
DANA 44 10 BOLT	12312

ACCESSORIES & SERVICE PARTS



#80741 HAMMER T-HANDLE

Chrome plated Hammer Head T-handle w/SAE inserts (for most B&M shifters excluding manual shifters) includes SAE thread adapters. Fits 1/2-20, 3/8-24, 3/8-16, and 5/16-18 threads



#80534 QUICKSILVER BILLET SHIFTER KNOB

CNC machined billet aluminum knob includes engraved insert with B&M logo. Adapters included with the knob fit 1/2-20, 3/8-24, 3/8-16 & 5/16-18 SAE threads.



#46110 B&M SHIFTER KNOB

High impact plastic, stain resistant white knob. Ideal for most shifters. Knob includes a clear lens and B&M logo insert. Fits 1/2-20, 3/8-24, 3/8-16 and 5/16-18 threads. For most B&M shifters & others w/SAE threads.



#46112 UNIVERSAL SHIFTER KNOB WITH BUTTON

High impact white knob with central button may be used to activate transbrake, launch control, nitrous or two step ignition control. Includes B&M logo insert. Thread adapters fit 1/2-20, 3/8-24, 3/8-16 and 5/16-18 threads. Works w/ 12 or 16V system.



#80846 LENS AND INSERT

Lens insert for B&M shifter knob part numbers 46112



#80642 UNIVERSAL BLACK PLASTIC T-HANDLE

T-handle packages include thread inserts to fit 1/2-20, 3/8-24, 3/8-16, and 5/16-18 SAE thread shifters. All B&M automatic shifters have 1/2-20 threads. Fits most B&M shifters & most aftermarket (SAE) shifters.



#80643 T-HANDLE CHROME ALUMINUM

T-handle packages include thread inserts to fit 1/2-20, 3/8-24, 3/8-16, and 5/16-18 SAE thread shifters. All B&M automatic shifters have 1/2-20 threads.

* Fits most B&M shifters & most aftermarket (SAE) shifters.



#80658 UNIVERSAL T-HANDLE

This B&M universal button T-handle fits most B&M and aftermarket shifters. Kit includes thread inserts to fit 1/2 - 20, 3/8 - 24, 3/8 - 16 and 5/16 - 18 SAE threaded sticks and a 12 Volt momentary switch to activate line-lock, transbrake or nitrous.



80659 UNIVERSAL T-HANDLE WITH BUTTON

This Universal T-Handle shift knob from B&M fit most B&M and aftermarket (SAE) shifters. They're available in plastic or aluminum, with or without a button for activating line lock, transbrake, or nitrous systems.



MAGNUM GRIP BUTTON SIDE PLATES

Optional stealth magnum grip side plate with 12-volt momentary button. The button may be used to activate transbrake, nitrous, launch control or two step ignition. Easily installs onto any of the B&M Magnum Grip shifters. Wire is completely hidden in a machined channel on the shifter stick.

FINISH	PART NUMBER
Magnum Grip Actuator, Black	81063
Magnum Grip Actuator, Clear Anodized	81060



#80637 RATCHET PAWL SPRING

Service Part: Upper Pawl Spring for B&M QuickSilver, Console QuickSilver, and Console Hammer shifters.



#81026 BLACK TEXTURED SHIFTER COVER FOR CONSOLE QUICKSILVER

Black (Textured) Cover for 68-69 Camaro Console QuickSilver is designed as an alternative to the chrome cover that is included with the 68-69 Camaro Console QuickSilver. Simple to install, and a great choice for those who are going for that "Blacked Out" look. Comes complete with four (4) mounting screws, a boot, and two (2) indicator windows to accommodate both 3-speed and 4-speed applications.



#80883 CO2 RAM CYLINDER

B&M's CO2 Ram Cylinder is for use with B&M's full line of Pro Bandit race shifters. Comes with Stainless Steel plunger and rubber stop. Ram stroke is 1.5".



#81027 CHROME PLASTIC COVER FOR CONSOLE QUICKSILVER

Chrome Plastic Cover for 81025 is a service part for the 68-69 Camaro Console Quicksilver. Whether the Chrome-Plastic Cover is worn out, damaged, or missing... this cover is readily available as a replacement. Sold Individually. Does not come with any additional hardware or accessories.



#81037 CHROME PLASTIC COVER CONSOLE MEGASHIFTER

Chrome Plastic Cover for 81035 is a service part for the 68-69 Camaro Console MegaShifter. Whether the Chrome-Plastic Cover is worn out, damaged, or missing... this cover is readily available as a replacement. Sold Individually. Does not come with any additional hardware or accessories.



#80717 ALUMINUM PRO STICK COVER

Brushed aluminum replacement cover (same as supplied with the #80706 Pro Stick shifter) for the B&M Pro Stick shifters. Comes with embossed B&M logo and quick release mounting pins.



#81122 PRO RATCHET STEALTH (BLACK) ALUMINUM COVER

Pro Ratchet Stealth (black) Aluminum Cover is a service part for the Pro Ratchet line of B&M racing shifters. It is a lightweight aluminum cover that is black anodized for durability and helps keep debris out of the shifter. Whether the aluminum cover is worn out, damaged, or missing? this cover is readily available as a replacement. Includes mounting screws, indicator decals, and gear indicator pointer.



#81165 USB CHARGING PORT REPLACEMENT SKIRT

B&M introduces their updated replacement skirt for the MegaShifter and SportShifter that includes a dual USB charging port. This new skirt includes a dual 5V 3.1A port that is great for charging most cell phones and tablets, while eliminating the need to have cords running up to the dash of the vehicle. The skirt includes the charging plug, wire, fuse and necessary electrical connectors to complete the installation and is backed by a 1 year warranty.



SHIFTER CABLES

UNIMATIC SHIFTER CABLES: Two lengths available, 5-ft. cable is standard for most applications.

- Prelubed for smooth operation
- Properly clearanced to reduce backlash
- .25" outer diameter blue 'long lay' outer jacket

LENGTH	PART #
All Unimatic 5-ft Blue Jacket cable	80735
All Unimatic 6-ft Blue Jacket cable	*80740

**recommended for Chrysler applications*

SUPER DUTY RACE SHIFTER CABLES: B&M's superior grade of hardcore super duty race cables feature a .375" O.D. Red 'long-lay' outer jacket and have up to 50% less backlash than competitive cables. All B&M Race Cables are prelubed for smooth operation.

- Rotary swaged ends
- Less than .015" per foot backlash
- Supplied with Pro Ratchet, Pro Stick & Pro Bandit but can be used on all B&M shifters (except Unimatic)

LENGTH	PART #
3-ft. cable (eyelet/thread)	80831
4-ft. cable (eyelet/thread)	80832
5-ft. cable (eyelet/thread)	80833
8-ft. cable (eyelet/thread)	80834
10-ft. cable (eyelet/thread)	80835
12-ft. cable (eyelet/thread)	80836

Performance Shifter Cables: B&M offers several lengths depending on application. The popular 5-ft. length comes packaged with most B&M shifters.

- Proper clearance to reduce backlash
- 0.250" outer diameter 'long lay' outer jacket
- These cables are supplied with most B&M shifters (except race shifters)

CABLES FOR B&M SHIFTERS BUILT BEFORE 1981: (WITH THREADS ON BOTH ENDS)

LENGTH	PART #
6-ft. cable	80506

CABLES FOR B&M SHIFTERS BUILT FROM 1981 TO PRESENT: (WITH EYELET ON ONE END AND THREADS ON THE OTHER)

LENGTH	PART #
4-ft. cable	80604
5-ft. cable	80605

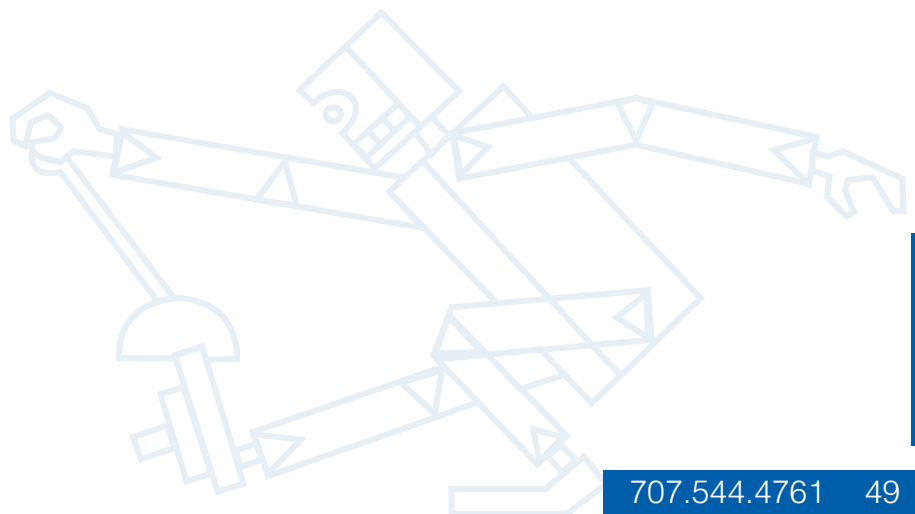

STARTERS

TRANSMISSIONS

FLEXPLATES

TORQUE CONVERTERS

AUTOMATIC SHIFTERS

MANUAL SHIFTERS

COOLING PRODUCTS

ACCESSORIES

**SHIFTER ACCESSORIES &
SERVICE PARTS**

B&M AUTOMATIC SHIFTER ACCESSORIES	PART #	DESCRIPTION
Brushed aluminum cover, Pro Stick	80717	Supplied with 80706 shifter (includes quick release pins)
Bracket & Lever Kit	35498	For GM TH400, 350, 250, 200, 200-4R & 700R4
Bracket & Lever Kit	70497	For GM '62-'73 Powerglide w/o T.V. Hole
Bracket & Lever Kit	75498	For GM 4L60E, 4L65E, 4L80E, 4L85E with PRNDL switch
Bracket & Lever Kit	40496	For Ford AOD transmissions
Bracket & Lever Kit	40497	For Ford C6 transmissions
Bracket & Lever Kit	50498	For Ford C4 transmissions
Bracket & Lever Kit	10497	For Chrysler '66 & later 727 or 904 Torqueflite & AMC '72 & later Torque Command trans
Bracket & Lever Kit	40504	For Ford AODE or 4R70W transmissions
Bracket & Lever Kit	40505	For Ford E40D or 4R100 transmissions
Cable Bracket, GM	30499	For TH400, 350, 250, 200, 700R4, 200-4R transmissions
Cable Bracket, Powerglide	70460	For Powerglide transmissions
Cable Bracket, Powerglide (Bandit style shifters only)	70469	For Powerglide with Pro Bandit (Composite X & Magnum Grip) & rear entry cable
Cable Bracket, GM	70499	For GM 4L60E, 4L65E, 4L80E, 4L85E with PRNDL switch
Cable Bracket, Ford	40498	For C6 transmissions
Cable Bracket, Ford	50499	For C4 transmissions
Cable Bracket, Ford	40495	For AOD transmissions
Cable Bracket, Chrysler	10494	For TF727 or 904 transmissions (with rear entry cable shifters - all Bandit series)
Cable Bracket, Chrysler	10499	For TF727 or 904 transmissions
Cable Bracket, GM (Bandit style shifters only)	30498	For TH400, 350, 250, 200, 700R4, 200-4R with 80797, 80798 or 81050 shifter
Cable Bracket, Ford (Bandit style shifters only)	40489	For C6 with 80797, 80798 or 81050 shifter
Cable Bracket, Ford (Bandit style shifters only)	50488	For C4 with 80797, 80798 or 81050 shifter
Gate plate & lever, Pro Stick, Pro Bandit, Street Bandit	80713	2-speed forward & reverse pattern
Gate plate, Pro Stick, Pro Bandit, Street Bandit, Stealth	80710	3-Speed reverse pattern
Gate plate, Pro Stick, Pro Bandit, Street Bandit, Stealth	80711	3-Speed standard pattern (Included with 80701 & 80706 shifters)
Gate plate, Pro Stick, Pro Bandit, Street Bandit, Stealth	80712	4-speed forward pattern (TH700-R4 & 200-4R)
Mounting Bracket	80884	Floor mount bracket for all Bandit shifters (for door cars)
Neutral Safety Switch Kit, Pro Stick	80844	Mounting bracket and neutral safety switch for Pro Stick
Powerglide Pro Lever	70465	For all B&M 2-speed shifters
Quick Disconnect & Cable Extension	80323	For all Bandit shifters when used in rear engine dragsters
Ram Bumper	80881	For Pro Bandits and all Bandit shifters
Reverse lockout Extension, Pro Stick, Pro Ratchet	80726	With extension knob
Swivel & Pin	80638	For all B&M levers
Trans Lever	20462	For GM TH400, 350, 250, 200, 700R4, 200-4R, 4L60E, 4L65E, 4L80E transmissions
Trans Lever	40461	For Ford C6, C4 transmissions
Trans Lever	10462	For Chrysler TF727 or 904 transmissions



AUTOMATIC SHIFTER SERVICE PARTS	REPLACEMENT T-HANDLE OR KNOB	KNOB INSERT	SHIFTER STICK	TRIGGER	BOOT	CHROME OR TOP COVER	BLACK PLASTIC COVER SKIRT	INDICATOR WINDOW OR DECAL STANDARD PATTERN	INDICATOR WINDOW OR DECAL - REV. PATTERN	INDICATOR CABLE/ POINTER	NEUTRAL REVERSE MICRO SWITCH	INDICATOR LIGHT	BACK-UP LIGHT KIT	5' REPLACEMENT CABLE
80675 StarShifter	80641		80588	80837	80611	80616	80617	80849		80615	80629			80605
80683/80676 QuickSilver	80670	80669	80587		80673	80671	80617	80672	80618		80629	80729		80605
80680 Truck MegaShifter	80641		80589	80837	80668	80820	80727	80696	80697	80814	80629	80667		80605
80681 Z-Gate	80642			80837		80645	80646				80629		80580	80605
80688 Console QuickSilver	80670	80669	80586		80673	80644		80672	80618		80629			
80690 MegaShifter	80641		80589	80837	80668	80820	80665	80696	80697	80814	80629	80667		80605
80692 Console MegaShifter	80641		80695	80838	80668	80663		80696	80697	80815	80629	80667		80605
80694 Console MegaShifter	80641		80695	80838	80668	80664		80696	80697	80815	80629	80667		80605
80701/80702/80706 Pro Stick	46110		80811	80868				80847	80847		80609			80833
80775 Unimatic	80642				46102						80609			80735
80776 SportShifter	80642				80661	80820	80665	80816		80813	80609	80667		80605
80840/80842 Pro Ratchet	46110		80586			80821		80848	80848	80615	80629			80833
80885/81001, 2 & 3 Hammer	80741		80891	80892	80890	80893	80894	80895		80897	80629	80896		80605
80793 Pro Bandit				80839							80609			80833
80797 Hi-Tek Street Bandit	80534			80839							80628			80604
81040/81041 Magnum Grip				80868				80869	80869		80609			80833
81045/81046 Magnum Grip				80868				80869	80869		80609			80833*
81050 Magnum Grip				80868				80869	80869		80628			80604
81025 Console QuickSilver	80670	80669	80586		80673	81027		80672	80618		80629	80729		80605
81035 Console MegaShifter	80641		80695	80838	80668	81037		80696	80697	80815	80629	80667		80605
81052 Stealth Magnum				80888				80696	80869		80609			80833
81113 Stealth Pro Bandit				80888				80696	80869		80609			80833*

STARTERS

TRANSMISSIONS

FLEXPLATES

TORQUE CONVERTERS

AUTOMATIC SHIFTERS

MANUAL SHIFTERS

COOLING PRODUCTS

ACCESSORIES

TRANSMISSION ACCESSORIES



NEW
GALLON
SIZE



#80259/80260 B&M TRICK SHIFT ATF

With Trick Shift, you can literally pour in performance! It was originally developed by B&M and a major oil company back in the early 1960's for racing applications. No other company offered a fluid strictly for performance shifting. Trick Shift's blend of foam inhibitors, extreme pressure agents, and shift modifiers worked so well for racing applications that it found its way to street use. This specific blend extends transmission life and dramatically improves shift quality. If you want an inexpensive way to improve the transmission performance of your vehicle, go with Trick Shift!

- Ideal for racing, performance street, RV, and heavy duty applications
- Provides extended transmission life and firmer shifts
- Can be mixed with stock-type transmission fluids (recommended to utilize exclusively for maximum improvement)
- Not recommended for electronic controlled trans

#80259
32 oz. sold in quantities of 12

#80260
1 gal. sold in quantities of 6



#22164 LOCKING DIP STICK FOR POWERGLIDE OR DEDENBEAR

B&M has designed a locking short dip stick in conjunction with the newly redesigned transmission shield to attach directly to the servo cover. The screw-on cap is precision machined billet aluminum with a knurled finish and O-ring seal to prevent leaks. The dipstick plugs into the transmission with a sealing grommet (standard equipment on most new GM transmissions).



#80277 UNIVERSAL REMOTE TRANSMISSION FILTER KIT

Many transmission failures are caused by contamination. A remote transmission oil filter increases filtration efficiency 2 to 5 fold. Replacement filter is a Fram™ PH8A or equivalent.



#70237 GM TH700R4 KICKDOWN KIT

TH700R4 transmissions will downshift from fourth to third gear anytime there is more than about half throttle (except Corvette and some H.O. Camaros and Firebirds). As a result, it is impossible to cruise at high speeds in overdrive (fourth) gear. This kit prevents a forced part throttle kickdown from fourth to third gear, and allows cruising at higher speeds in overdrive. The transmission will only kick down from fourth to third gear at 3/4 throttle.



#20234 GM VACUUM MODULATOR

B&M's Vacuum Modulator is fully adjustable, this allows you to tailor your shift points to within a range of 2-4 mph. Comes supplied pre-adjusted for normal shift points. For GM TH350 & TH400. Note: If you have a big camshaft and your engine does not make adequate vacuum you will not be able to make the stock or B&M modulator work properly, usually resulting in late, hard shifts.



GM TV/KICKDOWN CABLES

These universal fit adjustable cables will work in 95% of all listed transmission applications, yet are less expensive than OE models. Use as straight replacement cable or ease the installation of transmission swaps.

TRANSMISSION	PART NUMBER
TH350 TV/Kickdown Cable	30287
GM 700R4 TV Cable	70242



#20297 GM TH400 KICKDOWN SWITCH

When swapping the TH400 transmission into any vehicle, this kit makes installation of the transmission's kickdown feature a snap. This switch mounts to either a TH700 or TH350 throttle cable bracket.



#64511 THROTTLE VALVE CABLE ADAPTER

Easily installed TV cable levers for Edelbrock carbs. These kits allow you to adapt the throttle valve cable onto these carbs in order to achieve proper travel.



B&M ALUMINUM BRAIDED DIPSTICK

The best way to check your transmission's oil is to use one of B&M's transmission fluid dipsticks. The O-ring sealed cap screws into the tube, while the base of the tube has a sealing grommet where it goes into the transmission.

TRANSMISSION	PART NUMBER
GM TH350	22165
GM TH400	22166
GM 700R4 (4L60)	22167



#22168 B&M 6L80E LOCKING AUTOMATIC TRANSMISSION DIPSTICK

The B&M 6L80E Locking Transmission Dipstick was designed to allow for a quick and easy check of the automatic transmission fluid level and fluid quality by the vehicle owner/operator without having to go to the dealership. Constructed of billet Stainless Steel fittings, steel braided hose and black mil-spec anodized aluminum 6061-T6 cap and bracket, this rugged unit allows for both cold and warm fluid level checks and is meant to be left in the vehicle and locked into place. Additional features include an engraved B&M logo locking knurled handle cap and fluid level stamped indicator end. Note: designed specifically to fit 2010-2014 Camaro SS. May fit other applications.

STARTERS

TRANSMISSIONS

FLEXPLATES

TORQUE CONVERTERS

AUTOMATIC SHIFTERS

MANUAL SHIFTERS

COOLING PRODUCTS

ACCESSORIES



#120003 4L80E INTERNAL WIRING HARNESS

Replacement internal wiring harness for 1993 and later GM 4L80E automatic transmissions. Can also be used to update 4L80E transmissions manufactured previous to 1993.

- Sold individually
- Replaces 4L80E automatic transmission wiring harnesses
- Weather resistant
- Made in the USA



B&M NAG-1 LOCKING TRANSMISSION DIPSTICK

The B&M NAG-1 Locking Transmission Dipstick was designed to allow for a quick and easy check of the automatic transmission fluid level and quality by the vehicle owner/operator without having to go to the dealership. Constructed of billet steel and black mil-spec anodized aluminum 6061-T6, this rugged unit allows for both cold and warm fluid level checks and is meant to be left in the vehicle and locked into place. Additional features include an engraved B&M logo locking knurled handle cap and temperature range engraved indicator end.

ENGINE	PART NUMBER	ENGINE	PART NUMBER	Fits NAG-1 automatic transmission used in the 06-12 Dodge Charger, 05-08 Dodge Magnum, 08-12 Dodge Challenger and 05-12 Chrysler 300e
3.5L Engine	22300	6.1L Engine	22302	
3.6L Engine	22300	6.4L Engine	22302	
5.7L Engine	22301			



BRACKET AND LEVER KIT

This B&M Bracket and Lever Kit allows most B&M shifters to be used on a vehicle equipped with a Ford 4R70W or E400/4R100 Automatic transmission. Both Selector Shaft and Selector Lever are made of T6 Aluminum. Due to the countless uses and exposure to the elements, both parts are Hard Anodized to prevent wear and corrosion.

TRANSMISSION	PART NUMBER
FORD 4R70W	40504
E400/4R100	40505



#80250 TRANSMISSION PAN DRAIN PLUG KIT

Only a few automatic transmissions have drain plugs from the factory, removing the pan to drain the fluid can be a mess. Remove the pan once, drill a hole, bolt the B&M Drain Plug Kit in, and eliminate messy oil splash. Also non-magnetic.



#80217 POWER SWITCH FOR GM CLUTCH CONVERTERS GM TH700R4, 200-4R, 200C AND 350C

Power switch For GM Clutch Converters, 1981 to 1989 GM TH700R4 1981 to 1991 200-4R, 1980-1985 200C and 350C. Operate your vehicle as a standard type torque converter when it is more desirable than the lock-up type. The Power switch kit supplied for these transmissions only locks out the converter clutch in first through third gear. The TH700R4 and the 200-4R will not function properly with the lock-up converter locked out in fourth gear. The Power switch kit automatically overrides the switch in fourth gear in overdrive transmissions.



#120004 B&M SPEEDOMETER CONTROL UNIT

B&M's speedometer control unit



#120001 SHIFTPLUS 2 ELECTRONIC OVERDRIVE TRANSMISSION CONTROLLER

The ShiftPlus 2 electronic overdrive transmission control for GM 4L60E, 4L65E, 4L70E, 4L80E and 4L85E is fully configured right out of the box. There is no tuning necessary but for those who demand customization the unit is also optionally fully programmable based on load, speed and RPM. Works with GM automatic transmission models 4L60E, 4L65E, 4L70E, 4L80E and 4L85E that are 1993 and newer. Gives users complete control over most popular electronic overdrive transmissions and no laptop, hand-held tuning device, or software of any kind is required. Shift firmness, shift points, and torque converter lockup are simply adjusted with easy to use dials found on the end of the unit. Comes with a calibration for your transmission so all you have to do is drive it like it is or adjust it to suit your individual taste. Complete transmission diagnostics built in with bright LEDs right on the unit. Includes the Simple Shift control unit and wiring harness, specific to your application with clearly labeled connectors and easy to follow instructions. Available for most popular GM and Ford electronic overdrive transmissions



#120002 THROTTLE POSITION SENSOR FOR CARBURETED ENGINE KIT

This B&M throttle position sensor is used for carbureted engines. Part works in conjunction with B&M transmission controller part number 120001 only.



#70354 FILTER EXTENSION REPLACEMENT FOR B&M DEEP TRANSMISSION PAN

Filter extension for B&M deep pan part #70260 when used on a GM 4L60E automatic transmission. Lowers the filter to the bottom of the pan for improved fluid pick up on deeper than stock transmission oil pans.



#50279 FILTER EXTENSION REPLACEMENT FOR B&M DEEP TRANSMISSION PAN

Filter Extension for B&M part # 50281



#10288 SPECIAL FILTER FOR MOST B&M TRANSMISSION DEEP PANS

Replacement filter to be used on some B&M chrome steel deep pans, cast aluminum.

STARTERS

TRANSMISSIONS

FLEXPLATES

TORQUE CONVERTERS

AUTOMATIC SHIFTERS

MANUAL SHIFTERS

COOLING PRODUCTS

ACCESSORIES



#70288 FILTER EXTENSION REPLACEMENT FOR B&M DEEP TRANSMISSION PAN

Filter extension for B&M deep transmission pans. Works well with B&M deep pan part #70289 and 70260 with 700R4/4L60. Used to extend the filter to the bottom of a deeper than stock transmission pan. Easy to install.



#30284 FILTER EXTENSION FOR B&M TRANSMISSION DEEP PANS

Filter extension for B&M deep pan part #30280 and 30289. Lowers the filter to the bottom of a deeper than stock transmission oil pan for improved fluid pick up.



#20271 FILTER EXTENSION FOR B&M DEEP TRANSMISSION PANS 20280 AND 20289

Filter extension for B&M deep pan part #20280 and 20289. Lowers the filter to the bottom of the pan for improved fluid pick up on deeper than stock transmission oil pans.



#20248 TRANSMISSION GOVERNOR RECALIBRATION KIT FOR TH700R4, TH400 AND TH350 TRANSMISSION

This kit allows you to adjust the full throttle shift points of your transmission after it is installed in your vehicle. The Governor Recalibration Kit is very useful if you have a vehicle that is very light or has a low rear-end gear ratio.



#70248 CONVERTER LOCKUP CONTROLLER W/ FACTORY GM ELECTRIC SPEED SENSOR

The B&M Lockup Controller provides control of lockup through vehicle speed on GM TH700R4, 200, 200-4R, 350 and 4L60 with a lockup converter, Can be used for lockup operation when converting a non-lockup equipped vehicle to a lock-up style.



#70244 CONVERTER LOCKUP CONTROLLER

The B&M Converter Lockup Controller provides dash-mounted control to govern converter lockup at any speed between 30 and 90 mph. These kits eliminate converter lock and unlock cycling and premature unwanted converter lockup.



B&M SPEEDOMETER CABLE & GENERATOR FOR 70244 - GM CONVERTER LOCK-UP CONTROL KIT

Speedo Cable and Generator for part #70244 are service parts for GM Converter Lock-Up Control Kit - 70244. Whether the cable and generator are worn out or damaged...these two components are readily available as replacements so you can continue with your project or have your vehicle back to perfect as soon as possible. This package does not contain any other part aside from the Speedo Cable and Generator. Instructions not included.

COMPONENT	PART NUMBER
Speedo Cable	70208
Speedo Cable & Generator	70209



#80212 B&M TEMPERATURE GAUGE

Most transmission and converter failures can be traced directly to excessive heat. Even if your vehicle was equipped with a standard transmission cooler, it is an excellent idea to install a transmission temp gauge. This is because most of the time an engine will produce enough power to overheat the transmission, especially in towing applications. This gauge allows the driver to operate the vehicle within its limits, preventing possible damage.



#80278 B&M EASY MOUNTING KIT

This Easy Mounting Kit included with most B&M coolers is available separately for remounts or additional cooler support. Includes 4 nylon mounting rods, 4 nylon slip-lock nuts, and 4 sponge rubber pads. This special hardware is exceptionally convenient when mounting a cooler to an existing heat exchanger, such as an air conditioning condenser or radiator.



#46076 B&M ROLL CONTROL® WITH BUTTON

B&M Launch Controls can be used to control either your front or rear brakes. They're intended primarily as brake-locking devices for drag racing, but they also can be used on the street as hill-holders (up to 60 seconds).



#46075 B&M ROLL CONTROL® SOLENOID

This high quality solenoid can be used on either the front or rear brakes of your vehicle and can handle pressure spikes up to 1500 PSI or maintain constant pressure of up to 400 PSI. Installation kit includes: in-dash line fuse assembly, indicator light, aluminum switch mount, and button switch.



#46057 B&M COMMAND-FLO

CommandFlo for Honda '88-'00 Civic/CRX, '00 S2000, Acura '90-'00 Integra, Acura '91-'00 NSX. The CommandFlo is a billet aluminum fuel flow modifier for Honda and Acura applications. The CommandFlo allows adjustment of the fuel flow rate which lets you properly tune the air/fuel ratio. Ideal for use with free flow intakes and exhaust systems.

STARTERS

TRANSMISSIONS

FLEXPLATES

TORQUE CONVERTERS

AUTOMATIC SHIFTERS

MANUAL SHIFTERS

COOLING PRODUCTS

ACCESSORIES



#46054 FUEL PRESSURE GAUGE

The B&M Fuel Pressure Gauge Set allows for accurately measuring fuel pressure. Proper fuel pressure is critical at full throttle to prevent lean conditions. Recommended for use with CommandFlo for a complete, accurate fuel delivery tuning system. Designed specifically to fit Acura, Honda, & Mitsubishi applications. However may fit any application with 1/8" NPT.



SPIRAL CORD SWITCHES

Use with Transbrake, launch control and nitrous systems. Rated at 12 amps. Works with 12 and 16 volt systems Two wire cord measures 18 inches and stretches to 60 inches.

DESCRIPTION	PART NUMBER
RED MOMENTARY SWITCH	46013
GREEN MOMENTARY SWITCH	46003



#65212 B&M ADJUSTABLE HAT

Black B&M logo hat with velcro adjustable. One size fits most.

- Black cotton twill hat
- Embroidered B&M logo
- Stylish racing apparel
- Velcro adjustable one size fits most



B&M HYDROSTICK T-SHIRT

Back in the days when B&M started in Van Nuys, California, we were known for our Hydro Stick transmissions. We may not be selling Hydro Sticks anymore, but you can still wear the original B&M logo proudly, with this 100% cotton black tee featuring small B&M Hydro Stick logo on front and large mechanical man image on the back.

- B&M quality
- Durable
- Fade resistant
- Premium quality 100% pre-shrunk

SIZE	PART NUMBER
S	653301
M	653302
L	653303
XL	653304
2XL	653305



#651700 B&M BANNER

This large scale B&M logo banner is perfect to display your B&M Performance Products pride in your shop, garage, or out at the track. The banner is 82"Wx 23"H, made from heavy duty vinyl, with a hemmed edge, and grommets in each corner. Ready to hang!

- B&M quality
- Durable Vinyl
- Fade resistant
- hemmed perimeter
- 4 grommets attached



WARRANTY INFORMATION:

Lifetime Limited Warranty applies to all B&M shifters, differential covers and cast aluminum pans.

One Year Limited Warranty applies to B&M starters, coolers, shifter related accessories (knobs, handles, etc.), torque converters, flexplates, dipsticks, stamped steel pans and other transmission related accessories (except racing products).

90 Day Limited Warranty applies to B&M transmissions, launch control kits and all electrical components (switches, lights, solenoids). B&M Racing & Performance ("B&M") extends the following limited warranty to products purchased after August 1, 2015 to the original purchaser of its shifters, pans, coolers, starters, transmissions, components and accessories (hereafter "products").

B&M warrants the products mentioned above against defects in materials and workmanship for the period set forth below, when they are owned by the original purchaser and remain installed on the vehicle on which they were originally installed. This warranty is void if the product was not installed properly on the vehicle, was installed on a vehicle for which it was not designed, or was removed from the vehicle on which it was originally installed and reinstalled on another vehicle. This warranty shall not apply to normal wear (bushings, springs, etc.), cosmetic issues such as coatings and material discoloration, or any product that was installed on a racing vehicle (excluding shifters), installed contrary to B&M instructions, or altered, misused, repaired, damaged from an accident, collision, undercarriage road impact or debris, or willful or negligent act.

The warranty set forth herein for all B&M shifters, differential covers and cast aluminum pans extends for a period of the life of the original vehicle the product was installed on. The warranty set forth herein for B&M starters, coolers, shifter related accessories (knobs, handles, etc.), torque converters, flexplates, dipsticks, stamped steel pans and other transmission related accessories (except racing products) extends for a period of one year from the date of original purchase and the original vehicle it was installed on. The warranty set forth herein for B&M transmissions, launch control kits and all electrical components (switches, lights, solenoids) extends for a period of 90 days from the date of original purchase and the original vehicle it was installed on.

To make any claim under the terms of this limited warranty, the original purchaser **MUST** either return the product to the original retailer or directly to B&M. If the original purchaser elects to return the product to B&M directly, he or she must first contact B&M and obtain a Returned Material Authorization (RMA) number. Once the RMA number is received, the original purchaser may return the product to B&M Racing at 1500 Overland Court, Sacramento, CA 95691 (or such other address provided by B&M) along with the RMA number and Proof of Purchase of the covered product. The Proof of Purchase must clearly show the place of purchase, purchase price, product purchased, and date of purchase. If upon inspection by B&M the product is found to be defective in material or workmanship, B&M shall at its option, either exchange the product for new product with the same part number or refund the original purchase price.

This warranty is not contingent upon the purchaser's completion of the Warranty Registration Form found on the B&M website. If however the purchaser completes and submits that form at the time of purchase, B&M will keep that form on file which may serve as an aid in determining warranty coverage in the event of the loss of the original purchase receipt.

B&M's liability is expressly limited to the replacement of the product or refund of the purchase price as described herein. B&M shall have no liability for the cost of installation or removal of the defective product, the cost of labor or any additional parts required to complete the installation of the replacement product, towing or transportation costs, or return shipping costs. In no event shall B&M be liable for any direct, indirect, special, incidental and/or consequential losses or damages, including but not limited to interruption of business or loss of business or loss of profit or damage to related components resulting from the use of or inability to use the product, or any breach of warranty or any defect in the product, even if B&M shall have been advised of the possibility of such potential losses or damages. Some states do not allow the exclusion or limitation of incidental or consequential damages, so the above limitation or exclusion may not apply to you. This warranty gives you specific legal rights. You may also have other rights which may vary from state to state.

The warranties set forth herein are exclusive and unless otherwise required by applicable law, no other warranties are made by B&M or are authorized to be made with respect to the product.

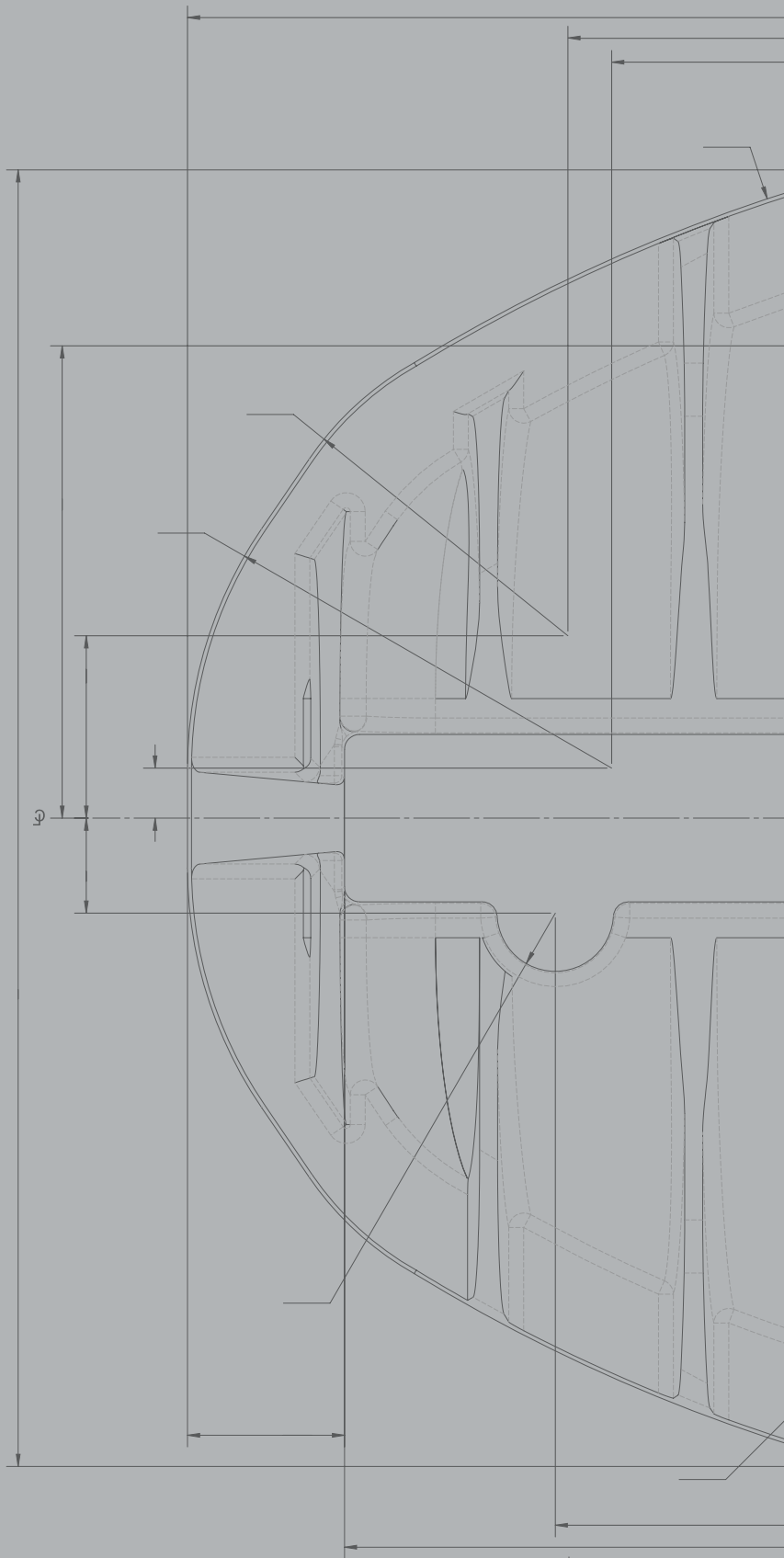
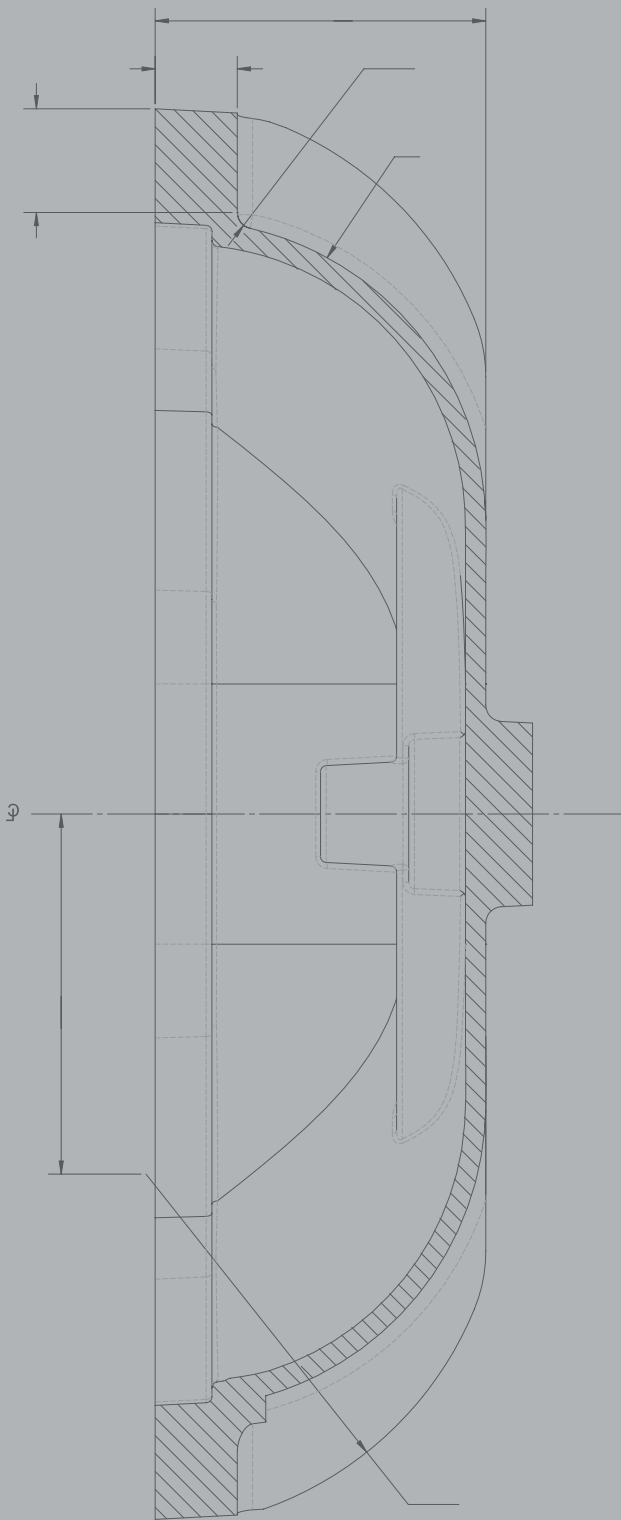

FALL 2016

PART# 660162 PRICE: \$5.00



100 STONY POINT ROAD SUITE 125 SANTA ROSA, CA 95401 • 707.544.4761 • WWW.BMRACING.COM