



CELSI  
*...the future of fire*



PREMIUM ELECTRIC FIRES COLLECTION



## WELCOME TO CELSI

At Celsi we know how important it is to create a stylish and relaxing living environment. That's why we've developed this collection of premium electric fires.

I believe our success stems from a combination of innovative design, investment in technology and the highest quality manufacturing standards. As a result all Celsi heaters carry a 2 year guarantee to reflect my belief in their quality and durability.



*Michael Dwyer*

This brochure has been designed to make the purchase of your new Celsi heater as simple as possible. I hope you find it both informative and inspiring.

### PURAFLAME®



Puraflame Introduction	page 4
Puraflame Panoramic	page 5
Puraflame Curved	page 6
Puraflame Camber	page 7
Puraflame Functionality at Your Fingertips	page 8



We are confident you are getting a product that is built to last. That's why we offer a 2 Year Guarantee on all Celsi electric fires.

### ELECTRIFLAME® XD



Electriflame XD Introduction	page 9
Electriflame XD Decadence	page 10
Electriflame XD Arcadia	page 11
Electriflame XD Camber	page 12
Electriflame XD Essence	page 13
Electriflame XD Oxford	page 14
Electriflame XD Portrait	page 15
Electriflame XD Landscape	page 16
Electriflame XD Lynx Suite	page 17
Electriflame XD Omega Suite	page 18



Electriflame Basalt Granite	Page 33
Electriflame Black Glass	Page 34
Electriflame Curved Black Glass	Page 35
Electriflame Ivory	Page 36
Electriflame London Suite	Page 37
Electriflame Paris Suite	Page 38
Electriflame Oslo Suite	Page 39

**ACCENT & FLAMONIK**



Accent & Flamonik Introduction	page 40
Flamonik Enchant	page 41
Flamonik Rapture	page 42
Accent Infusion	page 43
Accent Traditional	page 44

Electriflame Introduction	page 19
Electriflame Camber 22"	page 20
Electriflame Lamela	page 21
Electriflame Royale	page 22
Electriflame Modern	page 23
Electriflame Daisy	page 24
Electriflame Bauhaus	page 25
Electriflame Oxford 22" Hearth	page 26
Electriflame Caress	page 27
Electriflame Prestige Brown	page 28
Electriflame Oxford Wall Mounted	page 29
Electriflame Travertine	page 30
Electriflame Royal Botticino	page 31
Electriflame Piano Black	Page 32

**ELECTRIC OUTSET RANGE**



Electric Outset Range Introduction	page 45
Strata Electric	page 46
Misermatic Electric	page 47
Renaissance Electric	page 48

**FIRE SURROUNDS**

Fire Surround Introduction	page 49
Amor	Page 50
Arria	Page 50
Nova	Page 51
Rubi	Page 51

## PURAFLEAME® RANGE

Combining style with innovation, the Puraflame® range of electric fires is the ultimate in high technology, and gives you the most convincing real fire effect available today.

A Puraflame® electric heater is extremely versatile and creates a breathtaking feature virtually anywhere in your home, from your lounge to your bedroom. Using LCD technology Puraflame® is the only electric fire to give you the astonishing look and sound of a real fire, combined with exceptional functionality. At the touch of a button you can control your room temperature, flame picture, flame speed, volume and brightness. Read more about this amazing functionality opposite.

Celsi Puraflame® is not just a fireplace.  
It's an experience.

Shhhh... Listen...

PURAFLEAME® is the  
**quietest fire available\***  
on the market

\* 'flame only' setting



PURAFLEAME® CURVED with blazing log flame picture



PURAFLAME® PANORAMIC with blazing log flame picture

**PURAFLAME® PANORAMIC**

- 3 Realistic Flame Movies
- 5 Flame Speed settings
- Real Fire Sounds with 5 volume levels
- Up to 2kW heat output
- Programmable Thermostatic Heat Control
- Mood Lighting with choice of 3 colours
- Sleep Timer with 9 settings
- Adjustable screen brightness
- Stylish black glass fascia
- One of the quietest fires available on flame only setting
- 2 Year Guarantee

Dimensions (H x W x D)	400mm x 1080mm x 105mm
Heat Output – High	2kW
Heat Output - Low	1kW
Safety	Thermal cut out
Remote Control	Yes
Electronic Digital Thermostat	Yes
Mood Lighting	Yes
Flame Options	Smouldering Log Blazing Log Flaming Coal

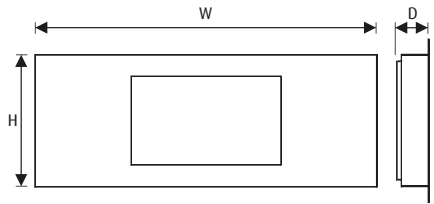

Please note: When installed there must be a minimum distance of 300mm between the bottom of the fire and the floor.





Watch the video

## PURAFLEME® CURVED

- 3 Realistic Flame Movies
- 5 Flame Speed settings
- Real Fire Sounds with 5 volume levels
- Up to 2kW heat output
- Programmable Thermostatic Heat Control
- Mood Lighting with choice of 3 colours
- Sleep Timer with 9 settings
- Adjustable screen brightness
- Stylish black glass fascia
- One of the quietest fires available on flame only setting
- 2 Year Guarantee

Dimensions (H x W x D)	505mm x 980mm x 135mm
Heat Output – High	2kW
Heat Output - Low	1kW
Safety	Thermal cut out
Remote Control	Yes
Electronic Digital Thermostat	Yes
Mood Lighting	Yes
Flame Options	Smouldering Log Blazing Log Flaming Coal

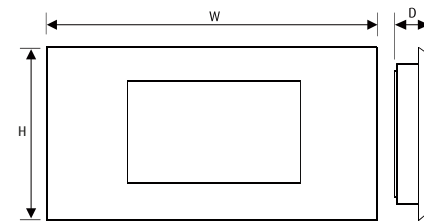

Please note: When installed there must be a minimum distance of 300mm between the bottom of the fire and the floor.





PURAFLAME® CAMBER with blazing log flame picture

**PURAFLAME® CAMBER**

- 3 Realistic Flame Movies
- 5 Flame Speed settings
- Real Fire Sounds with 5 volume levels
- Up to 1.8kW heat output
- Programmable Thermostatic Heat Control
- Mood Lighting with choice of 3 colours
- Sleep Timer with 9 settings
- Adjustable screen brightness
- Contemporary satin silver fascia
- One of the quietest fires available on flame only setting
- 2 Year Guarantee

Dimensions (H x W x D)	685mm x 615mm x 75mm inset + 120mm fascia
Heat Output – High	1.8kW
Heat Output – Low	0.9kW
Safety	Thermal cut out
Remote Control	Yes
Electronic Digital Thermostat	Yes
Flame Options	Smouldering Log Blazing Log Glowing Coal

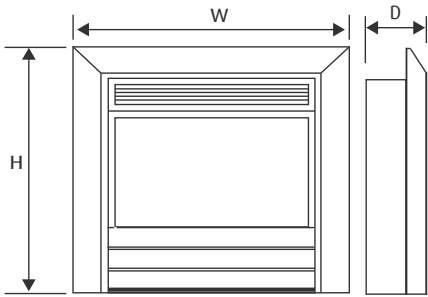

# CELSI PURAFLAME® THE MOST FUNCTIONAL ELECTRIC FIRE ON THE MARKET

## FLAME PICTURES

Celsi has patented some of the most advanced technologies to create the most sophisticated and realistic fire effect in the world. Every Puraflame fire has been designed to give the appearance of outstanding depth along with an amazing 3D effect, and comes with a selection of real fire effects to choose from.



**SMOULDERING LOG**  
Available on all models



**BLAZING LOG**  
Available on all models



**FLAMING COAL**  
Available on Curved and Panoramic only



**GLOWING COAL**  
Available on Puraflame Camber & Puraflame Oxford

## FLAME SPEED

You may prefer a slow and calming flame or a quick and spellbinding flicker. With a choice of 5 flame speeds you can speed up or slow down each of the real fire movies.



## FIRE VOLUME

There's nothing more soothing than the authentic crackle of a real log fire. Lower the volume for a more subtle result or crank it up for full effect. There is also a mute button to silence the sound effect when you need to. When on 'flame only' setting, Puraflame is the quietest fire on the market.

## MOOD LIGHTING

The mood lighting feature creates a calming ambience around the heater. A choice of 3 colours: white, amber and blue, lets you highlight the fire to suit your mood. This is only available on the Curved and Panoramic models and can be turned off if not required.



**WHITE**



**BLUE**



**AMBER**



**OFF**



## PICTURE BRIGHTNESS

Natural daylight or artificial lamplight can have a big impact on how you see the flame picture. We have included this brightness function to allow you the option to increase or dim the screen brightness to suit you and your environment.



## SLEEP TIMER

An extremely practical function. The sleep timer can be used to automatically turn the heater to standby mode after a predetermined amount of time. Great if you want to doze off and not worry about turning the fire off once you have fallen asleep. The timer can be set for up to a maximum of 4 hours in 30 minute intervals and once this time has elapsed the appliance will automatically go into standby.



## TEMPERATURE

The fan heater can be operated in manual or automatic mode. When in manual mode you can use the heat button on the remote handset to select low heat, high heat or heat off.

To eliminate the hassle of constantly manually adjusting the heat output, every Puraflame fire features a state-of-the-art, digitally controlled thermostat. Use the temperature function to turn on automatic heat mode. You can pre-select your comfort level and the heater will automatically adjust between high heat and off, maintaining the room temperature you have selected.



## FUNCTIONALITY AT YOUR FINGERTIPS



## ELECTRIFLAME®XD RANGE

The Celsi Electrifiame XD Range uses improved technology to create a stunning extra deep fuel bed and high definition flame picture. Sit back and relax as the vibrant new 3D flame effect, smouldering fuel bed and soothing heat output creates an atmospheric and highly realistic experience.



Extra Deep 3D Effect

Electrifiame XD comes with two heat levels and a variable flame dimmer with a new random glow fuel bed setting. All this can be operated via the remote control handset or using the manual controls on the appliance.





Watch the video

## ELECTRIFLAME®XD DECADENCE

- Solid Cast Iron Fascia
- Advanced 3D Technology to create an extra deep 3D effect
- Relaxing, smoky, full depth flame effect
- Low cost, high efficiency LED lighting
- Variable flame dimmer with four settings
- Two heat levels and a flame effect only option
- Operated via remote control handset or manual controls
- Supplied with a spacer and deep trim to allow the fire to fit easily into any 3" rebated surround
- Available in a choice of three colours; Silver, Gold and Black Nickel



ELECTRIFLAME®XD DECADENCE in Silver



ELECTRIFLAME®XD DECADENCE in Black Nickel

Dimensions (H x W x D)	630mm x 529mm x 63mm inset + 110mm fascia and spacer
Heat Output – High	1.8kW
Heat Output - Low	0.9kW
Safety	Thermal cut out
Remote Control	Yes
Available finishes	Silver, Gold and Black Nickel

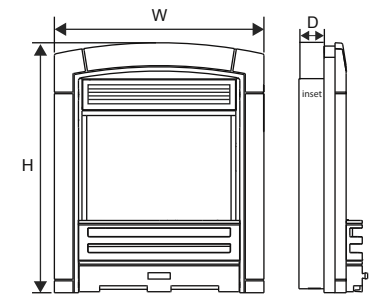

## ELECTRIFLAME®XD ARCADIA

- Solid Cast Iron Fascia
- Advanced 3D Technology to create an extra deep 3D effect
- Relaxing, smoky, full depth flame effect
- Low cost, high efficiency LED lighting
- Variable flame dimmer with four settings
- Two heat levels and a flame effect only option
- Operated via remote control handset or manual controls
- Supplied with a spacer and deep trim to allow the fire to fit easily into any 3" rebated surround
- Available in a choice of two colours; Silver and Gold



**ELECTRIFLAME®XD  
ARCADIA** in Gold

Dimensions (H x W x D)	612mm x 528mm x 63mm inset + 118mm fascia and spacer
Heat Output – High	1.8kW
Heat Output - Low	0.9kW
Safety	Thermal cut out
Remote Control	Yes
Available finishes	Gold and Silver

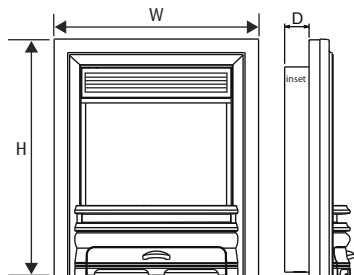

Watch the video

ELECTRIFLAME®XD ARCADIA in Silver

ELECTRIFLAME®XD CAMBER in Champagne



Watch the video

## ELECTRIFLAME®XD CAMBER

- Advanced 3D Technology to create an extra deep 3D effect
- Relaxing, smoky, full depth flame effect
- Low cost, high efficiency LED lighting
- LED decorative lights embedded in the fascia
- Variable flame dimmer with four settings
- Two heat levels and a flame effect only option
- Operated via remote control handset or manual controls
- Supplied with a spacer and deep trim to allow the fire to fit easily into any 3" rebated surround
- Available in a choice of three colours; Silver, Champagne, or Black



ELECTRIFLAME®XD CAMBER in Silver



ELECTRIFLAME®XD CAMBER in Black

Dimensions (H x W x D)	595mm x 490mm x 75mm inset + 35mm fascia
Heat Output - High	1.8kW
Heat Output - Low	0.9kW
Safety	Thermal cut out
Remote Control	Yes
Available finishes	Silver, Champagne and Black

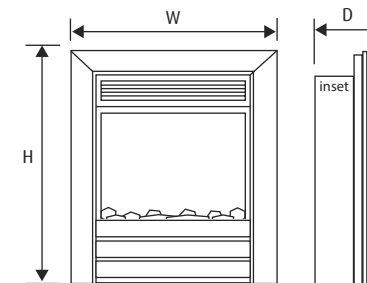

## ELECTRIFLAME®XD ESSENCE

- Advanced 3D Technology to create an extra deep 3D effect
- Relaxing, smoky, full depth flame effect
- Low cost, high efficiency LED lighting
- Variable flame dimmer with four settings
- Two heat levels and a flame effect only option
- Operated via remote control handset or manual controls
- Supplied with a spacer and deep trim to allow the fire to fit easily into any 3" rebated surround
- Available in a choice of four colours; brushed silver, antique brass, satin brass or black



**ELECTRIFLAME®XD  
ESSENCE**  
in Brushed Silver



**ELECTRIFLAME®XD  
ESSENCE** in Satin Brass



**ELECTRIFLAME®XD  
ESSENCE** in Black

Dimensions (H x W x D)	625mm x 535mm x 75mm inset + 80mm fascia
Heat Output – High	1.8kW
Heat Output - Low	0.9kW
Safety	Thermal cut out
Remote Control	Yes
Available finishes	Brushed Silver, Antique Brass, Satin Brass or Black

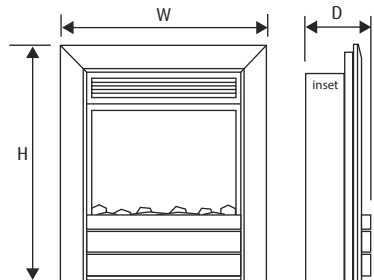

Watch the video



Watch the video

ELECTRIFLAME®XD OXFORD in Brown

## ELECTRIFLAME®XD OXFORD

- Solid Cast Iron Fascia
- Advanced 3D Technology to create an extra deep 3D effect
- Relaxing, smoky, full depth flame effect
- Low cost, high efficiency LED lighting
- Variable flame dimmer with four settings
- Two heat levels and a flame effect only option
- Operated via remote control handset or manual controls



ELECTRIFLAME®XD OXFORD in Black

Dimensions (H x W x D)	595mm x 490mm x 75mm inset + 35mm fascia
Heat Output - High	1.8kW
Heat Output - Low	0.9kW
Safety	Thermal cut out
Remote Control	Yes
Available finishes	Black or Brown

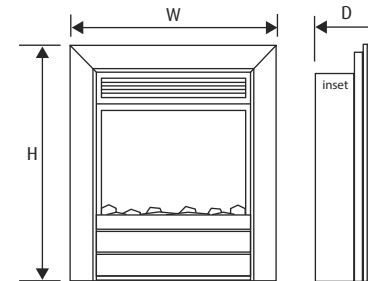



Watch the video

ELECTRIFLAME®XD PORTRAIT

## ELECTRIFLAME®XD PORTRAIT

- Advanced 3D technology to create an extra deep flame effect
- Relaxing, smoky full depth flame effect
- Low cost, high efficiency LED lighting
- Variable flame dimmer with four settings
- Two heat levels and a flame effect only option
- Operated via remote control handset or manual controls
- Optional random glow fuel bed setting

Dimensions (H x W x D)	720mm x 575mm x 150mm
Heat Output – High	2kW
Heat Output - Low	1kW
Safety	Thermal cut out
Remote Control	Yes



EXTRA DEEP 3D EFFECT

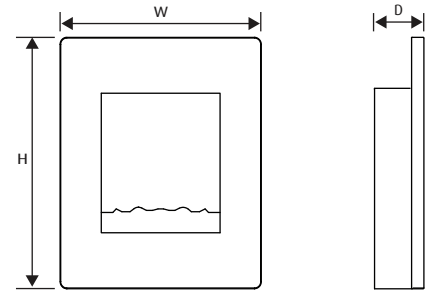

Please note: When installed there must be a minimum distance of 400mm between the bottom of the fire and the floor.





## ELECTRIFLAME®XD LANDSCAPE

- Advanced 3D technology to create an extra deep flame effect
- Relaxing, smoky full depth flame effect
- Low cost, high efficiency LED lighting
- Variable flame dimmer with four settings
- Two heat levels and a flame effect only option
- Operated via remote control handset or manual controls
- Optional random glow fuel bed setting

Dimensions (H x W x D)	650mm x 915mm x 133mm
Heat Output – High	1.8kW
Heat Output - Low	0.9kW
Safety	Thermal cut out
Remote Control	Yes



EXTRA DEEP 3D EFFECT

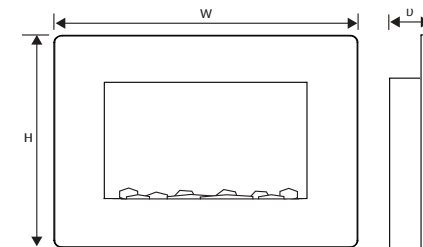

Please note: When installed there must be a minimum distance of 400mm between the bottom of the fire and the floor.







ELECTRIFLAME®XD LYNX SUITE

**ELECTRIFLAME®XD  
LYNX SUITE**

- Top quality Royal Botticino fireplace
- Advanced 3D technology to create an extra deep flame effect
- Relaxing, smoky full depth flame effect
- Low cost, high efficiency LED lighting
- Variable flame dimmer with four settings
- Two heat levels and a flame effect only option
- Operated via remote control handset or manual controls
- Optional random glow fuel bed setting

Dimensions (H x W x D)	1100mm x 1000mm x 300mm
Heat Output – High	2kW
Heat Output - Low	1kW
Safety	Thermal cut out
Remote Control	Yes



EXTRA DEEP 3D EFFECT

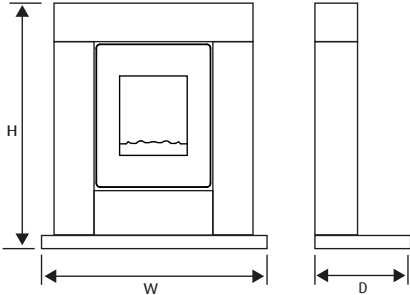



## ELECTRIFLAME®XD OMEGA SUITE

- Top quality Royal Botticino fireplace
- Advanced 3D technology to create an extra deep flame effect
- Relaxing, smoky full depth flame effect
- Low cost, high efficiency LED lighting
- Variable flame dimmer with four settings
- Two heat levels and a flame effect only option
- Operated via remote control handset
- Optional random glow fuel bed setting

Dimensions (H x W x D)	1050mm x 1260mm x 300mm
Heat Output – High	1.8kW
Heat Output - Low	0.9kW
Safety	Thermal cut out
Remote Control	Yes



EXTRA DEEP 3D EFFECT

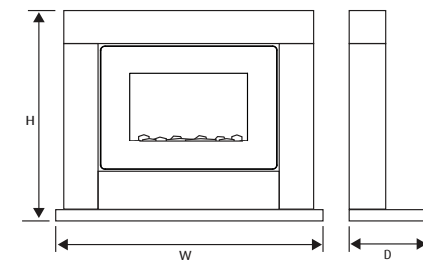

## ELECTRIFLAME® RANGE

Celsi Electrifiame uses advanced 3D technology to create one of the most realistic flame pictures found in any electric fire today.

Relax and enjoy the smoky, soothing flames and be amazed by the depth of the fuel effect. What's more, the high efficiency LED lights used to create the flame picture means that you benefit from low running costs too.

Electrifiame comes with a variable flame dimmer with four settings, and two heat levels, as well as a flame effect only option. All this can be operated via the remote control handset or using the manual controls on the appliance.



ELECTRIFLAME® PRESTIGE BROWN



## ELECTRIFLAME® CAMBER 22"

- Advanced 3D technology
- Relaxing, smoky full depth flame effect
- Low cost, high efficiency LED lighting
- Variable flame dimmer with three settings
- Two heat levels and a flame effect only option
- Operated via remote control handset or manual controls
- Supplied with a spacer and deep trim to allow the fire to fit easily into any 3" rebated surround

Dimensions (H x W x D)	615mm x 685mm x 75mm inset + 90mm fascia
Heat Output – High	1.8kW
Heat Output - Low	0.9kW
Safety	Thermal cut out
Remote Control	Yes
Available finishes	Polished Silver

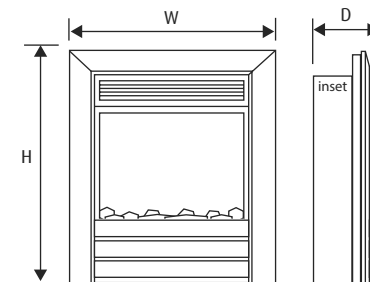

Watch the video



ELECTRIFLAME® CAMBER 22" in Polished Silver

## ELECTRIFLAME® LAMELA

- Advanced 3D technology
- Relaxing, smoky full depth flame effect
- Low cost, high efficiency LED lighting
- Variable flame dimmer with three settings
- Two heat levels and a flame effect only option
- Operated via remote control handset or manual controls
- Supplied with a spacer and deep trim to allow the fire to fit easily into any 3" rebated surround
- A Choice of two colours; Brass and Black or Silver and Black



**ELECTRIFLAME  
LAMELA**  
Silver and Black

Dimensions (H x W x D)	600mm x 500mm x 75mm inset + 80mm fascia and spacer
Heat Output – High	1.8kW
Heat Output - Low	0.9kW
Safety	Thermal cut out
Remote Control	Yes
Available finishes	Brass and Black or Silver and Black

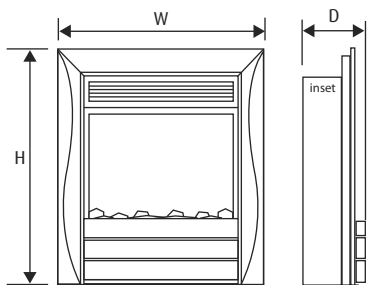

Watch the video

ELECTRIFLAME® ROYALE 16" in Brass



Watch the video

## ELECTRIFLAME® ROYALE

- Advanced 3D technology
- Relaxing, smoky full depth flame effect
- Low cost, high efficiency LED lighting
- Variable flame dimmer with three settings
- Two heat levels and a flame effect only option
- Operated via remote control handset or manual controls
- Supplied with a spacer and deep trim to allow the fire to fit easily into any 3" rebated surround
- A choice of three colour options; silver, brass or black
- Available in 16" and 22" fire widths



ELECTRIFLAME ROYALE 16" in Black



ELECTRIFLAME ROYALE 22" in Silver

	ROYALE 16"	ROYALE 22"
Dimensions (H x W x D)	595mm x 490mm x 75mm inset + 35mm fascia	595mm x 640mm x 75mm inset + 35mm fascia
Heat Output - High	1.8kW	1.5kW
Heat Output - Low	0.9kW	0.75kW
Safety	Thermal cut out	Thermal cut out
Remote Control	Yes	Yes
Available finishes	Brass, Silver or Black	Brass or Silver

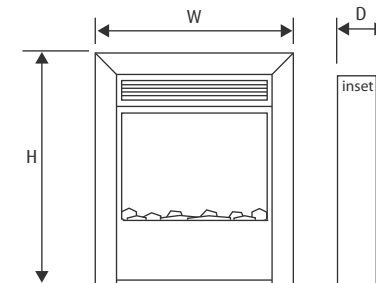

## ELECTRIFLAME® MODERN

- Advanced 3D technology
- Relaxing, smoky full depth flame effect
- Low cost, high efficiency LED lighting
- Variable flame dimmer with three settings
- Two heat levels and a flame effect only option
- Operated via remote control handset or manual controls
- Supplied with a spacer and deep trim to allow the fire to fit easily into any 3" rebated surround
- A choice of two colour options; brass or black



**ELECTRIFLAME  
MODERN**  
Brass

Dimensions (H x W x D)	595mm x 490mm x 75mm inset + 35mm fascia
Heat Output – High	1.8kW
Heat Output - Low	0.9kW
Safety	Thermal cut out
Remote Control	Yes
Available finishes	Brass or Black

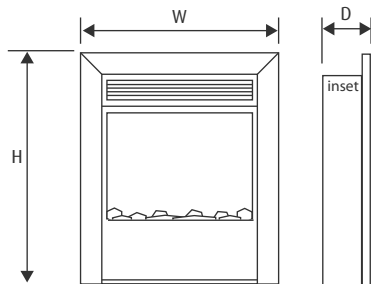

Watch the video

ELECTRIFLAME® DAISY in Silver



Watch the video

## ELECTRIFLAME® DAISY

- Advanced 3D technology
- Relaxing, smoky full depth flame effect
- Low cost, high efficiency LED lighting
- Variable flame dimmer with three settings
- Two heat levels and a flame effect only option
- Operated via remote control handset or manual controls
- Supplied with a spacer and deep trim to allow the fire to fit easily into any 3" rebated surround
- A choice of three colour options; silver, brass or black

Dimensions (H x W x D)	595mm x 490mm x 75mm inset + 35mm fascia
Heat Output – High	1.8kW
Heat Output - Low	0.9kW
Safety	Thermal cut out
Remote Control	Yes
Available finishes	Brass, Silver or Black

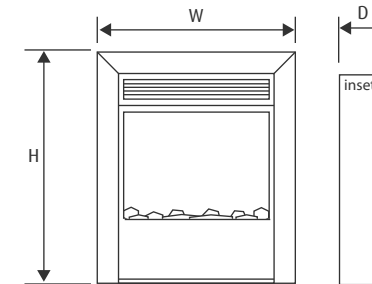

ELECTRIFLAME DAISY in Brass



ELECTRIFLAME DAISY in Black





## ELECTRIFLAME® BAUHAUS

- Advanced 3D technology
- Relaxing, smoky full depth flame effect
- Low cost, high efficiency LED lighting
- Variable flame dimmer with three settings
- Two heat levels and a flame effect only option
- Operated via remote control handset or manual controls
- Supplied with a spacer and deep trim to allow the fire to fit easily into any 3" rebated surround
- A choice of three colour options; silver, brass or black



**ELECTRIFLAME  
BAUHAUS** in Brass



**ELECTRIFLAME  
BAUHAUS** in Black

Dimensions (H x W x D)	595mm x 490mm x 75mm inset + 35mm fascia
Heat Output – High	1.8kW
Heat Output - Low	0.9kW
Safety	Thermal cut out
Remote Control	Yes
Available finishes	Brass, Silver or Black

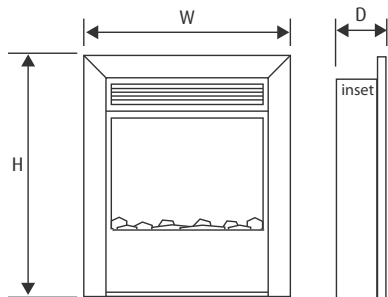

Watch the video

ELECTRIFLAME® OXFORD HEARTH MOUNTED 22" in Brown



## ELECTRIFLAME® OXFORD 22" HEARTH MOUNTED

- Elegantly designed MDF fascia
- Advanced 3D technology
- Relaxing, smoky full depth flame effect
- Low cost, high efficiency LED lighting
- Variable flame dimmer with four settings
- Two heat levels and a flame effect only option
- Operated via remote control handset or manual controls
- Supplied with a spacer to allow the fire to fit easily into any 3" rebated surround
- Available in brown or black top quality painted finishes

Dimensions (H x W x D)	628mm x 710mm x 60mm inset + 70mm fascia
Heat Output – High	1.5kW
Heat Output - Low	0.75kW
Safety	Thermal cut out
Remote Control	Yes
Available finishes	Brown or Black

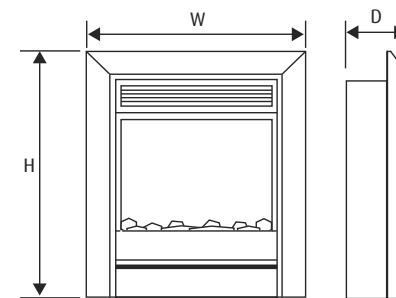

Watch the video



## ELECTRIFLAME® CARESS

- Advanced 3D technology
- Relaxing, smoky full depth flame effect
- Low cost, high efficiency LED lighting
- Variable flame dimmer with three settings
- Two heat levels and a flame effect only option
- Operated via remote control handset or manual controls
- Supplied with a spacer and deep trim to allow the fire to fit easily into any 3" rebated surround
- A choice of brass or polished silver



**ELECTRIFLAME CARESS  
BAUHAUS**  
in Polished Silver

Dimensions (H x W x D)	651mm x 535mm x 75mm inset + 59mm fascia
Heat Output – High	1.8kW
Heat Output - Low	0.9kW
Safety	Thermal cut out
Remote Control	Yes

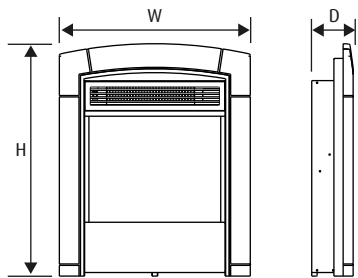

Watch the video

## ELECTRIFLAME® PRESTIGE BROWN



Watch the video

### ELECTRIFLAME® PRESTIGE BROWN

- Advanced 3D technology
- Relaxing, smoky full depth flame effect
- Low cost, high efficiency LED lighting
- Variable flame dimmer with four settings
- Two heat levels and a flame effect only option
- Operated via remote control handset or manual controls
- Includes an easy fixing wall plate for trouble free installation

Dimensions (H x W x D)	600mm x 1100mm x 150mm
Heat Output – High	1.5kW
Heat Output - Low	0.75kW
Safety	Thermal cut out
Remote Control	Yes

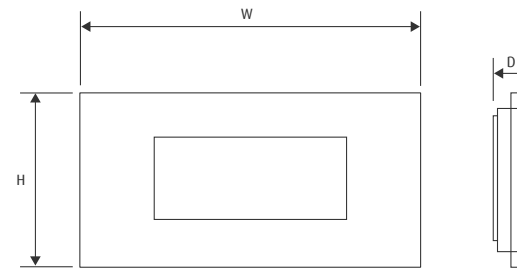

Please note: When installed there must be a minimum distance of 400mm between the bottom of the fire and the floor.





## ELECTRIFLAME® OXFORD WALL MOUNTED

- Elegantly designed MDF fascia
- Advanced 3D technology
- Relaxing, smoky full depth flame effect
- Low cost, high efficiency LED lighting
- Variable flame dimmer with four settings
- Two heat levels and a flame effect only option
- Operated via remote control handset or manual controls
- Available in brown or black top quality painted finishes

Dimensions (H x W x D)	635mm x 710mm x 130mm outset
Heat Output – High	1.5kW
Heat Output - Low	0.75kW
Safety	Thermal cut out
Remote Control	Yes
Available Finishes	Brown or Black



ELECTRIFLAME OXFORD in Brown

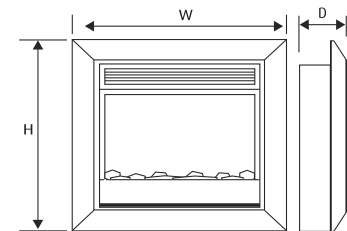



## ELECTRIFLAME® TRAVERTINE

- Advanced 3D technology
- Relaxing, smoky full depth flame effect
- Low cost, high efficiency LED lighting
- Variable flame dimmer with four settings
- Two heat levels and a flame effect only option
- Operated via remote control handset or manual controls
- Includes an easy fixing wall plate for trouble free installation
- Available in two sizes

	TRAVERTINE 1300	TRAVERTINE 1100
Dimensions (H x W x D)	600mm x 1300mm x 150mm	600mm x 1100mm x 150mm
Heat Output – High	1.5kW	1.5kW
Heat Output - Low	0.75kW	0.75kW
Safety	Thermal cut out	Thermal cut out
Remote Control	Yes	Yes

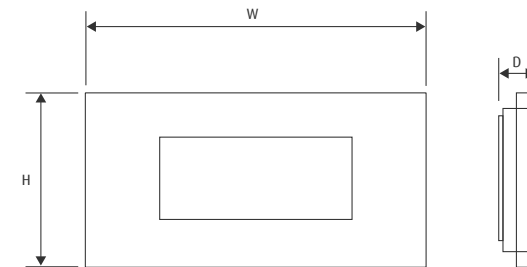

Please note: When installed there must be a minimum distance of 400mm between the bottom of the fire and the floor.





ELECTRIFLAME® ROYAL BOTTICINO

**ELECTRIFLAME®  
ROYAL BOTTICINO**

- Advanced 3D technology
- Relaxing, smoky full depth flame effect
- Low cost, high efficiency LED lighting
- Variable flame dimmer with four settings
- Two heat levels and a flame effect only option
- Operated via remote control handset or manual controls
- Includes an easy fixing wall plate for trouble free installation

Dimensions (H x W x D)	600mm x 1100mm x 150mm
Heat Output – High	1.5kW
Heat Output - Low	0.75kW
Safety	Thermal cut out
Remote Control	Yes

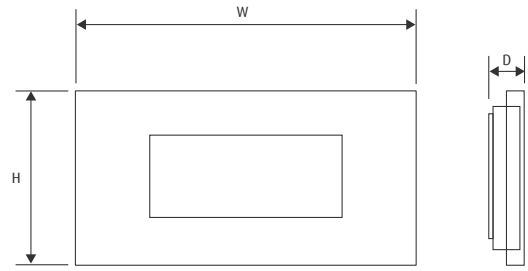

Please note: When installed there must be a minimum distance of 400mm between the bottom of the fire and the floor.

ELECTRIFLAME® PIANO BLACK



ELECTRIFLAME® PIANO BLACK

- Advanced 3D technology
- Relaxing, smoky full depth flame effect
- Low cost, high efficiency LED lighting
- Variable flame dimmer with four settings
- Two heat levels and a flame effect only option
- Operated via remote control handset or manual controls
- Includes an easy fixing wall plate for trouble free installation
- Available in two sizes

	PIANO BLACK 1300	PIANO BLACK 1100
Dimensions (H x W x D)	600mm x 1300mm x 150mm	600mm x 1100mm x 150mm
Heat Output – High	1.5kW	1.5kW
Heat Output - Low	0.75kW	0.75kW
Safety	Thermal cut out	Thermal cut out
Remote Control	Yes	Yes

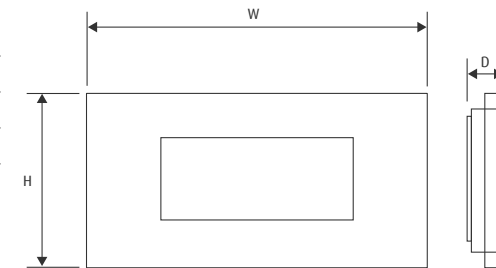

Please note: When installed there must be a minimum distance of 400mm between the bottom of the fire and the floor.





## ELECTRIFLAME® BASALT GRANITE

- Advanced 3D technology
- Relaxing, smoky full depth flame effect
- Low cost, high efficiency LED lighting
- Variable flame dimmer with four settings
- Two heat levels and a flame effect only option
- Operated via remote control handset or manual controls
- Includes an easy fixing wall plate for trouble free installation
- Available in two sizes

	BASALT GRANITE 1300	BASALT GRANITE 1100
Dimensions (H x W x D)	600mm x 1300mm x 150mm	600mm x 1100mm x 150mm
Heat Output – High	1.5kW	1.5kW
Heat Output - Low	0.75kW	0.75kW
Safety	Thermal cut out	Thermal cut out
Remote Control	Yes	Yes

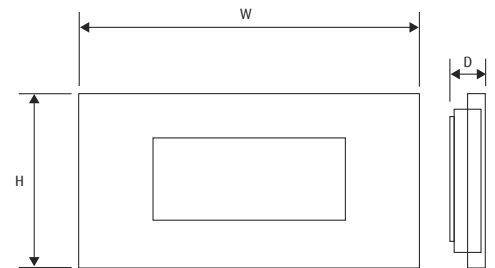

Please note: When installed there must be a minimum distance of 400mm between the bottom of the fire and the floor.

ELECTRIFLAME® BLACK GLASS



ELECTRIFLAME® BLACK GLASS

- Advanced 3D technology
- Relaxing, smoky full depth flame effect
- Low cost, high efficiency LED lighting
- Variable flame dimmer with four settings
- Two heat levels and a flame effect only option
- Operated via remote control handset or manual controls
- Includes an easy fixing wall plate for trouble free installation
- Available in two sizes

Dimensions (H x W x D)	BLACK GLASS 1300 600mm x 1300mm x 126mm	BLACK GLASS 1100 600mm x 1100mm x 126mm
Heat Output - High	1.5kW	1.5kW
Heat Output - Low	0.75kW	0.75kW
Safety	Thermal cut out	Thermal cut out
Remote Control	Yes	Yes

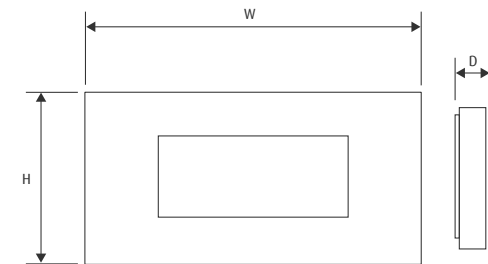

Please note: When installed there must be a minimum distance of 400mm between the bottom of the fire and the floor.



ELECTRIFLAME® CURVED BLACK GLASS

### ELECTRIFLAME® CURVED BLACK GLASS

- Advanced 3D technology
- Relaxing, smoky full depth flame effect
- Low cost, high efficiency LED lighting
- Variable flame dimmer with four settings
- Two heat levels and a flame effect only option
- Operated via remote control handset or manual controls
- Includes an easy fixing wall plate for trouble free installation
- 2 Year Guarantee

Dimensions (H x W x D)	590mm x 930mm x 149mm
Heat Output – High	1.5kW
Heat Output – Low	0.75kW
Safety	Thermal cut out
Remote Control	Yes

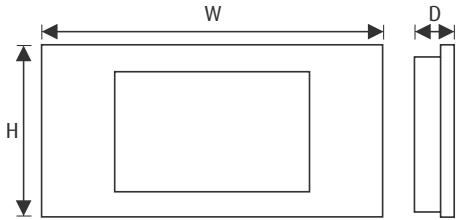

Please note: When installed there must be a minimum distance of 400mm between the bottom of the fire and the floor.



Watch the video

## ELECTRIFLAME® IVORY

- Advanced 3D technology
- Relaxing, smoky full depth flame effect
- Low cost, high efficiency LED lighting
- Variable flame dimmer with four settings
- Two heat levels and a flame effect only option
- Operated via remote control handset or manual controls
- Includes an easy fixing wall plate for trouble free installation
- Available in two sizes

Dimensions (H x W x D)	PIANO IVORY 1300 600mm x 1300mm x 150mm	PIANO IVORY 1100 600mm x 1100mm x 150mm
Heat Output - High	1.5kW	1.5kW
Heat Output - Low	0.75kW	0.75kW
Safety	Thermal cut out	Thermal cut out
Remote Control	Yes	Yes

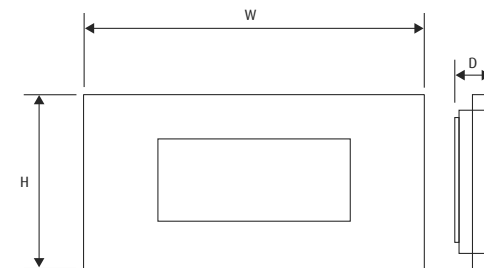

Please note: When installed there must be a minimum distance of 400mm between the bottom of the fire and the floor.





ELECTRIFLAME® LONDON SUITE

**ELECTRIFLAME®  
LONDON SUITE**

- Modern landscape electric fireplace
- Oak wood effect and glass fascia
- Extremely easy to install
- Advanced 3D technology
- Relaxing, smoky full depth flame effect
- Low cost, high efficiency LED lighting
- Variable flame dimmer with four settings
- Two heat levels and a flame effect only option
- Operated via remote control handset or manual controls
- Available with optional black glass hearth

Dimensions (H x W x D)	784mm x 1209mm x 135mm (Optional Hearth – 12mm x 1275mm x 270mm)
Heat Output - High	1.5kW
Heat Output - Low	0.75kW
Safety	Thermal cut out
Remote Control	Yes

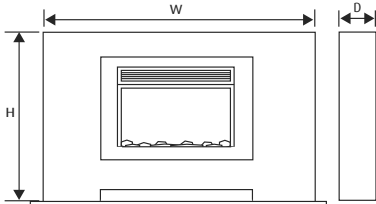



Watch the video

## ELECTRIFLAME® PARIS SUITE

- Contemporary portrait electric fireplace
- Walnut wood effect and glass fascia
- Extremely easy to install
- Advanced 3D technology
- Relaxing, smoky full depth flame effect
- Low cost, high efficiency LED lighting
- Variable flame dimmer with three settings
- Two heat levels and a flame effect only option
- Operated via remote control handset or manual controls
- Available with optional black glass hearth

Dimensions (H x W x D)	1185mm x 892mm x 135mm (Optional Hearth – 12mm x 960mm x 270mm)
Heat Output – High	1.8kW
Heat Output - Low	0.9kW
Safety	Thermal cut out
Remote Control	Yes

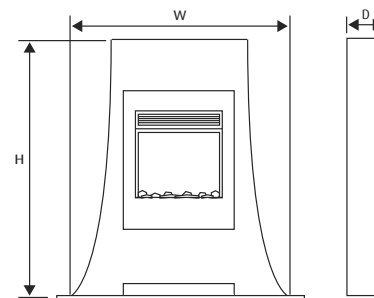





Watch the video

ELECTRIFLAME® OSLO SUITE

## ELECTRIFLAME® OSLO SUITE

- Contemporary electric fireplace
- Cherry wood effect and glass fascia
- Extremely easy to install
- Advanced 3D technology
- Relaxing, smoky full depth flame effect
- Low cost, high efficiency LED lighting
- Variable flame dimmer with four settings
- Two heat levels and a flame effect only option
- Operated via remote control handset or manual controls
- Available with optional black glass hearth

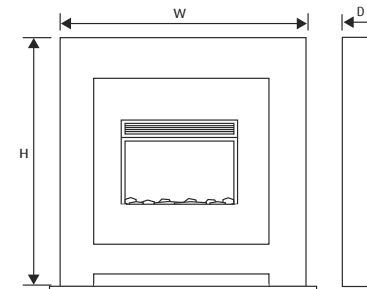
Dimensions (H x W x D)	1004mm x 1005mm x 135mm (Optional Hearth – 12mm x 1072mm x 270mm)
Heat Output – High	1.5kW
Heat Output – Low	0.75kW
Safety	Thermal cut out
Remote Control	Yes



## ACCENT & FLAMONIK RANGE

Accent hang-on-the-wall electric fires use ribbon flame technology to create a beautiful flame effect with a comforting under bed glow.

An Accent electric fire can create the perfect atmosphere to suit your mood with optional backlight in a choice of calming blue or vibrant orange glow, and variable flame speed ranging from a gentle wave to a dancing flicker.

Our Flamonik range features the latest electric fire technology to create distinctive and mesmerising flame pictures. They also include a colour changing fuel bed and colour changing back lights which enable you to set your fire to suit your mood.



FLAMONIK RAPTURE





FLAMONIK ENCHANT



Watch the video

### FLAMONIK ENCHANT

- Black curved glass fascia
- Enchanting smoky flame effect
- Colour changing back light with 4 settings
- Colour changing fuel bed with 4 settings
- Two heat settings up to 2kW

Dimensions (H x W x D)	441mm x 912mm x 126mm
Heat Output – High	2.0kW
Heat Output - Low	1.0kW
Safety	Thermal cut out
Remote Control	Yes
Mood Lighting	Yes



FLAMONIK ENCHANT Magenta



FLAMONIK ENCHANT Blue



FLAMONIK ENCHANT Amber



FLAMONIK ENCHANT Log Fuel Bed

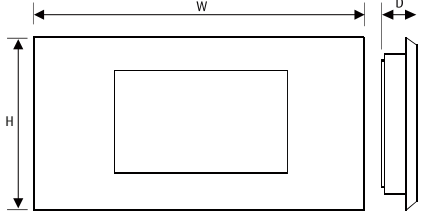

Please note: When installed there must be a minimum distance of 400mm between the bottom of the fire and the floor.



# FLAMONIK RAPTURE

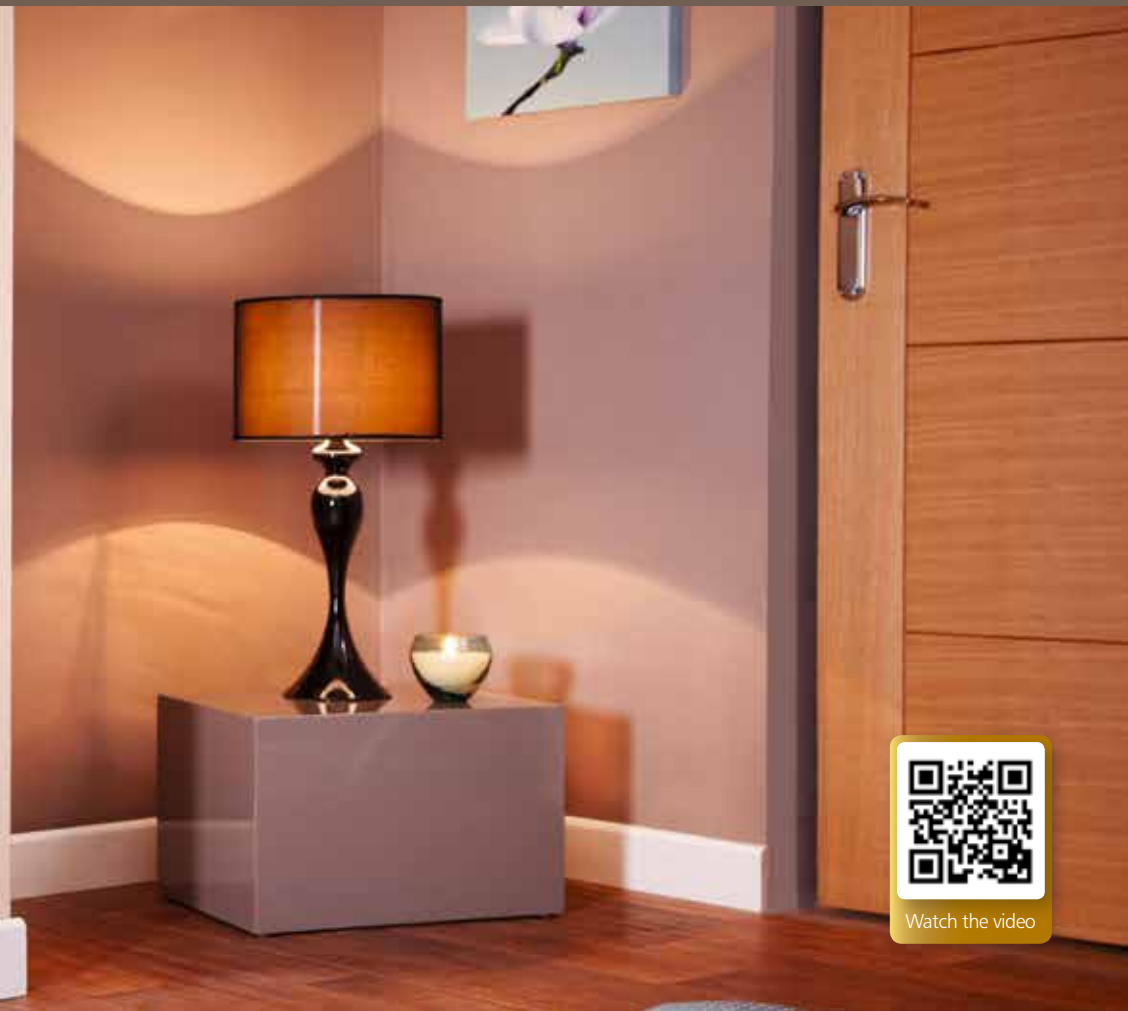

## FLAMONIK RAPTURE

- Black flat glass fascia
- Striking dancing flame effect
- Colour changing back light with 4 settings
- Colour changing fuel bed with 4 settings
- Two heat settings up to 2kW

Dimensions (H x W x D)	440mm x 686mm x 110mm
Heat Output – High	2.0kW
Heat Output - Low	1.0kW
Safety	Thermal cut out
Remote Control	Yes
Mood Lighting	Yes



FLAMONIK RAPTURE Magenta FLAMONIK RAPTURE Blue



FLAMONIK RAPTURE Amber

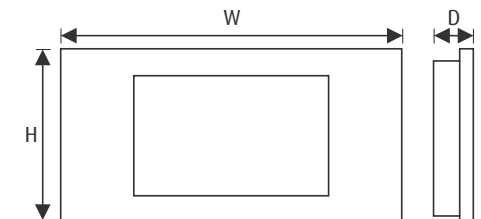

Please note: When installed there must be a minimum distance of 400mm between the bottom of the fire and the floor.



## ACCENT INFUSION

- Lively Ribbon Flame Effect
- Coal effect fuel bed
- Variable flame dimmer with three settings
- Two heat levels and a flame effect only option
- Operated via remote control handset or manual controls
- Up to 2kW heat output
- Available in a choice of brass, silver or black & chrome contemporary fascia
- 2 Year Guarantee



ACCENT INFUSION  
in Brass



ACCENT INFUSION  
in Black & Chrome

Dimensions (H x W x D)	595mm x 498mm x 75mm inset + 83mm fascia
Heat Output – High	2.0kW
Heat Output - Low	1.0kW
Safety	Thermal cut out
Remote Control	Yes
Available finishes	Brass, Silver or Black & Chrome

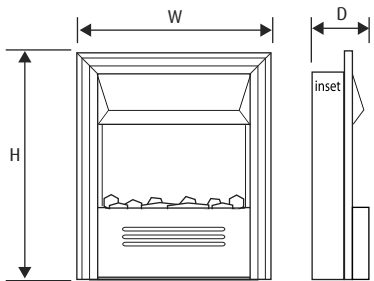

ACCENT INFUSION in Silver



Watch the video

ACCENT TRADITIONAL in Brass



Watch the video

## ACCENT TRADITIONAL

- Beautiful Ribbon Flame Effect
- Variable Flame Speed
- White and frosted stone fuel bed accompanied by a comforting under bed glow
- Up to 2kW heat output
- Available in a choice of brass effect or chrome
- 2 Year Guarantee

Dimensions (H x W x D)	595mm x 490mm x 75mm inset + 35mm fascia
Heat Output – High	2.0kW
Heat Output - Low	1.0kW
Safety	Thermal cut out
Remote Control	Yes
Available Finishes	Brass or Chrome



ACCENT TRADITIONAL  
in Silver

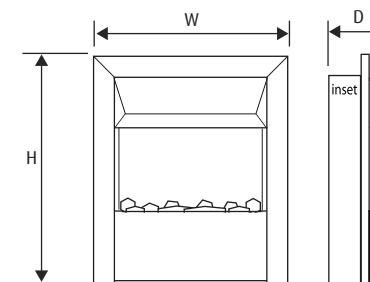

## ELECTRIC OUTSET RANGE

The Electric Outset fires use glowing radiant bars to create an uncanny resemblance to a gas outset radiant fire.

The Renaissance, Strata and Misermatic are timeless market leading designs now available regardless of whether you have a chimney or gas supply. The comforting radiant glow creates the perfect atmosphere to suit your mood, and soothing heat output creates a highly realistic experience.





## STRATA ELECTRIC

- 2kW heat output
- User friendly Electronic Top manual Control
- Glowing radiant fuel effect
- Variable Flame dimmer with 3 settings
- Choice of four colours

Dimensions (H x W x D)	530mm x 715mm x 210mm
Heat Output – High	2.0kW
Heat Output - Low	1.0kW
Safety	Thermal cut out
Manual Control	Yes
Available finishes	Black, Brown, White or Cream



STRATA in Black



STRATA in White



STRATA in Brown

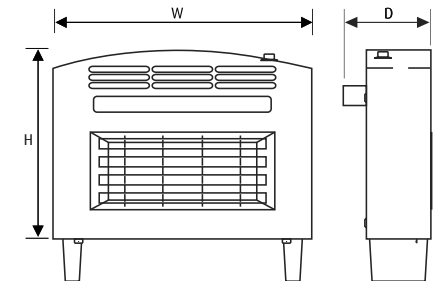



**MISERMATIC ELECTRIC**

- 2kW heat output
- User friendly Electronic Top manual Control
- Glowing radiant fuel effect
- Variable Flame dimmer with 3 settings
- Choice of five colours

Dimensions (H x W x D)	530mm x 800mm x 200mm
Heat Output – High	2.0kW
Heat Output - Low	1.0kW
Safety	Thermal cut out
Manual Control	Yes
Available finishes	Teak, Mahogany, Black, Medium Oak or Light Oak



MISERMATIC in Teak



MISERMATIC in Medium Oak



MISERMATIC in Mahogany



MISERMATIC in Black

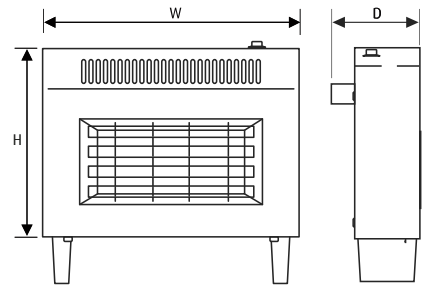

RENAISSANCE ELECTRIC in Silver



## RENAISSANCE ELECTRIC

- 2kW heat output
- User friendly Electronic Top manual Control
- Glowing radiant fuel effect
- Variable Flame dimmer with 3 settings
- Choice of two colours

Dimensions (H x W x D)	652mm x 730mm x 200mm
Heat Output - High	2.0kW
Heat Output - Low	1.0kW
Safety	Thermal cut out
Manual Control	Yes
Available Finishes	Silver or Black

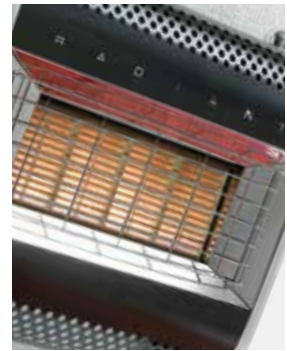

RENAISSANCE  
ELECTRIC in Black

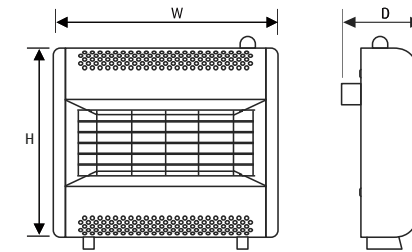



## SURROUNDS

Enhance the beauty of your Celsi fire with one of our striking stone surrounds.

Carved from luxury Honed Royal Botticino marble, a Celsi fireplace will fit perfectly with your existing décor and create a sophisticated feature in your home.

Honed Royal Botticino is a compound stone with a consistent pattern and beige colouring, and since it is manufactured from natural material every surround will have a unique appearance.



NOVA SURROUND

# AMOR SURROUND



The Amor surround features beautiful curves and is made from Royal Botticino marble. This surround is suitable for installation with any Puraflame, Electriflame or Accent hearth mounted electric fire.

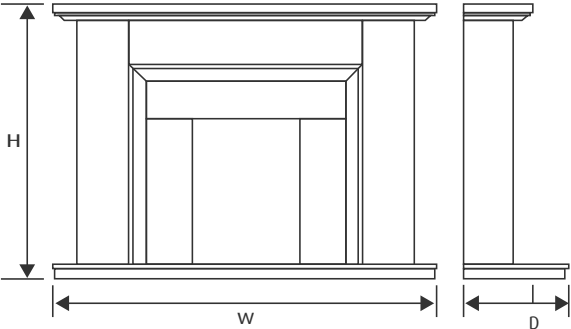

Dimensions (H x W x D) | **AMOR SURROUND**  
1060mm x 1370mm x 279-400mm

# ARRIA SURROUND



The Arria surround is based on the popular Tudor design and is made from Royal Botticino marble. This surround is suitable for installation with any Puraflame, Electriflame or Accent hearth mounted electric fire.

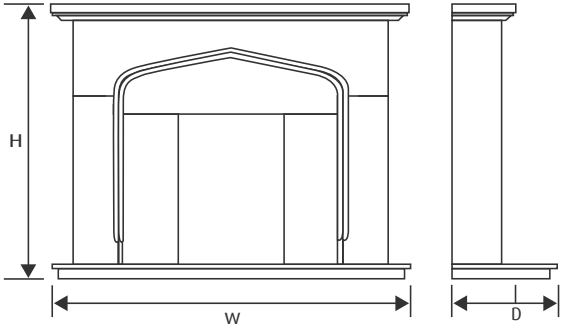

Dimensions (H x W x D) | **ARRIA SURROUND**  
1040mm x 1280mm x 180-380mm

## NOVA SURROUND



The Nova is a classically styled surround and is made from Royal Botticino marble. This surround is suitable for installation with any 16" Electrifiame or Accent hearth mounted electric fire.

Dimensions  
(H x W x D)

**NOVA SURROUND**  
1053mm x 1210mm  
x 239-400mm

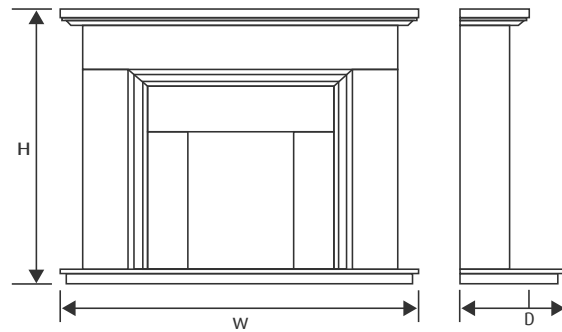

## RUBI SURROUND



The Rubi is a petite surround which is ideal for small living areas and is made from Royal Botticino marble. This surround is suitable for installation with any 16" Electrifiame or Accent hearth mounted electric fire.

Dimensions  
(H x W x D)

**RUBY SURROUND**  
930mm x 1000mm  
x 160-300mm

