

YOUR NO.1 CONTROLS DISTRIBUTOR



T H E P R I C E G U I D E

**THE
INDEPENDENTS'
INDEPENDENT**





Products for a wide range of applications

We provide, without doubt, the most comprehensive choice of ventilation systems available in the UK.

The Airvent range covers air movement, ventilation technologies and commercial hand dryers, along with whole house extraction systems for residential, commercial, public sector and industrial applications.



For the full Airvent range contact H&V today

WWW.HAV.CO.UK



 ADEY 06	 elson 51	 POTTERTON 90
 airvent 08	 ESI 52 <small>Energy Saving Innovative Controls Limited</small>	 REDRING 92
 altecnic 14 <small>Caleffi group</small>	 FERNOX 54 <small>MAKES WATER WORK</small>	 RWC 96
 aquabion 15	 Flamco 56	 SALUS 109 <small>CONTROLS</small>
 ARISTON 16	 GRUNDFOS 58	 SENTINEL 98
 Baker 17	 heatmiser 60	 SIEMENS 100
 BoilerMag 18	 HEATRAESADIA 62 <small>SMARTER CLEANER WARMER</small>	 SPIROTECH 102
 BWT 19 <small>BEST WATER TECHNOLOGY</small>	 Honeywell Home 64	 Stizflow Heating & Fans 104
 Cal Mag 20	 H&V CHEMICALS 70	 SUNVIC 106
 CirculatingPumps 24	 HORSTMANN 71	 TIMEGUARD 110
 Cistermiser 25 <small>OUR WORLD IS WATER</small>	 Kidde 74 <small>United Technologies</small>	 TRITON 112
 Danfoss 26	 kudox 76	 wilo 114
 DELTA DORE 36	 Lightw@ve 77	 Xpelair 116 <small>AIR QUALITY INNOVATION</small>
 DEVI 39 <small>by Danfoss</small>	 LOWARA 78	 ZILMET 118
 DURACELL 40	 MYSON 80	 Zip 120
 Drayton 41	 nest 84	 Miscellaneous Products 124
 dyson 48	 PEGLER 86 <small>INTEGRATED PIPING SYSTEMS</small>	 Warranty Chart 128

Keep informed with our latest offers & brand introductions, just email:

info@hav.co.uk

Just include your Name, Title, Company, Email Address and Account No.

...and we'll do the rest

Visit our website to view the latest catalogue online!

www.hav.co.uk

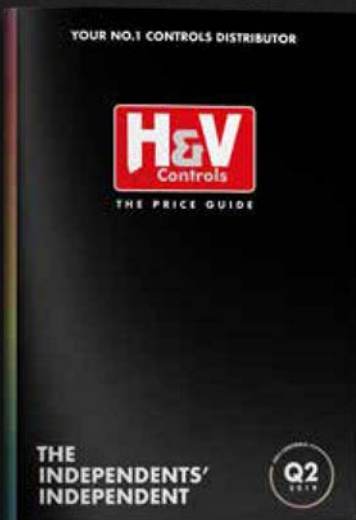

For more printed copies contact your local H&V Branch TODAY!

Roller banners and Catalogues available. Contact your local H&V Branch for Airvent point of sale material TODAY!



New from

These are our latest new product entries to the H&V Price Guide ...



altecnic
Caleffi group

Page 14

Honeywell Home

Page 68

Kidde
United Technologies

Page 74 & 75

LA-CO

Page 125

TRITON

Page 112

These are some of our updated product entries ...





































BoilerMag

Page 18

FERNOX
MAKES WATER WORK

Page 54

These and many other new product entries can be found throughout the price guide. **Just look out for the 'new' and 'product update' stickers!**

	Motorised zone valve 22mm 2 port	Motorised mid position valve 22mm 3 port	Full programmer 7day 5/2 day & 24h	Full timeswitch 7day 5/2 day & 24h
Danfoss	HP22 	HS3 	FP715Si 	TS715Si 
DELTA DORE Smart is the new power	N/A	N/A	TYBOX 827  Class IV 2%	N/A
Drayton	27100 	27101 	25474 - LP241 25475 - LP522 25476 - LP722 	25477 - LP111 25478 - LP711 
ESI Energy Saving Innovative Controls Limited	ESZV222L ESZV282N 	ESZV223 	ES1247B ES2247B ES3247B 	N/A
heatmiser	N/A	N/A	TM4 - TS 	TM1 
Honeywell Home	V4043H1056/U 	V4073A1039/U 	ST9400S1001 ST94001002 ST9400C1000 ST9500C1015 	ST9100A1008 ST9100S1007 ST9100C1006 
HORSTMANN	ZonePlus Z222 	ZonePlus Z322 	CentaurPlus C27 ServicePlus S27 ChannelPlus H27XL ChannelPlus H37XL ChannelPlus H47XL 	CentaurPlus C17 ServicePlus S17 ChannelPlus H17XL 
MYSON	MPE222 	MPE322 	MEP2c 	MEP1c 
SIEMENS	CZV222 	CMV322 	RWB29SI RWB2007 	RWB27SI RWB1007 
SUNVIC comfort in control	SZV2212 SZV2655 	SDV2211 	4973200 SUNPRO2000 	4973100 SUNPRO1000 

Wireless programmable room thermostat pack

Wireless room thermostat

Programmable 5/2 day room thermostat

Smart programmable

TP5000 SI-RF + RX1
TPOne BRF + RX1-S



Class IV
2%

RET2000B-RF



Class IV
2%

TPONE-B
TPONE-M



Class IV
2%

TPONE-S



Class IV
2%

TYBOX B+
TYBOX 137
TYBOX 147



Class IV
2%

TYBOX B+ (basic)
TYBOX 23
TYBOX 33
TYBOX 34



Class IV
2%

TYBOX 237



Class IV
2%

Six Connected
Packs available

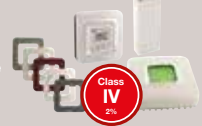

Class IV
2%

RF700 - Digistat +2RF
RF701 - Digistat +3RF



Class IV
2%

RF601 - Digistat+RF



Class IV
2%

22084 - Digistat +2
22083 - Digistat +3



Class IV
2%

Wiser Kits -
WT714R9K0902
WT724R9K0902
WT734R9K0902



Class VII
3.5%

ESRTP4RF



Class IV
2%

ESRTP5WIFILED
ESRTERFW



Class IV
2%

ESRTP5LED
ESRTP4



Class IV
2%

N/A

Slimline RF Kit V2
neoAir Bundle
neoKit 1 Gen 2
neoKit 2 Gen 2
neoKit-e Gen 2
neoAir Kit Gen 2



Slimline RF V2
neoAir



Slimline
Edge
Touch v2



neo
neoAir
neoAir Bundle
neoKits



CMT727D1016
Y3H710RF0053
Y4H910RF4003



Class V
3%

Y87RF2024
DT92E



Class V
3%

T4H110A1021
CMT707A1029
T3H110A0066



Class V
3%

Y6H910RW4022
Y6H910WF1011
Y6H920RW4026
ATP921R3100



Class V
3%

C-Stat 17-ZW
ThermoPlus AS2-RF



Class IV
2%

HRT4-ZW



Class IV
2%

C-Stat 17M
C-Stat 17B
ThermoPlus AS1
ThermoPlus AS2



Class IV
2%

N/A

MPRTRF



N/A

MPRT
TOUCH



T2WIFI



RDJ100RF/SET
REV24RF



RDH100RF/SET



REV24



RDS110



2227051
SUNSTATRF
2227052
SUNSTATRF SI



Class IV
2%

2306100
ESTATRF



Class IV
2%

2227001
SUNSTAT
2227002
SUNSTAT SI



Class IV
2%

2307000
WIFI S101



Class I
1%

Step up your performance and test the water with ADEY



Clean



MagnaCleanse



MagnaClean



Protect



Test



Maintain



Ask Europe's leading HVAC water treatment manufacturer how best practice works for you and your customers.



Cat No. Description List Price Disc Group

Cat No. Description List Price Disc Group

MagnaClean filters

MC chemical range

FL1-03-02028	FL1-03-01357	CP1-03-00022	FL1-03-01274
			
CP1-03-00022	Professional2, 22mm	179.64	201
FL1-03-01274	Micro2	161.71	201
FL1-03-01357	Professional2XP	261.22	201
FL1-03-02028	MagnaClean Dual XP 35mm/42mm	1109.00	201
CP1-03-00625	Professional2 chem pack - MC1+ & MC3+	226.22	201
FL1-03-01275	Micro2 chem pack - MC1+ & MC3+	202.47	201

					
MC1P	MC1 Protector	17.24	202		
CP1-03-00994	MC2 Silencer	24.53	202		
MC3C	MC3 Cleaner	16.02	202		
CP1-03-00998	MC4 Leak Sealer	24.53	202		
CP1-03-00999	MC5 RapidFlush System Cleaner	28.40	202		
CP1-03-01002	MC7 Biocide	33.40	202		

MagnaClean filters

				
CH1-03-01640	MC1+ Rapide 300ml	30.11	202	
CH1-03-02038	MC2+ Rapide 300ml	30.11	202	
CH1-03-01645	MC3+ Rapide 300ml	29.00	202	
CH1-03-02039	MC4+ Rapide 300ml	30.11	202	
CH1-03-02040	MC10+ Rapide 300ml	39.02	202	

MC22002	MCM22001	MCTT001	
			
MC22002	Professional, 22mm	167.33	201
MCM22001	Micro black	125.13	201
MCTT001	TwinTech	179.64	201

Water test kit

MagnaClean Commercial



	CP1-03-00626		
CP1-03-00626	Water test kit	62.53	201

MagnaCleanse RapidFlush filter

CP1-03-001123	MagnaClean Commercial 2"	3777.78	201
CP1-03-001124	MagnaClean Commercial 3"	4546.20	201
CP1-03-001125	MagnaClean Commercial 4"	5218.16	201
CP1-03-001126	MagnaClean Commercial 6"	9317.84	201

	MACK01		
MACK01	MagnaCleanse complete solution	827.40	201
VC002	VibraClean radiator agitator	109.31	201

Scale reducers

			
SR1-03-02794	MagnaScale 22mm compression	79.87	201
SR1-03-01978	ElectroScale 15mm compression	52.96	201



Tile Fan Range 100mm 4" Axial Fans

Cat No.	Model	m3/hr	Ltr/s	Watts	dB(A)@3m	List Price	Disc Group
442828	Tile fan 100mm	75	20	15	41	13.23	6402
442829	Tile fan 100mm plus timer	75	20	15	41	15.36	6402
442830	Tile fan 100mm plus humidistat	75	20	15	41	20.07	6402



Domestic Range 100mm 4" Axial - Toilet and Bathroom Fans

Cat No.	Model	m3/hr	Ltr/s	Watts	dB(A)@3m	List Price	Disc Group
457085A	Standard fan	88	24.44	16	32	9.81	6402
459299A	Standard fan plus pull cord	88	24.44	16	32	11.71	6402
457086A	Standard fan plus timer	88	24.44	16	32	12.25	6402
459294A	Standard fan plus humidistat plus pull cord	88	24.44	16	32	22.02	6402
459309A	Standard fan plus shutters and timer	88	24.44	20	32	21.15	6402
459318A	Standard fan plus humidistat and shutters	88	24.44	20	32	22.15	6402



Domestic Range 150mm 6" Axial - Kitchen Fans

Cat No.	Model	m3/hr	Ltr/s	Watts	dB(A)@3m	List Price	Disc Group
426566	Standard fan	245	68.06	25	45	16.23	6402
438170	Standard fan and pull cord	245	68.06	25	45	20.82	6402
438171	Standard fan and timer	245	68.06	25	45	23.32	6402
435103	Standard fan plus shutters and pull cord	245	68.06	30	45	28.49	6402
426568	Standard fan plus shutters and timer	245	68.06	30	45	28.77	6402



Quiet Fan Range 100mm 4" Axial Fans

Cat No.	Model	m3/hr	Ltr/s	Watts	dB(A)@3m	List Price	Disc Group
406957	Quiet fan 100mm	75	21	4.8	27	24.55	6402
406958	Quiet fan 100mm plus timer	75	21	4.8	27	30.68	6402
406959	Quiet fan 100mm plus humidistat	75	21	4.8	27	43.38	6402



Domestic Range 100mm 4" Shower Fan Kits

Cat No.	Model	m3/hr	Ltr/s	Watts	dB(A)@3m	List Price	Disc Group
434445A	In-line standard fan	85	23.61	14	41	18.41	6402
434446A	In-line standard fan plus timer	85	23.61	14	41	22.83	6402



Domestic Range 100mm 4" Shower Fan and Light Kit

Cat No.	Model	m3/hr	Ltr/s	Watts	dB(A)@3m	List Price	Disc Group
434448A	In-line standard fan plus timer complete with light kit, white and chrome bezels	85	23.61	14	41	49.67	6402



Domestic Range 100mm 4" Shower Fan and LED Light Kit

Cat No.	Model	m3/hr	Ltr/s	Watts	dB(A)@3m	List Price	Disc Group
477523	In-line standard fan plus timer complete with LED light kit, white and chrome bezels	86	24	10.4	41	78.80	6402



Domestic Range Part L Compliant 100mm 4" & 150mm 6" Inline Shower Fan Kits

Cat No.	Model	m3/hr	Ltr/s	Watts	dB(A)@3m	List Price	Disc Group
448385	100mm In-line standard fan	86	24	10	41	31.91	6402
448386	150mm In-line standard fan	227	63	20	40	41.56	6402



Domestic Range Part L Compliant 100mm 4" & 150mm 6" Inline Shower Fan & Light Kits

Cat No.	Model	m3/hr	Ltr/s	Watts	dB(A)@3m	List Price	Disc Group
448387	100mm In-line standard fan & light kit	86	24	10	41	56.97	6402
448388	150mm In-line standard fan & light kit	227	63	20	40	66.87	6402

Domestic Range Part L Compliant 100mm 4" & 150mm 6" Fans

Cat No.	Model	m3/hr	Ltr/s	Watts	dB(A)@3m	List Price	Disc Group
448379	100mm Standard fan	92	25.5	11	45	13.71	6402
448380	100mm Standard fan plus timer	92	25.5	11	45	17.40	6402
448381	100mm Standard fan plus humidistat	92	25.5	11	45	31.79	6402
448382	150mm Standard fan	230	63.89	18	40	26.24	6402
448383	150mm Standard fan plus timer	230	63.89	18	40	30.08	6402
448384	150mm Standard fan plus humidistat	230	63.89	18	40	42.34	6402

Domestic Range Part L Compliant Inline Mixed Flow Fan

Cat No.	Model	Speed	m3/hr	Ltr/s	Watts	dB(A)@3m	List Price	Disc Group
442825	In-line standard fan 45Ltr per second	High	244	67.78	25	24	77.22	6402
		Low	180	50	20	20		
442826	In-line standard fan 45Ltr per second plus timer	High	244	67.78	25	24	85.16	6402
		Low	180	50	20	20		
477638	100mm In-line mixed flow fan plus timer with LED shower & light kit	High	244	67.78	25	24	164.73	6402
		Low	180	50	20	20		

Domestic Range Part L Compliant 4" High Performance Centrifugal Fan

Cat No.	Model	m3/hr	Ltr/s	Watts	dB(A)@3m	List Price	Disc Group
AC100TN	Single speed fan with electronic over run timer	75	20.83	11	36	50.27	6402

Domestic Range Part F&L Compliant 100mm Low Watt 4" Continuous Running F/less Centrifugal Fan

Cat No.	Model	Speed	m3/hr	Ltr/s	Watts	dB(A)@3m	List Price	Disc Group
409737	Standard fan plus humidistat plus pull cord	Low			1.5	24	81.02	6402
		High			2.5	25.9		
		Boost			8	38.5		

Domestic Range Part F&L Compliant 100mm Low Watt SELV 4" Continuous Running F/less Centrifugal Fan

Cat No.	Model	Speed	m3/hr	Ltr/s	Watts	dB(A)@3m	List Price	Disc Group
409738	Standard fan plus humidistat plus pull cord	Low			1.5	24	104.00	6402
		High			2.5	25.9		
		Boost			8	38.5		

Low Profile Range 100mm 4" Low Profile (15mm) Axial and Low Voltage Axial

Cat No.	Model	m3/hr	Ltr/s	Watts	dB(A)@3m	List Price	Disc Group
431301	Standard fan	90	25	14	38	10.83	6402
431302	Standard fan plus timer	90	25	14	38	14.72	6402
404119	Standard fan plus timer, Chrome	90	25	14	38	19.61	6402
434399	Standard SELV 12V fan plus timer	90	25	23	38	35.07	6402

Low Profile Range 150mm 6" Low Profile (15mm) Slim Axial with Butterfly Shutters. IP44

Cat No.	Model	m3/hr	Ltr/s	Watts	dB(A)@3m	List Price	Disc Group
435403	Standard fan	228	63.33	16	45	18.42	6402
435404	Standard fan plus timer	228	63.33	16	45	21.50	6402
435405	Standard fan plus humidistat	228	63.33	16	45	33.99	6402





Flat Ducting

Cat No.	Model	List Price	Disc Group
100mm x 54mm Flat Ducting			
404120	Flat channel lengths 1m	4.04	6402
404121	Flat channel lengths 2m	7.07	6402
404122	Short round to rectangle adaptor male	1.24	6402
404123	Flat channel connector	0.83	6402
404124	Elbow bend 90° Male	1.36	6402
404125	Elbow bend 90° Female	1.79	6402
404126	Vertical 90° bend	1.72	6402
404127	Horizontal 90° bend	1.89	6402
404128	Horizontal air brick	1.82	6402
404129	Air brick grille	1.87	6402
404130	Flat channel clips pair	0.63	6402
404131	T Piece	4.54	6402
204mm x 60mm Flat Ducting			
404132	Flat channel lengths 1.5m	9.54	6402
404133	Horizontal 90° bend	4.79	6402
404134	Vertical 90° bend	3.38	6402
404135	Duct clip pair	2.80	6402
404136	Connector	2.17	6402
404137	Elbow bend 90° Male	4.39	6402
404138	Round to rectangle adaptor	4.37	6402
404139	Air brick connector and grille	3.23	6402
404140	T Piece	9.59	6402



Additional Accessories

Cat No.	Model	List Price	Disc Group
409736	100mm diameter 10m insulated ducting	28.20	6402
404141	PVC Flexible Ducting 100mm x 15m	13.00	6402
404142	PVC Flexible Ducting 100mm x 45m	36.69	6402
404143	100mm x 350mm ABS Pipe	1.75	6402
404144	100mm diameter Y Piece	2.78	6402
404145	150mm - 100mm Reducer	2.06	6402
404146	100mm Round Grille White	2.25	6402
404147	100mm Round Grille Chrome	4.45	6402



Multi Vent & Accessories

Cat No.	Model	List Price	Disc Group
478192	Continuous running whole house mechanical extract ventilation unit. 3 speeds, Low - 45 ltr/s, Medium - 85 ltr/s, High - 123 ltr/s.	144.33	6402
404150	PVC Flexible Ducting 125mm x 6m	6.51	6402
404153	60-215mm Worm drive hose clip	1.01	6402
404154	125mm Wall kit	6.69	6402



Heat Recovery Accessories

Cat No.	Model	List Price	Disc Group
404155	Extract diffuser	8.28	6402
404156	Supply diffuser	5.80	6402
404157	125mm x 90° Insulated bend	14.65	6402
404158	125mm x 2m Insulated pipe	32.51	6402
404159	125mm x 90° Uninsulated bend	8.38	6402
404160	125mm Uninsulated connector	4.53	6402
404161	125mm x 45° Insulated bend	10.66	6402
404162	125mm x 45° Uninsulated bend	8.38	6402
404163	125mm x 1.5m Ducting	8.75	6402



Commercial Range Ancillaries

Cat No.	Cat No.	Model	White	Brown	List Price	Disc Group
401897		PVC Ducting 3m 100mm			2.90	6402
401898		PVC Ducting 3m 150mm			6.81	6402
401903	401905	Gravity grille 100mm	401903	401905	2.25	6402
401904	401906	Gravity grille 150mm	401904	401906	4.16	6402
401907	401909	Fixed grille 100mm	401907	401909	2.25	6402
401908	401910	Fixed grille 150mm	401908	401910	4.16	6402
401899		Window fixing kit 100mm			9.56	6402
401900		Window fixing kit 150mm			13.40	6402
401901		Wall fixing kit 100mm			7.01	6402
401902		Wall fixing kit 150mm			9.21	6402

Automatic & Manual Hand dryers for Commercial Applications

1.1kW Compact Eco Swift

409733

White

409734

Satin Stainless Steel

409735

Polished Stainless Steel

- Intelligent sensing, element auto switch off when ambient temperature reaches 25°C, reducing the wattage of the dryer to 0.5kW
- 10-12 seconds drying time
- Infra Red Automatic
- H260xW180xD157mm



List Price

409733

£128.³⁹

409734/409735

£132.⁶⁶

Disc Group 6402

JETDRY Automatic
Double Sided
Hand Dryer

409393

- Lo-Carbon DC Motor 750W-2050W
- 99.9% HEPA Filter
- UV Sterilisation
- Approximately 10 seconds drying time
- LED indicator
- Removable drip tray
- Air speed 95m/s
- Antibacterial coating
- IXP4 Rated
- H700xW300xD225mm



List Price

£610.⁰²

Disc Group 6402

1.6kW Tornado Hand Dryer

437656

White

437659

Polished Stainless Steel

437661

Satin Stainless Steel

- 10-12 seconds drying time
- Blue LED for hand drying range
- Powerful operation
- Power usage adjustable to 0.9kW by switching off the element
- Save up to 70% on energy costs
- H277xW201xD175mm



List Price

437656

£290.⁶⁹

437659/437661

£341.⁷⁶

Disc Group 6402

2.3kW Automatic Hand Dryer

477639

White

477640

Polished Stainless Steel

- 70dba at 1m
- Approximately 23 seconds drying time
- Blue LED 'Dryzone' Indicator
- Chrome plated nozzle
- H237xW270xD208mm



List Price

477639

£150.⁶²

477640

£153.⁷⁷

Disc Group 6402

1.5kW Automatic Hand Dryer

429022

Gloss White



- Approximately 30 seconds drying time
- Quiet Operation
- Hygienic
- H275xW225xD160mm

List Price

£77.⁹⁴

Disc Group 6402

1.0kW Automatic Eco Fast Dryer

444769

Epoxy Coated



- 1.2mm thick steel cover
- Intelligent sensing, element auto switch off when ambient temperature reaches 25°C
- Element adjustable down to 0.5kW
- Approximately 13 seconds drying time
- Infra Red Automatic
- H180xW250xD138.5mm

List Price

£206.¹⁵

Disc Group 6402

2.0kW Automatic Hand Dryer

429021

Aluminium
Cover



- Die Cast Aluminium Cover painted white gloss
- Approximately 30 seconds drying time
- Quiet Operation
- Hygienic
- H275xW225xD160mm

List Price

£104.⁵⁷

Disc Group 6402

2.0kW Automatic Hand Dryer

441356

Stainless
Steel



- Satin polished stainless steel cover
- Approximately 28 seconds drying time
- Quiet Operation
- Hygienic
- H280xW270xD148mm

List Price

£192.⁵⁹

Disc Group 6402

2.4kW Manual Heavy Duty

441098

White



- 2.00mm thick steel cover
- Approximately 26 seconds drying time
- Powerful Operation
- Chrome plated nozzle
- H248xW284xD202mm

List Price

£248.⁷⁵

Disc Group 6402

2.4kW Automatic Heavy Duty

401936

Hand & Face
Dryer



- Approximately 30 seconds drying time
- LM24 pressure die cast aluminium
- Powerful operation
- H264xW275xD177mm

List Price

£185.³⁴

Disc Group 6402

Commercial Range 125mm In-line Mixed Flow Fan

Cat No.	Model	Speed	m3/hr	Ltr/s	Watts	dB(A)@3m	List Price	Disc Group
477633	In-line standard fan	High	310	86	33	35	97.59	6402
		Low	240	67	28	31		
477634	In-line standard fan plus timer	High	310	86	33	35	105.06	6402
		Low	240	67	28	31		

Commercial Range 150mm In-line Mixed Flow Fan

Cat No.	Model	Speed	m3/hr	Ltr/s	Watts	dB(A)@3m	List Price	Disc Group
477635	In-line standard fan	High	500	138	48	35	109.13	6402
		Low	400	111	42	31		
477636	In-line standard fan plus timer	High	500	138	48	35	116.05	6402
		Low	400	111	42	31		

Commercial Range 230mm 9" and 300mm 12" Axial Fans

Cat No.	Model	Speed	m3/hr	Ltr/s	Watts	dB(A)@3m	List Price	Disc Group
401893	230mm 9" Standard fan plus auto shutters 259Ltr/sec	High	932	258.89	90	52	138.97	6402
		Low	684	190	90	51		
401891	230mm 9" Standard fan with fixed grille 259Ltr/sec	High	932	258.89	90	52	112.83	6420
		Low	684	190	90	51		
401896	300mm 12" Standard fan plus auto shutters 415Ltr/sec	High	1494	415	100	53	182.90	6420
		Low	961	266.94	100	52		
401894	300mm 12" Standard fan with fixed grille 415Ltr/sec	High	1494	415	100	53	154.39	6420
		Low	961	266.94	100	52		
401940	Window kit for 230mm						23.94	6420
401941	Window kit for 300mm						31.69	6420

Commercial Range Fan Controller

Cat No.	Model	List Price	Disc Group
401961	2 Speed + off. Reversible	33.43	6420

For our full range of Airvent hand dryers

see page 11



A SPECIALIST IN HEATING
CONTROLS | PUMPS | CHEMICALS

**THE
INDEPENDENTS'
INDEPENDENT**



Massive Stocks | Next Day Deliveries | Knowledgeable Staff | Best Prices

WWW.HAV.CO.UK

CAT. NO. DESCRIPTION PRICE DISC. GROUP

Auto Air Vents

	502040	1/2" Minical auto air vent	11.55	801
	502630	3/8" Robocal auto air vent no check valve	10.16	801
	502649	15mm Robocal auto air vent	10.52	801

Safety Pressure Relief Valves

	311430	Safety valve without gauge 1/2" F/F 3 bar	10.93	801
	311460	Safety valve without gauge 1/2" F/F 6 bar	12.63	801
	312430	Safety valve without gauge 1/2" M/F 3 bar	12.63	801
	313430	Combined safety valve and gauge 1/2" F/F 3 bar	24.32	801
	513460	Safety valve without gauge 1/2" F/F 6 bar	20.10	801

Pressure Gauges

	WI-557104	0-4 bar 1/4" 50mm centre back connection	15.72	801
	WI-557304	0-4 bar 1/4" 50mm bottom connection	15.72	801
	WI-557306	0-6 bar 1/4" 50mm bottom connection	19.29	801
	WI-557310	0-10 bar 1/4" 50mm bottom connection	19.29	801

Pressure Reducing Valves

	533641H	PRV 15mm 1.0 - 5.5bar no pressure gauge port	53.32	801
	533651H	PRV 22mm 1.0 - 5.5bar no pressure gauge port	57.10	801
	533841H	PRV 15mm 1.0 - 5.5bar with pressure gauge	62.20	801
	533851H	PRV 22mm 1.0 - 5.5bar with pressure gauge	65.98	801
	533861H	PRV 28mm 1.0 - 5.5bar with pressure gauge	102.89	801
	ER-PRV1522	PRV 15mm x 22mm with gauge	24.60	801

Check Valves & Flow Regulators

	303615	15mm Double check with integral isolating valve	25.48	801
--	--------	---	-------	-----

Tundishes

	AP-400003	3/4"M x 1/2"F outlet straight plastic tundish	9.68	801
	AP-400010	15mm x 22mm outlet straight plastic tundish	11.47	801
	AP-400011	22mm x 28mm outlet plastic tundish	14.34	801

Sealed System Accessories

	RS-MB	Vessel mounting bracket 8 litre - 25 litre heating vessels	8.20	801
	RS-MB2	Vessel mounting bracket with strap	21.65	801

Water Meters

	GG-3005F20	3/4" Single Jet Water Meter	91.01	801
	GG-3003F13	1/2" Single Jet Water Meter	81.01	801

Filling Loops

	CA-300001	Robofil fill loop complete with PRV	104.02	801
	CA-300606	Ecofil plus filling loop (G24 approved)	18.43	801
	ALT-ST0035	Filling loop with pressure gauge	28.30	801

Thermostatic Mixing Valves

	CA-100822	TMV 2&3 fail-safe TMV30-50°C 15mm	95.11	801
	CA-100824	TMV 2&3 fail-safe TMV30-50°C 22mm	129.60	801

Auto By-pass Valves

	519002GLW	Auto by-pass valve 22mm	56.65	801
	ER-22MMSTRBI	Differential by-pass 22mm - Straight	22.94	801
	ER-22MMANGBI	Angled by-pass valve 22mm	15.13	801
	ER-28MMANGBI	Angled by-pass valve 28mm	18.54	801
	ER-28MMSTRBI	Straight by-pass valve 28mm	25.46	801

Shock Arrester

	PV016RS	15mm 0.16L Shock Arrester	53.91	801
---	---------	---------------------------	-------	-----

Thermostatic Radiator Valves

	200425 LTC	Ecocal 15mm angled TRV	22.62	801
	200445 LTC	Ecocal 15mm angled twin pack	33.50	801

Manual Radiator Valves

	410415LTC	Eclipse 15mm angle c/w lockshield & wheelhead caps	10.81	801
	YU-JQAL213HC	Eclipse radiator valve drain off tail piece	7.92	801
	YU-JQAL024LC	15mm Straight Modern Pair	31.17	801
	YU-JQAL025LC	15mm Angled Modern Pair	31.17	801
	ER-15MMVAL	15mm Angled White 1/2" Nut	3.21	801
	YU-JQAL029LC	15mm Angled modern pair	29.84	801

Aquabion® Conditioners The alternative to softeners

Over 100,000 people have chosen Aquabion® over a salt based water softener. Stand up to limescale, join the revolution and sell Aquabion®

- No maintenance, just change every 5* to 7 years
- Nothing to go wrong, no electric, no moving parts and no magnets
- No corrosion, no worries
- ALL boilers and ALL appliances are safe with Aquabion® units
- No online competition
- POS available on request
- 5 year warranty
- Unique patented self cleaning action

The patented **AQUABION®**

- No need for:
- Power connection
 - Regular maintenance
 - Chemicals or magnets

The **AQUABION®** does not make the water soft

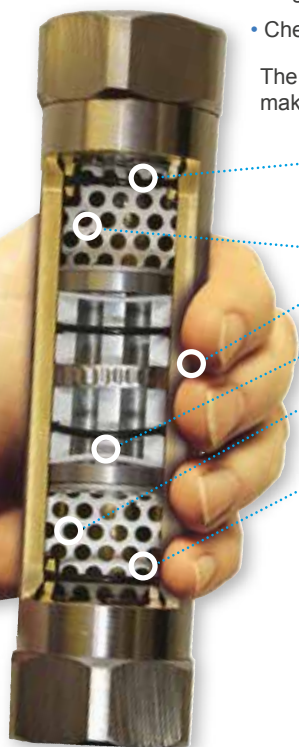

- Special swirl body made of Nirosta steel
- Electrolyte water
- Special metal housing
- High-purity zinc active anode
- Pressure resistance up to 16 bar **PN 16**
- Reusable materials according to the new German Drinking Water Ordinance

Materials tested by German Technical Control Board and the German Technical and Scientific Association for Gas and Water



- Limescale reduction guaranteed
- Great profit from each sale
- Uses zinc NO salt
- Easy installation
- Precision German engineering
- Putting limescale in its place

Cat No.	Description	List Price	Disc Group
Commercial			
H20	¾" Water Conditioner	1050.00	1212
H25	1" Water Conditioner	1602.80	1212
H32	1¼" Water Conditioner	2408.52	1212
H40	1½" Water Conditioner	2965.14	1212
H50	2" Water Conditioner	4567.35	1212
Domestic			
S15	½" Water Conditioner	357.20	1212
S20	¾" Water Conditioner	525.30	1212
AQUABIONMINIS	Shower Conditioner (mini)*	85.68	1212
AQUABIONMINIW	Washing Machine Conditioner (mini)*	130.00	1212



Quality
Made in Germany



ACS

DVGW
W 270

The next generation in limescale prevention



ANDRIS LUX^{10 15 30}

New Generation of Europrisma

UNDER/OVER SINK UNVENTED ELECTRIC WATER HEATER

- Improved performance, efficiency and durability
- Installation in 10 easy steps
- Copper heating element (nickel free) with faster heat up times

OVERSINK MODEL

CAT NO.	MODEL	List Price	Disc Group
3100302	10L O/Sink 3kW	186.00	6101
3100308	15L O/Sink 3kW	212.00	6101
3820017	30L O/Sink 3kW (including Kits A, B & C)	527.00	6101

UNDERSINK MODEL

CAT NO.	MODEL	List Price	Disc Group
3100303	10L U/Sink 3kW	186.00	6101
3100306	10L U/Sink 2kW	160.00	6101
3100309	15L U/Sink 3kW	212.00	6101
3100310	15L U/Sink 2kW	178.00	6101

ANDRIS LUX INSTALLATION ACCESSORIES

In order to fit an Ariston Andris Lux it is good practice and sometimes mandatory to install one or several of the following kits:

KIT A



Expansion Vessel & Non-return Valve

KIT B



3.5 Bar Pressure Reducing Valve

KIT C



Discharge Tundish

CAT NO.	MODEL	List Price	Disc Group
406801	Kit A	50.00	6102
406802	Kit B	40.00	6102
406807	Kit C	10.00	6102

ARISTON

10
YEAR
WARRANTY



PICCOLO

Wall mounted electric point of use water heater

CAT NO.	MODEL	List Price	Disc Group
3100525	Piccolo 2kW	125.00	6101

25
YEAR
WARRANTY
ON TANK



CLASSICO

High efficiency floor standing direct and indirect unvented cylinders

CAT NO.	MODEL	List Price	Disc Group
3060398	Classico STD 125 HE*	608.00	6102
3060399	Classico STD 150 HE*	629.00	6102
3060400	Classico STD 210 HE*	681.00	6102
3060401	Classico STD 300 HE*	866.00	6102
3060402	Classico STD 500 HE*	1514.00	6102
3060379	Classico STI 125 HE*	730.00	6102
3060380	Classico STI 150 HE*	756.00	6102
3060381	Classico STI 210 HE*	834.00	6102
3060382	Classico STI 300 HE*	959.00	6102

10
YEAR
WARRANTY



ST100

Wall-hung unvented water heater

CAT NO.	MODEL	List Price	Disc Group
3820016	ST 100*	623.00	6101

*Includes Control Kit

HOT WATER | HEATING | RENEWABLES
ariston.com/uk/andrislux

 @AristonUK  /AristonUK  /AristonThermo



The "BACKERSAFE" Immersion heaters are manufactured in a full range of sheath materials including Copper, Incoloy 800, Incoloy 825 and Titanium to suit the varying water conditions around the country



Cat No.	Description	List Price	Disc Group
---------	-------------	------------	------------

Copper Sheath Range

Backersafe			
09192VS	11" Immersion heater with 7" thermostat	33.59	1201
09193VS	14" Immersion heater with 11" thermostat	38.71	1201
09194VS	18" Immersion heater with 11" thermostat	38.71	1201
09195VS	23" Immersion heater with 18" thermostat	43.48	1201
09182VS	27" Immersion heater with 18" thermostat	37.73	1201
09196VS	30" Immersion heater with 18" thermostat	42.77	1201
09197VS	36" Immersion heater with 18" thermostat	47.58	1201



Cat No.	Description	List Price	Disc Group
---------	-------------	------------	------------

Anti-Corrosive Range

Backersafe			
09733VS	11" Backerloy immersion heater with 7" thermostat	44.59	1201
09009VS	14" Backerloy immersion heater with 11" thermostat	49.40	1201
09021VS	18" Backerloy immersion heater with 11" thermostat	59.92	1201
09022VS	23" Backerloy immersion heater with 18" thermostat	60.14	1201
09734VS	27" Backerloy immersion heater with 18" thermostat	48.02	1201
09023VS	30" Backerloy immersion heater with 18" thermostat	61.96	1201
09024VS	36" Backerloy immersion heater with 18" thermostat	61.65	1201



Cat No.	Description	List Price	Disc Group
---------	-------------	------------	------------

Low Watts Anti-Corrosive Range

Backersafe			
09801VS	11" 825 Backerloy immersion heater with 7" thermostat	56.40	1201
09802VS	27" 825 Backerloy immersion heater with 18" thermostat	63.26	1201



Cat No.	Description	List Price	Disc Group
---------	-------------	------------	------------

Titanium Range

Backersafe			
09015VC	11" Titanium immersion heater with 7" thermostat	127.58	1201
09016VC	14" Titanium immersion heater with 11" thermostat	137.02	1201
09017VC	27" Titanium immersion heater with 18" thermostat	145.48	1201



Cat No.	Description	List Price	Disc Group
---------	-------------	------------	------------

Thermostats

Backermatic			
13200J	BMST 7" Thermostat	17.78	1202
13201J	BMST 11" Thermostat	19.11	1202
13203J	BMST 18" Thermostat	22.05	1202

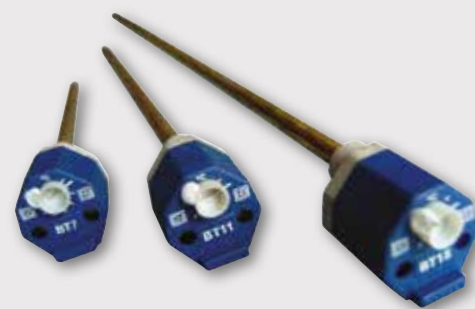

Cat No.	Description	List Price	Disc Group
---------	-------------	------------	------------

Thermostats

Backermatic			
13081J	BT7 7" Thermostat	9.67	1202
13082J	BT11 11" Thermostat	10.56	1202
13083J	BT18 18" Thermostat	11.27	1202



High performance at Excellent prices

BoilerMag offers:

- The market's biggest magnetic core
- Easy in-line installation
- High performance dirt removal
- Removal of sludge and scale



BoilerMag Domestic

Cat. No	Description	List Price	Disc Group
BM22	BoilerMag 22mm	108.16	3950
BM28	BoilerMag 28mm	119.60	3950

Try our Part L & Chemical Packs



GREAT VALUE!

BoilerMag Filter & Chemical Packs

Cat. No	Description	List Price	Disc Group
BM22/CP	22mm filter, BM1 Inhibitor, BM3 Cleaner	121.68	3950

BoilerMag Part L Compliance Packs

Cat. No	Description	List Price	Disc Group
BM22/PLCK	22mm filter, BM1 Inhibitor, BM3 Cleaner, BMESR	154.96	3950

BoilerMag Treatment Chemicals

Cat. No	Description	List Price	Disc Group
BM1	BM1 Inhibitor 500ml	10.19	3950
BM3	BM3 Cleaner 500ml	10.19	3950



BWT

BEST WATER TECHNOLOGY

BWT WATER SOFTENERS

WS Series Premium Water Softeners

WARRANTY:
2-YEAR @HOME
LABOUR AND
5-YEAR PARTS



WS355 14L Electric

WS355HF 14L Electric Hi Flow

- ✓ Easy to install and set up
- ✓ Free @home commissioning
- ✓ Free product support

Cat No.	List Price	Disc Group
WS355	733.52	1901
WS355HF	782.46	1901



Choose **BWT**

Say no to limescale

COMPACT ELECTROLYTIC SCALE INHIBITOR

Limebeater Electrolytic Scale Inhibitor

5 YEAR
GUARANTEE

- ✓ Compact design for easier installation
- ✓ All metal construction for durability
- ✓ Suitable for cold and hot water supplies

LBC2-15V2 15mm Limebeater (compression)

LBC2-22V2 22mm Limebeater (compression)

LBP2-15 15mm Limebeater (push-fit)

LBP2-22 22mm Limebeater (push-fit)

Cat No.	List Price	Disc Group
LBC2-15V2	43.97	1901
LBC2-22V2	46.46	1901
LBP2-15	55.08	1901
LBP2-22	61.84	1901



ELECTRONIC WATER CONDITIONER

Wrappa 2 Electronic Water Conditioner

LW2 Wrappa 2



- ✓ Simple installation (no need to cut pipe)
- ✓ Works on most pipe material and sizes incl. plastic
- ✓ No maintenance required

Cat No.	List Price	Disc Group
LW2	105.83	1901

COMPACT MAGNETIC SCALE INHIBITOR

Limefighter Magnetic Scale Inhibitor

5 YEAR
GUARANTEE

- ✓ Compact design for easier installation
- ✓ All metal construction for durability
- ✓ Suitable for cold and hot water supplies

LFC2-15V2 15mm Limefighter (compression)

LBC2-22V2 22mm Limefighter (compression)

Cat No.	List Price	Disc Group
LFC2-15	44.21	1901
LFC2-22	51.01	1901



POLYPHOSPHATE DOSING SYSTEM

Combi-Care Polyphosphate Dosing System

AC002400 Replacement Cartridge

AC002100 15mm Combi-Care

AC002200 22mm Combi-Care



- ✓ Offers protection from limescale and corrosion
- ✓ 12 month cartridge life
- ✓ Whole house or single appliance protection

Cat No.	List Price	Disc Group
AC002400	37.02	1901
AC002100	75.55	1901
AC002200	97.28	1901

Enjoy the benefits of softened water

with Calmag's range of units

ESSENTIAL FOR ENERGY SAVINGS

CalSoft Mini >

12.5 litre vessel
1-8 people



CalSoft Midi >

18 litre vessel
1-11 people



CalSoft Maxi >

25 litre vessel
1-15 people



Dimensions

	CALSOFT MINI	CALSOFT MIDI	CALSOFT MAXI
A	470mm	470mm	470mm
B	660mm	900mm	1100mm
C	330mm	330mm	330mm

Please note these dimensions are approximations and should be checked depending where the installation will be carried out i.e. in a confined area. Dimensions do not include pipework dimensions

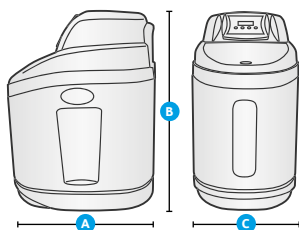

Benefits

- ✓ Compact and easy to install under kitchen sinks
- ✓ Low salt consumption
- ✓ Low volume of cleansing water – less than conventional softeners
- ✓ Commissioning service available
- ✓ Regular cleansing cycle will keep the resin in prime condition
- ✓ Suitable for installation in garages, cupboards and loft space
- ✓ Low salt consumption - saltsaver can use any type of salt; block or tablet.
- ✓ Little programming required - no flashing lights or confusing digits

5 YEAR PARTS GUARANTEE

Installation Kits

The standard 1/2"/15mm installation kits are suitable for homes with a cold water storage tank. If however, your home has a combination boiler or direct hot water system we recommend the installation of our high flow 3/4"/22mm installation kit. Each kit comes with inlet valve, outlet valve, bypass valve, washers and 2 x stainless steel hoses. We use stainless steel full bore hoses for maximum flow rates.



1/2" / 15MM KIT

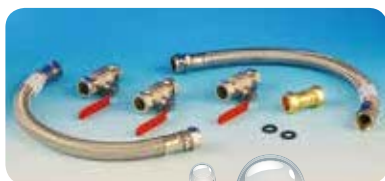

3/4" / 22MM KIT

	CALSOFT MINI	CALSOFT MIDI	CALSOFT MAXI
Fits under a sink	YES	NO	NO
Parts guarantee	5yr	5yr	5yr
Metered	YES	YES	YES
No of people	1-8	1-11	1-15
Capacity per regeneration @300ppm	2000 litres	3000 litres	4000 litres
All domestic situations	YES	YES	YES
Salt used per regen (approx)	2kg	2.8kg	3.5kg
Water used per regen (approx)	85 litres	115 litres	202 litres

CAT NO.	DESCRIPTION	LIST PRICE	DISC GROUP
WS-CALSOFT-MINI	Metered unit 1-8 people	779.50	3506
WS-CALSOFT-MIDI	Metered unit 1-11 people	1155.80	3504
WS-CALSOFT-MAXI	Metered unit 1-15 people	1209.56	3504
WS-INSTALL KIT	15mm stainless install kit	65.70	3506
WS-HFK	22mm stainless high flow kit	105.20	2001

Scale inhibitors

- ✔ Lifetime guarantee
- ✔ No maintenance
- ✔ Environmentally friendly
- ✔ No chemicals
- ✔ Combination products
- ✔ Models to suit all applications

Magnetic Units



LIFETIME GUARANTEE

WRAS APPROVED PRODUCT

CAT NO.	CONNECTION TYPE	CONNECTION SIZE	MAX TEMP °C	MAX PRESSURE (BAR)	SINGLE APPLIANCE OR WHOLE HOUSE PROTECTION	LIST PRICE	DISC GROUP
SI-CALMAG	Compression	15mm	80°C	12	Whole House	46.17	3506
SI-CALMAG-22	Compression	22mm	80°C	12	Whole House	48.76	3506
SI-CALMAG-PF	John Guest Speedfit	15mm & 22mm	40°C	12	Whole House	52.59	3504

Electrolytic Units

CalLytic



5 YEAR GUARANTEE

WRAS APPROVED PRODUCT

CAT NO.	CONNECTION TYPE	CONNECTION SIZE	MAX TEMP °C	MAX PRESSURE (BAR)	SINGLE APPLIANCE OR WHOLE HOUSE PROTECTION	LIST PRICE	DISC GROUP
SI-CALLYTIC-MINI	John Guest Speedfit	15mm & 22mm	40°C	12	Whole House	55.47	3504
SI-CALLYTIC-15	Compression	15mm	80°C	12	Whole House	53.34	3504
SI-CALLYTIC-22	Compression	22mm	80°C	12	Whole House	57.14	3504

Magnetic & Electrolytic Units

CalCombi

CalGlow



LIFETIME GUARANTEE

WRAS APPROVED PRODUCT

CAT NO.	CONNECTION TYPE	CONNECTION SIZE	MAX TEMP °C	MAX PRESSURE (BAR)	SINGLE APPLIANCE OR WHOLE HOUSE PROTECTION	LIST PRICE	DISC GROUP
SI-CALCOMBI	John Guest Speedfit	15mm & 22mm	40°C	12	Whole House	69.46	3506
SI-CALCOMBI-MINI	John Guest Speedfit	15mm & 22mm	40°C	12	Whole House	60.12	3506
SI-GLOW 15	Compression	15mm	80°C	12	Whole House	46.93	2001
SI-CALGLOW	Compression	22mm	80°C	12	Whole House	58.72	3504

Electrolytic Units

WRAS approval is not required on any unit which is classed as a "wrap-around" due to the fact that no materials are in direct contact with POTABLE water



CALTRONIC

CAT NO.	CONNECTION TYPE	CONNECTION SIZE	LIST PRICE	DISC GROUP
SI-CALTRONIC	Compression	15mm & 42mm	103.92	3504

MAX TEMP °C	MAX PRESSURE (BAR)	SINGLE APPLIANCE OR WHOLE HOUSE PROTECTION
40°C	12	Whole House

LIFETIME GUARANTEE

Polyphosphate Units

CalPhos

BUY WITH CONFIDENCE



CAT NO.	CONNECTION TYPE	LIST PRICE	DISC GROUP
SI-CALPHOS	Compression	165.82	2001

CONNECTION SIZE	MAX TEMP °C	MAX PRESSURE (BAR)	SINGLE APPLIANCE OR WHOLE HOUSE PROTECTION
15mm	40°C	7	Single Appliance

CALPHOS 15

Chemical range

Key features guide



KEY FEATURES	CAT NO.	DESCRIPTION	LIST PRICE	DISC GROUP
<ul style="list-style-type: none"> Heavy duty inhibitor Protects against corrosion and limescale Suitable for all system needs Ensures optimum system efficiency Test kits available BuildCert approved available 	CHEM-CM100	1 litre Buildcert Inhibitor	14.38	3505
	CHEM-PROTECTOR-1L	1 litre Inhibitor	9.14	3505
	CHEM-CP100-500	500ml Inhibitor	7.80	3505
	CHEM-BC-CM100-500	500ml Buildcert Inhibitor	10.33	3505
	CHEM-CALRAD	125ml Inhibitor for towel radiators	3.73	2001
<ul style="list-style-type: none"> Powerful cleanser Suitable for new and old systems Cleans sludge, flux, and installation debris 	CHEM-CLEANSER	1 litre Cleanser	9.14	3505
	CHEM-CC300-500	500ml Cleanser	7.80	3505
<ul style="list-style-type: none"> Noise and silencer Moves particles of silt, sand, sludge, and more Suitable for new and old systems Breaks down iron oxide Eliminates cold spots on radiators Restores systems with circulating problems 	CHEM-SILENCER-1L	1 litre Silencer	9.14	3505
	CHEM-CS500-500	500ml Silencer	7.80	3505
<ul style="list-style-type: none"> Descales systems Eliminates kettling Quick dissolving action Dissolves limescale and corrosion deposits 	CHEM-DESCALER	1 litre Descaler	9.14	3504
	CHEM-CD200-500	500ml Descaler	7.80	3505
<ul style="list-style-type: none"> Seal inaccessible leaks and weeping joints Avoids costly repairs Will not block pumps, valves, or air vents Seals in 24 hours Compatible with all system materials 	CHEM-SEALER-1L	1 litre Leak Sealer	15.88	3505
	CHEM-CS400-500	500ml Leak Sealer	10.33	3505
<ul style="list-style-type: none"> Anti-freeze Protection to -24°C at 40% solution Compatible with all metals Anti-bacterial Corrosion inhibitor included in the formula Recommended for all solar systems 	ANTI-FREEZE-5L	5 litre Anti -freeze	53.20	2001
	ANTI-FREEZE-25L	25 litre Anti-freeze	266.03	2001
<ul style="list-style-type: none"> All in one universal product Controls sludge, flux and other debris Prevents boiler noise Prevents pump seizure Protects against corrosion and limescale "Leave in system" formula Unique formula flocculates particles Compatible with all metals Use when standard treatment is not feasible 	CHEM-CALCHEM	1 litre Universal Chemical	14.77	3504
<ul style="list-style-type: none"> Universal applicator for chemicals 	CHEM-UNI-DOSE	Universal doser complete with all adaptors	8.79	3505

HEATING PACKS

HEAT PACK A



Includes heating filter, 500ml BuildCert inhibitor & 500ml cleanser

CAT NO.	LIST PRICE	DISC GROUP
CHEM-HTG-PACK-A	81.27	3505

HEAT PACK B



Includes heating filter, 500ml BuildCert inhibitor, 500ml cleanser & filling loop

CAT NO.	LIST PRICE	DISC GROUP
CHEM-HTG-PACK-B	94.22	3505

HEAT PACK C



Includes heating filter, 500ml BuildCert inhibitor, 500ml cleanser, filling loop & 15mm electrolytic scale inhibitor

CAT NO.	LIST PRICE	DISC GROUP
CHEM-HTG-PACK-C	106.00	3505

HEAT PACK D



Includes heating filter, 500ml BuildCert inhibitor, 500ml cleanser & 15mm electrolytic scale inhibitor

CAT NO.	LIST PRICE	DISC GROUP
CHEM-HTG-PACK-D	100.11	3505

External Condensate discharge



CalDensate

CalDensate's white in-line neutraliser ensures it blends in with traditional white overflow pipes, inside the property, giving an aesthetically pleasing appearance.



Benefits include:

- ✓ Total acid protection
- ✓ Environmentally friendly
- ✓ Easy to replace cartridge
- ✓ 12 month life
- ✓ Fits all condensing boilers
- ✓ Simple connections
- ✓ Slimline product
- ✓ Fits all condensate piping
- ✓ Suitable for high temperature

CAT NO.	DESCRIPTION	LIST PRICE	DISC GROUP
AN-CALDENSATE	Acidic Neutraliser	55.51	2001
AN-CALDENSATE-R	12 mth cartridge	23.13	2001

CalSoakaway

Purpose made traditional soakaway neutraliser.



10 YEAR WARRANTY

Benefits include:

- ✓ Total acid protection
- ✓ 10 year warranty
- ✓ No replacement needed
- ✓ Lasts the lifetime of the boiler*
- ✓ Simple to install
- ✓ Easy discharge
- ✓ Compatible with 22mm, 35mm and 42mm condensate pipe

*Based on a replacement boiler scheme

CAT NO.	DESCRIPTION	LIST PRICE	DISC GROUP
AN-CALSOAKAWAY	Traditional soakaway to BS6798	28.89	2001

Powerflush machine

Used to clean fouled central heating systems.

Benefits include:

- ✓ Compact
- ✓ Lightweight
- ✓ Easy to use
- ✓ Portable
- ✓ Large tank capacity
- ✓ Simple to install
- ✓ Compatible with all approved chemicals
- ✓ Flow reverser
- ✓ Powerful acid proof flushing pump



CAT NO.	DESCRIPTION	LIST PRICE	DISC GROUP
CHEM-PF-CALFLUSH	Calflush Domestic	913.63	3506

Weld-On 611

Versatile, high strength solvent cement for non-pressure ABS & U-PVC piping systems.



Benefits include:

- ✓ Fast set
- ✓ Good gap filling properties
- ✓ Clear
- ✓ Initial set time 10 mins

CAT NO.	DESCRIPTION	LIST PRICE	DISC GROUP
CHEM-611-250	Plumbing solvent cement	5.90	2001

Isn't it time you changed to Circulating Pumps?

Presenting the CP50/60 high-efficiency and SE20B/60B bronze secondary hot water range of pumps from CPL.



Why choose a CPL pump?

CP50/60



- Fits in any set-up
- Simple connection
- Simply well known and easy to operate
- Automatic bleeding function
- Lower electricity bills

Cat No.	List Price	Disc Group
CP50	93.10	2101
CP60	96.55	2101

SE20B/60B



- A secondary hot water domestic and commercial circulator
- Glandless design for easy pipe installation
- Constant & manual speeds
- Ideal for single or multi-pump networks
- Use in new systems or as a replacement
- Optimum performance, reliability and maintenance free operation

Cat No.	Description	List Price	Disc Group
4178916	SE20B	169.00	2101
4178917	SE60B	203.00	2101

Cistermiser Urinal & Cistern Flushing

IRC – Infrared Urinal Control Valve

Cat No.	Description	List Price	Disc Group
IRC2	Infrared Urinal Control Valve	227.00	2201



Hydraulic Valves

Cat No.	Description	List Price	Disc Group
STD	Hydraulic Cistern Control Valve - Standard	139.00	2201
LP	Hydraulic Cistern Control Valve - Low Pressure	156.00	2201



Easyflush – No-touch WC Flush Valve

Cat No.	Description	List Price	Disc Group
EF/WAVE	Easyflush Infrared WC Flush Valve	210.00	2201



Easyflush Direct – No-touch Mains WC Flush Valve

Cat No.	Description	List Price	Disc Group
efd	Easyflush Direct Mains WC Flush Valve	313.00	2201



Vectatap Infrared Basin Tap

Cat No.	Description	List Price	Disc Group
VT	Vectatap Infrared Basin Tap	270.00	2201



Novatap Infrared Basin Tap

Cat No.	Description	List Price	Disc Group
NT-EX	Novatap Infrared Basin Tap	270.00	2201



Combimate Limescale Prevention

Combimate Limescale Prevention Device



Cat No.	Description	List Price	Disc Group
COM1	Combimate Scale Reducer 15mm	135.00	2201
COM2	Combimate Scale Reducer 22mm	162.00	2201
SIL1	Combiphos Refill Pack (1 x 800g bottle)	18.45	2202
SIL20/C	Combiphos Refill Pack (20 x 800g bottles)	369.00	2202



DOMESTIC THERMOSTATIC RADIATOR VALVES

*
8mm
Olive Now
Included

013G605000

Cat No.	Description	List Price	Disc Group
RAS-C² Bi-directional combi packs <small>(includes "Revolver" valve & sensor)</small>			
013G605000	15mm Angle contract TRV	18.77	2812
013G605500	10mm Angle contract TRV*	18.77	2812
013G605100	15mm Straight contract TRV	18.77	2812
013G605600	10mm Straight contract TRV	18.77	2812
013G606000	15mm Angle reversible with 10mm Push-fit elbow*	22.94	2812

013G600500

Cat No.	Description	List Price	Disc Group
RAS-C² Bi-directional radiator packs <small>(includes "Revolver" valve, matching lockshield valve & sensor)</small>			
013G600500	15mm Angle TRV + matching lockshield	24.47	2812
013G600600	10mm Angle TRV + matching lockshield	24.47	2812
013G600300	15mm Straight TRV + matching lockshield	24.47	2812
013G600400	10mm Straight contract TRV	24.47	2812
013G600700	15mm Angle + lockshield, both with 10mm Push-fit elbow	30.44	2812

013G601300

Cat No.	Description	List Price	Disc Group
RAS-D² Bi-directional combi packs <small>(includes chrome "Revolver" valve & sensor)</small>			
013G601300	10/15mm Angle TRV, White sensor & Chrome valve body	31.05	2812
013G601200	10/15mm Angle TRV, Chrome sensor & valve body	42.74	2812
013G601400	10/15mm Straight TRV, Chrome sensor & valve body	42.74	2812
013G601500	10/15mm Straight TRV, White/Chrome sensor & Chrome valve body	31.05	2812

013G601800

Cat No.	Description	List Price	Disc Group
RAS-D² Bi-directional combi packs <small>(includes chrome "Revolver" valve, lockshield & sensor)</small>			
013G601700	10/15mm Angle TRV complete + lockshield, white/chrome	49.48	2812
013G601600	10/15mm Angle all Chrome TRV + lockshield	61.52	2812
013G601900	15mm Straight TRV complete + lockshield, white/chrome	49.48	2812
013G601800	10/15mm Straight all Chrome TRV + lockshield	61.52	2812

013G712500

Cat No.	Description	List Price	Disc Group
RTW Bi-directional combi packs <small>(includes "Revolver" valve & sensor)</small>			
013G712000	15mm Angle, Flow selectable reversible Bi-directional valve	14.23	2812
013G712500	10mm Angle, Flow selectable reversible Bi-directional valve	14.23	2812
RTW Bi-directional radiator packs <small>(includes "Revolver" valve, matching lockshield valve & sensor)</small>			
013G710500	15mm Angle, Flow selectable reversible Bi-directional valve and matching lockshield valve	20.07	2812
013G710600	10mm Angle, Flow selectable reversible Bi-directional valve and matching lockshield valve	20.07	2812
013G711000	RTW Thermostatic Fixed Sensor Only	12.84	2812

LOCKSHIELD VALVES

003L020300

Cat No.	Description	List Price	Disc Group
Manual valve radiator packs, type RLV-D <small>(includes valve bodies, fitting & wheelhead kit)</small>			
003L023800	10/15mm Angled lockshield + wheelhead, Chrome	39.79	2812
003L023900	10/15mm Straight lockshield + wheelhead valve, Chrome	39.79	2812
003L023400	10mm Angled lockshield + wheelhead valve, Nickel	14.58	2812
003L023500	15mm Angled lockshield + wheelhead valve, Nickel	14.58	2812
003L023600	10mm Straight lockshield + wheelhead valve, Nickel	19.43	2812
003L023700	15mm Straight lockshield + wheelhead valve, Nickel	19.43	2812
Domestic lockshield valves, type RLV-D			
003L020300	15mm Angle, compression connections, Nickel	7.10	2812
003L020400	10mm Angle, compression connections, Nickel	7.10	2812
003L020500	15mm Angle, complete with 10mm Push-fit elbow, Nickel	10.84	2812

COMMERCIAL THERMOSTATIC RADIATOR VALVES

013G167600



Cat No.	Description	List Price	Disc Group
TRV Valve Body type RA-G for one pipe systems			
Straight			
013G167500	RA-G15 - 1/2" Straight pipe valve	38.46	2812
013G167700	RA-G20 - 3/4" Straight pipe valve	41.49	2812
013G167900	RA-G25 - 1" Straight pipe valve	54.99	2812
Vertical angle			
013G167600	RA-G15 - 1/2" Vertical Angle 1 pipe valve	38.46	2812
013G167800	RA-G20 - 3/4" Vertical Angle 1 pipe valve	41.49	2812
013G168000	RA-G25 - 1" Vertical Angle 1 pipe valve	54.99	2812

013G002300



Cat No.	Description	List Price	Disc Group
TRV Valve Body type RA-FN, for 2 Pipe Systems			
Straight			
013G002200	3/8" Straight TRV body	14.52	2812
013G002400	1/2" Straight TRV body	14.52	2812
013G008400	15mm or 1/2" Straight TRV body	17.60	2812
013G002600	3/4" Straight TRV body	19.95	2812
013G002800	1" Straight TRV body	37.25	2812
Vertical angle			
013G002100	3/8" Vertical angle TRV body	14.52	2812
013G002300	1/2" Vertical angle TRV body	14.65	2812
013G0023AA	15mm/1/2" Angle TRV body	17.78	2812
013G002500	3/4" Vertical angle TRV body	19.78	2812
013G002700	1" Vertical angle TRV Body	37.25	2812
Horizontal angle			
013G014100	3/8" Angle TRV body (horizontal sensor)	14.52	2812
013G014900	15mm or 1/2" Angle body (horizontal sensor)	17.78	2812
013G014500	3/4" Angle TRV body (horizontal sensor)	19.95	2812

013G291000



Cat No.	Description	List Price	Disc Group
Thermostatic sensor type RA2000 for use with all RA-FN, RA-N & RA-G valve bodies			
013G291000	Fixed sensor 5-26°C (replaces RA2010)	22.62	2812
013G291400	Fixed sensor 5-22°C (replaces RA2070)	22.62	2812
013G292000	Fixed sensor, Tamperproof 5-26°C (replaces RA2020)	33.56	2812
013G291200	Remote sensor 5-26°C (replaces RA2012)	34.28	2812
013G291600	Remote sensor 5-22°C (replaces RA2072)	33.26	2812
013G292200	Remote sensor, Tamperproof 5-26°C (replaces RA2022)	42.76	2812
013G506200	Remote adjuster 2m 6-28°C	75.82	2812
013G506500	Remote adjuster 5m 6-28°C	82.98	2812
013G506800	Remote adjuster 8m 6-28°C	89.82	2812
013G299000	Remote adjuster - Click - Fixed Sensor 5-26°C	23.52	2812

013G295000



Cat No.	Description	List Price	Disc Group
Spares & accessories for thermostatic radiator valves			
013G295000	Replacement for RAVL Built-in Sensor	26.21	2812
013G295200	Replacement for RAVL Remote Sensor	37.18	2812
013G296000	Replacement for RAV Built-in Sensor	35.13	2812
013G296200	Replacement for RAV Remote Sensor	49.97	2812

LOCKSHIELD VALVES

Cat No.	Description	List Price	Disc Group
Commercial lockshield valves without drain-cock connector, type RLV			
Straight			
003L012200	3/8" Straight valve	16.49	2812
003L012400	1/2" Straight valve	17.00	2812
003L012415	15mm or 1/2" Straight valve	19.29	2812
003L012600	3/4" Straight valve	22.77	2812
Vertical angle			
003L012100	3/8" Vertical angle valve	16.49	2812
003L012300	1/2" Vertical angle valve	17.00	2812
003L012315	15mm or 1/2" Vertical angle valve	19.29	2812
003L012500	3/4" Vertical angle valve	22.77	2812



003L012300

Cat No.	Description	List Price	Disc Group
Commercial lockshield valves with drain-cock connector, type RLV			
Straight			
003L014200	3/8" Straight valve	20.48	2812
003L014400	1/2" Straight valve	21.46	2812
003L014415	15mm or 1/2" Straight valve	24.10	2812
003L014600	3/4" Straight valve	28.72	2812
Vertical angle			
003L014100	3/8" Vertical angle valve	20.48	2812
003L014300	1/2" Vertical angle valve	21.46	2812
003L014315	15mm or 1/2" Vertical angle valve	24.10	2812
003L014500	3/4" Vertical angle valve	28.72	2812

TIMESWITCHES AND PROGRAMMERS



087N789800



087N654200

Cat No.	Description	List Price	Disc Group
MK18 models with calendar & service interval timer			
087N789800	FP715Si - 7 Day, 24hr or 5/2 Day, 2 channel, independent timebases	90.16	2812
087N789700	CP715Si - 7 Day, 24hr or 5/2 Day, 2 channel, common timebase	83.70	2812
087N789900	TS715Si - 7 Day, 24hr or 5/2 Day, single channel timeswitch	71.12	2812

Cat No.	Description	List Price	Disc Group
SET programmers & timeswitches			
087N654000	SET 1E - 24hr electronic timeswitch	85.10	2812
087N654100	SET 2E - 24hr electronic mini-programmer	92.81	2812
087N654200	SET 3E - 24hr electronic programmer	101.08	2812



087N690400



087N653800

Cat No.	Description	List Price	Disc Group
Factory replacement units (Plug-in modules, no backplate supplied)			
087N686800	102E7 FRU - Complete with dial cover	113.10	2812
087N690400	103E7 FRU - Complete with dial cover	102.57	2812

Cat No.	Description	List Price	Disc Group
GP programmers & timeswitches (Note: 103E7 replaces 103E/E5 & 102E7 replaces 102E/E5)			
087N653800	103E7 - 7 Day or 5/2 Day electronic timeswitch	120.80	2812
087N653600	102E7 - 7 Day or 5/2 Day electronic mini-programmer	132.00	2812
087N652500	106 - 24hr electro-mechanical timeswitch for optional water or heating priority systems	138.69	2812

COMMERCIAL TIMESWITCHES

Cat No.	Description	List Price	Disc Group
Commercial timeswitches, MK8, 7 Day			
087N656600	811 - Single channel 30A, SPST, On/Off switching	367.14	2812
087N657200	851 - Single channel 10A, SPDT, On/Off switching	346.33	2812
087N657500	852 - 2 channel, 2 x SPDT, 10A, On/Off switching	406.35	2812
087N656800	841 - Single channel 15A, SPST, Pulsed output	448.01	2812
087N657100	842 - 2 channel 2 x 3A, SPDT, Pulsed output	530.04	2812

087N656600



087N657500

PROGRAMMABLE ROOM THERMOSTATS

Cat No.	Description	List Price	Disc Group
5/2 Day Programmable Thermostats			
087N791000	TP5000 Si - 5 day/2 day & 24hr programmable electronic room thermostat with service interval function, battery powered	81.07	2812
087N791100	TP5000A Si - as TP5000 Si but for remote sensor (not included), battery powered	84.55	2812
087N791700	TP5000M Si - 5/2 day & 24hr programmable electronic room thermostat with service interval function, mains powered	86.60	2812
087N791800	TP5000MA Si - as TP5000M Si but for remote sensor (not included), mains powered	90.08	2812
087N791200	TP5000 Si-RF - 5/2 day & 24hr programmable electronic room thermostat with RF control & service interval function, battery powered	93.46	2812
087N791300	TP5000A Si-RF - as TP5000 Si-RF but for remote sensor (not included)	97.06	2812
087N791400	TP5000 Si-RF + RX-1 - 5/2 day & 24hr programmable electronic room thermostat with service interval function complete with RX-1 receiver unit, battery powered	176.88	2812



087N791400



Cat No.	Description	List Price	Disc Group
7 Day Programmable Thermostats			
087N800200	TP7001 Si - 7 day/5/2 day & 24hr programmable electronic room thermostat with service interval function, battery powered	87.69	2812
087N800900	TP7001A Si - as TP7000 Si but for remote sensor (included), battery powered	92.02	2812
087N800300	TP7001M Si - 7 day/5/2 day & 24hr programmable electronic room thermostat with service interval function, mains powered	102.88	2812
087N801000	TP7001MA Si - as TP7000M Si but for remote sensor (included), mains powered	107.20	2812



087N800200



TPOne™ Programmable Room Thermostat



TP One, now with
Wifi connectivity

Cat No.	Description	List Price	Disc Group
7 Day Programmable Thermostats			
087N785100	TPOne-B - 7 day, 5/2 day & 24hr programmable electronic room thermostat with service interval function, battery powered	78.63	2812
087N785200	TPOne-M - 7 day, 5/2 day & 24hr programmable electronic room thermostat with service interval function, mains powered	86.60	2812
087N785400	TPOne-RF + RX1S - 7 day, 5/2 day & 24hr wireless programmable room thermostat with service interval function, complete with RX-1S receiver unit	171.56	2812
087N785300	TPOne-RF - 7 day, 5/2 day & 24hr wireless programmable room thermostat with service interval function (thermostat only)	90.68	2812
7 Day Programmable Thermostats with WiFi			
087N7856	TPOne-S + DBR - Internet connected 7 day, 5/2 day programmable room thermostat	242.11	2812
087N785500	TPOne-S - Internet connected 7 day, 5/2 day programmable room thermostat	155.79	2812
087N7857	TPOne (DBR) - Second channel RF receiver for domestic hot water control	73.78	2812
087N786800	TPOne-S Table Stand - Table stand for TPOne-S and / or TPOne-RF	25.74	2812

Danfoss Eco® Programmable Radiator Thermostats





Cat No.	Description	List Price	Disc Group
Danfoss Eco® Programmable Radiator Thermostats			
014G100400	Programmable sensor with adapters for Danfoss RA valves and valves with M30 connection	61.46	2812
014G102000	Angle, 10/15 mm Combi Pack. Includes Flow selectable reversible Bi-directional valve and programmable sensor	81.25	2812
014G102100	Angle, 10/15 mm Radiator Pack. Includes Flow selectable reversible Bi-directional and matching lockshield valves and programmable sensor	90.68	2812

ROOM THERMOSTATS





Cat No.	Description	List Price	Disc Group
Electronic Wireless Room Thermostats			
087N644300	RET2000B-RF - Digital, Battery powered, RF - Thermostat, Remote sensor input	61.56	2812
087N644400	RET2000B-RF + RX1-S - Digital, Battery powered, RF - Thermostat with Mains Powered Single Channel Receiver	157.89	2812

087N644400



087N645100

Cat No.	Description	List Price	Disc Group
Electronic, type RET 1000 (5-30°C)			
087N645100	RET1000B - Dial setting, Battery powered	29.91	2812
087N645000	RET1000M - Dial setting, Mains powered	29.91	2812
087N645200	RET1000MS - Dial setting, Mains powered and Mains output	29.91	2812
087N645400	RET1000MD - Dial setting, Mains powered with delayed start	33.45	2812



087N644100

Cat No.	Description	List Price	Disc Group
Electronic, type RET 2000 (5-30°C)			
087N644100	RET2000B - Digital, Battery powered	60.01	2812
087N644000	RET2000M - Digital, Mains powered	60.01	2812
087N644200	RET2000MS - Digital, Mains powered & Mains output	60.01	2812
087N644500	RET2000MD - Digital, Mains powered with delayed start	63.59	2812



087N111000

Cat No.	Description	List Price	Disc Group
Electro-Mechanical, type RMT 230 (8-30°C)			
087N111000	RMT230* - SPDT 220/240 Vac, 10(4)A, No accelerator	24.42	2812
087N110000	RMT230 - SPDT 220/240 Vac, 10(4)A	25.25	2812
087N112500	RMT230T - SPDT 220/240 Vac, 10(4)A, Night set-back	33.35	2812



087N119600

Cat No.	Description	List Price	Disc Group
Electro-Mechanical, type RMT 24 (8-30°C)			
087N119600	RMT24 - SPDT 24 Vac, 10(4)A	28.02	2812
087N119700	RMT24T - SPDT 24 Vac, 10(4)A, Night set-back	36.18	2812

087N774400

Cat No.	Description	List Price	Disc Group
Electronic, Flat Stat type FMT 230 (5-30°C) flush mounting			
087N774400	FMT230D - Room thermostat for flush mounting. Fitting into a standard single gang UK electrical accessory box, 230V powered	60.69	2812

087N701000

Cat No.	Description	List Price	Disc Group
Electronic, type RET 230 (5-30°C) 230V			
087N701000	RET230NSB - Voltage free SPDT 220/240 Vac, 3(1)A, 2 x LED, night set-back	35.51	2812

ROOM THERMOSTATS, CONTINUED



087N743000

Cat No.	Description	List Price	Disc Group
Electronic, type RET 230 (5-30°C) 230V			
087N743000	RET230P - Voltage free SPDT 220/240 Vac, 3(1)A	24.50	2812



CYLINDER, PIPE, IMMERSION AND FROST THERMOSTATS



041E001000

Cat No.	Description	List Price	Disc Group
Cylinder Thermostat			
041E001000	ATC Cylinder - 30-90°C, SPDT, differential 6-10K	25.48	2812



041E000000

Cat No.	Description	List Price	Disc Group
Pipe Thermostat			
041E000000	ATP Pipe - 30-90°C, SPDT, differential 6K	55.37	2812



087N727900

Cat No.	Description	List Price	Disc Group
Digital Cylinder Thermostat			
087N727900	CET2000B-RF + RX-1S - Digital cylinder thermostat with clamp-on sensor. Battery powered with RF communication. Complete with RX-1S receiver unit	163.55	2812



087N671200

Cat No.	Description	List Price	Disc Group
Frost Thermostats			
087N671200	ATF - Pipe frost thermostat, range 10-90°C, SPDT, differential 6K	37.86	2812
087N701300	RET230F5 - Electronic room mounting frost thermostat, 5°C	37.86	2812
087N701200	RET230F - Electronic room mounting frost thermostat, Factory set to 5°C	37.86	2812



099-106200

Cat No.	Description	List Price	Disc Group
Immersion Thermostats			
099-105700	ITC - Immersion control thermostat 0-90°C, 1/2" x 100mm, SPDT	49.52	2812
099-105800	ITC - Tamper-proof immersion control thermostat 0-90°C, 1/2" x 100mm, SPDT	49.37	2812
099-105900	ITL - Immersion limit thermostat 90-110°C, factory set to 90°C, 1/2" x 117mm, SPST	53.76	2812
099-106100	ITD - Immersion dual control/limit thermostat 30-90°C, 1/2" x 100mm control 30-90°C SPDT, limit 90-100°C, factory set to 90°C, SPST	91.81	2812
099-106200	ITD - Immersion dual control/limit thermostat 30-90°C, 1/2" x 100mm control 30-90°C SPDT, limit pre-set to 80°C, SPST	91.81	2812

MOTORISED VALVES

Cat No.	Description	List Price	Disc Group
3 Port mid-position valves complete with HSA3 actuators (spring return to heating closed)			
Shoe type			
087N661300	HS3 - 22mm 3 port mid-position valve complete with actuator	117.81	2812
Paddle type			
087N664600	HS3B - 22mm 3 port mid-position valve complete with actuator	117.81	2812
087N665100	HS3B28 - 28mm 3 port mid-position valve complete with actuator	146.94	2812
087N665000	HS3B15 - ½" / 15mm 3 port mid-position valve complete with actuator	117.81	2812
087N664800	HS3B0.75 - ¾" 3 port mid-position valve complete with actuator	117.81	2812
087N664900	HS3B1.0 - 1" 3 port mid-position valve complete with actuator	146.94	2812



087N661300

Cat No.	Description	List Price	Disc Group
2 Port valves complete with HPA2 actuators (spring return to heating closed)			
Shoe type			
087N660900	HP22 - 22mm 2 port valve complete with HPA2 actuator	80.30	2812
087N661100	HP28 - 28mm 2 port valve complete with HPA2 actuator	101.47	2812
087N661200	HP28C - 28mm 2 port valve complete with HPA2C actuator	110.29	2812
087N660800	HP15 - ½" / 15mm 2 port valve complete with HPA2 actuator	80.30	2812
087N660200	HP0.75 - ¾" 2 port valve complete with HPA2 actuator	80.30	2812
087N660400	HP1.0 - 1" 2 port valve complete with HPA2 actuator	101.47	2812
Paddle type			
087N664200	HP22B - 22mm 2 port valve complete with HPA2 actuator	80.30	2812
087N664400	HP28B - 28mm 2 port valve complete with HPA2 actuator	101.47	2812
087N664500	HP28BC - 28mm 2 port valve complete with HPA2C actuator	110.29	2812
087N664000	HP15B - ½" / 15mm 2 port valve complete with HPA2 actuator	80.30	2812
087N663400	HP0.75B - ¾" 2 port valve complete with HPA2 actuator	80.30	2812
087N663700	HP1.0B - 1" 2 port valve complete with HPA2 actuator	101.47	2812



087N660900

Cat No.	Description	List Price	Disc Group
Spring return valve actuators (use with both paddle & shoe valves)			
087N658700	HSA3 - 3 port mid-position valve actuator	69.04	2812
087N658900	HSA3D - 3 port diverter valve actuator, 4 wire with SPST Aux. Sw	69.04	2812
087N657900	HPA2 - 2 port valve actuator, 4 wire with SPST Aux. Sw	51.97	2812
087N658000	HPA2C - 2 port valve actuator, 5 wire with SPDT Aux. Sw	60.28	2812



087N658700

ENGINEERING
TOMORROW

Danfoss

Programmable Radiator Thermostat

Danfoss Eco™

Stand-alone programmable radiator thermostat

Control your individual radiators using Bluetooth technology with the Danfoss Eco™ App.

Each Eco™ radiator thermostat can be programmed individually to give you complete control over your home heating. Programme your radiators to fit your daily schedule and achieve better comfort levels and increased energy savings.



Up to
30%
energy saving by
replacing old
radiator thermostats
with the new
Danfoss Eco™





**THE
INDEPENDENTS'
INDEPENDENT**

Simple and smart heating control

Install a Tybox 5000/5100 connected pack and introduce your clients to the smart home with Tydom by Delta Dore.



WARRANTY
5
YEAR



Tydom application,
encrypted and secure



**LOT 20
COMPLIANT**

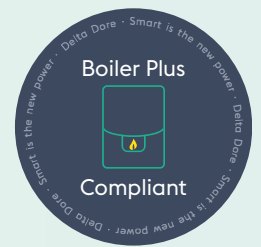

technical support

020 7660 2919

sales information

Visit www.deltadore.co.uk/contact and request a visit from your local Delta Dore representative.

come and visit our concept space at

THE BUILDING CENTRE



Cat No.	Model No.	Description	ErP Class	List Price	Disc Group
---------	-----------	-------------	-----------	------------	------------

One Channel Thermostats - ideal for combi boilers (without smart home control)

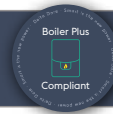

6053002	TYBOX B+ basic	Wireless RF room thermostat with manual 1-24h timer (replaces the TYBOX 33)	4	109.18	2901
6053007	TYBOX B+	Wireless RF programmable room thermostat 24h/7day (replaces the TYBOX 137)	4	112.96	2901



One/Two Channel Thermostats - ideal for combi boilers (with smart home control)



6050643	5000 Connected pack	One channel connected thermostat & Tydom hub - wired 24/230v & app enabled	4	169.15	2901
6050635	5100 Connected pack	One channel connected thermostat & Tydom hub - wireless RF 24/230v & app enabled	4	211.15	2901
6053058	5100 Two channel connected pack	Two connected thermostats & Tydom hub (combi boiler) ideal for 2 channel heating (new heating system > 150m²) - wireless RF 24/230v & app enabled	4	302.33	2903

Two/Three Channel Thermostat & Programmer Packs - ideal for system/regular boilers (with smart home control)

6053059	5100 Two channel connected system pack	One connected thermostat, one hot water receiver & Tydom hub (system/regular boiler) ideal for two channel heating and hot water - wireless RF & app enabled	4	290.70	2903
6053057	5100 Three channel connected system pack	Two connected thermostats, one hot water receiver & Tydom hub (system/regular boiler) ideal for three channel, 2 heating and 1 hot water (new heating system > 150m²) - wireless RF & app enabled	4	383.73	2903



Underfloor Heating (with smart home control)



6053060	UFH Connected pack (expandable)	Three zone UFH base pack (expandable to 32 zones + hot water) - wireless RF & app enabled	4	480.61	2903
---------	---------------------------------	---	---	--------	------



Simple and smart heating control

DELTA DORE
Smart is the new power

Cat No. Model No. Description

**ErP
Class**

**List
Price**

**Disc
Group**

Plug and Play Smart Home Products

6410168	TYXAL+ Pack	Security base pack (pre-associated, 100% wireless & 10 year battery - notifications with Tydom)	N/A	752.93	2901
6351376	TYXIA 6610	Connected rocker switch for lamps (astrological function with Tydom)	N/A	66.95	2901

Other Smart Home Products (Heating - wet & electric)

6700107	TYDOM 1.0	Smart Home Hub	N/A	99.00	2901
6050636	TYBOX 5000	Wired connected thermostat (programmable with Tydom - 1 zone)	4	76.02	2901
6050608	TYBOX 5100	Wireless RF connected thermostat - 4 core cable 24/230v (programmable with Tydom - 32 zones max)	4	116.70	2901
6050634	TYBOX 5200	Wireless RF connected thermostat - 3 core cable 230v (programmable with Tydom - 32 zones max)	4	116.70	2901
6351180	TYXIA 6410	Wireless RF connected receiver for hot water (programmable with Tydom - 32 max)	N/A	111.24	2901
6050567	RF 6420	Wireless RF connected boiler relay/interlock (no switch live - compatible with TYBOX 5100/5200)	-	101.85	2901
6300045	TYBOX 5101	Wireless RF connected thermostat only (programmable with Tydom - 32 zones max) compatible with Delta 8000, RF4890, RF6620/30/40, RF 6450	4	66.54	2901
6050568	RF 6450	Wireless RF connected receiver for heat pump	-	67.15	2901
6151058	MINOR 1000	Wireless RF connected thermostat for electric radiator (programmable with Tydom - 32 zones max) compatible with 6620/30/40	4/Lot 20	69.30	2901
6050638	RF 6620	Wireless RF 16A electric radiator connected receiver with cable (powered)	N/A	61.80	2902
6050640	RF 6630	Wireless RF 16A electric radiator connected receiver with terminal (powered)	Lot 20	61.80	2901
6050641	RF 6640	Wireless RF 16A electric radiator connected receiver with terminal (volt free)	Lot 20	61.80	2901
6050561	RF 6600 FP	Wireless RF connected pilot wire receiver (programmable with TYDOM - 32 max)	Lot 20	68.96	2901
6050615	RF 4890	Wireless RF connected receiver for electric underfloor heating - 10A	Lot 20	83.87	2901
6300037	FLOOR SENSOR RF4890	Floor sensor (for use with RF 4890)	-	53.56	2901
6053048	DELTA 8000 BT	8 zone underfloor heating wiring centre (expandable up to 32 zones)	4	213.35	2901
6053049	DELTA 8000 RF	Underfloor heating wireless RF connected gateway (one per DELTA 8000 BT)	4	42.50	2901

Other Thermostats (without smart home control)

6053056	TYBOX BUS OT	Wired opentherm programmable thermostat - BUS	5	81.50	2901
6053035	TYBOX 23	Wireless RF digital room thermostat	4	82.03	2901
6053002E	TYBOX 33	Wireless RF digital room thermostat with temperature dial	4	109.18	2901
6053016	TYBOX 34	Wireless RF digital room thermostat with temperature dial (industry standard backplate)	4	110.27	2901
6053007E	TYBOX 137	Wireless RF programmable room thermostat (24hr & 7 day)	4	112.96	2901
6351037	RF 642	Wireless RF 16A receiver (compatible with the Tybox 157)	N/A	141.10	2901
6050426	DRIVER 620	Wired 2-zone pilot wire programmer (replacement for the micro DRIVER 2H fil pilote)	N/A	145.35	2901
6050537	TYBOX 827	Wireless RF two channel programmer with integrated thermostat (system/regular boiler)	4	192.75	2901

DEVI^{mat}

- Super sticky adhesive mesh
- Under 4mm thin
- 100% aluminium earth sheath
- Semko approved
- Part L compliant
- Floor Guard guarantee; covers both the cable and the floor
- 17th Edition compliant



DEVIreg™
Touch

DEVI^{mat} Electric Underfloor Heating



DEVIreg Touch



DEVIreg Smart App (Phone Not Included)

DEVIreg Smart



DEVIreg Smart Range

Cat No.	Description	List Price	Disc Group
DEVI^{mat} DTIR 100W/m² for timber construction floors (mats are 500mm wide)			
83030500	50W, 230V Twin conductor, single cold tail mat, area to be warmed 0.5m ²	82.78	2867
83030502	100W, 230V Twin conductor, single cold tail mat, area to be warmed 1.0m ²	92.74	2867
83030504	150W, 230V Twin conductor, single cold tail mat, area to be warmed 1.5m ²	113.78	2867
83030506	200W, 230V Twin conductor, single cold tail mat, area to be warmed 2.0m ²	132.85	2867
83030508	250W, 230V Twin conductor, single cold tail mat, area to be warmed 2.5m ²	151.99	2867
83030510	300W, 230V Twin conductor, single cold tail mat, area to be warmed 3.0m ²	171.11	2867
83030512	350W, 230V Twin conductor, single cold tail mat, area to be warmed 3.5m ²	190.25	2867
83030514	400W, 230V Twin conductor, single cold tail mat, area to be warmed 4.0m ²	209.38	2867
83030516	500W, 230 V Twin conductor, single cold tail mat, area to be warmed 5.0m ²	247.63	2867
83030518	600W, 230V Twin conductor, single cold tail mat, area to be warmed 6.0m ²	276.33	2867
83030520	700W, 230V Twin conductor, single cold tail mat, area to be warmed 7.0m ²	303.95	2867
83030522	800W, 230V Twin conductor, single cold tail mat, area to be warmed 8.0m ²	332.66	2867
83030524	900W, 230V Twin conductor, single cold tail mat, area to be warmed 9.0m ²	360.30	2867
83030526	1000W, 230V Twin conductor, single cold tail mat, area to be warmed 10.0m ²	392.18	2867
83030528	1200W, 230V Twin conductor, single cold tail mat, area to be warmed 12.0m ²	445.32	2867
DEVI^{mat} DTIR 150W/m² for concrete construction floors (mats are 500mm wide)			
83030560	75W, 230V Twin conductor, single cold tail mat, area to be warmed 0.5m ²	82.78	2867
83030562	150W, 230V Twin conductor, single cold tail mat, area to be warmed 1.0m ²	92.74	2867
83030564	225W, 230V Twin conductor, single cold tail mat, area to be warmed 1.5m ²	113.78	2867
83030566	300W, 230V Twin conductor, single cold tail mat, area to be warmed 2.0m ²	144.06	2867
83030568	375W, 230V Twin conductor, single cold tail mat, area to be warmed 2.5m ²	166.17	2867
83030570	450W, 230V Twin conductor, single cold tail mat, area to be warmed 3.0m ²	180.53	2867
83030572	525W, 230V Twin conductor, single cold tail mat, area to be warmed 3.5m ²	205.01	2867
83030574	600W, 230V Twin conductor, single cold tail mat, area to be warmed 4.0m ²	231.62	2867
83030576	750W, 230V Twin conductor, single cold tail mat, area to be warmed 5.0m ²	279.11	2867
Thermostats			
DEVIreg Touch - Touch Screen Programmable room thermostats			
140F1064	DEVIreg Touch - Touch screen thermostat, Frame Colour: Pure White	130.59	2867
140F1069	DEVIreg Touch - Touch screen thermostat, Frame Colour: Pure Black	130.59	2867
DEVIreg Smart			
140F1140	DEVIreg Smart, Polar White	215.58	2867
140F1141	DEVIreg Smart, Pure White	215.58	2867
140F1142	DEVIreg Smart, Ivory	215.58	2867
140F1143	DEVIreg Smart, Black	215.58	2867
DEVIreg 130 - Dial Room Thermostat			
140F1010	DEVIreg 130, manual, wall mounted dial thermostat	81.67	2867

Industrial available in AA / AAA / C / D / 9V



Cat No.		Per Pack	Pack List Price	Disc Group
ID1500/10	AA Size	10	3.83	6105
ID2400/10	AAA Size	10	3.51	6105
ID1400/10	C Size	10	9.25	6105
ID1300/10	D Size	10	14.22	6105
ID1604/10	9V Size	10	13.03	6105

Plus Power available in AA / AAA / C / D / 9V



Cat No.		Per Blister	Per Box	Box List Price	Disc Group
AAK4PLUS	MN1500B4	4	20 x 4	55.72	6105
AAAK4PLUS	MN2400B4	4	10 x 4	27.86	6105
CK2PLUS	MN1400B2	2	10 x 2	28.34	6105
DK2PLUS	MN1300B2	2	10 x 2	33.91	6105
9VK1PLUS	MN1604B1	1	10 x 1	28.34	6105

Ultra Power available in AA / AAA / C / D / 9V



Cat No.		Per Blister	Per Box	Box List Price	Disc Group
ULTRA AAK4	MX1500B4	4	20 x 4	66.86	6105
ULTRA AAAK4	MX2400B4	4	10 x 4	33.43	6105
ULTRA CK2	MX1400B2	2	10 x 2	32.46	6105
ULTRA DK2	MX1300B2	2	10 x 2	32.46	6105
ULTRA 9VK1	MX1604B1	1	10 x 1	33.67	6105

Rechargeable available in AA / AAA / C / D / 9V



Cat No.		Per Blister	Per Box	Box List Price	Disc Group
Multichargers					
ACCUCHARGERCEFF22	CEF22	1	4 x 1	154.55	6105
ACCUCHARGERCEFF27	CEF27	1	3 x 1	76.02	6105
Pre-charged Premium Rechargeables					
AA4HR6/2500MAH	HR6 AA	4	10 x 4	116.28	6105
AAA4HR03/850MAH	HR03 AAA	4	10 x 4	116.28	6105
Rechargeables					
AA4HR6/1300MAH	HR6 AA	4	10 x 4	90.12	6105
AAA4HR03/750MAH	HR03 AAA	4	10 x 4	90.12	6105
C/HR14	HR14 C	2	10 x 2	117.73	6105
D/HR20	HR20 D	2	10 x 2	117.73	6105
9V/HR09V	HR9V 9V	1	10 x 1	90.12	6105

Specialist batteries for specialist applications



Cat No.		Per Blister	Per Box	Box List Price	Disc Group
Ultra M3 Photographic Batteries					
123ULTRAM3B2	3V Lithium	2	10 x 2	62.50	6105
CRV3ULTRAM3	3V Lithium Digital	1	6 x 1	49.85	6105
Car Alarm, Pager, and Remote Control Batteries					
MN9100B2	1.5V Alkaline	2	10 x 2	19.62	6105
MN21B2	12V Alkaline	2	10 x 2	19.62	6105
Electronic Watch & Calculator Batteries					
D357B2	1.5V Silver Oxide	2	10 x 2	40.21	6105
LR44B2	1.5V Alkaline	2	10 x 2	10.17	6105
DL2016B2	3V Lithium	2	10 x 2	19.14	6105
DL2025B2	3V Lithium	2	10 x 2	19.14	6105
DL2032B2	3V Lithium	2	10 x 2	19.14	6105

smart rooms with **Wiser**™

Introducing Wiser, the beautifully simple multi-zone heating system from Drayton.



What makes Wiser wiser?

- Buildable multi-zoning
- 3 channels, 16 rooms, 32 devices
- 20 minute install on industry standard wallplate
- Suitable for 99% of all UK boilers
- Works with Amazon Alexa, the Google Assistant & IFTTT

The **Wiser**™ options

Life Is On **Drayton**
by Schneider Electric



Class VII
3.5%

Wiser Thermostat Kit 1

One channel thermostat pack ideal for combi-boilers. Enables you to control heating via the Wiser Heat app.

Cat No.	List Price	Disc Group
WT714R9K0902	179.93	3106



Class VII
3.5%

Wiser Thermostat Kit 2

Two channel thermostat pack ideal for conventional systems. Enables you to control heating and hot water via the Wiser Heat app. Wire in existing cylinder thermostat for hot water control.

Cat No.	List Price	Disc Group
WT724R9K0902	192.78	3106



Class VII
3.5%

Wiser Thermostat Kit 3

Three channel thermostat pack ideal for properties with two heating zones. Enables you to control heating and hot water via the Wiser Heat app. Wire in existing cylinder thermostat for hot water control.

Cat No.	List Price	Disc Group
WT734R9K0902	282.75	3106



Class VIII / VII
5% / 3.5%

Wiser Multi-zone Kit 1

One channel thermostat system with two radiator thermostats to start zoning your system. Suitable for combination boilers. Control the room thermostat and radiator thermostats via the Wiser Heat app. Add more radiator valves to create more independent zones.

Cat No.	List Price	Disc Group
WV714R9K0902	282.75	3106



Class VIII / VII
5% / 3.5%

Wiser Multi-zone Kit 2

Two channel thermostat system with two radiator thermostats to start zoning your system. Suitable for conventional boilers. Set schedules for the room thermostat, radiator thermostats and hot water via the Wiser Heat app. Add more radiator valves to create more independent zones.

Cat No.	List Price	Disc Group
WV724R9K0902	295.61	3106



Expand your Smart Home

Expand your Wiser system with additional radiator thermostats to create smart rooms.

Cat No.	List Price	Disc Group
WV704R0A0902	57.83	3106

Use the Wiser Plug to schedule your home electrical appliances from the Wiser Heat app.

Cat No.	List Price	Disc Group
WB704H1A0902	45.57	3106

*ErP Class varies depending on boiler type. ErP shown refers to either a Modulating Boiler or an On/Off Boiler.

Drayton

by Schneider Electric



List Price
From
£30.34

Now
Available

Clip-in wireless controls

Suitable for Worcester boilers

- Clip-in boiler controls
- 4 pack options
- Simple wireless installation
- Signal strength indicator

www.draytoncontrols.co.uk

0333 6000 622



BRITISH BUILT TO LAST



HEAR ALL THE NEWS
@draytonheating



SEE OUR PRODUCTS
/draytoncontrols

Timeswitches and Programmers



Single Channel

Cat No.	Description	List Price	Disc Group
25477	LP111 Single Channel 24hr, 3 on/off	69.44	3102
25478	LP711 Single Channel 7 day, 3 on/off	80.40	3102
29205	SM1 Single Channel Electro Mechanical Timelock 24hr	165.01	3102

Two Channel

Cat No.	Description	List Price	Disc Group
25473	LP112 Two Channel 24hr, 3 on/off	77.58	3102
25476	LP722 Two Channel 7 day, 3 on/off	102.49	3102
25475	LP522 Two Channel 5/2 day, 3 on/off	90.25	3102
25474	LP241 Two Channel 24hr, 3 on/off (separate timing per channel)	87.96	3102
29206	SM2 Two Channel Electro Mechanical Programmer 24hr	173.94	3102

With Service Interrupter

Cat No.	Description	List Price	Disc Group
25493	LP111Si Single Channel 24hr, 3 on/off	104.79	3102
25494	LP711Si Single Channel 7 day, 3 on/off	115.76	3102
25492	LP722Si Two Channel 7 day, 3 on/off	139.38	3102
25491	LP522Si Two Channel 5/2 day, 3 on/off	126.93	3102
25490	LP241Si Two Channel 24hr, 3 on/off (separate timing per channel)	123.82	3102
25489	LPSi Reset unit	133.66	3102

Thermostats

Clip-in Wireless Controls



Cat No.	Description	ErP Class	List Price	Disc Group
25039DR	LP20 Dual channel programmer for Worcester Boilers		30.34	3106
RF560DR	LP10RF Programmer & Digistat +2RF for Worcester Boilers	IV	76.32	3106
RF561DR	LP10RF Programmer & Digistat +3RF for Worcester Boilers	IV	75.84	3106
RF562DR	LP20RF Dual channel programmer & Digistat +RF for Worcester Boilers	IV	75.52	3106
22589DR	LP10RF Programmer spare for Worcester Boilers		69.07	3106
22590DR	LP20RF Dual channel programmer spare for Worcester Boilers		45.70	3106

Thermostats



Cat No.	Description	ErP Class	List Price	Disc Group
24001	RTS1 Room Stat - SPST	IV	24.84	3102
24002	RTS2 Room Stat - SPST with LED indication	IV	28.19	3102
24003	RTS3 Frost Stat SPST	IV	28.31	3102
24004	RTS4 Room Stat - SPDT Volt Free Contacts	IV	29.37	3102
24028	RTS8 Room Combi Stat 2/3 wire	I	24.50	3102
03 01 260	PTS 1 Pipe Stat		49.83	3102
13007	HTS3 Cylinder Stat		31.44	3102

Digital Room Thermostats



Cat No.	Description	ErP Class	List Price	Disc Group
30002	Digistat* Wired Battery	IV	58.61	3102
22192	Digistat*1 Wired Battery	IV	58.49	3102
RF601	Digistat*RF Stat + Receiver	IV	157.29	3102
RF710	Digistat*1RF Stat + Receiver	IV	157.98	3102
31003	Digistat*RF Stat only	IV	102.88	3102
22190	Digistat*1RF Stat only	IV	102.67	3102
22149	Digistat Receiver only		126.85	3102
13616	Digistat*C RF Cylinder Stat + Receiver + Sensor		252.97	3102

Programmable Thermostats



Cat No.	Description	ErP Class	List Price	Disc Group
22084	Digistat*2, Wired, 24hr, Battery	IV	83.97	3102
22088	Digistat*2, Wired, 24hr, Mains	IV	91.78	3102
RF700	Digistat*2RF, 24hr + Receiver	IV	182.09	3102
22090	Digistat*2RF, 24hr, Transmitter only	IV	111.41	3102
22083	Digistat*3, Wired, 7 Day, 5/2 Day, Battery	IV	95.35	3102
22087	Digistat*3, Wired, 7 Day, 5/2 Day, Mains	IV	102.93	3102
RF701	Digistat*3RF, 7 Day, 5/2 Day + Receiver	IV	192.55	3102
22092	Digistat*3RF, 7 Day, 5/2 Day, Transmitter only	IV	125.54	3102
22149	Digistat Receiver only		126.85	3102

TRV4 Range



Classic TRV4

Key Features -

- Class I rated for energy efficiency
- Non-stick internals
- Slim-line contemporary design
- Liquid filled sensor
- Balance the system via the TRV

Cat No.	Description	List Price	Disc Group
07 05 150	15mm Angle with integral head	29.00	3101
07 05 151	15mm Straight with integral head	29.98	3101
07 05 152	10mm Angle with integral head	30.04	3101
07 05 155	10mm Straight with integral head	31.47	3101
07 05 180	15mm Angle with integral head + lockshield, boxed	37.77	3101
07 05 190	15mm Straight with integral head + lockshield, boxed	43.72	3101
07 05 184	15mm Angle + lockshield + drain off tail piece	45.81	3101
07 25 006	Integral head	25.73	3101
07 05 153	1/2" Screwed female angle with integral head	43.95	3101
07 05 156	1/2" Screwed female straight with integral head	46.15	3101
07 05 154	3/4" Screwed female angle with integral head	51.15	3101
07 05 187	1/2" Angle with + lockshield	60.75	3101
07 05 158	15mm Angle with 2m remote head	50.95	3101
07 05 183	15mm Angle + lockshield + 10mm Chrome elbow	47.28	3101



Chrome TRV4

Key Features -

- Ideal for towel rails
- Non-stick internals
- Slim-line contemporary design
- Liquid filled sensor
- Straight, angled and Lockshield options

Cat No.	Description	List Price	Disc Group
07 05 150C	15mm Angle all Chrome boxed	45.56	3101
07 05 151C	15mm Straight all Chrome boxed	46.67	3101
07 05 170	15mm Angle + lockshield, all Chrome, blister packed	70.69	3101
07 05 171	15mm Straight + lockshield, all Chrome, blister packed	70.98	3101
07 03 013	Integral head - all Chrome	39.09	3101



White TRV4

Key Features -

- Class I rated for energy efficiency
- Neutral white cap
- Non-stick internals
- Liquid filled sensor
- Balance the system via the TRV

Cat No.	Description	List Price	Disc Group
07 07 015	15mm Angle with integral head	29.43	3101
07 07 115	15mm Straight with integral head	31.41	3101
07 07 260	15mm Angle with lockshield	38.33	3101
07 07 007	All white TRV4 head only	25.73	3101

TRV4 Accessories & Adaptors



Cat No.	Description	List Price	Disc Group
07 05 902	15mm Drain off tail piece only - chrome	6.11	3101
07 15 180	15mm Angle TRV4 valve body only	23.79	3101
07 15 196	15mm Corner angle left TRV4 valve body	62.15	3101
07 25 007	TRV4 2m Remote head	39.63	3101
07 35 408	8mm Reducer - bulk packed in 50's	56.85	3101
07 35 123	Wheelhead & lockshield cap pack of 5	19.41	3101
07 15 181	15mm Straight TRV4 valve body only	23.89	3101
07 15 197	15mm Corner angle right TRV4 valve body	61.40	3101
07 25 008	TRV4 6m Remote head	41.89	3101
07 35 410	10mm Reducer - bulk packed in 50's	49.52	3101

RT TRV Range



RT212

Key Features -

- Wax sensor
- Bi-directional valve body
- Non-stick internals
- Straight and angle option
- Range limiting

Cat No.	Description	List Price	Disc Group
08 08 010	10mm Angle	20.01	3101
08 08 015	15mm Angle	19.75	3101
08 08 099	Head only	16.24	3101
08 08 115	15mm Straight	20.52	3101
08 08 260	15mm Angle + lockshield	28.47	3101
08 08 263	15mm Angle + lockshield + 10mm PF elbow	35.18	3101
08 08 810	15mm Angle + 8 & 10mm reducers	22.25	3101



RT313

Key Features -

- Easy grip cap
- Bi-directional valve body
- Non-stick internals
- Straight and angle option
- Range limiting

Cat No.	Description	List Price	Disc Group
08 48 015	15mm Angle	21.57	3101
08 48 099	Head only	17.80	3101



RT414

Key Features -

- Liquid sensor
- Bi-directional valve body
- Non-stick internals
- Straight and angle option
- Range limiting

Cat No.	Description	List Price	Disc Group
10 10 015	Integral head +15mm angle body	22.63	3101
10 10 115	Integral head +15mm straight body	24.11	3101
10 10 260	Integral head +15mm angle + lockshield	30.97	3101
10 10 264	Integral head +15mm angle + lockshield + drain off tail piece	33.84	3101
10 10 360	Integral Head +15mm straight + lockshield	34.90	3101
10 10 099	Head only	23.27	3101

Lockshield and Accessories



Cat No.	Description	List Price	Disc Group
08 08 900	15mm Angle lockshield + white cap	7.65	3101
08 08 901	15mm Angle lockshield + drain off tap	8.55	3101
08 08 902	15mm Drain off tap	4.16	3101
08 08 906	15mm Straight lockshield + white cap	12.05	3101
08 08 904	10mm Push-fit elbow	5.19	3101
08 08 905	15mm Push-fit elbow	6.43	3101
08 08 920	½" Angle commercial lockshield	20.59	3101



Cat No.	Description	List Price	Disc Group
07 01 165	Drain easy kit	55.83	3102
07 02 020	22mm Angle auto bypass valve	47.83	3102
07 45 015	Tapstat 15mm 2 way head	201.58	3101
07 45 016	Tapstat 15mm 3 way head	219.35	3101
07 45 017	Tapstat 28mm 2 way head	228.48	3101

Packs

Biflo



Cat No.	Description	List Price	Disc Group
PBBE66	3 Port 22mm + LP241 + RTS1 + HTS3 + LWC1	348.90	3103
PBBE68	3 Port 22mm + LP241 + RTS1 + HTS3 + LWC3	348.90	3103
PBBE86	3 Port 22mm + LP522 + RTS1 + HTS3 + LWC1	345.93	3103
PBBE86S	3 Port 22mm + LP522Si + RTS1 + HTS3 + LWC1	536.84	3103
PBBE88	3 Port 22mm + LP522 + RTS1 + HTS3 + LWC3	348.90	3103
PBBE96	3 Port 22mm + LP722 + RTS1 + HTS3 + LWC1	349.64	3103
PBBE98	3 Port 22mm + LP722 + RTS1 + HTS3 + LWC3	349.64	3103

Twinzone



Cat No.	Description	List Price	Disc Group
PBTE66	2 x 2 Port 22mm + LP241 + RTS1 + HTS3 + LWC1	419.53	3103
PBTE68	2 x 2 Port 22mm + LP241 + RTS1 + HTS3 + LWC3	419.53	3103
PBTE86	2 x 2 Port 22mm + LP522 + RTS1 + HTS3 + LWC1	415.08	3103
PBTE86B	2 x 2 Port 28mm + LP522 + RTS1 + HTS3 + LWC1	489.53	3103
PBTE88	2 x 2 Port 22mm + LP522 + RTS1 + HTS3 + LWC3	419.53	3103
PBTE96	2 x 2 Port 22mm + LP722 + RTS1 + HTS3 + LWC1	418.64	3103
PBTE98	2 x 2 Port 22mm + LP722 + RTS1 + HTS3 + LWC3	418.64	3103

Unvented



Cat No.	Description	List Price	Disc Group
UWH62	2 Port 22mm + LP241 + RTS1 + LWC1	348.90	3103
UWH62B	2 Port 28mm + LP241 + RTS1 + LWC1	433.34	3103
UWH82	2 Port 22mm + LP522 + RTS1 + LWC1	348.90	3103
UWH82B	2 Port 28mm + LP522 + RTS1 + LWC1	433.34	3103

Motorised Valves and Spares

Motorised Valves



Cat No.	Description	List Price	Disc Group
27100	ZA5/679-2 22mm 2 Port - 5 wire SPST switch	107.43	3102
27101	MA1/679-3 22mm 3 Port Mid-position	163.80	3102
27102	ZA3/679-3 22mm 3 Port Diverter - no switch	150.84	3102
27111	ZA5/679-3 22mm 3 Port Diverter - 5 wire SPST switch	162.00	3102
27205	ZA6/779-2 28mm 2 Port - 6 wire SPST switch	151.32	3102
27206	MA1/779-3 28mm 3 Port Mid-position	210.73	3102
27207	ZA3/679-3 28mm 3 Port Diverter - no switch	186.67	3102

Valve Bodies



Cat No.	Description	List Price	Disc Group
27600	22mm 2 Port Body	60.36	3102
27602	22mm 3 Port Body	102.56	3102
27601	28mm 2 Port Body	96.83	3102
27603	28mm 3 Port Body	129.88	3102
06 14 003	TAMV4 ¾" BSP Valve body	147.11	3102



Cat No.	Description	List Price	Disc Group
27011	Synchronous Motor Pack	58.31	3102

Valve Actuators



Cat No.	Description	List Price	Disc Group
27650	5 Wire Actuator SPST Switch 230V	88.48	3102
27651	Mid-position Actuator 230V	127.51	3102
27652	3 Wire Actuator No Switch 230V	83.42	3102
27653	6 Wire Actuator SPST Switch 230V	94.93	3102
06 14 026	TAM2 240V Actuator	256.32	3102
06 14 027	TAM2 240V Actuator + Aux Switch	277.30	3102
06 14 028	TAM4 240V Actuator Mid-position	249.38	3102

TRV4 Range

Key Features -

- Class I rated for energy efficiency
- Non-stick internals
- Liquid filled sensor
- Balance the system via the TRV

Cat No.	Description	List Price	Disc Group
07 05 180	TRV4 Classic - 15mm Angle with integral head + lockshield, boxed	37.77	3101
07 07 260	TRV4 White - 15mm Angle with lockshield	38.33	3101



RT212

Key Features -

- Wax sensor
- Bi-directional valve body
- Non-stick internals
- Straight and angle option
- Range limiting

Cat No.	Description	List Price	Disc Group
08 08 016	15mm Angle TRV	19.30	3103

Motorised Valves

Cat No.	Description	List Price	Disc Group
27100	ZA5/679-2 22mm 2 Port Valve & Actuator	107.43	3102
27101	MA1/679-3 22mm Mid Position Valve & Actuator	163.80	3102



Digistat RF Range

Cat No.	Description	List Price	Disc Group
RF601	Digistat +RF and Single Channel Receiver	157.29	3102
RF700	Digistat +2RF and Single Channel Receiver	182.09	3102
RF701	Digistat +3RF and Single Channel Receiver	192.35	3102
RF710	Digistat +1RF and Single Channel Receiver	157.98	3102

The fastest to dry hands hygienically with HEPA filtered air.

Dyson Airblade™ hand dryers are powered by the Dyson digital motor V4. Its small size and power density are what have made our latest hand dryer technology possible.

Fastest

Other hand dryers can take up to 43 seconds to dry hands. Too slow. Testing based on NSF Protocol P335 shows that Dyson Airblade™ hand dryers are fast, drying hands in 12 seconds or under.

Most hygienic

Other hand dryers blow dirty washroom air onto your hands. Dyson Airblade™ hand dryers use HEPA filters. So hands are dried using cleaner air, not dirty air.

Low running costs

Dyson Airblade™ hand dryers cost up to 80% less to run than other hand dryers, and 98% less than paper towels.¹



Certified by Quiet Mark²

The Noise Abatement Society tested and approved the decibel levels of the Dyson Airblade V hand dryer – awarding it the Quiet Mark. The Quiet Mark has been developed in response to public health concerns over the psycho-physiological effects of excessive or invasive sound produced by appliances.

¹ For calculations visit dyson.co.uk/calcs

² Quiet Mark™ is a trading name of Quiet Mark Approval Limited, a trading arm of the Noise Abatement Society.



dyson airblade dB

The fastest, most hygienic hand dryer.

10 second dry time.

HEPA filter captures 99.95% of particles the size of bacteria.

Tested and certified by NSF.

Certified for use in food environments by HACCP International.

Tough and durable.

Contains antibacterial additive.

Cat No.	List Price	Disc Group
AB14 Grey	1753.11	9907
AB14 White	1753.11	9907

AB14 H 661mm W 303mm D 247mm

AB
14



Grey



White

dyson airblade V

The most hygienic hand dryer is now 35% quieter.²

Certified by Quiet Mark.

HEPA filters capture 99.95% of particles the size of bacteria.

Tested and certified by NSF.

12 second dry time.

Slim profile, no recessing required.

Small carbon footprint.

Contains antibacterial additive.

Cat No.	List Price	Disc Group
HU02 Sprayed nickel	1195.29	9907
HU02 White	1195.29	9907

HU02 H 394mm W 234mm D 100mm

HU
02



Sprayed nickel



White

dyson airblade tap

Airblade™ hand drying technology in a tap.

Wash and dry hands at the sink. No water dripped on the floor.

12 second dry time.

HEPA filter captures 99.95% of particles the size of bacteria.

Tested and certified by NSF.

Certified for use in food environments by HACCP International.

Costs just £48 to run per year.

Small carbon footprint.

Cat No.	List Price	Disc Group
WD04 Short	2213.52	9907
WD05 Long	2213.52	9907
WD06 Wall	2213.52	9907

WD04 H 158.5mm W 295mm D 280.5mm

WD05 H 308mm W 295mm D 280.5mm

WD06 W 295mm D 305mm



Long



Short



Wall

²Loudness reduction when compared to the original Dyson Airblade V hand dryer.



THE INDEPENDENTS' INDEPENDENT



Introducing the new water heating range from Elson

Instantaneous Handwash

EHW3

- 3kW
- Slimline design
- Combined on/off and temperature control
- Neon 'Power On' indicator
- Pre-set safety cut-out
- Instant hot water
- Swivel 200mm outlet
- Quick & easy installation
- H235xW151xD87mm



Cat No.	List Price	Disc Group
93020001	63.19	6108



Unvented Water Heater

EUV10 / EUV15

- 2.2kW
- 10 & 15 litre options
- Expansion relief valve
- Expansion vessel may be required
- Connected to mains water supply giving full mains pressure
- Quick & easy installation
- H415xW265xD264mm (EUV10)
- H445xW295xD296mm (EUV15)
- Both capacities ErP C rated



Cat No.	List Price	Disc Group
93050021 (EUV10)	122.42	6108
93050022 (EUV15)	134.19	6108



Oversink Vented Water Storage

EOS7

- 3kW
- 7 litre capacity
- 10-70°C adjustable thermostat
- Instant hot water
- Swivel 300mm outlet
- Quick & easy installation
- H356xW240xD240mm



Cat No.	List Price	Disc Group
93010001	116.46	6108



Boiling Water Dispenser

EBW25

- 2.5kW
- 2.5 litre capacity
- 14 cups (167ml) at one time
- Instant boiling water
- Quick & easy installation
- H445xW290xD190mm



Cat No.	List Price	Disc Group
93200001	421.25	6108

Elson Point of Sale Display Board

- Circa 120cm High
- Floor Standing Catalogue Dispenser
- Rigid Construction

Call your nearest branch for details!





ESRT5LED / ESRT5WIFILED
5 Series Programmable Room Thermostat

The ESRT5 is designed for time and temperature control of your heating. Comes with 7 day, 5/2 or 24 hour programming options, all in one unit with a factory-set programme which can be user modified.

The simple click on/off backplate is designed to be fully interchangeable throughout the entire 5 Series range and, with just a 5 volt connection, can be changed over safely without disconnecting the power or re-wiring.

Users can choose between TPI and Delayed Start energy saving features and select a landlord service interval for additional peace of mind. Wireless models are available (ESRT5RF) for an easy retrofit solution.

Cat No.	Description	List Price	Disc Group
ESRT5LED	Wired Flush Mounted	75.40	402
ESRT5WW	WiFi Wall Mounted	140.49	402
ESRT5WF	WiFi Flush Mounted	140.49	402
ESRT5RFWIFIP	Wireless RF with Stand	191.72	402

- Large, easy to read LCD with white back light
- 7 day, 5/2 or 24 hour operation all in one unit
- 2 on/off or 3 on/off per day
- Automatic BST/GMT 1 hour time change
- Factory set clock and date
- Easy to use overrides
- Fits on industry standard backplate
- Easy to use and quick to install



ES1247B
1 Channel Multi Purpose Programmer

Cat No.	List Price	Disc Group
ES1247B	49.14	402

The ES1247B is a single channel multi purpose programmer, designed for timed control of your heating & hot water. Ideal for use with a combination boiler or a single heating zone. It can also be used in conjunction with an existing programmer to control additional heating zones or for when additional hot water cylinder control is required.



ES2247B
2 Channel Multi Purpose Programmer

Cat No.	List Price	Disc Group
ES2247B	58.29	402

The ES2247B is a two channel multi purpose programmer, designed for separate control of your heating and stored hot water. The heating and hot water programmes are independent of each other, giving you the opportunity to operate the system in the most energy efficient and cost effective manner.



ES3247B
3 Channel Multi Purpose Programmer

Cat No.	List Price	Disc Group
ES3247B	62.04	402

The ES3247B is our top of the range three channel multi purpose programmer, offering three completely independent time controlled channels. Ideal for control of two individual heating zones and separate hot water control giving you the opportunity to operate the system in the most energy efficient and cost effective manner. The multi-channel capabilities enables installers to comply with Part L of the amended Building Regulations by providing separate timed heating control for living and sleeping zones whilst also providing timed control of hot water.



ESRT4 / ESRT4RF
Programmable Room Thermostat

Cat No.	List Price	Disc Group
ESRT4	41.91	402
ESRT4RF	92.73	402

- TPI Technology
- Large, easy to read LCD with blue back light
- Optimum Stop, Delayed & Optimum Start
- 7 day, 5/2 day or 24 hour programming options
- Holiday Mode
- 4 or 6 time and temperature events
- Automatic BST/GMT 1 hour time change
- Factory set clock and date
- Pre-set built in programme
- Wireless (ESRT4RF receiver)
- Easy to use overrides and quick to install



ESRTM
Mechanical Room Thermostat

Volt free contacts, audible click when dial is turned, industry standard backplate

Cat No.	List Price	Disc Group
ESRTM	12.84	402



ESCTDEB
Electronic Dual Hot Water Cylinder Thermostat

Accurate temperature control with weekly one hour "boost" kills legionella bacteria, wide user defined temperature range

Cat No.	List Price	Disc Group
ESCTDEB	32.84	402

ESPLUGWIFI
WiFi Smart Plug

Use the ESPLUGWIFI to switch any appliance ON/OFF from your mobile phone or tablet anywhere in the world! Energy usage can be easily monitored and costs calculated by an hour, day or month basis. With simple timers and schedules that can be repeated each week or as a one off, giving you complete control of your appliances and the energy they use.

ESPLUGWIFI is the smart way to power and monitor the energy your home uses.



Cat No.	List Price	Disc Group
ESPLUGWIFI	52.86	402

ESZV222L/ESZV282/ESZV223
2/3 Port Zone Valves



A direct replacement for the market leader, spring return action, detachable lead, manual lever for filling/draining the system replacement actuator head & motor, quiet operation, minimum power usage

Cat No.	Description	List Price	Disc Group
ESZV222L	22mm 2 Port Zone Valve	58.67	402
ESZV282N	28mm 2 Port Zone Valve	75.63	402
ESZV223P	22mm 3 Port Zone Valve	72.60	402

ESZVA222/ESZVA223
2/3 Port Actuator Heads

2 Port Actuator head - ESZVA222
3 Port Actuator head - ESZVA223

Cat No.	List Price	Disc Group
ESZVA222	35.63	402
ESZVA223	38.94	402

ESAVB
Automatic Air vent



3/8" and 1/2" BSP connections, Vacuum break to prevent air locks, 110°C operating temperature, 6 bar maximum working pressure

Cat No.	List Price	Disc Group
ESAVB	5.94	402

ESAVB15C
Automatic Air vent, Cylinder style



15mm compression fitting
110°C operating temperature,
6 bar maximum working pressure

Cat No.	List Price	Disc Group
ESAVB15C	5.61	402

ESABV22
Auto Bypass Valve



22mm compression fitting, reduces system noise, 16 bar maximum pressure, 120°C intermittent pressure, Up to 50 litres per minute flow rate, 0.05 to 0.5 pressure range

Cat No.	List Price	Disc Group
ESABV22	13.00	402

ESWC1
Wiring Centre

- Simplifies wiring & circuit testing
- Robust fire retardant ABS
- Dedicated terminal block for each system component



Cat No.	List Price	Disc Group
ESWC1	11.55	402

ESRTD2 / ESRTD3 / ESRTERFW
Electronic Room Thermostat with LCD display



- TPI Technology
- LCD display
- Double insulated
- Large, clear adjustable dial
- Surface mounted
- Temperature control accuracy of +/- 0.6°C
- Easy fit back plate
- Delay Start version (ESRTD3)
- Wireless (ESRTERFW receiver)



Cat No.	List Price	Disc Group
ESRTD2	28.39	402
ESRTD3	32.67	402
ESRTERFW	61.71	402

ESCTS
Clamp-on Cylinder Thermostat



Double insulated, Bimetallic sensor, wide temperature range, cylinder strap and hooks

Cat No.	List Price	Disc Group
ESCTS	14.59	402

Central Heating Protectors

GREAT VALUE

- Protects against corrosion and scale forming
- Gas savings of up to 15% can be achieved when Protector F1 is used with Cleaner F3
- Prevents sticking pumps and boiler noise
- Stops radiator cold spots

Cat No.	Description	List Price	Disc Group
23992	MB-1 Protector, 4 litre	41.07	2301
56599	Protector F1, 500ml	22.63	2301
62418	Protector F1 Express, 400ml	25.38	2301
56700	Protector F1 Superconcentrate Box, 290ml	33.93	2301
61033	Protector Alpha-11, 5 litre	37.96	2301
23980	Protector Alpha-11, 25 litre	179.40	2301
62234	Filter Fluid+ Protector, 500ml	23.10	2301
62310	Filter Fluid+ Protector Express, 400ml	25.19	2301



Equipment

- High temperature operation to 85°C
- Fast action – cleans the most heavily contaminated system in one site visit
- Easy to operate, lightweight and robust machine



Cat No.	Description	List Price	Disc Group
56779	Powerflow Flushing Machine MKIII, 50 litre	1250.00	-
62134	MaxMag tool to agitate sludge and magnetite collected at the bottom of radiators	46.06	2301
55568	Powerflow Pump head Adapter	143.44	2301
37641	Total Dissolved Solids Meter (TDS Meter)	81.67	2301

Central Heating Repair Products

- Reduces boiler noise
- Improves heat transfer efficiency
- Compatible with all FernoX Cleaners and Protectors
- Fast and simple to use – designed to be left in the system



Cat No.	Description	List Price	Disc Group
56602	Boiler Noise Silencer F2, 500ml	26.21	2301
62421	Boiler Noise Silencer F2 Express, 400ml	23.38	2301
56702	Boiler Noise Silencer F2 Superconcentrate Box, 290ml	33.01	2301

Test Kits

- Simple and accurate on-site testing of FernoX Protector level concentration
- Over 25 systems can be tested with every kit



Cat No.	Description	List Price	Disc Group
37906	Protector Test Kit	25.30	2301
38983	Water Analysis Kit for complete on-site analysis of system water quality	155.40	2301
61161	System Health Check (SHC) postal sampling water test service	42.78	2301

Limescale Remedies

- Restores efficiency to all types of water heater
- Powerful acid limescale remover - dissolves up to 50% of its own weight of limescale
- Corrosion inhibited and easy to use



Cat No.	Description	List Price	Disc Group
61027	DS-3 Limescale Remover, 2kg	26.12	2301
61015	Superconcentrate Limescale Preventer, 450g	22.97	2301
61013	Sterox (tablets), 345g	60.10	2301
56609	LP Sterox, 1 litre	46.18	2301
56726	LP Sterox Test Strips, x50	31.84	2301

Scale Reducers



Cat No.	Description	List Price	Disc Group
62303	Electrolytic Scale Reducer 15mm (push fit)	40.39	2301
58263	Electrolytic Scale Reducer 15mm (compression)	43.28	2301
62304	Electrolytic Scale Reducer 22mm (compression)	59.52	2301
62301	Magnetic Scale Reducer 15mm (push fit)	32.22	2301
58264	Magnetic Scale Reducer 15mm (compression)	35.19	2301
62302	Magnetic Scale Reducer 22mm (compression)	41.02	2301

Consumables



- Well established, proven and safe product
- Self cleaning - WRAS approved flux
- Suitable for use with both lead containing and lead-free solder alloys

Cat No.	Description	List Price	Disc Group
20437	Powerflow Flux, 100g	7.92	2301
20436	Powerflow Flux, 350g	14.90	2301
61001	Water Hawk, 200g	5.16	2301
61023	Water Hawk, 400g	7.50	2301
61025	Hawk White, 200g	3.43	2301
61024	Hawk White, 400g	5.07	2301
61016	LS-X External Leak Sealer & Jointing Compound, 50ml	6.94	2301

Central Heating Cleaners

GREAT VALUE

- Removes sludge, limescale and other debris
- Easy to use – hot or cold, the system can be left running normally during cleaning
- Fast acting cleaners for new and existing systems
- Express products doses in less than 30 seconds – ideal for maintenance

Cat No.	Description	List Price	Disc Group
56600	Cleaner F3, 500ml	21.28	2301
62420	Cleaner F3 Express, 400ml	28.09	2301
56701	Cleaner F3 Superconcentrate Box, 290ml	28.30	2301
56608	Powerflushing Cleaner F5, 1 litre	26.31	2301
61102	DS40 System Cleaner 1.9kg	50.90	2301
61009	System Neutraliser, 2kg	53.89	2301



Equipment

- Ideal for reducing pressure loss from systems
- Seals small leaks and weeps from inaccessible places
- Does not cause blockages in pumps or pipework



Cat No.	Description	List Price	Disc Group
56603	Leak Sealer F4, 500ml	22.03	2301
64222	Leak Sealer F4 Express 400ml	28.24	2301
56703	Leak Sealer F4 Superconcentrate Box, 290ml	33.53	2301

The TF1 Filter Range

- Award-winning in-line system filters
- When combined with Filter Fluid+ Protector optimum efficiency levels and extended system longevity can be achieved
- Removes both magnetic and non-magnetic debris
- Simple to install, maintain and service

Cat No.	Description	List Price	Disc Group
62414	TF1 Sigma Filter (slip socket) 22mm	100.00	2301
62415	TF1 Sigma Filter (with valves) 22mm	115.00	2301
62417	TF1 Sigma Filter (with valves) 28mm	145.00	2301
62416	TF1 Sigma Filter Installer's Pack (slip socket) 22mm	125.00	2301
62248	TF1 Omega Filter (slip socket) 22mm	106.73	2302
62251	TF1 Omega Filter (slip socket) 28mm	136.75	2302
62249	TF1 Omega Filter (with valves) 22mm	127.86	2302
62252	TF1 Omega Filter (with valves) 28mm	151.20	2302
62131	TF1 Compact Filter 22mm	126.33	2301
59256	TF1 Total Filter 22mm	130.18	2301
59257	TF1 Total Filter 28mm	147.31	2301
62169	TF1 Compact Filter Installer's Pack 22mm	158.18	2301



KEEP A LID ON COST...*

TF1 Sigma Filter

Next generation sealed plastic composite in-line filter



- Fast to install and clean
- Quality valves or Slip socket connection
- Powerful Neodymium magnet and Hydronic Particle technology
- Rapid dosing with Fernox Express products
- Fits vertical and horizontal pipework
- 22mm and 28mm fittings

* No ongoing hidden expense for replacement O-rings over the life of the system

AVAILABLE NOW



RedProtect

The revolutionary new chemical tablets and filtration system protecting against magnetic and non-magnetic contaminants that greatly exceeds Buildcert performance standards.



Ask Your Local H&V For More Details



T-Plus Brass

The T-plus is specially designed to create perfect branches quickly and easily, whilst the system remains in operation.

The design of the T-plus is unique and responds precisely to the requirements of installers and their customers. The combination of a plunger, striking pin and a trigger sets the new standard in the creation of branches for systems in operation.

The new branching mechanism (the trigger) means perfect installation everywhere, every time. Once the pin is removed, the charge ignites and the striking pin shoots straight forward. This makes a clean cut in the pipe creating the branch. This makes it possible to make branches even where there is little available space. There is no need to use a hammer any more.



Contraflex Expansion Vessel

For sealed heating installations (acc. to EN12828) and chilled water (cooling) installations. When the temperature in the installation rises, the system water will expand. The 'expansion water' is stored temporarily in the expansion vessel to keep the pressure in the installation at the correct level.

- Maximum working pressure: 3.0 or 6.0 bar
- Vessels in accordance with EN13831
- Suitable for systems with a maximum flow temperature of 120 °C
- Maximum temperature diaphragm: 70 °C
- Suitable for addition of glycol-based anti-freeze up to 50%
- In accordance with Pressure Equipment Directive 2014/68/EU
- Deep drawn steel vessel halves with zinc plated steel clench ring
- Contra-Flex 35 - 80: With feet.



Prescomano

Safety valves with pressure gauge for sealed central heating and chilled water (cooling) installations.

Prescor safety valves have a special shape which, not only achieves a perfect seal, but also provides a large blow off capacity. The valve seal is made of high quality rubber which is heat resistant to 140 °C and where the hardness of the rubber adjusts to the set pressure of the safety valve. In this way, the valve cannot stick to the seat.

All valves are tested before they leave our facility and are available for heating and cooling installations as well as for protection of various hot water storage appliances.





Cat No.	Description	List Price	Disc Group
RedProtect			
30057	RedProtect Filter (RP filter)	109.25	4002
30058	RedProtect Filter Set (RP filter set)	142.50	4002
30059	RedProtect Inhibitor Tablets (RP1)	18.50	4002
30060	RedProtect Inhibitor & Cleaner Tablets (RP1 & RP2)	36.00	4002



Auto Air Vent

Cat No.	Description	List Price	Disc Group
Auto Air Vents			
27750	3/8" Auto air vent	11.50	4002
27740	1/2" Auto air vent	11.84	4002
27780	1/8" Auto air vent	10.53	4002
27711	1/2" Auto air vent with bottom side entry	12.99	4002
28520	Flexvent Super, 1/2 Auto air vent	79.30	4002



FC Flexofit

Cat No.	Description	List Price	Disc Group
FC Flexofit			
24980	1/2" Flexofit, shock arrestor	39.64	4002



Pressure Reducing Valve

Cat No.	Description	List Price	Disc Group
Pressure Reducing Valves			
17441	1/2" Adjustable pressure reducing valve with gauge	142.68	4002
17442	3/4" Adjustable pressure reducing valve with gauge	155.87	4002
27684	PRESCOMANO, combined safety valve & gauge 1/2"	23.63	4001



Cubex Expansion Vessels + Kits

Cat No.	Description	List Price	Disc Group
Cubex Expansion Vessels + Kits			
16497	Complete 'A' kit 8 litre vessel + fitting kit	110.25	4001
16499	Complete 'A' kit 12 litre vessel + fitting kit	115.85	4001
16501	Complete 'A' kit 18 litre vessel + fitting kit	130.20	4001
16503	Complete 'A' kit 25 litre vessel + fitting kit	145.88	4001

Cupak B Kits are also available. The B Kits are identical to Pack A other than the safety valve is supplied separately to allow for remote installation.



T-Plus Brass

Cat No.	Description	List Price	Disc Group
T-Plus Brass			
90515	T-Plus Brass 15 x G1/2m	102.41	4001
90522	T-Plus Brass 22 x 1/2 x 22	135.52	4001
90528	T-Plus Brass 28 x RP 3/4	145.04	4001
90535	T-Plus Brass 35 x RP 3/4	150.33	4001
90542	T-Plus Brass 42 x RP 3/4	159.11	4001



Contraflex Expansion Vessels

Cat No.	Description	List Price	Disc Group
Contraflex Expansion Vessels			
26074	Contraflex 8/05 3B, 8 litre expansion vessel	26.75	4002
26136	Contraflex 12/05 3B, 12 litre expansion vessel	29.45	4002
26171	Contraflex 18/05 3B, 18 litre expansion vessel	35.44	4002
26241	Contraflex 25/05 3B, 25 litre expansion vessel	44.57	4002
26343	Contraflex 35/05 3B, 35 litre expansion vessel	57.75	4002
26493	Contraflex 50/05 6B, 50 litre expansion vessel	81.95	4002



Airfix potable vessel

Cat No.	Description	List Price	Disc Group
Airfix Potable Vessels			
24900	Airfix P 02, potable vessels	31.45	4002
24901	Airfix P 03, potable vessels	34.44	4002
24902	Airfix P 05, potable vessels	45.43	4001
24903	Airfix P 08, potable vessels	39.06	4002
24904	Airfix P 12, potable vessels	59.43	4001
24905	Airfix P 16, potable vessels	63.63	4001
24906	Airfix P 18, potable vessels	82.46	4001
24907	Airfix P 24, potable vessels	87.57	4001
24910	Airfix P 35, potable vessels	107.65	4002
24911	Airfix P 50, potable vessels	142.22	4002

PICK THE RIGHT TEAM



MEET THE NEW LINE UP

Grundfos understand that for you to be successful, you need the best team behind you so we have again improved our domestic circulator line up.

Replacing ALPHA2L, the new ALPHA1 delivers the highest efficiency on the market, whilst the new ALPHA3 delivers the same high efficiency but also includes wireless hydraulic balancing and set up direct to your smartphone, now without the need for a separate ALPHA Reader. (New ALPHA1 is also available as a stainless steel "N" version for DHW applications).

Superseding the market leading UPS2, the new UPS3 is built on a platform proven in millions of boilers. UPS3 keeps features like manual deblocking, robust startup and ceramic shaft / bearings, but adds a new plug, increased efficiency and, allowing more fast, first time fixes, replaces many OEM boiler pumps. Just scan an old pump with the Grundfos GO Replace app to confirm if UPS3 can be used. www.grundfos.co.uk/newteam

be
think
innovate

GRUNDFOS 

UPS3 15-50/65

ALPHA3 MODEL B



Cat No.	Description	List Price	Disc Group
Domestic Circulators			
99199622	UPS3 15-50/65	262.52	6406
99415672	ALPHA1 15-50/60	287.72	6406
99371966	ALPHA3 15-50/60	471.46	6406

UPS2 8M

MAGNA1



Cat No.	Description	List Price	Disc Group
Light Commercial Circulators			
98707848	UPS2 25-80	340.78	4401
98707851	UPS2 32-80	404.79	4401
99221216	MAGNA1 25-40 1½" BSPM	427.00	4401
99221217	MAGNA1 25-60 1½" BSPM	507.00	4401
99221213	MAGNA1 25-80 1½" BSPM	578.00	4401
99221214	MAGNA1 25-100 1½" BSPM	640.00	4401
99221215	MAGNA1 25-120 1½" BSPM	719.00	4401
99221234	MAGNA1 32-60 2" BSPM	614.00	4401
99221235	MAGNA1 32-80 2" BSPM	641.00	4401
99221236	MAGNA1 32-100 2" BSPM	702.00	4401

Conlift 1 LS



Cat No.	Description	List Price	Disc Group
Condensate Pumps			
98452219	Conlift pump 1 LS condensate removal	90.28	6406
97936173	Conlift pump 1 condensate removal	135.43	6406
97936176	pH+ flexible neutralisation unit upgrade	185.80	6406
97936177	Hose extension	59.73	6406
97936178	Refill pack	172.53	6406
97936209	Alarm PCB upgrade	146.00	6406

UPS15-50N

Comfort



Cat No.	Description	List Price	Disc Group
Hot Water Circulators			
97549426	UPS 15-50N Stainless Steel	254.88	4401
99164484	UP15-14B secondary hot water circulator	204.00	4401
99164487	UP15-14BA PM secondary hot water service circulator with Autoadapt	335.00	4401
99415696	ALPHA1 15-50 N high efficiency	355.00	6406

Sololift 2



Cat No.	Description	List Price	Disc Group
Sololift 2			
97775329	WC1, 1 Toilet plus one connection	483.98	6406
97775330	WC-3 1 Toilet plus up to three connections	635.38	6406
97775331	CWC-3 1 Toilet plus up to three connections	662.43	6406
97775332	C-3 Washing machine, dishwasher, shower	481.28	6406
97775333	D-2 Shower, wash basin	432.60	6406



Cat No.	Description	List Price	Disc Group
Shower Pumps			
98950216	Twin impeller regenerative 1.5 BAR (STR2-1.5 C)	244.76	4501
98950217	Twin impeller regenerative 2.0 BAR (STR2-2.0 C)	277.18	4501
98950218	Single impeller regenerative 2.0 BAR (SSR2-2.0 C)	205.49	4501
98950219	Twin impeller regenerative 1.5 BAR (STR2-1.5 CN)	533.54	4501
98950220	Twin impeller regenerative 2.0 BAR (STR2-2.0 CN)	1362.43	4501

Cat No.	Description	List Price	Disc Group
Water Boosting			
MD450200	Home Booster 4.5 Bar	2948.40	6406
MCST0200	Slave Tank 200L	1228.50	6406
59539509	UPA15-90N	300.30	6406
98562865	SCALA2 Booster Pump	564.10	4401

heatmiser®



Control of up to
32 Zones



Turns your heating
off when you leave



Automatically adjusts
the heat up time



Voice Control of your
Heating & Hot Water



Boiler Plus
Compliant

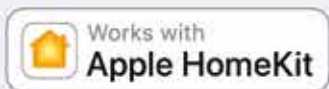

IFTTT

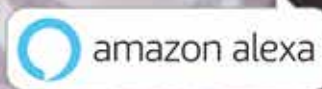

Control from Anywhere



Heatmiser Product Range

Cat No.	Description	List Price	Disc Group
Dial Type Thermostats			
DS1	Surface Mount Dial Thermostat	18.83	1234
DS1-L	Surface Mount Thermostat with Display	23.17	1234
DS-SB	Set Back Thermostat	34.42	1234
DS-SB PUBLIC	Set Back Thermostat	34.42	1234
Slimline Thermostats			
SLIMLINE V2	Multi-Mode Slimline Thermostat	46.17	1234
SLIMLINE-N V2	Multi-Mode Slimline Network Thermostat	47.92	1234
SLIMLINE-HW-N V2	Multi-Mode Slimline Network Thermostat with Hot Water	51.75	1234
SLIMLINE-E V2	Multi-Mode Slimline Electric Floor Thermostat (inc 3M Probe)	50.42	1234
Thermostats Edge			
EDGE	Multi-Mode Thermostat with Modbus	41.46	1234
EDGE-E	Multi-Mode Electric Floor Heating Thermostat with Modbus	46.54	1234
RF SENSOR	Wireless Air Temperature Sensor	12.50	1234
DOOR CONTACT	Window / Door Contact Sensor	15.83	1234
Touchscreen Thermostats			
TOUCH V2	Multi-Mode Touchscreen Thermostat	54.12	1234
TOUCH-E V2	Multi-Mode Touchscreen Electric Floor Heating Thermostat	59.21	1234
Battery Thermostats			
SLIMLINE-B	Battery Powered Programmable Thermostat	45.29	1234
Programmiers - Time Clocks			
TM1 V3	Single Zone Time Clock	40.67	1234
TM4-TS V2	4 Zone Time Clock	62.79	1234
TM1-NV3	12V Single Zone Time Clock	41.62	1234
Wireless Thermostats			
SLIMLINE RF V2	Multi-Mode Slimline RF Thermostat	45.00	1234
SLIMLINE RF KIT V2	Multi-Mode Slimline RF Thermostat with RF Switch Receiver	74.99	1234
NEOAIR BUNDLE	Bundle Includes neoAir, RF Switch and Desk Stand	91.67	1234
Wireless Receivers			
RF SWITCH	2 Channel RF Receiver	35.00	1234
RF SWITCH 16A	Electric Heating RF Receiver	38.29	1234
Fan Coil Thermostats			
EDGE HC	Fan Coil Thermostat with Key Card override	46.50	1234
EDGE HC MODBUS	Fan Coil Thermostat with Modbus connectivity	48.20	1234
NEOSTAT HC	Fan Coil Thermostat. Compatible with neoHub	62.00	1234
Neo			
NEOSTAT V2	neoStat - Available in Black, White and Silver Finishes	60.00	1234
NEOSTAT 12V	neoStat 12V - Available in Black, White and Silver Finishes	60.00	1234
NEOSTAT E V2	neoStat E - Available in Black, White and Silver Finishes	64.29	1234
NEOSTAT HW	neoStat HW - Available in Black, White and Silver Finishes	60.00	1234
NEOAIR	Wireless Neo - Available in Black, White and Silver Finishes	60.00	1234
NEOPLUG	neoPlug	34.00	1235
NEOULTRA	Central Control for the Neo System	125.00	1234
NEOHUB	HomeKit Enabled Neo Internet Gateway	125.00	1234
NEOKIT 1	HomeKit Enabled neoKit 1 - Heating Only - Available in Black or White	185.00	1234
NEOKIT 2	HomeKit Enabled neoKit 2 - Heating & Hot Water - Available in Black, White or Silver	241.66	1234
NEOKIT-E	HomeKit Enabled neoKit-E - Electric Floor Heating - Available in Black, White or Silver	189.17	1234
NEOAIR KIT	HomeKit Enabled Wireless neoAir Kit - Available in Black, White and Silver Finishes	217.50	1234
Underfloor Heating Accessories			
TA230	2 Wire Thermal Actuator	13.00	1234



DS-SB



SLIMLINE V2



EDGE



TOUCH V2



NEOAIR BUNDLE



NEOKIT 1



NEOULTRA

SUPREME

Modern white high-impact thermoplastic casing.
Food grade thermoplastic water container for longer life expectancy.
2.5kW heating element.



Cat. No.	Model	List Price	Disc Group
95200252	Supreme 150 2.5 litre, 10 cups at one time	870.73	4701
95200253	Supreme 165 5 litre, 20 cups at one time	1036.71	4701
95200254	Supreme 180 7.5 litre, 30 cups at one time	1146.03	4701

SUPREME SS

Food grade thermoplastic water container for longer life expectancy.
2.5kW heating element with improved Intelliboil™ management for boiling efficiency.



Cat. No.	Model	List Price	Disc Group
95200240	Supreme 150 SS 2.5 litre, 10 cups at one time	888.16	4701
95200241	Supreme 165 SS 5 litre, 20 cups at one time	1057.45	4701
95200242	Supreme 180 SS 7.5 litre, 30 cups at one time	1168.93	4701



HOTFLO / MULTIPOINT

Cat. No.	Model	ErP Rating	List Price	Disc Group
95050148	Hotflo 10, 10 litre 2.2kW	B	417.35	4707
95050149	Hotflo 15, 15 litre 2.2kW	B	463.73	4707
95050143	Multipoint 10, 10 litre 3kW	A	590.47	4703
95050145	Multipoint 10, 10 litre 4.5kW	A	614.55	4703
95050144	Multipoint 15, 15 litre 3kW	A	676.57	4703
95050146	Multipoint 15, 15 litre 4.5kW	A	704.16	4703
7693971	Multipoint Eco 30L 3kW Horizontal	B	1123.19	4703
7693979	Multipoint Eco 30L 3kW Vertical	A	889.27	4703
7693980	Multipoint Eco 50L 3kW Horizontal	B	1240.47	4703
7693981	Multipoint Eco 50L 3kW Vertical	B	914.33	4703
7693982	Multipoint Eco 80L 3kW Horizontal	B	1332.22	4703
7693983	Multipoint Eco 80L 3kW Vertical	B	1098.41	4703
7694024	Multipoint Eco 100L 3kW Horizontal	C	1503.16	4703
7694025	Multipoint Eco 100L 3kW Vertical	C	1231.75	4703

HOTFLO / MULTIPOINT

Unvented point of use hot water

Allows flexible siting meaning there is no requirement for a cold water cistern.
Can be used with standard or mixer taps and fed from the mains water supply.
Provides high hot flow rates.

HOTFLO / MULTIPOINT ACCESSORIES

Cat. No.	Model	List Price	Disc Group
95970352	Pack U1. Pressure limiter	95.72	4703
95970351	Pack U2. Comprises: expansion vessel, expansion & check valves for Multipoint	182.16	4703
95970354	Pack U3. Blending valve	158.64	4703
95970356	Pack U5. Expansion vessel and check valve for Hotflo	136.71	4703
95970359	Pack U6. Temperature and pressure relief valve for Hotflo	111.46	4703
95970360	Pack U7. Thermostatic blending valve	166.38	4703

AMPTEC

Electric flow boiler

4, 6, 9, 11 or 12kW rating.
Models for radiators or underfloor heating systems.
Suitable for use with standard pumps, programmers and room thermostats.
Suitable for use on sealed or open vented systems.
Compact size and lightweight for ease of installation.
Ease of operation with user adjustable thermostat and neon indicators.
No fluing requirements give installation flexibility.
Can be installed singly or as multiple installations.
Solid state electronics for reliability.



AMPTEC

Cat. No.	Model	ErP Rating	List Price	Disc Group
95022001	C400 boiler 4kW	D	660.88	4702
95022002	C600 boiler 6kW	D	660.88	4702
95022003	C900 boiler 9kW	D	921.99	4702
95022004	C1100 boiler 11kW	D	1095.42	4702
95022005	C1200 boiler 12kW	D	1121.00	4702
95022101	U401 Underfloor 4kW	D	660.88	4702
95022102	U601 Underfloor 6kW	D	660.88	4702
95022103	U901 Underfloor 9kW	D	921.99	4702
95022104	U1101 Underfloor 11kW	D	1095.42	4702
95022105	U1201 Underfloor 12kW	D	1121.00	4702

Contact your local branch
for a copy of our latest
brochure



HEATRAESADIA



HAIR DRYER



Cat. No.	Model	List Price	Disc Group
95020084	1kW element 1.4M flexible hose and swivel nozzle, timer with automatic switch-off	297.98	4702

EXPRESS AND UTC

Open outlet storage water heaters.



Cat. No.	Model	ErP Rating	List Price	Disc Group
95010160	Express 7. 1kW. Oversink	A	238.98	4704
95010161	Express 7. 3kW. Oversink	A	238.98	4704
95010162	Express 15. 3kW. Oversink	B	425.95	4704
95970103	Telescopic spout for Express 91	-	59.82	4703
95010702	UTC99 15L 1.5kW	B	624.98	4703
95010703	UTC99 15L 3kW	B	624.98	4703

STREAMLINE

Undersink units for use with option packs.
Oversink units are complete with spout and valve.



Cat. No.	Model	ErP Rating	List Price	Disc Group
95010280	Streamline 7 litre 1kW undersink	B	224.91	4703
95010282	Streamline 7 litre 3kW undersink	B	224.91	4703
95010284	Streamline 10 litre 1kW undersink	B	288.44	4703
95010286	Streamline 10 litre 3kW undersink	B	288.44	4703
95010281	Streamline 7 litre 1kW oversink	B	271.71	4703
95010283	Streamline 7 litre 3kW oversink	B	271.71	4703
95010285	Streamline 10 litre 1kW oversink	B	335.29	4703
95010287	Streamline 10 litre 3kW oversink	B	335.29	4703

POINT OF USE ACCESSORIES

Cat. No.	Model	List Price	Disc Group
95970513	Pack D. Telescopic spout	64.12	4703
95970514	Pack J. 2 Hole mixer tap	235.60	4703
95970515	Pack K. Monobloc mixer tap	123.27	4703
95970323	Pack M. Elbow pillar taps (pair)	673.86	4703
95970324	Pack P. Elbow basin taps (pair)	660.40	4703
95970325	Pack Q. 2 Hole elbow mixer tap	749.52	4703
95970516	Pack R. Pillar Taps (pair)	246.60	4703
95970317	Pack S/T. Basin Taps	196.54	4703
95970316	Pack Y. SH Lever Mixer Tap	386.75	4703
95970315	Pack X. SH Lever Basin Taps	360.96	4703
95970318	Pack W. SH Lever Pillar Taps	425.43	4703
95970115	Flow reducer for Streamline	25.65	4703
95970320	Streamline 1000	271.78	4703
95970321	Streamline 2000 with Waste	330.66	4703
95970322	Streamline 2000 with Waste & elbow	402.57	4703
95970347	Streamline 3000	232.05	4703

FBM ECO

Rectangular wall-mounted, adjustable thermostat,
left or right hand inlet / overflow.



Cat. No.	Model	ErP Rating	List Price	Disc Group
95040300	FBM Eco 25	B	1113.50	4703
95040301	FBM Eco 45	C	1379.53	4703
95040302	FBM Eco 70	C	1640.32	4703
95040303	FBM Eco 125	C	1877.28	4703

HANDY

Electric instantaneous handwash.



Cat. No.	Model	ErP Rating	List Price	Disc Group
95020115	Handy no touch 3.1kW	A	160.28	4702
95020113	Handy 3. 3.1kW	A	105.90	4702
95020114	Handy 7. 7.2kW	A	116.95	4702

HAND DRYERS



Cat. No.	Model	List Price	Disc Group
95020082	Handy Dri 14E. 1.4kW No touch	332.28	4702
95020090	Handy Dri 24 2.4kW White Heavy duty, vandal-resistant, auto infrared on/off, drying time 28 seconds	445.50	4702



A new chapter in programmable thermostats.



Easier to install with
a new wiring centre

Introducing the T4 Series.

The CM900 has been the installers' preferred choice for years. But things have moved on ... The good news is that the more intelligent Honeywell T4 Series shares the same DNA as the CM900 with TPI & optimisation features, plus:

- It has 1 and 7 day scheduling built in
- It has a larger screen, making it easier to read
- It's easy to wire with a new wiring centre designed for installers
- It's simple to programme with an intuitive interface
- It has OpenTherm capability built in
- Ideal for any system, any boiler

For more information about the intelligent T4 Series, please visit: honeywelluk.com

Lyric T6 Engineered for comfort

- Touch-screen interface** offers easy and optimal heating adjustment
- Access via a mobile device** lets customers have complete control, anytime, anywhere
- Smart automated boiler control** delivers better performance and superior energy efficiency
- Pre-configured scheduling** gives customers a choice of settings to suit their need
- Location-based programming (geo-fencing)** an additional automated layer of control, adjusting the customer's home heating based on their location



Lyric T6 Programmable thermostat

Cat No.	Description	List Price	Disc Group
Y6H910WF1011	Lyric T6 - Wired, Touch Screen, Wireless App Control, Geo-Fencing Technology	209.58	4901
Y6H910RW4022	Lyric T6R - Wireless RF, Touch Screen, App Control, Geo-Fencing Technology	233.03	4901
T6H700RW4011	T6R Wireless Thermostat Spare	205.32	4901
R6H911RF4018	Two Channel Wireless Receiver Box	130.58	4901
Y6H920RW4026	T6R-HW Smart Thermostat	275.60	4901



Lyric Series Wi-Fi Accessories

Cat No.	Description	List Price	Disc Group
HAWCIC1S	Lyric C1 - Wi-Fi Connected Security Camera	144.54	4901
W1KS	Lyric W1 - Wi-Fi Connected Water Leak & Freeze Detector	93.96	4901
W1AS	Lyric W1 - Accessory Cable Sensor 1.2m	28.92	4901



T4 Series Effortless temperature control

Cat No.	Description	List Price	Disc Group
T4H110A1021	T4 - Wired, 7 Day, 5/2 Day Programmable Thermostat	98.49	4901
Y4H910RF4003	T4R - Wireless RF, 7 Day, 5/2 Day Programmable Thermostat	189.05	4901
T4H310A3032	T4 - Wired Modulating, 7 Day, 5/2 Day Programmable Thermostat	132.87	4901



Y4H910RF4003

evohome Smart home controls

Cat No.	Description	Erp Class	List Price	Disc Group
ATF500DHW	evohome hot water kit		137.78	4901
ATP921R3100	evohome Wifi connected thermostat pack	VIII 5%	364.49	4901
HR92UK	evohome radiator controller		92.74	4901
HR924UK	evohome radiator multizone		331.20	4901
HR914	evohome radiator multizone		305.96	4901
HCC80R	Underfloor heating controller		450.76	4901
ATF800	evohome desk stand		87.38	4901
ATF600	evohome wall mount kit		63.96	4901
R8810A1018	Optentherm bridge		149.20	4901
Y87RF2024	Wireless digital thermostat	V 3%	147.38	4901
RFG100	Mobile access kit		85.18	4901
ATC928G3000	evohome controller (table stand not included)	VIII 5%	317.60	4901



ATP921R3100



ATF500DHW



HR924UK

evohome Security



Cat No.	Description	List Price	Disc Group
HS922GPRS	Connected Wireless Home Alarm Kit with GPRS	455.80	4901
HS911S	Connected Wireless Starter Home Alarm Kit	258.29	4901
HS912S	Connected Wireless Home Alarm Kit	379.83	4901
HS9HUBGPRS	evohome Security Hub	247.20	4901
TAG4S	Contactless Tags	30.36	4901
TCC800MS	Wireless Remote Control Key Fob	45.58	4901
TCPA1BS	Wireless Panic Button	45.58	4901
IRPI8EZS	Wireless Pet-Immune Motion Sensor	60.76	4901
CAMIR-8EZS	Wireless Motion Sensor with Camera	121.56	4901
FG8MS	Wireless Glass-Break Sensor	91.16	4901
DO8EZS	Wireless Door and Window Sensor	45.58	4901
DFS8MS	Wireless Smoke Sensor	106.36	4901
CO8MS	Wireless Carbon Monoxide Sensor	150.92	4901
SI800MS	Wireless Battery Internal Siren	121.56	4901
SEF8MS	Wireless Battery Siren	212.72	4901

Thermostats

Wired and wireless



Cat No.	Description	Erp Class	List Price	Disc Group
CMT707A1029	CM707 7 Day prog stat wired, service reminder, optimum start	IV 2%	107.29	4901
CMT727D1016	CM727 7 Day prog stat wireless, with service reminder & optimum start RF	V 3%	104.23	4901
DT90E1012	DT90 Wired digital room thermostat 24-230V AC with TPI control	IV 2%	49.56	4901
DT92E1000	Wireless Room Stat	V 3%	139.60	4901
Y87RF2024	Wireless digital thermostat	V 3%	147.38	4901
L6188A2002U	Single aquastat 25-95°C with well		76.72	4901
L6188A2036U	Single aquastat 70-140°C with well		88.25	4901
L6188A2044U	Tradeline aquastat 40-110°C without well		113.47	4901
L6188C2008U	Single limit aquastat 70-140°C without well + MR + 1.5m cap		100.67	4901
L641A1039	Cylinder stat 40-80°C (Y & S Plan Cylinder/stat)		32.49	4901
L641B1004	Pipe stat Low Limit 10-40°C with tamperproof cover		43.72	4901
L641B1012	Pipe stat SPDT 50-95°C high limit with tamperproof cover		43.72	4901
T4360A1009	Frost thermostat SPST 3-25°C		33.87	4901
T4360E1018	Room stat SPST with N.S.B		47.96	4901
T6360B1028	Room stat SPDT 10-30°C 10A (Y & S Plan Room/stat)	I 1%	27.40	4901
T6360B1036	Room stat SPDT with neon indicator lamp	I 1%	33.60	4901
T6360B1069	Tamperproof room stat SPDT 2 Amp		38.96	4901

Programmings & Timers Heating & hot water control

Cat No.	Description	List Price	Disc Group
ST9100A1008	1 Day timer, volt free	73.96	4901
ST9100S1007	1 Day service timer, volt free	88.74	4901
ST9100C1006	7 Day timer, volt free relay, holiday mode	86.63	4901
ST9400A1002	1 Day 2 channel programmer	104.56	4901
ST9400S1001	1 Day 2 channel service programmer	125.49	4901
ST9400C1000	7 Day 2 channel programmer holiday mode	113.00	4901
ST9500C1015	7 Day 2 zone programmer, large LCD, holiday mode	113.00	4901
ST699B1002	Programmer 24hr 2 on/off	155.98	4901
ST799A1003	Programmer 7 day 2 on/off	166.38	4901



ST9400



ST699B1002

Wired Sundial Control Installer packs

Cat No.	Description	List Price	Disc Group
Y609A1003	Boxed Y Plan with 24hr programmer	215.92	4901
Y609A1029	Boxed Y Plan with 7 day programmer	237.94	4901
Y609A1037	Boxed S Plan with 24hr programmer	278.58	4901
Y609A1045	Boxed S Plan with 7 day programmer	292.05	4901



Wireless Sundial RF2 Control packs

Cat No.	Description	Erp Class	List Price	Disc Group
Y9120H2009	Pk 1 - 1 ch. heating pack - ST9120C + DT92E	IV 2%	221.00	4901
Y9420H1008	Pk 2 - 2 ch. heating pack - ST9420C + DT92E	IV 2%	241.09	4901
Y9420S2005	Pk 3 - 2 ch.system pack ST9420C + DT92E + CS92A	V 3%	341.54	4901
Y9120W1000	Pk 4 - 1 ch. HW pack ST9120C + CS92		221.00	4901
Y9520Z1007	Pk 5 - 2 zone pack ST9520C + 2xDT92	V 3%	341.54	4901



Y9420S2005

Motorised Valves and valve spares

Cat No.	Description	List Price	Disc Group
V4043H1056/U	2 Port zone valve 22mm SRC 5 wire. S Plan valve	106.23	4901
V4043H1106/U	2 Port zone valve 28mm SRC 6 wire	147.03	4901
V4044C1288/U	Diverter valve 22mm 3 wire 3 port	142.92	4901
V4073A1039/U	Mid-position valve 22mm 3 port, Y Plan valve	150.76	4901
V4073A1088/U	Mid-position valve 28mm 3 port	187.29	4901
272742A/U	Ball on card, replacement ball for Honeywell valves	9.74	4901
40001011-002/U	Synchron motor 24V spare for V4043/V4073 valves	58.36	4901
40002737-003/U	Synchron motor 240V for V4044C, V4073A & V4043H	46.72	4901
40003916-001/U	V4043H Replacement power head	78.58	4901
40003916-002/U	V4044C Replacement power head	109.43	4901
40003916-003/U	V4073A Replacement power head	127.27	4901
40003918-006/U	Sealing plate & ball for V4043H valves	22.27	4901
40003918-007/U	Sealing plate & ball for V4044C & V4073A valves	22.27	4901



V4043



V4073



V4073A

Accessories and thermocouples

Cat No.	Description	List Price	Disc Group
42002116-002	Junction box	8.87	4901
42005748 001	Wiring centre	22.87	4901
EA122-AB	Auto air vent 1/8" - 3/8" with 1/2" adaptor	17.45	4901
K42008628-001KIT	Frost stat protection kit, (T4360A+L641B)	68.80	4901
TG510A1001/U	Universal thermostat guard (small)	39.27	4901
TG511A1000/U	Universal thermostat guard (large)	41.00	4901
Thermocouples			
Q309A2788	36" Tradline thermocouple	11.16	4901

Manual Valve and matching lockshield

Cat No.	Description	List Price	Disc Group
VHL120-08A	Manual Valve + Lockshield: 8mm Angled Body	24.05	4901
VHL120-08S	Manual Valve + Lockshield: 8mm Straight Body	21.27	4901
VHL120-10A	Manual Valve + Lockshield: 10mm Angled Body	24.05	4901
VHL120-10S	Manual Valve + Lockshield: 10mm Straight Body	29.49	4901
VHL120-15A	Manual Valve + Lockshield: 15mm Angled Body	22.60	4901
VHL120-15A-D	Manual Valve + Lockshield: 1 x Drain-off Tail Piece 15mm Angled Body	24.72	4901
VHL120-15A-DP	Manual Valve + Lockshield: 1 x Drain-off Tail Piece 2 x 10mm Push fittings; 15mm Angled Body	33.58	4901
VHL120-15A-P	Manual Valve + Lockshield: 2 x 10mm Push fittings; 15mm Angled Body	29.49	4901
VHL120-15S	Manual Valve + Lockshield: 15mm Straight Body	26.76	4901
VHL120-15S-D	Manual Valve + Lockshield: 1 x Drain-off Tail Piece 15mm Straight Body	30.18	4901
VHL120-15S-DP	Manual Valve + Lockshield: 1 x Drain-off Tail Piece; 2 x 10mm Push fittings; 15mm Straight Body	41.00	4901
VHL120-15S-P	Manual Valve + Lockshield: 2 x 10mm Push fittings; 15mm Straight Body	34.96	4901

TRV 'Traditional' and lockshield

Cat No.	Description	List Price	Disc Group
T1001W0GB	TRV Fixed head for VT117E was T100-353	20.47	4901
VT15-15A/B	Traditional TRV Bulk Pack; 15mm Angled Body	188.34	4901 new
VT15-10A/B	Traditional TRV Bulk Pack; 10mm Angled Body	224.98	4901 new
VTL15-15A/B	Traditional TRV Bulk Pack; + Lockshield 15mm Angled Body	273.76	4901 new
VTL15-10A/B	Traditional TRV Bulk Pack; + Lockshield 10mm Angled Body	375.07	4901 new
VTL15-15S/B	Traditional TRV Bulk Pack; + Lockshield 15mm Straight Body	375.07	4901 new
VT117-15A	Traditional TRV; 15mm Angled Body	27.77	4903
VT117-15S	Traditional TRV; 15mm Straight Body	24.00	4901
VTL120-08A	Traditional TRV; + Lockshield: 8mm Angled Body	25.34	4901
VTL120-08S	Traditional TRV; + Lockshield: 8mm Straight Body	30.80	4901
VTL120-10A	Traditional TRV; + Lockshield: 10mm Angled Body	25.34	4901
VTL120-10S	Traditional TRV; + Lockshield: 10mm Straight Body	30.80	4901
VTL120-15A	Traditional TRV; + Lockshield: 15mm Angled Body	22.60	4901
VTL120-15A-D	Traditional TRV + Lockshield: 1 x Drain-off Tail Piece 15mm Angled Body	26.03	4901
VTL120-15A-DP	Traditional TRV + Lockshield: 1 x Drain-off Tail Piece, 2 x 10mm Push fittings; 15mm Angled Body	34.92	4901
VTL120-15A-P	Traditional TRV + Lockshield: 2 x 10mm Push fittings; 15mm Angled Body	30.80	4901
VTL120-15S	Traditional TRV + Lockshield: 15mm Straight Body	28.07	4901
VTL120-15S-D	Traditional TRV + Lockshield: 1 x Drain-off Tail Piece 15mm Straight Body	31.49	4901
VTL120-15S-DP	Traditional TRV + Lockshield: 1 x Drain-off Tail Piece; 2 x 10mm Push fittings; 15mm Straight Body	40.36	4901
VTL120-15S-P	Traditional TRV + Lockshield: 2 x 10mm Push fittings; 15mm Straight Body	36.27	4901



42002116-002



Q309A2788

EA122-AB



VHL120



VT15



VTL120

TRV 'Classic' and lockshield

Cat No.	Description	List Price	Disc Group
T4021GB	TRV Fixed head for VT200E Classic Chrome	26.38	4901
VT200-15A	Classic TRV; 15mm Angled Body	25.78	4901
VT200-15S	Classic TRV; 15mm Straight Body	28.52	4901
VTL200-08A	Classic TRV; + Lockshield: 8mm Angled Body	35.07	4901
VTL200-10A	Classic TRV; + Lockshield: 10mm Angled Body	35.07	4901
VTL200-10S	Classic TRV; + Lockshield: 10mm Straight Body	40.52	4901
VTL200-15A	Classic TRV; + Lockshield: 15mm Angled Body	32.34	4901
VTL200-15A-D	Classic TRV + Lockshield: 1 x Drain-off Tail Piece 15mm Angled Body	35.76	4901
VTL200-15A-DP	Classic TRV + Lockshield: 1 x Drain-off Tail Piece 2 x 10mm Push fittings; 15mm Angled Body	44.60	4901
VTL200-15A-P	Classic TRV + Lockshield: 2 x 10mm Push fittings; 15mm Angled Body	40.52	4901
VTL200-15S	Classic TRV + Lockshield: 15mm Straight Body	37.78	4901
VTL200-15S-D	Classic TRV + Lockshield: 1 x Drain-off Tail Piece 15mm Straight Body	43.27	4901
VTL200-15S-DP	Classic TRV + Lockshield: 1 x Drain-off Tail Piece; 2 x 10mm Push fittings; 15mm Straight Body	52.58	4901
VTL200-15S-P	Classic TRV + Lockshield: 2 x 10mm Push fittings; 15mm Straight Body	45.98	4901



VTL200

evohome Radiator controller

Cat No.	Description	List Price	Disc Group
HR92UK	evohome radiator controller	92.74	4901
HR924UK	evohome radiator multizone	331.20	4901
HR914	evohome radiator multizone	305.96	4901



HR92UK

Valves

Cat No.	Description	List Price	Disc Group
Thermostatic Radiator Valves			
VT15AG	Radiator Thermostatic Radiator Valve; reversible flow; angled body; 8mm	17.74	4901
VT15BG	Radiator Thermostatic Radiator Valve; reversible flow; angled body; 10mm	17.74	4901
VT15EG	Radiator Thermostatic Radiator Valve; reversible flow; angled body; 15mm	20.40	4903
Thermostatic Mixing Valves			
TM200VP-3/4E	Thermostatic mixing TMV3 valve 15mm	96.18	4901
TM200VP-3/4H	Thermostatic mixing TMV3 valve 22mm	118.83	4901
TM200VP-3/4ZC	TMV3 Thermostatic mixing valve 4in1 15mm	125.29	4901
TM200VP-3/4ZD	TMV3 Thermostatic mixing valve 4in1 22mm	139.60	4901
Auto By-Pass Valves			
DU144A1001	Straight automatic by-pass valve, 22mm compression	55.00	4901
DU145-3/4B	Angled automatic by-pass valve, 22mm compression	55.00	4901
DU146-3/4E	Angled automatic by-pass valve, 3/4" BSPF	83.20	4901
DU146-11/4E	Angled automatic by-pass valve, 1 1/4" BSPF	164.29	4901
Pressure Reducing Valves			
DO4FM-1/2ZGC	PRV 15mm Compression, 1.5 to 6 bar outlet range with gauge	38.16	4901



VT15EG



TM200VP



DU145

DU144



DO4FM-1/2ZGC



H&V Inhibitor 1L

HV100

H&V Inhibitor gives long term protection of domestic central heating systems against internal corrosion and limescale formation. It prevents corrosion of all metals found in these systems.

- Central Heating Inhibitor for mixed-metal domestic central heating systems
- Protects against corrosion and limescale
- Reduces boiler noise
- Stops frequent venting of radiators
- Extends system life
- Prevents sticking pumps
- Saves on fuel bills
- Reduces maintenance costs
- Maintains system efficiency
- Prevents cold spots in radiators
- Non-toxic, environmentally friendly

Cat no.	List price	Disc Group
HV100	8.35	5402

H&V Cleanser 1L

HV800

H&V Cleanser is a neutral, nonhazardous product that is well inhibited and compatible with all metals and materials commonly used in heating systems.

- Neutral universal cleanser for pre-commissioning new systems in accordance with BS7593:1992
- Removes sludge and scale and restores heating efficiency of existing systems
- Removes flux residues and other debris
- Compatible with all metals and materials commonly used in heating systems
- Easy to use, system can be left running normally during cleansing
- Suitable for use with all known power flushing machines
- Neutral, non-hazardous formula

Cat no.	List price	Disc Group
HV800	8.65	5402

The C-Stat range is Boiler Plus Compliant

The Horstmann range of products offers a solution for both combi and non-combi boiler installations, meaning you can continue to fit the thermostats and time controls you know and love, safe in the knowledge that your installation will meet the new building regulations.

Are you?



C-Stat 17-B
C-Stat 17-M
C-Stat 17-ZW

**BOILER
PLUS
COMPLIANT**

Boiler Plus regulations:

When installing a new or replacement boiler you need to:

- Ensure that the system meets minimum standards for boiler interlock, time and temperature control, as would be done for a new system.
- When installing a Gas Combination boiler only in existing dwellings a minimum of one of the following should also be installed:
 - Flue gas heat recovery system or
 - Weather compensation or
 - Load compensation or
 - Smart thermostat with automation & optimisation

- On screen user instructions
- Reliable Z Wave wireless connection (RF)
- Choice of 24 hr or 7 day version
- Reduced energy costs
- No disruption to décor
- Battery & Mains versions available
- Boiler Plus Compliant

If you are installing a Gas Combination boiler (including LPG) to meet Boiler Plus compliance, any product from the C-Stat range can be installed.

HORSTMANN

www.horstmann.co.uk

Programmable room thermostats

ThermoPlus AS2-RF

Wireless programmable stat



ErP Class
I
+1%

Cat no.	Mains Powered	Battery Powered	Braille	LED Display	RF	List price	Disc Group
AS2-RF		•	•	•	•	164.31	8001
AS1	•		•	•		81.08	8001
AS2		•	•	•		85.02	8001

C-Stat programmable room stat

Wireless, battery & mains versions

BOILER PLUS COMPLIANT

ErP Class
IV
+2%



Cat no.	24hr	7 day	2 Wire Connection	Battery Powered	Mains Powered	Wireless	List price	Disc Group
C-Stat 17-B		•	•	•			87.87	8001
C-Stat 17-M		•			•		94.66	8001
C-Stat 17-ZW		•				•	140.00	8001

Room thermostats



HRT4-A

ErP Class
IV
+2%



HRT4-B

ErP Class
IV
+2%



HRT4-ZW

ErP Class
IV
+2%



HTT4

ErP Class
IV
+2%



HFT4

ErP Class
IV
+2%



HRT3

ErP Class
I
+1%



HCT2

CentaurPlus C17-ZW

ErP Class
IV
+2%

Combined wireless room stat and time control



List price 135.76
Disc Group 8001

Cat no.	Description	List price	Disc Group
HRT4-A	Mains powered electronic stat	23.78	8001
HRT4-B	Battery powered electronic stat	45.15	8001
HRT4-ZW	Wireless electronic stat with receiver	92.06	8001
HTT4	Mains powered tamperproof stat	29.73	8001
HFT4	Mains powered frost stat	27.32	8001
HRT3	Mains powered mechanical thermostat	17.33	8001
HCT2	Cylinder stat	18.73	8001

BOILER PLUS COMPLIANT

Excluding HRT3 & HCT2

Central heating programmers



ChannelPlus H47XL



ChannelPlus H37XL



ChannelPlus H27XL



ChannelPlus H17XL



425 Coronet



425 Diadem & 425 Tiara



CentaurPlus C17



CentaurPlus C27

Cat no.	Model Type	Description	List price	Disc Group
H47XL	ChannelPlus	4 channel, 7 day electronic	212.26	8001
H37XL	ChannelPlus	3 channel, 7 day electronic	153.67	8001
H27XL	ChannelPlus	2 channel, 24hr or 7 day electronic	88.78	8001
H17XL	ChannelPlus	Single channel, 24hr or 7 day timeswitch	73.29	8001
425C	Coronet	Single circuit timeswitch	71.16	8001
425T	Tiara	Twin circuit hot water/heating programmer	80.14	8001
425D	Diadem	Twin circuit hot water/heating programmer with neon lights	82.57	8001
C17	CentaurPlus	Single channel, 24hr or 7 day timeswitch	60.08	8001
C27	CentaurPlus	Two channel, 24hr or 7 day programmer	66.19	8001
S17	ServicePlus	Single channel, 24hr or 7 day timeswitch	79.10	8001
S27	ServicePlus	Two channel, 24hr or 7 day programmer	75.30	8001

Electric heating timers and boost controls



E7Q



Electronic 7



Electrisaver E30

Cat no.	Description	List Price	Disc Group
E7Q	Economy 7 timer and boost control	103.16	8002
Electronic 7	Digital version of E7Q	101.33	8002
Electrisaver E30	Electronic boost timer 30 minutes, 1 or 2 hour	39.44	8002

Motorised zone valves



Z222



Z228



Z322

Cat no.	Description	List price	Disc Group
Z222	22mm 2 Port Valve	71.98	8001
Z228	28mm 2 Port Valve	118.13	8001
Z322	22mm 3 Port Valve	99.02	8001

SMOKE ALARMS

FIREX



ENERGY SAVING
70%

*compared to previous Firex alarms

Firex Mains-powered Smoke and Heat Alarms

The popular Firex mains alarm range gets bigger with the inclusion of the long-life sealed in Lithium battery option of the ionisation, optical and heat models. And all now offer 70% Reduced Energy Consumption for lower lifetime running costs!

Cat No.	Sensor type	Back-up (battery)	Warranty (yrs)	List Price	Disc Group
KF10	Ionisation	Alkaline	6	17.19	9908
KF10R	Ionisation	Rechargeable Lithium	6 inc battery	39.79	9908
KF10LL	Ionisation	Sealed-in Lithium	6 inc battery	26.73	9908
KF20	Optical	Alkaline	6	28.67	9908
KF20R	Optical	Rechargeable Lithium	6 inc battery	53.52	9908
KF20LL	Optical	Sealed-in Lithium	6 inc battery	37.83	9908
KF30	Heat	Alkaline	6	33.52	9908
KF30R	Heat	Rechargeable Lithium	6 inc battery	54.79	9908
KF30LL	Heat	Sealed-in Lithium	6 inc battery	41.75	9908
SMK4896	Volt-free relay – Firex and Slick			1.75	9908
REMTH	Wired remote test + hush – Firex and Slick			33.19	9908

Slick® Fast Fit Mains-powered Smoke and Heat Alarms

Wirelessly interconnect up to 15 alarms using the RF SFTP wireless pattress, Kidde's Slick premium alarms are fast-fit and can be remotely tested using the wireless remote test and hush accessory (RTH RF).

Cat No.	Sensor type	Back-up (battery)	Warranty (yrs)	List Price	Disc Group
15FW	Ionisation	Duracell Alkaline	6	17.85	9908
15FWR	Ionisation	Rechargeable Lithium	10 inc battery	38.08	9908
25FW	Optical	Duracell Alkaline	6	28.77	9908
25FWR	Optical	Rechargeable Lithium	10 inc battery	53.13	9908
35FW	Heat	Duracell Alkaline	6	39.29	9908
35FWR	Heat	Rechargeable Lithium	10 inc battery	56.00	9908
RF SFTP	Wireless pattress	Rechargeable Lithium	10 inc battery	61.73	9908
RTH RF	Wireless remote test + hush	Lithium	5	63.52	9908

10-year sealed-in battery Optical Smoke Alarm

A long-life option – never need to change the battery for the full life of the product – ideal for social landlord installations.

Cat No.	Sensor type	Back-up (battery)	Warranty (yrs)	List Price	Disc Group
10Y29	Optical	Sealed-in Lithium	10 inc battery	18.88	9908

Battery Smoke Alarms

A convenient range of self-install 4" and 5" alarms manufactured to a high quality and with helpful features such as an Escape Light (99080).

Cat No.	Sensor type	Back-up (battery)	Warranty (yrs)	List Price	Disc Group
DY29B	Optical	Zinc + Alkaline	5	17.25	9908

new



HOME PROTECT HALLWAY

Long life optical smoke alarm with sealed-in Lithium battery that lasts the full 10-year life of the alarm and never needs to be replaced. Includes a high intensity emergency safety light to help guide you to safety in the event of a fire in the home.

Model	Sensor type	Battery	Warranty (yrs)	List Price	Disc Group
WFPL	Optical	Sealed-in Lithium	10	30.77	9908



HOME PROTECT LIVING AREA

Long life optical smoke alarm with sealed-in Lithium battery that lasts the full 10-year life of the alarm and never needs to be replaced.

Model	Sensor type	Battery	Warranty (yrs)	List Price	Disc Group
WFP	Optical	Sealed-in Lithium	10	23.10	9908





All Kidde products are BSI or LPCB certified. Those certified to the appropriate BS standard carry the Kitemark for confidence

CO ALARMS

10-year sealed-in battery Carbon Monoxide Alarms

A long-life option – never need to change the battery for the full life of the product – plus digital display for peak level monitoring.

Cat No.	Sensor type	Back-up (battery)	Warranty (yrs)	List Price	Disc Group
10LLCOB	Non digital	Sealed-in Lithium	10 inc battery	27.63	3510
10LLDCOB	Digital display	Sealed-in Lithium	10 inc battery	28.75	3510



Battery Carbon Monoxide Alarms with Hush™ feature

Manufactured using Kidde's own CO cells for consistency and quality, these convenient, portable alarms also offer a digital display version.

Cat No.	Type	Back-up (battery)	Warranty (yrs)	List Price	Disc Group
5COLSB	Test / reset	Alkaline	7	18.23	3510
7COB	Test / reset – Box	Alkaline	10	20.65	3511
7COC	Test / reset – Clamshell	Alkaline	10	20.04	3511
7DCOC	Digital display +Test / reset	Alkaline	10	26.83	3510



Mains-powered Carbon Monoxide Alarms

Interlink with the Slick premium range using the unique Smart Interconnect feature, for wide area protection.

Cat No.	Type	Back-up (battery)	Warranty (yrs)	List Price	Disc Group
4MCO	230V Mains	Rechargeable Lithium	6 inc battery	62.44	9908
4MDCO	230V Mains + Digital display	Rechargeable Lithium	6 inc battery	70.98	3510
PATCO	Wireless pattress for 'Slick' CO alarms		N/A	2.81	9908



Combination CO and Smoke Alarm

A single unit that features a unique Voice Alarm to warn of which danger has been identified. It also has a front-loading battery compartment for easy changing of Alkaline battery

Cat No.	Sensor type	Back-up (battery)	Warranty (yrs)	List Price	Disc Group
10SCO	Optical / Electrochemical	Alkaline	10	30.67	3510



Fire Safety Fire Extinguishers/Blanket

Complete the protection package with these fire safety products – every contractor should stock a selection to complement the Kidde alarms range.

Cat No.	Type	Weight/Size	List Price	Disc Group
KSPD2G	Dry powder	2Kg	36.13	9908
FB1	Cloth Fire Blanket	1.0 x 1.0m	24.50	9908



Home Safety Pack CO + Smoke Alarms

The ideal solution – a pair of battery alarms in one pack: the popular 29HD smoke and 5CO carbon monoxide alarms (see above for details).



Cat No.	List Price	Disc Group
COSAC	26.67	3510

new

HOME PROTECT BEDROOM

Long life optical smoke alarm with sealed-in Lithium battery that lasts the full 10-year life of the alarm and never needs to be replaced. Includes a voice alarm to tell you of the detection of smoke.

Model	Sensor type	Battery	Warranty (yrs)	List Price	Disc Group
WFPV	Optical	Sealed-in Lithium	10	24.54	9908



HOME PROTECT KITCHEN

Offers detection of both smoke and carbon monoxide in a single alarm. Its sensors interact to distinguish between non-harmful cooking fumes or steam and real fires, therefore reducing nuisance alarms and making this alarm ideal for the kitchen.

Model	Sensor type	Battery	Warranty (yrs)	List Price	Disc Group
WFPCO	Optical	Sealed-in Lithium	10	35.94	9908



Electric Ladder Towel Rails

STRAIGHT STANDARD

- Ready to be wired
- Available in Fixed Temperature (Standard), Adjustable Temperature (Thermostatic) and Low Surface Temperature (LST) models
- IP55 - Suitable for installation in IEE Zones 1 & 2 and outside areas
- Sealed cartridge element (replaceable)



STRAIGHT LIQUID FILLED TOWEL RAIL

Cat No.	Colour	Width (mm)	Height (mm)	Watts	List Price	Disc Group
KTR150STDCHR	Chrome	400	700	150	97.75	3527
KTR200STDCHR	Chrome	500	800	200	131.00	3527
KTR250FLATCH	Chrome	500	1100	250	126.10	3527
IP Rating	IP55	Cable Length	1000mm			

ACCESSORIES

Dual fuel element kits comprise an electrical cartridge element with 1000mm cable and fittings to convert a standard a central heating towel rail to electric only or electric and central heating. To convert to electric only, there is a blanking plug supplied and the T piece can be discarded. To convert to dual fuel, the T piece can take the element and a radiator valve and the blanking plug can be discarded. They are fixed temperature with a built-in thermostat. They also incorporate a thermal fuse as a safety feature. These kits can also be used as replacements for the standard towel rails. IP55 rated.



Element kit



KWC
towel rail wall controller

Wall controllers offer basic control of the surface temperature for standard towel rails. The controller is not thermostatic and functions by reducing the amount of time the element is actually heating. There are 5 different power settings and a 2 hour button. Fits a standard single back box. IPX4 rated.

ACCESSORIES

Cat No.	Description	List Price	Disc Group
KWC	White Towel Rail Wall Controller	48.78	3528
KWCCH	Chrome Towel Rail Wall Controller	59.00	3527
K150ELEMENT	150W Element Kit	25.14	9906
K250ELEMENT	250W Element Kit	25.14	9906
K400ELEMENT	400W Element Kit	25.76	9906



Generation 2



The latest Generation 2 Lightwave devices offer all new home control features including 2-way communication, in-built energy monitoring, colour changing LEDs and improved all round performance. Generation 2 devices are controlled via the new Link Plus and Link Plus App, which also includes new features such as automations, triggers and intelligent, wireless 2-way switching. The Link Plus can also control existing Lightwave Generation 1 devices and can be voice controlled using Apple HomeKit, Google Assistant or Amazon Alexa.

Lightwave Link Plus

- Connects to home Wi-Fi router
- Allows remote control access
- Syncs to any Lightwave device
- Compatible with Gen 1 & 2
- Voice control with HomeKit / Alexa / Google



Cat No	List Price	Disc Group
L2	287.39	6110

Smart Dimmer

- LED compatible single or double dimmers
- 2-way communication
- Wireless 2-way switching
- Built in energy monitoring



Cat No	List Price	Disc Group
L21	132.60	6110
L22	221.03	6110

Smart Socket

- 13A rated double socket
- Lockable buttons for safety
- 2-way communication
- Built in energy monitoring
- Customisable colour LEDs



Cat No	List Price	Disc Group
L42	132.60	6110

Generation 1

Lightwave Link

- Connects to your home broadband Wi-Fi router
- Allows remote control access
- Syncs to any Lightwave device



Cat No	List Price	Disc Group
LW930	166.22	6110

Socket

- Single or double sockets
- Available in white, chrome, black chrome and stainless steel
- Easy to install using existing wiring circuits
- 35mm back box is recommended



Cat No	Description	List Price	Disc Group
LW260WH	1 Gang, White	64.66	6110
LW260BLK	1 Gang, Black chrome	64.66	6110
LW260C	1 Gang, Chrome	64.66	6110
LW260SS	1 Gang, Stainless steel	64.66	6110
LW270WH	2 Gang, White	73.87	6110
LW270BLK	2 Gang, Black chrome	73.87	6110
LW270C	2 Gang, Chrome	73.87	6110
LW270SS	2 Gang, Stainless steel	73.87	6110

Wire-free Switch

- Operate one dimmer, socket or relay
- Wireless unit, battery operated
- Available in white, chrome, black chrome and stainless steel
- 1 and 2 gang variants



Cat No	Description	List Price	Disc Group
LW201WH	1 Gang, White	81.46	6110
LW201BLK	1 Gang, Black chrome	81.46	6110
LW201C	1 Gang, Chrome	81.46	6110
LW201SS	1 Gang, Stainless steel	81.46	6110
LW221WH	2 Gang, White	89.00	6110
LW221BLK	2 Gang, Black chrome	89.00	6110
LW221C	2 Gang, Chrome	89.00	6110
LW221SS	2 Gang, Stainless steel	89.00	6110

Energy Monitor

- Measure household energy usage
- Easy to install
- Save energy and money



Cat No	List Price	Disc Group
LW600	65.21	6110

Signal Booster

- Extend the range of Lightwave devices
- Battery operated
- Waterproof



Cat No	List Price	Disc Group
LW800	46.18	6110

Slave Dimmer

- Slave dimmers to perform 2-way switching
- Must be used with a Lightwave Master Dimmer
- Available in white, chrome, black chrome and stainless steel
- 1 gang, 2 gang and master/slave variants



Cat No	Description	List Price	Disc Group
LW450WH	1 Gang, White	77.59	6110
LW450BLK	1 Gang, Black chrome	77.59	6110
LW450C	1 Gang, Chrome	77.59	6110
LW450SS	1 Gang, Stainless steel	77.59	6110
LW452WH	2 Gang, White	180.10	6110
LW452BLK	2 Gang, Black chrome	180.10	6110
LW452C	2 Gang, Chrome	180.10	6110
LW452SS	2 Gang, Stainless steel	180.10	6110
LW455WH	Master, White	215.28	6110
LW455BLK	Master, Black chrome	215.28	6110
LW455C	Master, Chrome	215.28	6110
LW455SS	Master, Stainless steel	215.28	6110

Dimmer

- LED compatible dimmers
- Available in white, chrome, black chrome and stainless steel
- Easy to install using existing wiring circuits
- 1, 2, 3 and 4 gang variants



Cat No	Description	List Price	Disc Group
LW400WH	1 Gang, White	95.16	6110
LW400BLK	1 Gang, Black chrome	95.16	6110
LW400C	1 Gang, Chrome	95.16	6110
LW400SS	1 Gang, Stainless steel	95.16	6110
LW420WH	2 Gang, White	137.03	6110
LW420BLK	2 Gang, Black chrome	137.03	6110
LW420C	2 Gang, Chrome	137.03	6110
LW420SS	2 Gang, Stainless steel	137.03	6110
LW430WH	3 Gang, White	192.93	6110
LW430BLK	3 Gang, Black chrome	192.93	6110
LW430C	3 Gang, Chrome	192.93	6110
LW430SS	3 Gang, Stainless steel	192.93	6110
LW440WH	4 Gang, White	257.10	6110
LW440BLK	4 Gang, Black chrome	257.10	6110
LW440C	4 Gang, Chrome	257.10	6110
LW440SS	4 Gang, Stainless steel	257.10	6110

Home Thermostat

- Wireless thermostat
- Battery operated
- Create weekly profiles
- Monitor temperature in real-time



Cat No	List Price	Disc Group
LW921	263.47	6110

Thermostatic Radiator Valve

- Create zoned heating
- Retrofit wireless valve
- No tools required
- Battery operated



Cat No	List Price	Disc Group
LW922	155.75	6110

Passive Infrared Sensor

- Switch lights or sockets when movement is detected
- Wireless unit, battery operated
- Available in white, chrome, black chrome and stainless steel



Cat No	Description	List Price	Disc Group
LW107WH	White	62.79	6110
LW107C	Chrome	62.79	6110
LW107BLK	Black chrome	62.79	6110
LW107SS	Stainless steel	62.79	6110

Mood Controller

- Store up to five 'moods', grouping dimmers, sockets and relays to link to one button
- Wireless unit, battery operated
- Available in white, chrome, black chrome and stainless steel



Cat No	Description	List Price	Disc Group
LW101WH	White	66.59	6110
LW101C	Chrome	66.59	6110
LW101BLK	Black chrome	66.59	6110
LW101SS	Stainless steel	66.59	6110

Boiler Switch

- Control the homes boiler
- Save energy and money
- Requires electrical connection
- Requires Lightwave Thermostat & Link



Cat No	List Price	Disc Group
LW920	263.47	6110

Inline Relay and Inline Dimmer

- Operate mains voltage devices such as curtains and garage doors
- Control large lighting circuits
- Can be installed in confined areas such as roof spaces and wall cavities



Cat No	Description	List Price	Disc Group
LW821	Relay 500W	55.39	6110
LW830	Relay 3000W	73.87	6110
LW831	Dimmer 250W	73.87	6110

Remote On/Off 13A Socket Kit

- Plug & play adaptors
- Switch devices rated at up to 3000W
- White
- Dimmable adaptors available



Cat No	Finish	List Price	Disc Group
LW301WH	White, Dim	83.12	6110
LW321WH	White	86.83	6110

Magnetic Switch

- Attach to any non-metallic door or window
- Activate linked dimmers or sockets



Cat No	List Price	Disc Group
LW904	36.36	6110

Lowara ecocirc[®]

How can efficiency work even harder?

The answer is simple, it's the spherical motor design!

- No common shaft, shaft seals and conventional bearings have been eliminated.
- No back bearing.
- No air vent bleed valve.
- Floating spherical impeller.
- Energy saving.
- Only one moving part.
- Anti-block device.
- Quick and easy to install.
- Led light function on control giving operational status of Pump.
- Fast installation.
- ErP Ready to 2015 standards.
- No special tools required.
- Personalised end cap with your company details FOC.
- **Directly interchangeable with other manufacturers units.**



Domestic Circulator Pumps



Cat No.	Description	List Price	Disc Group
605008209	Ecocirc 25-4/130	145.00	3514
605008263	Ecocirc 25-6/130	145.00	3514
605008262	Ecocirc Premium 25-6/130	168.00	3514
LH9600002B	Pump Head Removal Tool	19.00	6107

Domestic Hot Water Circulator Pumps



Cat No.	Description	List Price	Disc Group
605005020	Ecocirc Pro 15-1/65	170.00	6107
605005100	Ecocirc Pro 15-1/65 R Temp Probe	216.00	6107
605005140	Ecocirc Pro 15-1/65 U Timer	238.00	6107
605005180	Ecocirc Pro 15-1/65 RU Temp Probe & Timer	283.00	6107
105006127	TLCN 25-6 Stainless HW Circulator 130mm	244.00	6107
105006125	TLCN 25-6 Stainless HW Circulator 180mm	380.00	6107

Light Commercial Circulator Pumps



Cat No.	Description	List Price	Disc Group
605009125	Ecocirc XL PLUS 25-40	400.00	6107
605009175	Ecocirc XL PLUS 25-60	474.00	6107
E503210AA	Ecocirc XL PLUS 25-80	540.00	6107
E503220AA	Ecocirc XL PLUS 25-100	598.00	6107
605009225	Ecocirc XL PLUS 32-40	491.00	6107
605009275	Ecocirc XL PLUS 32-60	572.00	6107
E503230AA	Ecocirc XL PLUS 32-80	598.00	6107
E503240AA	Ecocirc XL PLUS 32-100	564.00	6107

Home Boosting



Cat No.	Description	List Price	Disc Group
UKRESVARI10205A	Resvari (maximum pressure 4.2 bar)	3041.00	6107
UKRESFIX10205A	Resfix (maximum pressure 4.2 bar)	2295.00	6107
UKRESASSIST180A	Assist Unit	1470.00	6107

Submersible Pump



Cat No.	Description	List Price	Disc Group
109439181	DOC3/A Flood Kit	390.00	6107
109395390	Additional 6 metre hose & couplings	59.00	6107

ELECTRONIC CONTROLS

The smart way to control your heating

MYSON have a range of electronic controls available through H&V. From programmable room thermostats to WiFi controlled thermostats, MYSON have a solution for you.



HEATING VALVES

Save money on your heating bills

MYSON's range of valves includes products such as the TRV 2-WAY, as well as a complete range of pushfit and manual valves. We also have a full range of decorative valves that complement our towel and design radiator range.



ELECTRONIC CONTROLS

PROGRAMMERS & THERMOSTATS

Cat No.	Description	List Price	Disc Group
Programmable Room Thermostats			
MPRT	Programmable room stat	83.84	6201
MPRTRF	Programmable RF thermostat 24hr or 7 day	149.80	6201
MPRTRFCR	Programmable RF thermostat Chrome finish	149.80	6201
T2WIFI	WiFi Touch Pad Programmable Room Thermostat for 'Smart Phone' Control	132.68	6201
T2AHWIFI	WiFi Touch Pad Programmable Room Thermostat for 'Smart Phone' Control + Control Hub	382.05	6201
Programmables			
MEP1C	Single channel time switch	86.79	6201
MEP2C	Dual channel programmer	87.76	6201
Thermostats			
MRT1	Room thermostat	15.80	6201
MCT1	Cylinder stat	16.59	6201

VALVES & CONTROLS

Cat No.	Description	List Price	Disc Group
Motorised Valves & Accessories			
MPE322	Midi valve 22mm	113.74	6201
MPE222	Zone valve 22mm	89.43	6201
MPE228	Zone valve 28mm	113.94	6201
MPE328	Midi valve 28mm	144.91	6201
ACT322	Midi valve actuator	84.28	6201
ACT222	Zone valve actuator 22mm	76.45	6201
ACT228	Zone valve actuator 28mm	84.28	6201
Control Packs			
MZ PAK2	Zone pack 22mm	242.81	6201
MZ PAK3	Zone pack 22/28mm valves	274.63	6201
MZ PAK4	Megaflow pack	183.66	6201



HEATING VALVES

TRVs

Cat No.	Description	List Price	Disc Group
2TRV10C	TRV 10/15mm Chrome, 2 way	24.75	6201
2TRV15C	TRV 15mm Chrome, 2 way	24.32	6201
2TRV10N	TRV 10/15mm Nickel contract TRV, 2 way	21.87	6201
2TRV15N	TRV 15mm Nickel contract TRV	21.49	6201
2TRVUS	TRV Nickel contract TRV with 8, 10 & 15mm fittings	22.26	6201
2TRVRSHEAD 2	Remote sensor, 2 metre capillary	40.30	6201
2TRVADJHEAD 2	Remote adjuster 2 metre capillary	61.20	6201
2TRVHEAD	TRV Head standard, head only	18.15	6201
2TRVHEADCON	TRV Contract head only	16.32	6201
PETTRV15N	Petite TRV 15mm Nickel finish angle	17.63	6201
PETTRV10N	Petite TRV 10mm Nickel finish angle	17.63	6201

MANUAL RADIATOR VALVES

Fullflow			
FF15LAC	½" x 15mm Angle lockshield	26.98	6201
FF15WAC	½" x 15mm Angle wheelhead	26.98	6201
FF15LACD	½" x 15mm Angle lockshield with drain off	31.43	6201

COMPRESSION PLASTIC PIPE VALVES

Matchmate			
MM10LAN90	Lockshield angle Nickel 10mm (90)	11.93	6201
MM10LAND90	Lockshield drain off angle Nickel 10mm (90)	15.03	6201
Matchmaster			
MR10LACD90	Lockshield with drain off angle Chrome 10mm (90)	22.80	6201
Contract			
2TRV10N90	TRV 2 Way Nickel angle 10mm (90)	24.46	6201
2TRV10C90	TRV 2 Way Polished Chrome angle 10mm (90)	27.29	6201

PUSH FIT PLASTIC PIPE VALVES

Cat No.	Description	List Price	Disc Group
Matchmate			
MM10WANPF90	Push-fit wheelhead angle Nickel 10mm (90)	12.25	6201
MM10LANPF90	Push-fit lockshield angle Nickel 10mm (90)	12.25	6201
MM10LANDPF90	Push-fit lockshield with drain off angle Nickel 10mm (90)	15.35	6201
MM10LANPF	Push-fit Lockshield angle Nickel 10mm	11.60	6201
MM10LANDPF	Push-fit lockshield with drain off angle Nickel 10mm	14.65	6201
Matchmaster			
MR10WACPF90	Push-fit wheelhead angle Chrome 10mm (90)	19.28	6201
MR10LACPF90	Push-fit lockshield angle Chrome 10mm (90)	19.28	6201
MR10LACDPF90	Push-fit lockshield with drain off angle Chrome 10mm (90)	23.05	6201
MR10LACPF	Push-fit lockshield angle Chrome 10mm	18.65	6201
MR10LACDPF	Push-fit lockshield with drain Off 10mm	22.48	6201
Contract			
2TRV10NPF90	TRV 2 way Nickel angle 10mm (90)	24.68	6201
2TRV10CPF90	TRV 2 way Polished Chrome angle 10mm (90)	27.57	6201
2TRV10NPF	TRV 2 way Nickel Angle 10mm	24.13	6201
2TRV10CPF	TRV 2 way Polished Chrome angle 10mm	27.05	6201

DECORATIVE RADIATOR VALVES

Cat No.	Description	List Price	Disc Group
DEC180SLV	180mm Chrome plated pipe sleeve	92.93	6201
2TRV15DEC	Polished Chrome TRV V/A 15mm/½"	63.96	6201
2TRVHDDEC	Polished Chrome TRV head	36.77	6201
2TRV15ADEC	Polished Chrome TRV body only 15mm/½" angle	36.77	6201

RADIATOR VALVE SPARES

Fullflow			
FFTOPWH	Wheelhead cap	0.73	6201
Matchmate			
MMTOPLS	Lockshield cap	0.73	6201
MMTOPWH	Wheelhead cap	0.73	6201
MRTOPWH	Wheelhead cap	0.73	6201

ACCESSORIES

ABV22	22mm Auto by-pass valve	50.07	6201
ABV22S	22mm Auto by-pass valve straight	50.07	6201
COMBI-LOOP	Filling loop	30.93	6201

LST RADIATOR KITS

CCKTC	Close coupled TRV kit	139.50	6201
DIRECTFIT	Direct fit kit (now includes BS lockshield)	76.41	6201
2TRVLSTCAP	Replacement capillary for CCKTC	72.86	6201



Flexibility, Reliability, Trust

The all new Terrier TRV from Pegler Yorkshire is the only choice. Installers and contractors can fit and forget, knowing that their reputation is in good hands.

- Made to last - fit and forget
- Dynamic colour visual settings
- Smooth operation - intuitive settings
- 33% Hysteresis reduction



Terrier
The Only
Choice

For more detailed information:
www.pegler-yorkshire.co.uk

PEGLER 
INTEGRATED PIPING SYSTEMS

nest



Let's build the connected home together.

Nest thermostats, the Nest Protect smoke and CO alarm and the Nest Hello video doorbell all work together and can be controlled with a phone.* They're all excellent ways into the connected home for you. And most importantly, your customers will love them.

Contact your account manager for details on becoming an authorised Nest reseller



Cat No.	Description	List Price	Disc Group
HHF001235-GB	Nest Thermostat E	148.00	6203

*Remote control requires working Internet and Wi-Fi.

Nest Learning Thermostat

Cat No.	Description	List Price	Disc Group
T3010GB	Nest Learning Thermostat, Stainless Steel	228.13	6203
T3018GB	Nest Learning Thermostat, Copper	228.13	6203
T3019GB	Nest Learning Thermostat, Black	228.13	6203
T3030EX	Nest Learning Thermostat, White	228.13	6203
AT3000GB	Stand for Nest Learning Thermostat	36.46	6203



Nest Protect Smoke & CO Alarm



Cat No.	Description	List Price	Disc Group
S3000BWGB	Nest Protect, Battery	113.54	6203
S3003LWGB	Nest Protect, Wired	113.54	6203
S3006WBGB	Nest Protect, Battery, 3 Pack	311.46	6203

Nest Hello Video Doorbell



Cat No.	Description	List Price	Disc Group
NC5100GB	Nest Hello Video Doorbell	238.54	6203

Nest Cam IQ Indoor



Cat No.	Description	List Price	Disc Group
NC3100GB	Nest Cam IQ Indoor Security Camera	311.46	6203

Nest Cam IQ Outdoor



Cat No.	Description	List Price	Disc Group
NC4100GB	Nest Cam IQ Outdoor Security Camera	342.71	6203

Nest Cam Indoor



Cat No.	Description	List Price	Disc Group
NC1102GB	Nest Cam Indoor	165.63	6203
NC1200GB	Nest Cam Indoor, 2 Pack	290.63	6203

Nest Cam Outdoor



Cat No.	Description	List Price	Disc Group
NC2100GB	Nest Cam Outdoor	186.46	6203
NC2400GB	Nest Cam Outdoor, 2 Pack	342.71	6203



Description

Terrier Decor Thermostatic
Radiator Valve pack
Angle TRV & LS 15mm x 1/2

Cat No.	List Price	Disc Group
632322	52.63	6601
632329	60.53	6601
632334	52.63	6601

632322
Anthracite/CP

632329
Mixed CP

632334
White/CP



Cat No.	Size & Pattern
631802	8mm/10mm Angle
631803	TRV + LS367CPLS
631807	15mm Straight

List Price	Disc Group
49.30	6601
49.30	6601
51.20	6601

Description
Terrier Thermostatic Radiator
Valve & Lockshield Packs



Cat No.	Size & Pattern	List Price	Disc Group
631823	TRV INTPF + LS Angle 15mm/10mm with Elbow	58.55	6602
631822	TRV INTPF Angle 15mm/10mm with Elbow	36.15	6602
661205	10mm x 1/2" Lockshield with Elbow	22.89	6602
661206	15mm x 1/2" Lockshield with Elbow	23.88	6602
661201	10mm x 1/2" Wheelhandle with Elbow	22.89	6602
661202	15mm x 1/2" Wheelhandle with Elbow	23.88	6602

Description
Terrier Radiator Valve with Push-fit
connections and self sealing tails

Cat No.	Size	List Price	Disc Group
601032	8mm x 1/2"	19.32	6601
601036	10mm x 1/2"	19.32	6601
601038	15mm x 1/2"	19.32	6601
With Drain Off:			
601052	8mm x 1/2"	24.39	6601
601056	10mm x 1/2"	24.39	6601
601058	15mm x 1/2"	24.39	6601



Description
Terrier Lockshield Radiator Valve

Cat No.	Size	List Price	Disc Group
Angle Pattern:			
601022	8mm x 1/2"	19.32	6601
601026	10mm x 1/2"	19.32	6601
601028	15mm x 1/2"	19.32	6601
Straight Pattern:			
602028	15mm x 1/2"	26.35	6601



Description
Terrier Wheelhandle Radiator Valve

Cat No.	Size	List Price	Disc Group
Angle Pattern:			
631800	8mm/10mm	32.76	6601
631801	15mm	32.76	6601



Description
Terrier Thermostatic Radiator Valve

THERMOSTATIC MIXING VALVE copper x copper

Cat No.	Size	List Price	Disc Group	Cat No.	Size	List Price	Disc Group	Cat No.	Size	List Price	Disc Group
5A1401	15mm	71.34	6607	5A1403	15mm	131.32	6607	5A1405	15mm	137.64	6607
5A1402	22mm	83.05	6607	5A1404	22mm	152.71	6607	5A1406	22mm	158.88	6607



Cat No.	List Price	Disc Group
686002	44.24	6603

Description
Pegler Commercial Radiator Valves Angle Vertical Thermostatic Radiator Valve

686002 - Compression
15mm/1/2" Female Iron x 1/2" Male Iron



Cat No.	List Price	Disc Group
686001	44.24	6603

Description
Pegler Commercial Radiator Valves Angle Horizontal Thermostatic Radiator Valve

686001 - Compression
15mm/1/2" Female Iron x 1/2" Male Iron

686300 - Push-fit
15mm x 1/2" Male Iron



Cat No.	Size	List Price	Disc Group
686011	2m	92.44	6603
686012	5m	111.50	6603
686013	8m	129.12	6603

Description
Pegler Commercial Remote Thermostatic Head



Cat No.	Size	List Price	Disc Group
Compression/Male Iron:			
680007	15mm/1/2" x 1/2"	30.80	6603
680010	22mm/3/4" x 3/4"	39.00	6603

Description
Pegler Commercial Radiator Valves Angle Wheelhandle Radiator Valve



Cat No.	Size	List Price	Disc Group
Compression/Male Iron:			
681007	15mm/1/2" x 1/2"	33.61	6603
681010	22mm/3/4" x 3/4"	40.47	6603

Description
Pegler Commercial Radiator Valves Straight Wheelhandle Radiator Valve



Cat No.	Size	List Price	Disc Group
Compression/Male Iron:			
661001	10mm/3/4" x 3/4"	22.89	6602

Description
Pegler Commercial Radiator Valves Straight Lockshield Radiator Valve



Cat No.	Size	List Price	Disc Group
Compression/Male Iron:			
686030	15mm/1/2" x 1/2"	23.47	6603
686031	22mm/3/4" x 3/4"	32.43	6603

Description
Pegler Commercial Radiator Valves Angle Thermostatic Valve Body



Cat No.	Size	List Price	Disc Group
Compression/Male Iron:			
686032	15mm/1/2" x 1/2"	23.47	6603
686033	22mm/3/4" x 3/4"	32.43	6603

Description
Pegler Commercial Radiator Valves Angle Thermostatic Valve Body



Cat No.	Size	List Price	Disc Group
Compression/Male Iron:			
686034	15mm/1/2" x 1/2"	23.47	6603
686035	22mm/3/4" x 3/4"	32.43	6603

Description
Pegler Commercial Radiator Valves Straight Thermostatic Valve Body



Cat No.	List Price	Disc Group
686005	25.68	6603
686095	36.50	6603

Description
Pegler Commercial Thermostatic Head



Accessories

Cat No.	Description	List Price	Disc Group
634006	Chrome plated extension tail piece ETP 21mm + nut & olive	9.39	6601
841101	Terrier White lockshield/wheelhead cap	5.41	3524
841006	Terrier Chrome tail pipe	15.25	3524
841008	Terrier Chrome drain off tail pipe	19.08	3524
840001	Pegler 1/2" Green 'O' rings	3.01	3524
840002	Pegler 1/2" Red 'O' rings	3.01	3524
843001	Pegler 1/2" White lockshield/wheelhead cap	5.41	3524
686122	Pegler Anti Theft Thermal Ring	2.26	6603
686123	Pegler Anti Theft Thermal Ring Tool	8.96	6603

Cat No.		List Price	Disc Group
254001	15mm Chrome plated full bore valve	17.23	6607
254002	22mm Chrome plated full bore valve	22.82	6607
254003	28mm Chrome plated full bore valve	32.29	6607
254004	35mm Chrome plated full bore valve	51.78	6607
254005	42mm Chrome plated full bore valve	69.25	6607
254006	54mm Chrome plated full bore valve	122.27	6607



Description
PB300 RED LEVER BALL VALVES PN16

Cat No.		List Price	Disc Group
255001	15mm Chrome plated full bore valve	17.23	6607
255002	22mm Chrome plated full bore valve	22.82	6607
255003	28mm Chrome plated full bore valve	32.29	6607



Description
PB300T RED LEVER BALL VALVES PN16 valve

Cat No.		List Price	Disc Group
254011	15mm Chrome plated full bore valve	17.23	6607
254012	22mm Chrome plated full bore valve	22.82	6607
254013	28mm Chrome plated full bore valve	32.29	6607



Description
PB300 YELLOW LEVER BALL VALVES PN16

CE

Cat No.		List Price	Disc Group
255021	15mm Chrome plated full bore valve	17.23	6607
255022	22mm Chrome plated full bore valve	22.82	6607
255023	28mm Chrome plated full bore valve	32.29	6607



Description
PB300T YELLOW LEVER BALL VALVES PN16

CE

Cat No.		List Price	Disc Group
254021	15mm Chrome plated full bore valve	17.23	6607
254022	22mm Chrome plated full bore valve	22.82	6607
254023	28mm Chrome plated full bore valve	32.29	6607
254024	35mm Chrome plated full bore valve	51.78	6607
254025	42mm Chrome plated full bore valve	69.25	6607
254026	54mm Chrome plated full bore valve	122.28	6607



Description
PB300 BLUE LEVER BALL VALVES PN16

CE

Cat No.		List Price	Disc Group
255011	15mm Chrome plated full bore valve	17.23	6607
255012	22mm Chrome plated full bore valve	22.82	6607
255013	28mm Chrome plated full bore valve	32.29	6607



Description
PB300T BLUE LEVER BALL VALVES PN16

CE

Cat No.		List Price	Disc Group
242003	1/2" Chrome plated full bore valve	11.28	151
242004	3/4" Chrome plated full bore valve	23.95	151
242005	1" Chrome plated full bore valve	30.02	151
242006	1 1/4" Chrome plated full bore valve	49.85	151
242007	1 1/2" Chrome plated full bore valve	68.66	151

Larger sizes available upon request



Description
PB500 RED LEVER BALL VALVES PN25

Cat No.	Size	List Price	Disc Group
66001	15mm	13.51	6605
66004	22mm	19.47	6605

Description
Tectite TX300 Quarter turn ball valve



Easy to install EP1 and EP2 programmers from Potterton.



EP1 Programmer (Single Channel)

EP2 Programmer (Twin Channel)

- Digital clock display
- 230v single channel for central heating only
- Independent 7 day programming
- LED circuit indicator
- Built-in programmer
- Clock maintained during power failure
- Manual over-ride function
- For fully pumped and gravity fed systems

- Digital clock display
- 230v two channel for central heating and hot water
- Independent 7 day programming
- LED circuit indicator
- Built-in programmer
- Clock maintained during power failure
- Individual over-rides
- For fully pumped and gravity fed systems

Cat No.	List Price	Disc.	Group
7211472	99.27		1401

Cat No.	List Price	Disc.	Group
7211473	101.29		1401

Existing EP backplate can be used, ensuring minimal disruption and a quick and easy installation.

BAXI MAKE IT EASY TO BECOME BOILER PLUS COMPLIANT.

Here's two easy to install Baxi products to ensure your boiler installation is Boiler Plus compliant.

Baxi uSense

The Baxi uSense Wired Smart Thermostat** is the perfect addition to their Baxi boiler. Giving your customer complete control of their heating, from wherever they are. uSense makes perfect sense.



IFOS (In flue outdoor sensor)

Multifit IFOS provides installers with a cost effective, easy to install way to comply with Boiler Plus, when used with uSense or other time and temperature controls.

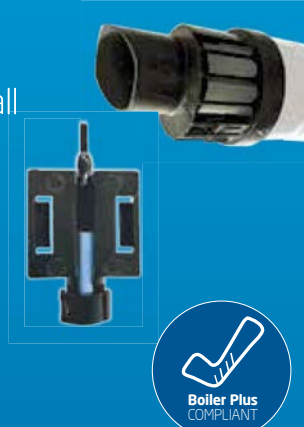

	Cat No.	List Price	Disc.	Group
uSense	7649277	214.00		1401
IFOS	7683084	40.00		1401

*T&C's apply. Visit baxi.co.uk for more details.
**Meets Boiler Plus compliance with load compensation when installed with an OpenTherm compatible boiler. In all other cases, it acts as time and temperature control only.

BAXI
Make it easy

WHEN YOU REALISE BAXI'S CONTROL IS ACTUALLY SMART.



BAXI  uSense

Give your customers complete control and add a Baxi uSense to their Baxi 600. Specifically made for Baxi boilers, uSense makes perfect sense.

 baxi.co.uk

* T&C's apply. Visit baxi.co.uk for more details



BAXI
Make it easy

Washroom Solutions

A

Auto AV3S

Hand Wash Unit

- Unique Vortex technology to effectively diffuse water flow
- Hygienic, touch-free automatic sensor control for start/stop
- Delivers warm water instantly

Cat. No	Model	kW Rating	List Price	Disc Group
43679901	AV3S	3	129.38	7001

A

Manual I3VS

Hand Wash Unit

- Unique Vortex technology to effectively diffuse water flow
- Single control dial for start/stop and temperature selection
- Delivers warm water instantly

Cat. No	Model	kW Rating	List Price	Disc Group
43678901	I3VS	3	74.25	7001

Water Heating

MS6

Unvented 6L Water Heater

Cat. No	Model	Capacity	List Price	Disc Group
47789701	MS6	6L	106.31	7001

C

B

WS7

7L Vented Water Storage Heaters

Cat. No	Model	kW Rating	List Price	Disc Group
44780001	WS73	3	132.07	7001

Powerstream Ascari

Electric Flow Boilers

Cat. No	Model	kW Rating	List Price	Disc Group
45551860	PSA12	12	1390.34	7001

D

Water Heating Continued.....

EW & MW

Unvented Water Storage Heaters

- EW & MW models for undersink applications
- MW models fitted with temperature/pressure relief device

Cat. No	Model	Capacity	List Price	Disc Group
47789301	EW10	10L	233.75	7001
47789401	EW15	15L	259.72	7001
47789101	MW10	10L	471.60	7001
47789201	MW15	15L	532.17	7001

Cat. No	Description	List Price	Disc Group
87783101	Optional cold water control pack	93.29	7002
87783103	Optional 15mm fail safe thermostatic blending valve	84.10	7002
97783236	Optional tundish	15.43	7002

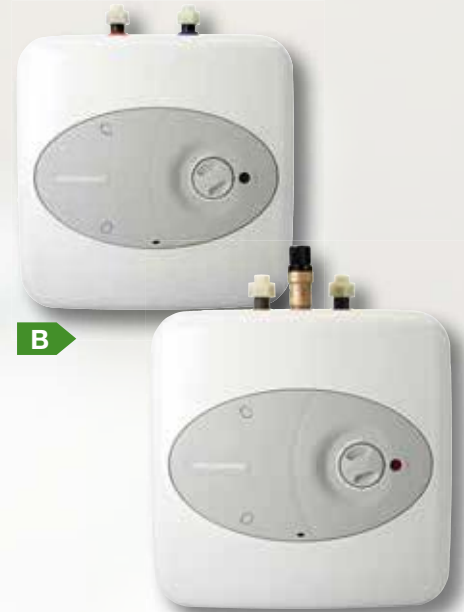

Powerstream and Powerstream Eco

Unvented Instantaneous Water Heaters

- Delivers hot water at point of use
- Water supplied to 1 or 2 outlets: shower and basin or two basins

Cat. No	Model	kW Rating	List Price	Disc Group
45793201	RP1	9.5	218.66	7001
45793204	RP10.8	10.8	236.57	7001
45793202	RP12	12.0	275.44	7001
45673201	RP1E	9.5	240.53	7001
45673202	RP10.8E	10.8	260.23	7001

Cat. No	Model	Description	List Price	Disc Group
85793616	LT1	Spray tap pair	58.07	7002
85793620	RM1	Shower mixer kit	105.92	7002



Instantaneous Electric Water Heating



A

Instant Electric Hot Water Tap

- Compact instantaneous electric hot water tap
- Instant hot water anywhere you need it
- Ideal for hand washing in domestic and commercial applications
- Plugs into a standard domestic power supply
- Requires only a cold water supply - no hot water storage

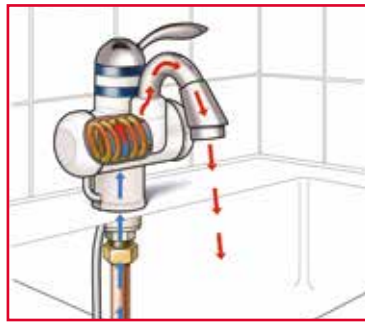

Cat. No	Model	kW Rating	List Price	Disc Group
43679001	TAP1	2.5	70.88	7001

Beverage Water Boiling



- Three way boiling water tap, ideal for beverage making and food preparation in domestic and small office kitchens
- Provides piping hot water from a compact 2 litre capacity water tank (1kW heating up to 33 cups per hour at 94°C)
- Rapid flow rate delivery - 1.8 litres/min at 3Bar pressure
- Safety interlock to avoid accidental operation and insulated spout to prevent it becoming too hot in use
- Features a unique vent valve which expels inline cooling water between uses to maintain temperature
- Supplied with simple fit flexible hoses for speedy connection
- Easy access to tank for inspection and descaling in hard water areas
- Reditap also connects to conventional hot and cold water supplies to give a mixer washing facility to the kitchen sink
- Available with chrome or brushed nickel tap finishes

Cat. No	Model	Capacity	List Price	Disc Group
22566802	RTTC	2.0L	553.94	7001
22566803	RTTB	2.0L	573.09	7001



For an exciting new shower range take it as Red.



Pure

Push button Start/Stop instantaneous electric shower with a single mode shower head and 2 year warranty.



Bright



SmartFit push button Start/Stop electric shower with multi-entry connectivity, 3 mode shower head and 3 year warranty.



Glow



Phased shutdown, SmartFit push button Start/Stop electric shower with digital temperature indication 5 mode shower head and 3 year warranty.

Cat. No	Model	kW Rating	List Price	Disc Group
53531301	RPS7 Pure	7.5	55.00	7003
53531001	RPS8 Pure	8.5	57.00	7003
53531101	RPS9 Pure	9.5	59.00	7003
53531201	RPS10 Pure	10.5	61.00	7003
53533301	RBS7 Bright	7.5	93.00	7003
53533001	RBS8 Bright	8.5	95.00	7003
53533101	RBS9 Bright	9.5	97.00	7003
53533201	RBS10 Bright	10.5	99.00	7003
53535301	RGS7 Glow	7.5	117.00	7003
53535001	RGS8 Glow	8.5	119.00	7003
53535101	RGS9 Glow	9.5	121.00	7003
53535201	RGS10 Glow	10.5	123.00	7003



Multi-entry connectivity

Left and right side entry
8 water entry points
6 cable entry points
Twin terminal block



A All are A rated for energy efficiency

Tenant® Valve



Cat No	Description	List Price	Disc Group
TVAP200075	Tenant® Valve, 3/4" FBSP	302.42	7502
TVAP200080	Tenant® Valve, 1" FBSP	317.26	7501
SBTVAP200075	Tenant® Valve with SharkBite® connections, 22mm	304.01	7501
SBTVAP200080	Tenant® Valve with SharkBite® connections, 28mm	323.30	7501
TADP200075	Class 'D' water meter adaptor	29.68	7501
WATM110700	Class 'A' cold water meter cartridge	83.10	7501
WATM110750	Class 'A' hot water meter cartridge	92.64	7501
PCAP110700	Retrofit clip on pulse output cap	47.49	7501

Pressure Reducing Valves



Cat No	Description	List Price	Disc Group
PRED800015	Predator® adjustable PRV with gauge, 15mm comp, up to 80°C	36.99	7502
PRED800020	Predator® adjustable PRV with gauge, 22mm comp, up to 80°C	43.88	7501
PRED320001	Easiset® 320F adjustable PRV, 1/2" FBSP, up to 45°C	44.63	7501
PRED320003	Easiset® 320M adjustable PRV, 1/2" MBSP union, up to 45°C	51.09	7501
PRED320010	Easiset® 320C adjustable PRV, 15mm comp, up to 45°C	45.26	7501
PRED320050	Easiset® 320F adjustable PRV, 1/2" FBSP, up to 80°C	46.53	7501
PRED320051	Easiset® 320M adjustable PRV, 1/2" MBSP union, up to 80°C	52.36	7501
PRED320060	Easiset® 320C adjustable PRV, 15mm comp, up to 80°C	48.55	7501
SB-PRED320001	Easiset® 320 PRV with SharkBite® connections, 15mm, up to 45°C	54.80	7501
SB-PRED320005	Easiset® 320 PRV with SharkBite® connections, 22mm, up to 45°C	64.87	7502
SB-PRED320050	Easiset® 320 PRV with SharkBite® connections, 15mm, up to 80°C	56.60	7501
SB-PRED320055	Easiset® 320 PRV with SharkBite® connections, 22mm, up to 80°C	67.31	7501

Thermostatic Mixing Valves



Cat No	Description	List Price	Disc Group
HEAT110750	Ausimix® Compact TMV, 2in1, 15mm	66.04	3517
HEAT110755	Ausimix® Compact TMV, 2in1, 22mm	78.55	7501
HEAT110780	Ausimix® Compact TMV, 4in1, 15mm	89.36	7501
HEAT110785	Ausimix® Compact TMV, 4in1, 22mm	101.87	7501
HEAT110751	Ausimix® Compact Telescopic TMV, 2in1, 15mm	76.00	7501
SBHEAT110750	Ausimix® Compact 2in1 TMV, 15mm, with SharkBite® connections	73.35	7501
SBHEAT110755	Ausimix® Compact 2in1 TMV, 22mm, with SharkBite® connections	87.13	7501
SBHEAT110780	Ausimix® Compact 4in1 TMV, 15mm, with SharkBite® connections	97.41	7501
SBHEAT110785	Ausimix® Compact 4in1 TMV, 22mm, with SharkBite® connections	110.03	7501

Approved to **both** TMV2 and TMV3 schemes

Pressure & Temperature Relief Valves



Cat No	Description	List Price	Disc Group
PTEM510001	Lever top pressure & temperature relief valve, 1/2" x 15mm, 6 bar	44.84	7502
PTEM550852	Full cartridge pressure & temperature relief valve, 1/2" x 15mm, 7 bar	52.26	7502
PTEM550853	Full cartridge pressure & temperature relief valve, PTFE coated, 1/2" x 15mm, 10 bar	52.26	3517
PTEM550854	Full cartridge pressure & temperature relief valve, PTFE coated, 1/2" x 15mm, 7 bar	52.26	3517
PTEM550856	Full cartridge pressure & temperature relief valve, PTFE coated, 1/2" x 15mm, 4.5 bar	52.26	7502
PTEM550857	Full cartridge pressure & temperature relief valve, PTFE coated, 1/2" x 15mm, 6 bar	52.26	3517
PTEM100050	Lever top pressure and temperature relief valve, type TPR28, 1" MBSP x 28mm, 7 bar	214.97	7501

Floguard® Check Valves



Cat No	Description	List Price	Disc Group
FLOW235001	Single check valve, DZR brass, 15mm	7.10	3517
FLOW235002	Single check valve, DZR brass, 22mm	11.02	3517
FLOW235005	Single check valve, DZR brass, 3/4" FBSP	12.40	7501
FLOW230001	Mini double check valve, DZR brass, 15mm	9.33	7501
FLOW230002	Mini double check valve, nickel plated, 15mm	9.33	7501
FLOW230005	Double check valve, DZR brass, 1/2" FBSP	10.28	7501
SB2615	Double check valve, DZR brass, 15mm, with SharkBite® connections	14.84	7501

Tundishes



Cat No	Description	List Price	Disc Group
TUND219005	Straight plastic tundish, 15mm x 22mm	8.37	7501
TUND218024	90° plastic tundish, 15mm x 3/4" FBSP	11.24	7501
TUND219015	Straight plastic tundish, 22mm x 28mm	15.37	7501
TUND300001	Straight epoxy steel tundish, 1" x 1 1/4" FBSP	54.17	7501
TUND300004	Straight epoxy steel tundish, 1 1/2" x 2" FBSP	71.23	7501

All type AA backflow prevention

Expansion Vessels



Cat No	Description	List Price	Disc Group
XVES050000	Potable water shock arrestor, 0.16L, 1/2" MBSP	28.20	7501
XVES050050	Expansion vessel for potable water, 18L, 3/4" MBSP	44.41	7502

Other sizes of expansion vessel available, up to 5000 l, for heating and potable systems

SharkBite® Fittings



Cat No	Description	List Price	Disc Group
SB0115	Coupling, 15mm (pack of 10)	32.90	7501
SB0122	Coupling, 22mm (pack of 5)	25.20	7501
SB0115S	Slip coupling, 15mm (pack of 10)	83.70	7501
SB0122S	Slip coupling, 22mm (pack of 5)	54.60	7501
SB0215	90° elbow, 15mm (pack of 10)	38.20	7501
SB0222	90° elbow, 22mm (pack of 5)	28.60	7501
SB0315	Equal tee, 15mm x 15mm x 15mm (pack of 10)	50.90	7501
SB0322	Equal tee, 22mm x 22mm x 22mm (pack of 5)	35.80	7501
SB0315S	Slip tee, 15mm x 15mm x 15mm	10.18	7501
SB0322S	Slip tee, 22mm x 22mm x 22mm	13.46	7501
SB0415	End stop, 15mm (pack of 10)	32.90	7501
SB0422	End stop, 22mm (pack of 5)	25.20	7501
SB1315	Draincock with street end, 15mm (pack of 5)	40.30	7501
SB111515MP	Male connector, parallel thread, 15mm x 1/2" BSP (pack of 5)	25.20	7501
SB111515F	Female connector, parallel thread, 15mm x 1/2" BSP (pack of 5)	36.30	7501
SB141515	Tap connector, 15mm x 1/2" loose nut (pack of 5)	24.90	7501
SB231530015F	Push-fit to female flexible connector, 300mm long, 15mm x 1/2" BSP	8.80	7501
SB231530015	Push-fit to push-fit flexible connector, 300mm long, 15mm x 15mm	10.39	7501

Filling Loops



Cat No	Description	List Price	Disc Group
FIBV246208	Filmaster® filling loop, dual isolator c/w check valve, 15mm	13.04	7501
BCAP246200	Filling loop sealing cap and tag, 1/2"	2.33	3517
SB2315ST	Filling loop with street ends, 15mm	14.31	7501

KEEP IT CLEAN!



IT'S NOT X-RATED,
IT'S THE SENTINEL CHEMICAL RANGE.

Heating systems can get really dirty. The Sentinel chemical range available at Travis Perkins are designed to keep boilers and heating systems clean and working at their best.

#ThinkDirty
[SentinelProtects.com/Dirty](https://www.SentinelProtects.com/Dirty)

SENTINEL®



Cat No.	Description	List Price	Disc Group
1 Litre Chemical Inhibitor			
X100L	Inhibitor in 12 litre cases, priced per litre	29.75	8101
X200L	Descaler in 12 litre cases, priced per litre	24.44	8101
X300L	Cleanser in 12 litre cases, priced per litre	30.44	8101
X400L	De-Sludger in 12 litre cases, priced per litre	27.98	8101
X500L	Inhibited antifreeze	62.64	8101
X700L	Underfloor heating/low temperature biocide	65.42	8101
X800L	Jetflo heavy duty cleaner 1 litre bottle	31.12	8101



Cat No.	Description	List Price	Disc Group
Sentinel Solar			
R100-10L-DRUM	Sentinel Solar Inhibitor 10 litre	75.96	8101
SOLARFLUSH	Sentinel Solar filling & flushing unit	1630.12	8101



Cat No.	Description	List Price	Disc Group
Sentinel Ground Source & Thermal Range			
R500L-20L-DRUM	Sentinel R500 GSHP Thermal Fluid 20L Drum	95.17	8101
R600L-20L-DRUM	Sentinel R600 ASHP Thermal Fluid 20L Drum	166.61	8101



Cat No.	Description	List Price	Disc Group
Sentinel Ground Source & Thermal Range			
SOLAR-TEST-KIT	Sentinel Test Kit	553.69	8101



Cat No.	Description	List Price	Disc Group
System Filter			
ELIM300GRP22MM	Sentinel Vortex 300 system filter	118.89	8101
SYSTEM-FILTER-GB	Sentinel system filter	159.92	8102
ELIMINATOR	Sentinel Eliminator system filter	158.81	8102



Cat No.	Description	List Price	Disc Group
Physical Inhibitors			
CONDENS SAFE PLUS	Salamander Condensafe Plus	70.15	7601
CONDENS SAFE REFILL	Salamander Condensafe refill	14.43	7601
SESI 15	SESI Electrolytic scale inhibitor 15mm	75.03	8101
SESI 22	SESI Electrolytic scale inhibitor 22mm	130.89	8101



Cat No.	Description	List Price	Disc Group
Test Kits			
X100T-T-GB	X100 test kit	28.40	8101



Cat No.	Description	List Price	Disc Group
20 Litre Containers			
X100L-20L-GB	Inhibitor 20 Litre	496.35	8101
X200L-20L-GB	Descaler 20 Litre	538.49	8101
X400L-20L-GB	De-Sludger 20 Litre	564.15	8101



Cat No.	Description	List Price	Disc Group
Rapid Dose			
X100RD	X100 Rapid Dose 400ml	34.45	8101
X200RD	X200 Rapid Dose 400ml	30.52	8101
X400RD	X400 Rapid Dose 400ml	32.42	8101
RD-LS	Rapid Dose Leak Sealer	31.57	8101

Smart Programmings

Cat No.	Description	List Price	Disc Group
RDS110	Electromechanical daily programmer	259.26	3301

The Smart Thermostat is different. Its unique features benefit both professional installers and end customers. From easy installation and fast commissioning to being always in touch with its surroundings, it creates perfect places.



Programmings



Cat No.	Description	List Price	Disc Group
RWB2e	Electromechanical daily programmer	109.93	3301
RWB29si	Electronic daily, 5 day/2 day or 7 day programmer with service interval function	107.85	3301
RWB2007	Electronic 5 day/2 day or 7 day programmer with service interval function	113.04	3301

Timers



Cat No.	Description	List Price	Disc Group
RWB30e	Electromechanical daily timer	78.81	3301
RWB27si	Electronic daily, 5 day/2 day or 7 day timer with service interval function	78.81	3301
RWB1007	Electronic 5 day/2 day or 7 day timer with service interval function	82.96	3301

Wireless Thermostats



Cat No.	Description	List Price	Disc Group
RDD100.1RFS	RF Wireless room thermostat and receiver	99.56	3301
RDE100.1RFS	RF Wireless programmable room thermostat and receiver	136.89	3301
RDH100RF/SET	Easy electronic wireless TPI room thermostat	96.44	3301
RDJ100RF/SET	Easy electronic programmable wireless TPI room thermostat and receiver	109.93	3301
REV24RF/SET	7 Day wireless programmable room thermostat and receiver	250.96	3301
RDE-MZ6	Wireless multizone receiver (up to 6 devices)	184.59	3301
RDD100.1RF	Wireless room thermostat for use with RDE-MZ6	62.22	3301
RDE100.1RF	Wireless programmable room thermostat for use with RDE-MZ6	77.78	3301

Programmable Room Thermostats



Cat No.	Description	List Price	Disc Group
RDE100	7 day programmable room thermostat mains powered	58.07	3301
RDE100.1	7 day programmable room thermostat battery powered	58.07	3301
RDJ100	Easy electronic daily programmable room thermostat with TPI control	56.00	3301
REV13	Daily electronic programmable room thermostat	116.15	3301
REV24	7 day electronic programmable room thermostat	126.52	3301

Digital Room Thermostats



Cat No.	Description	List Price	Disc Group
RDD100	Electronic room thermostat mains powered	45.63	3301
RDD100.1	Electronic room thermostat battery powered	45.63	3301
RDD100.1DHW	Electronic room thermostat with DHW output	112.00	3301
RDH100	Easy electronic room thermostat with TPI control	43.56	3301

Room and Cylinder Thermostats



Cat No.	Description	List Price	Disc Group
RAA21-GB	Room thermostat with volt free contacts	20.74	3301
RAA31.16	Room thermostat including neon	27.48	3301
RAA11	Tamperproof room/frost thermostat	18.15	3301
RAA20LD-GB	Room thermostat with large dial	33.19	3301
RAM1	Cylinder or pipe thermostat	25.41	3301

Motorised Valves



Cat No.	Description	List Price	Disc Group
CMV322	3 port 22mm mid position valve	186.67	3301
CMV328	3 port 28mm mid position valve	207.41	3301
CZV222	2 port 22mm zone valve	129.63	3301
CZV228	2 port 28mm zone valve	147.26	3301

TRVs and By-Pass Valves



Cat No.	Description	List Price	Disc Group
Trade TRV 15	Trade TRV 2-way wax sensor (10/15mm)	25.93	3302
MTN51GB	TRV 10/15mm liquid	34.22	3302
MTN51GBL	TRV 10/15mm liquid with push fit elbow	34.74	3301
BPV22	22mm auto by-pass valve	64.30	3301

SPIROCOMBI® MB3

Effective system water deaeration and dirt separation, combined in one unit.



NEW
FOR
2019



Industry-leading
20 year guarantee



Energy saving

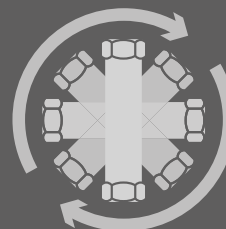

Quick and easy;
universal installation
(360°)



Sturdy brass
housing

CAT NO.	DESCRIPTION	LIST PRICE	DISC GROUP
UC022WJ	SpiroCombi MB3 22mm Deaeration and dirt separation combined	£158.87	8202
UC028WJ	SpiroCombi MB3 28mm Deaeration and dirt separation combined	£167.04	8202

To find out more visit

www.spirotech.co.uk



@SpirotechUK

SPIROTRAP[®] MBC1

Cost-effective dirt separator for removing both magnetic and non-magnetic dirt particles.



- Sturdy brass housing
- Quick and easy installation
- Universal installation all directions (360)
- Quick and hassle free cleaning

CAT NO.	DESCRIPTION	LIST PRICE	DISC GROUP
UE022WHA01	SpiroTrap MBC1 Dirt Separator 22mm	£72.10	8202

SPIROTRAP[®] MB3

Unique magnetic field booster technology for optimal dirt separation.



- Sturdy brass housing
- Quick and easy service
- Removable high powered magnet for best performance
- Universal installation all directions (360°)
- Energy savings of up to 7.4%
- Sizes up to 2"

CAT NO.	DESCRIPTION	LIST PRICE	DISC GROUP
UE022WJ	SpiroTrap MB3 Dirt Separator 22mm	£96.91	8202
UE028WJ	SpiroTrap MB3 Dirt Separator 28mm	£112.70	8202

* SpiroTrap MBL available up to 2" ask in branch for more details

SPIROVENT[®] RV2

Continuous, effective system water deaeration and fast, easy installation at any angle.



- Sturdy brass housing
- Universal installation all directions (360°)
- Effectively removes micro bubbles
- Reliable, leak-free venting system
- Energy savings of up to 6%
- Sizes up to 2"

CAT NO.	DESCRIPTION	LIST PRICE	DISC GROUP
UA022W	SpiroVent RV2 Deaerator 22mm	£96.91	8202
UA028W	SpiroVent RV2 Deaerator 28mm	£112.70	8202

* Available up to 2" ask in branch for more details

SPIROCROSS[®]

Minimal fluid mixing with 3-in-1 operation; balancing, deaeration and dirt separation.

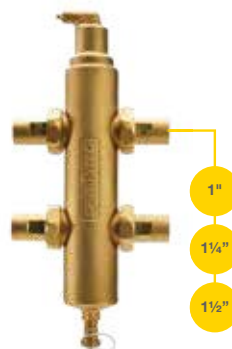

- Increased energy efficiency
- 3-in-1 saving; space, time and costs
- 3-in-1 operation balancing deaeration, dirt separation
- Minimal fluid mixing

CAT NO.	DESCRIPTION	LIST PRICE	DISC GROUP
AX100	Hydraulic Deaerator and dirt separator 1"	£395.93	8202
AX125	Hydraulic Deaerator and dirt separator 1¼"	£427.04	8202
AX150	Hydraulic Deaerator and dirt separator 1½"	£478.02	8202

CONVECTOR HEATERS



SCH20

- 2kW Heat output
- 3 heat settings
- Adjustable Thermostat
- H400xW570xD145mm

List Price	Disc Group
23.50	9909



SCH20T

- 2kW Heat output
- 3 heat settings
- Adjustable Thermostat
- Timer
- H400xW570xD145mm

List Price	Disc Group
29.13	9909

OIL FILLED RADIATORS



SOFR15

- 1.5kW Heat output
- Stylish design
- Radiator 'style'
- 7 Fins
- H625xW235xL340mm

List Price	Disc Group
57.38	9909



SOFR20T

- 2kW Heat output
- Stylish design
- Radiator 'style'
- 9 Fins
- Timer
- H625xW235xL420mm

List Price	Disc Group
68.98	9909



SOFR20

- 2kW Heat output
- Stylish design
- Radiator 'style'
- 9 Fins
- H625xW235xL420mm

List Price	Disc Group
65.21	9909



SOFR25T

- 2.5kW Heat output
- Stylish design
- Radiator 'style'
- 11 Fins
- Timer
- H625xW235xL500mm

List Price	Disc Group
74.94	9909

FAN HEATERS

USE UPRIGHT OR FLAT



SFH20

- 1kW/2kW
- 2 heat settings
- Can be used upright or flat
- Thermostatic temperature control
- Overheat protection
- H125xW245xD295mm

List Price	Disc Group
13.23	9909



SFHU20

- 1kW/2kW
- 2 heat settings
- Thermostatic temperature control
- Overheat protection
- H255xW220xD175mm

List Price	Disc Group
13.13	9909



SFHF20

- 1kW/2kW
- 2 heat settings
- Thermostatic temperature control
- Overheat protection
- H125xW295xD245mm

List Price	Disc Group
14.79	9909

WALL FANS

SWFR16

16" WALL FAN WITH REMOTE

- Oscillating control & tilt action
- Fully guarded plastic blades
- Metal mesh safety cover
- 3 Speed settings
- Remote control
- 0.5-7.5 hour timer

List Price	Disc Group
41.15	3519



SWFM16

16" WALL FAN

- Oscillating control & tilt action
- Fully guarded plastic blades
- Metal mesh safety cover
- 3 Speed settings

List Price	Disc Group
36.13	3519



DESK FANS

SFG9

9" DESK FAN

- Oscillating control & tilt action
- Fully guarded plastic blades
- Metal mesh safety cover
- 2 Speed settings

List Price	Disc Group
19.83	3519



SFG12

12" DESK FAN

- Oscillating control & tilt action
- Fully guarded plastic blades
- Metal mesh safety cover
- 3 Speed settings

List Price	Disc Group
22.54	3519

SFG16

16" DESK FAN

- Oscillating control & tilt action
- Fully guarded plastic blades
- Metal mesh safety cover
- 3 Speed settings

List Price	Disc Group
25.83	3519



MULTI-AREA FANS

STF1

TOWER FAN

- 75 degree angle oscillation
- 3 Speed settings

List Price	Disc Group
36.62	3519

STF1R

TOWER FAN WITH REMOTE

- Remote control
- Up to 7.5 hour timer
- 75 degree angle oscillation
- 3 Speed settings

List Price	Disc Group
40.54	3519

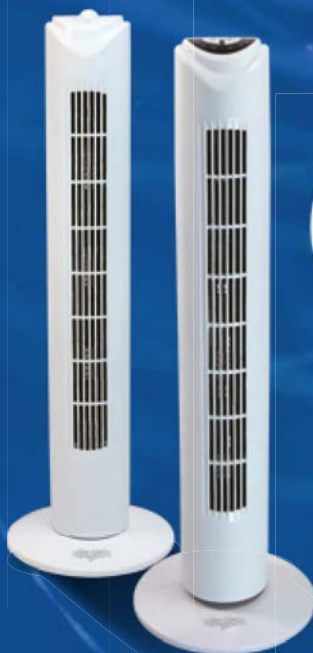

SFG6C

6" CLIP FAN

- Fully guarded plastic blades
- Mesh safety cover
- 2 Speed settings

List Price	Disc Group
15.47	3519



SPF18

18" POWER FAN

- Tilt action
- Fully guarded blades
- Metal mesh safety cover
- 3 Speed settings

List Price	Disc Group
52.92	3519



List Price	Disc Group
26.50	3519

SFGP16

16" PEDESTAL FAN

- Oscillating control & tilt action
- Fully guarded plastic blades
- Metal mesh safety cover
- 3 Speed settings

Room Thermostats



Electronic Room Thermostat

Cat No	Power Source	Contact Type	Current Rating - Resistive (inductive)	Temp Range	ErP Class	Additional	List Price	Disc Group
2306000 ESTAT	Mains Powered	Changeover (SPDT)	2 (0.5) Amp @ 220V +/- 10V	5°C - 30°C	I / 1%	LED Status Indicator	18.35	8401
2306100 ESTATRF	Battery powered (AA x 2) Transmitter Mains powered (230V) Receiver	Changeover (SPDT), volt free	3 (1) Amp @ 230V	5°C - 35°C	IV / 2%	Wireless (RF), TPI control, push button, large LCD, surface mounted receiver	91.12	8401

TLX 9000 Series - Electromechanical

Electromechanical range with a stylish low profile design. Large setting dial with thumbwheel operation, tamperproof option, LED status indicator.



Cat No	Operation Voltages	Contact Type	Current Rating - Resistive (inductive)	Temp Range	ErP Class	Additional	List Price	Disc Group
TLX9301	230V	On/Off (SPST)	16 (7) Amp	5°C-30°C	I / 1%	High Current	30.31	8401
TLX9201	230V	Changeover (SPDT)	10 (4) Amp	5°C-30°C	I / 1%		20.04	8401
TLX9401	230V	Changeover (SPDT)	10 (4) Amp	-5°C-15°C	I / 1%	Tamperproof Frost	23.73	8401
TLX9701	230V	Changeover (SPDT)	10 (4) Amp	5°C-30°C	I / 1%	Tamperproof	21.09	8401

TLX 2000 Series - Electromechanical

Electromechanical range for light to medium duty applications. High specification and reliability.

Complete with backplate, accelerator heater and suitable for B.S. Conduit boxes. 24V and tamperproof models available.



Cat No	Operation Voltages	Contact Type	Current Rating - Resistive (inductive)	Temp Range	ErP Class	Additional	List Price	Disc Group
TLX2251	24V	On/Off (SPST)	6 Amp	3°C-27°C	I / 1%		48.91	8402
TLX2259	230V	On/Off (SPST)	6 (2) Amp	3°C-27°C	I / 1%		29.90	8401
TLX2358	230V	Changeover (SPDT)	6 (2) Amp	3°C-27°C	I / 1%	Tamperproof	48.01	8401
TLX2360	230V	On/Off (SPST)	6 (2) Amp	0°C-15°C	I / 1%	Tamperproof Frost	33.06	8401
TLX2356	230V	Changeover (SPDT)	6 (2) Amp	3°C-27°C	I / 1%		38.04	8401

TLM 2000 Series - Electromechanical

Robust range for 4-20 Amp resistive loads. Wide range to suit all applications with tamperproof models available.



Cat No	Operation Voltages	Contacts	Current Rating - Resistive (inductive)	Temp Range	ErP Class	Additional	List Price	Disc Group
TLM2628	230V	On/Off (SPST)	20 (9) Amp	3°C-27°C	I / 1%		54.36	8401
TLM2457	230V	On/Off (SPST)	20 (9) Amp	0°C-15°C	I / 1%	Tamperproof Frost	48.12	8401
TLM2453	230V	On/Off (SPST)	20 (9) Amp	3°C-27°C	I / 1%	Tamperproof	49.83	8401
TLM2802	230V	Changeover (SPDT)	20 (9) Amp	10°C-40°C	I / 1%		57.98	8401
TLM2253	230V	On/Off (SPST)	20 (9) Amp	3°C-27°C	I / 1%		45.29	8401
TLM2257	230V	On/Off (SPST)	20 (9) Amp	-15°C-10°C	I / 1%	Frost	38.96	8401

WiFi Heating Control

Sunvic WiFi S101 7 day, 5/2 day, 5/1/1 day programmer for central heating

Cat No	Power Source	Contact Type	Current Rating - Resistive (inductive)	Temp Range	ErP Class	Additional	List Price	Disc Group
2307000	230V 50Hz	SPST	3 (1) Amp @ 230V	5°C-50°C	I / 1%	Heating Only	97.99	8401



Programmable Room Thermostats

SunStat & SunStatRF

Wired and wireless (RF) programmable room thermostats

- 7-day programming with 4 daily independent time & temperature pairs
- Recognisable screen icons, simple user interface and copy function for quick and easy programming
- Large, clear backlit display (blue) with status, clock and temperature display
- Lockable controls to prevent tampering
- Frost protection facility (5°C)
- TPI control permits an energy saving of up to 10% (c.f. conventional thermostat)
- Battery powered (x2 "AA")
- Wireless (RF) model comes complete with a mains powered receiver unit, back-box, and cradle enabling the unit to be used free standing or wall mounted.

Cat No	Power Source	Contact Type	Current Rating - Resistive (inductive)	Temp Range	ErP Class	Additional	List Price	Disc Group
2227001 SUNSTAT	Battery powered (AA x 2)	Changeover (SPDT), volt free	10 (3) Amp @ 230V	5°C-45°C	IV / 2%	Wired, TPI control, batteries included	60.87	8402
2227002 SUNSTAT SI	Battery powered (AA x 2)	Changeover (SPDT), volt free	10 (3) Amp @ 230V	5°C-45°C	IV / 2%	Wired, TPI control, batteries included, Service Interval & Delayed Start	63.85	8402
2227051 SUNSTATRF	Battery powered (AA x 2) Transmitter Mains powered (230V) Receiver	Changeover (SPDT), volt free	16 (3) Amp @ 230V	5°C-45°C	IV / 2%	Wireless (RF), 868MHz, TPI control, batteries included, complete with receiver, back box and cradle	121.72	8402
2227052 SUNSTATRF SI	Battery powered (AA x 2) Transmitter Mains powered (230V) Receiver	Changeover (SPDT), volt free	16 (3) Amp @ 230V	5°C-45°C	IV / 2%	Wireless (RF), 868MHz, TPI control, batteries included, complete with receiver, back box and cradle, Service Interval & Delayed Start	124.71	8402



Central Heating Programmers

SunPro1000 & SunPro2000

Single and twin channel programmers

- 7 day, 5/2 day, 24hr programming options
- Saves on stock: 1 unit suits all installations
- Selectable on/off times up to 3 times daily for greater energy efficiency
- Frost protection and holiday mode keep your home and heating safe
- Easy-to-read backlit display is better for elderly and visually impaired
- Advance and boost (for 1, 2 or 3 hours): greater control and save money

Cat No	Operation Voltages	Contact Type	Current Rating - Resistive (inductive)	Temp Range	Additional	List Price	Disc Group
4973100 SUNPRO1000	230V	Changeover (SPDT), volt free	3 (1) Amp @ 230V	0°C-45°C	For control of hot water or central heating	70.51	8402
4973200 SUNPRO2000	230V	Changeover (SPDT)	3 (1) Amp @ 230V	0°C-45°C	For independent time control of hot water and central heating	87.20	8402
4973300 SUNPRO3000	230V	Changeover (SPDT)	3 (1) Amp @ 230V	0°C-45°C	For independent time control of hot water and central heating	127.84	8401



Thermostats & Accessories

VKL 3000 Series Rod Thermostats with built-in temperature cut-out

A conventional Rod Thermostat and an Over Temperature Cut-Out Thermostat both contained within the same housing, providing a simple cost-effective compliance to meet with the new European Safety Legislation (EN 60730 and EN 60-353--2-73).

Cat No	Operation Voltages	Stem Length	Current Rating (Amps)	Temp Range	Differential °C	Overtemp Cut-out °C	List Price	Disc Group
VKL3205	230V	7"/178mm	16 Amp	30°C-70°C	10°C	81°C	11.16	8401
VKL3305	230V	11"/280mm	16 Amp	40°C-70°C	6°C	81°C	11.48	8401
VKL3405	230V	18"/457mm	16 Amp	40°C-70°C	5°C	81°C	12.25	8401

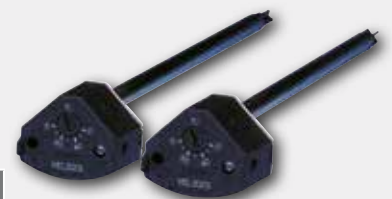

Motorised Valves



Cat No.	Description	List Price	Disc Group
SDV2291	SD2601 + EDT2702 - 3 Port, 22mm (Diverter) Valve & Actuator	111.69	8401
SMV2217	SM5203 + EML3454 - 2 Port (22mm) Motor Open Motor Closed External Unival Valve & Actuator	107.87	8401
SZV2228	SZ2301 + EML3503 - 2 Port (28mm) SZV External unival valve & spring return actuator	111.32	8401
SDV2211	SD2701 + EDT2702 - 3 Port, 22mm (Mid Position) Unishare Valve & Actuator	122.64	3521
SZV2212	SZ2301 + EML3454 - 2 Port (22mm) External Unival valve & spring return actuator	85.04	8402
SDMV2304	EcoSmart containing SDM1901 + EDT3201 - 3 Port, 22mm (mid position) Motor Open Motor Closed Unishare Valve & Actuator	122.66	3521
SZMV2305	EcoSmart containing SZM1801 + EML3454 - 2 Port (22mm) Unival valve & actuator	85.04	8402
SZV2655	2 Port (22mm) Contract Valve (inc. click fit actuator)	65.37	8402

Spare Actuators



Cat No.	Description	List Price	Disc Group
DM5601	3 port, (Unishare) Duoflow actuator; Motor Open - Motor Close; Mid position; 5 wire	128.80	8402
DM5651	3 port, (Unishare) Duoflow actuator; Motor Open - Motor Close; Plug-in; Mid position; 5 wire	140.55	8402
SD2601	3 port (Unishare) actuator; Diverter; Spring return action; Normally open to hot water; 2 wire	123.17	8402
SD2701F	3 port (Unishare) actuator; Mid position; Spring return action; High temp; Normally closed; 4 wire	117.52	8402
SD2752	3 port (Unishare) actuator - with Plug and Gland; Mid position; Spring return action; Normally open to hot water; 4 wire	150.44	8402
SD2701	3 port (Unishare) actuator; Mid position; Spring return action; Normally open to hot water; 4 wire	109.54	8401
SM5201	2 port (Unival) actuator; Motor Open - Motor Closed operation; Energy saving; 4 wire	89.32	8402
SM5203	2 port (Unival) actuator; Motor Open - Motor Closed operation; Energy saving; 5 wire	82.73	8402
SZ2301F	2 port (Unival) actuator; High temp. Spring return action; Normally closed; 4 wire. Aux switch normally open	75.21	8401
SZ2302	2 port (Unival) actuator; Spring return action; Normally closed; 4 wire for gravity DHW systems S.P.D.T Aux switch	85.55	8401
SM5205	2 port (Unival) actuator; Motor Open - Motor Closed operation; Energy saving; 6 wire	113.75	8401
SZ2301	2 port (Unival) actuator; Spring return action; Normally closed; 4 wire. Aux switch normally open	67.21	8401
SZ2351	2 port (Unival) actuator; Spring return action; Normally open; 4 wire for gravity DHW systems. Aux switch normally open	87.43	8401



Valve Bodies

Cat No.	Description	List Price	Disc Group
EDT2702	3 port; 22mm; Unishare /Uniflo valve body - use with SD/SDM actuators	77.52	8401
EML3454	2 port; 22mm; Unival valve body - use with SM / SZ actuators	57.24	8401
EML3503	2 port; 28mm; Unival valve body - use with SM / SZ actuators	76.61	8401

Thermostatic Radiator Valves



Cat No.	Description	List Price	Disc Group
7175510	TRV510 (white) 15mm with 8/10mm fittings 6 - 28°C. Vertical & Horizontal Mounting, Frost Protection, Lockable	18.01	8401
7175515	Lockshield (white) to fit Sunvic TRV510 with 8/10mm fittings	11.59	3521
7175550	TRV510 plus lockshield fittings 15mm with 8/10mm fittings	26.22	3521
7175761	TRV760 (chrome) 15mm with 8/10mm fittings 6 - 28°C. Vertical & Horizontal Mounting, Frost Protection, Lockable	20.47	8402
7175765	Lockshield (chrome) to fit Sunvic TRV760 with 8/10mm fittings	12.39	3521
7175760	TRV760 plus lockshield fittings 15mm with 8/10mm fittings	29.49	8402

Programmable & Timers

Cat No.	Description	List Price	Disc Group
EP101	1 Channel Programmable Heating Controller	76.03	7701
EP110	1 Channel Time Switch	56.66	7701
EP200	2 Channel Programmable Heating Controller	81.73	7701
EP210	2 Channel Time Switch	60.89	7701
EP310	3 Channel Time Switch	74.79	7701



Internet Connected

Cat No.	Description	List Price	Disc Group
IT500	High design 2 channel internet ready thermostat	224.34	7701
IT500BM	Internet thermostat used with plug & play receivers	193.33	7701
LG+5V	Plug-In with Facia plate for IDEAL-LOGIC+/VOGUE	68.19	7701
RT310i	Internet Thermostat	165.52	7701



Valves

Cat No.	Description	List Price	Disc Group
PMV22	22mm 2 port zone valve with Honeywell compatible head	65.98	7701
PMV28	28mm 2 port zone valve with Honeywell compatible head	87.38	7701
PMV32	32mm 3 port zone valve with Honeywell compatible head	73.12	7701
PMV38	38mm 3 port zone valve with Honeywell compatible head	94.52	7701



Thermostats

Cat No.	Description	List Price	Disc Group
RT100	Mechanical Thermostat	19.17	7701
RT200	Electronic Thermostat	33.53	7701
RT310	Digital Room Thermostat	49.37	7701
RT310RF	Digital Room Thermostat With RF	85.01	7701
RT500	Programmable Room Thermostat	76.13	7701
RT510	Digital Programmable Thermostat	62.66	7701
RT510BC	Plug 'N' Play Programmable Room Thermostat	96.30	7701
RT510RF	Programmable Room Thermostat with RF	91.34	7701
RT510TX	Digital Room Thermostat To Replace The RT500TX	57.17	7701
ST620VBC	Radio Frequency Vaillant Boiler Controller	162.10	7701
ST620WBC	Radio Frequency Worcester Boiler Controller	89.17	7701



Ancillaries

Cat No.	Description	List Price	Disc Group
BBP1	BAXI 200/400 Facia Plate To Be Used With RT510BC / RXBC5V / RXBC605	12.48	7701
CT100	Cylinder / Pipe Thermostat	17.53	7701
MP100A	5M Energy Saving A Rated Circulating Pump	130.00	7701
MP200A	6M Energy Saving Pump	139.10	7701
TC100	Wiring Centre	25.07	7701



Wi-Fi Thermostat

TIMEGUARD[®]

A **theben** Group Company

The smart solution for efficient
Wi-Fi installations

- Wi-Fi controlled room thermostat.
- Available for Android and IOS only.
- Works with Wi-Fi and 4G.
- Supports multiple users/devices.
- Enables user to programme, change and check heating status wherever they are.
- Schedule heating times over a week with up to 6 time/temperature periods per day with weekly repeats.
- 5°C to 35°C set temperature range with temperature adjustment in 0.5 or 1.0 degree steps.
- Wall thermostat simply replaces existing 2 or 3 wire installation enabling Wi-Fi connection via home router.



Programa*stat*[®]**+**

The **Smart** Heating
Solution Range

Economy 7

- Interchangeable with Sangamo and Horstmann Economy 7 units.
- Suitable for use with single, dual or twin element immersion heaters.
- Pre-programmed automatic boost and three on-demand options – 30 minutes, 1 & 2 hours.
- Designed for use with Economy 7 off peak rate overnight electricity plans.
- Pre-selected timing options manually adjustable to allow user programming.
- Pre-programmed automatic boost and 3 on demand options – 30 minutes, 1 & 2 hours.
- Countdown boost display showing boost time remaining.
- Fits and supplied with a standard size Economy 7 wall box.



Interchangeable
with Sangamo
and Horstmann units



TRTWIFI

Wi-Fi Programmable Digital Room Thermostat

Cat No	List Price	Disc Group
TRTWIFI	99.99	8801



FSTWIFI

Wi-Fi Controlled Fused Spur

Cat No	List Price	Disc Group
FSTWIFI	77.49	8801



TRT030N

Electronic Room Thermostat

Cat No	List Price	Disc Group
TRT030N	22.99	8801



TRT030DN

Digital Electronic Room Thermostat

Cat No	List Price	Disc Group
TRT030DN	24.99	8801



TRTD7N

Economy 7 Digital Timeswitch with Boost Control

Cat No	List Price	Disc Group
TRTD7N	79.99	8801



TRTM7N

Economy 7 Analogue Timeswitch with Boost Control

Cat No	List Price	Disc Group
TRTM7N	79.99	8801

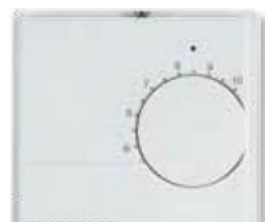

TRT031N

Frost Thermostat

Cat No	List Price	Disc Group
TRT031N	23.99	8801



TRT032N

Tamper Proof Room Thermostat

Cat No	List Price	Disc Group
TRT032N	23.99	8801



TRT034N

7 Day Digital Programmer - 1 Channel

Cat No	List Price	Disc Group
TRT034N	52.49	8801



TRT036N

7 Day Digital Programmer - 2 Channel

Cat No	List Price	Disc Group
TRT036N	56.49	8801



TRT037N

Wireless 7 Day Programmable Room Thermostat

Cat No	List Price	Disc Group
TRT037N	94.99	8801



TRT047N

Wireless Digital Room Thermostat with Night Set Back

Cat No	List Price	Disc Group
TRT047N	81.99	8801

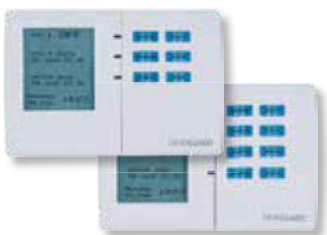

TRT038N/TRT039N

7 Day Digital Heating Programmer - 3/4 Channel

Cat No	List Price	Disc Group
TRT038N	138.99	8801
TRT039N	169.49	8801



TS900B

24hr Timer, 13A (3kW) loading

Cat No	List Price	Disc Group
TS900B	26.52	8801



TRT044

Cylinder/Pipe Thermostat

Cat No	List Price	Disc Group
TRT044	18.49	8801



TRT049N

Wiring Centre Box

Cat No	List Price	Disc Group
TRT049N	14.99	8801

Everyday Solutions from the Nation's No.1 Shower Brand

Avena electric shower



- Swivel-Fit™ - A 180° reversible inlet for left and right hand-side water connectivity
- Left and right hand side cable entry points
- Separate power and temperature controls
- White/Chrome shower kit includes a single mode shower head



Cat No.	Power	List Price	Disc Group
White/Chrome			
SPAVENA8	8.5kW	110.65	6407
SPAVENA9	9.5kW	119.87	6407

T80Z Fast-Fit electric shower



- Swivel-Fit™ - A 180° reversible inlet for left and right hand-side water connectivity
- Swing-Fit™ Terminal for left and right hand-side cabling
- Ideal for replacement installations
- Shower kit includes: 1.25m anti-twist hose and 5 mode, rub clean shower head



6 Cable Entry Points
8 Water Entry Points

Cat No.	Power	List Price	Disc Group
Chrome			
SP8CHR8ZFF	8.5kW	348.60	6407
SP8CHR9ZFF	9.5kW	361.76	6407
SP8CHR1ZFF	10.5kW	374.91	6407
White/Chrome			
SP8007ZFF	7.5kW	238.98	6407
SP8008ZFF	8.5kW	252.13	6407
SP8009ZFF	9.5kW	265.29	6407
SP8001ZFF	10.5kW	278.44	6407
ECO8008ZFF	8.5kW	252.13	6407

T80 Pro-Fit electric shower



- Left and right hand side water entry points
- Swing-Fit™ Terminal for left and right hand-side cabling
- Copper or plastic, Compression or Push-fit Fittings can be used
- Ideal fit for replacement installations
- Shower kit includes: fully adjustable riser rail and 1.5m anti-twist hose with 5 mode, rub clean showerhead



8 Cable Entry Points
8 Water Entry Points

Cat No.	Power	List Price	Disc Group
White			
SP8007PF	7.5kW	255.34	6407
ECO8008PF	8.5kW eco	268.49	6407
SP8008PF	8.5kW	268.49	6407
SP8009PF	9.5kW	281.64	6407
SP8001PF	10.5kW	294.79	6407

T80Z Thermostatic Fast-Fit electric shower



- Precise thermostatic temperature control
- Left and right hand side water entry points
- Swing-Fit™ Terminal for left and right hand-side cabling
- Ideal for replacement installations
- Easy to use controls for both flow and temperature
- Shower kit includes: 1.25m anti-twist hose and 5 mode, rub clean shower head



6 Cable Entry Points
8 Water Entry Points

Cat No.	Power	List Price	Disc Group
White			
SP8008ZFTHM	8.5kW	377.23	6407
SP8009ZFTHM	9.5kW	390.38	6407
SP8001ZFTHM	10.5kW	403.54	6407

AS2000XT thermostatic power shower



- Precise thermostatic temperature control
- Automatic safety shutdown feature
- Adjustable maximum temperature stop



Cat No.	List Price	Disc Group
White/Chrome		
TAS2000XTHM	480.02	6407

T30i hand wash unit



- Ideal where only a cold mains water supply is available
- A single, numbered dial control for start/stop and temperature selection
- Fitted with a 200mm swivel arm



Cat No.	Power	List Price	Disc Group
White/Chrome			
T3A3034i	3kW	107.44	6407

Everyday Solutions from the Nation's No.1 Shower Brand

Exe Bar Mixer thermostatic mixer shower



UNEXTHBMINC

- Thermostatic temperature control
- Automatic safety shutdown
- Separate flow and temperature controls
- Suitable for all water systems
- Shower kit includes: 1.25m anti-twist hose and 3 mode shower head



Cat No.	Product	List Price	Disc Group
Chrome			
UNEXTHBM	Standard Exe	124.61	6407
UNEXTHBMINC	Exe with lever	128.39	6407

Dene Cool Touch Bar Mixer thermostatic mixer shower



- Thermostatic temperature control
- Fast-fit push-fit surface brackets
- Separate flow and temperature controls
- Suitable for all water systems
- Shower kit includes: 1.25m anti-twist hose and 3 mode shower head



Cat No.	Product	List Price	Disc Group
Chrome			
UNDETHBMCT	Cool Touch	157.49	6407
UNDETHBMCTLE	Cool Touch Lever	165.35	6407

Eden Concentric thermostatic mixer shower



2 in 1 Solution

- Thermostatic temperature control
- Separate flow and temperature controls
- Suitable for all water systems
- Shower kit includes: 1.5m anti-twist hose and 5 mode, rub clean shower head



Cat No.	Product	List Price	Disc Group
Chrome			
UNEDTHCM	Concentric	339.85	6407

Omnicare thermostatic electric shower



- Precise thermostatic temperature control within +/-1°C for BEAB Care accreditation
- Easy operation with soft press start/stop power button and looped lever handle
- Tactile surfaces and audible feedback
- Dual purpose grab riser rail option, designed to withstand up to 150kg
- Shower kit includes: 2m anti-twist hose and 5 mode, rub clean shower head



Omnicare Design with Grab Kit

Cat No.	Power	Finish	List Price	Disc Group
CINCDES08WGRB	8.5kW	White	514.79	6407
CINCDES09WGRB	9.5kW	White	528.13	6407

Omnicare Design with Extended Kit

Cat No.	Power	Finish	List Price	Disc Group
CINCDES08W	8.5kW	White	467.13	6407
CINCDES09W	9.5kW	White	480.48	6407

T150+ thermostatic electric shower



- Precise thermostatic temperature control within +/-1°C for BEAB Care accreditation
- Low resistance operation controls and soft press start/stop button
- Extended 670mm riser rail kit with adjustable fixing centres
- Shower kit includes: 1.75m anti-twist hose and 5 mode, rub clean shower head

Cat No.	Power	List Price	Disc Group
White/Chrome			
SP1508WP	8.5kW	391.29	6407
SP1509WP	9.5kW	403.20	6407



NOW. A BETTER FUTURE.

The world of the future is full of challenges. What does the responsible life of tomorrow look like? We take up this complex question – and provide the answer with highly efficient, innovative products and solutions. And the focus is always on you: Making your daily routine simpler is our inspiration for creating innovations, further developments and even more service.

WILO BRINGS THE FUTURE.

www.wilo.com/future

Pioneering for You

wilo

Domestic Circulators



Cat No.	Description	List Price	Disc Group
4215522	Yonos PICO 25/1-5 130mm	118.00	9500
4215516	Yonos PICO 25/1-6 130mm	128.00	9500

Secondary Hot Water



Cat No.	Description	List Price	Disc Group
4035479	SB30 130mm	338.00	9501
4035483	SB60 130mm	522.00	9501
TOP Z			
2048341	30/7 DM PN6/10 RG 180mm	689.00	9501
Brass Unions			
4092743	0.5" x 1"	21.00	9503
2815099	1" x 1.5"	48.00	9503

Light Commercial Range



Cat No.	Description	List Price	Disc Group
2120639	Yonos MAXO 25/0.5-7 PN10	408.00	9501
2120640	Yonos MAXO 25/0.5-10 PN10	551.00	9501
2120642	Yonos MAXO 30/0.5-7 PN10	452.00	9501
2120643	Yonos MAXO 30/0.5-10 PN10	627.00	9501
2120644	Yonos MAXO 30/0.5-12 PN10	813.00	9501

Flanged Pumps



Cat No.	Description	List Price	Disc Group
2120645	Yonos MAXO 40/0.5-4 PN6/10	639.00	9501
2120646	Yonos MAXO 40/0.5-8 PN6/10	757.00	9501
2120647	Yonos MAXO 40/0.5-12 PN6/10	966.00	9501
2120649	Yonos MAXO 50/0.5-9 PN6/10	1163.00	9501

*larger connection sizes available on request

Twin Head Flanged Pumps



Cat No.	Description	List Price	Disc Group
2160585	Yonos MAXO-D 32/0.5-7 PN6/10	1186.00	9501
2120663	Yonos MAXO-D 32/0.5-12 PN6/10	1423.00	9501
2120664	Yonos MAXO-D 40/0.5-8 PN6/10	1485.00	9501
2120665	Yonos MAXO-D 40/0.5-12 PN6/10	2010.00	9501
2120667	Yonos MAXO-D 50/0.5-9 PN6/10	2278.00	9501
2120668	Yonos MAXO-D 50/0.5-12 PN6/10	2716.00	9501

*larger connection sizes available on request

Submersible Pumps



Cat No.	Description	List Price	Disc Group
2043828	Twister TMW 32/8	323.00	9500

A full range of submersible/drainage/sewage pumps available on request

Simply Silent™ Contour

Our quietest bathroom fan. Fact.

And it's So Simple to install

- Suitable for wall, ceiling, panel and window fitting
- Complies with building regulations Part F and L
- Sleek and subtle design, with interchangeable fascia options, available in square and round

Key Features



The Contour Range

4"/100mm **Simply Silent™ Contour** extractor fan, for the effective control of humidity and odours in bathrooms, shower rooms, cloakrooms and toilets.

Cat No.	Reference	Model	Speeds	l/s	Watts	dB(A)@3m	List Price	Disc Group
92960AW	C4S	Standard Square	2	15/21	6.3/7	15/29	41.70	6409
92961AW	C4R	Standard Round	2	15/21	6.3/7	15/29	41.70	6409
92962AW	C4TS	Timer Square	2	15/21	6.3/7	15/29	46.34	6409
92963AW	C4TR	Timer Round	2	15/21	6.3/7	15/29	46.34	6409
92964AW	C4PS	Pullcord Square	2	15/21	6.3/7	15/29	46.34	6409
92965AW	C4PR	Pullcord Round	2	15/21	6.3/7	15/29	46.34	6409
92966AW	C4HTS	Humidistat/Timer Square	2	15/21	6.3/7	15/29	78.79	6409
92967AW	C4HTR	Humidistat/Timer Round	2	15/21	6.3/7	15/29	78.79	6409

4"/100mm **Simply Silent™ Contour – Constant Volume** extractor fan, for the effective control of humidity, odours and mould growth in kitchens, bathrooms, shower rooms, cloakrooms and toilets.

Cat No.	Reference	Model	l/s Bathroom	l/s Kitchen	List Price	Disc Group
92968AW	CV4S	Constant Volume Square	5/8/18	8/13/18	132.38	6409
92969AW	CV4R	Constant Volume Round	5/8/18	8/13/18	132.38	6409
92970AW	LVCV4S	Low Volt Constant Volume Square	5/8/18	8/13/18	154.62	6409
92971AW	LVCV4R	Low Volt Constant Volume Round	5/8/18	8/13/18	154.62	6409

Simply Silent™ DX100

Technologically advanced. Contemporary styling.

- Suitable for wall, ceiling, panel and window fitting
- Complies with building regulations Part F and L
- Traditional grille-style fascia, available in square and round



Key Features



GHOST™
AIR MOVEMENT
TECHNOLOGY



The Simply Silent™ DX100 comes complete with a So Simple universal wall fitting kit.

The DX100 Range

4"/100mm **Simply Silent™ DX100** is a two-speed extractor fan that shares many of the same features and benefits of the Simply Silent™ Contour, but with a more conventional grille-style fascia.

Cat No.	Reference	Model	Speeds	l/s	dB(A)@3m	List Price	Disc Group
93025AW	DX100S	Standard Square	2	15/21	22/34	32.44	6409
93027AW	DX100PS	Pullcord Square	2	15/21	22/34	37.08	6409
93026AW	DX100TS	Timer Square	2	15/21	22/34	37.08	6409
93028AW	DX100HTS	Humidistat/Timer Square	2	15/21	22/34	69.51	6409
93029AW	DX100HPTS	Humidistat/Pullcord/Timer Square	2	15/21	22/34	78.79	6409
93030AW	DX100PIRS	PIR Square	2	15/21	22/34	64.89	6409
93005AW	DX100R	Standard Round	2	15/21	22/34	32.44	6409
93007AW	DX100PR	Pullcord Round	2	15/21	22/34	37.08	6409
93006AW	DX100TR	Timer Round	2	15/21	22/34	37.08	6409
93008AW	DX100HTR	Humidistat/Timer Round	2	15/21	22/34	69.51	6409
93009AW	DX100HPTR	Humidistat/Pullcord/Timer Round	2	15/21	22/34	78.79	6409
93010AW	DX100PIRR	PIR Round	2	15/21	22/34	64.89	6409

Simply Silent™ Shower Fan Complete Range

4"/100mm extractor fan and installation kit

Also available with built-in LED light



GHOST™
AIR MOVEMENT
TECHNOLOGY

- Kit includes:**
- DX100BTR extractor fan
 - External grille
 - 3M flexible ducting



- Kit includes:**
- C4TR extractor fan
 - External grille
 - 3M flexible ducting
 - SELV transformer



Cat No.	Reference	Model	Timer	Speed	l/s	dB(A)@3m	List Price	Disc Group
93086AW	SSSFC	Simply Silent Shower Fan Complete	Yes	2	15/21	22/34	41.70	6410
93087AW	SSISFC	Simply Silent Illumi Shower Fan Complete	Yes	1	21	29	92.70	6410

SEALED SYSTEM KIT

Contents: Filling loop, safety relief valve c/w pressure gauge, four way connector

Cat No.	Description	List Price	Disc Group
SMARTEX	Sealed system kit c/w bracket	78.36	810

CAL-PRO

expansion vessel for heating systems. capacity: from 4 - 600 litres

Cat No.	Description	List Price	Disc Group
130000400	4L Cal Pro heating vessel 3/4" BSP 1.5 bar	58.45	810
130000800	8L Cal Pro heating vessel 3/4" BSP 1.5 bar	47.68	810
1300001200	12L Cal Pro heating vessel 3/4" BSP 2 bar	58.86	810
1300001800	18L Cal Pro heating vessel 3/4" BSP 2 bar	67.23	810
1300002400	24L Cal Pro heating vessel 3/4" BSP 2 bar	77.00	810
1300003503	35L With feet Cal Pro heating vessel 3/4" BSP 2 bar	127.45	810
1300005003	50L With feet Cal Pro heating vessel 3/4" BSP 2 bar	154.27	810
1300008000	80L With base Cal Pro heating vessel 3/4" BSP 2.5 bar	379.68	810
1300010500	105L With base Cal Pro heating vessel 3/4" BSP 2.5 bar	486.95	810
1300015000	150L With base Cal Pro heating vessel 3/4" BSP 2.5 bar	631.59	810
1300020000	200L With base Cal Pro heating vessel 3/4" BSP 2.5 bar	765.41	810
1300025000	250L With base Cal Pro heating vessel 3/4" BSP 2.5 bar	1214.59	810
1300030000	300L With base Cal Pro heating vessel 3/4" BSP 2.5 bar	1458.55	810
1300040000	400L With base Cal Pro heating vessel 3/4" BSP 2.5 bar	1974.41	810
1300050000	500L With base Cal Pro heating vessel 1" BSP 2.5 bar	2422.86	810
1300060000	600L With base Cal Pro heating vessel 1" BSP 2.5 bar	2934.86	810

OEM-PRO

expansion vessel for boilers

Cat No.	Description	List Price	Disc Group
13B6001208	12L OEM Pro Round Flat 531	131.05	810
13B0001805	18L OEM Pro Round Flat 531	134.86	810
13A6000815	8L OEM Pro Round Flat 541	108.18	810
13A6001011	10L OEM Pro Round Flat 541	112.23	810
13N6000619	6L OEM Pro Rectangular Flat 537	136.18	810



ZILMET®



MADE IN ITALY - GLOBALLY RENOWNED

Zilmet UK sizing calculator

The new Zilmet UK sizing calculator is now available for FREE. Get your free calculator by visiting

www.zilmet.co.uk

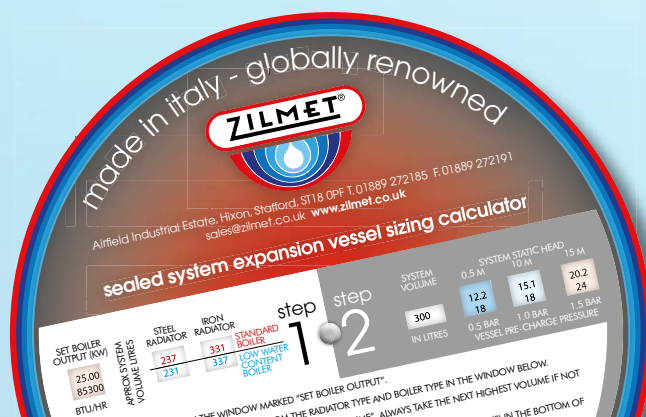

HYDRO-PRO

electric pumps, anti-water hammer and water heaters

Cat No.	Description	List Price	Disc Group
11A0000200	2L Hydro Pro 1/2" BSP 3.5 bar	59.32	810
11A0003500	35L Hydro Pro 1" BSP 2 bar	204.18	810
11A0005000	50L With feet Hydro Pro 1" BSP 2 bar	279.45	810
11A0005002	50L Hydro Pro horizontal 1" BSP 2 bar	418.05	810
11A0008000	80L Hydro Pro 1" BSP 2 bar	557.41	810
11A0010500	105L Hydro Pro 1 1/4" BSP 2 bar	710.64	810
11A0020000	200L Hydro Pro 1 1/4" BSP 2 bar	1253.45	810
11A0040000	400L Hydro Pro 1 1/4" BSP 2 bar	2127.09	810

INOX- PRO

expansion vessel for anti-hammer, use in coastal areas and in the presence of brackishness. capacity: from 0.16 - 18 litres

Cat No.	Description	List Price	Disc Group
11B000AA00	0.16L Inox Pro polished 1/2" BSP	106.00	810
11B000BB00	0.5L Inox Pro polished 1/2" BSP	131.73	810
11B0000100	1L Inox Pro polished 1/2" BSP 3.5 bar	115.68	810
11B0000201	2L Inox Pro polished 1/2" BSP 3.5 bar	198.86	810
11B000AA18	0.16L Inox Pro dull 1/4" BSP	73.36	810
11B000AA02	0.16L Inox Pro dull 1/2" BSP	48.86	810

ULTRA- PRO

potable water, pumps and booster sets

Cat No.	Description	List Price	Disc Group
1100001215	12L Ultra Pro 3/4" BSP 3 bar	121.55	810
1100001940	19L Ultra Pro 3/4" BSP 3 bar	128.27	810
11000024A8	24L Ultra Pro horizontal 3/4" BSP 1.5 bar	192.82	810
1100020007	200L Ultra Pro horizontal 1 1/2" BSP 1.5 bar	1457.77	810
1100030007	300L Ultra Pro horizontal 1 1/2" BSP 1.5 bar	1728.73	810
1100006006	60L Ultra Pro 1" BSP 1.5 bar	537.14	810
1100008006	80L Ultra Pro 1" BSP 1.5 bar	682.09	810
1100010006	100L Ultra Pro 1" BSP 1.5 bar	829.86	810
1100020006	200L Ultra Pro 1 1/2" BSP 1.5 bar	1373.32	810

WATER- PRO

electric pumps and water heaters

Cat No.	Description	List Price	Disc Group
11A0000517	5L Water Pro 3/4" BSP 3 bar	72.36	810
11A0000822	8L Water Pro 3/4" BSP 3 bar	76.95	810
11A0001214	12L Water Pro 3/4" BSP 2 bar	88.82	810
11A0001821	18L Water Pro 3/4" BSP 2 bar	102.27	810
11A0002425	24L Water Pro 1" BSP 2 bar	118.59	810

BRACKETS

Cat No.	Description	List Price	Disc Group
HVMB	Mounting bracket 4-24L heating	11.23	810
WVMB	Mounting bracket with ring 4-24L potable	31.77	810





It's Hydroboil. Refreshed.

Our on-wall boiling range has had a facelift!

The same reliable, energy efficient performance on the inside, a new modern design on the outside. The Zip Hydroboil range continues to offer specifiers and end-users the reliable performance they expect, delivering energy and cost efficient boiling water at the touch of a lever.

Visit specify.zipwater.co.uk to view the whole range or call 0345 6 005 005



It's water. Refreshed.

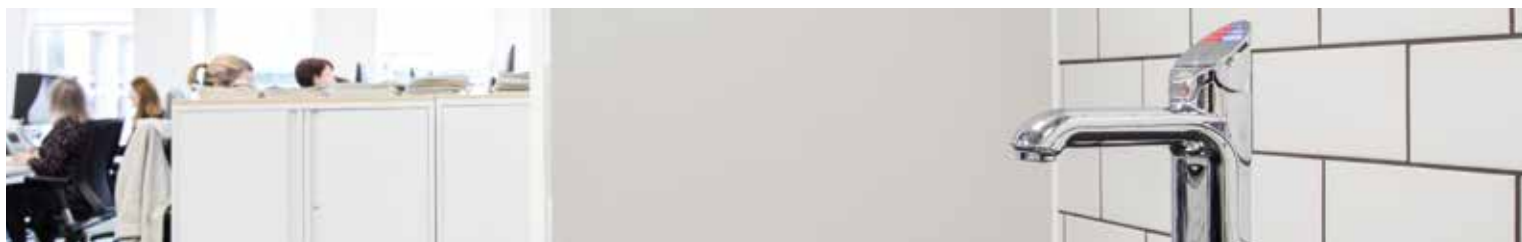

ZIP HYDROTAP[®] COMMERCIAL RANGE

CAT NO.	BOILING	CHILLED	SPARKLING	HOT & COLD	CUPS PER HOUR	GLASSES PER HOUR	LIST PRICE	DISC GROUP
HYDROTAP G4 Classic								
HT1762UK	•	•	•		160	175	4397.46	9702
HT1704UK	•	•			160	175	3837.78	9702
HT1706UK	•				160	N/A	1945.55	9702
HT1765UK		•	•		N/A	175	2997.74	9702
HT1711UK		•			N/A	175	2438.06	9702

PRODUCT CODE	PRODUCT NAME	DESCRIPTION	LIST PRICE	DISC GROUP
HYDROTAP G4				
CH101	CHILLMASTER	Floorstanding	1756.15	9701
CH102	CHILLMASTER	Wall mounted	1730.40	9701
CH104	WALL FOUNTAIN	Recessed chiller	4107.64	9701
CH103	CHILLTAP	Counter mounted	1529.55	9701
CT2/140	CHILLTAP EXTRA	Chilled and ambient water	1660.36	9701

ZIP HYDROTAP[®] FINISHES

BRIGHT CHROME

This is our standard finish and prices are quoted opposite

BRUSHED CHROME

To order this finish add Z1 to the code (e.g HT1783Z1UK)

GLOSS BLACK

To order this finish add Z2 to the code (e.g HT1783Z2UK)

MATT BLACK

To order this finish add Z3 to the code (e.g HT1783Z3UK)

Prices will vary for finishes other than Chrome. Contact us for details.

ZIP HYDROTAP[®] ACCESSORIES

PRODUCT CODE	DESCRIPTION	LIST PRICE	DISC GROUP
HYDROTAP ACCESSORIES FOR COMMERCIAL USE			
ZT402	Replacement 0.2 micron filter cartridge for HydroTap G4 models	90.83	9703
ZT007	Tap font for Industrial side button tap	204.69	9703
90915UK	Tap font and drip tray for HydroTap G4 Classic tap (bright chrome)	190.84	9703
ZT400	CO ₂ replacement cylinder	38.63	9703
93702	ZIP MicroPurity™ filter for HydroTap 0.2 micron	125.00	9703
93703	ZIP MicroPurity™ filter for HydroTap 3 micron	125.00	9703
FL250	ZIP Scale Prevention Filter 2,250 litres	99.17	9703
FL500	ZIP Scale Prevention Filter 3,750 litres	124.17	9703
FL1000	ZIP Scale Prevention Filter 7,000 litres	165.83	9703
FL1500	ZIP Scale Prevention Filter 10,000 litres	224.17	9703
FL2000	ZIP Scale Prevention Filter 16,500 litres	307.50	9703
FL250G4 KIT	ZIP Scale Filter Installation Kit G4 2,250 Litre	208.33	9703
FL500G4 KIT	ZIP Scale Filter Installation Kit G4 3,750 Litre	232.50	9703
FL1000G4 KIT	ZIP Scale Filter Installation Kit G4 7,000 Litre	275.00	9703
FL1500G4 KIT	ZIP Scale Filter Installation Kit G4 10,000 Litre	333.33	9703
FL2000G4 KIT	ZIP Scale Filter Installation Kit G4 16,500 Litre	416.66	9703

ZIP CHILLTAP



ZIP ACCESSORIES





ZIP ON WALL BOILING WATER

Our wall-mounted boiling water heaters are essential appliances for the workplace and are available in the widest range of models and capacities.



THE ZIP HYDROBOIL PLUS

Cuts energy consumption in 5 ways

- Super-Heat-Boost System
- Power-Pulse™ energy saving technology
- Inactivity sleep mode
- Low light sleep mode
- Integral 24 hour 7 day timer

CAT NO.	CAPACITY IN LITRES	CUPS AT ONCE	CUPS PER HOUR	RATING kW @230V	LIST PRICE	DISC GROUP
ZIP HYDROBOIL PLUS						
303562	3	18	100	1.5	1035.00	9701
305562	5	30	140	2.4	1170.00	9701
307562	7.5	45	140	2.4	1305.00	9701
ZIP HYDROBOIL						
301552	1.5	9	100	1.5	760.00	9701
303552	3	18	100	1.5	920.00	9701
305552	5	30	140	2.4	1025.00	9701
307552	7.5	45	140	2.4	1130.00	9701
310552	10	60	180	3.0	1390.00	9701
315552	15	90	180	3.0	1695.00	9701
325552	25	150	180	3.0	2075.00	9701
340552	40	240	240	2x 3.0	2605.00	9701
ZIP ECONOBOIL						
303542	3	18	100	1.5	671.00	9701
305542	5	30	140	2.4	761.00	9701

ZIP HOT WATER

Our energy efficient water heaters provide instantaneous and unlimited hot water, with a range of products to suit every requirement.

ZIP INLINE ES

- Instant hot water for handwashing
- The most energy efficient way to directly heat water, electrically

ZIP INLINE CEX

- Provides a constant supply of hot water
- Available for installation over-sink (CEX-O), or under-sink (CEX-U)

ZIP INLINE DEX/DBX

Single or multiple outlets for hand-washing sinks, showers and baths

- Provide a constant supply of hot water, to one or more outlets
- Regulate power consumption electronically, depending on supply water temperature, pressure and flow rate, to maintain set temperature

CAT NO.	DETAILS	RATING kW @230V	ERP RATING	LIST PRICE	DISC GROUP
INLINE ELECTRONIC INSTANTANEOUS WATER HEATERS					
ES3	Single outlet for handwashing	2.8	A	263.32	9701
ES4	Single outlet for handwashing	4.4	A	283.57	9701
ES6	Single outlet for handwashing	5.5	A	303.83	9701
CEX-U	Undersink	6.6 - 8.8	A	333.68	9701
CEX-O	Oversink	6.6 - 8.8	A	333.68	9701
DEX12	Three phase	18 - 27	A	462.67	9701
DBX18	Three phase	18	A	667.35	9701
DBX21	Three phase	21	A	686.54	9701
DBX24	Three phase	24	A	699.33	9701
DBX27	Three phase	27	A	711.06	9701





ZIP HOT WATER CONTINUED

CAT NO.	PRODUCT NAME	DETAILS	CAPACITY IN LITRES	RATING kW @230V	ERP RATING	LIST PRICE	DISC GROUP
VENTED OPEN OUTLET WATER HEATERS FOR SINGLE OUTLETS							
P4/52	TUDOR	Vented open outlet, oversink	5	2.0	A	188.70	9701
P4/102	TUDOR	Vented open outlet, oversink	10	2.0	A	227.07	9701
P4/52UB	TUDOR	Vented open outlet, undersink	5	2.0	A	170.57	9701
P4/102UB	TUDOR	Vented open outlet, undersink	10	2.0	A	206.82	9701
C2/50	CONTRACT	Vented open outlet, oversink	5	2.0	A	110.87	9701
C2/100	CONTRACT	Vented open outlet, oversink	10	2.0	A	167.37	9701
UNVENTED WATER HEATERS FOR SINGLE OR MULTIPLE OUTLETS							
AP3/05	AQUAPOINT	Glass lined, undersink	5	2.0	A	197.22	9701
AP3/10	AQUAPOINT	Glass lined, undersink	10	2.0	A	221.74	9701
AP3/15	AQUAPOINT	Glass lined, undersink	15	2.0	A	238.80	9701
AP3/05/OB	AQUAPOINT	Glass lined, oversink	5	2.0	A	197.22	9701
AP3/10/OB	AQUAPOINT	Glass lined, oversink	10	2.0	A	221.74	9701
AP3/15/OB	AQUAPOINT	Glass lined, oversink	15	2.0	A	238.80	9701
AP3/30E	AQUAPOINT	Glass lined	30	2.0	C	487.19	9701
AP3/50E	AQUAPOINT	Glass lined	50	2.0	C	505.73	9701
AP3/80E	AQUAPOINT	Glass lined	80	2.0	C	532.51	9701
AP3/100E	AQUAPOINT	Glass lined	100	2.0	C	577.83	9701
VP103	VARIPOINT	Copper tank, P&T valve, oversink	10	2.2	A	407.24	9701
VP153	VARIPOINT	Copper tank, P&T valve, oversink	15	2.2	A	470.13	9701
VP103/UB	VARIPOINT	Copper tank, P&T valve, undersink	10	2.2	B	407.24	9701
VP153/UB	VARIPOINT	Copper tank, P&T valve, undersink	15	2.2	A	470.13	9701



ZIP TUDOR



ZIP AQUAPOINT



ZIP VARIPOINT

ZIP HOT WATER ACCESSORIES

PRODUCT CODE	DESCRIPTION	LIST PRICE	DISC GROUP
VENTED ACCESSORIES			
OB/1	300mm spout and valve for oversink models	35.02	9703
TS/1	Telescopic spout 350-600mm for oversink models	56.65	9703
UB/1	Monobloc mixer vented tap for Tudor undersink	113.30	9703
UB/6	Single lever basin tap for Tudor undersink	129.78	9703
UB/7	Single lever sink tap for Tudor undersink	147.29	9703
UNVENTED ACCESSORIES			
AQ1	Pressure & temperature relief valve	96.82	9703
AQ2	Expansion vessel & check valve	85.49	9703
AQ3	Pressure reducer & line strainer	85.49	9703
AQ4	Thermostatic blending valve	124.63	9703

OUR PRODUCTS
ARE ERP
COMPLIANT



For all your water-delivery needs, we can meet your requirements.

Our wide range of products are designed to suit any application – for home or work.

AIANO

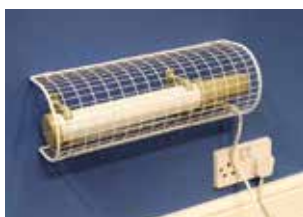

Cat No.	Description	Dimensions (mm)	List Price	Disc Group
Tubular Heater Guards				
STG11	1ft single guard	408x137x114	14.29	6403
STG12	1ft double guard	408x222x114	15.90	6403
STG13	1ft treble guard	408x305x114	19.98	6403
STG21	2ft single guard	713x137x114	19.92	6403
STG22	2ft double guard	713x222x114	23.13	6403
STG23	2ft treble guard	713x305x114	28.25	6403
STG24	2ft quad guard	713x508x114	38.85	6403
STG31	3ft single guard	1018x137x114	25.73	6403
STG32	3ft double guard	1018x222x114	30.65	6403
STG33	3ft treble guard	1018x305x114	42.27	6403
STG34	3ft 4 bank guard	1018x508x114	53.13	6403
STG41	4ft single guard	1323x137x114	31.15	6403
STG42	4ft double guard	1323x222x114	36.38	6403
STG43	4ft treble guard	1323x305x114	50.73	6403
STG44	4ft 4 bank guard	1323x508x114	65.21	6403
STG51	5ft single guard	1630x137x114	36.27	6403
STG52	5ft double guard	1630x222x114	43.10	6403
STG53	5ft treble guard	1630x305x114	61.58	6403
STG54	5ft 4 bank guard	1630x508x114	80.92	6403
STG61	6ft single guard	1933x137x114	43.79	6403
STG62	6ft double guard	1933x222x114	51.83	6403
STG63	6ft treble guard	1933x305x114	74.88	6403
STG64	6ft 4 bank guard	1933x508x114	114.71	6403



MODULO PLUS MOTORISED BALL VALVES



Cat No.	Description	List Price	Disc Group
Motorised Valves			
01425700	1 1/4" Modulo Plus 2-Way Pipe union	381.00	3601
01425702	1 1/2" Modulo Plus 2-Way Pipe union	465.80	3601
01425704	2" Modulo Plus 2-Way Pipe union	588.80	3601
01425710	1 1/4" Modulo Plus 3-Way Pipe union	437.70	3601
01425712	1 1/2" Modulo Plus 3-Way Pipe union	562.10	3601
01425714	2" Modulo Plus 3-Way Pipe union	756.60	3601

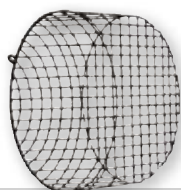

Cat No.	Description	List Price	Disc Group
Terminal Guards			
TG18	8x4x3 PVC coated overflow guard	8.03	3401
HAV TGC	11x5x9 PVC coated	10.44	1102



Cat No.	Description	List Price	Disc Group
Thermocouples			
7000/900MM	900mm Universal thermocouple	9.88	1601



Cat No.	Description	List Price	Disc Group
Pump Valves			
305208	22mm Ball type pump valve	5.50	3501
305212	28mm Ball type pump valve	6.75	3501
305226	22mm Gate type pump valve	5.71	3501
305230	28mm Gate type pump valve	7.68	3501
305409	Short pump adaptor	5.79	3501
305413	Long pump adaptor	7.73	3501
305418	Short pump union	6.80	3501
305422	Long pump union	7.82	3501
305427	Fibre pump gasket	0.49	3501
305431	Rubber pump gasket	0.49	3501

Cat No.	Description	List Price	Disc Group
Gate Valves			
302209	15mm Brass gate valve BS5154	5.44	3501
302213	22mm Brass gate valve BS5154	6.64	3501
302218	28mm Brass gate valve BS5154	12.00	3501
302312	22mm Brass gate valve - lockshield	6.75	3501

Cat No.	Description	List Price	Disc Group
Stop Cocks			
301606	15mm Brass stopcock	5.71	3501
301611	22mm Brass stopcock	9.67	3501

Cat No.	Description	List Price	Disc Group
Service & Isolating Valves			
304609	15mm Chrome isolating valve	1.52	3501
304807	15mm X 1/2" Straight service valve CP	1.97	3501
304829	15mm X 1/2" Angled service valve CP	2.41	3501

Cat No.	Description	List Price	Disc Group
Filling Loop			
307425	PART L Filling loop - straight	10.21	3501

Water Meters



Available on Request



Cat No.	Description	List Price	Disc Group
Giacomini Radiator Valves			
R26GBX023	AQUARIUS 15mm angle lockshield/wheelhead radiator valve skin pack	6.97	4101



Cat No.	Description	List Price	Disc Group
Surestop			
SS/15/SPL	15mm Surestop stopcock	49.29	8501
SS/22/SPL	22mm Surestop stopcock	54.29	8501
SS/15/RPL	15mm Surestop remote stopcock	91.43	8501
SS/22/RPL	22mm Surestop remote stopcock	107.14	8501



new

Cat No.	Description	List Price	Disc Group
Giacomini Radiator Valves			
LAC-22108	LA-CO Regular Flux 475g	21.18	5101
LAC-22105	LA-CO Regular Flux 125g	7.91	5101
LAC-22103	LA-CO Regular Flux 60g	4.70	5101
LAC-22195	LA-CO Flux 125g. Brush in cap	6.98	5101
LAC-42008	LA-CO Slic-Tite 120ml BIC	11.49	5101
LAC-42018	LA-CO Slic-Tite 120ml BIC	19.59	5101
LAC-79704N	LA-CO Precision Spout Oiler 118ml	3.22	5101
LAC-11525	LA-CO Cool Gel 947ml/32oz	23.50	3512



Teddington
Appliance Controls



Cat No.	Description	List Price	Disc Group
Fire Safety Valves			
KBB/C/65 1.5M	1.5m Capillary 65°	52.48	6401
KBB/C/65 3.0M	3.0m Capillary 65°	55.43	6401
KBB/C/65 6.0M	6.0m Capillary 65°	61.45	6401
KBB/C/65 9.0M	9.0m Capillary 65°	69.13	6401
KBB/C/65 12.0M	12m Capillary 65°	92.25	6401
KBB/C/90 2.0M	2.0m Capillary 90°	53.18	6401
KBB/C/90 3.0M	3.0m Capillary 90°	55.43	6401



Cat No.	Description	List Price	Disc Group
Scalemaster			
400105	Magnetic limescale inhibitor Speedfit 15mm	42.06	7901
400143	Magnetic limescale inhibitor Gold 15mm	47.18	7901
400259	Magnetic limescale inhibitor Gold 22mm	58.42	7901
401010	Electrolytic limescale inhibitor Speedfit 15mm	55.88	7901
401041	Electrolytic limescale inhibitor Gold 15mm	61.02	7901
401065	Electrolytic limescale inhibitor Gold 22mm	85.95	7901
402031	Electrolytic limescale inhibitor Gold 28mm	265.48	7901
500010	SM1 Inhibitor 1 litre	11.30	7902
500119	SM2 De-scaler	11.30	7902
500218	SM3 Cleaner	11.30	7902
500317	SM4 Sludge remover	11.30	7902



Cat No.	Description	List Price	Disc Group
Tiger Loop			
TIGERLOOP	Titan TIGERLOOP oil unit	103.35	6401

A series of horizontal dotted lines for taking notes.

A series of horizontal dotted lines for taking notes.

Warranty Chart 2018-2019

Manufacturer	Warranty Period	2018												2019											
		J	F	M	A	M	J	J	A	S	O	N	D	J	F	M	A	M	J	J	A	S	O	N	D
ACL INNENVS MOTORROL VALVES ETC	18M - DOM	Date of Manufacture indicated on Unit + Warranty Period IE: 26/18 Expires Jan/20																							
ACL INNENVS LIFESTYLE PROGRAMMES ETC	18M - DOM	Date of Manufacture indicated on Unit + Warranty Period IE: 26/18 Expires Jan/20																							
AQUABION	5 yr - DOM	Date of Sale indicated on Unit																							
CIRCULATING PUMPS	30M - DOM	0815	0915	1015	1115	1215	0116	0216	0316	0416	0516	0616	0716	0816	0916	1016	1116	1216	0117	0217	0317	0417	0517	0617	0717
AITECNIC	12M - DOM	5216	0417	0917	1317	1717	2217	2617	3017	3417	3917	4417	4817	5217	0418	0918	1318	1718	2218	2618	3018	3418	3918	4418	4818
DANFOSS (TRV) (EGA/BS-A3 OR B3)	24M - DOM	A/B16	C/D16	E/F16	G/H16	I/J16	M/N16	O/P16	R/S16	T/U16	V/W16	X/Z16	A/B17	C/D17	E/F17	G/H17	I/J17	K/L17	M/N17	O/P17	R/S17	T/U17	V/W17	X/Z17	
DANFOSS (OTHER)	24M - DOM	0516	0916	1416	1816	2216	2716	3116	3616	4016	4416	4916	5216	0517	0917	1417	1817	2217	2717	3117	3617	4017	4417	4917	5217
DANFOSS MOTORISED VALVE BODIES	24M - DOM	NL	OA	OB	OC	OD	OE	OF	OG	OH	OI	OJ	OK	OL	PA	PB	PC	PD	PE	PF	PG	PH	PI	PJ	PK
DANFOSS RANDALL	24M - DOM	Expiry Date indicated on Unit No Sticker No Warranty																							
DELTA DORE	5 yr - DOM	Date of Sale indicated on Unit																							
DRAYTON (INNENVS)	18M - DOM	Date of Manufacture indicated on Unit + Warranty Period IE: 15/18 Expires Sept/19																							
GRUNDFOS PUMPS	30M - DOM	1533	1537	1541	1545	1549	1551	1604	1608	1612	1617	1621	1625	1633	1637	1641	1645	1649	1651	1704	1708	1712	1717	1721	1725
GRUNDFOS PUMPS	5 yr - DOM	Domestic heating circulators UPS2-1.5-50/60 ALPHA2 ALPHA3 series purchased from 1st Jan 2014 PC 1401. Booster pumps SQUAL2 AMAZON AMAZON UNIVERSAL shower pumps from 1st March 2017 PC 1709. Proof of purchase required																							
HEATMISER	2 yr - DOM	Date of Sale indicated on Unit. Proof of purchase required																							
HONEWELL	18M - DOM	1632	1637	1641	1645	1650	1701	1705	1710	1715	1719	1723	1727	1732	1737	1741	1745	1750	1801	1805	1810	1815	1819	1823	1826
HORSTMANN	2 or 5 yr DOM	XL Models & Valves 5 Years all other 2 Years from DOM indicated on Unit IE 10/15 on XL Expires 10/20 (Oct 2020)																							
SIEMENS	24M - DOM	0116	0216	0316	0416	0516	0616	0716	0816	0916	1016	1116	1216	0117	0217	0317	0417	0517	0617	0717	0817	0917	1017	1117	1217
MVSON HEATING	18M - DOM	0616	0716	0816	0916	1016	1116	1216	0117	0217	0317	0417	0517	0617	0717	0817	0917	1017	1117	1217	0118	0218	0318	0418	0518
BAXI POTERTON	12M - DOM	170101	170201	170301	170401	170501	170601	170701	170801	170901	171001	171101	171201	180101	180201	180301	180401	180501	180601	180701	180801	180901	181001	181101	181201
SALAMANDER	15M - DOM	Expiry Date indicated on Unit																							
ESI CONTROLS	24M - DOM	0516	0916	1416	1816	2216	2716	3116	3616	4015	4416	4916	5216	0517	0917	1417	1817	2217	2717	3117	3617	4017	4417	4917	5217
SALUS	5 yr - DOM	Date of Installation, Proof of purchase required																							
SUNVIC	18M - DOM	GM	HM	IM	JM	KM	LM	AM	BN	CN	DN	EN	FN	GN	HN	IN	JN	KN	LN	AO	BO	CO	DO	EO	FO
SUNVIC	18M - DOM	0616	0716	0816	0916	1016	1116	1216	0117	0217	0317	0417	0517	0617	0717	0817	0917	1017	1117	1217	0118	0218	0318	0418	0518
SUNVIC (BRITISH GAS ONLY)	Yellow Label	Expiry Date indicated on Unit																							
TEKNIGAS	12M - DOM	0117	0217	0317	0417	0517	0617	0717	0817	0917	1017	1117	1217	0118	0218	0318	0418	0518	0618	0718	0818	0918	1018	1118	1218
WILCO SALMONSON (COMMERCIAL)	18M - DOM	0616	0716	0816	0916	1016	1116	1216	0117	0217	0317	0417	0517	0617	0717	0817	0917	1017	1117	1217	0118	0218	0317	0418	0518

Warranty cover will always be subject to manufacturer test results and approval.

How to use this guide

1. Select manufacturer (also type of product if manufacturer has a number of different methods of date coding).
 2. Follow the line along to select the current month.
 3. Note where the line of the current month meets the manufacturer. The current month and any months to the right are in warranty, any codes to the left have expired.
- Warranty periods quoted refer to date of manufacture and not date of installation. H&V withhold the right to alter the periods quoted without prior notice, **E & O.E.**

Should you have an issue with a product from the following manufacturer, please contact them directly to arrange an engineer visit or return.

Heatrae Sadia: 0344 871 1535 | Nest: 0808 169 2307 | Triton: 02476 372 222 | Zip: 0345 600 5005

NB. DOM Represents date of manufacture

- 1 **General.** All goods supplied by us are sold only upon the following conditions. The placing of an order for any such goods, or the acceptance of our quotation or tender or of delivery of the goods, includes acceptance of the following conditions. Unless expressly agreed by us in writing any other terms or conditions (including any which may be contained in your order) are excluded. Unless expressly incorporated in our quotation or tender, all descriptions, illustrations, drawings, dimensions, weights, measures, specifications, standards of performance or other descriptive matter or pre-contractual statements are approximate only and shall not form part of the contract. Our record of any order placed by you verbally shall be conclusive as to the type and quantity of product and the point and date of delivery.
- 2 **Validity.** Unless previously withdrawn, our quotation is open for acceptance within the period stated therein or, when no period is so stated, within 30 days after its date, and is subject to written confirmation by us at the time of acceptance. All goods are offered subject to their being available upon receipt of order.
- 3 **Delivery.** Unless otherwise specified, the price quoted includes delivery to any premises specified by you within our van delivery area, full details of which are available on request. The risk of all goods passes to you when they first enter those premises or are placed in store under Clause 5. We reserve the right to choose the method of transport, to charge for deliveries outside our van delivery area, and to charge you with all manufacturers' carriage charges for special items.
- 4 **Delivery times.** Time for delivery shall not be of the essence of the contract unless previously agreed by us in writing. Any delivery dates or times quoted are approximate only as we are subject to the manufacturers' or suppliers' delivery promises which are passed on to you in good faith. For the avoidance of doubt such delivery dates or times given to you shall not create a contractual obligation to deliver on such date or time and accordingly no liability shall be accepted by us for any claim by you or any third party for direct or consequential loss or damage arising from delay in delivery.
- 5 **Delay in delivery.** If we do not receive sufficient forwarding instructions within 14 days after notification that the goods are ready for despatch, you will either take delivery or arrange for storage. Otherwise we shall be entitled to arrange storage on your behalf and at your risk, either at our own works (making a charge of 1 1/2% of the invoice value of the goods per month) or elsewhere. We shall be entitled to payment as if the goods had been duly delivered. All charges for storage, insurance or demurrage will be payable by you.
- 6 **Acceptance.** Unless you give us written notice within 7 days from the date of delivery that the goods are not in conformity with the contract, you are deemed to have accepted the goods.
- 7 **Passing of property.** Each of the following sub-clauses 7.1 to 7.6 are separate and severable and shall be enforceable accordingly:
 - 7.1 Notwithstanding delivery, all goods supplied by us will remain our absolute property until you pay in full for them and for all other goods previously supplied by us;
 - 7.2 You will store the goods in such a way that they are readily identifiable as our property, but you may, as trustees for us, sell them to a third party in the normal course of your business;
 - 7.3 Upon any sale by you of the goods (either alone or with other items) all rights which you have against the buyer shall automatically vest in us;
 - 7.4 We shall be entitled immediately after giving notice of our intention to repossess, to enter upon any premises with such transport as maybe necessary and repossess any goods to which we have title under this Clause;
 - 7.5 If you incorporate the goods we supply to you into other products with or without materials you already possess or which are supplied to you by third parties the property in such other product will pass to us and you shall store them without charge on our behalf as bailee;
 - 7.6 You shall not be entitled to pledge or in any way charge by way of security any of the goods which remain our property but in the event you do so all monies owing by you to us shall, without prejudice to any other right or remedy available to us forthwith, become due and payable.
- 8 **Loss or damage in transit.** Any shortage or damage must be clearly stated upon the driver's Delivery Sheet and a written statement of the facts received at our branch and by the Carrier (if not ourselves) within 3 days after the date of delivery, otherwise no claim will be entertained. The package and contents should be retained for examination. Written notice of any non-delivery must be received at our branch within 7 days after the date of invoice. Time is of the essence of this clause. Our liability in respect of any claim accepted under this Clause is limited to making up the shortage or replacing any goods proved to have been damaged or lost in transit to the point of delivery, and we accept no liability for any loss or damage suffered by you, whether direct or consequential and howsoever arising.
- 9 **Packing etc.** Crates, cases, pallets, stillages or skids or other returnable packaging are not included in the quoted price, and will be charged at current rates. You will, however, be credited with the amount charged when it is returned to us in good condition within 14 days of the date of our invoice. Cable drums will be charged in accordance with the makers' drum schedules.
- 10 **Prices.** All goods are sold subject to the prices and any relevant discounts ruling at the time of delivery. Our prices, discount rates and Conditions of Sale may be altered at any time without notice. All discounts and prices are calculated upon a "whole order" or "majority of the order" basis. If, when placing your order you select only certain items or reduced quantities are specified, we must reserve the right to review the discounts and prices at the time such orders are accepted.
 - 10.1 All prices given are further subject to VAT (Value Added Tax) at the rate applicable at the time of despatch.
 - 10.2 All priced documents are further subject to VAT (Value Added Tax) at the rate applicable at the time of despatch.
- 11 **Payment.** Payment in full without retention or set-off shall be due not later than the end of the month following that in which the goods were delivered, or on earlier demand. If you do not comply punctually with these terms of payment we reserve the right to charge you interest on any amount overdue at the rate of 2% over the Royal Bank of Scotland plc base rate current for the time being, and without notice to suspend further deliveries until all arrears (including interest) have been paid and, at our option, to rescind any subsisting contract with you as to all or any parts of future deliveries but without prejudice to any rights already accrued to us under such contracts.
- 12 **Performance.** It is your responsibility to determine that the goods are sufficient and suitable for the purpose to which they are to be put. We cannot accept any responsibility either in respect of installation of any goods or as to the ultimate performance of any product in which the goods may be installed. We shall in no way be liable for any direct or consequential damage, loss or expense arising from any defect or inefficiency caused by the manner in which the goods are used.
- 13 **Defects after delivery.** All goods supplied by us are manufactured by others. Accordingly, we shall pass on to you the benefit of the warranty, if any, given by the manufacturer of the goods. Our liability under this Clause shall be in lieu of any warranty or condition implied by law as to the quality or fitness for any particular purpose of the goods, and we shall not be under any liability, whether in contract, tort or otherwise in respect of any goods or loss resulting from such defects or from anything done or omitted in connection with the goods or from any work done in connection therewith.
- 14 **Return of goods.** In no circumstances may goods supplied against a firm order be returned without our prior written consent and the receipt of your advice note stating the reason for the return and the date and number of our invoice. All goods returned must be securely packed and, unless we arrange collection, consigned carriage paid. If we collect we reserve the right to make a handling charge, and the issue of our collection note will not bind us to issue any credit in respect of the goods.
- 15 **Termination.** We may without prejudice to our other rights and remedies determine the contract or any unfulfilled part of it or withhold further deliveries or make partial deliveries if:
 - (a) you fail to make a payment on the due date under this or any other contract between us;
 - (b) you purport to cancel or suspend, or commit any breach of this or any other contract between us;
 - (c) you become insolvent or make any composition with your creditors or have a receiver appointed of all or any part of your undertaking or assets or go into liquidation (save for the purposes of amalgamation or reconstruction) and we shall be entitled to recover from you all our loss including any loss of profit or loss on re-sale.
- 16 **Waiver.** Any failure by us to enforce any or all of these Conditions shall not be construed as a waiver of any of our rights hereunder.
- 17 **Rights of third parties.** For the avoidance of doubt the provisions of the Contracts (Rights of Third Parties) Act 1999 shall not apply to any term or condition hereof and nothing contained herein shall confer on any third party any benefit or the right to enforce any term or condition hereof.
- 18 **WEEE Directive.** You shall be responsible for the cost of collection, treatment, recovery and environmentally sound disposal of all goods that fall within the scope of the WEEE directive where you are not the end user.
 - 18.1 Nothing in clause 18 shall prevent a producer from concluding an agreement whereby the parties to the agreement make alternative arrangements between themselves to finance the costs of the collection, treatment, recovery and environmentally sound disposal of WEEE.
- 19 **Promotions.** We reserve the right, during any promotion that offers a FREE product when reaching a certain order requirement, to supply an alternative or nearest equivalent item.
 - 19.1 We reserve the right to amend or withdraw any promotional offer without notice.
- 20 **E&OE (Errors and Omissions Excepted).** Although we strive to keep the content of all our publications, literature and communications as accurate as possible, we cannot be held responsible for any errors and/or omissions.

OUR LOCATIONS

H&V NORTHERN



Manager - Mark Burns

Units 9 & 10
Morgans Business Park
Bettys Lane
Norton Canes
Cannock
West Midlands
WS11 9UU

Tel: 01543 277 725
Fax: 01543 277 938
Email: sales.northern@hav.co.uk

H&V SOUTHERN



Manager - Spencer Stokes-Hart

Conservation House
Blackhorse Road
Letchworth Garden City
Hertfordshire
SG6 1HD

Tel: 01462 674 201
Fax: 01462 480 226
Email: sales.southern@hav.co.uk

SPECIALISED SERVICE - FAST

WWW.HAV.CO.UK