

# orthopaedic

bone cutting forceps	PAGE 181
bone rongeurs	PAGE 183
bone holding forceps	PAGE 186
plaster spreaders and shears	PAGE 190
bone curettes	PAGE 192
bone levers	PAGE 197
retractors	PAGE 198
hooks, rugines and raspatories	PAGE 200
osteotomes, chisels and gouges	PAGE 202
wire cutters, pliers, and accessories	PAGE 206
mallets	PAGE 211
rasps	PAGE 215
files and punches	PAGE 216
pushers, impactors, and skids	PAGE 217
elevators	PAGE 217
elevators, retractors and bone levers	PAGE 220
saws, shears and knives	PAGE 226
nail and staple instruments	PAGE 228
screw and plate instruments	PAGE 230
chucks	PAGE 232
drills and cerclage wire	PAGE 234
AO type instruments	PAGE 235
clover leaf nails and instruments	PAGE 239
threaded pins, rush pins, and guide wires	PAGE 240
wires and pins	PAGE 241
kirschner/arthrodesis wires and accessories	PAGE 242
staples, nuts and washers	PAGE 245
lead hands	PAGE 246



## BONE CUTTING FORCEPS

### McIndoe bone cutting forcep

lightweight, compound action, angled jaw with prismatic points

**SC-OR/13b** 165mm long

**SC-OR/13c** 191mm long

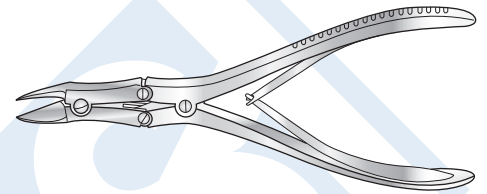

### Liston screw joint bone cutting forcep

with fluted handle

150mm long

**SC-OR/24** straight

**SC-OR/24a** angled

180mm long

**SC-OR/25** straight

**SC-OR/25a** angled

200mm long

**SC-OR/26** straight

230mm long

**SC-OR/27** straight

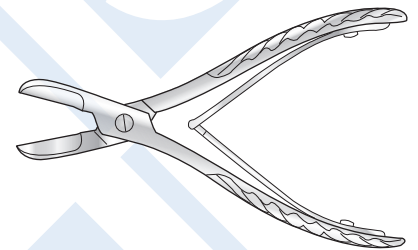

### Liston compound action bone cutting forcep

straight, for heavy duty

**SC-OR/27a** 305mm long

**SC-OR/27b** 300mm long

**SC-OR/27c** 190mm long

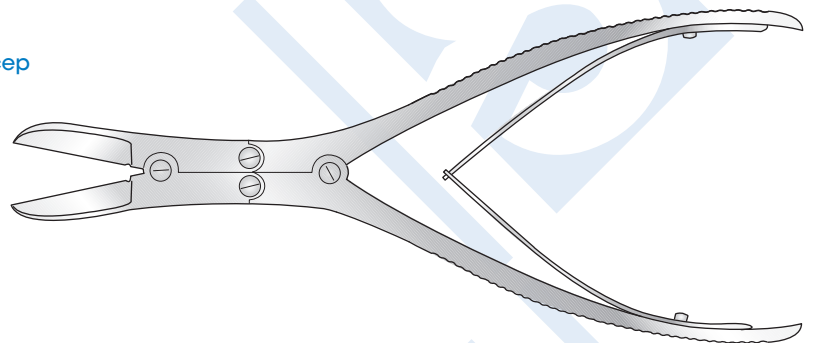

### Liston box joint bone cutting forcep

straight

**SC-OR/032** 140mm long

**SC-OR/033** 200mm long

**SC-OR/027** 220mm long

angled

**SC-OR/061** 170mm long

**SC-OR/062** 220mm long

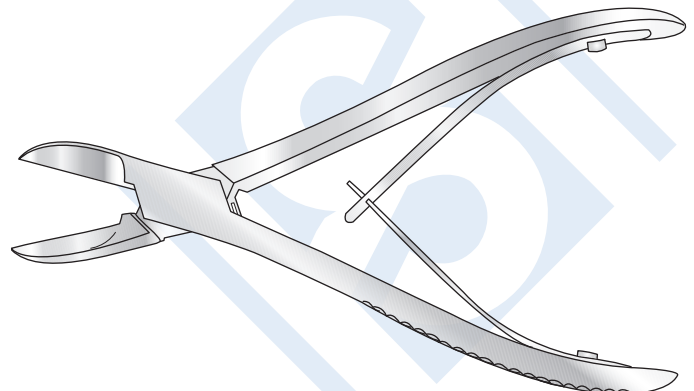

## BONE CUTTING FORCEPS

---

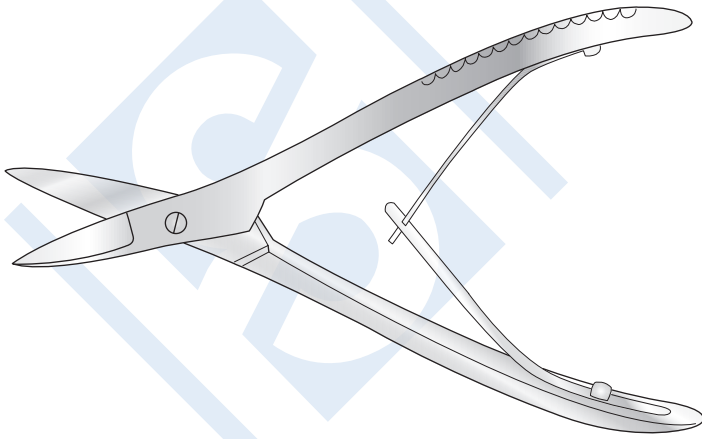

**Screw joint bone cutting forcep**

straight

**SC-OR/030** 160mm long

---

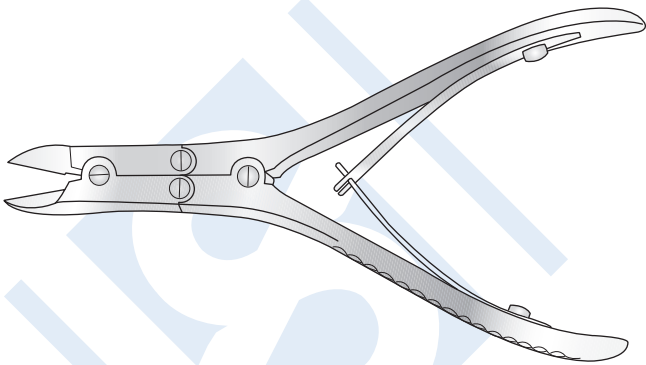

**Ruskin-Liston compound action bone cutting forcep**

fine

straight

**SC-OR/057** 140mm long

**SC-OR/074** 145mm long

**SC-OR/073** 190mm long

angled

**SC-OR/063** 190mm long

---

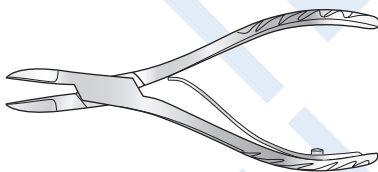

**Stamms box joint bone cutter**

standard,  
stainless steel

**SC-OR/N056** 140mm long

---

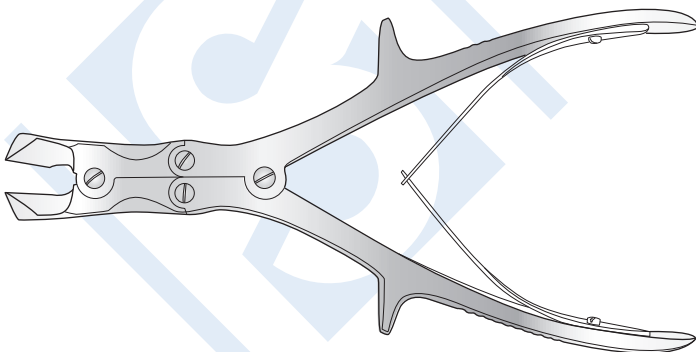

**Horsley compound action bone cutter**

**SC-OR/002** 235mm long

**BONE RONGEURS**

**Echlin compound action bone rongeur**

straight, with or without horn  
230mm long

**SC-OR/005** width 2mm

**SC-OR/006** width 3mm

**SC-OR/007** width 4mm

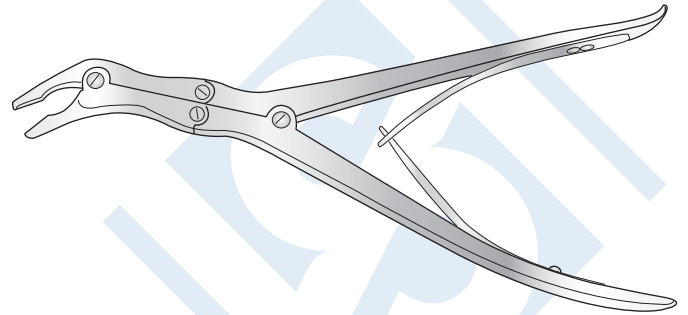
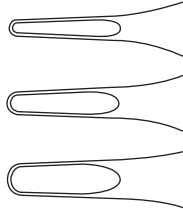

**Leksell compound action bone rongeur**

250mm long

**SC-OR/066** 3mm bite

**SC-OR/069** 5mm bite

**SC-OR/065** 8mm bite

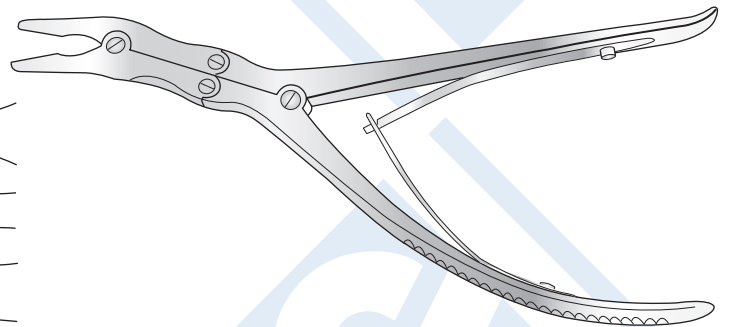
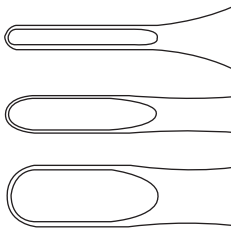

**Leksell compound action bone rongeur**

**SC-OR/008** width 3mm  
240mm long

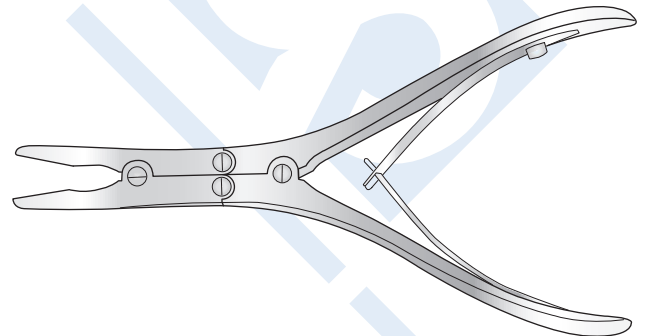

**Stille compound action bone rongeur**

angled to side

**SC-OR/037** 11mm bite,  
240mm long

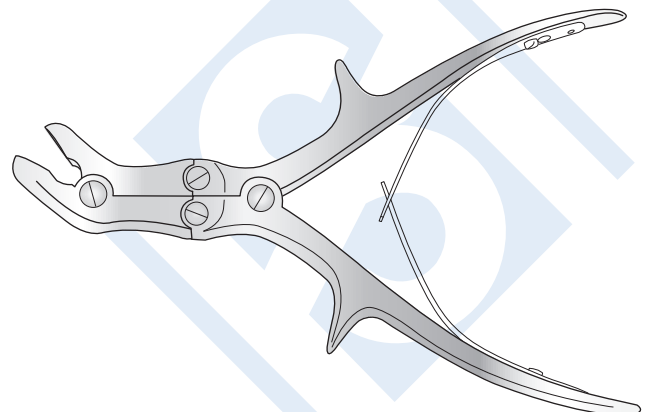

## BONE RONGEURS

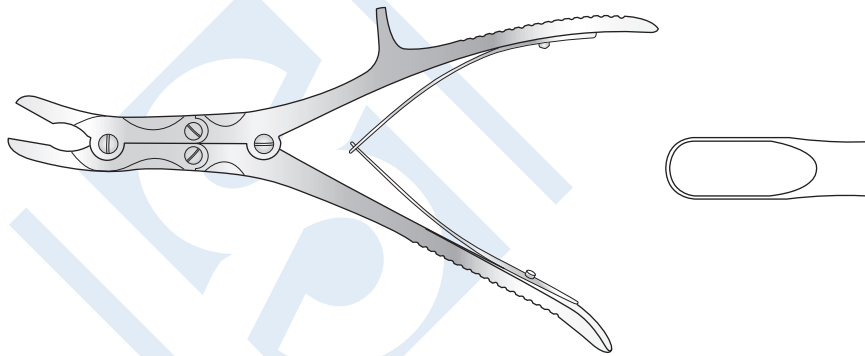

Leksell Stille compound action bone rongeur

**SC-OR/065a** 8mm bite  
240mm long

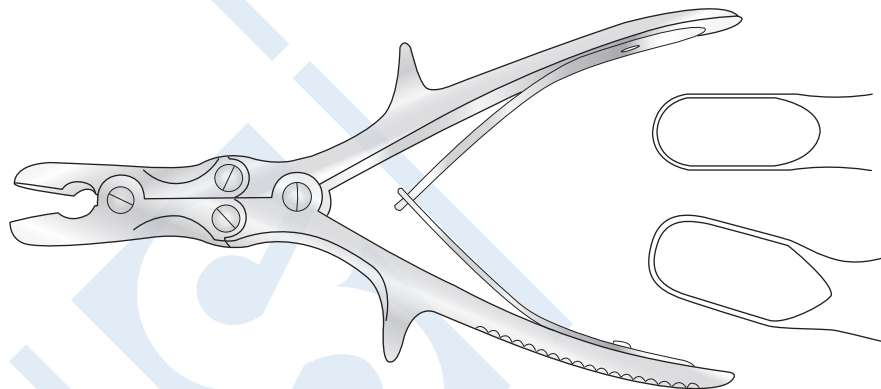

Luer Stille compound action bone rongeur

straight

**SC-OR/071** 10mm bite,  
220mm long

**SC-OR/072** 12mm bite,  
260mm long

curved

**SC-OR/071a** 10mm bite,  
220mm long

**SC-OR/071b** 11mm bite,  
230mm long

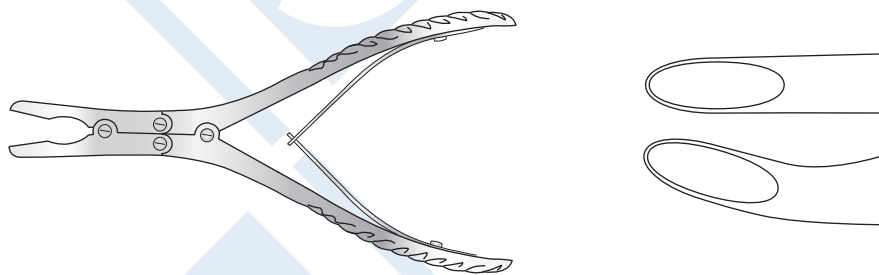

Luer compound action bone rongeur

6mm bite, 190mm long

**SC-OR/13** straight

**SC-OR/13a** curved

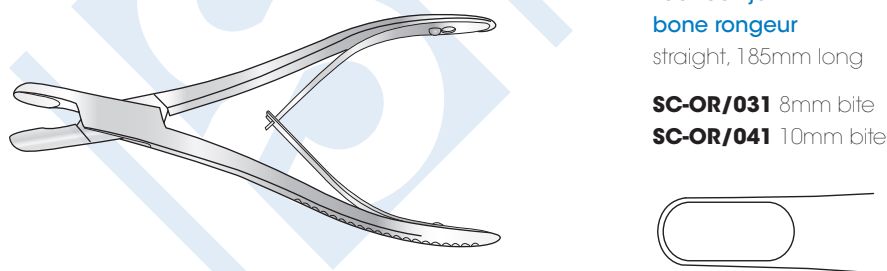

Luer box joint bone rongeur

straight, 185mm long

**SC-OR/031** 8mm bite

**SC-OR/041** 10mm bite

curved, 210mm long

**SC-OR/042** 8mm bite

**BONE RONGEURS**

**Cushing screw joint  
bone rongeur**

190mm long

straight

**SC-OR/039** 4mm bite

**SC-OR/058** 6mm bite

**SC-OR/059** 8mm bite

curved

**SC-OR/060** 4mm bite

**SC-OR/067** 6mm bite

**SC-OR/068** 8mm bite

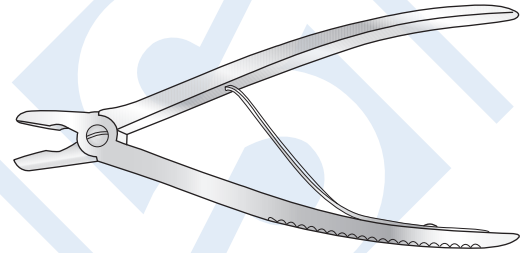
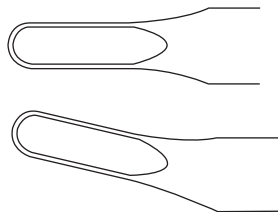

**Ruskin compound action  
bone rongeur**

3mm bite, 150mm long

**SC-OR/034** straight

**SC-OR/035** curved

4mm bite, 185mm long

**SC-OR/028** straight

**SC-OR/036** curved

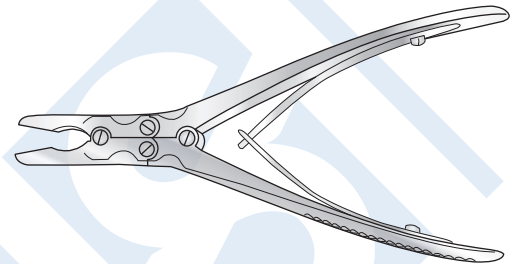
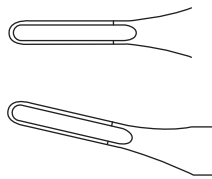

**Compound action  
bone rongeur**

lightweight pattern  
curved, 150mm long

**SC-OR/013d** 4mm bite

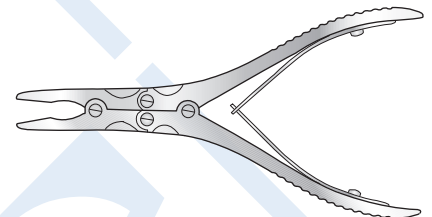

**Lempert box joint  
bone rongeur**

3mm bite, 155mm long

**SC-OR/327** straight

**SC-OR/010** curved

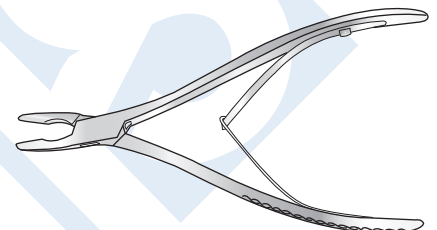
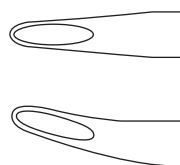

## BONE HOLDING FORCEPS

---

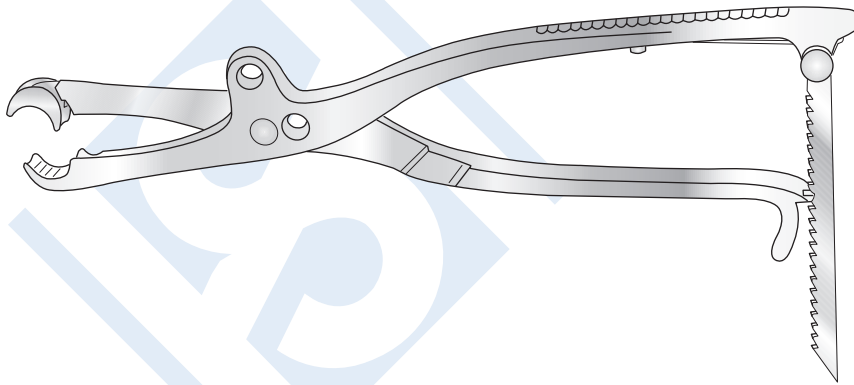

Lambotte  
bone holding forceps

**SC-OR/015** 265mm long

---

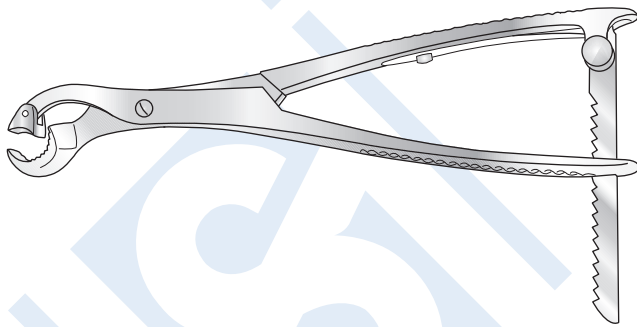

Lambotte  
bone holding forceps

**SC-OR/016** 220mm long

**SC-OR/017** 215mm long

**SC-OR/022** 330mm long

---

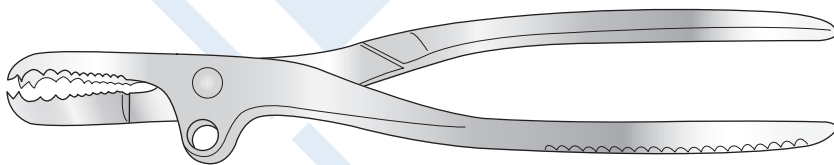

Farabeuf  
bone holding forceps

**SC-OR/021** 230mm long

**SC-OR/328** 250mm long

---

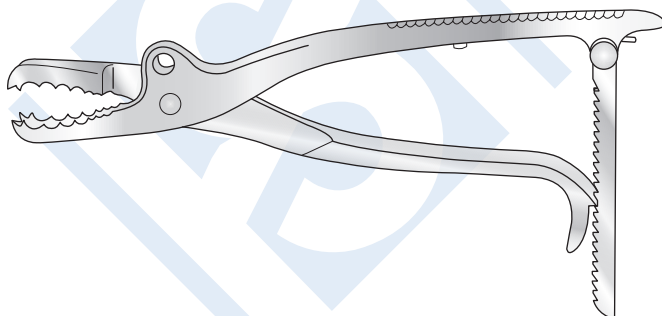

Farabeuf-Lambotte  
bone holding forceps

**SC-OR/30e** 195mm long

**SC-OR/055** 250mm long

**SC-OR/30f** 260mm long



## BONE HOLDING FORCEPS

### Bone holding forceps

screw joint,  
with holding screw

**SC-OR/029** 165mm long

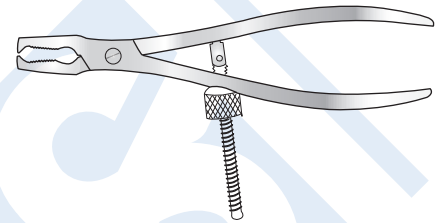

### Hey Groves bone holding forceps

with screw locking device

**SC-OR/29d** 200mm long

**SC-OR/29e** 225mm long

**SC-OR/29f** 305mm long

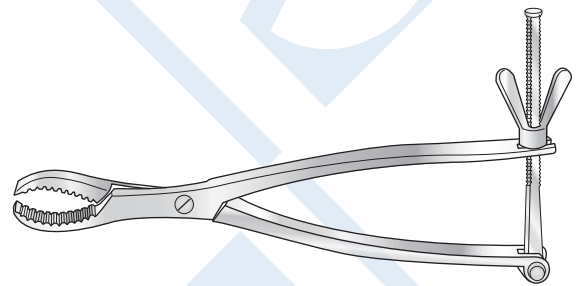

### Bone holding forceps

**SC-OR/13** 140mm long

**SC-OR/014** 185mm long

**SC-OR/018** 215mm long

**SC-OR/019** 275mm long

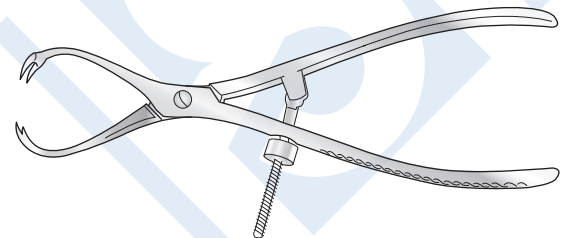

### Fergusson's bone holding forceps

**SC-OR/30** 150mm long

**SC-OR/30a** 200mm long

**SC-OR/30b** 230mm long

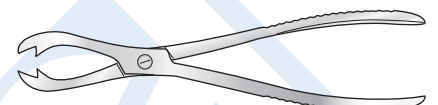

### Frosch bone holding forceps

**SC-OR/N061** 180mm long

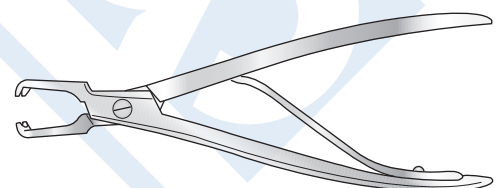

## BONE HOLDING FORCEPS

---

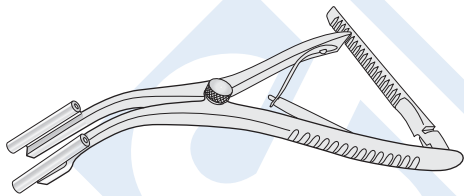

Joint calcaneal spreader

**SC-OR/CAL001** 40mm opening, 1.6mm $\varnothing$ , 170mm long

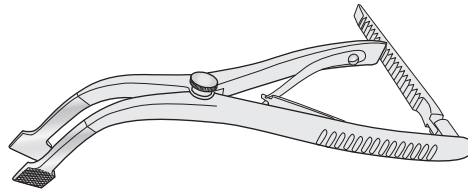

Calcaneal spreader

**SC-OR/CAL002** 40mm opening, 15mm wide tip, 70mm long

---

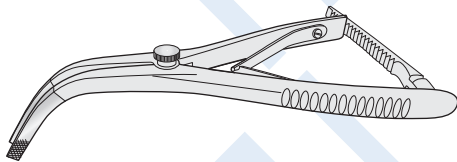

Inge type lamina spreader

**SC-OR/CAL003** 40mm opening, no teeth, 5mm wide tip, 170mm long

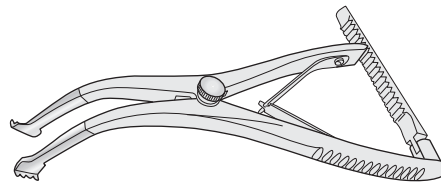

Inge type lamina spreader

**SC-OR/CAL004** baby, 40mm opening, with teeth, 10mm wide tip, 160mm long  
**SC-OR/CAL004a** 50mm opening, with teeth, 10mm wide tip, 240mm long

---



Harrison bone holding forceps

**SC-OR/30d** 190mm long

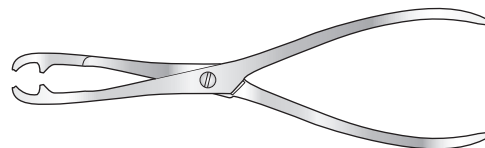

St Thomas bone holding forceps

**SC-OR/403c** 182mm long

---

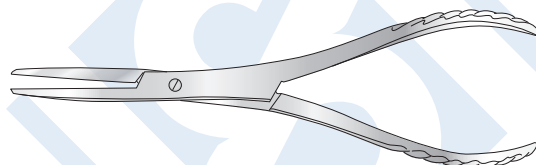

Sequestrum (Necrosis) forcep

straight, long fine jaws

**SC-OR/SEQ001** 191mm long

**SC-OR/SEQ002** 203mm long

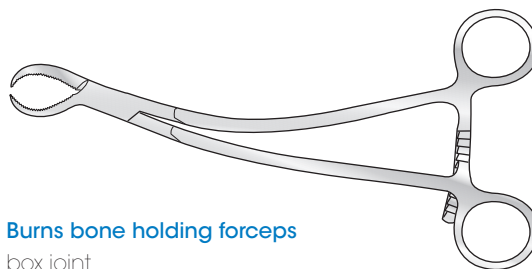

Burns bone holding forceps

box joint

**SC-OR/29a** 200mm long

**BONE HOLDING FORCEPS AND CLAMPS**

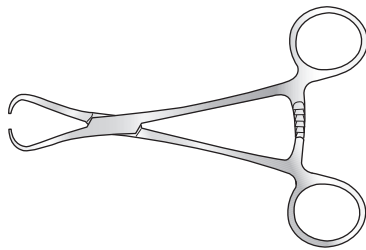

**Orthopaedic grasping forceps**  
box joint

**SC-OR/29b** 125mm long  
**SC-OR/29c** 165mm long

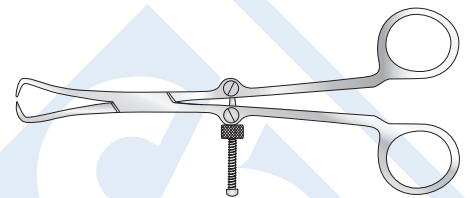

**Reduction forcep**  
with adjustable lock

**SC-OR/RED001a** small, 135mm long  
**SC-OR/RED001b** large, 168mm long

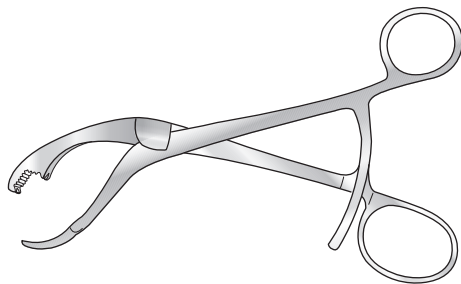

**Verbrugge bone holding forceps**

**SC-OR/30c** 180mm long

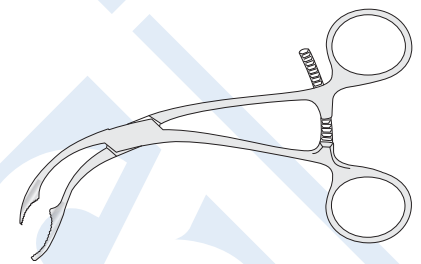

**Scarf type clamp**

**SC-OR/SCA** 150mm long

**Lowman bone holding clamp**

**SC-OR/28**

infant 125mm long  
child 175mm long  
adult 205mm long

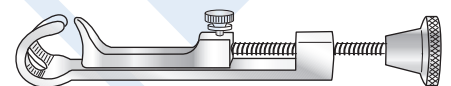

**Parker modified Lowman bone holding clamp, single**

**SC-OR/5644**

160mm long

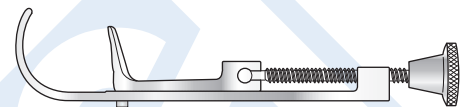

**Parker retractor**

for use with Lowman clamp

**SC-OR/5643** chain 850mm long

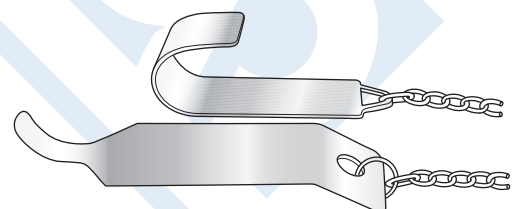

## PLASTER SPREADERS AND SHEARS

---

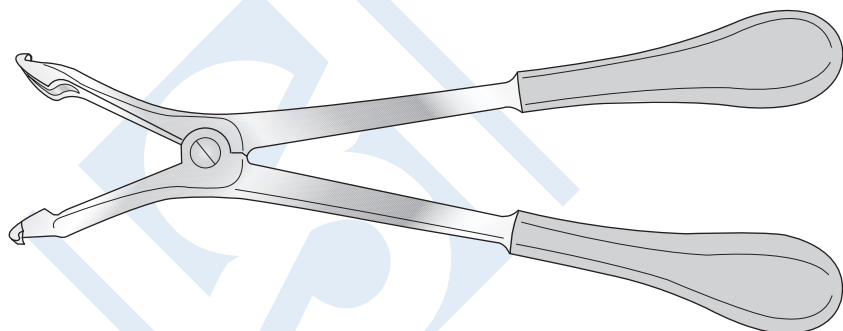

**Haglund plaster spreader**  
working part curved in right  
**SC-OR/207** 280mm long

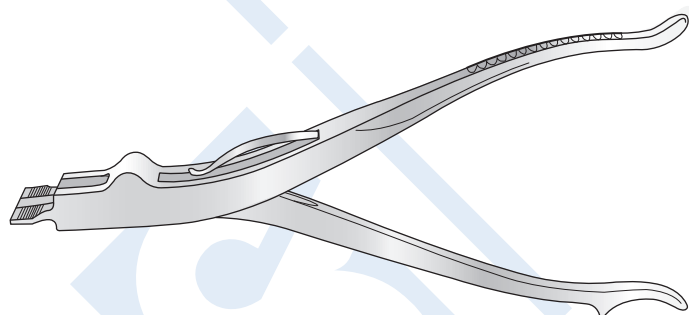

**Lawton plaster spreader**  
working part curved in right  
**SC-OR/208** 220mm long

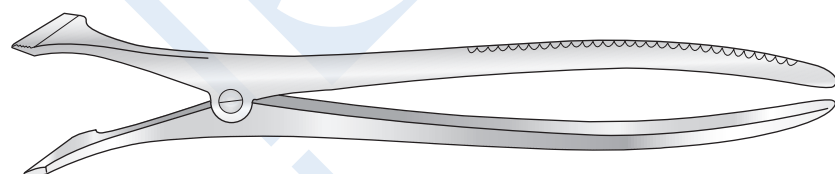

**Henning plaster spreader**  
**SC-OR/211** 270mm long

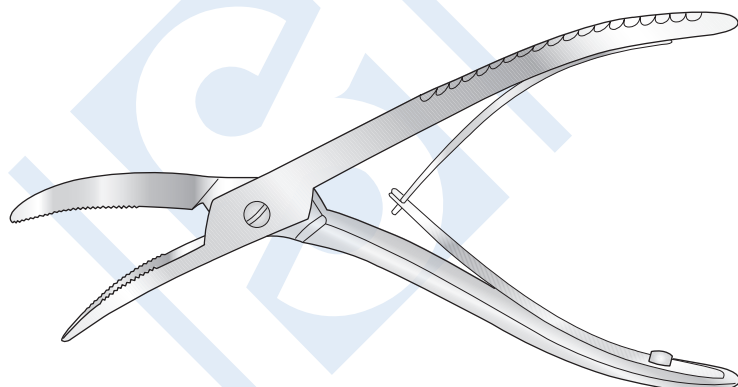

**Wolf plaster spreader**  
**SC-OR/212** 180mm long  
**SC-OR/329** 250mm long

**PLASTER SHEARS**

**Stille type  
plaster shears**

- SC-OR/210** 380mm long
- SC-OR/210a** 330mm long
- SC-OR/210b** 460mm long

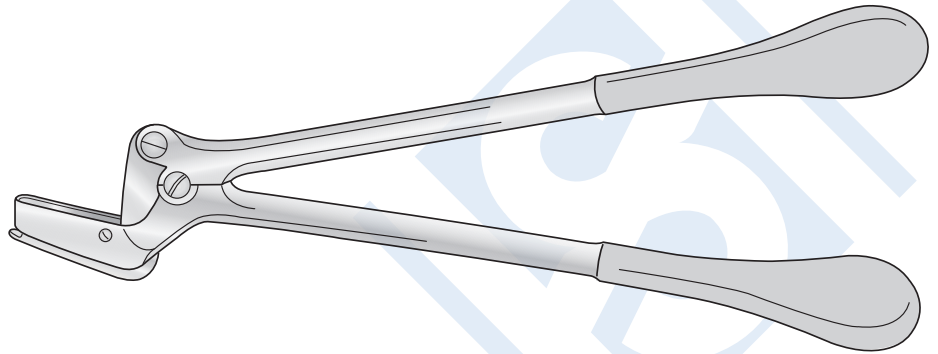

**Plaster cutter**

- SC-OR/40** 240mm long

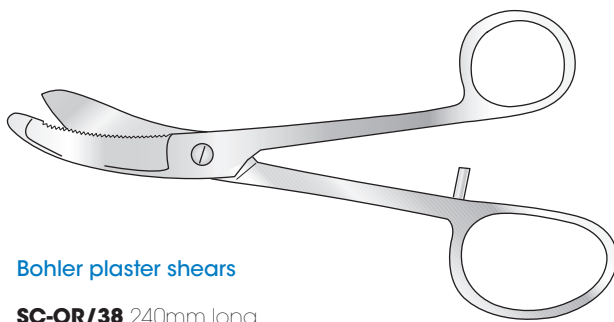
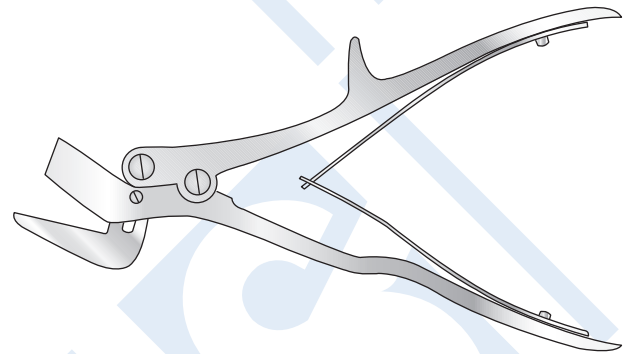

**Bohler plaster shears**

- SC-OR/38** 240mm long

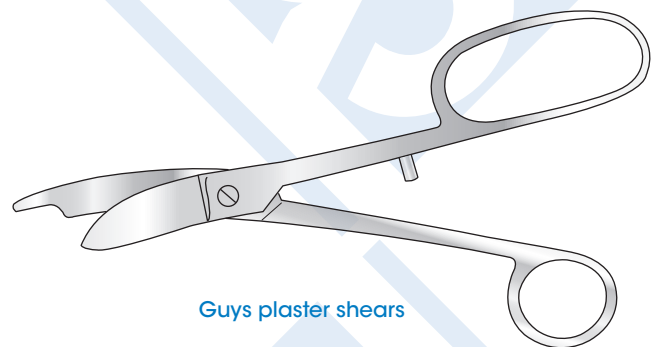

**Guys plaster shears**

- SC-OR/39** 240mm long

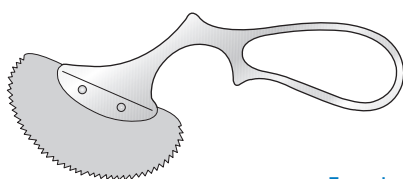

**Engel plaster saw**

- SC-OR/40b** 150mm long

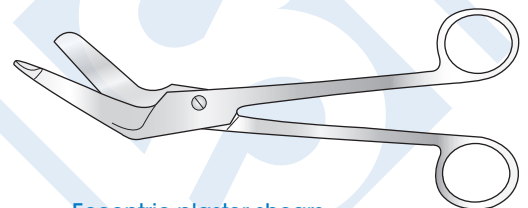

**Eccentric plaster shears**

without heavy serrated blade

- SC-OR/40a** 190mm long

## BONE CURETTES

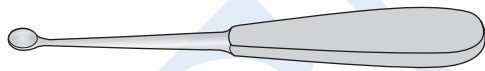

### Bone curette

straight, 180mm long

**SC-OR/075** width 2mm

**SC-OR/076** width 4mm

**SC-OR/077** width 6mm

**SC-OR/078** width 8mm

**SC-OR/079** width 10mm

**SC-OR/080** width 12mm

**SC-OR/081** width 14mm

**SC-OR/082** width 16mm

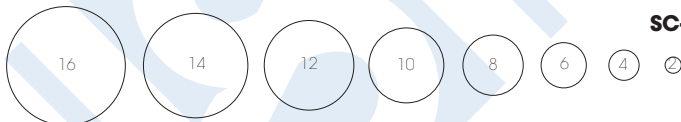

### Bone curette

straight, 260mm long

**SC-OR/083** width 2mm

**SC-OR/084** width 4mm

**SC-OR/085** width 6mm

**SC-OR/086** width 8mm

**SC-OR/087** width 10mm

**SC-OR/088** width 12mm

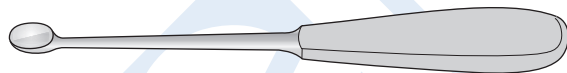
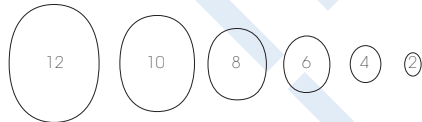

### Bone curette

straight, 210mm long

**SC-OR/089** width 2mm

**SC-OR/090** width 4mm

**SC-OR/091** width 6mm

**SC-OR/092** width 8mm

**SC-OR/093** width 10mm

**SC-OR/094** width 12mm

**SC-OR/095** width 14mm

**SC-OR/096** width 16mm

**SC-OR/097** width 20mm

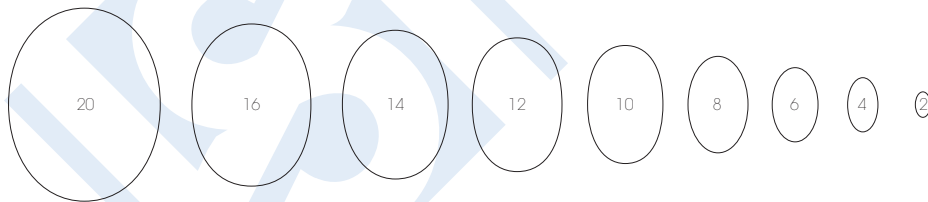

### Busche bone curette

angled, 250mm long

**SC-OR/138** width 3mm

**SC-OR/139** width 4mm

**SC-OR/140** width 5mm

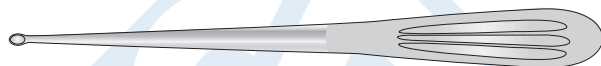

### Bruns bone curette

225mm long

straight

**SC-OR/189** width 3mm

**SC-OR/190** width 4mm

**SC-OR/191** width 5mm

**SC-OR/192** width 6mm

**SC-OR/193** width 7mm

**SC-OR/194** width 8mm

angled

**SC-OR/195** width 3mm

**SC-OR/196** width 4mm

**SC-OR/197** width 5mm

**SC-OR/198** width 6mm

**SC-OR/199** width 7mm

**SC-OR/200** width 8mm



**BONE CURETTES**

**Gourdet bone curette**

straight, blunt  
280mm long

- SC-OR/157** width 6mm
- SC-OR/158** width 8mm
- SC-OR/159** width 10mm
- SC-OR/160** width 12mm
- SC-OR/161** width 14mm

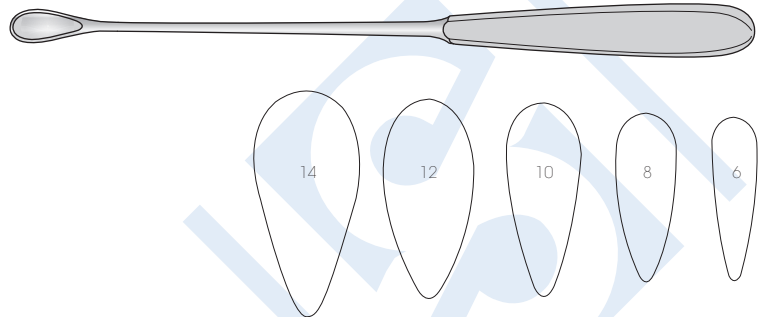

**Shroeder bone curette**

straight, 310mm long

- SC-OR/151** width 6mm
- SC-OR/152** width 8mm
- SC-OR/153** width 10mm
- SC-OR/154** width 12mm
- SC-OR/155** width 14mm

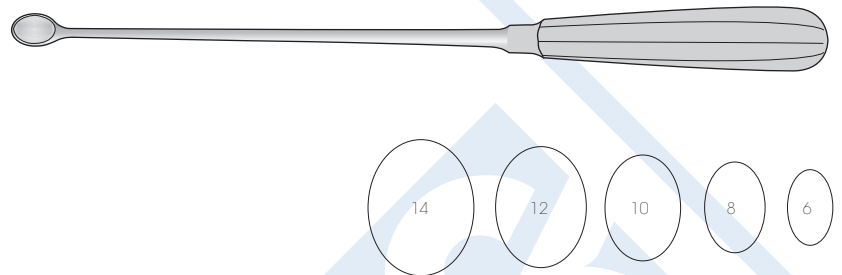

**Simon bone curette**

straight, 240mm long

- SC-OR/145** width 6mm
- SC-OR/146** width 8mm
- SC-OR/147** width 10mm
- SC-OR/148** width 12mm
- SC-OR/149** width 14mm

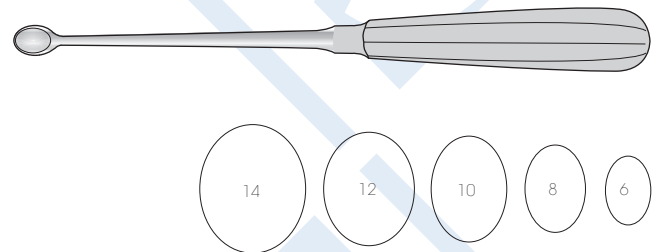

**Spinal curette**

oval, 205mm long

- |                             |                              |
|-----------------------------|------------------------------|
| <b>SC-OR/031a</b> width 4mm | <b>SC-OR/031e</b> width 8mm  |
| <b>SC-OR/031b</b> width 5mm | <b>SC-OR/031f</b> width 9mm  |
| <b>SC-OR/031c</b> width 6mm | <b>SC-OR/031g</b> width 10mm |
| <b>SC-OR/031d</b> width 7mm | <b>SC-OR/031h</b> width 11mm |

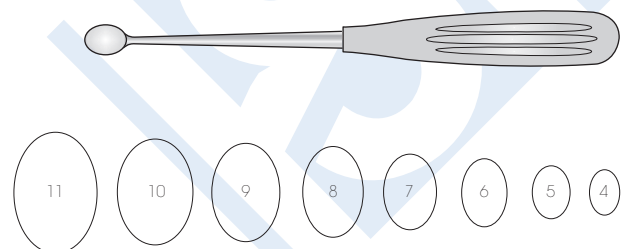

## BONE CURETTES

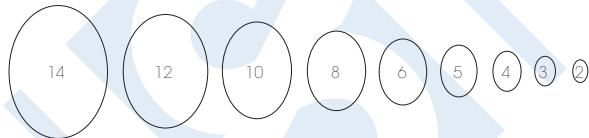
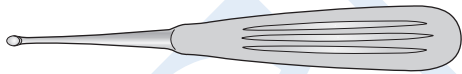

### Volkmann bone curette

straight, 170mm long

**SC-OR/112** width 2mm

**SC-OR/113** width 3mm

**SC-OR/114** width 4mm

**SC-OR/115** width 5mm

**SC-OR/116** width 6mm

**SC-OR/117** width 8mm

**SC-OR/118** width 10mm

**SC-OR/119** width 12mm

**SC-OR/120** width 14mm

### Volkmann bone curette

straight, 230mm long

**SC-OR/SH.5687**

bowl width 10mm

bowl length 14.5mm



### Wallich bone curette

blunt

**SC-OR/162** 420mm long



### Williger bone curette

straight, 170mm long

**SC-OR/122** width 3.5mm

**SC-OR/123** width 5.5mm



### Charnley bone curette

with T handle,

380mm long

**SC-OR/N040**

large, 20 x 14mm

**SC-OR/N041**

medium, 17 x 12mm

**SC-OR/N042**

small, 11 x 8mm



**BONE CURETTES**

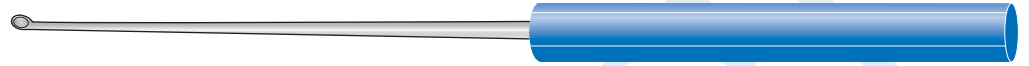

**Syvert bone curette**

Blue acetal "Suregrip" handle \*, 380mm long

straight

**SC-OR/236** width 3mm

**SC-OR/237** width 4mm

**SC-OR/238** width 5mm



angled

**SC-OR/240** width 3mm

**SC-OR/241** width 4mm

**SC-OR/245** width 5mm



**Bone curette**

Blue acetal "Suregrip" handle \*, 410mm long.

straight

**SC-OR/249** width 3mm

**SC-OR/250** width 4mm

**SC-OR/251** width 5mm

angled

**SC-OR/252** width 3mm

**SC-OR/253** width 4mm

**SC-OR/254** width 5mm



**Caspar bone curette**

Blue acetal "Suregrip" handle \*, 220mm long.

straight

**SC-OR/230** width 3.5mm

**SC-OR/231** width 4.5mm

**SC-OR/232** width 5.5mm

angled

**SC-OR/233** width 3.5mm

**SC-OR/234** width 4.5mm

**SC-OR/235** width 5.5mm



**Bone curette**

Blue acetal "Suregrip" handle \*, 270mm long, straight.

**SC-OR/226** width 4mm

**SC-OR/227** width 6mm

**SC-OR/228** width 8mm

**SC-OR/229** width 10mm

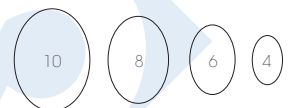

\* ALSO AVAILABLE WITH TUFNOL HANDLE

## BONE CURETTES

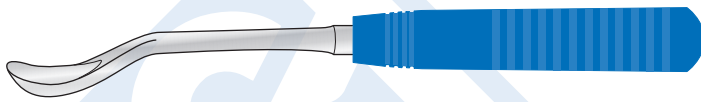

### Capener spoon

Blue acetal "Suregrip" handle\* 285mm long.

**SC-OR/389a** width 16mm

**SC-OR/389b** width 20mm

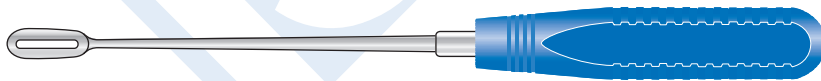

### Capener lamina curette

Blue acetal "Suregrip" handle\* 300mm long.

**SC-OR/389c** 12 x 32mm



### Capener lamina curette

Blue acetal "Suregrip" handle\* 300mm long.

**SC-OR/389d** 6 x 18mm

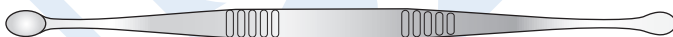

### Stanley Boyd curette

double ended



**SC-OR/SH-5313** small 1 50mm long

**SC-OR/SH-5313a** medium 200mm long

**SC-OR/SH-5314** large 250mm long



### Volkmann bone scoop

double-ended, straight

**SC-OR/31** 175mm long

**SC-OR/213** 220mm long

**SC-OR/175** 220mm long



### Martini bone curette

SHOWN AT HALF SIZE  
double-ended, straight 140mm long

**SC-OR/170** small and medium

**SC-OR/171** medium and large

\* ALSO AVAILABLE WITH TUFNOL HANDLE

**BONE LEVERS**

**Lanes bone lever**

240mm long

6mm

**SC-OR/N011** slight curve

**SC-OR/N012** full curve

8mm

**SC-OR/N013** slight curve

**SC-OR/N014** full curve



**Lanes bone lever**

for small bones

**SC-OR/N015** 10mm wide

265mm long



**Lanes bone lever**

for small bones, serrated end

**SC-OR/N016** 10mm wide

260mm long

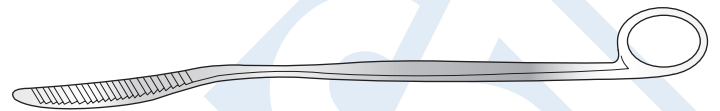

**Trethowan bone lever**

ring handle

**SC-OR/N017** 220mm long



**Watson-Jones bone lever**

**SC-OR/N054** 275mm long

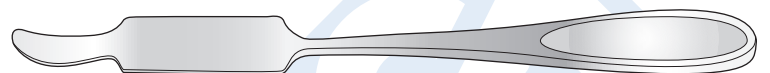

**Bankhart bone lever**

**SC-OR/SH.5315** 300mm long



## RETRACTORS

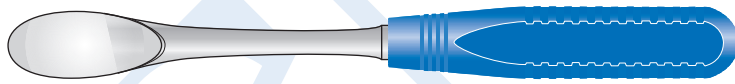

a

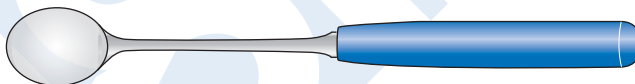

b



c

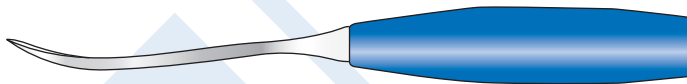

d



e

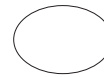
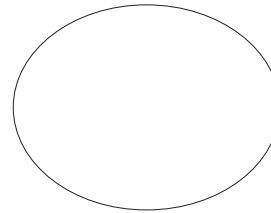
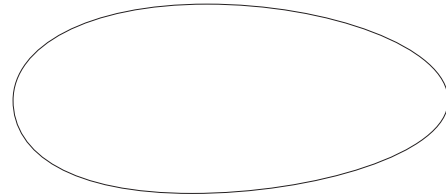

Bunch of 5's

**SC-OR/N059**

Blue acetal "Suregrip" handle \*

- a 1 x 25mm large Spoon Elevator
- b 1 x 27mm large Curette
- c 1 x 9mm small Curette
- d 1 x 20mm Curved Osteotome
- e 1 x 8mm small Gouge, cranked

\* ALSO AVAILABLE WITH TUFNOL HANDLE

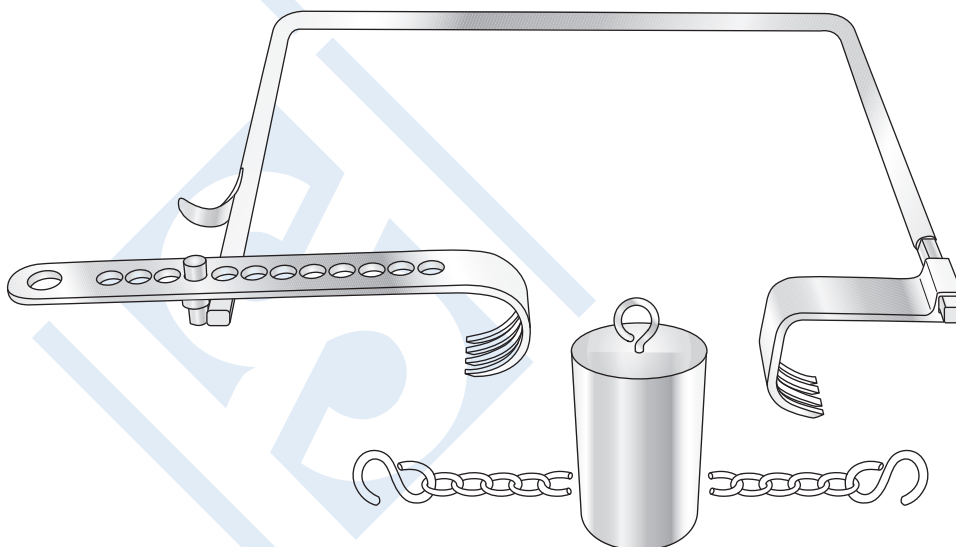

**Charnley initial incision retractor**

**SC-OR/N038a**

frame only

**SC-OR/N038b**

weight only, 75mm x 50ø

**SC-OR/N038c**

short blade, 50mm deep

**SC-OR/N038d**

long blade, 50mm deep

**SC-OR/N038e**

short blade, 75mm deep

**SC-OR/N038f**

long blade, 75mm deep

**SC-OR/N038g**

short blade, 100mm deep

**SC-OR/N038h**

long blade, 100mm deep

**RETRACTORS**

**Travers retractor**

self retaining, internal rack, 210mm long

**SC-GI/323** 4 x 5 teeth,  
95mm fully open

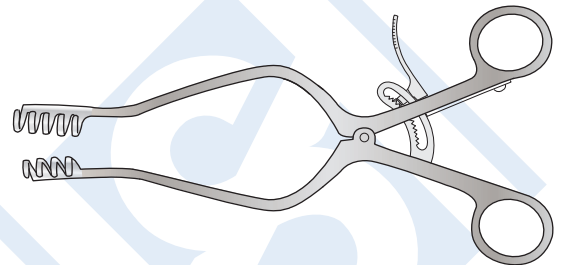

**West retractor**

self retaining, 140mm long

**SC-GI/326** 3 x 4 teeth, 60mm fully open  
**SC-GI/326cr** 3 x 4 teeth, 60mm fully open, with cam rack

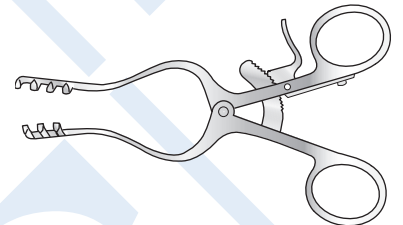

**Norfolk and Norwich retractor**

self retaining, with internal rack,  
4 x 5 teeth, 51mm blades,  
216mm long

**SC-GI/325** 4 x 5 teeth,  
51mm blades

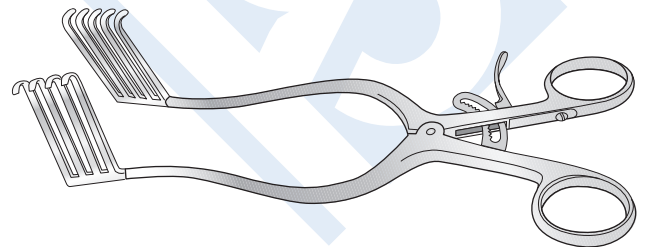

**Jackson Burrows retractor**

self-retaining

**SC-GI/377** 175mm

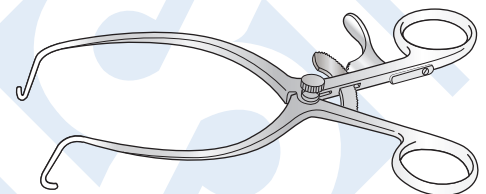

## RETRACTORS, HOOKS

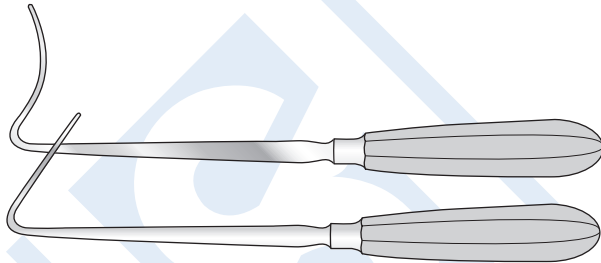

### Jackson Burrows hand retractor

225mm long

**SC-OR/N050** narrow curve, 13mm blade

**SC-OR/N050a** broad, angular, 20mm blade

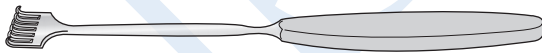

### Ballance (Volkman) retractor 203mm long

sharp

**SC-GI/463** 1 prong

**SC-GI/463a** 2 prong

**SC-GI/463b** 3 prong

**SC-GI/463c** 4 prong

**SC-GI/463d** 6 prong

blunt

**SC-GI/463e** 1 prong

**SC-GI/463f** 2 prong

**SC-GI/463g** 3 prong

**SC-GI/463h** 4 prong

**SC-GI/463i** 6 prong

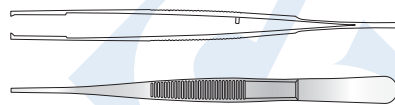

### Jackson Burrows dissecting forcep

140mm long

**SC-OR/N037** tongue and groove only

**SC-OR/N037a** tongue and groove, 1-2 teeth

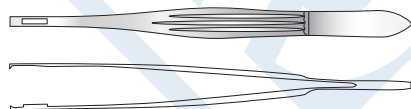

### Charnley-McIndoe dissecting forceps

150mm long

**SC-OR/N045a** 2-3 teeth

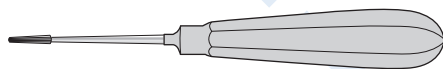

### Paton bone burr

satin handle, 155mm long

**SC-OR/403** 3.5mmø x 17mm

**SC-OR/403a** 4.5mmø x 17mm

**SC-OR/403b** 5.0mmø x 17mm



### Dislocation hook

**SC-OR/SH-5703** 253mm long

\* ALSO AVAILABLE WITH TUFNOL HANDLE

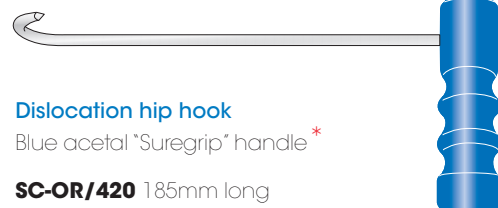

### Dislocation hip hook

Blue acetal "Suregrip" handle \*

**SC-OR/420** 185mm long

## HOOKS, RUGINES, AND RASPATORIES

### Kocher bone hook

220mm long

**SC-OR/N036** sharp  
**SC-OR/N036a** blunt

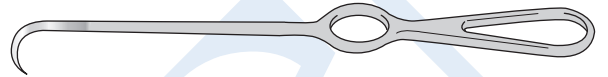

### Langenbeck bone hook

**SC-OR/391** 200mm long

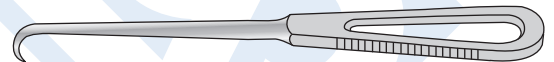

### Mitchell rugine

straight, sharp edge,  
fan shaped, hollow handle

**SC-OR/N034** 210mm long

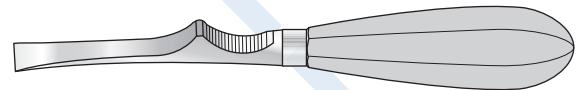

### Farabeuf rugine

curved end, chisel edge,  
hollow handle

**SC-OR/N033** 160mm long

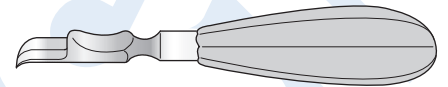

### Robert Jones rugine

convex sharp edge,  
fan shaped end,  
with solid pistol handle

**SC-OR/N035** 185mm long

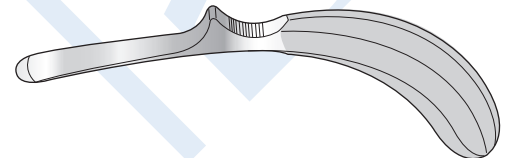

### Key raspatories

**SC-OR/310** width 6.4mm 180mm long  
**SC-OR/313** width 9.5mm 190mm long  
**SC-OR/311** width 12.7mm 190mm long  
**SC-OR/312** width 19mm 200mm long  
**SC-OR/314** width 25.4mm 210mm long

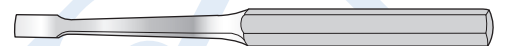

### Lambotte raspatory

205mm long

**SC-OR/242** width 10mm  
**SC-OR/243** width 15mm  
**SC-OR/244** width 20mm

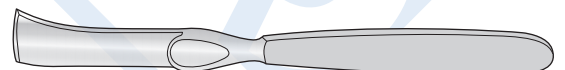

## OSTEOTOMES, CHISELS AND GOUGES



### Lexer osteotome

Blue acetal "Suregrip" handle \*, 4mm, 180mm long.

**SC-OR/SH5347a**

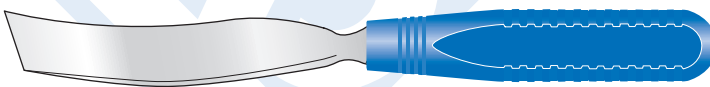

### Capener osteotome

Blue acetal "Suregrip" handle \*, 250mm long.

shallow curved

**SC-OR/384** width 6mm

**SC-OR/385** width 10mm

**SC-OR/386** width 12mm

**SC-OR/387** width 15mm

**SC-OR/388** width 20mm

**SC-OR/389** width 25mm

**SC-OR/390** width 30mm

acute curved

**SC-OR/390a** width 6mm

**SC-OR/390b** width 10mm

**SC-OR/390c** width 15mm

**SC-OR/390d** width 20mm

**SC-OR/390e** width 25mm

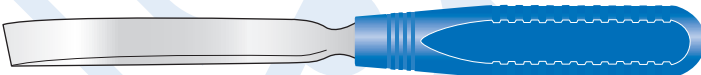

### Capener osteotome

Blue acetal "Suregrip" handle \*, straight, 255mm long.

**SC-OR/374** width 6mm

**SC-OR/375** width 8mm

**SC-OR/376** width 10mm

**SC-OR/377** width 12mm

**SC-OR/378** width 13mm

**SC-OR/379** width 15mm

**SC-OR/380** width 18mm

**SC-OR/381** width 20mm

**SC-OR/382** width 25mm

**SC-OR/383** width 30mm

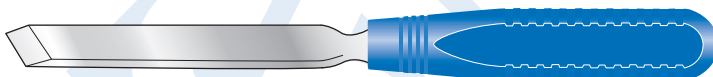

### Capener chisel

Blue acetal "Suregrip" handle \*, straight, 250mm long.

**SC-OR/368** width 6mm

**SC-OR/369** width 10mm

**SC-OR/370** width 12mm

**SC-OR/371** width 15mm

**SC-OR/372** width 20mm

**SC-OR/373** width 25mm

\* ALSO AVAILABLE WITH TUFNOL HANDLE



**OSTEOTOMES, CHISELS AND GOUGES**

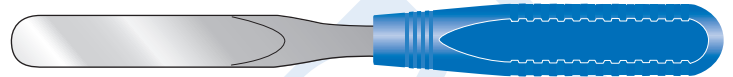

**Capener lamina gouge**

Blue acetel "Suregrip" handle, straight\*, 265mm long.

- |                             |                             |
|-----------------------------|-----------------------------|
| <b>SC-OR/362</b> width 6mm  | <b>SC-OR/365</b> width 15mm |
| <b>SC-OR/363</b> width 10mm | <b>SC-OR/366</b> width 20mm |
| <b>SC-OR/364</b> width 12mm | <b>SC-OR/367</b> width 25mm |

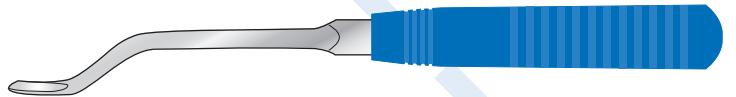

**Capener lamina gouge**

cranked, Blue acetel "Suregrip" handle\*, 250mm long.

OTHER LENGTHS AND SIZES AVAILABLE

- |                              |                                |
|------------------------------|--------------------------------|
|                              | with reversed edge             |
| <b>SC-OR/373c</b> width 6mm  | <b>SC-OR/373cre</b> width 6mm  |
| <b>SC-OR/373d</b> width 8mm  | <b>SC-OR/373dre</b> width 8mm  |
| <b>SC-OR/373j</b> width 10mm | <b>SC-OR/373jre</b> width 10mm |
| <b>SC-OR/373e</b> width 11mm | <b>SC-OR/373er</b> width 11mm  |
| <b>SC-OR/373f</b> width 16mm | <b>SC-OR/373fre</b> width 16mm |
| <b>SC-OR/373k</b> width 17mm | <b>SC-OR/373kre</b> width 17mm |

**Capener lamina gouge**

swan neck, Blue acetel "Suregrip" handle\*, 250mm long.

**SC-OR/373g** width 8mm

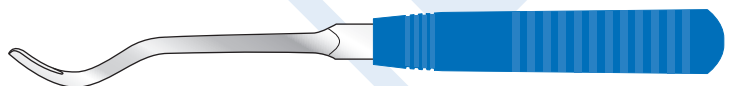

**Capener lamina gouge**

reverse cranked, Blue acetel "Suregrip" handle\*, 245mm long.

- |                               |                               |
|-------------------------------|-------------------------------|
| <b>SC-OR/3730r</b> width 6mm  | <b>SC-OR/373ar</b> width 11mm |
| <b>SC-OR/3731r</b> width 8mm  | <b>SC-OR/373nr</b> width 16mm |
| <b>SC-OR/373mr</b> width 10mm | <b>SC-OR/373jr</b> width 17mm |

\* ALSO AVAILABLE WITH TUFNOL HANDLE

## OSTEOTOMES, CHISELS AND GOUGES



### Read osteotome

serrated head  
180mm long

**SC-OR/335** width 4mm

**SC-OR/336** width 5mm



### Read gouge

serrated head, 180mm long

**SC-OR/344** width 2mm

**SC-OR/345** width 3mm

**SC-OR/346** width 4mm

**SC-OR/347** width 5mm

**SC-OR/341** width 6mm

**SC-OR/342** width 7mm

**SC-OR/343** width 8mm



### Read chisel

serrated head, 180mm long

**SC-OR/337** width 2mm

**SC-OR/338** width 3mm

**SC-OR/339** width 4mm

**SC-OR/340** width 5mm

**SC-OR/341** width 6mm

**SC-OR/342** width 7mm

**SC-OR/343** width 8mm

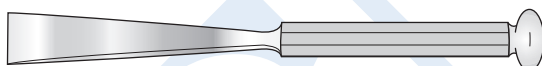

### Swedish pattern osteotome

200mm long

**SC-OR/348** width 10mm

**SC-OR/349** width 15mm

**SC-OR/350** width 20mm

**SC-OR/351** width 25mm

**SC-OR/352** width 30mm

with tungsten carbide edge

**SC-OR/348tc** width 10mm

**SC-OR/349tc** width 15mm

**SC-OR/350tc** width 20mm

**SC-OR/351tc** width 25mm

**SC-OR/352tc** width 30mm

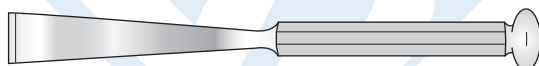

### Swedish pattern chisel

200mm long

**SC-OR/353** width 10mm

**SC-OR/354** width 15mm

**SC-OR/355** width 20mm

**SC-OR/356** width 25mm

**SC-OR/357** width 30mm

with tungsten carbide edge

**SC-OR/355tc** width 20mm

**SC-OR/356tc** width 25mm

**SC-OR/357tc** width 30mm

**SC-OR/356tc** width 25mm

**SC-OR/357tc** width 30mm

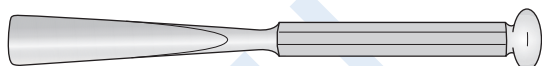

### Swedish pattern gouge

200mm long

**SC-OR/358** width 10mm

**SC-OR/359** width 15mm

**SC-OR/360** width 20mm

**SC-OR/361** width 25mm

with tungsten carbide edge

**SC-OR/358tc** width 10mm

**SC-OR/359tc** width 15mm

**SC-OR/360tc** width 20mm

**SC-OR/361tc** width 25mm



### Lambotte osteotome

230mm long

straight

**SC-OR/392** 2mm wide

**SC-OR/392a** 4mm wide

**SC-OR/392b** 7mm wide

**SC-OR/392c** 15mm wide

**SC-OR/392d** 20mm wide

**SC-OR/392e** 25mm wide

**SC-OR/392f** 30mm wide

**SC-OR/392g** 38mm wide

**SC-OR/392h** 44mm wide

**SC-OR/392i** 50mm wide

curved

**SC-OR/392j** 15mm wide

**SC-OR/392k** 20mm wide

**SC-OR/392m** 25mm wide

**SC-OR/392n** 30mm wide

**SC-OR/392o** 38mm wide

**SC-OR/392p** 40mm wide

**SC-OR/392q** 44mm wide

**SC-OR/392r** 50mm wide

## OSTEOTOMES, CHISELS AND GOUGES

**Albee osteotome**  
190mm long

**SC-OR/NO62a** width 38mm  
**SC-OR/NO62b** width 50mm

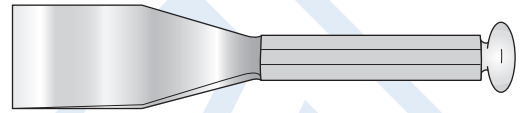

**Moore hollow osteotome**  
rectangular, for curved standard stems

**SC-OR/N008** 135mm long  
**SC-OR/N008a** 255mm long



**Small osteotomes**  
150mm long

**SC-OR/14-4** 4mm wide  
**SC-OR/14-6** 6mm wide  
**SC-OR/14-8** 8mm wide



**Small chisels**  
150mm long

**SC-OR/18-4** 4mm wide  
**SC-OR/18-4** 6mm wide  
**SC-OR/18-4** 8mm wide

**Small gouges**  
150mm long

**SC-OR/16-4** 4mm wide  
**SC-OR/16-6** 6mm wide  
**SC-OR/16-8** 8mm wide

**Box chisel**

Blue acetal "Suregrip" handle\*,  
285mm long

**SC-OR/N008b**



\* ALSO AVAILABLE WITH TUFNOL HANDLE

**Alexander gouge**

straight, 170mm long

**SC-OR/290** width 5mm  
**SC-OR/291** width 7mm

**SC-OR/292** width 9mm  
**SC-OR/293** width 11mm



**Partsch gouge**

straight

140mm long

**SC-OR/283** width 3mm  
**SC-OR/284** width 4mm  
**SC-OR/285** width 5mm  
**SC-OR/286** width 6mm

170mm long

**SC-OR/294** width 3mm  
**SC-OR/287** width 4mm  
**SC-OR/295** width 5mm  
**SC-OR/288** width 6mm  
**SC-OR/289** width 7mm



## WIRE CUTTERS

---

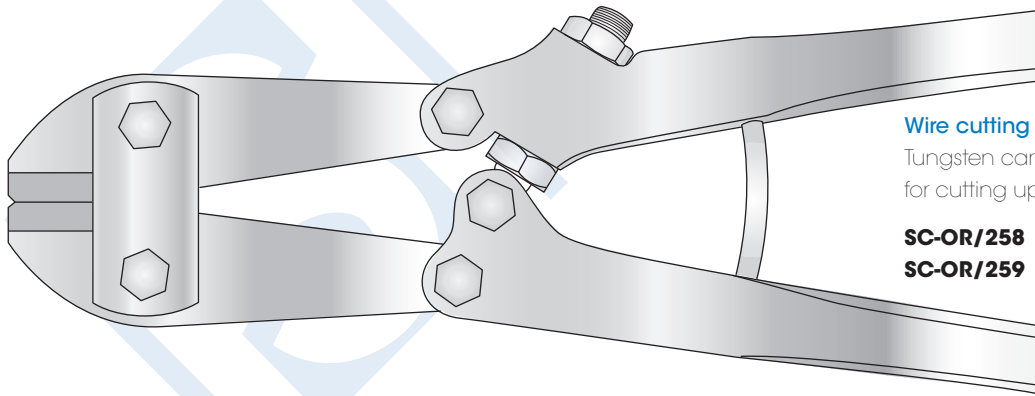

### Wire cutting pliers

Tungsten carbide edge,  
for cutting up to and including 6mm  $\varnothing$

**SC-OR/258** 450mm long

**SC-OR/259** 560mm long

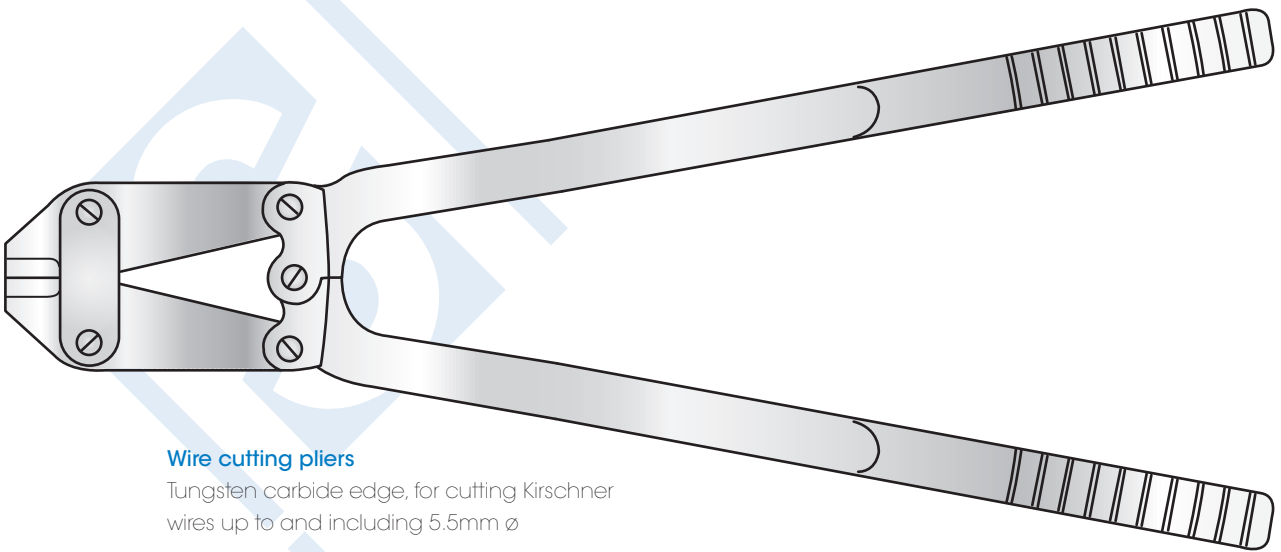

### Wire cutting pliers

Tungsten carbide edge, for cutting Kirschner  
wires up to and including 5.5mm  $\varnothing$

**SC-OR/07a** 480mm long

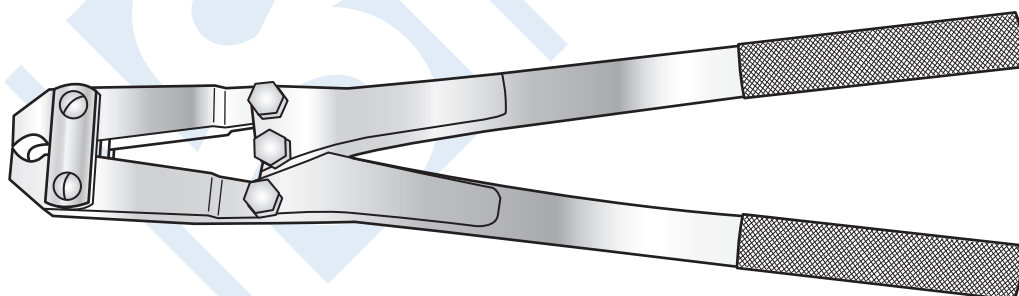

### Wire cutting pliers

Tungsten carbide edge,  
for cutting Kirschner  
wires up to 4mm  $\varnothing$

**SC-OR/261**

380mm long

**WIRE CUTTERS**

**Top cutter**

gold handles, Tungsten carbide edge,  
for cutting kirschner wire

**SC-OR/06** up to 2.5mm, 215mm long

**SC-OR/06a** up to 1.5mm, 145mm long

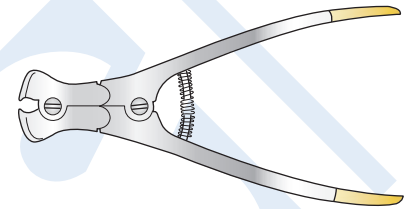

**Top and side cutter**

small, gold handles, Tungsten carbide edge,  
for cutting Kirschner wires up to 1.5mmØ

**SC-OR/06b** 175mm long

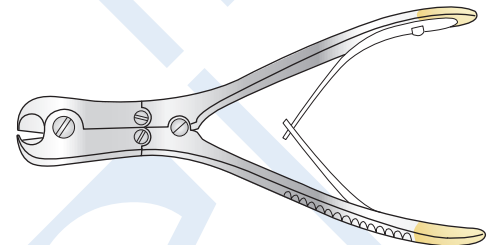

**Side cutter**

compound action, angled Tungsten carbide jaw,  
gold handles, for Kirschner wire up to 1.6mmØ

**SC-OR/N060** 180mm long

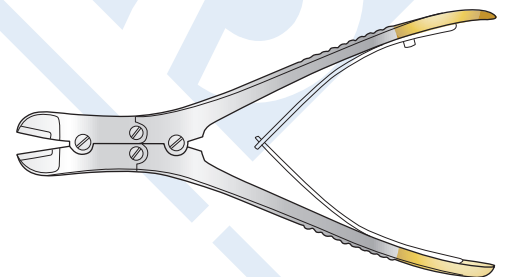

**Side cutter**

gold handles, Tungsten carbide edge,  
for cutting Kirschner wires up to 1.5mm Ø.

**SC-OR/260** 170mm long

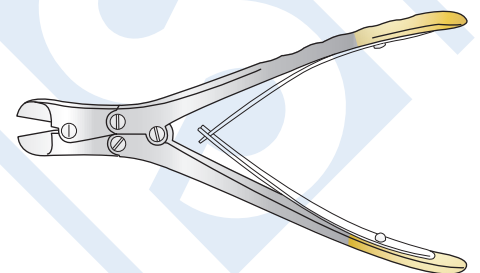

## WIRE CUTTERS AND PLIERS

---

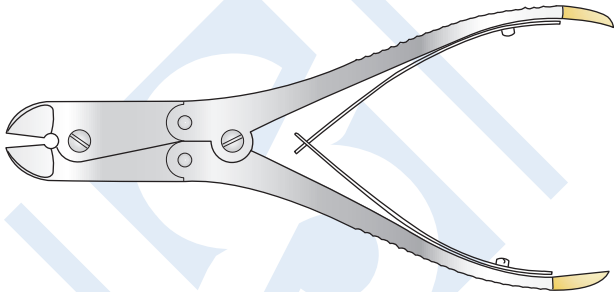

### Side cutter

gold handles, Tungsten carbide edge, jaws have rounded edges, for cutting Kirschner wires

**SC-OR/331** up to 2.5mm $\varnothing$ , 230mm long

**SC-OR/332** up to 2.2mm $\varnothing$ , 215mm long

**SC-OR/333** up to 1.5mm $\varnothing$  145mm long

---

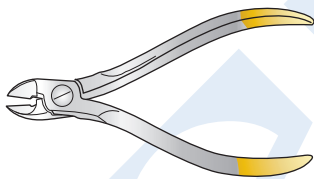

### Wire cutting pliers

gold handles, Tungsten carbide edge, 120mm long

**SC-OR/263** for wire up to 0.2mm  $\varnothing$

**SC-OR/267** for wire up to 0.3mm  $\varnothing$

**SC-OR/262** for wire up to 0.5mm  $\varnothing$

**SC-OR/269** for wire up to 0.5mm  $\varnothing$  115mm long

**SC-OR/268** for wire up to 0.7mm  $\varnothing$

---

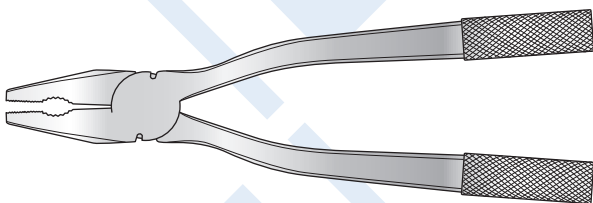

### Orthopaedic plier/cutter

stainless steel

**SC-OR/271b** 180mm long

**SC-OR/271c** 220mm long

---

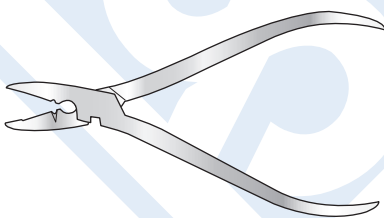

### Bone plate bender/ wire cutter pliers

for nipping and breaking off soft wire only.  
Not suitable for K wires

**SC-OR/32a** 150mm long

## WIRE CUTTERS AND PLIERS

**Pliers for wire** 175mm long

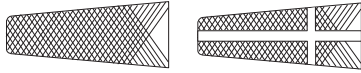

**SC-OR/273**

**SC-OR/275**

**Pliers for bone burrs** 190mm long

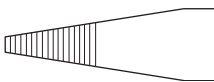

**SC-OR/274**

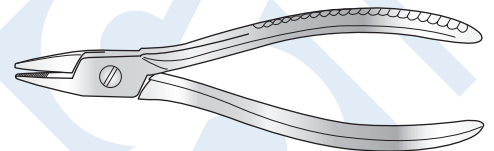

**Orthopaedic plier/cutter**

stainless steel, Tungsten carbide edge,  
for cutting kirshner wire up to 1.6mm

**SC-OR/271a** TC 180mm long

**SC-OR/271b** non TC for cutting soft wire only, max cut 1.6mm, 180mm long

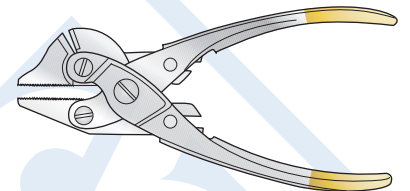

**Mole grip type wrench**

stainless steel

**SC-OR/N052** 190mm long

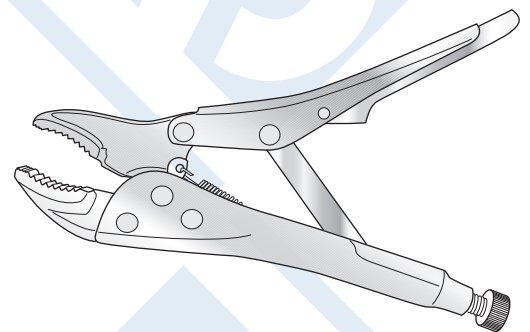

**Orthopaedic pliers**

**SC-OR/49b** 185mm

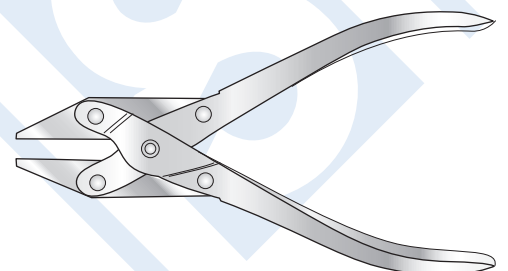

## ACCESSORIES

---



**Wire twister** biomet type

**SC-OR/49a** 150mm long

---

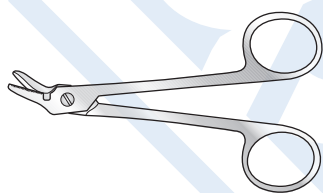

**Suture wire cutting scissors**

angled to cut soft wire only, max cut 1.2mm

**SC-OR/07b** 120mm long

---



**Suture wire cutting scissors**

**SC-OR/07c** 110mm long

---

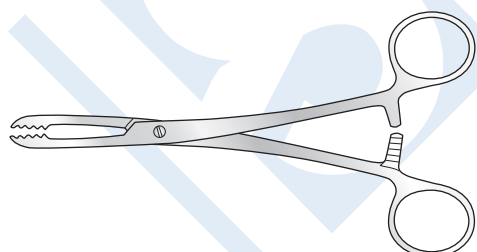

**Martin cartilage forceps**

**SC-OR/393** 180mm long

---



**Charnley suture forcep**

slotted, 1-2 teeth

**SC-OR/N045** 180mm long

---

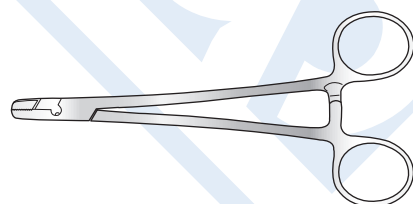

**Wire twister and cutter**

to cut soft wire only, max cut 1.6mm

**SC-OR/49** 150mm long



**MALLETS**

**Mallet**

with serrated head, 170mm long

**SC-OR/023** 190 grams

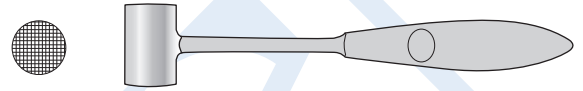

**Mallet**

Blue acetal "Suregrip" handle  
275mm long

**SC-OR/270A-BH**

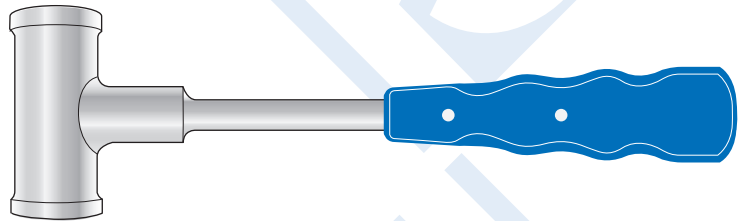

**Mallet**

stainless steel, 270mm long

**SC-OR/270** 640 grams

**SC-OR/271** 1020 grams

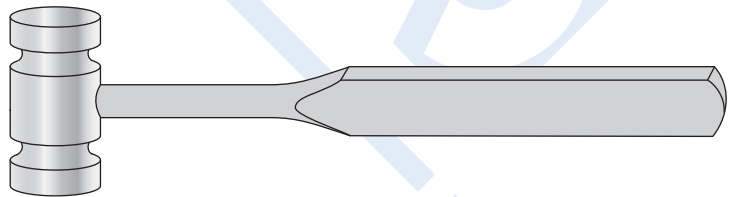

**Mallet**

stainless steel, with pistol grip  
240mm long

**SC-OR/20** 580 grams

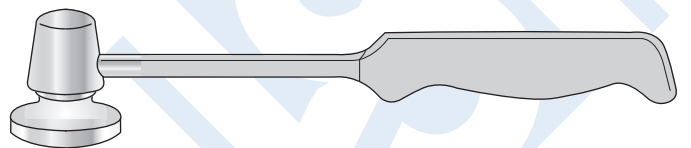

\* ALSO AVAILABLE WITH TUFNOL HANDLE

## MALLETS

---

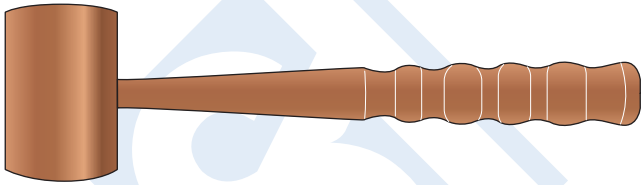

### Mallet

'Tufnol', 240mm long

**SC-OR/LE1001** 340 grams, vertical end

---

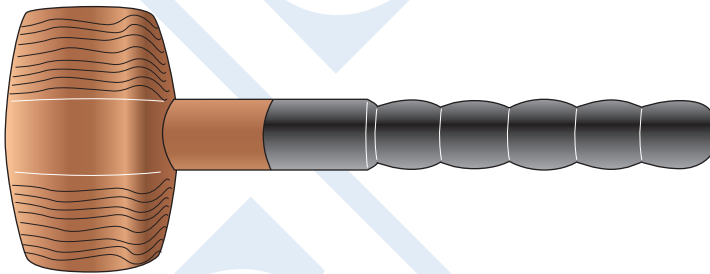

### Mallet

'Tufnol', 255mm long

**SC-OR/22a** 520 grams, vertical end

**SC-OR/22** 650 grams, horizontal end

---

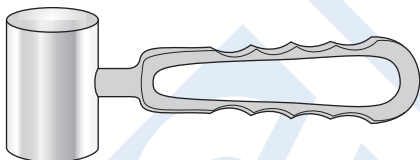
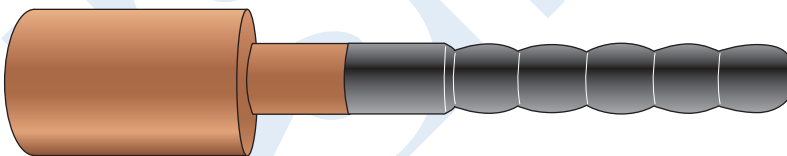

### Heath mallet

stainless steel, 135mm long

**SC-OR/N044c** 650 grams

**SC-OR/N044b** 920 grams

**SC-OR/N044** 1150 grams

**SC-OR/N044a** 1340 grams

---

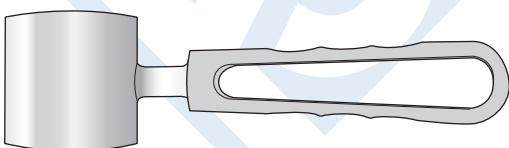

### Royal Cornwall mallet

stainless steel, with extended handle and strong welded head, 190mm long

**SC-OR/N044rc** 1000 grams

**MALLETS**

**Orthopaedic mallet**

Surgical Holdings pattern, stainless steel, 170mm long

**SC-OR/N055b** 800 grams

**SC-OR/N055** 880 grams

**SC-OR/N055a** 1020 grams

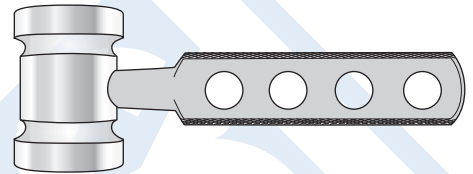

**Orthopaedic mallet**

stainless steel, Surgical Holdings pattern, one flat and one domed end, 180mm long

**SC-OR/272a** 960 grams

**SC-OR/272c** 750 grams

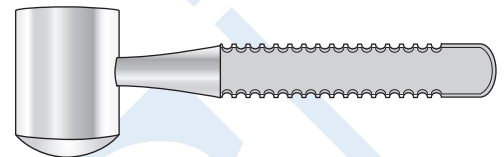

**Toffee hammer**

stainless steel, one plain and one serrated side, 190mm long

**SC-OR/N047** 280 grams

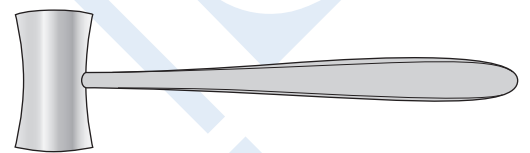

**Ombredanne mallet**

stainless steel, one flat and one domed end

**SC-OR/272** 950 grams, 240mm long

**SC-OR/272b** 1110 grams, 270mm long

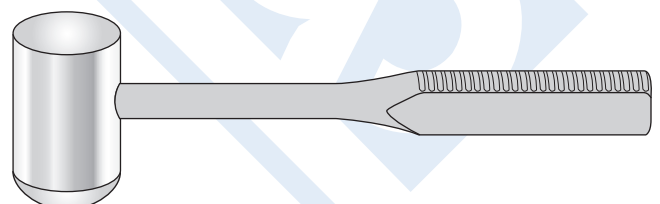

## MALLETS

---

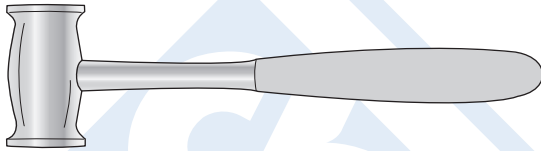

### Collin mallet

stainless steel, 205mm long

**SC-OR/23** 270grams

---

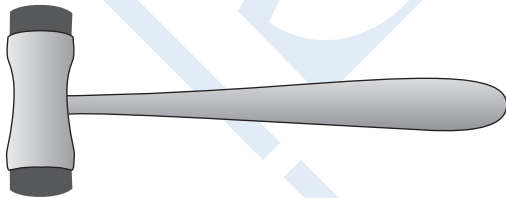

### Kelsey Fry mallet

with renewable acetal ends, 190mm long

**SC-OR/N047a** 280 grams

**SC-OR/N048** replacement end - pair

---

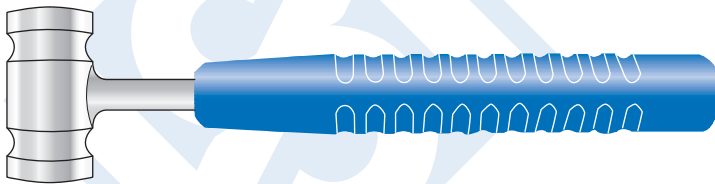

### Surgical Holdings orthopaedic mallet .

Stainless steel with Blue acetal "Suregrip" handle  
270mm long

**SC-OR/410** 720 grams

**SC-OR/411** 800 grams

**SC-OR/412** 900 grams

**SC-OR/413** 970 grams

---

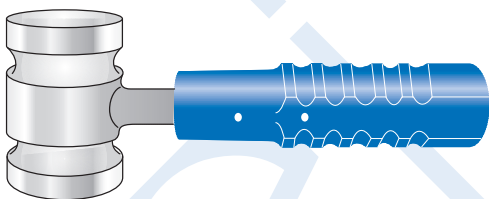

### Surgical Holdings orthopaedic mallet .

Stainless steel with blue acetal "Suregrip" handle  
200mm long

**SC-OR/414BH** 660 grams

**SC-OR/415BH** 790 grams

**SC-OR/416BH** 1020 grams

**SC-OR/417BH** 1400 grams

---

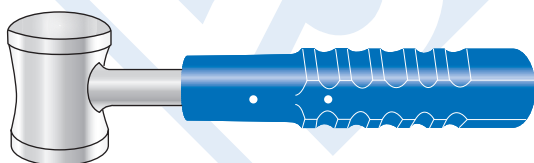

### Surgical Holdings mallet .

Stainless steel with Blue acetal "Suregrip" handle  
domed faced head, 200mm long

**SC-OR/418BH** 650 grams

**RASPS**

**Putti rasp**

**SC-OR/12** 300mm long

OTHER SHAPES AND  
CONFIGURATIONS ON REQUEST



**Bone file and rasp**

stainless steel

**SC-OR/12a** 215mm long



**Austin Moore type rasp**

including Tommy bar.  
295mm long

**SC-OR/HP001** standard

**SC-OR/HP002** narrow  
not illustrated

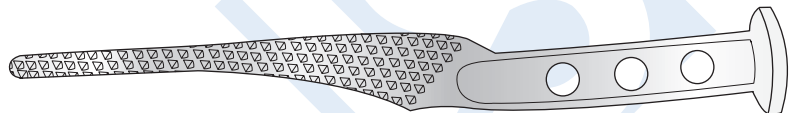

**Thompson type rasp**

including Tommy bar

**SC-OR/HP003** 270mm long

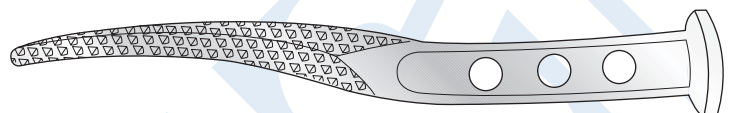

**MANY OTHER TYPES AVAILABLE**

SUPPLY A DRAWING OF THE PROSTHESIS - WE WILL MAKE THE RASP IN ANY BATCH SIZE YOU REQUIRE. THE TEETH WILL BE CHIPPED UP AT 0.75MM PER FACE OVER AND ABOVE THE SIZE OF THE PROSTHESIS STEM, TO ALLOW FOR CEMENTING.

## FILES AND PUNCHES

---



### Miller bone file

180mm long



**SC-OR/318** short end

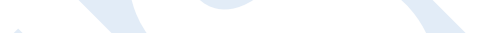

**SC-OR/319** slight curve



**SC-OR/322** full curve

---



### McGoey punch

double ended, 220mm long



**SC-OR/N04** 13 x 19mm



**SC-OR/N04a** 6 x 10mm



**SC-OR/N04b** 13 x 6mm half round

---



head size 15 x 19.5mm

### Smillie bone punch

**SC-OR/N018**

straight 140mm long

**SC-OR/N019**

cranked 175mm long



head size 9.5 x 15.5mm

## PUSHERS, IMPACTORS AND SKIDS

---

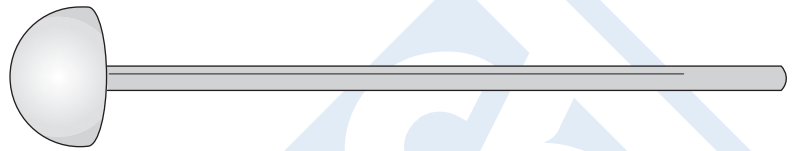

**Charley cup pusher**

with nylon head

**SC-OR/N020** 295mm long



**Charley prosthesis pusher**

stainless steel handle

with nylon insert

**SC-OR/N021** 180mm long

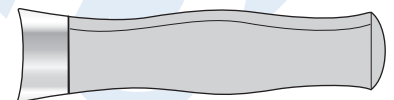

**Judet impactor**

stainless steel handle

with nylon head

**SC-OR/N009** 140mm long



**Femoral pusher**

head impactor, white Pomalux

**SC-OR/N053** 31mm  $\varnothing$  x 180mm long

## PUSHERS, IMPACTORS AND SKIDS

---



**Hardinge cement restrictor**  
with T handle

**SC-OR/HR001** 335mm long

---

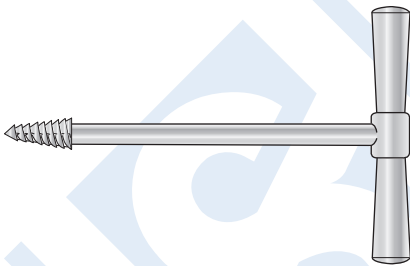

**Moore femoral head extractor**  
with T handle

**SC-OR/N005** 150mm long

**SC-OR/N006** 205mm long

---



**Murphy skids**  
double ended, 355mm long

**SC-OR/N007** uncoated

**SC-DIA/111** coated

---



**Murphy skids**  
single ended, 330mm long

**SC-OR/N007a** coated



**ELEVATORS**

**Adson periosteal elevator**

serrated grip, 165mm long

straight

**SC-OR/N028** 7mm wide

curved

**SC-OR/N029** 5mm wide

**SC-OR/N030** 7mm wide

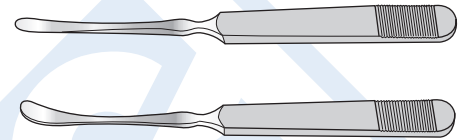

**Bristow periosteal elevator**

sharp edge

**SC-OR/N010** 240mm long

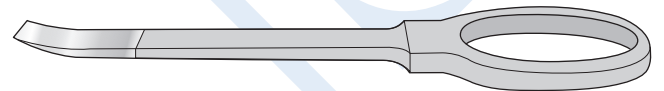

**Doyen periosteal elevator**

satin finish handle

165mm long

**SC-OR/N031** right

**SC-OR/N032** left

180mm long

**SC-OR/256** right

**SC-OR/255** left

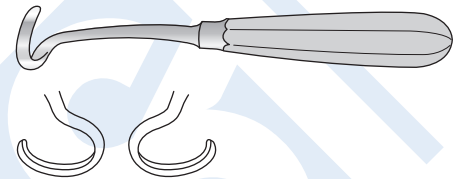

**Key periosteal elevator**

190mm long

**SC-OR/N023** 10mm wide

**SC-OR/N024** 13mm wide



**Langenbeck elevator**

straight

**SC-OR/302** 200mm long

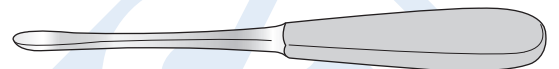

**Macdonald dissector** double ended

**SC-GI/285** 191mm long



## ELEVATORS

---

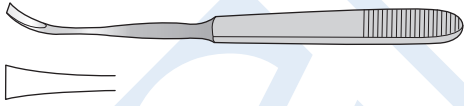

### Pennybacker elevator

curved, sharp, 6mm wide

**SC-OR/N025** 170mm long

---

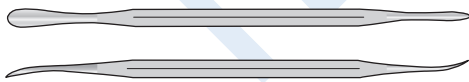

### Periosteal elevator

straight

**SC-OR/19a** 175mm long

---



### Periosteal elevator

straight, 12 x 20mm, with Blue acetal "Suregrip" handle

**SC-OR/SH-5695** 195mm long

---



### Periosteal elevator

curved, 5 x 25mm, with Blue acetal "Suregrip" handle

**SC-OR/SH-5696** 185mm long

---

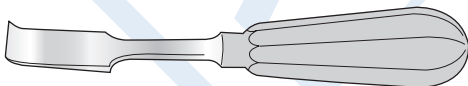

### Tudor Edwards periosteal elevator

for first rib, satin finish handle, 175mm long

**SC-OR/N026** 12mm wide

**SC-OR/N027** 18mm wide

---

**ELEVATORS**

**Hohmann bone elevator**

matt finish, 160mm long

**SC-OR/307a** 6mm wide

**SC-OR/307b** 8mm wide

**SC-OR/307d** 10mm wide

**SC-OR/307e** 15mm wide

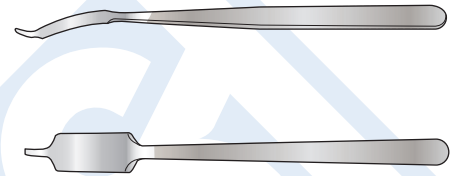

**Hohmann-Muller spike elevator**

with narrow spade

**SC-OR/307f** 220mm long, 10mm wide

**SC-OR/307** 230mm long, 12mm wide

**SC-OR/308** 240mm long, 18mm wide

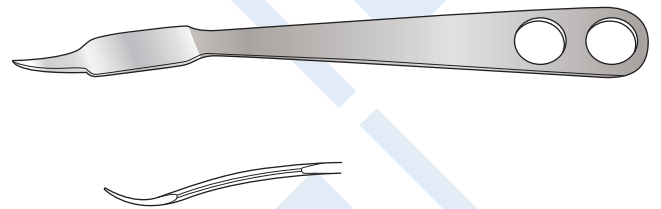

**Hohmann-Aldinger bone elevator**

curved

**SC-OR/304** 270mm long x 24mm wide

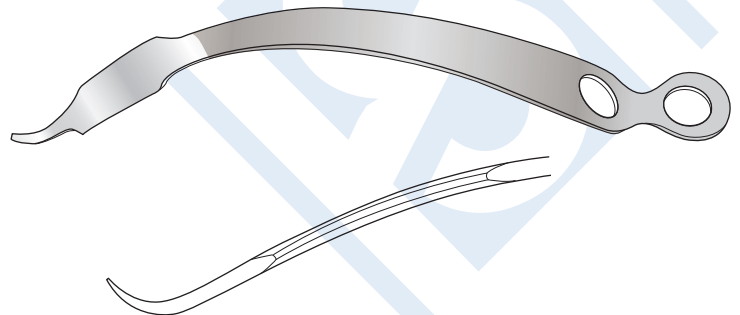

**Hohmann bone elevator**

curved

**SC-OR/305** 285mm long x 34mm wide

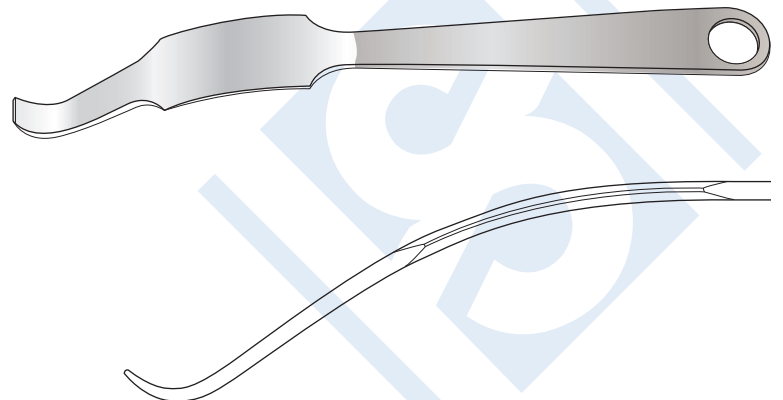

## ELEVATORS, RETRACTORS AND BONE LEVERS

---

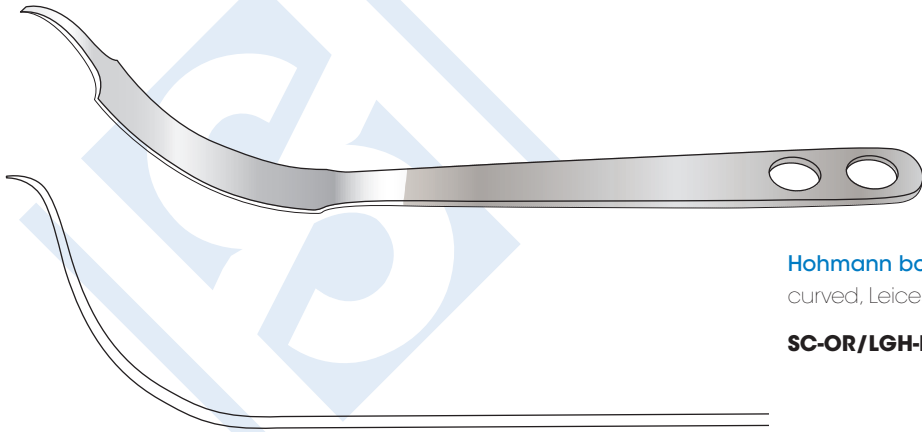

### Hohmann bone lever

curved, Leicester Royal Infirmary pattern

**SC-OR/LGH-HOH** 340mm long x 23mm wide

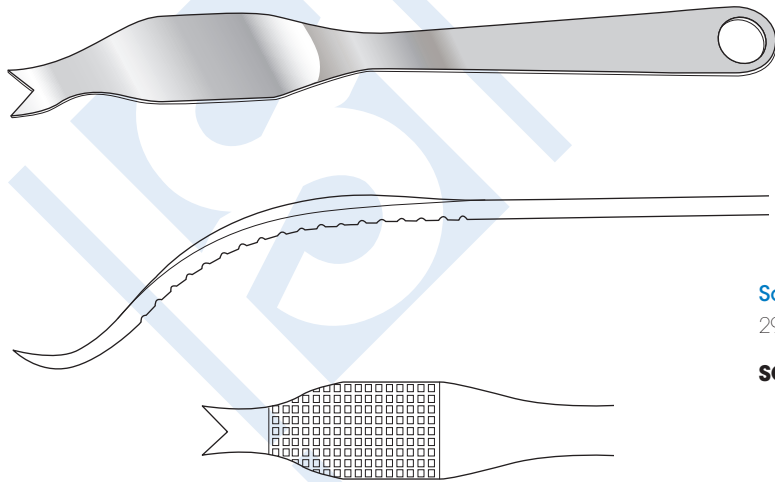

### Schumacher bone elevator

290mm long

**SC-OR/307k** 35mm wide, 18mm at edge

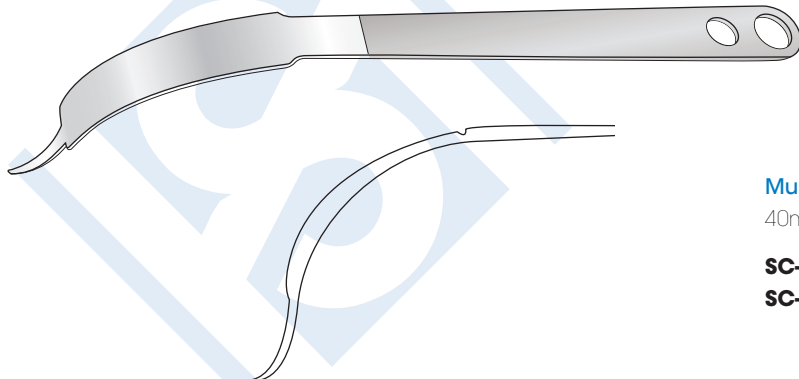

### Muller soft tissue retractor

40mm wide

**SC-OR/307aNOR** 410mm long

**SC-OR/307bNOR** 300mm long

**ELEVATORS, RETRACTORS AND BONE LEVERS**

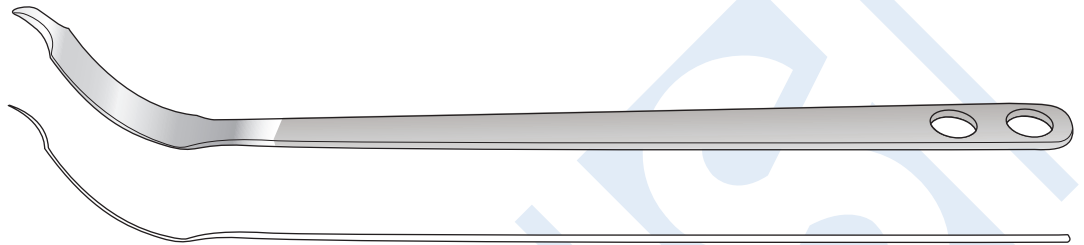

**Anterior hip retractor** 22mm wide  
**SC-OR/5912** large, 420mm long  
**SC-OR/5913** medium, 400mm long

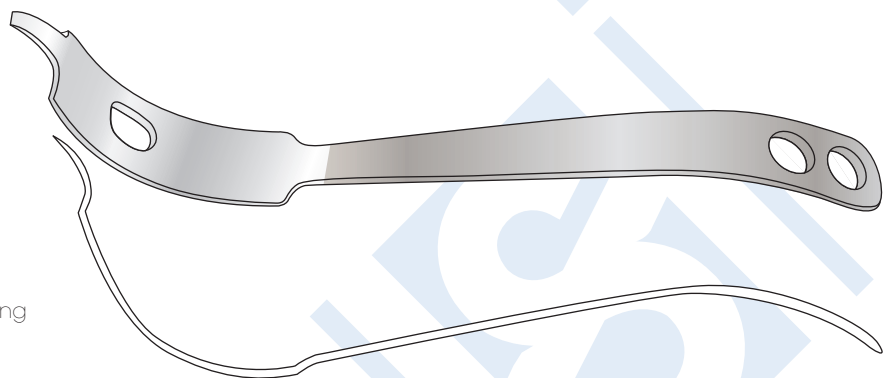

**Anterior hip retractor**  
**SC-OR/307L** 35mm wide, 330mm long

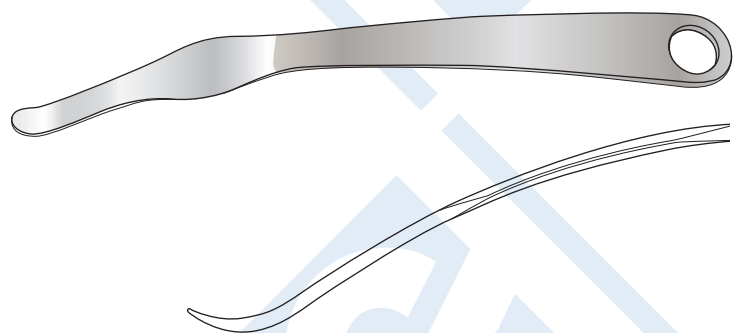

**Hohmann bone elevator**  
 for use with Bunch of 5's, 270mm long  
**SC-OR/309a** 24mm wide

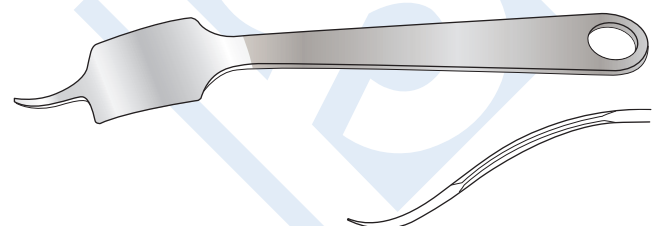

**Hohmann bone elevator**  
 with narrow spade  
**SC-OR/307c** 45mm wide, 240mm long  
**SC-OR/307g** 65mm wide, 255mm long

## ELEVATORS, RETRACTORS AND BONE LEVERS

---



**Wagner bone elevator**

220mm long

**SC-OR/307h** 17mm wide

---

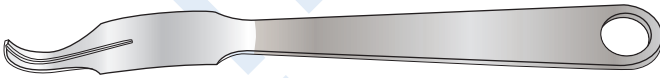

**Lange-Hohmann bone elevator**

250mm long

**SC-OR/307i** 24mm wide

---

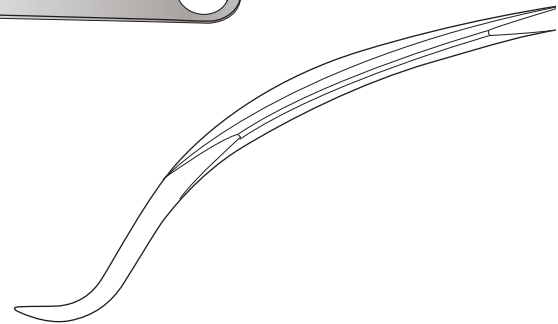
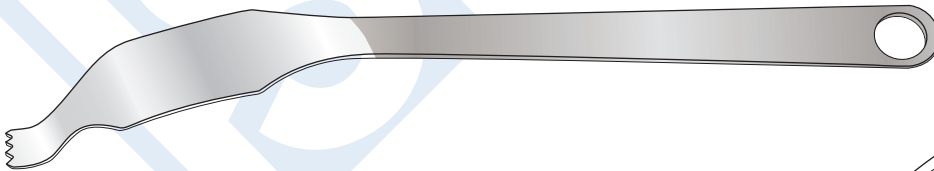

**Schumacher bone elevator**

345mm long

**SC-OR/307j** 37mm wide, 18mm at edge

---

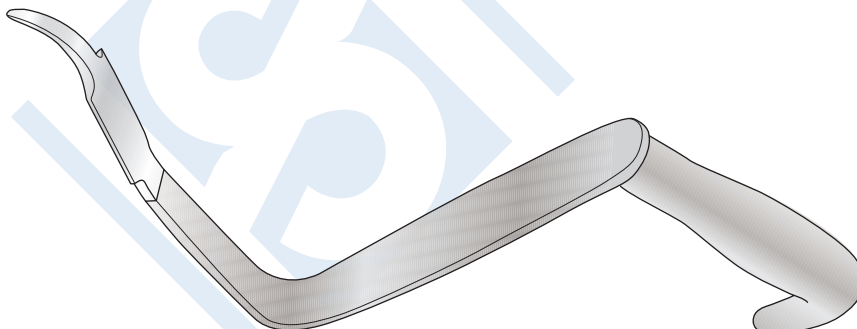

**Angled retractor**

with handle, 255mm overall length

**SC-OR/SH5638**

**ELEVATORS, RETRACTORS AND BONE LEVERS**

**Fakuda type retractor**

230mm long

**SC-OR/SH5507**

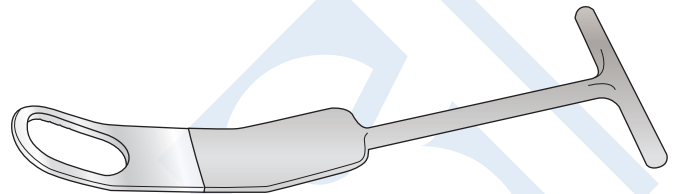

**Hohmann retractor**

45° angle

200mm long

**SC-OR/SH5394**

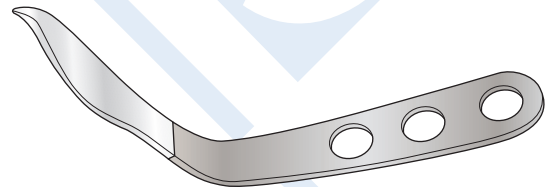

**Hohmann tapered spike retractor**

225mm overall length

**SC-OR/308a**

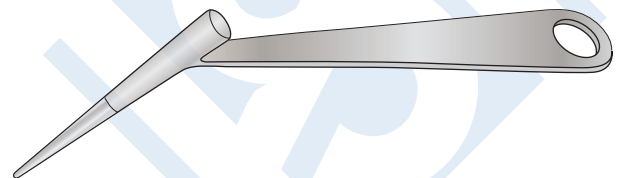

**Posterior bone lever**

230mm long

**SC-OR/308r**

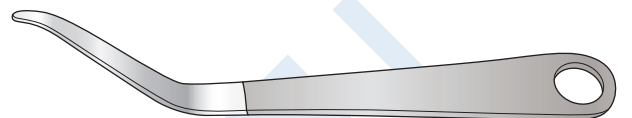

**Trethowan bone lever**

bent, ring handle 222mm long

**SC-OR/no17** straight

**SC-OR/no17b** 90° angle

**SC-OR/no17c** 70° angle (illustrated)

**SC-OR/no17d** 45° angle

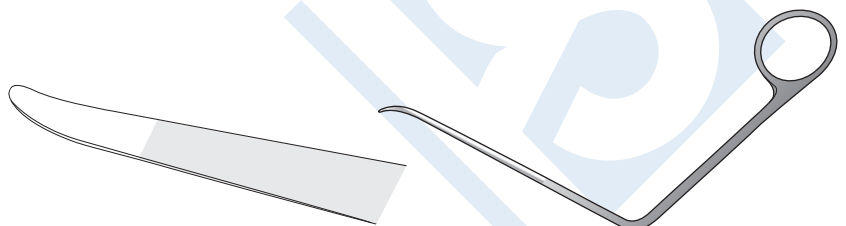

## SAWS

---

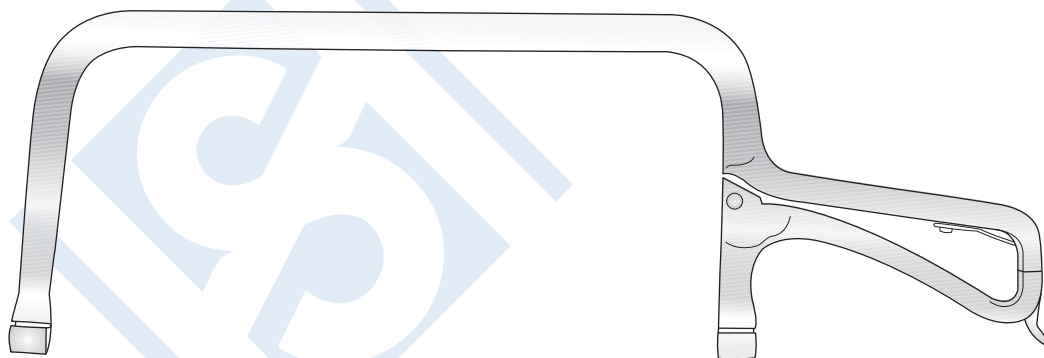

Collin amputation saw

**SC-OR/257**

390mm long

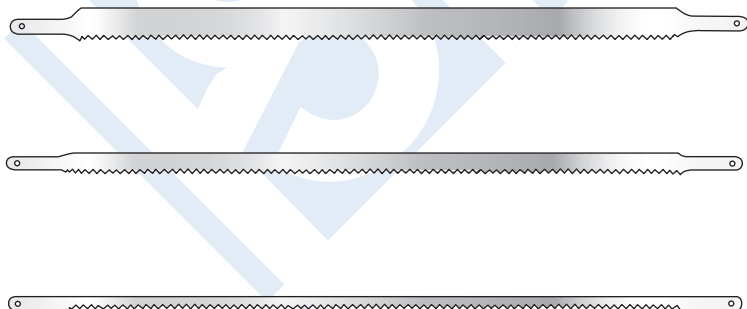

Saw blades

carbon steel

**SC-OR/326**



**SAWS, SHEARS AND KNIVES**

**Gigli saw handles**

per pair

**SC-OR/08** 65mm long

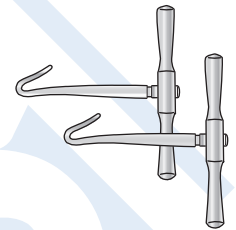

**Charnley saws**

**SC-OR/10c** 500mm long

**SC-OR/11c** 700mm long

**Gigli saws**

**SC-OR/09** 300mm long

**SC-OR/10** 500mm long

**SC-OR/11** 700mm long

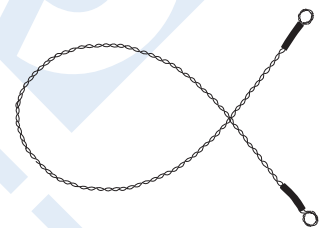

**Collin rib shears**

**SC-OR/001** 195mm long

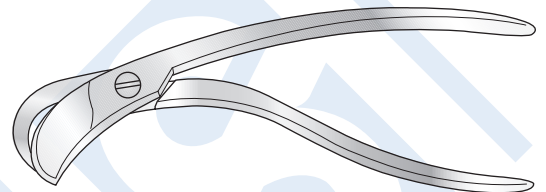

**Guys tenotomy knife**

**SC-OR/N046** 140mm long



**Smillie menisectomy knife**

175mm long

**SC-OR/048** straight

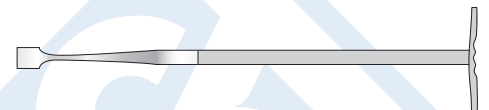

**Smillie menisectomy knife**

protruding beak at base, 175mm long

**SC-OR/N0048a** curved to right

**SC-OR/N0048b** curved to left

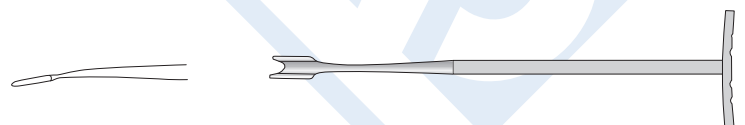

## NAIL AND STAPLE INSTRUMENTS

---

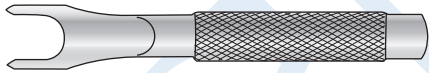

Staple starter  
**SC-OR/56a**

---

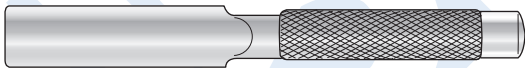

Staple set  
**SC-OR/56c**

---

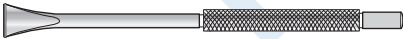

Staple set 150mm long  
**SC-OR/56e** for 1mm staples

---

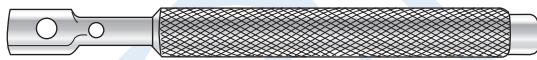

Driver  
for Rush nails  
**SC-OR/1350-003**

---

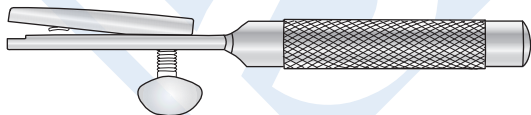

Staple driver  
**SC-OR/56b**

---

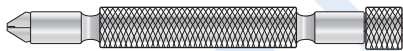

Staple driver 150mm long  
**SC-OR/56f** for 1mm staples

---

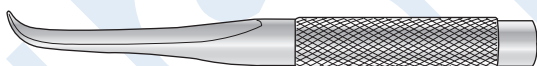

Staple remover  
**SC-OR/56d**

---



Staple remover 150mm long  
**SC-OR/56g** for 1mm staples

---

**NAIL AND STAPLE INSTRUMENTS**

Rush nail reamer

**SC-OR/1350-001**

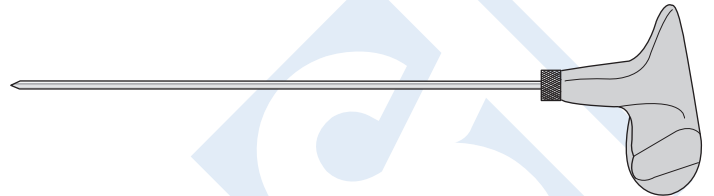

Bone awl (reamer)

straight, 150mm long

**SC-OR/SH-5658**

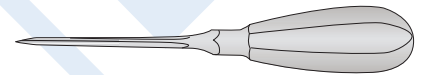

Bone awl

straight, with eye, 3.2mmø, 160mm long

**SC-OR/SH-5648**

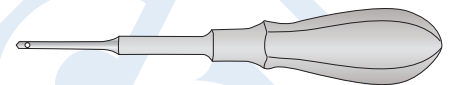

Pin bender

for Rush nails

**SC-OR/1350-002**



Pin punch

with Blue acetal "Suregrip" handle

**SC-OR/04** 130mm long



Hammer

for Rush nails, with Blue acetal "Suregrip" handle

**SC-OR/1325-000** 500g

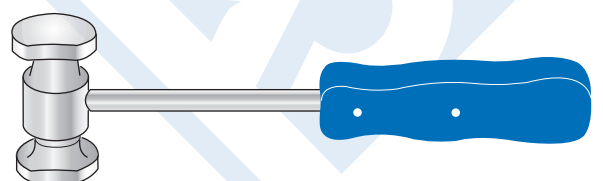

## SCREW AND PLATE INSTRUMENTS

---

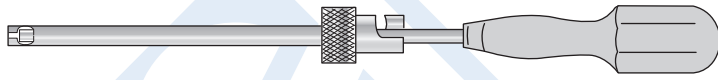

### Orthopaedic screwdriver

with holding sleeve

**SC-OR/42** for 3.6mm Ø screws, 279mm

**SC-OR/43** for 2.8mm Ø screws, 229mm

---



### Lanes type screwdriver

**SC-OR/44** single slot to fit 5/32, 9/64, 7/64 bone screws, 229mm long

Also available with Phillips and cross slot

---

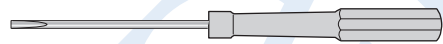

### Screwdriver

for finger plate screws

**SC-OR/45** 165mm long

---



### Screw depth gauge

calibrated in metric

**SC-OR/41** 254mm

---

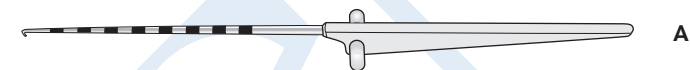

A



B



C

### Arthroscopy probe

230mm long

**SC-OR/N058** pattern A

**SC-OR/N058a** pattern B

**SC-OR/N058b** pattern C

---

**SCREW AND PLATE INSTRUMENTS**

**Allen key sets**

bright guard

**SC-OR/N051** 1.5mm - 10mm

TO ORDER:

QUOTE SC-OR/N051 THEN ADD SIZE REQUIRED

EG **SC-OR/N051-1.5**

size mm	overall length
1.5	63mm
2.0	77mm
2.5	87mm
3.0	93mm
4.0	104mm
5.0	120mm
6.0	141mm
7.0	147mm
8.0	158mm
10.0	180mm



**Orthopaedic ruler** stainless steel

**SC-OR/50** imperial, 6"

**SC-OR/51** metric, 150mm

**SC-OR/51a** metric, 300mm



**Bone plate benders**

per pair

**SC-OR/32** 190mm long

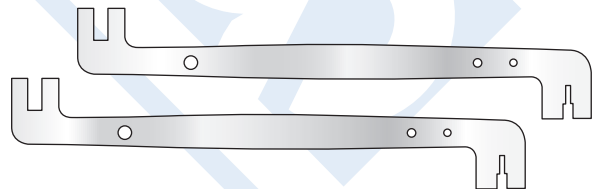

**Lane screw holding forceps**

**SC-OR/53b** 290mm long

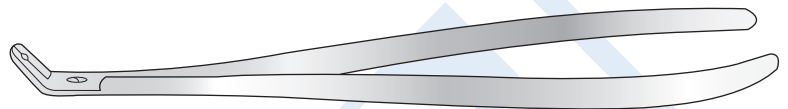

**Lane plate holding forceps**

**SC-OR/53a** 290mm long

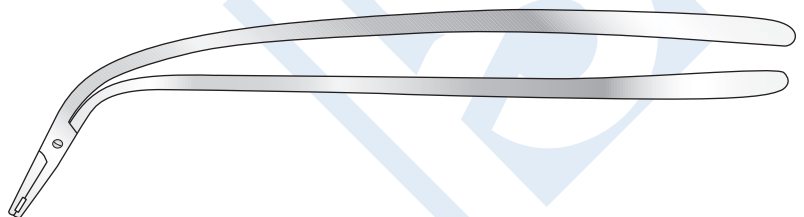

## DRILLS AND CHUCKS

---

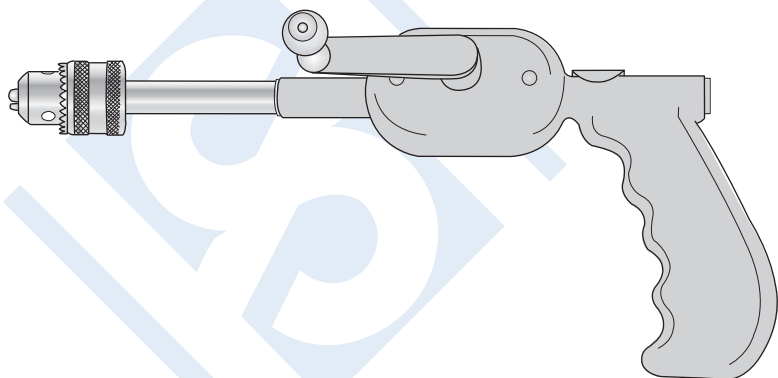

**Orthopaedic hand drill**  
with spindle lock

**SC-OR/52** 305mm

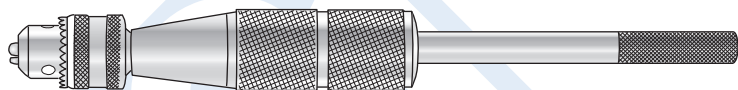

**Intramedullary pin chuck**

cannulated, with stainless steel holding sleeve,  
stainless steel chuck, aluminium handle

**SC-OR/02** Maximum capacity 6.5mm Ø  
267mm long

**Spare chuck key**

hard chrome

**SC-OR/02a** for SC-OR/2, SC-OR/2b, and SC-OR/2bl

**CHUCKS**

**Intramedullary pin chuck** stainless steel, with T handle  
**SC-OR/02b** maximum capacity 6.5mm Ø, 152mm long

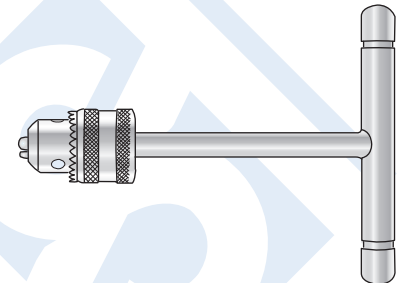

**Replacement chuck** stainless steel  
**SC-OR/02bf** for SC-OR/2 and SC-OR/2b

**Intramedullary pin chuck**  
 stainless steel chuck, with lightweight cannulated T handle  
**SC-OR/02bi** Maximum capacity 6.5mm ø, 140mm long

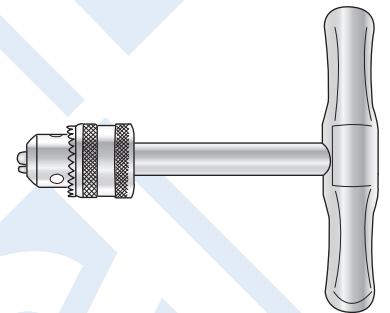

**Small chuck** for use with:  
**SC-OR/0447-002** 0445-097 Mini countersink 0445-020  
 0445-010 0445-024  
 0445-014 0445-027

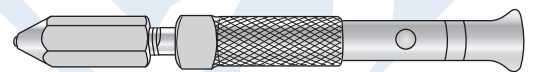

**Watson Jones Guide Wire Introducer**  
 stainless steel  
**SC-OR/02d** 140mm long

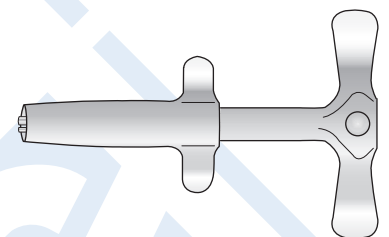

**Introducing handle**  
 for toe and finger wires, stainless steel  
**SC-OR/02e** up to 1.5mmØ

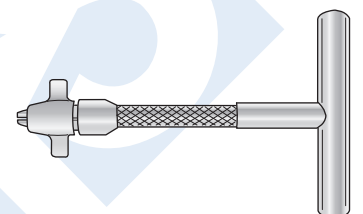

## DRILLS / CERCLAGE WIRE

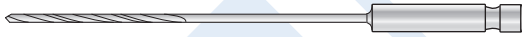

### Twist drills

with quick fit

	Ø mm	TOTAL LENGTH mm	FLUTE LENGTH mm	
<b>SC-OR/0445-011</b>	1.1	60	35	for 1.5mm cortical screws
<b>SC-OR/0445-015</b>	1.5	85	60	for 1.5mm cortical screws
<b>SC-OR/0445-016</b>	1.5	105	70	large, for 1.5mm cortical screws
<b>SC-OR/0445-019</b>	2.0	100	75	for 2.7mm cortical screws
<b>SC-OR/0445-021</b>	2.0	125	100	large, for 4.0mm cortical screws
<b>SC-OR/0445-025</b>	2.5	110	85	for 4.0mm cortical and cancellous screws
<b>SC-OR/0445-023</b>	2.5	180	155	large, for 4.0mm cortical and cancellous screws
<b>SC-OR/0445-026</b>	2.7	105	75	for 2.7mm cortical screws
<b>SC-OR/0445-028</b>	2.7	125	100	large, for 2.7mm cortical screws
<b>SC-OR/0445-031</b>	3.2	145	110	for 4.5mm cortical screws
<b>SC-OR/0445-029</b>	3.2	195	160	large, for 4.5mm cortical screws
<b>SC-OR/0445-035</b>	3.5	110	85	for 3.57mm cortical screws
<b>SC-OR/0445-037</b>	3.5	195	160	large, for 3.5mm cortical screws
<b>SC-OR/0445-044</b>	4.5	145	120	for 4.5mm cortical screws
<b>SC-OR/0445-048</b>	4.5	195	170	large, for 4.5mm cortical screws



### Twist drills OTD

Made from implant grade stainless steel, with 2.5mm flute x 125mm long

material conforms to BS 7252: Part 1: 1997. ISO 5832-1: 1997. Comp.D.

### CODE & mmØ

**OTD/1.4**

**OTD/1.6**

**OTD/2.0**

**OTD/2.4**

**OTD/2.8**

**OTD/3.2**

### CODE & mmØ

**OTD/3.6**

**OTD/4.0**

**OTD/4.4**

**OTD/4.8**

**OTD/5.6**

**OTD/6.4**

OTHER SIZES AVAILABLE



### Soft wires with eyes

In packs of 10

	Ø mm	LENGTH mm
<b>SC-OR/0407-008</b>	0.8	280
<b>SC-OR/0407-001</b>	1.0	280
<b>SC-OR/0407-002</b>	1.2	280
<b>SC-OR/0407-007</b>	0.8	500
<b>SC-OR/0407-003</b>	1.0	500
<b>SC-OR/0407-004</b>	1.2	500

### Soft wires without eye

In packs of 10

	Ø mm	LENGTH mm
<b>SC-OR/0407-024</b>	0.6	175
<b>SC-OR/0407-026</b>	0.8	200
<b>SC-OR/0407-027</b>	1.0	250
<b>SC-OR/0407-028</b>	1.2	300
<b>SC-OR/0407-029</b>	0.8	500
<b>SC-OR/0407-030</b>	1.0	500
<b>SC-OR/0407-031</b>	1.2	500

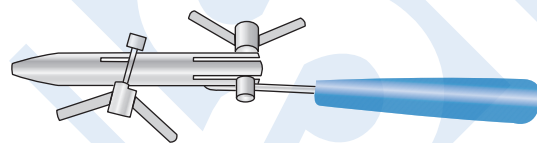

### Wire tightener

for Cerclage and Kirschner wires with two blue acetal "Suregrip" handles\*

**SC-OR/0607-021** 23mm long

### Rolls

	Ø mm	LENGTH m
<b>SC-OR/0407-009</b>	0.8	10
<b>SC-OR/0407-005</b>	1.0	10
<b>SC-OR/0407-006</b>	1.2	10



**AO TYPE INSTRUMENTS**



**Mini countersink**

**SC-OR/0445-088** for 1.5mm & 2mm screws



**Small countersink**

**SC-OR/0445-087** for 2.7mm screws



**Small countersink**

**SC-OR/0445-089** for 3.5mm screws

**Threaded tap**

**SC-OR/0447-019** for 2mmØ mini screws

**SC-OR/0447-028** for 2.7mmØ cortical screws

**SC-OR/0447-033** for 3.5mmØ fine thread



**Threaded tap**

**SC-OR/0447-015** for 1.5mmØ mini screws

**SC-OR/0447-026** for 2.7mmØ cortical screws

**SC-OR/0447-032** for 3.5mmØ cortical screws

**SC-OR/0447-034** for 4mmØ cancellous screws



**Threaded tap**

**SC-OR/0447-046** for 4.5mmØ cortical screws



for use with:

**0445-088** Mini countersink

**0447-015** Threaded tap

**0447-019** Threaded tap

**0453-032** Mini screwdriver,  
cross slotted

**0453-034** Mini screwdriver,  
with subsection forceps

**0453-045** Cross slotted screwdriver

**Handle**

with dental couple, with Blue acetal  
"Suregrip" handle\*

**SC-OR/0447-001**



## AO TYPE INSTRUMENTS



### Holding sleeve

**SC-OR/0453-028** for screws



### Holding sleeve

**SC-OR/0451-098** for mini screws



### Holding sleeve

**SC-OR/0453-006** for small screws



### Handle

with quick fit, with Blue acetal "Suregrip" handle \*

**SC-OR/0447-043**

for use with:

**0447-026** Threaded tap

**0447-028** Long threaded tap

**0447-032** Fine threaded tap

**0447-033** Long threaded tap

**0447-034** Threaded tap  
for cancellous screws

**0447-046** Threaded tap for cortical screws

**0445-087** Small countersink 2.7

**0445-089** Small countersink 3.5

**0453-003** Small hexagonal screwdriver

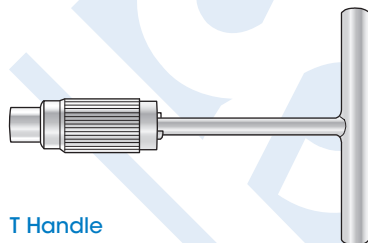

### T Handle

with quick fit

**SC-OR/0447-044**

for use with:

**0447-026** Threaded tap

**0447-028** Long threaded tap

**0447-032** Fine threaded tap

**0447-033** Long threaded tap

**0447-034** Threaded tap for cancellous screws

**0447-046** Threaded tap for cortical screws

**0447-048** Long threaded tap 4.5Ø

**0453-003** Small hexagonal screwdriver

\* ALSO AVAILABLE WITH TUFNOL HANDLE

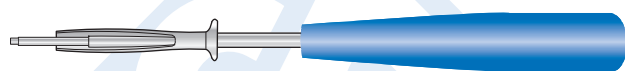

### Small screwdriver

with hexagonal end for use with holding sleeve,  
with blue acetal "Suregrip" handle \*

SC-OR/0451-098

**SC-OR/0453-002** 2.5mm

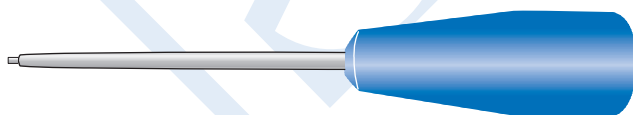

### Hexagonal screwdriver

for large screws, with blue acetal "Suregrip" handle \*

**SC-OR/0453-012** 3.5mmØ

**AO TYPE INSTRUMENTS**

**Small cross slotted screwdriver**

with holding sleeve, with blue acetal "Suregrip" handle \*  
SC-OR/0453-006

**SC-OR/0453-045**



**Cardan screwdriver**

**SC-OR/0453-017**

for screws with 3.5mmØ hexagonal head, with blue acetal "Suregrip" handle \*



\* ALSO AVAILABLE WITH TUFNOL HANDLE

**Screwdriver with T handle**

**SC-OR/0453-013** for screws with 3.5mmØ hexagonal head

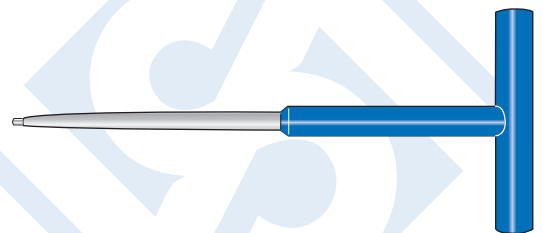

**Mini screwdriver**

with holding sleeve, cross slotted

**SC-OR/0453-032**



**Mini screwdriver**

with holding sleeve, and hexagonal end 1.5mm

**SC-OR/0453-034**



**Small hexagonal screwdriver**

**SC-OR/0453-003** 2.5mmØ  
for use with:  
**0447-043** Handle with quick fit  
**0447-044** T handle with quick fit



## AO TYPE INSTRUMENTS

---

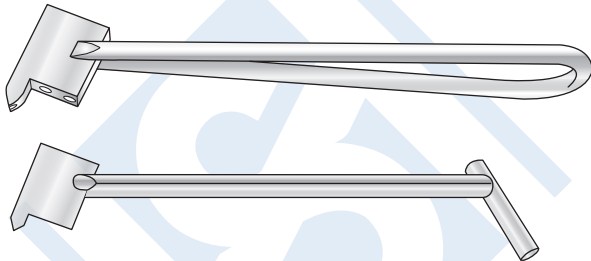

### Drill guide

for 2mmØ screws

**SC-OR/0449-025**

**SC-OR/0449-020** with finder

---

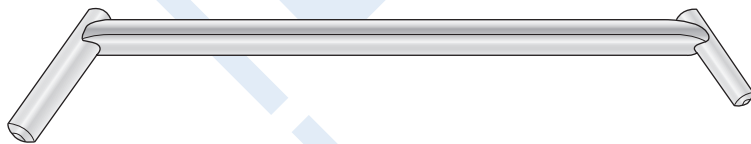

### Drill guide

**SC-OR/0449-015** for 1.1 and 1.5mmØ drills

---

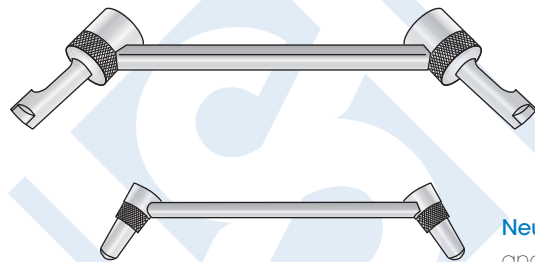

### Neutral drill guide

and dynamic compression  
system tension

**SC-OR/0469-032**

for 3.5mm cortical screws,  
fine thread, 2.5mm drills

**SC-OR/0469-043**

for 4.5mm screws, 3.2mm drills  
extra long

**SC-OR/0469-044**

For 4.5mm screws, 3.2mm drills

**SC-OR/0469-015**

For 2mm screws, 1.5mm drills

**SC-OR/0469-021**

For 2.7mm screws, 2.0mm drills

---



**Spanner** for use with **0262-045** cortical nuts,  
11mmØ, 8mmØ hexagon

**SC-OR/0453-021**

---

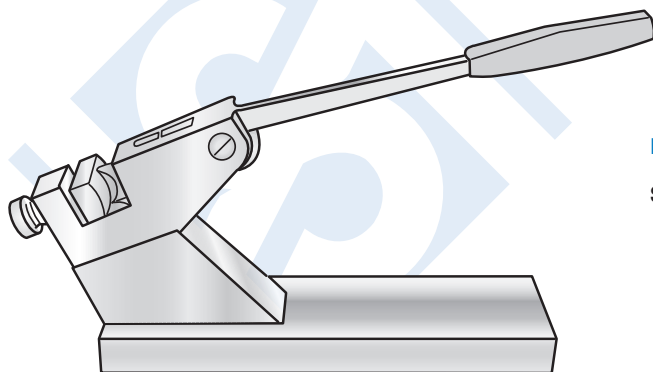

### Plate bending press

**SC-OR/0483-030**

**CLOVER LEAF NAILS AND INSTRUMENTS**

**Nail introducer**

**SC-OR/1319** straight

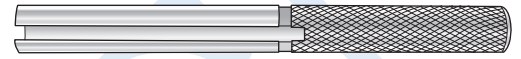

**Nail driver**

**SC-OR/1321**

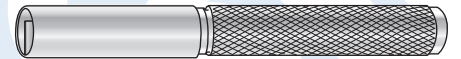

**Nail impactor**

**SC-OR/1323**

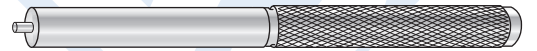

**Nail extractor**

with flattened hook,  
for medullary nails 6-12mmø

**SC-OR/0047b** 305mm

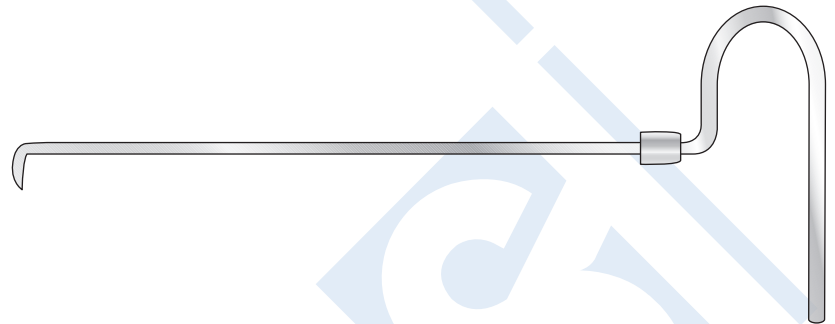

**Slotted hammer**

for use with above

**SC-OR/0047a** 280mm



**Nail extractor**

sliding hammer  
with detachable hook  
for medullary nails 6-16mmø

**SC-OR/1201** 540mm long

**SC-OR/1204** hook only

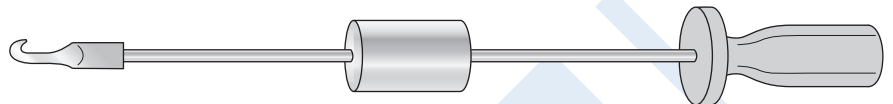

## THREADED PINS, RUSH PINS AND GUIDE WIRES



### Threaded pin

with triangular point

5mmØ drill size 3.5mm Ø

	LENGTH mm	LENGTH mm	LENGTH mm
<b>SC-OR/0413-052</b>	100	<b>SC-OR/0413-054</b>	150
<b>SC-OR/0413-053</b>	125	<b>SC-OR/0413-055</b>	170
		<b>SC-OR/0413-056</b>	200
		<b>SC-OR/0413-057</b>	250

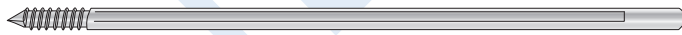

### Threaded pin

with triangular point

6mmØ,

thread length 50mm

drill size Ø 4.5mm

	LENGTH mm	4.5mmØ, thread length 18mm, drill size Ø 3.5mm, 4.5mm	LENGTH mm
<b>SC-OR/0413-072</b>	100		
<b>SC-OR/0413-073</b>	125		
<b>SC-OR/0413-074</b>	150		<b>SC-OR/0413-060</b>
<b>SC-OR/0413-075</b>	170		<b>SC-OR/0413-061</b>
<b>SC-OR/0413-076</b>	200		<b>SC-OR/0413-062</b>



### Denham pin

Temporary implants,

material conforms to BS 7252: Part 1:

1997 .ISO 5832-1: 1997. Comp.D.

CE marking available on request

square end or  
three sided end in stock  
other sizes available

	SIZES Ø	LENGTH
DP/1	3.96mm (5/32")	20.3mm (8")
DP/2	3.96mm (5/32")	22.9mm (9")
DP/3	4.76mm (3/16")	20.3mm (8")
DP/4	4.76mm (3/16")	22.9mm (9")



### Rush pins

material conforms to BS 7252: Part 1: 1997.

ISO 5832-1: 1997. Comp.D.

3/32" and 1/8" Ø up to 10.2mm (4")

Other diameters and lengths available

LENGTHS	
mm	inch
15.2	6
17.8	7
20.3	8
22.9	9
25.4	10
27.9	11
30.0	11.75



### Watson Jones guide wire

material conforms to BS 7252: Part 1:

1997. ISO 5832-1: 1997

triangular end

2.4mm (3/32") Ø

graduated in mms or 1/4"

## WIRES AND PINS

**Steinmann pins** Temporary implants, material conforms to BS 7252: Part 1: 1997. ISO 5832-1: 1997. Comp.D. CE marking available on request

Ø mm*	Ø mm*
1.58	3.96
2.00	4.36
2.38	4.76
2.78	6.00
3.17	6.35
3.57	8.00

**LENGTHS** 150, 180, 200, 250mm  
\*Other lengths and dimensions available

When ordering, use prefix letters with size following, eg Trocar with one screw end  
Ø4.76mm = IPTS/476



**IPTT** = trocar/trocar ends



**IPTS** = trocar/trocar with one screw end



**IPTSE** = trocar/square end



**IPTSE3** = trocar/with 3 sided end

**Steinmann pin cap** with slot

**SC-OR/54a-4** 4mmØ

**SC-OR/54a-6** 6mmØ

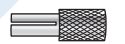

**SC-OR 54a**

**Steinmann pin cap** with screw

**SC-OR/54b-4** 4mmØ

**SC-OR/54b/1** 6mmØ

**SC-OR/54c** replacement screw

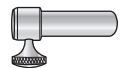

**SC-OR 54b**

**Bohler stirrup**

**SC-OR/N001** small 89 x 102mm

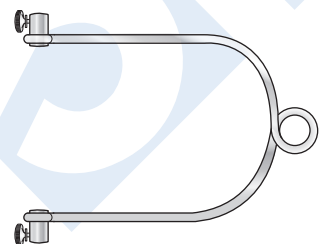

**SC-OR/N002** medium 114 x 165mm

**SC-OR/N003** large 152 x 241mm



## KIRSCHNER/ARTHRODESIS WIRES AND ACCESSORIES

**Kirschner/Arthrodesis wire** Temporary implants, material conforms to BS 7252: Part 1: 1997. ISO 5832-1: 1997. Comp.D.

	Ø mm 0.9 1.0 1.1 1.2 1.4 1.5 1.6 2.0
trocar/trocar <b>KW/TT(+Ø)</b>	
	
trocar/plain <b>KW/TP(+Ø)</b>	
	
drill point/plain <b>KW/DPP(+Ø)</b>	
	
trocar/trocar part threaded each end <b>KW/TTPT(+Ø)</b>	
	
trocar/trocar fully threaded <b>KW/TTFT(+Ø)</b> length up to 127mm available in 1.2mmØ and 1.6mmØ	

**LENGTHS** up to 100, 127, 152, 229, 300mm

These standard style ends are in stock, other combinations available.

When ordering, use prefix letters + diameter in mm + length required



**Kirschner wire bender**

**SC-OR/55a** 137mm long

**SC-OR/55b** 133mm long

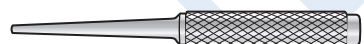



## KIRSCHNER WIRES

Kirschner wire, sterile, in packets of 10

### TROCAR/PLAIN



<b>KWHS007-S</b> 0.9mm x 50mm	<b>KWHS258-S</b> 1.1mm x 50mm	<b>KWHS010-S</b> 1.4mm x 50mm	<b>KWHS102-S</b> 2.0mm x 100mm
<b>KWHS025-S</b> 0.9mm x 65mm	<b>KWHS261-S</b> 1.1mm x 65mm	<b>KWHS028-S</b> 1.4mm x 65mm	<b>KWHS120-S</b> 2.0mm x 115mm
<b>KWHS043-S</b> 0.9mm x 70mm	<b>KWHS264-S</b> 1.1mm x 70mm	<b>KWHS046-S</b> 1.4mm x 70mm	<b>KWHS138-S</b> 2.0mm x 125mm
<b>KWHS061-S</b> 0.9mm x 75mm	<b>KWHS267-S</b> 1.1mm x 75mm	<b>KWHS064-S</b> 1.4mm x 75mm	<b>KWHS156-S</b> 2.0mm x 140mm
<b>KWHS079-S</b> 0.9mm x 90mm	<b>KWHS270-S</b> 1.1mm x 90mm	<b>KWHS082-S</b> 1.4mm x 90mm	<b>KWHS0018-S</b> 2.0mm x 150mm
<b>KWHS097-S</b> 0.9mm x 100mm	<b>KWHS273-S</b> 1.1mm x 100mm	<b>KWHS100-S</b> 1.4mm x 100mm	<b>KWHS174-S</b> 2.0mm x 180mm
<b>KWHS115-S</b> 0.9mm x 115mm	<b>KWHS276-S</b> 1.1mm x 115mm	<b>KWHS118-S</b> 1.4mm x 115mm	<b>KWHS192-S</b> 2.0mm x 200mm
<b>KWHS133-S</b> 0.9mm x 125mm	<b>KWHS279-S</b> 1.1mm x 125mm	<b>KWHS136-S</b> 1.4mm x 125mm	
<b>KWHS151-S</b> 0.9mm x 140mm	<b>KWHS282-S</b> 1.1mm x 140mm	<b>KWHS154-S</b> 1.4mm x 140mm	
<b>KWHS0014A-S</b> 0.9mm x 150mm	<b>KWHS285-S</b> 1.1mm x 150mm	<b>KWHS0021-S</b> 1.4mm x 150mm	
<b>KWHS169-S</b> 0.9mm x 180mm	<b>KWHS288-S</b> 1.1mm x 180mm	<b>KWHS172-S</b> 1.4mm x 180mm	
<b>KWHS187-S</b> 0.9mm x 200mm	<b>KWHS291-S</b> 1.1mm x 200mm	<b>KWHS190-S</b> 1.4mm x 200mm	
<hr/>			
<b>KWHS008-S</b> 1.0mm x 50mm	<b>KWHS009-S</b> 1.2mm x 50mm	<b>KWHS011-S</b> 1.6mm x 50mm	
<b>KWHS026-S</b> 1.0mm x 65mm	<b>KWHS027-S</b> 1.2mm x 65mm	<b>KWHS029-S</b> 1.6mm x 65mm	
<b>KWHS044-S</b> 1.0mm x 70mm	<b>KWHS045-S</b> 1.2mm x 70mm	<b>KWHS047-S</b> 1.6mm x 70mm	
<b>KWHS062-S</b> 1.0mm x 75mm	<b>KWHS063-S</b> 1.2mm x 75mm	<b>KWHS065-S</b> 1.6mm x 75mm	
<b>KWHS080-S</b> 1.0mm x 90mm	<b>KWHS081-S</b> 1.2mm x 90mm	<b>KWHS083-S</b> 1.6mm x 90mm	
<b>KWHS098-S</b> 1.0mm x 100mm	<b>KWHS099-S</b> 1.2mm x 100mm	<b>KWHS101-S</b> 1.6mm x 100mm	
<b>KWHS116-S</b> 1.0mm x 115mm	<b>KWHS117-S</b> 1.2mm x 115mm	<b>KWHS119-S</b> 1.6mm x 115mm	
<b>KWHS134-S</b> 1.0mm x 125mm	<b>KWHS135-S</b> 1.2mm x 125mm	<b>KWHS137-S</b> 1.6mm x 125mm	
<b>KWHS152-S</b> 1.0mm x 140mm	<b>KWHS153-S</b> 1.2mm x 140mm	<b>KWHS155-S</b> 1.6mm x 140mm	
<b>KWHS0016-S</b> 1.0mm x 150mm	<b>KWHS171-S</b> 1.2mm x 180mm	<b>KWHS0017-S</b> 1.6mm x 150mm	
<b>KWHS170-S</b> 1.0mm x 180mm	<b>KWHS189-S</b> 1.2mm x 200mm	<b>KWHS173-S</b> 1.6mm x 180mm	
<b>KWHS188-S</b> 1.0mm x 200mm		<b>KWHS191-S</b> 1.6mm x 200mm	
	<b>KWHS0019-S</b> 1.25mm x 150mm		

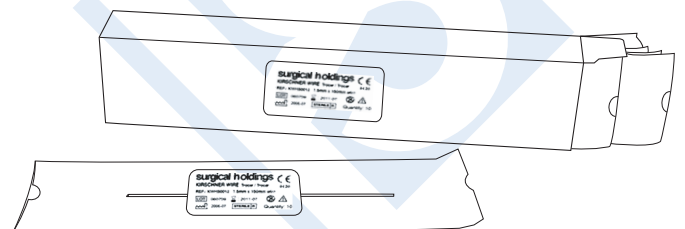

## ARTHRODESIS WIRE

Arthrodesis wire, sterile, in packets of 10



<b>KWHS001-S</b>	0.9mm x 50mm	<b>KWHS257-S</b>	1.1mm x 50mm	<b>KWHS004-S</b>	1.4mm x 50mm	<b>KWHS286-S</b>	1.8 x 50mm
<b>KWHS019-S</b>	0.9mm x 65mm	<b>KWHS260-S</b>	1.1mm x 65mm	<b>KWHS022-S</b>	1.4mm x 65mm	<b>KWHS287-S</b>	1.8 x 65mm
<b>KWHS037-S</b>	0.9mm x 70mm	<b>KWHS263-S</b>	1.1mm x 70mm	<b>KWHS040-S</b>	1.4mm x 70mm	<b>KWHS288-S</b>	1.8 x 70mm
<b>KWHS055-S</b>	0.9mm x 75mm	<b>KWHS266-S</b>	1.1mm x 75mm	<b>KWHS058-S</b>	1.4mm x 75mm	<b>KWHS289-S</b>	1.8 x 75mm
<b>KWHS073-S</b>	0.9mm x 90mm	<b>KWHS269-S</b>	1.1mm x 90mm	<b>KWHS076-S</b>	1.4mm x 90mm	<b>KWHS290-S</b>	1.8 x 90mm
<b>KWHS091-S</b>	0.9mm x 100mm	<b>KWHS272-S</b>	1.1mm x 100mm	<b>KWHS094-S</b>	1.4mm x 100mm	<b>KWHS276-S</b>	1.8 x 100mm
<b>KWHS109-S</b>	0.9mm x 115mm	<b>KWHS275-S</b>	1.1mm x 115mm	<b>KWHS112-S</b>	1.4mm x 115mm	<b>KWHS277-S</b>	1.8 x 115mm
<b>KWHS127-S</b>	0.9mm x 125mm	<b>KWHS278-S</b>	1.1mm x 125mm	<b>KWHS130-S</b>	1.4mm x 125mm	<b>KWHS278A-S</b>	1.8 x 125mm
<b>KWHS145-S</b>	0.9mm x 140mm	<b>KWHS281-S</b>	1.1mm x 140mm	<b>KWHS148-S</b>	1.4mm x 140mm	<b>KWHS279-S</b>	1.8 x 140mm
<b>KWHS0009-S</b>	0.9mm x 150mm	<b>KWHS284-S</b>	1.1mm x 150mm	<b>KWHS0011-S</b>	1.4mm x 150mm	<b>KWHS280-S</b>	1.8 x 150mm
<b>KWHS163-S</b>	0.9mm x 180mm	<b>KWHS290-S</b>	1.1mm x 200mm	<b>KWHS166-S</b>	1.4mm x 180mm	<b>KWHS281A-S</b>	1.8 x 180mm
<b>KWHS181-S</b>	0.9mm x 200mm			<b>KWHS184-S</b>	1.4mm x 200mm	<b>KWHS282-S</b>	1.8 x 200mm
		<b>KWHS003-S</b>	1.2mm x 50mm				
<b>KWHS002-S</b>	1.0mm x 50mm	<b>KWHS021-S</b>	1.2mm x 65mm	<b>KWHS0011A</b>	1.5mm x 150mm	<b>KWHS006-S</b>	2.0mm x 50mm
<b>KWHS020-S</b>	1.0mm x 65mm	<b>KWHS039-S</b>	1.2mm x 70mm			<b>KWHS024-S</b>	2.0mm x 65mm
<b>KWHS038-S</b>	1.0mm x 70mm	<b>KWHS057-S</b>	1.2mm x 75mm	<b>KWHS005-S</b>	1.6mm x 50mm	<b>KWHS042-S</b>	2.0mm x 70mm
<b>KWHS056-S</b>	1.0mm x 75mm	<b>KWHS075-S</b>	1.2mm x 90mm	<b>KWHS023-S</b>	1.6mm x 65mm	<b>KWHS060-S</b>	2.0mm x 75mm
<b>KWHS074-S</b>	1.0mm x 90mm	<b>KWHS093-S</b>	1.2mm x 100mm	<b>KWHS041-S</b>	1.6mm x 70mm	<b>KWHS078-S</b>	2.0mm x 90mm
<b>KWHS092-S</b>	1.0mm x 100mm	<b>KWHS111-S</b>	1.2mm x 115mm	<b>KWHS059-S</b>	1.6mm x 75mm	<b>KWHS096-S</b>	2.0mm x 100mm
<b>KWHS110-S</b>	1.0mm x 115mm	<b>KWHS129-S</b>	1.2mm x 125mm	<b>KWHS077-S</b>	1.6mm x 90mm	<b>KWHS114-S</b>	2.0mm x 115mm
<b>KWHS128-S</b>	1.0mm x 125mm	<b>KWHS147-S</b>	1.2mm x 140mm	<b>KWHS095-S</b>	1.6mm x 100mm	<b>KWHS132-S</b>	2.0mm x 125mm
<b>KWHS146-S</b>	1.0mm x 140mm	<b>KWHS0010B-S</b>	1.2mm x 150mm	<b>KWHS113-S</b>	1.6mm x 115mm	<b>KWHS150-S</b>	2.0mm x 140mm
<b>KWHS0010A-S</b>	1.0mm x 150mm	<b>KWHS165-S</b>	1.2mm x 180mm	<b>KWHS131-S</b>	1.6mm x 125mm	<b>KWHS0013-S</b>	2.0mm x 150mm
<b>KWHS164-S</b>	1.0mm x 180mm	<b>KWHS183-S</b>	1.2mm x 200mm	<b>KWHS149-S</b>	1.6mm x 140mm	<b>KWHS168-S</b>	2.0mm x 180mm
<b>KWHS182-S</b>	1.0mm x 200mm			<b>KWHS0012-S</b>	1.6mm x 150mm	<b>KWHS186-S</b>	2.0mm x 200mm
				<b>KWHS167-S</b>	1.6mm x 180mm		
				<b>KWHS185-S</b>	1.6mm x 200mm		

## STAPLES, NUTS AND WASHERS

### Staples

material conforms to BS 7252: Part 1: 1997. ISO 5832-1: 1997. Comp.D.  
various lengths and widths available



**Straight staple**

**SC-OR/1650**

1.0, 2.4, 3.2mmø



**Barbed staple**

**SC-OR/1655**



**Stepped staple**

**SC-OR/1660**



**U shaped staple**

**SC-OR/1665**



**U shaped staple**

for epiphysis

**SC-OR/1670**



**U shaped staple**

for epiphysis, toothed

**SC-OR/1675**



**angled staple**

**SC-OR/1680**



**angled staple**

toothed

**SC-OR/1685**

### Nuts

4.5mm Ø for cortical screws



**SC-OR/0262-045**

Ø 11mm HEXAGON Ø 8mm

**SC-OR/0453-021**

Spanner for use with OR/0262-045

### Washers



**SC-OR/0263-045** 4.5mm Ø, mini

**SC-OR/0263-070** 7.0mm Ø, medium

**SC-OR/0263-130** 13mm Ø, large

## LEAD HANDS

---

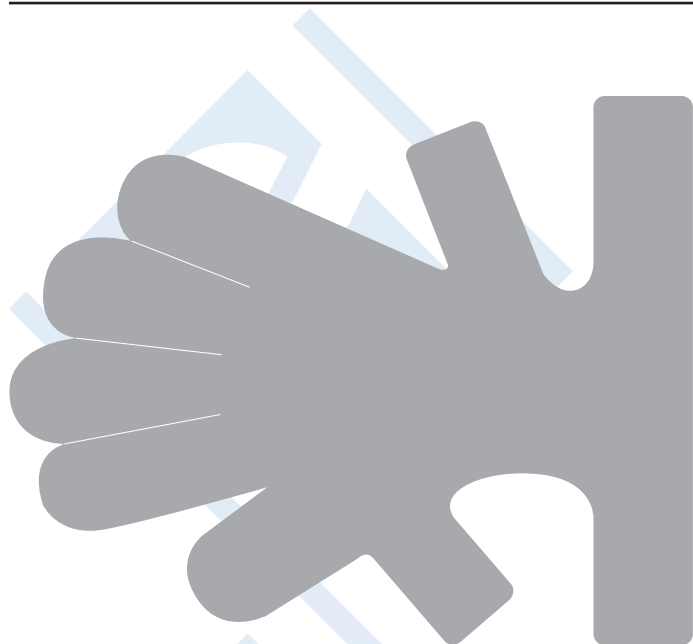

### Lead hand

1.8mm gauge

**SC-SH/128000** for adult

**SC-SH/5483** for child

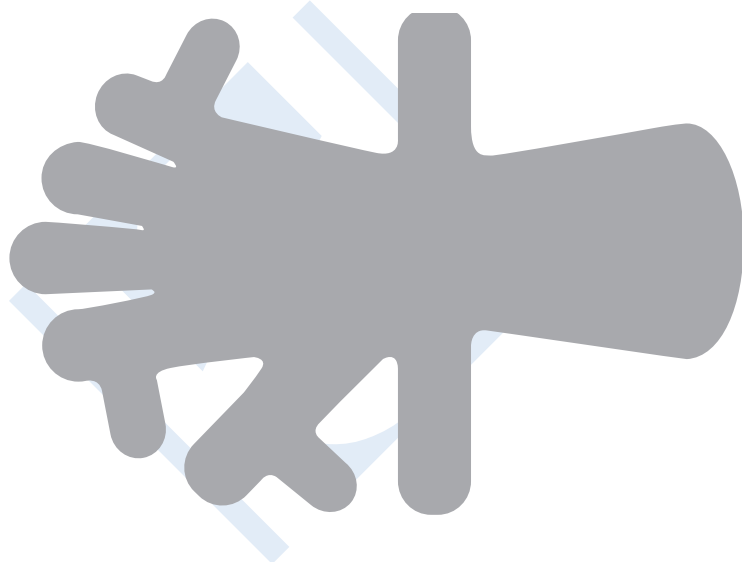
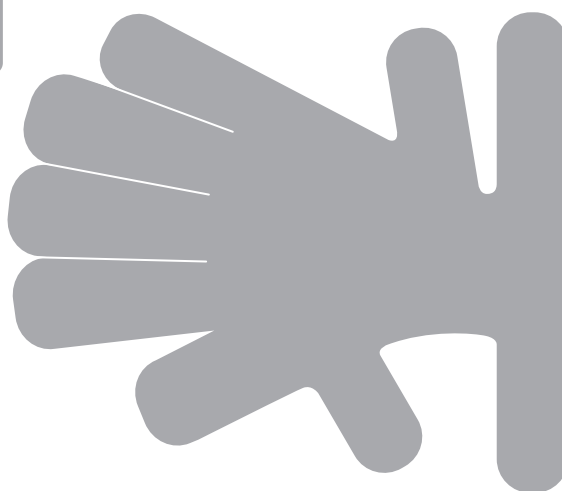

### Lead hand

Chelsea and Westminster pattern

**SC-SH/128001** 2.5mm gauge