

***Fair-Play***

---

**A TRANS·LUX® COMPANY**

**FOOTBALL LED SCOREBOARD  
INSTRUCTION MANUAL**

REVISION DATE: 10-13-08

PART#: 98-0004-02

# *Fair-Play*

**A TRANS·LUX® COMPANY**

## **SERVICE & CUSTOMER INFORMATION**

CUSTOMER MUST HAVE PART NUMBER WHEN ORDERING ITEMS THROUGH THE SERVICE DEPARTMENT.

IF FURTHER HELP IS NEEDED CONTACT A FAIR-PLAY SERVICE REP IN YOUR FAIR-PLAY DEALER ORGANIZATION OR PHONE THE FAIR-PLAY HELP DESK AT (800) 462-2716.

TO AID YOU IN YOUR DISCUSSIONS WITH SERVICE REPS, WE SUGGEST THAT YOU RECORD THE FOLLOWING:

MODEL NUMBER: \_\_\_\_\_

FAIR-PLAY SALES ORDER NUMBER: \_\_\_\_\_  
(THIS NUMBER IS FOUND IN THE UPPER RIGHT HAND CORNER OF THE PACKING SLIP AND INVOICE.)

INSTALLATION DATE: \_\_\_\_\_

WARRANTY: A COPY OF THE **FIVE-YEAR LIMITED WARRANTY** IS ENCLOSED.

# FAIR-PLAY SCOREBOARDS

DES MOINES, IOWA

INSTRUCTION DRAWING LIST

## **STANDARD FOOTBALL LED SCOREBOARDS**

TABLE OF CONTENTS

DESCRIPTION	DRAWING NUMBER
FOOTBALL LED SCOREBOARD FACE VIEWS.....	01-0009-07 01-0009-13 01-0009-08 01-0009-09 01-0009-10 01-0009-11 01-0009-12
INSTALLATION INSTRUCTIONS FOR LED SCOREBOARDS.....	98-0000-03
COLUMN & STRINGER ASSEMBLY MAX. 27'-0" X 8'-0" SIZE.....	01-0019-01
COLUMN & STRINGER ASSEMBLY MAX. 32'-0" X 8'-0" SIZE.....	01-0019-02
COLUMN & STRINGER ASSEMBLY MAX. 36'-0" X 8'-0" SIZE.....	01-0019-03
SCOREBOARD CARE - OFF SEASON.....	EL-1527
GROUNDING INSTRUCTIONS.....	E-6-4923
TYPICAL 2 COLUMN FOOTBALL ELECTRICAL INSTALLATION.....	01-0009-06
TYPICAL OUTDOOR PROCESSOR WIRING.....	12-0004-01
TYPICAL LED OUTDOOR DIGITS & BALL POSSESSION WIRING.....	12-0003-01
TYPICAL LED OUTDOOR H/E, FIG. 1'S, SPOTS WIRING.....	12-0003-01-1
OUTDOOR DATA HOOK-UP BOX ASSY WITH SURGE ARRESTOR (REQ'D. FOR WIRED MODELS)...	16-5002-01
SWITCH LABEL FOR H410-REV2B SCBD/TEAM NAME.....	12-0013-03
TYPICAL WIRING TEAM NAME.....	24-3000-01
TYPICAL CONNECTIONS FOR DIRECT WIRED or WIRELESS(RF) TEAM NAME CONVERTER BOX...	06-1013-04
COLUMNS AND FOOTINGS CHARTS.....	98-0029-01
CHART FOR SCOREBOARD DETAILS & TYPICAL INSTALLATION	
TROUBLE SHOOTING FOR OUTDOOR SCOREBOARDS.....	01-0008-03
WARRANTY	

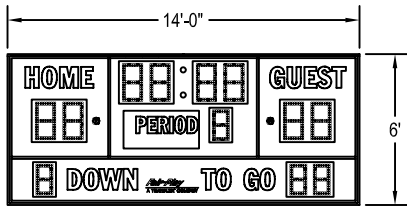

FB-8114-2

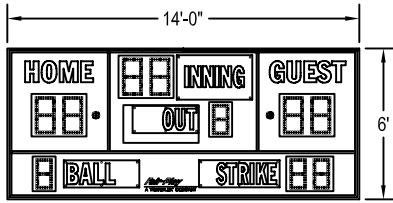

FB-8114-2 (WITH BASEBALL CAPTIONS)

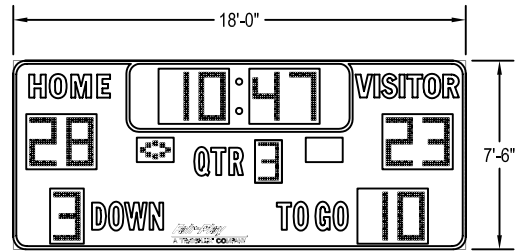

FB-8218-2

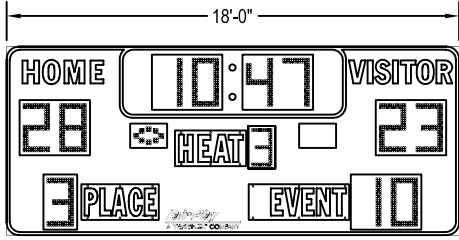

FB-8218-2 (WITH TRACK CAPTIONS)

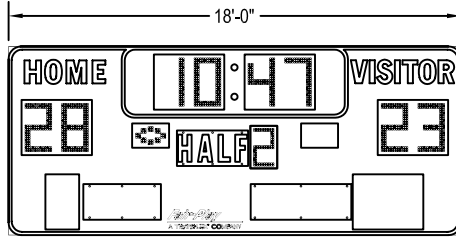

FB-8218-2 (WITH SOCCER CAPTIONS)

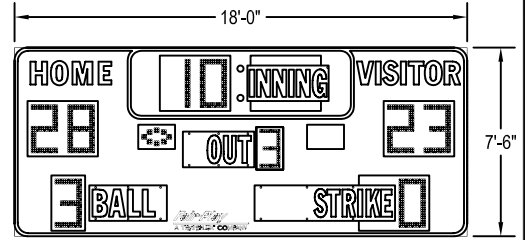

FB-8218-2 (WITH BASEBALL CAPTIONS)

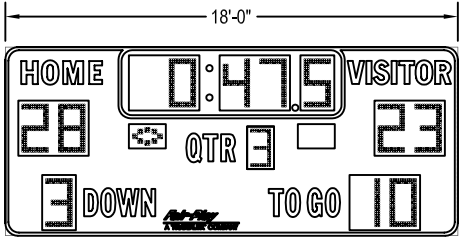

FB-8218TK-2

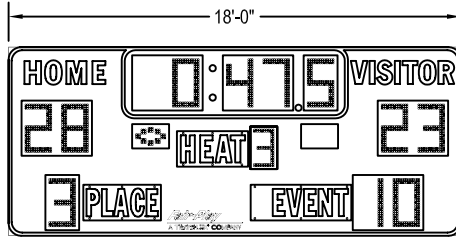

FB-8218TK-2 (WITH TRACK CAPTIONS)

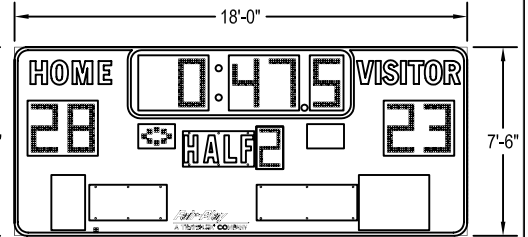

FB-8218TK-2 (WITH SOCCER CAPTIONS)

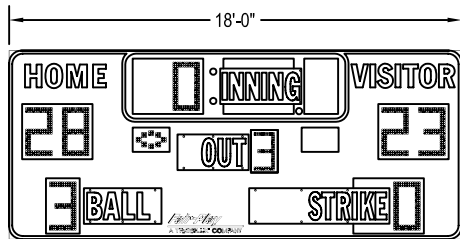

FB-8218TK-2 (WITH BASEBALL CAPTIONS)

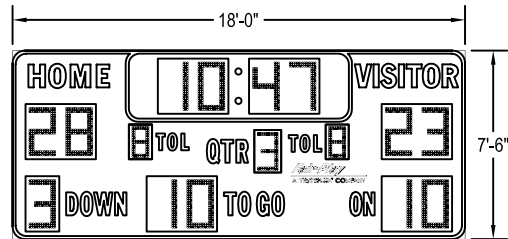

FB-8318-2

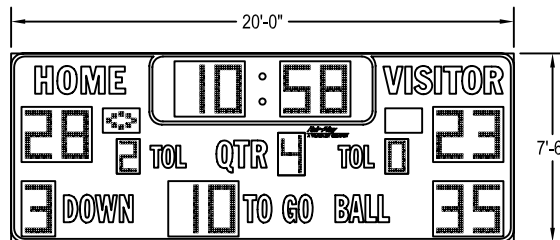

FB-8120-2

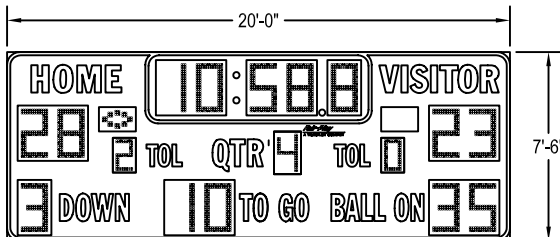

FB-8120TK-2, FB-8120TK-40L-2 (8 X 40, 1.375" LED CAPTIVE TEAM NAME NOT SHOWN)

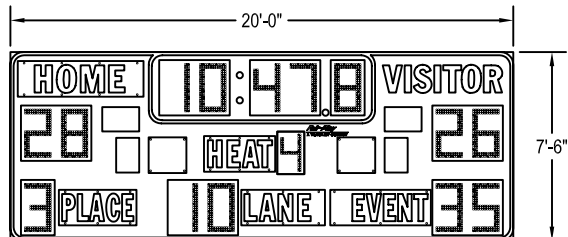

FB-8120TK-2 (WITH TRACK CAPTIONS)

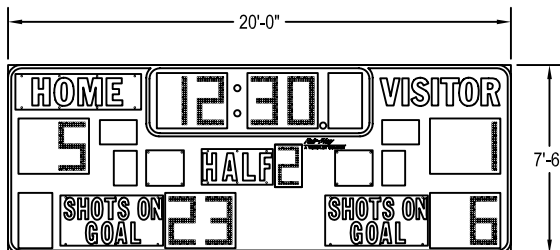

FB-8120TK-2 (WITH SOCCER CAPTIONS)

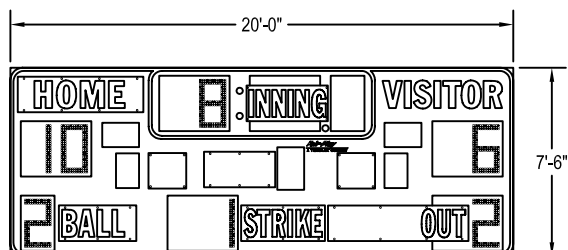

FB-8120TK-2 (WITH BASEBALL CAPTIONS)

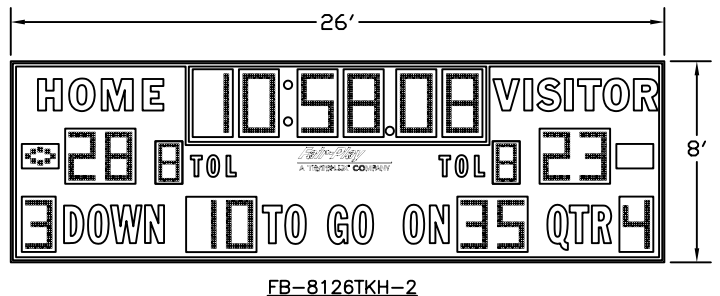
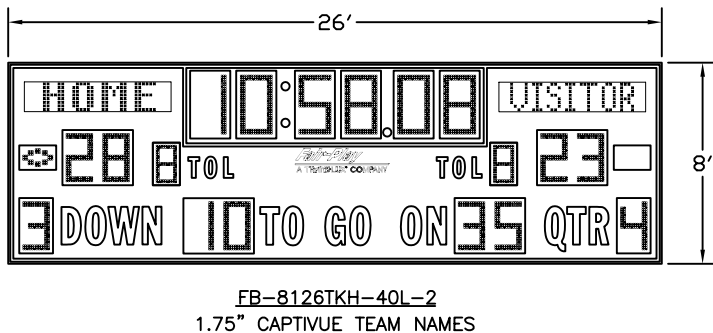
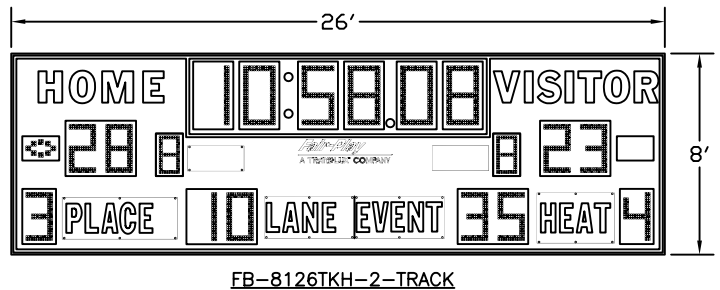
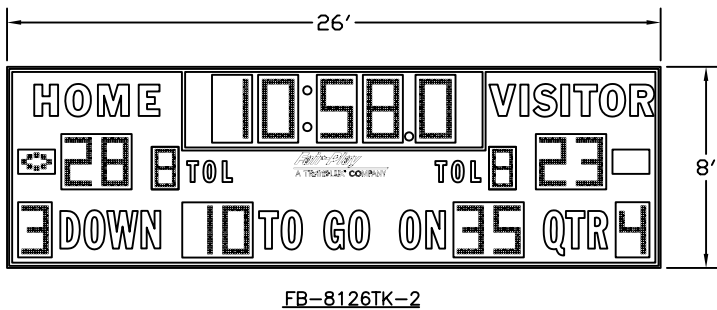
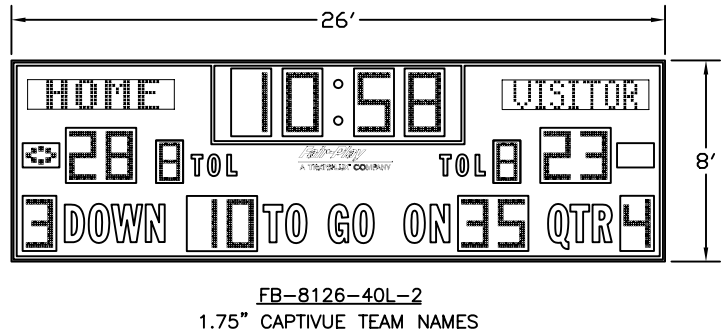
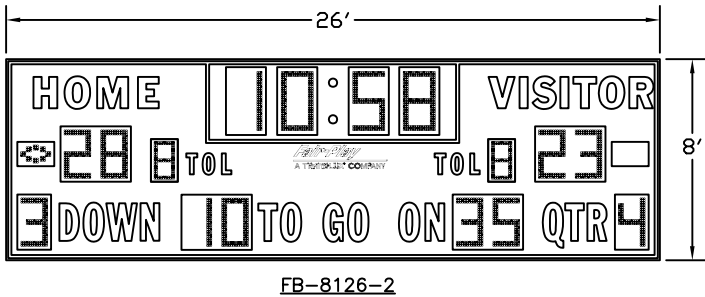
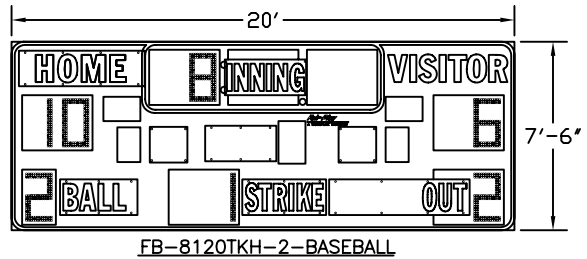
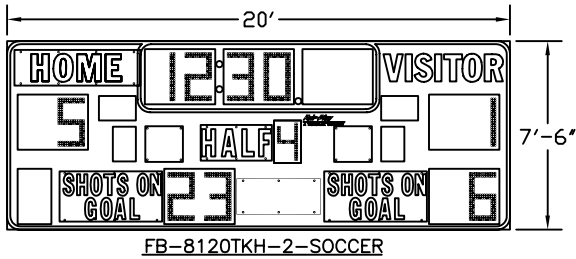
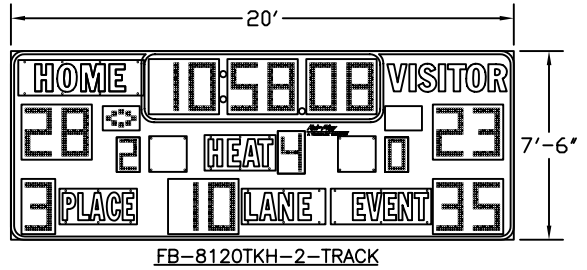
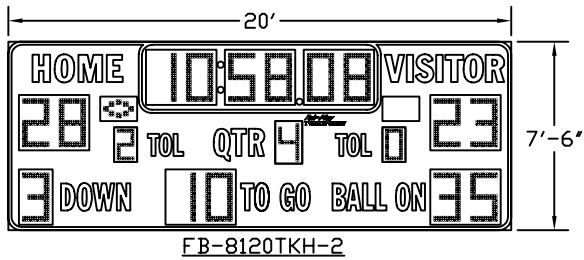

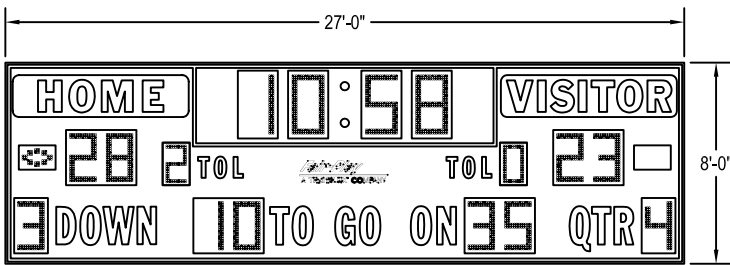

FB-8127-2

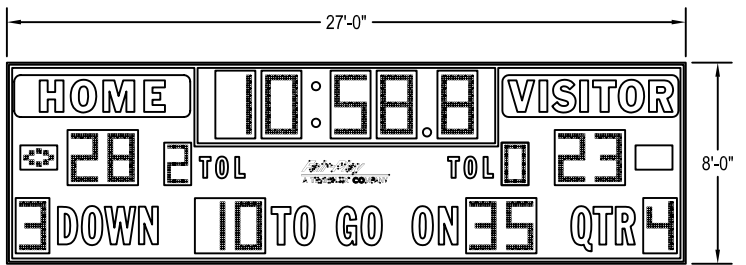

FB-8127TK-2

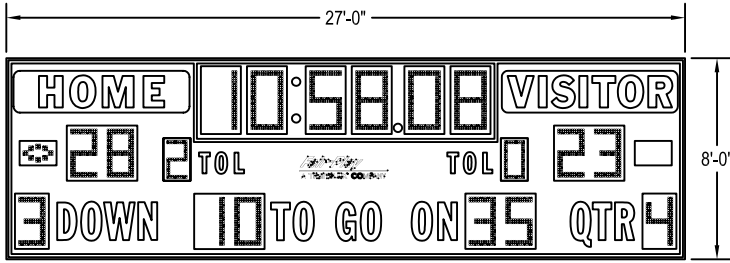

FB-8127TKH-2

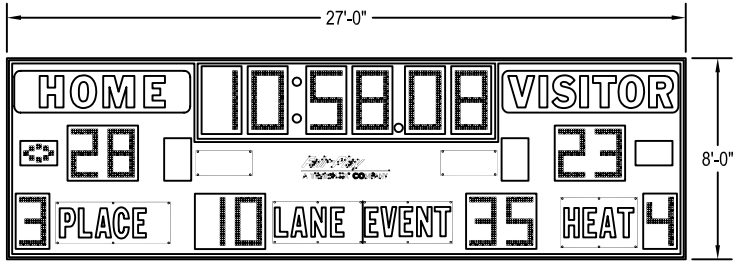

FB-8127TKH-2 (WITH TRACK CAPTIONS)

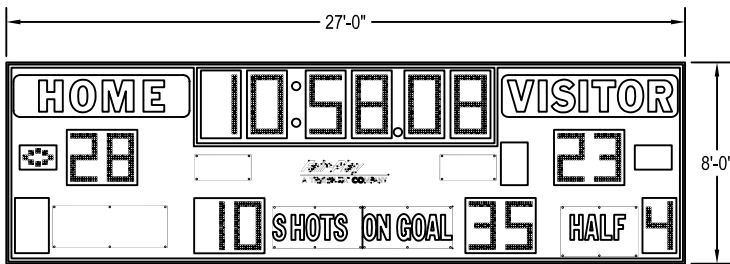

FB-8127TKH-2 (WITH SOCCER CAPTIONS)

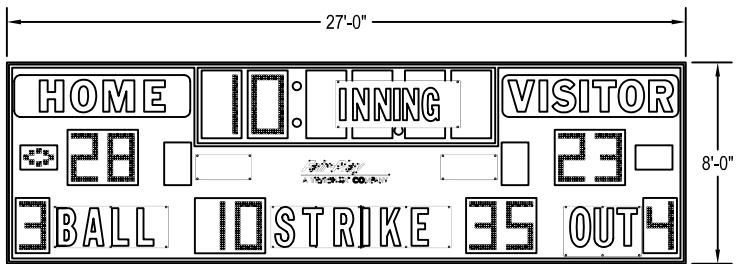

FB-8127TKH-2 (WITH BASEBALL CAPTIONS)

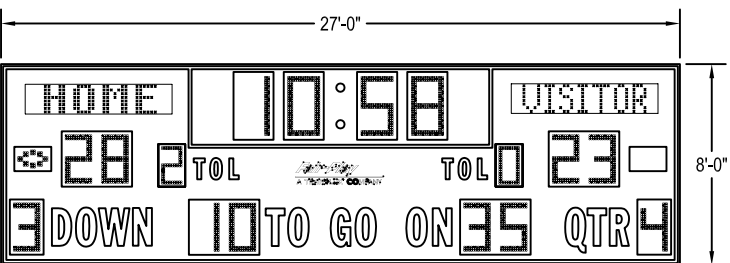

FB-8127-40L-2  
1.75" CAPTIVUE TEAM NAMES

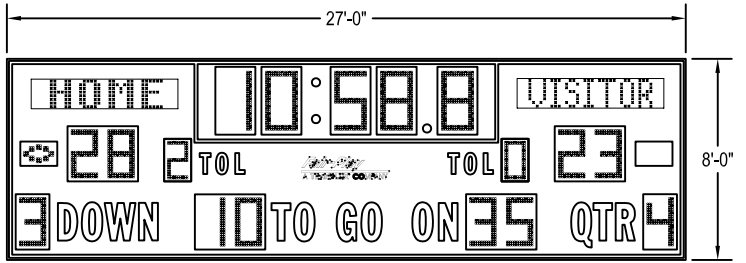

FB-8127TK-40L-2  
1.75" CAPTIVUE TEAM NAMES

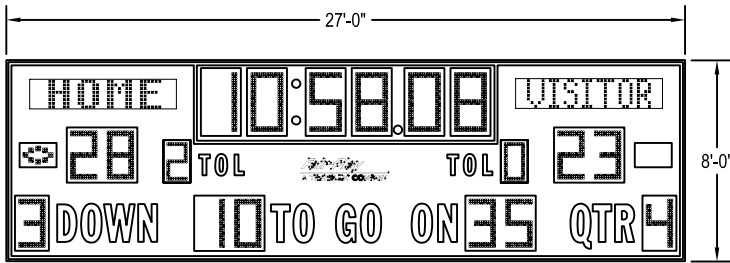

FB-8127TKH-40L-2  
1.75" CAPTIVUE TEAM NAMES

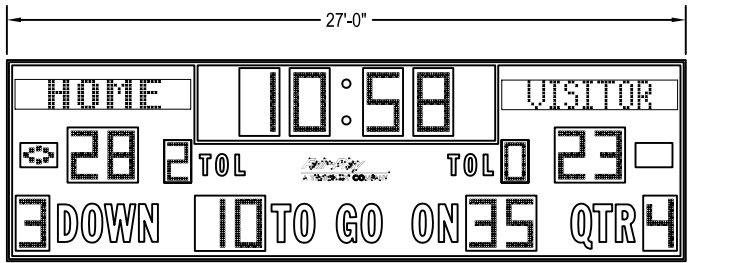

FB-8127-48L-2  
1.75" CAPTIVUE TEAM NAMES

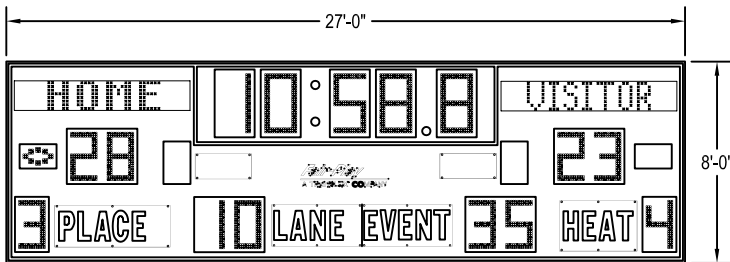

FB-8127TK-48L-2  
1.75" CAPTIVUE TEAM NAMES

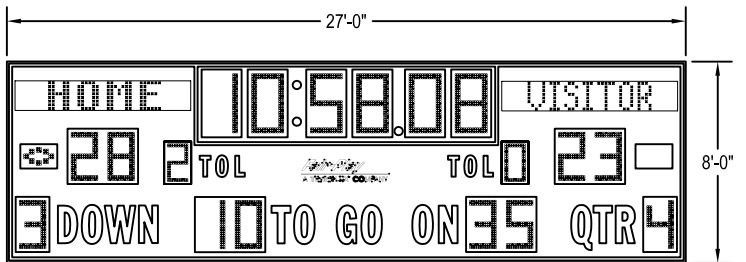

FB-8127TKH-48L-2  
1.75" CAPTIVUE TEAM NAMES

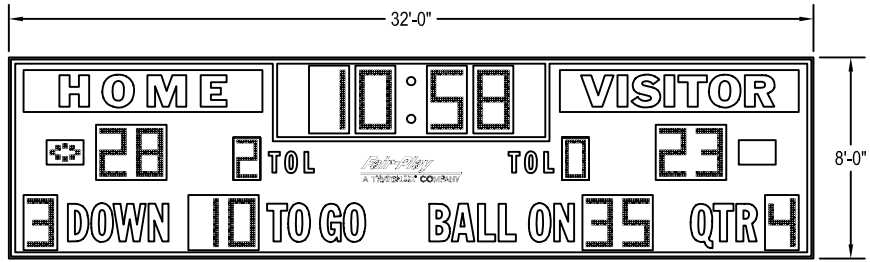

FB-8132-2

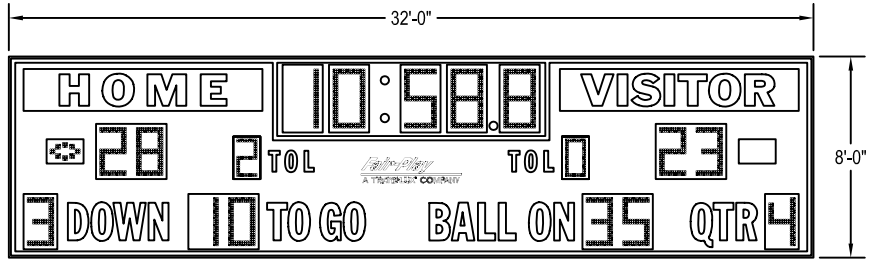

FB-8132TK-2

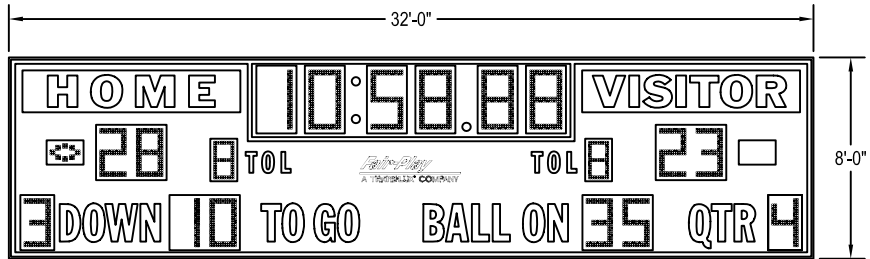

FB-8132TKH-2

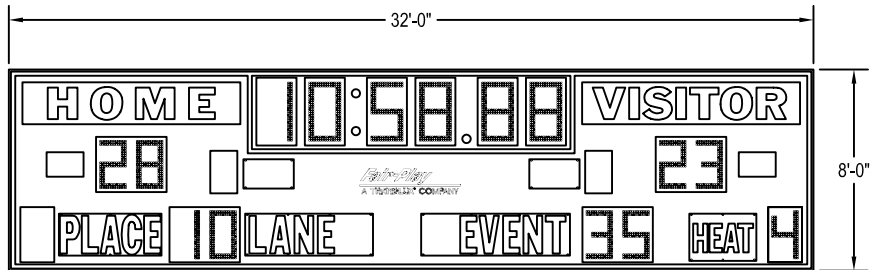

FB-8132TKH-2 (WITH TRACK CAPTIONS)

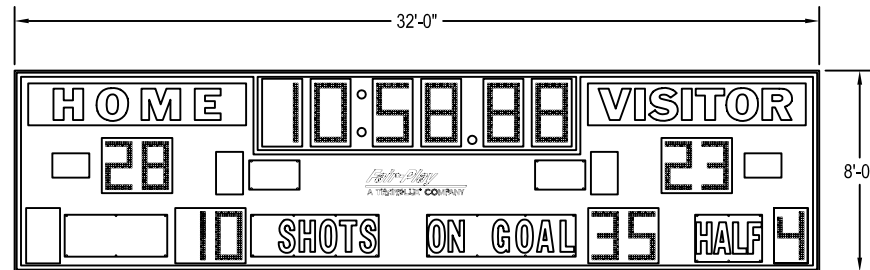

FB-8132TKH-2 (WITH SOCCER CAPTIONS)

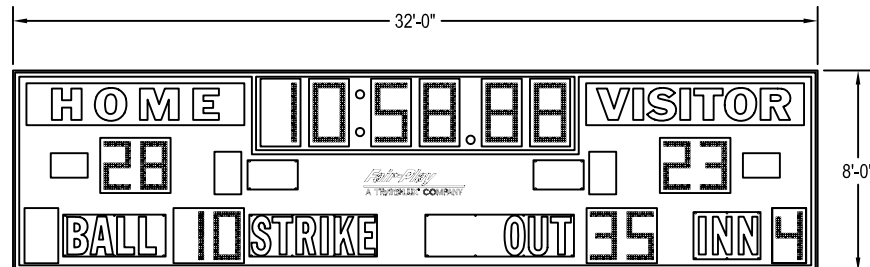

FB-8132TKH-2 (WITH BASEBALL CAPTIONS)

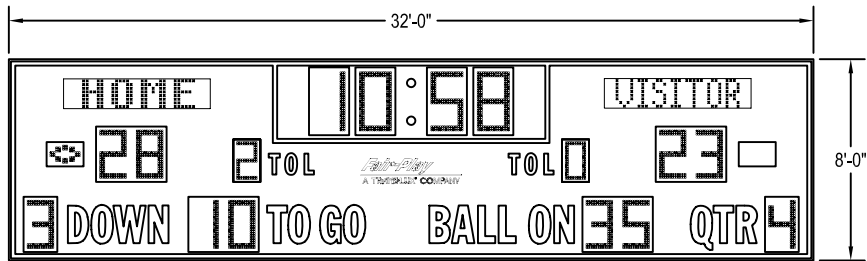

FB-8132-40L-2  
1.75" CAPTIVUE TEAM NAMES

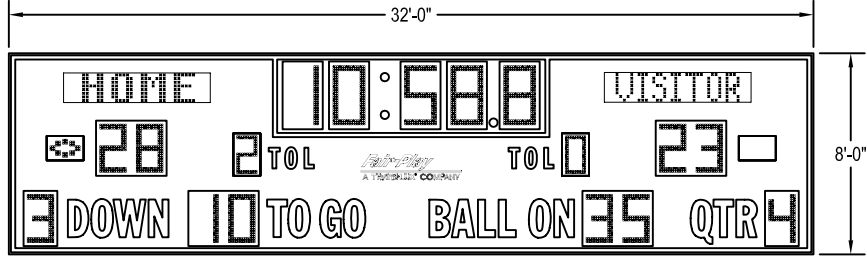

FB-8132TK-40L-2  
1.75" CAPTIVUE TEAM NAMES

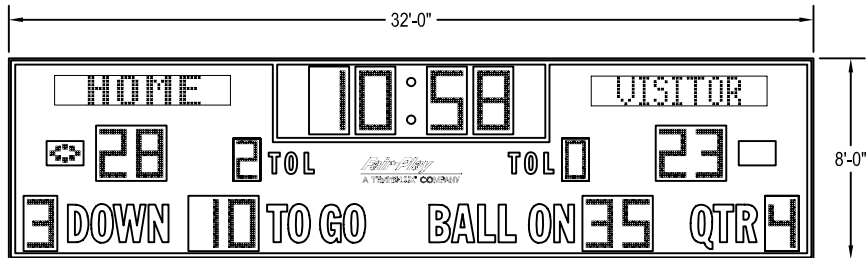

FB-8132-48L-2  
1.75" CAPTIVUE TEAM NAMES

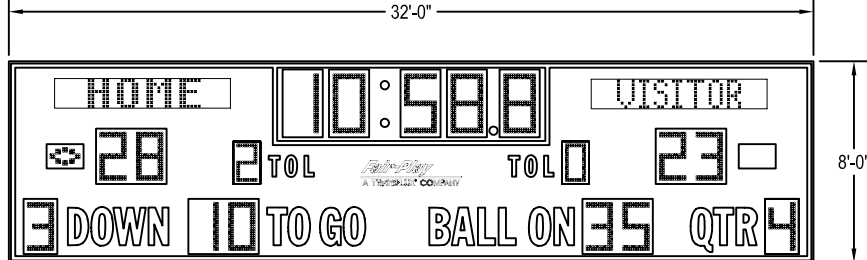

FB-8132TK-48L-2  
1.75" CAPTIVUE TEAM NAMES

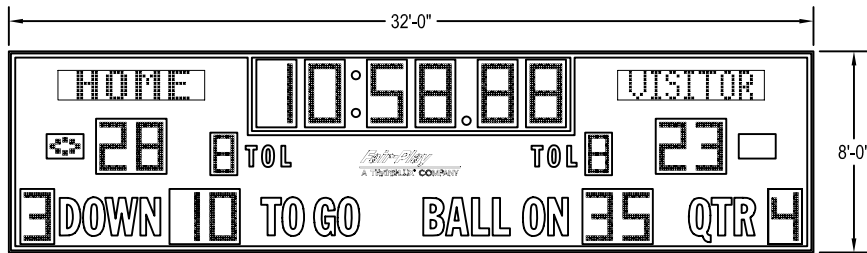

FB-8132TKH-40L-2  
1.75" CAPTIVUE TEAM NAMES

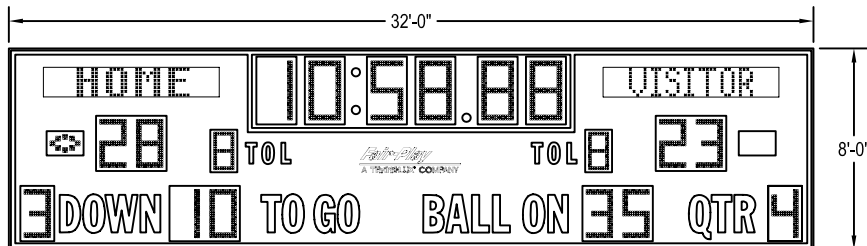

FB-8132TKH-48L-2  
1.75" CAPTIVUE TEAM NAMES



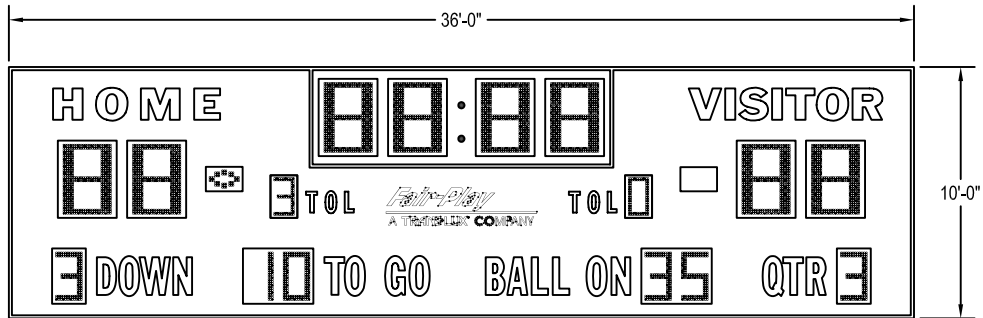

FB-8136-2

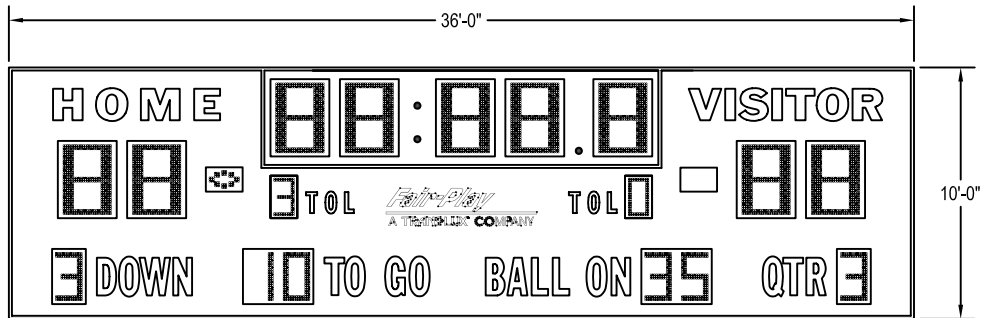

FB-8136TK-2

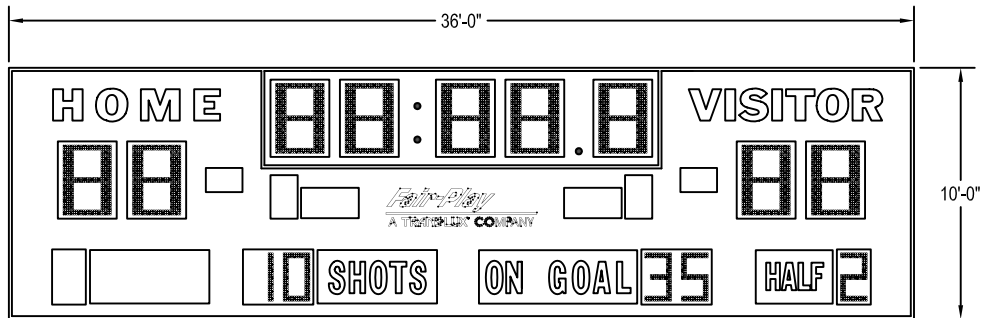

FB-8136TK-2 (WITH SOCCER CAPTIONS)

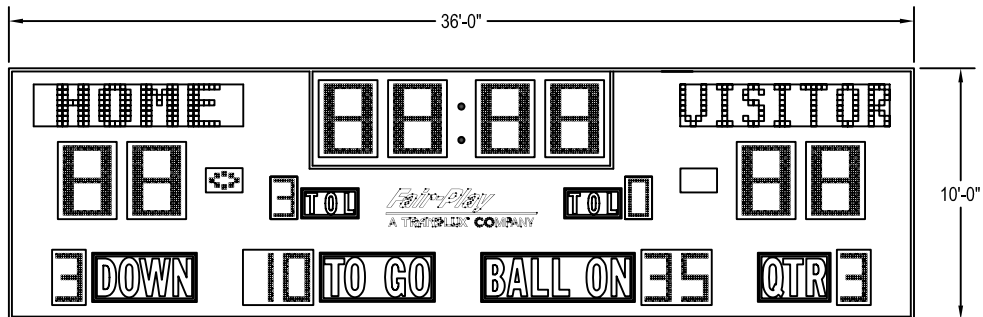

FB-8136-40L-2

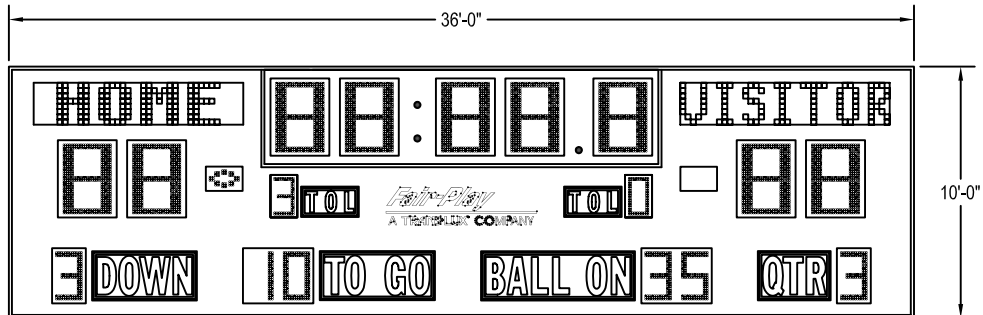

FB-8136TK-40L-2

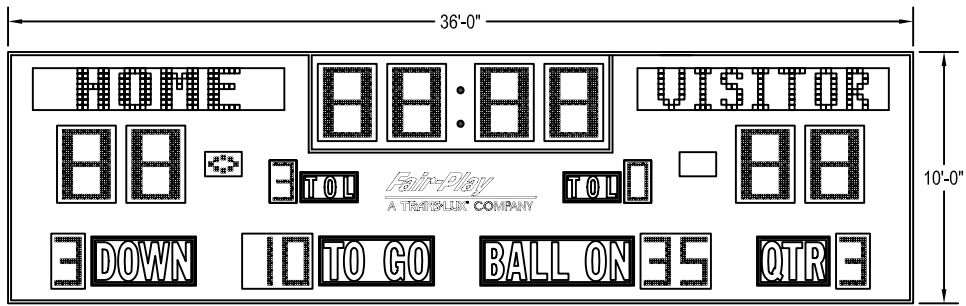

FB-8136-48L-2

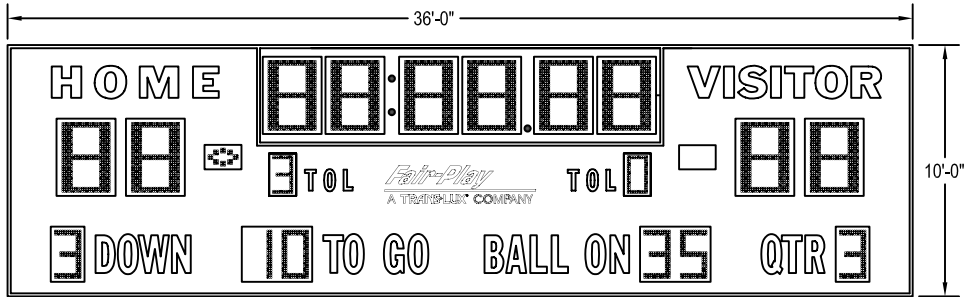

FB-8136TKH-2

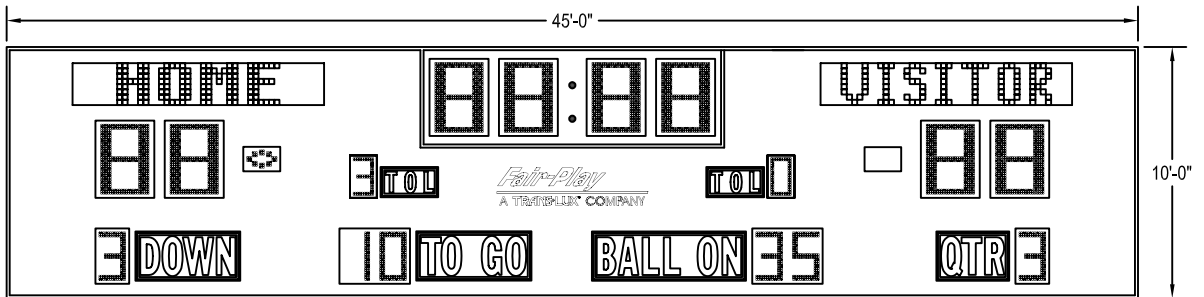

FB-8145-48L-2

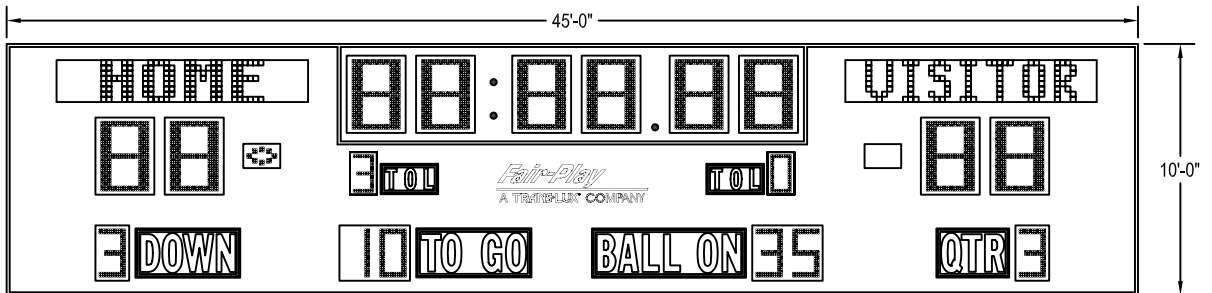

FB-8145TKH-48L-2

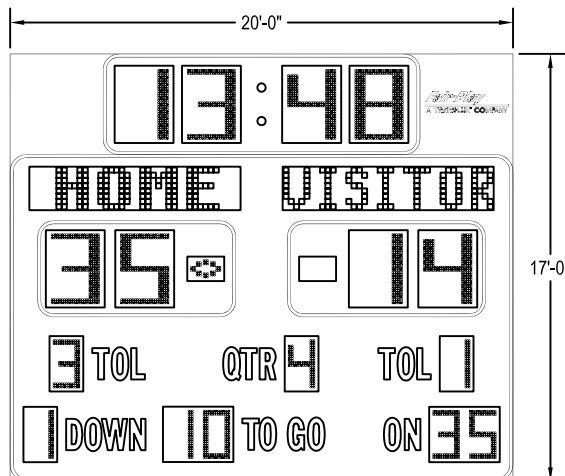

FB-8165-40L-2

## INSTALLATION INSTRUCTIONS - LED SCOREBOARDS

98-0000-03

### FAIR-PLAY SCOREBOARDS DES MOINES, IOWA

LOCATION - The scoreboard may be positioned to face any direction so that the spectators and the operator can see it. For maximum visibility, place it at a south or west end of the field so that the sun does not shine directly on the face of the board during afternoon games.

ERECTION - The scoreboard is usually mounted on either two, three, or four columns, spaced as shown on the installation drawing enclosed. Steel columns set in concrete are recommended, but other types of supports may be used. The size of the columns and concrete bases shown are designed to withstand 80 mph winds in average soil with allowable stresses of 2500 PSF. The design should be altered to take into account your soil conditions; the height of the scoreboard above the ground; and to comply with local codes which specify wind load requirements, etc.

The weight and dimensions of your scoreboard are also shown on the installation drawing. The scoreboard can be easily lifted into place using a crane or boom truck such as used by utilities and sign companies. U-bolts or eyebolts are included on the top edge of the board. Hook the slings or spreader bar cables into these bolts when lifting the board. The eyebolts may be removed after the scoreboard is secured to the supports. **Caution: If eyebolts are removed, plug open holes in scoreboard or water damage will occur and warranty will be void.** The board is to be bolted or welded to the supports at each hanger position.

- Water Ingress: No additional penetrations may be created in the product unless they are sealed per Nema 4 Standard. All field penetrations must be tested using a stream of water poured from a container located not less than 6" away horizontally. Warranty will be void if this testing is not completed during installation, or if there is water ingress from field modifications. Any cabinets located above the product must not allow water to build up and then flow through conduits into the product. Penetrations between product and higher cabinets must be sealed between the cabinet internal spaces using water tight cable to conduit seals. Holes remaining from eye bolt removal must be filled, sealed and tested.
- Ventilation: Install product so that air flow is not restricted. Customer's structure must allow for the free flow of outside ambient air to the product, without recirculation of air. Warranty will be void if components fail due to air flow restrictions.

POWER - Your scoreboard is wired for connection to a 120 volt single phase; two wire grounded power supply, as shown on the installation drawing enclosed.

All split cabinets require wires be routed to the power supplies to operate all sections.

The total power required, when all LED's are turned on, is given in watts on the installation drawing. A fused disconnect is required and is usually mounted on one of the support columns within view of the scoreboard face.

CONTROL CABLE - A single two wire shielded control cable is required from the point where the control is located, to the junction box in the scoreboard. It should be installed in conduit (1/2" or larger) for mechanical protection. Care should be taken when soldering the cable to the control connectors.

GROUND WIRE - The proper grounding of the electrical circuits and the scoreboard structure are important aspects of any installation. Refer to drawing E-6-4923 for suggestions on grounding the circuits in accordance with the National Electric Code.

CONTROL - A control console is supplied complete with a power cable and a control cable to connect the control to the receptacle box. A 120 volt two wire grounded outlet is required, which should be a DEDICATED CIRCUIT at the scoreboard control point. Battery operation available.

The control must be operated and stored in a dry location.

HORN - (Optional) Horns are shipped separate and installed by customer. Ref. 98-0020-01 for horn installation instructions.

**Horns should not be supplied by others and attached to the scoreboard without the written approval of the Fair-Play Engineering Department. Electrical loads imposed by unauthorized horns may damage the circuits and nullify the warranty. NOTE: Horns are not available on all models.**

If you need additional help, contact a Service Rep in your Fair-Play dealer organization or phone the Fair-Play Help Desk (800) 462-2716.

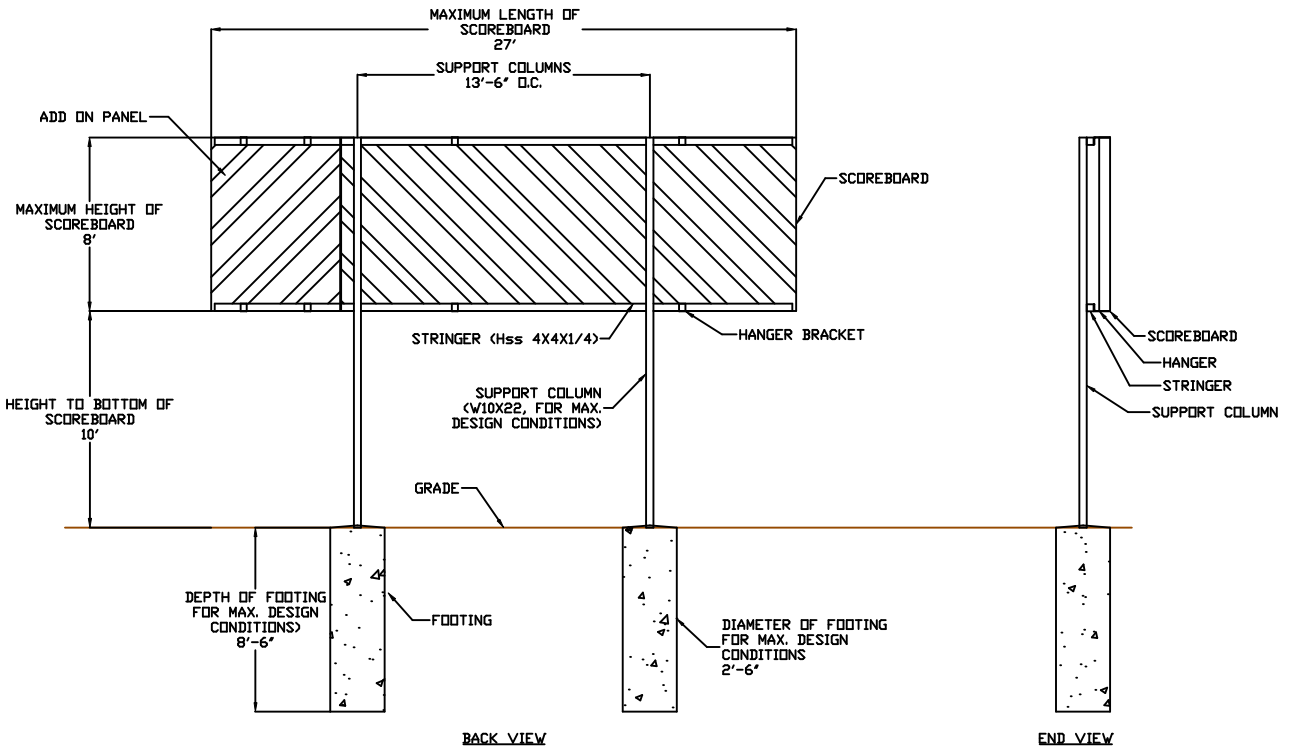

#### DESIGN CRITERIA:

1. CODES  
UNIFORM BUILDING CODE, 1997  
AMERICAN CONCRETE INSTITUTE 318-89  
AMERICAN INSTITUTE OF STEEL CONSTRUCTION - ASD 1989
2. LATERAL LOADS:  
SEISMICITY: SEISMIC ZONE 0  
BASIC WIND SPEED: 80 MPH  
EXPOSURE: C  
DESIGN WIND PRESSURE: 30.0 psf

#### GENERAL NOTES:

1. THE CONTRACT STRUCTURAL DRAWINGS AND SPECIFICATIONS REPRESENT THE FINISHED STRUCTURE. THEY DO NOT INDICATE THE MEANS OR METHODS OF CONSTRUCTION.
2. TRANS-LUX CORPORATION AND OR ANY OF ITS SUBSIDIARIES ASSUMES NO RESPONSIBILITY FOR WORK COMPLETED BY OTHERS.
3. FIELD VERIFY ALL EXISTING DIMENSIONS, MEMBER SIZES, AND ELEVATION SHOWN ON THE DRAWINGS. ALL DISCREPANCIES SHALL BE BROUGHT TO THE ATTENTION OF THE ENGINEER IMMEDIATELY.
4. ANY ENGINEERING DESIGN PROVIDED BY OTHERS AND SUBMITTED FOR REVIEW OR RECORD SHALL BEAR THE STAMP AND SIGNATURE OF A PROFESSIONAL STRUCTURAL ENGINEER REGISTERED IN THE STATE OF INSTALLATION.

#### CONSTRUCTION PROCEDURES AND SAFETY REQUIREMENTS:

1. COMPLY WITH ALL APPLICABLE CITY, COUNTY, STATE AND FEDERAL LAWS AND REGULATIONS ADOPTED PURSUANT THERETO.
2. PROVIDE ALL MEASURES NECESSARY TO PROTECT THE WORKMEN AND OTHER PERSONS DURING CONSTRUCTION. PROVIDE ALL NECESSARY MEASURES TO AVOID EXCESSIVE STRESSES AND TO HOLD THE STRUCTURAL ELEMENTS IN PLACE DURING CONSTRUCTION. SUCH MEASURES SHALL INCLUDE, BUT NOT BE LIMITED TO, BRACING; SHORING FOR CONSTRUCTION EQUIPMENT; SCAFFOLDING; SAFETY NETS; SUPPORT AND BRACING FOR CRANES AND HOISTS; GUYING, ETC.

#### CONCRETE AND REINFORCING STEEL:

1. ALL CONCRETE WORK SHALL CONFORM TO THE LATEST EDITION OF THE AMERICAN CONCRETE INSTITUTE PUBLICATIONS: ACI 301, ACI 311, ACI 315, ACI 318, ACI 437, ACI 304; UNLESS OTHERWISE NOTED ON THE DRAWINGS.
2. ALL CONCRETE SHALL HAVE A MINIMUM ULTIMATE COMPRESSIVE STRENGTH OF 3000 P.S.I. AT 28 DAY TEST.
3. CONCRETE SHALL CONSIST OF THE FOLLOWING:  
ASTM A150 TYPE 1 PORTLAND CEMENT  
ASTM C33 NORMAL WEIGHT AGGREGATES  
NO CHLORIDES SHALL BE ALLOWED IN THE CONCRETE MIX.
4. CONCRETE THAT WILL BE SUBJECTED TO REPEATED FREEZE-THAW CYCLES DURING THE STRUCTURE'S LIFE SHALL HAVE A WATER-CEMENT RATIO NO EXCEEDING 6 GALLONS PER BAG AND SHALL CONTAIN ENTRAINED AIR. SEE ACI 301 FOR ADDITIONAL REQUIREMENTS.
5. MECHANICALLY VIBRATE CONCRETE AT TOPS OF DRILLED PIERS.

#### STRUCTURAL STEEL:

1. STRUCTURAL STEEL MATERIAL SHALL BE ASTM:  
A572 (50KSI) ROLLED W-SHAPE COLUMNS  
A36 CONNECTION MATERIAL AND STIFFENER PLATES  
A36 ROLLED SECTIONS AND PLATE
2. STRUCTURAL STEEL DETAILS, FABRICATION, AND ERECTION SHALL CONFORM TO THE AISC "MANUAL OF STEEL CONSTRUCTION - ASD" LATEST EDITION. UNLESS OTHERWISE SHOWN OR SPECIFIED.
3. ALL STRUCTURAL TUBE ENDS TO BE COVERED WITH LIGHT GAGE END CAPS.
4. ALL NEW STEEL TO BE PRIMED AND PAINTED WITH AN APPROVED COLOR.
5. ALL WELDING SHALL BE DONE BY CERTIFIED WELDERS WITH EXPERIENCE AND CERTIFICATION IN THE TYPES OF WELDING CALLED FOR. CERTIFICATES SHALL BE NOT MORE THAN 6 MONTHS OLD AND SHALL BE THOSE ISSUED BY AN ACCEPTABLE TESTING AGENCY.
6. ALL WELDS SHALL BE E70XX ELECTRODES, AND SHALL BE PRIMED AND PAINTED WITH AN APPROVED COLOR.
7. UNLESS OTHERWISE NOTED, ALL WELDS SHALL BE CONTINUOUS 1/4" FILLET WELDS. ALL FULL AND/OR PARTIAL PENETRATION WELDS SHALL BE FULLY DETAILED ON THE SHOP DRAWINGS.
8. ALL FIELD WELDING SHALL BE PERIODICALLY INSPECTED AND CERTIFIED BY AN A QUALIFIED INDEPENDENT TESTING FIRM AS CALLED FOR UNDER THE "SPECIAL INSPECTIONS" PORTION OF THE UNIFORM BUILDING CODE, 1997.

#### DRILLED PIERS:

1. SOIL IS ASSUMED TO BE AVERAGE WITH MAXIMUM ALLOWABLE LATERAL BEARING STRESS OF 150 PSF/FT AND MAXIMUM ALLOWABLE AXIAL BEARING STRESS OF 1500 PSF.
3. ALL DRILLED PIERS SHALL BEAR ON AN UNDISTURBED SOIL.
4. PROVIDE FOR DEWATERING AT EXCAVATIONS FROM EITHER SURFACE WATER OR SEEPAGE.
5. THE ELEVATION IDENTIFYING THE BOTTOM OF SHAFT IS AN APPROXIMATE LENGTH FOR ESTIMATING PURPOSES ONLY. THE ACTUAL LENGTH WILL BE DETERMINED IN THE FIELD FROM THE ACTUAL ELEVATION OF THE BEARING STRATUM TO BE VERIFIED BY THE ON-SITE SOILS TESTING AGENCY.
6. CONCRETE SHALL BE PLACED IMMEDIATELY AFTER SHAFTS ARE CLEANED, DATA IS RECORDED AND APPROVAL OF BEARING SURFACE IS OBTAINED. EXCAVATIONS SHALL NOT BE LEFT OPEN OVERNIGHT.
7. BEARING CAPACITY SHALL BE VERIFIED BY THE ON-SITE SOILS TESTING AGENCY. REMOVAL OF DEBRIS FROM THE BOTTOM OF THE SHAFT SHALL BE DONE BY MECHANICAL METHODS AND NOT BY THE TRADE CONTRACTOR'S PERSONNEL. AT NO TIME SHALL ANY FIELD PERSONNEL ACCESS DRILLED PIER EXCAVATIONS.
8. ALL PIERS SHALL BE CENTERED UNDER COLUMNS.
9. ALL DRILLED PIER INSTALLATIONS AND CONCRETE PLACEMENT SHALL BE INSPECTED AND CERTIFIED BY A QUALIFIED SPECIAL INSPECTOR AS CALLED FOR UNDER THE "SPECIAL INSPECTION" PORTION OF THE UNIVERSAL BUILDING CODE, 1997.

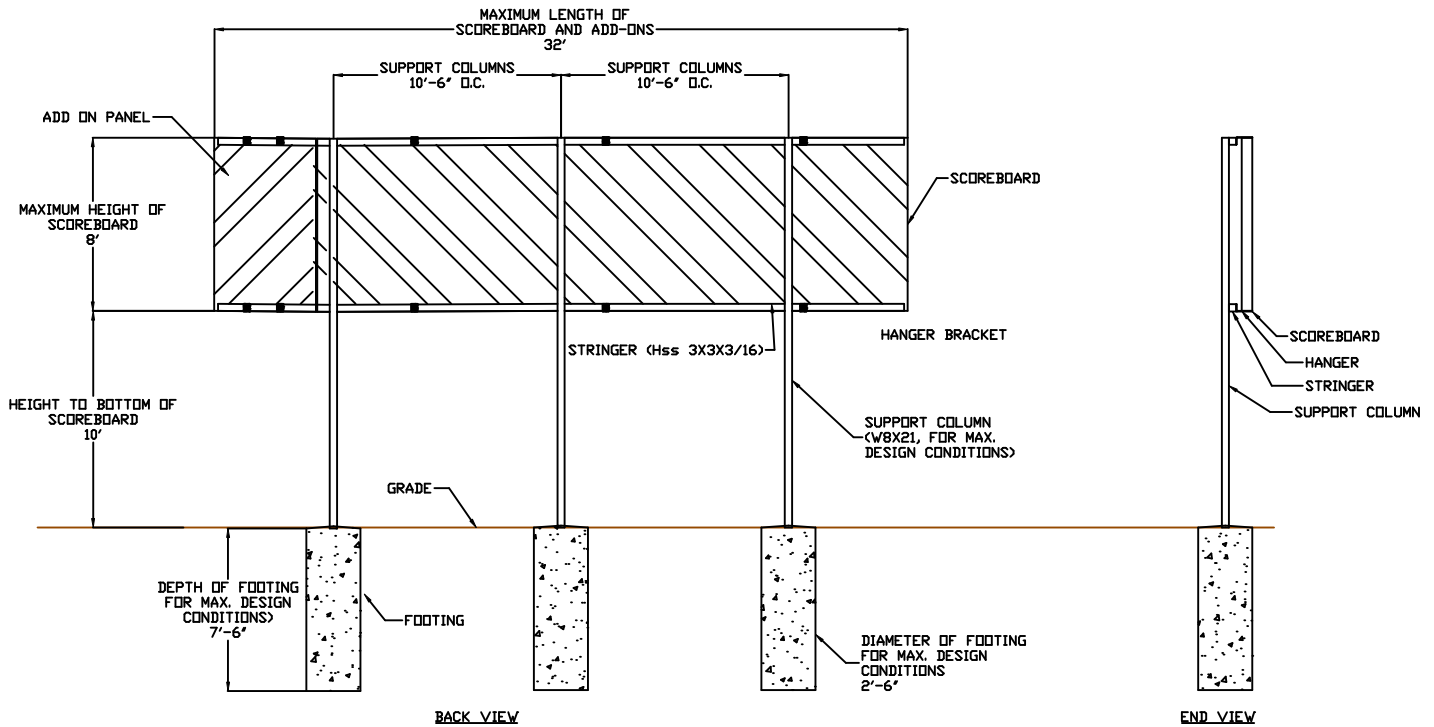

#### DESIGN CRITERIA:

1. CODES  
UNIFORM BUILDING CODE, 1997  
AMERICAN CONCRETE INSTITUTE 318-89  
AMERICAN INSTITUTE OF STEEL CONSTRUCTION - ASD 1989

2. LATERAL LOADS:  
SEISMICITY: SEISMIC ZONE 0  
BASIC WIND SPEED: 80 MPH  
EXPOSURE: C  
DESIGN WIND PRESSURE: 30.0 psf

#### GENERAL NOTES:

1. THE CONTRACT STRUCTURAL DRAWINGS AND SPECIFICATIONS REPRESENT THE FINISHED STRUCTURE. THEY DO NOT INDICATE THE MEANS OR METHODS OF CONSTRUCTION.
2. TRANS-LUX CORPORATION AND OR ANY OF ITS SUBSIDIARIES ASSUMES NO RESPONSIBILITY FOR WORK COMPLETED BY OTHERS.
3. FIELD VERIFY ALL EXISTING DIMENSIONS, MEMBER SIZES, AND ELEVATION SHOWN ON THE DRAWINGS. ALL DISCREPANCIES SHALL BE BROUGHT TO THE ATTENTION OF THE ENGINEER IMMEDIATELY.
4. ANY ENGINEERING DESIGN PROVIDED BY OTHERS AND SUBMITTED FOR REVIEW OR RECORD SHALL BEAR THE STAMP AND SIGNATURE OF A PROFESSIONAL STRUCTURAL ENGINEER REGISTERED IN THE STATE OF INSTALLATION.

#### CONSTRUCTION PROCEDURES AND SAFETY REQUIREMENTS:

1. COMPLY WITH ALL APPLICABLE CITY, COUNTY, STATE AND FEDERAL LAWS AND REGULATIONS ADOPTED PURSUANT THERETO.
2. PROVIDE ALL MEASURES NECESSARY TO PROTECT THE WORKMEN AND OTHER PERSONS DURING CONSTRUCTION. PROVIDE ALL NECESSARY MEASURES TO AVOID EXCESSIVE STRESSES AND TO HOLD THE STRUCTURAL ELEMENTS IN PLACE DURING CONSTRUCTION. SUCH MEASURES SHALL INCLUDE, BUT NOT BE LIMITED TO, BRACING; SHORING FOR CONSTRUCTION EQUIPMENT; SCAFFOLDING; SAFETY NETS; SUPPORT AND BRACING FOR CRANES AND HOISTS; GUYING, ETC.

#### CONCRETE AND REINFORCING STEEL:

1. ALL CONCRETE WORK SHALL CONFORM TO THE LATEST EDITION OF THE AMERICAN CONCRETE INSTITUTE PUBLICATIONS: ACI 301, ACI 311, ACI 315, ACI 318, ACI 437, ACI 304; UNLESS OTHERWISE NOTED ON THE DRAWINGS.
2. ALL CONCRETE SHALL HAVE A MINIMUM ULTIMATE COMPRESSIVE STRENGTH OF 3000 P.S.I. AT 28 DAY TEST.
3. CONCRETE SHALL CONSIST OF THE FOLLOWING:  
ASTM A150 TYPE 1 PORTLAND CEMENT  
ASTM C33 NORMAL WEIGHT AGGREGATES  
NO CHLORIDES SHALL BE ALLOWED IN THE CONCRETE MIX.
4. CONCRETE THAT WILL BE SUBJECTED TO REPEATED FREEZE-THAW CYCLES DURING THE STRUCTURE'S LIFE SHALL HAVE A WATER-CEMENT RATIO NO EXCEEDING 6 GALLONS PER BAG AND SHALL CONTAIN ENTRAINED AIR. SEE ACI 301 FOR ADDITIONAL REQUIREMENTS.
5. MECHANICALLY VIBRATE CONCRETE AT TOPS OF DRILLED PIERS.

#### STRUCTURAL STEEL:

1. STRUCTURAL STEEL MATERIAL SHALL BE ASTM:  
A572 (50KSI) ROLLED W-SHAPE COLUMNS  
A36 CONNECTION MATERIAL AND STIFFENER PLATES  
A36 ROLLED SECTIONS AND PLATE
2. STRUCTURAL STEEL DETAILS, FABRICATION, AND ERECTION SHALL CONFORM TO THE AISC "MANUAL OF STEEL CONSTRUCTION - ASD" LATEST EDITION. UNLESS OTHERWISE SHOWN OR SPECIFIED.
3. ALL STRUCTURAL TUBE ENDS TO BE COVERED WITH LIGHT GAGE END CAPS.
4. ALL NEW STEEL TO BE PRIMED AND PAINTED WITH AN APPROVED COLOR.
5. ALL WELDING SHALL BE DONE BY CERTIFIED WELDERS WITH EXPERIENCE AND CERTIFICATION IN THE TYPES OF WELDING CALLED FOR. CERTIFICATES SHALL BE NOT MORE THAN 6 MONTHS OLD AND SHALL BE THOSE ISSUED BY AN ACCEPTABLE TESTING AGENCY.
6. ALL WELDS SHALL BE E70XX ELECTRODES, AND SHALL BE PRIMED AND PAINTED WITH AN APPROVED COLOR.
7. UNLESS OTHERWISE NOTED, ALL WELDS SHALL BE CONTINUOUS 1/4" FILLET WELDS. ALL FULL AND/OR PARTIAL PENETRATION WELDS SHALL BE FULLY DETAILED ON THE SHOP DRAWINGS.
8. ALL FIELD WELDING SHALL BE PERIODICALLY INSPECTED AND CERTIFIED BY AN A QUALIFIED INDEPENDENT TESTING FIRM AS CALLED FOR UNDER THE "SPECIAL INSPECTIONS" PORTION OF THE UNIFORM BUILDING CODE, 1997.

#### DRILLED PIERS:

1. SOIL IS ASSUMED TO BE AVERAGE WITH MAXIMUM ALLOWABLE LATERAL BEARING STRESS OF 150 PSF/FT AND MAXIMUM ALLOWABLE AXIAL BEARING STRESS OF 1500 PSF.
3. ALL DRILLED PIERS SHALL BEAR ON AN UNDISTURBED SOIL.
4. PROVIDE FOR DEWATERING AT EXCAVATIONS FROM EITHER SURFACE WATER OR SEEPAGE.
5. THE ELEVATION IDENTIFYING THE BOTTOM OF SHAFT IS AN APPROXIMATE LENGTH FOR ESTIMATING PURPOSES ONLY. THE ACTUAL LENGTH WILL BE DETERMINED IN THE FIELD FROM THE ACTUAL ELEVATION OF THE BEARING STRATUM TO BE VERIFIED BY THE ON-SITE SOILS TESTING AGENCY.
6. CONCRETE SHALL BE PLACED IMMEDIATELY AFTER SHAFTS ARE CLEANED, DATA IS RECORDED AND APPROVAL OF BEARING SURFACE IS OBTAINED. EXCAVATIONS SHALL NOT BE LEFT OPEN OVERNIGHT.
7. BEARING CAPACITY SHALL BE VERIFIED BY THE ON-SITE SOILS TESTING AGENCY. REMOVAL OF DEBRIS FROM THE BOTTOM OF THE SHAFT SHALL BE DONE BY MECHANICAL METHODS AND NOT BY THE TRADE CONTRACTOR'S PERSONNEL. AT NO TIME SHALL ANY FIELD PERSONNEL ACCESS DRILLED PIER EXCAVATIONS.
8. ALL PIERS SHALL BE CENTERED UNDER COLUMNS.
9. ALL DRILLED PIER INSTALLATIONS AND CONCRETE PLACEMENT SHALL BE INSPECTED AND CERTIFIED BY A QUALIFIED SPECIAL INSPECTOR AS CALLED FOR UNDER THE "SPECIAL INSPECTION" PORTION OF THE UNIVERSAL BUILDING CODE, 1997.

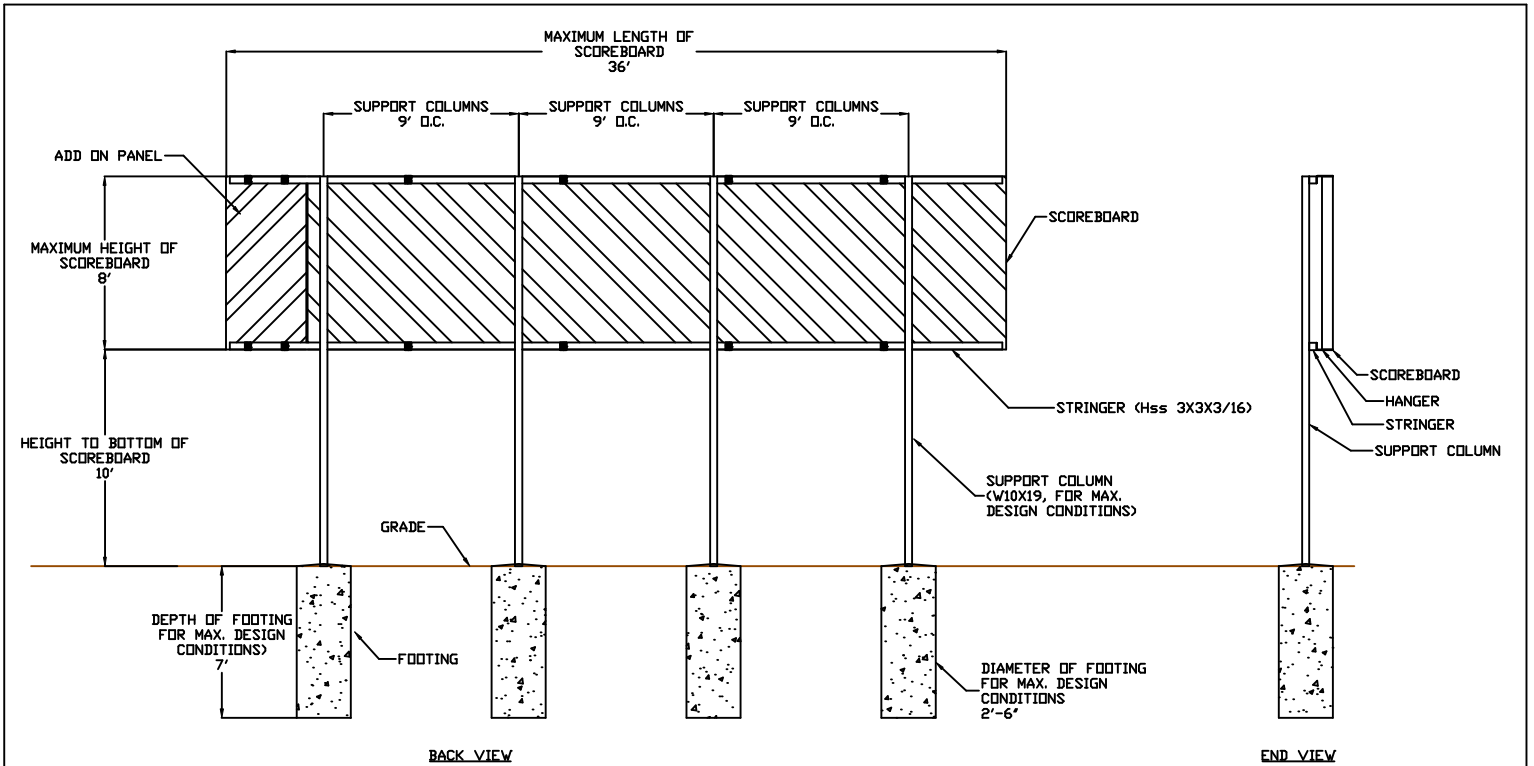

#### DESIGN CRITERIA:

1. CODES  
UNIFORM BUILDING CODE, 1997  
AMERICAN CONCRETE INSTITUTE 318-89  
AMERICAN INSTITUTE OF STEEL CONSTRUCTION - ASD 1989
2. LATERAL LOADS:  
SEISMICITY: SEISMIC ZONE 0  
BASIC WIND SPEED: 80 MPH  
EXPOSURE: C  
DESIGN WIND PRESSURE: 30.0 psf

#### GENERAL NOTES:

1. THE CONTRACT STRUCTURAL DRAWINGS AND SPECIFICATIONS REPRESENT THE FINISHED STRUCTURE. THEY DO NOT INDICATE THE MEANS OR METHODS OF CONSTRUCTION.
2. TRANS-LUX CORPORATION AND OR ANY OF ITS SUBSIDIARIES ASSUMES NO RESPONSIBILITY FOR WORK COMPLETED BY OTHERS.
3. FIELD VERIFY ALL EXISTING DIMENSIONS, MEMBER SIZES, AND ELEVATION SHOWN ON THE DRAWINGS. ALL DISCREPANCIES SHALL BE BROUGHT TO THE ATTENTION OF THE ENGINEER IMMEDIATELY.
4. ANY ENGINEERING DESIGN PROVIDED BY OTHERS AND SUBMITTED FOR REVIEW OR RECORD SHALL BEAR THE STAMP AND SIGNATURE OF A PROFESSIONAL STRUCTURAL ENGINEER REGISTERED IN THE STATE OF INSTALLATION.

#### CONSTRUCTION PROCEDURES AND SAFETY REQUIREMENTS:

1. COMPLY WITH ALL APPLICABLE CITY, COUNTY, STATE AND FEDERAL LAWS AND REGULATIONS ADOPTED PURSUANT THERETO.
2. PROVIDE ALL MEASURES NECESSARY TO PROTECT THE WORKMEN AND OTHER PERSONS DURING CONSTRUCTION. PROVIDE ALL NECESSARY MEASURES TO AVOID EXCESSIVE STRESSES AND TO HOLD THE STRUCTURAL ELEMENTS IN PLACE DURING CONSTRUCTION. SUCH MEASURES SHALL INCLUDE, BUT NOT BE LIMITED TO, BRACING; SHORING FOR CONSTRUCTION EQUIPMENT; SCAFFOLDING; SAFETY NETS; SUPPORT AND BRACING FOR CRANES AND HOISTS; GUYING, ETC.

#### CONCRETE AND REINFORCING STEEL:

1. ALL CONCRETE WORK SHALL CONFORM TO THE LATEST EDITION OF THE AMERICAN CONCRETE INSTITUTE PUBLICATIONS: ACI 301, ACI 311, ACI 315, ACI 318, ACI 437, ACI 304; UNLESS OTHERWISE NOTED ON THE DRAWINGS.
2. ALL CONCRETE SHALL HAVE A MINIMUM ULTIMATE COMPRESSIVE STRENGTH OF 3000 P.S.I. AT 28 DAY TEST.
3. CONCRETE SHALL CONSIST OF THE FOLLOWING:  
ASTM A150 TYPE 1 PORTLAND CEMENT  
ASTM C33 NORMAL WEIGHT AGGREGATES  
NO CHLORIDES SHALL BE ALLOWED IN THE CONCRETE MIX.
4. CONCRETE THAT WILL BE SUBJECTED TO REPEATED FREEZE-THAW CYCLES DURING THE STRUCTURE'S LIFE SHALL HAVE A WATER-CEMENT RATIO NO EXCEEDING 6 GALLONS PER BAG AND SHALL CONTAIN ENTRAINED AIR. SEE ACI 301 FOR ADDITIONAL REQUIREMENTS.
5. MECHANICALLY VIBRATE CONCRETE AT TOPS OF DRILLED PIERS.

#### STRUCTURAL STEEL:

1. STRUCTURAL STEEL MATERIAL SHALL BE ASTM:  
A572 (50KSI) ROLLED W-SHAPE COLUMNS  
A36 CONNECTION MATERIAL AND STIFFENER PLATES  
A36 ROLLED SECTIONS AND PLATE
2. STRUCTURAL STEEL DETAILS, FABRICATION, AND ERECTION SHALL CONFORM TO THE AISC "MANUAL OF STEEL CONSTRUCTION - ASD" LATEST EDITION. UNLESS OTHERWISE SHOWN OR SPECIFIED.
3. ALL STRUCTURAL TUBE ENDS TO BE COVERED WITH LIGHT GAGE END CAPS.
4. ALL NEW STEEL TO BE PRIMED AND PAINTED WITH AN APPROVED COLOR.
5. ALL WELDING SHALL BE DONE BY CERTIFIED WELDERS WITH EXPERIENCE AND CERTIFICATION IN THE TYPES OF WELDING CALLED FOR. CERTIFICATES SHALL BE NOT MORE THAN 6 MONTHS OLD AND SHALL BE THOSE ISSUED BY AN ACCEPTABLE TESTING AGENCY.
6. ALL WELDS SHALL BE E70XX ELECTRODES, AND SHALL BE PRIMED AND PAINTED WITH AN APPROVED COLOR.
7. UNLESS OTHERWISE NOTED, ALL WELDS SHALL BE CONTINUOUS 1/4" FILLET WELDS. ALL FULL AND/OR PARTIAL PENETRATION WELDS SHALL BE FULLY DETAILED ON THE SHOP DRAWINGS.
8. ALL FIELD WELDING SHALL BE PERIODICALLY INSPECTED AND CERTIFIED BY AN A QUALIFIED INDEPENDENT TESTING FIRM AS CALLED FOR UNDER THE "SPECIAL INSPECTIONS" PORTION OF THE UNIFORM BUILDING CODE, 1997.

#### DRILLED PIERS:

1. SOIL IS ASSUMED TO BE AVERAGE WITH MAXIMUM ALLOWABLE LATERAL BEARING STRESS OF 150 PSF/FT AND MAXIMUM ALLOWABLE AXIAL BEARING STRESS OF 1500 PSF.
3. ALL DRILLED PIERS SHALL BEAR ON AN UNDISTURBED SOIL.
4. PROVIDE FOR DEWATERING AT EXCAVATIONS FROM EITHER SURFACE WATER OR SEEPAGE.
5. THE ELEVATION IDENTIFYING THE BOTTOM OF SHAFT IS AN APPROXIMATE LENGTH FOR ESTIMATING PURPOSES ONLY. THE ACTUAL LENGTH WILL BE DETERMINED IN THE FIELD FROM THE ACTUAL ELEVATION OF THE BEARING STRATUM TO BE VERIFIED BY THE ON-SITE SOILS TESTING AGENCY.
6. CONCRETE SHALL BE PLACED IMMEDIATELY AFTER SHAFTS ARE CLEANED, DATA IS RECORDED AND APPROVAL OF BEARING SURFACE IS OBTAINED. EXCAVATIONS SHALL NOT BE LEFT OPEN OVERNIGHT.
7. BEARING CAPACITY SHALL BE VERIFIED BY THE ON-SITE SOILS TESTING AGENCY. REMOVAL OF DEBRIS FROM THE BOTTOM OF THE SHAFT SHALL BE DONE BY MECHANICAL METHODS AND NOT BY THE TRADE CONTRACTOR'S PERSONNEL. AT NO TIME SHALL ANY FIELD PERSONNEL ACCESS DRILLED PIER EXCAVATIONS.
8. ALL PIERS SHALL BE CENTERED UNDER COLUMNS.
9. ALL DRILLED PIER INSTALLATIONS AND CONCRETE PLACEMENT SHALL BE INSPECTED AND CERTIFIED BY A QUALIFIED SPECIAL INSPECTOR AS CALLED FOR UNDER THE "SPECIAL INSPECTION" PORTION OF THE UNIVERSAL BUILDING CODE, 1997.

## **SCOREBOARD CARE – OFF SEASON**

**EL-1527**

### **FAIR-PLAY SCOREBOARDS DES MOINES, IOWA**

Your Fair-Play scoreboard, when installed as directed by the installation instructions, is designed and constructed to withstand normal environmental conditions. Because of its seasonal usage, particularly outdoor football and baseball scoreboards, long life with minimum service can be expected by caring for the scoreboard during off-season.

OFF-SEASON PREVENTATIVE MAINTENANCE PROCEDURES CAN INCLUDE:

- 1.) Small scoreboards and portable scoreboards can be disconnected and removed from their supports and stored in an indoor location.
- 2.) Controls should be unplugged, placed in their carrying cases and stored in a dry location of moderate temperatures.
- 3.) The processors in outdoor scoreboards will benefit by their removal and storage in a dry location of moderate temperature. When left in the scoreboard they are subject to vandalism and damage from various types of weather, including lightning.

IF IT IS NOT PRACTICAL TO REMOVE THE PROCESSOR, ITS POWER AND CONTROL CONNECTORS CAN BE UNPLUGGED TO ISOLATE IT FROM EXTERNAL ELECTRICAL SOURCES. WHEN UNPLUGGING CONNECTORS, BE SURE EACH IS MARKED WITH A NUMBER OR TAPE TO INDICATE ITS CORRECT SOCKET POSITION. DRAPE THE CABLE HARNESS UP SO THE CONNECTOR DOES NOT LIE ON THE BOTTOM OF THE SCOREBOARD COMPARTMENT.

- 4.) The scoreboard equipment should be inspected, reassembled, and tested well before the first game of the season to allow sufficient time for the return and repair of any malfunctioning parts.

### **CAUTION**

SERVICE THE SCOREBOARD ONLY AFTER IT IS DISCONNECTED FROM ITS POWER SOURCE.



NOTE: ALL REFERENCES ARE TO THE NATIONAL ELECTRICAL CODE, 1999 EDITION.

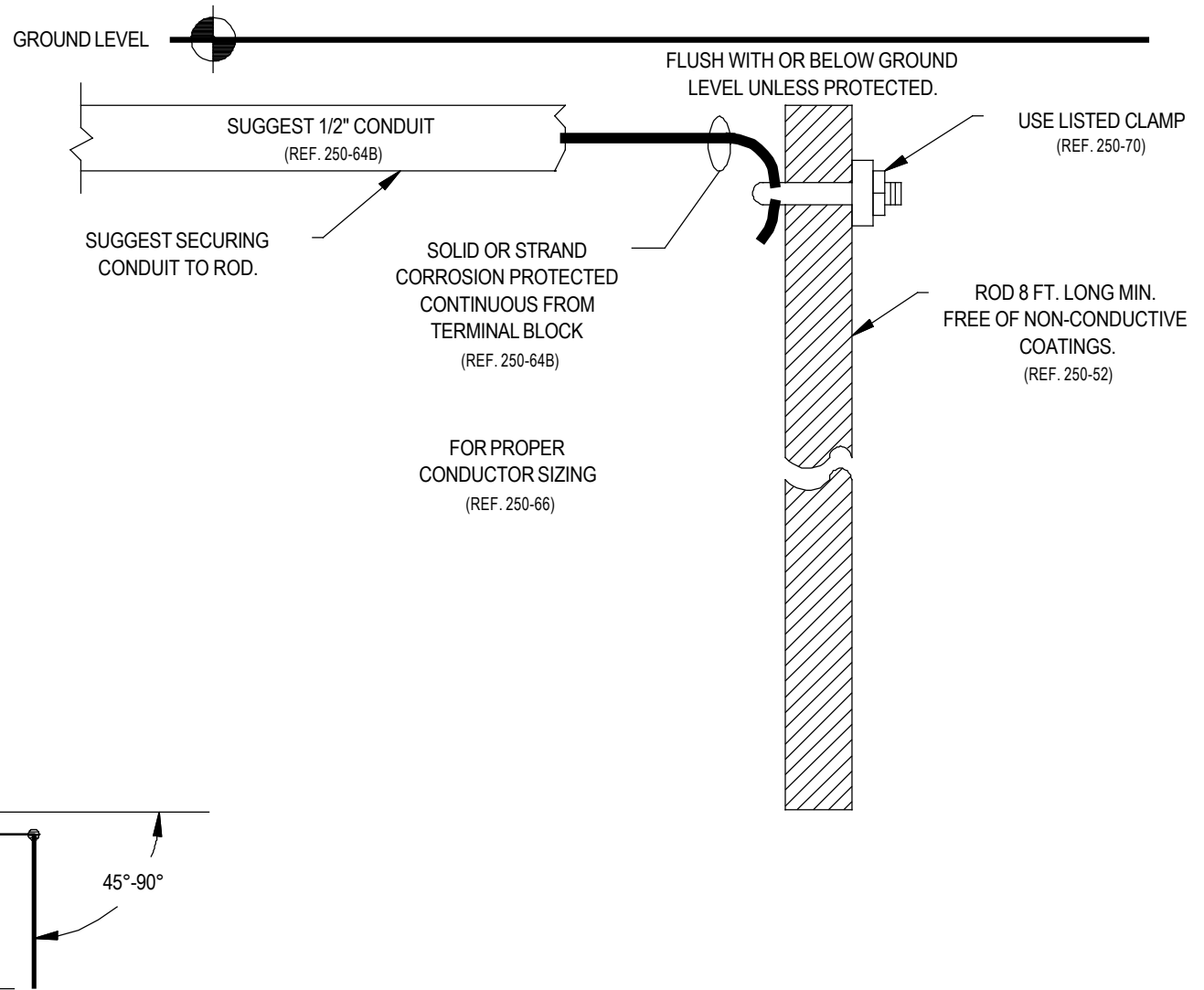

**TRANS·LUX**  
*Fair-Play*

1700 DELAWARE AVE.  
DES MOINES, IA 50317

THIS DOCUMENT CONTAINS FAIR-PLAY PROPRIETARY INFORMATION. ANY DISCLOSURE, USE OR DUPLICATION OF THE DOCUMENT OR OF ANY INFORMATION CONTAINED THEREIN FOR OTHER THAN THE SPECIFIC PURPOSE FOR WHICH IT WAS DISCLOSED IS EXPRESSLY PROHIBITED, EXCEPT AS MAY BE OTHERWISE AGREED TO IN WRITING

TITLE  
GROUNDING INSTRUCTIONS  
FOR TYP. OUTDOOR SCBD  
AS PER N.E.C. ARTICLE 250

DRAWN BY  
DLS  
DATE  
11-15-95  
SCALE  
NONE

MODEL:  
A  
DWG. NO.  
E-6-4923

A	UPDATED TITLE BLOCK	9-06-02	DLS
1	UPDATED CODE INFORMATION FROM 1999 EDITION	05-19-99	BEW
REV.#	CHANGE	DATE	BY

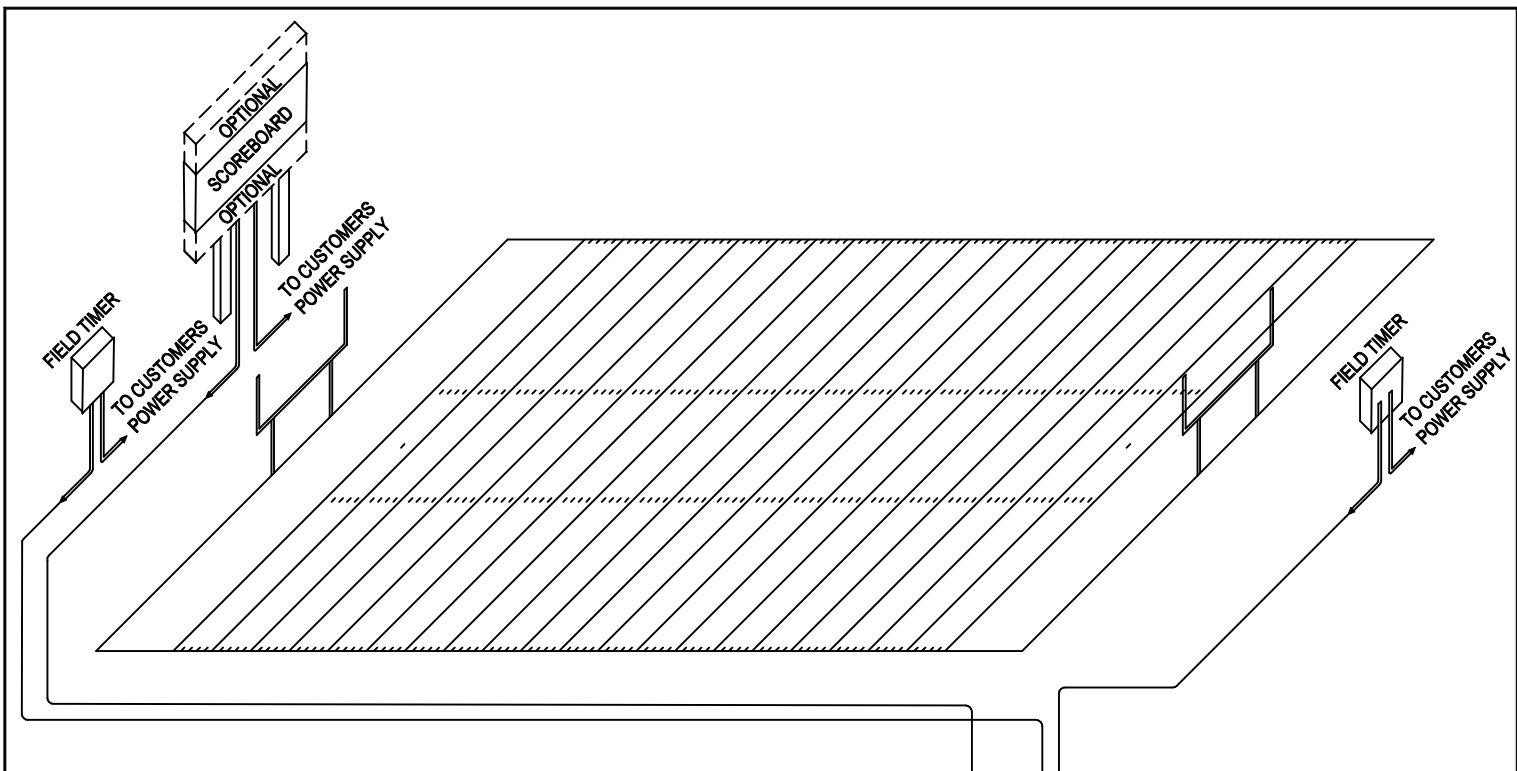

**CONTROL HOOK-UP LOCATION**

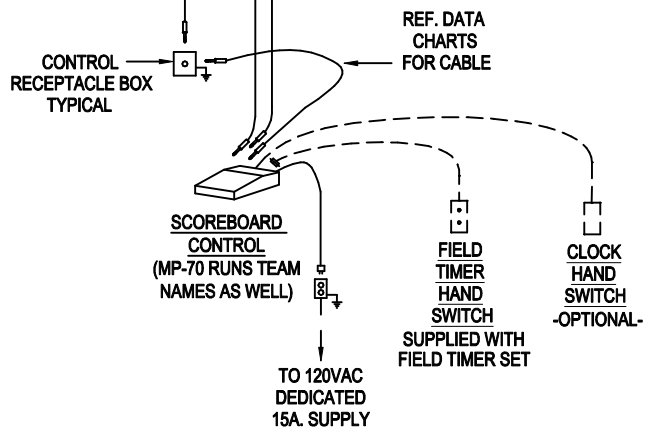

**NOTE:**  
SUGGEST CONDUIT WHERE CABLE  
MAY BE SUBJECT TO MECHANICAL  
DAMAGE. CONDUIT SIZE DEPENDS  
ON INSTALLATION.

HINGED LID  
SHOWN OPEN

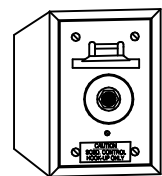

**ASSEMBLY DETAIL  
RAINTIGHT CONTROL  
RECEPTACLE BOX**

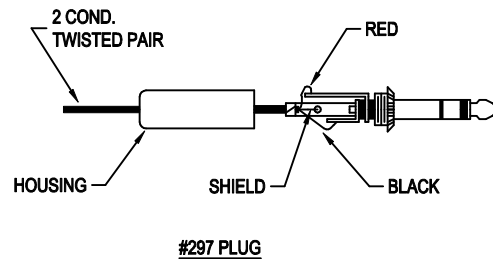
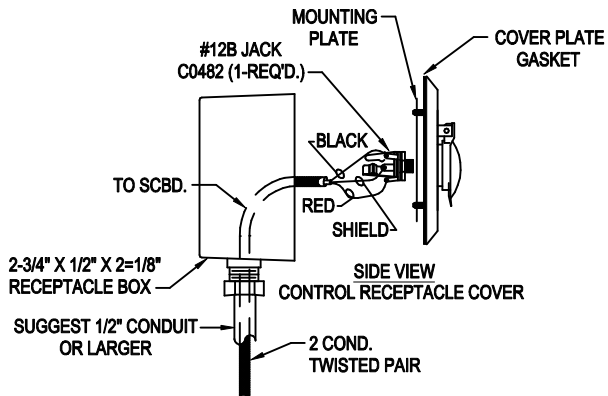

REV. 08-29-01

01-0009-06

LED 1208 JUMPER LOCATIONS

LOCATION	PIN #															
	2	4	6	8	10	12	14	16	1	3	5	7	9	11	13	15
JP1										X						
JP3																
JP4			X													
JP5			X													
JP6	HAS THREE PINS 2 & 3 NEED A JUMPER															
JP7			X													
K25	BOARD TYPE							REFERENCE DOCUMENT 14-0012-01								

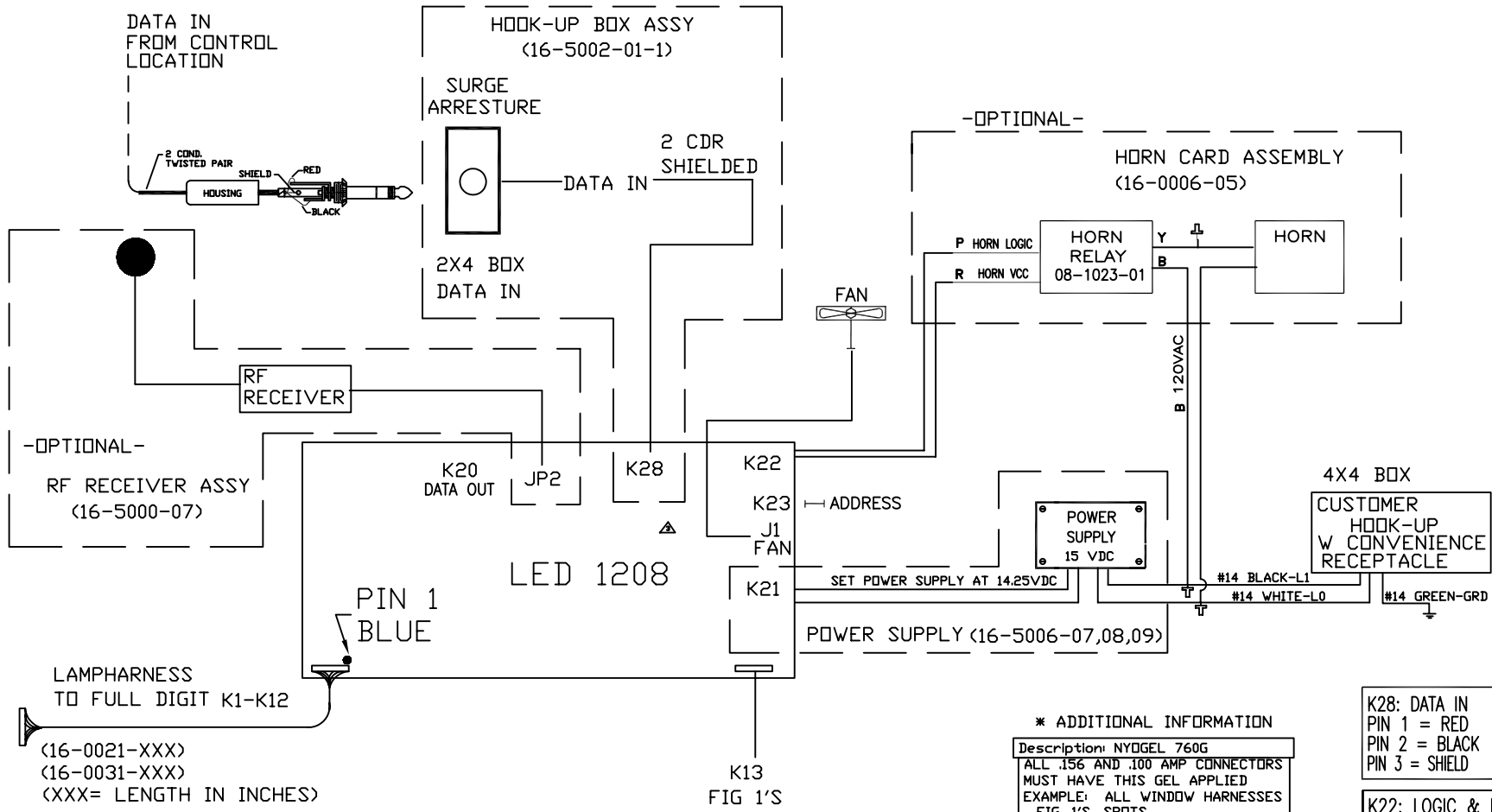

**\* ADDITIONAL INFORMATION**  
 Description: NYOGEL 760G  
 ALL .156 AND .100 AMP CONNECTORS MUST HAVE THIS GEL APPLIED  
 EXAMPLE: ALL WINDOW HARNESSSES, FIG. 1'S, SPOTS  
**WARNING**  
 DO NOT DO THE ADDRESS PLUGS OR ANY TRANSFORMER OR POWER SUPPLY PLUGS

**K28: DATA IN**  
 PIN 1 = RED  
 PIN 2 = BLACK  
 PIN 3 = SHIELD

**K20: DATA OUT**  
 PIN 1 = RED  
 PIN 2 = BLACK

**K22: LOGIC & HORN WIRING**  
 PIN 1 = HORN LOGIC (PURPLE)  
 PIN 6 = HORN VCC (RED)  
 PIN 3 = ADDRESS PLUG

REV.#	CHANGE	DATE	BY
D	ADDED NEW HARNESS PART NUMBER AS AN OPTION	2/28/05	DLS
C	REMOVED BOARD TYPE REF. DOC., SWITCHED FROM 12VDC TO 15VDC	9/13/04	NAP
B	CORRECTED JUMPER LOCATION ON BOARD TYPR 25	6/27/02	NAP
A	REDID CHART, NEW BLOCK	12-07-01	NAP
3	CORRECTED CONNECTIONS ON DRIVER	8-1-01	NAP
2	ADDED JUMPER INFORMATION CHART	8-1-01	NAP
1	ADDED GEL & HARNESS INFORMATION	5-23-01	NAP

**TRANS·LUX**  
*Fair-Play*  
 1700 DELAWARE AVE.  
 DES MOINES, IA 50317

THIS DOCUMENT CONTAINS FAIR-PLAY PROPRIETARY INFORMATION. ANY DISCLOSURE, USE OR DUPLICATION OF THE DOCUMENT OR OF ANY INFORMATION CONTAINED THEREIN FOR OTHER THAN THE SPECIFIC PURPOSE FOR WHICH IT WAS DISCLOSED IS EXPRESSLY PROHIBITED, EXCEPT AS MAY BE OTHERWISE AGREED TO IN WRITING

TITLE: TYPICAL WIRING POWER DISTRIBUTION LED OUTDOOR SCBDS.

DRAWN BY: NAP  
 DATE: 4-19-01  
 SCALE: NONE

MODEL: COMMON  
 DWG. NO.: 12-0004-01

# BACK VIEW OF DIGITS AND BALL POSSESSION

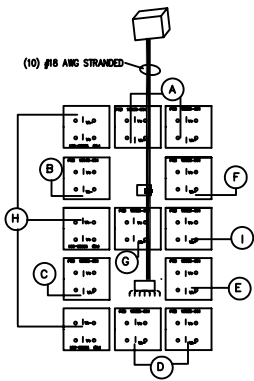

5=V+ ON ALL CARDS  
TYPICAL WIRE CONNECTION  
for 15"  
LED

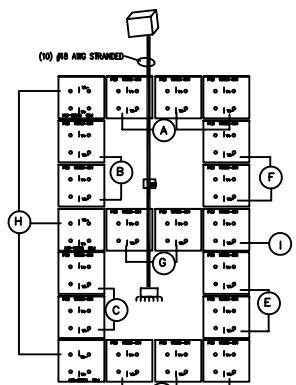

5=V+ ON ALL CARDS  
TYPICAL WIRE CONNECTION  
for 18"  
LED

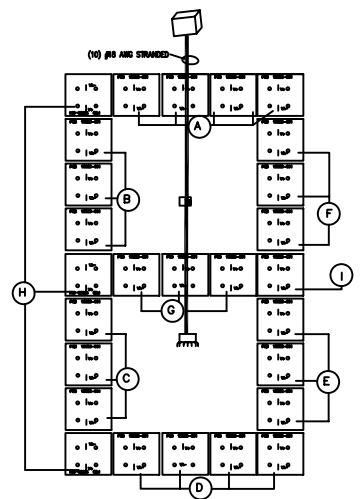

5=V+ ON ALL CARDS  
TYPICAL WIRE CONNECTION  
24"  
LED

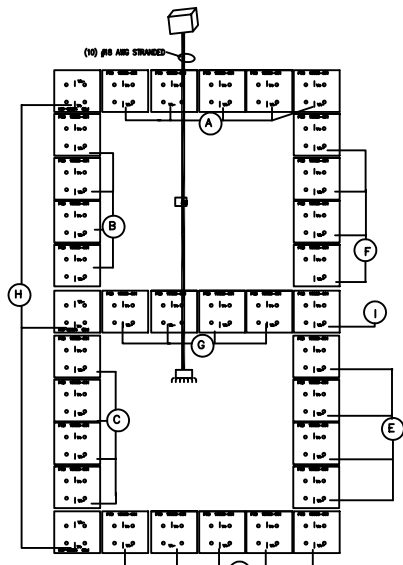

5=V+ ON ALL CARDS  
TYPICAL WIRE CONNECTION  
30"  
LED

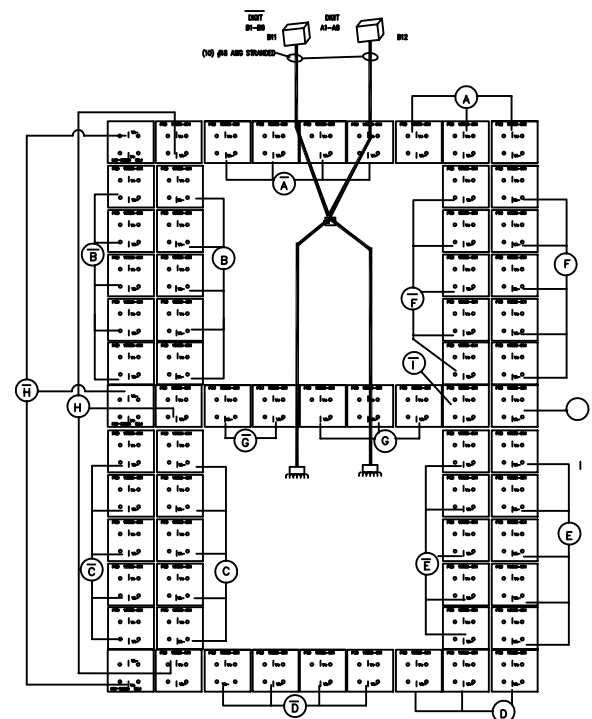

5=V+ ON CARDS NEED TO STAY WITH APPROPRIATE CIRCUIT  
EXAMPLE: THE DIGIT AND DIGIT  
TYPICAL WIRE CONNECTION  
36" DOUBLE STROKE  
LED

- 16-5001-05 (12VDC)
- 24-1031-01 (15VDC)

ALL CARDS WILL BE PLACED ON THE SHEETMETAL  
RIGHT SIDE UP (PART NUMBER TO TOP)

OPTIONAL 15" AND 18" FULL DIGIT  
15" SHOWN, 18" TYPICAL

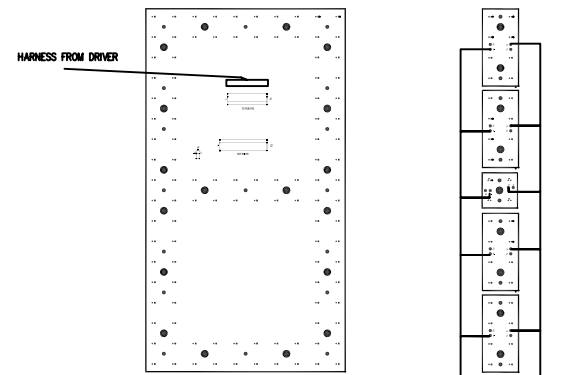

- 15" DIGIT = 24-1047-01(-02)
  - 18" DIGIT = 24-1057-01
- FIGURE 1  
2 X 2 DIGIT = 24-1049-01(-02)  
2 X 4 DIGIT = 24-1048-01(-02)

REF. 12-0009-01 FOR DRIVER CONNECTIONS

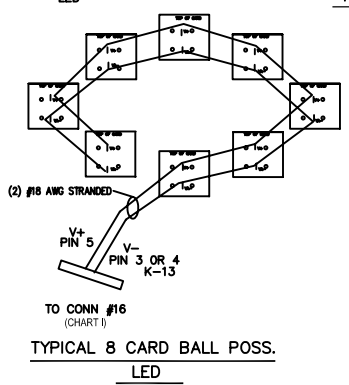

TYPICAL 8 CARD BALL POSS.  
LED

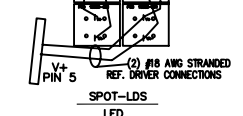

SPOT-LDS  
LED

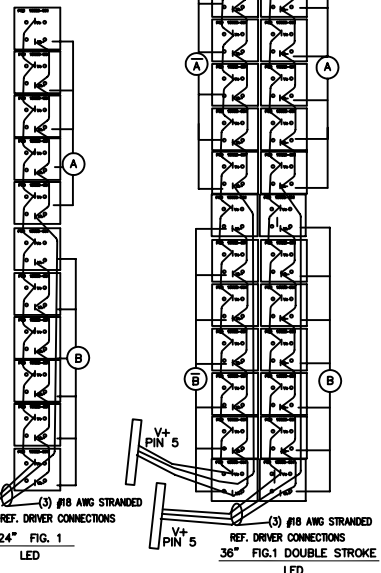

TYPICAL WIRE CONNECTION  
24" FIG. 1  
LED

- NOTE: EACH DIGIT ASSEMBLY WILL USE A W0129-CABLE TIE F0748-RIVET TO ATTACH THE CABLE TIE W0005-TIE
- NOTE: USE NYOGEL ON ALL CONNECTIONS INCLUDING THE T-TAPS

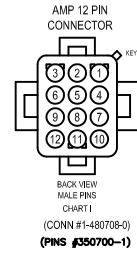

REF DRAWING 12-0003-01-1 FOR SPOTS AND FIG. 1 & H/E WIRING

0 TO 9 UNIT WIRING		
PIN#	CIRCUIT	CONDUCTOR COLOR
1	A or A	BLUE
2	B or B	PINK
3	C or C	PURPLE
4	D or D	GRAY
5	VLED (V+)	BLACK (V+)
6	E or E	BROWN
7	F or F	ORANGE
8	G or G	YELLOW
9	I or I	WHITE
10	H or H	RED

REV.#	CHANGE	DATE	BY
E	REMOVED DEGREE LAYOUT, ADDED NEW 15" & 18" DIGIT	03/01/05	DLS
D	ADDED PART # 24-1031-01 FOR 12VDC TO 15VDC SWITCH	09-13-04	DLS
C	ADDED FIG. 1'S AND DS SPOT	5/22/02	NAP
B	ADDED WHAT DEGREE OF LED USING	12-10-01	NAP
A	REDID ADDED THE INFORMATION FOR PART # 16-5001-05	11-28-01	NAP
2	ADDED 30" WIRING AND CABLE TIE PART #	10-22-01	NAP
1	ADDED GEL INFORMATION	5-23-01	NAP

1700 DELAWARE AVE.  
DES MOINES, IA 50317

THIS DOCUMENT CONTAINS TRANS-LUX PROPRIETARY INFORMATION. ANY DISCLOSURE, USE OR DUPLICATION OF THE DOCUMENT OR OF ANY INFORMATION CONTAINED THEREIN FOR OTHER THAN THE SPECIFIC PURPOSE FOR WHICH IT WAS DISCLOSED IS EXPRESSLY PROHIBITED, EXCEPT AS MAY BE OTHERWISE AGREED TO IN WRITING. COPYRIGHT 2003.

TITLE  
**TYPICAL WIRING  
LED OUTDOOR  
DIGITS**

DRAWN BY  
NAP  
DATE  
11-26-01  
SCALE

MODEL:  
**A**  
DWG. NO.  
12-0003-01

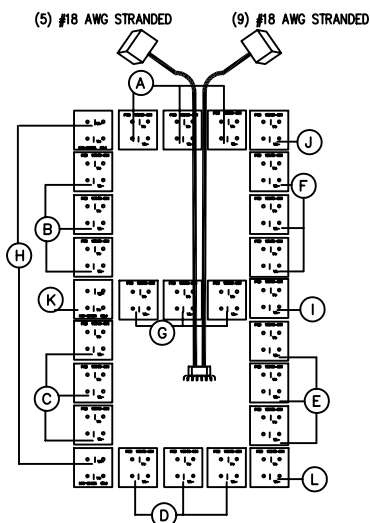

BACK VIEW  
TYPICAL WIRE CONNECTION  
24" 12 SEGMENT H/E INCLUDES PITCH SPEED LED

5=V+ TO CARDS NOTED A,B,C,D,E,F,G,H SEGMENTS  
5=V+ TO CARD NOTED I,J,K,L

H & E 12 SEGMENT UNIT WIRING		
PIN#	CIRCUIT	CONDUCTOR COLOR
1	A	BLUE
2	B	PINK
3	C	PURPLE
4	D	GRAY
5	VLED (V+)	BLACK (V+)
6	E	BROWN
7	F	ORANGE
8	G	YELLOW
9	H	WHITE
10		

H & E 12 SEGMENT UNIT WIRING		
PIN#	CIRCUIT	CONDUCTOR COLOR
1		
2		
3		
4		
5	VLED (V+)	BLACK (V+)
6	I	BROWN
7	J	ORANGE
8	K	YELLOW
9	L	WHITE
10		

NOTE: MP-70 MUST HAVE VERSION 2.18 FOR NEW DIGIT

K13-REF. TO CHART A  
PIN 1=FIG.1 TOP/HALF  
PIN 2=FIG.1 BOT/HALF  
PIN 3=V.POSS/AT BAT  
PIN 4=H.POSS/AT BAT  
PIN 5=V+ BLACK  
PIN 6=ERROR SPOT  
PIN 7=HIT SPOT  
PIN 8=MIN. COLONS  
PIN 9=SEC. COLONS  
PIN10= N.C.

NOTE: USE NYOGEL ON ALL  $\triangle$  CONNECTIONS INCLUDING THE T-TAPS

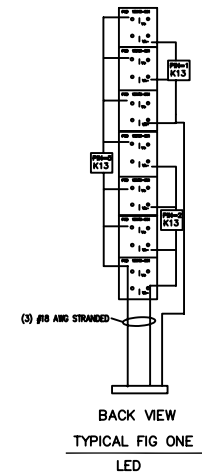

BACK VIEW  
TYPICAL FIG ONE  
LED

0 TO 9 UNIT WIRING		
PIN#	CIRCUIT	CONDUCTOR COLOR
1	A or $\bar{A}$	BLUE
2	B or $\bar{B}$	PINK
3	C or $\bar{C}$	PURPLE
4	D or $\bar{D}$	GRAY
5	VLED (V+)	BLACK (V+)
6	E or $\bar{E}$	BROWN
7	F or $\bar{F}$	ORANGE
8	G or $\bar{G}$	YELLOW
9	I or $\bar{I}$	WHITE
10	H or $\bar{H}$	RED

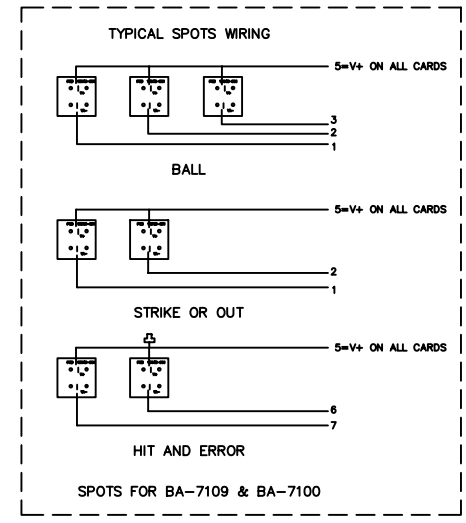
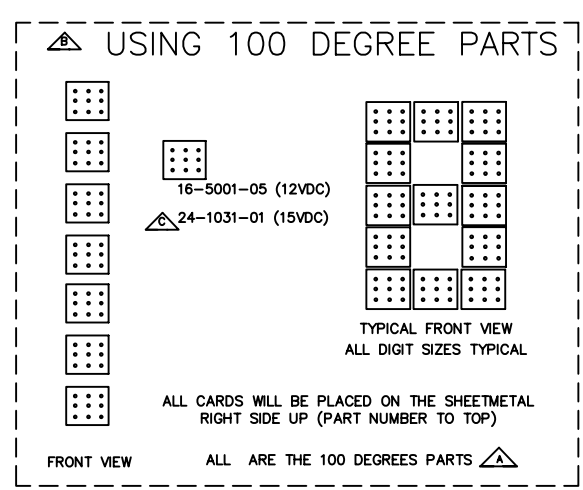
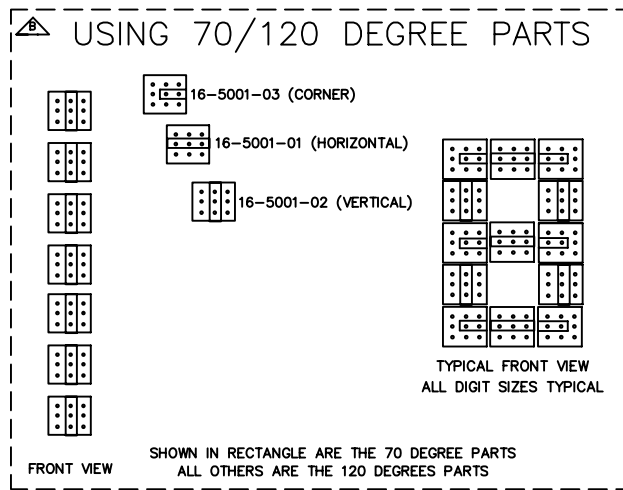
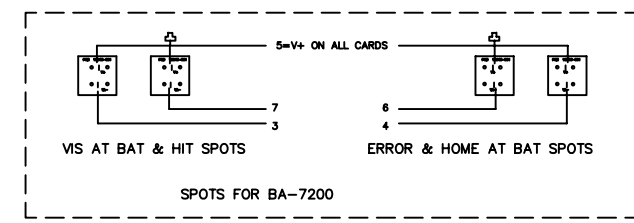
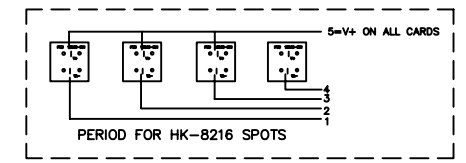

$\triangle$	NEW 12 SEGMENT H&E WIRING FOR STANDARD H&E AND MPH OPTION	01-05-07	NAP
$\triangle$	ADDED PART # 24-1031-01 FOR 12VDC TO 15VDC SWITCH	09-13-04	NAP
$\triangle$	ADDED WHAT DEGREE OF LED USING	12-10-01	NAP
$\triangle$	REDID DRAWING ADDED INFORMATION FOR PART#16-5001-05	11-29-01	NAP
$\triangle$	ADDED INFORMATIONS ON GEL & REDID SPOT WIRES	5-24-01	NAP
REV.#	CHANGE	DATE	BY

**TRANS·LUX**  
*Fair-Play*

1700 DELAWARE AVE.  
DES MOINES, IA 50317

THIS DOCUMENT CONTAINS FAIR-PLAY PROPRIETARY INFORMATION. ANY DISCLOSURE, USE OR DUPLICATION OF THE DOCUMENT OR OF ANY INFORMATION CONTAINED THEREIN FOR OTHER THAN THE SPECIFIC PURPOSE FOR WHICH IT WAS DISCLOSED IS EXPRESSLY PROHIBITED, EXCEPT AS MAY BE OTHERWISE AGREED TO IN WRITING

TITLE	DRAWN BY	MODEL:
TYPICAL WIRING LED OUTDOOR H/E, FIG 1'S, SPOTS	NAP	A COMMON
	DATE	
	4/20/01	
	SCALE	DWG. NO.
	NONE	12-0003-01-1

2X4 BOX (B0729)

SURGE ARRESTER  
MOUNT TOWARDS TOP  
WITH DOUBLE SIDED TAPE  
PART # PD10552

LINE IN RED - RING

GROUND SHIELD

LINE IN

BLACK - TIP

REFER TO  
CONNECTOR  
DETAIL B

14 GA. TO EARTH GROUND  
CONNECT TO GROUND LUG

22 GA.

22 GA.

22 GA.

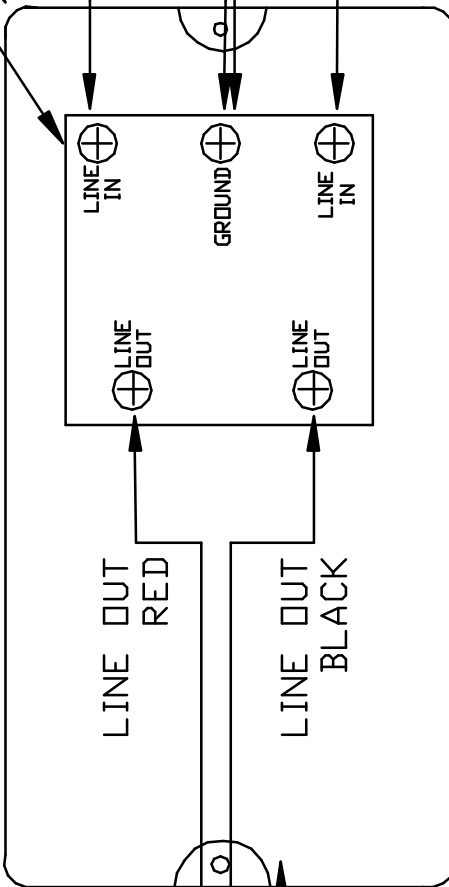

Parts List

Item	Description	FP #	Qty
1	1 PAIR, 22 GA. BELDEN Q7315/B451	C0550	72'
2	3-PIN AMP CONN. W/PINS-103957-2 FOR LED BOARDS	C1248	1
3	SWITCHCRAFT 12B JACK	C0482	1
4	2X4 COVER	B0087	1
5	SURGE ARRESTER	PD10552	1
6	2X4 BOX	B0729	1
7	7/8 BUSHING	B0550	1
8	SHRINK TUBING	T0237	1'
9	SPADE TERMINAL	T0015	5
10	3-PIN FOR BOARDS W/RC	C0521	1
11	#297 FOR BOARDS W/12B JACK	C0483	1
12	14 GA GREEN	W0043	4'
13	14 GA TERMINAL	T0011	1

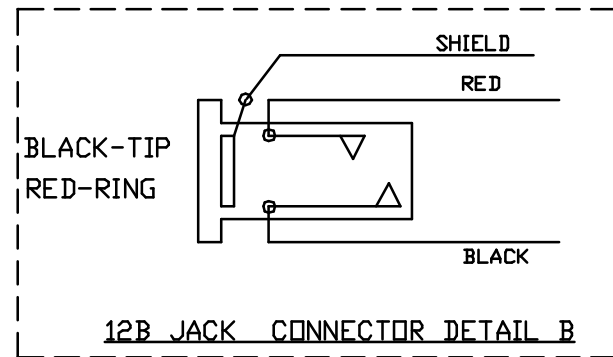
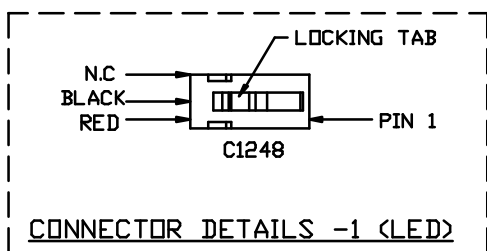
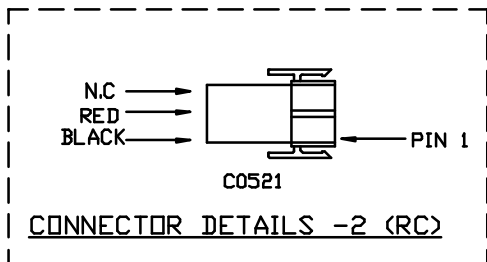
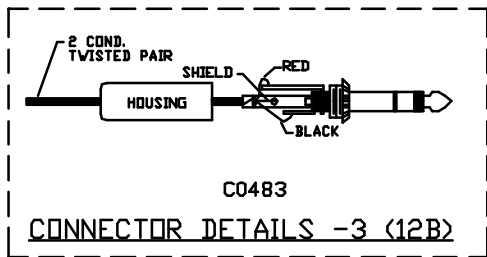

NOTE: SHRINK TUBING NEEDS TO COVER WIRES  
ESPECIALLY THE SHIELD

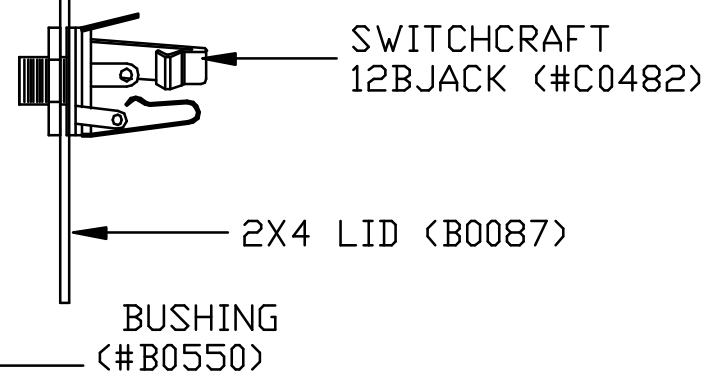

REFER TO  
CONNECTOR DETAILS -1 -2 -3

PIN 1 22 GA.  
PIN 2 22 GA.

**TRANS·LUX**  
*Fair-Play*  
1700 DELAWARE AVE.  
DES MOINES, IA 50317

THIS DOCUMENT CONTAINS FAIR-PLAY PROPRIETARY INFORMATION. ANY DISCLOSURE, USE OR DUPLICATION OF THE DOCUMENT OR OF ANY INFORMATION CONTAINED THEREIN FOR OTHER THAN THE SPECIFIC PURPOSE FOR WHICH IT WAS DISCLOSED IS EXPRESSLY PROHIBITED, EXCEPT AS MAY BE OTHERWISE AGREED TO IN WRITING

TITLE	DRAWN BY NAP	MODEL:
OUTDOOR (ONLY) DATA HOOKUP BOX ASSEM. WITH SURGE ARRES.	DATE 4-3-01	A COMMON
	SCALE none	DWG. NO. 16-5002-01

12-0013-03

△ 12-0013-03-1

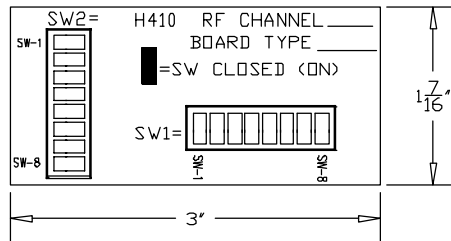

NOTE:

ON SW2 SWITCH 1 THRU 6 USES A BINARY # SYSTEM (REFERENCE DOCUMENT 14-0012-01 FOR BOARD TYPE SETTING).

\*LABEL MUST BE PLACED NEXT TO RECEIVER.

\*DO NOT PLACE ON RECEIVER.

\*BOARD TYPE AND RF CHANNEL MUST BE CLEARLY MARKED ALONG WITH THE SWITCH POSITION FOR SWITCH 1 AND 2.

MARK THE SWITCHES THAT ARE ON.

H410	SWITCH 1 SETTINGS								
	1	2	3	4	5	6	7	8	
SCOREBOARD	ON								
TEAM NAMES			ON						
				TEAM NAMES ON					
32 COLUMNS				ON					
40 COLUMNS					ON				
48 COLUMNS						ON			
CONTIGUOUS DATA							ON		
MP70 DATA OUT								ON	
SHOT TIMER		ON							
SWITCH EXAMPLE OFF IS ON OPPOSITE SIDE OF THE NUMBERS									
NOTE: SWITCH 4-8 USED ONLY WHEN TEAM NAME IS ON									

BLANK SQUARE=OFF

PLACE ON INSIDE OF LID 62-0007-02 △

NOTE SWITCH 2=#8 SWITCH ON WHEN TEAM NAME IS 8 ROWS HIGH  
 △ #8 SWITCH OFF WHEN TEAM NAME IS 7 ROWS HIGH

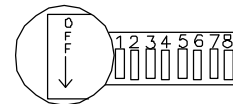

REV.#	CHANGE	DATE	BY
△	ADDED LABEL 12-0013-03-1	01-9-03	NAP
△	ADDED INFORMATION FOR SWITCH TWO POSITION 8	9-24-01	NAP
△	CORRECTED PART # FOR LID	7-18-01	NAP
1	ADDED INFORMATION FOR POSITION 8 SETTING ON SWITCH ONE	06-12-01	NAP

<p>1700 DELAWARE AVE. DES MOINES, IA 50317</p>	<p>THIS DOCUMENT CONTAINS FAIR-PLAY PROPRIETARY INFORMATION. ANY DISCLOSURE, USE OR DUPLICATION OF THE DOCUMENT OR OF ANY INFORMATION CONTAINED THEREIN FOR OTHER THAN THE SPECIFIC PURPOSE FOR WHICH IT WAS DISCLOSED IS EXPRESSLY PROHIBITED, EXCEPT AS MAY BE OTHERWISE AGREED TO IN WRITING</p>	TITLE	DRAWN BY	MODEL:	
		LABELS AND SWITCH SETTINGS FOR TEAM NAME REC.	NAP	B	COMMON
			DATE	DWG. NO.	
			1-7-03	12-0013-03	
	SCALE FULL				

PIXEL SIZE	POWER SUPPLY SIZE AND VOLTAGE	MAX. NUMBER OF LED MODULES PER SUPPLY POWER	MAX. NUMBER OF LED MODULES ON 14 GAUGE WIRE
1.375"	320 WATT 15VDC	6	4
1.75"	320 WATT 15VDC	6	4
2.5"	320 WATT 15VDC	6	4

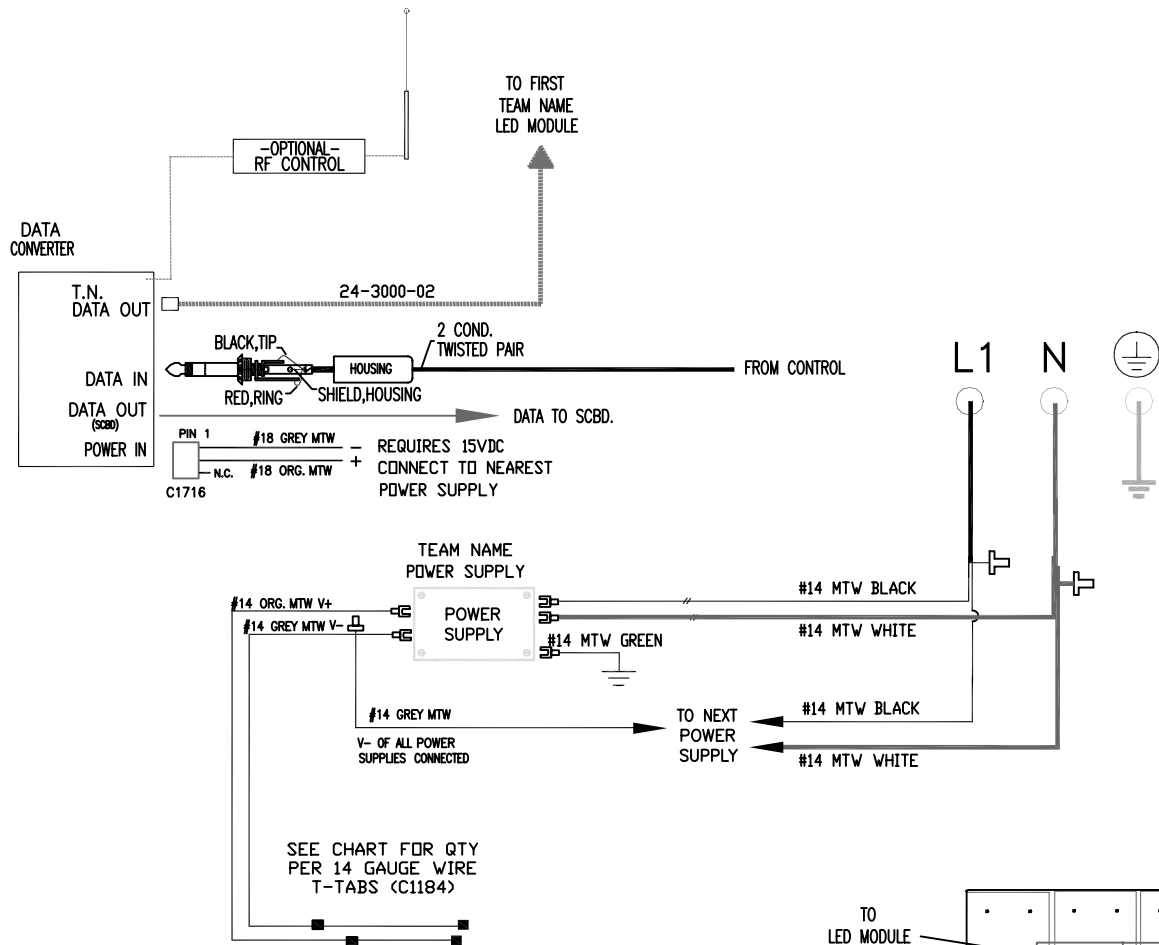

**ASSEMBLY NOTES:**

- \*8X40 TEAM NAME SHOWN, 8X48 TEAM NAME TYPICAL.
- \*NUMBER OF POWER SUPPLIES WILL VARY, REF. CHART.
- \*NYOGEL 760G REQUIRED AT LOCATIONS:  
ALL CONNECTIONS (HEADERS) ON THE LED MODULES.  
DO NOT APPLY TO POWER SUPPLIES.
- \*POWER SUPPLY:  
VERIFY POWER SUPPLY IS SWITCHED TO 115VAC.  
MEASURE VOLTAGE AT POWER SUPPLY = REF. CHART.  
CHAIN TOGETHER THE V- OF ALL POWER SUPPLIES IN THE TEAM NAMES.
- \*HIPOT TEST REQUIREMENTS:  
1.5 KILOVOLTS FOR 1 SECOND
- \*CONTINUITY CHECK BETWEEN CABINET AND GROUND

☐ = SPADE TERMINAL  
#18, T0666  
#14, T0146

SEE CHART FOR QTY PER 14 GAUGE WIRE T-TABS (C1184)

24-0020-01-XXX  
-XXX = LENGTH IN INCHES  
DATA TO VISITOR TEAM NAME PANEL

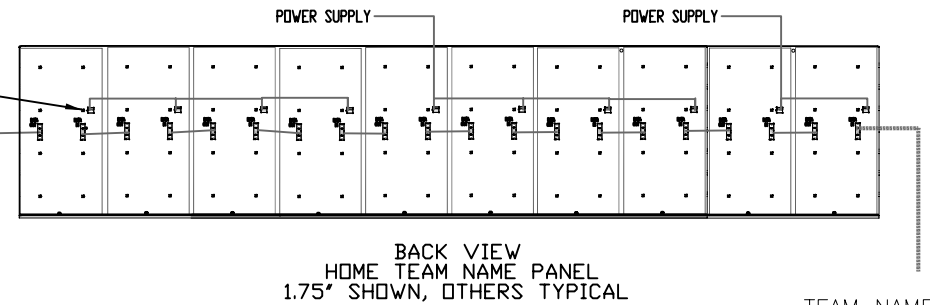

**TRANS·LUX**

1700 DELAWARE AVE.  
DES MOINES, IA 50317

THIS DOCUMENT CONTAINS TRANS-LUX PROPRIETARY INFORMATION. ANY DISCLOSURE, USE OR DUPLICATION OF THE DOCUMENT OR OF ANY INFORMATION CONTAINED THEREIN FOR OTHER THAN THE SPECIFIC PURPOSE FOR WHICH IT WAS DISCLOSED IS EXPRESSLY PROHIBITED, EXCEPT AS MAY BE OTHERWISE AGREED TO IN WRITING. COPYRIGHT 2003.

TITLE <b>TYPICAL WIRING CAPTIVE TEAM NAMES</b>	DRAWN BY DLS	MODEL: <b>A</b>
	DATE 1/31/05	
	SCALE NONE	
DWG. NO. <b>24-3000-01</b>		

B	POWER SUPPLY UPDATE PER CARD RATIO ON DERATING	6-8-07	NAP
A	ADDED 14 GAUGE WIRE INFORMATION AND T-TABS	11-30-06	NAP
OR	ORIGINAL RELEASE	1/31/05	DLS
REV.#	APTIVUE	DATE	BY



A BLANK SETTING IS OFF

SWITCH 1 SETTINGS	1	2	3	4	5	6	7	8
SCOREBOARD	ON							
SHOT TIMER		ON						
TEAM NAMES			ON					

TEAM NAMES	32 COLUMNS	40 COLUMNS	48 COLUMNS
	ON	ON	ON
		ON	ON
			ON

DATA FLOW OPTIONS

CONTIGUOUS DATA	MP70 DATA OUT
	ON
	ON

SWITCH 2 SETTINGS	1	2	3	4	5	6	7	8
8 ROW TEAM NAME								ON
7 ROW TEAM NAME								

SWITCH 3 SETTINGS	1	2	3	4	SWITCH 2, 3, 4, NO ASSIGNED FUNCTION
ASP TEAM NAME DATA	ON				
CAPTIVE TEAM NAME DATA					



PLACE ON INSIDE OF LID OF 60-0013-02

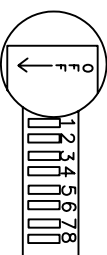

REF. 14-0012-01 FOR COMPLETE SWITCH SETTINGS

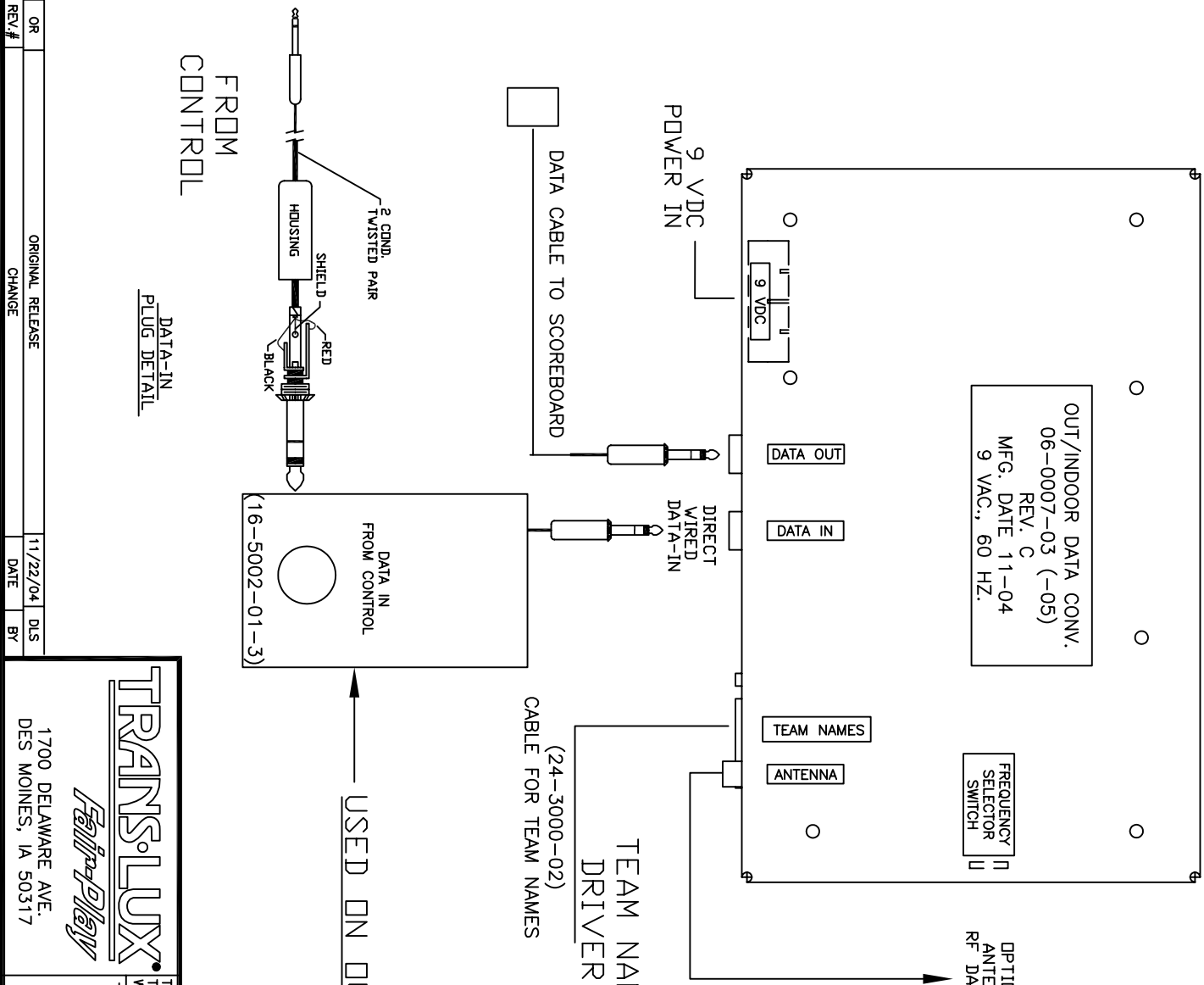

**TRANS-LUX**  
*Fuller & Alley*

1700 DELAWARE AVE.  
 DES MOINES, IA 50317

THIS DOCUMENT CONTAINS FAIR-PLAY PROPRIETARY INFORMATION. ANY DISCLOSURE, USE OR DUPLICATION OF THE DOCUMENT OR OF ANY INFORMATION CONTAINED THEREIN FOR OTHER THAN THE SPECIFIC PURPOSE FOR WHICH IT WAS DISCLOSED IS EXPRESSLY PROHIBITED, EXCEPT AS MAY BE OTHERWISE AGREED TO IN WRITING.

TYPICAL CONNECTIONS  
 OUT/INDOOR DATA CONVERTER BOX

TITLE	DRAWN BY	MODEL:
	DLS	A
	DATE	
	11/22/04	
	SCALE	
	NONE	
	DWG. NO.	
	06-1013-04	

OR ORIGINAL RELEASE CHANGE  
 11/22/04 DLS  
 DATE BY

# **COLUMNS and FOOTINGS**

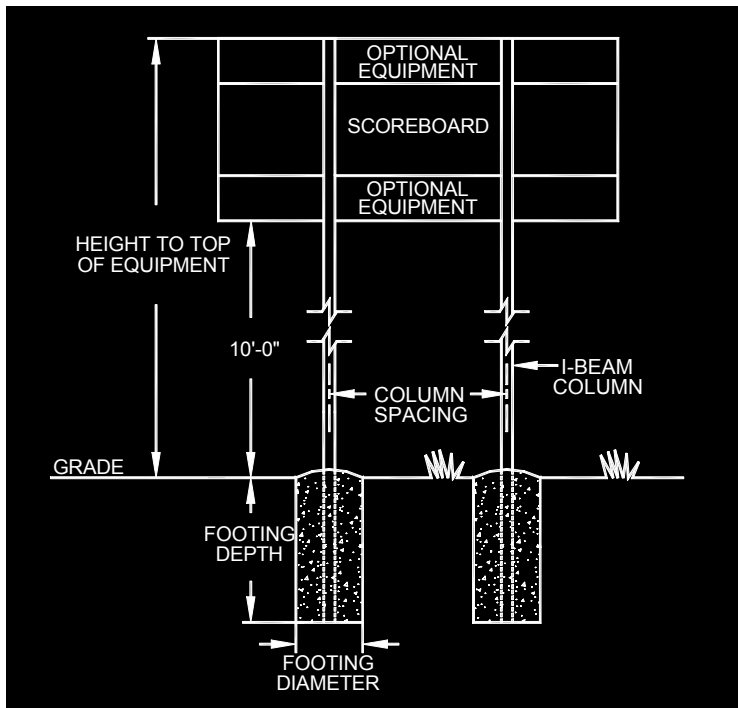

- Notes: Read thoroughly before selecting columns & footings.
- Reference chart on back side for columns and footings.
- The column length equals all component heights + 10'-0" (above grade) + footing depth. See item "A" below if installing a top mounted pendant sign.
- This chart does not support 2-sided installations.
- **Columns and footings are selected for locating scoreboard & components 10'-0" above grade. Wind load: 30psf (80 mph). Soil: average with allowable stresses of 2500 psf.**
- **Design should be altered for different soil conditions, clearance, or local codes.**
- **If your scoreboard size is not listed check with your local Fair-Play representative or seek the services of a local Engineer. This chart does not support equipment with end signs.**
- Reference your installation Manual for back view hanger details and proper column spacing.

"A" When calculating column length, do not include any top mounted Pendant sign models. These signs fasten to the edge of the scoreboard and do not require columns.

- *While Fair-Play believes the instructions contained herein are accurate and correct, in light of varying soil and other conditions, Fair-Play does not warrant the accuracy or correctness of such instructions and there are no warranties, expressed or implied including but not limited to any warranties of merchantability or fitness for a particular purpose.*
- *In no event shall Fair-Play be liable to dealer or its customer for any indirect, special or consequential damages or lost profits arising out of or related to this sale or the performance or breach thereof even if Fair-Play has been advised of the possibility thereof. Fair-Play's liability to dealer, if any, in connection with this sale shall in no event exceed the total amount paid by dealer for the scoreboard & sign equipment furnished by Fair-Play.*

# **COLUMNS and FOOTINGS CHART**

Length of Scoreboard	8'	8'-6"	9'	10'	12'	14'	16'	18'	20'	24'	27'	32'	36'	45'
<b># of Columns Spacing</b>	2 4'-0"	2 4'-3"	2 4'-6"	2 5'-0"	2 6'-0"	2 7'-0"	2 8'-0"	2 9'-0"	2 10'-0"	2 12'-0"	2 13'-6"	3 10'-6"	4 9'-0"	5 9'-0"
<b>Height from grade to top of equipment</b>														
<b>13-14 ft</b>	W6 X 9 2'-0" dia 4'-6" deep	W6 X 9 2'-0" dia 4'-6" deep	W6 X 9 2'-0" dia 4'-6" deep	W6 X 9 2'-0" dia 5'-0" deep	W6 X 9 2'-0" dia 5'-0" deep	W8 X 10 2'-6" dia 5'-0" deep	W10 X 12 2'-6" dia 5'-0" deep	W10 X 12 2'-6" dia 5'-6" deep	W8 X 13 2'-6" dia 5'-6" deep	W8 X 13 2'-6" dia 6'-0" deep	W8 X 15 2'-6" dia 6'-6" deep	W8 X 13 2'-6" dia 6'-0" deep	W10 X 13 2'-6" dia 6'-0" deep	W10 X 13 2'-6" dia 6'-0" deep
<b>15-16 ft</b>	W8 X 10 2'-6" dia 5'-0" deep	W8 X 10 2'-6" dia 5'-0" deep	W10 X 12 2'-6" dia 5'-0" deep	W8 X 13 2'-6" dia 5'-0" deep	W8 X 13 2'-6" dia 5'-6" deep	W10 X 15 2'-6" dia 6'-0" deep	W10 X 15 2'-6" dia 6'-0" deep	W10 X 17 2'-6" dia 6'-6" deep	W10 X 17 2'-6" dia 6'-6" deep	W10 X 19 2'-6" dia 7'-0" deep	W10 X 19 2'-6" dia 7'-6" deep	W8 X 18 2'-6" dia 7'-0" deep	W8 X 15 2'-6" dia 6'-6" deep	W8 X 15 2'-6" dia 6'-6" deep
<b>17-18 ft</b>	W8 X 13 2'-6" dia 5'-6" deep	W10 X 15 2'-6" dia 5'-6" deep	W8 X 15 2'-6" dia 5'-6" deep	W12 X 16 2'-6" dia 6'-0" deep	W8 X 15 2'-6" dia 6'-0" deep	W10 X 17 2'-6" dia 6'-6" deep	W12 X 19 2'-6" dia 7'-0" deep	W10 X 19 2'-6" dia 7'-0" deep	W8 X 21 2'-6" dia 7'-6" deep	W10 X 2 2'-6" dia 8'-0" deep	W10 X 22 2'-6" dia 8'-6" deep	W8 X 21 2'-6" dia 7'-6" deep	W10 X 19 2'-6" dia 7'-0" deep	W10 X 19 2'-6" dia 7'-0" deep
<b>19-20 ft</b>	W8 X 15 2'-6" dia 6'-0" deep	W10 X 17 2'-6" dia 6'-0" deep	W10 X 17 2'-6" dia 6'-0" deep	W12 X 19 2'-6" dia 6'-6" deep	W10 X 19 2'-6" dia 7'-0" deep	W8 X 21 2'-6" dia 7'-6" deep	W12 X 22 2'-6" dia 7'-6" deep	W10 X 22 2'-6" dia 8'-0" deep	W10 X 22 2'-6" dia 8'-6" deep	W10 X 30 2'-6" dia 9'-0" deep	W10 X 26 2'-6" dia 9'-0" deep	W10 X 26 2'-6" dia 8'-6" deep	W10 X 22 2'-6" dia 8'-0" deep	W10 X 22 2'-6" dia 8'-0" deep
<b>21-22 ft</b>	W10 X 19 2'-6" dia 6'-6" deep	W8 X 18 2'-6" dia 6'-6" deep	W10 X 19 2'-6" dia 6'-6" deep	W12 X 22 2'-6" dia 7'-0" deep	W10 X 22 2'-6" dia 7'-6" deep	W10 X 22 2'-6" dia 8'-0" deep	W12 X 26 3'-0" dia 7'-6" deep	W10 X 30 2'-6" dia 8'-6" deep	W10 X 26 2'-6" dia 9'-0" deep	W10 X 39 2'-6" dia 9'-6" deep	W12 X 30 3'-0" dia 9'-6" deep	W12 X 30 3'-0" dia 8'-6" deep	W12 X 26 3'-0" dia 8'-0" deep	W12 X 26 3'-0" dia 8'-0" deep
<b>23-24 ft</b>	W10 X 22 2'-6" dia 7'-0" deep	W10 X 22 2'-6" dia 7'-0" deep	W10 X 22 2'-6" dia 7'-0" deep	W10 X 22 2'-6" dia 7'-6" deep	W10 X 26 2'-6" dia 8'-0" deep	W14 X 30 3'-0" dia 8'-0" deep	W12 X 26 3'-0" dia 8'-6" deep	W12 X 30 3'-0" dia 8'-6" deep	W12 X 30 3'-0" dia 9'-0" deep	W10 X 45 2'-6" dia 10'-6" deep	W12 X 35 3'-0" dia 10'-0" deep	W12 X 35 3'-0" dia 9'-0" deep	W10 X 30 2'-6" dia 9'-6" deep	W10 X 30 2'-6" dia 9'-6" deep
<b>25-26 ft</b>	W10 X 22 2'-6" dia 7'-6" deep	W10 X 22 2'-6" dia 7'-6" deep	W10 X 26 2'-6" dia 7'-6" deep	W10 X 26 2'-6" dia 8'-0" deep	W10 X 26 2'-6" dia 8'-6" deep	W14 X 34 3'-0" dia 8'-6" deep	W12 X 30 3'-0" dia 9'-0" deep	W12 X 35 3'-0" dia 9'-0" deep	W12 X 35 3'-0" dia 9'-6" deep	W12 X 50 3'-0" dia 10'-0" deep	W16 X 45 3'-6" dia 10'-0" deep	W12 X 40 3'-0" dia 10'-0" deep	W12 X 35 3'-0" dia 9'-0" deep	W12 X 35 3'-0" dia 9'-0" deep
<b>27-28 ft</b>	W10 X 26 2'-6" dia 8'-0" deep	W10 X 26 2'-6" dia 8'-0" deep	W10 X 26 2'-6" dia 8'-0" deep	W12 X 30 3'-0" dia 8'-0" deep	W12 X 30 3'-0" dia 8'-6" deep	W14 X 38 3'-0" dia 9'-0" deep	W12 X 35 3'-0" dia 9'-6" deep	W12 X 40 3'-0" dia 10'-0" deep	W12 X 40 3'-0" dia 10'-0" deep	W12 X 53 3'-0" dia 11'-0" deep	W18 X 50 3'-6" dia 10'-6" deep	W14 X 43 3'-0" dia 10'-6" deep	W12 X 35 3'-0" dia 10'-0" deep	W12 X 35 3'-0" dia 10'-0" deep
<b>29-30 ft</b>	W10 X 30 2'-6" dia 8'-0" deep	W10 X 30 2'-6" dia 8'-6" deep	W10 X 30 2'-6" dia 8'-6" deep	W12 X 35 3'-0" dia 8'-6" deep	W12 X 35 3'-0" dia 9'-0" deep	W14 X 38 3'-0" dia 9'-6" deep	W12 X 40 3'-0" dia 10'-0" deep	W12 X 50 3'-0" dia 10'-6" deep	W14 X 48 3'-0" dia 10'-6" deep	W14 X 53 3'-6" dia 11'-0" deep	W18 X 55 3'-6" dia 11'-6" deep	W16 X 50 3'-6" dia 10'-6" deep	W14 X 43 3'-0" dia 10'-6" deep	W14 X 43 3'-0" dia 10'-6" deep
<b>31-32 ft</b>	W12 X 30 3'-0" dia 8'-0" deep	W12 X 30 3'-0" dia 8'-0" deep	W12 X 35 3'-0" dia 8'-6" deep	W14 X 38 3'-0" dia 8'-6" deep	W14 X 38 3'-0" dia 9'-6" deep	W14 X 43 3'-0" dia 10'-0" deep	W12 X 45 3'-0" dia 10'-6" deep	W14 X 53 3'-6" dia 10'-0" deep	W14 X 48 3'-0" dia 11'-0" deep	W14 X 61 3'-6" dia 11'-6" deep	W18 X 60 3'-6" dia 12'-0" deep	W18 X 55 3'-6" dia 11'-0" deep	W14 X 43 3'-0" dia 11'-0" deep	W14 X 43 3'-0" dia 11'-0" deep
<b>33-34 ft</b>	W14 X 34 3'-0" dia 8'-6" deep	W12 X 35 3'-0" dia 8'-6" deep	W12 X 35 3'-0" dia 9'-0" deep	W14 X 38 3'-0" dia 9'-0" deep	W12 X 45 3'-0" dia 9'-6" deep	W14 X 43 3'-0" dia 10'-6" deep	W12 X 53 3'-0" dia 11'-0" deep	W14 X 53 3'-6" dia 10'-6" deep	W14 X 53 3'-6" dia 11'-0" deep	W14 X 61 3'-6" dia 12'-0" deep	W18 X 65 3'-6" dia 12'-6" deep	W18 X 60 3'-6" dia 11'-6" deep	W14 X 48 3'-0" dia 11'-0" deep	W14 X 48 3'-0" dia 11'-0" deep

## STANDARD COLUMNS and FOOTINGS FOR FOOTBALL LED SCOREBOARDS

Height from top of equipment to grade	Length of Scoreboard							
	14'	18'	20'	26'	27'	32'	36'	45'
# of Columns Spacing	2 7'-0"	2 9'-0"	2 10'-0"	2 13'-0"	2 13'-6"	3 10'-6"	4 9'-0"	5 9'-0"
FB-8114-2	W10 X 15 2'-6" dia 6'-0" deep							
FB-8120(TK)-2 FB-8120TK-40L-2 FB-8120TKH-2			W8 X 21 2'-6" dia 7'-6" deep					
FB-8126(TK)(TKH)-2 FB-8126(TK)(TKH)-40L-2				W10 X 22 2'-6" dia 8'-6" deep				
FB-8127(TK)(TKH)-2 FB-8127(TK)(TKH)-40L-2 FB-8127(TK)(TKH)-48L-2					W10 X 22 2'-6" dia 8'-6" deep			
FB-8132(TK)(TKH)-2 FB-8132(TK)(TKH)-40L-2 FB-8132(TK)(TKH)-48L-2						W8 X 21 2'-6" dia 7'-6" deep		
FB-8136(TK)(TKH)-2 FB-8136(TK)-40L-2 FB-8136(TK)-48L-2							W10 X 22 2'-6" dia 8'-0" deep	
FB-8145(TKH)-48L-2								W10 X 22 2'-6" dia 8'-0" deep
FB-8165-40L-2			W12 X 40 3'-0" dia 10'-0" deep					
FB-8218(TK)-2 FB-8318-2 FB-8418TKH-2		W10 X 19 2'-6" dia 7'-0" deep						

**FOOTBALL LED SCOREBOARD DATA CHART**

	SCBD TYPE	SIZE			EST. WT. (LBS.)	TOTAL AMPS	CONTROL		HANGER
		"A" LENGTH	"B" HEIGHT	OVERALL DEPTH			TYPE	TYPE	
FB-8114-2	25	14'-0"	6'-0"	10"	350	2	1, 2	6	W=7'-0", X=5'-9 1/2"
FB-8120-2	23	20'-0"	7'-6"	10"	500	5	1	6	W=10'-0", X=7'-3 1/2"
FB-8120-40L-2	23	20'-0"	7'-6"	10"	500	8	1	6	W=10'-0", X=7'-3 1/2"
FB-8120TK-2	23	20'-0"	7'-6"	10"	640	6	1	6	W=10'-0", X=7'-3 1/2"
FB-8120TK-40L-2	23	20'-0"	7'-6"	10"	640	8	1	6	W=10'-0", X=7'-3 1/2"
FB-8120TKH-2	23	20'-0"	7'-6"	10"	640	6	1	6	W=10'-0", X=7'-3 1/2"
FB-8126-2	23	26'-0"	8'-0"	10"	1,105	6	1	6	W=13'-0", X=7'-9 1/2"
FB-8126TK-2	23	26'-0"	8'-0"	10"	1,105	6	1	6	W=13'-0", X=7'-9 1/2"
FB-8126-40L-2	23	26'-0"	8'-0"	10"	1,105	11	1	6	W=13'-0", X=7'-9 1/2"
FB-8126TKH-2	23	26'-0"	8'-0"	10"	1,105	6	1	6	W=13'-0", X=7'-9 1/2"
FB-8126TKH-40L-2	23	26'-0"	8'-0"	10"	1,105	11	1	6	W=13'-0", X=7'-9 1/2"
FB-8127-2	23	27'-0"	8'-0"	10"	920	6	1	6	W=13'-6", X=7'-9 1/2"
FB-8127-40L-2	23	27'-0"	8'-0"	10"	1,200	11	1	6	W=13'-6", X=7'-9 1/2"
FB-8127-48L-2	23	27'-0"	8'-0"	10"	1,200	11	1	6	W=13'-6", X=7'-9 1/2"
FB-8127TK-2	23	27'-0"	8'-0"	10"	920	6	1	6	W=13'-6", X=7'-9 1/2"
FB-8127TK-40L-2	23	27'-0"	8'-0"	10"	1,200	11	1	6	W=13'-6", X=7'-9 1/2"
FB-8127TK-48L-2	23	27'-0"	8'-0"	10"	1,200	12	1	6	W=13'-6", X=7'-9 1/2"
FB-8127TKH-2	23	27'-0"	8'-0"	10"	920	7	1	6	W=13'-6", X=7'-9 1/2"
FB-8127TKH-40L-2	23	27'-0"	8'-0"	10"	1,200	11	1	6	W=13'-6", X=7'-9 1/2"
FB-8127TKH-48L-2	23	27'-0"	8'-0"	10"	1,200	12	1	6	W=13'-6", X=7'-9 1/2"
FB-8132-2	23	32'-0"	8'-0"	10"	1,100	6	1	6	W=10'-6",10'-6",X=7'-9 1/2"
FB-8132-40L-2	23	32'-0"	8'-0"	10"	1,360	11	1	6	W=10'-6",10'-6",X=7'-9 1/2"
FB-8132-48L-2	23	32'-0"	8'-0"	10"	1,360	12	1	6	W=10'-6",10'-6",X=7'-9 1/2"
FB-8132TK-2	23	32'-0"	8'-0"	10"	1,100	6	1	6	W=10'-6",10'-6",X=7'-9 1/2"
FB-8132TK-40L-2	23	32'-0"	8'-0"	10"	1,360	11	1	6	W=10'-6",10'-6",X=7'-9 1/2"
FB-8132TK-48L-2	23	32'-0"	8'-0"	10"	1,360	12	1	6	W=10'-6",10'-6",X=7'-9 1/2"
FB-8132TKH-2	23	32'-0"	8'-0"	10"	1,100	7	1	6	W=10'-6",10'-6",X=7'-9 1/2"
FB-8132TKH-40L-2	23	32'-0"	8'-0"	10"	1,360	11	1	6	W=10'-6",10'-6",X=7'-9 1/2"
FB-8132TKH-48L-2	23	32'-0"	8'-0"	10"	1,360	12	1	6	W=10'-6",10'-6",X=7'-9 1/2"
FB-8136-2	24	36'-0"	10'-0"	10.25"	1,618	9	1	3	W=9'-0", 9'-0", 9'-0", X=5'-11", 2'-11"
FB-8136-40L-2	24	36'-0"	10'-0"	10.25"	1,618	20	1	3	W=9'-0", 9'-0", 9'-0", X=5'-11", 2'-11"
FB-8136-48L-2	24	36'-0"	10'-0"	10.25"	2,550	21	1	3	W=9'-0", 9'-0", 9'-0", X=5'-11", 2'-11"
FB-8136TK-2	24	36'-0"	10'-0"	10.25"	1,550	10	1	3	W=9'-0", 9'-0", 9'-0", X=5'-11", 2'-11"
FB-8136TK-40L-2	24	36'-0"	10'-0"	10.25"	1,550	21	1	3	W=9'-0", 9'-0", 9'-0", X=5'-11", 2'-11"
FB-8136TK-48L-2	24	36'-0"	10'-0"	10.25"	1,550	22	1	3	W=9'-0", 9'-0", 9'-0", X=5'-11", 2'-11"
FB-8136TKH-2	24	36'-0"	10'-0"	10.25"	1,550	11	1	3	W=9'-0", 9'-0", 9'-0", X=5'-11", 2'-11"
FB-8145-48L-2	24	45'-0"	10'-0"	10.25"	2,391	21	1	3	W=9',9',9',9' X=5'-11"
FB-8145TKH-48L-2	24	45'-0"	10'-0"	10.25"	1,700	23	1	3	W=9',9',9',9' X=5'-11"
FB-8218-2	25	18'-0"	7'-6"	10"	575	4	1, 2	6	W=9'-0", X=7'-3 1/2"
FB-8218TK-2	26	18'-0"	7'-6"	10"	575	5	1, 2	6	W=9'-0", X=7'-3 1/2"
FB-8318-2	23	18'-0"	7'-6"	10"	575	5	1	6	W=9'-0", X=7'-3 1/2"
FB-8165-40L-2	24	20'-0"	17'-0"	10.25"	1,358	14	1	4	W=5'-11",7",5'-11",7",3'-5"
FB-8418TKH-2	23	18'-0"	7'-6"	10"	575	5	1	6	W=9'-0", X=7'-3 1/2"
SC-1418		27'-0"	3'-0"	10"	431	2	3	6	

**POWER-VAC:** 120 VAC, 60 Hz, 2 WIRE

**HANGER TYPE:** 3= HAT BRACKET  
4= FLAT BRACKET  
6= STANDARD "J"

**CONTROLS:** 1=MP-70  
2=MP-50  
3=MP-70-106

WIRELESS OPTIONAL ON ALL SCOREBOARD MODELS IN CHART

**LAMP TYPE:** LED

**CONTROL CABLE:** C0550, 1-PAIR, 22 GAUGE ((1) PER SCOREBOARD)

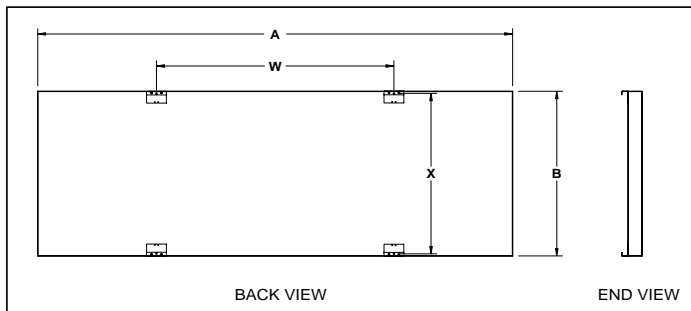



# ***Fair-Play***

**A TRANS·LUX® COMPANY**

## **TROUBLE SHOOTING OUTDOOR SCOREBOARDS**

**Problem:**

**Scoreboard does not light or function.**

**Solution:**

1. Check scoreboard breaker.
2. Make sure connectors on processors are seated properly.
3. Check power at the scoreboard. If there is no power at the scoreboard, call an electrician.

**Random LED's, scoreboard not functioning correctly.**

1. Check to see if the controller is operating properly. Check power at the controller location. Check data cable plug and connectors.
2. Plug the controller into the data in on the processor located in the scoreboard. If the scoreboard runs, you need to replace the data cable.
3. Install spare processor, if this works send in old processor for repair.
4. If the above steps don't work, send in the controller for repair.

**Miscellaneous LED's not lighting or staying lit all the time**

1. If a complete digit is not working, check the connector on the processor.
2. If a single LED digit is not lighting, change the entire PCA card. Replace with correct part number located on back of card.
3. If lamps are staying lit, install spare processor or call authorized Fair-Play dealer.

# *Fair-Play*

**A TRANS-LUX® COMPANY**

**TRANS-LUX MIDWEST CORPORATION  
d.b.a. Fair-Play Scoreboards**

## **LIMITED SCOREBOARD WARRANTY**

Fair-Play provides a limited five-year warranty when its permanently mounted scoreboards and scoreboard controllers are operated and maintained according to the owner's instructions furnished with the equipment. Such limited warranty is two years for portable scoreboards. This warranty covers all electronic components, including LEDs, for five or two years as applicable from the date of invoice that prove to be defective in material or workmanship. Our #161 and #655-type indoor lamps are warranted on a ten-year factory exchange basis from the date of invoice.

Warranted for one year are mechanical control panel switches, connectors, horns and visual goal indicators. Wireless control components are warranted for two years. Wireless control devices even if not defective may not function reliably in certain environments or otherwise due to outside causes beyond Seller's control, including but not limited to cell phones or portable computers. In the event it is determined a wireless device during the ninety (90) day period following shipment does not function in accordance with its specification without repeated errors or is otherwise consistently unreliable, and Seller determines repair or replacement thereof is not likely to improve performance, at Purchaser's request, upon return to Seller postage prepaid in like new condition within such time period, Seller's sole obligation shall be to refund the entire purchase price of such device. Thereafter Seller's sole obligation shall be to repair or replace, other non-wireless defective components for the balance of the warranty period without responsibility or liability for claims for unreliable performance not due to defects. Batteries, battery packs and battery recharging equipment are warranted for thirty (30) days, except for defects arising from misuse, abuse, negligence or other exclusions set forth below. In no event will Fair-Play have any obligation for any damage caused by defective batteries, battery packs and battery recharging equipment. Also warranted for 30 days are outdoor portable scoreboard carts.

Fair-Play's sole obligation during the applicable warranty period is to repair or replace any defective items. Defective assemblies or components are to be returned postage prepaid to Fair-Play's service center, after obtaining a return authorization number, for repair or replacement at no cost to the owner during the applicable warranty period. Replacement parts may be either new or like-new. Return shipping costs after repair will be paid by Seller except for overnight, express or special shipping costs which shall be paid by Purchaser. Excluded from this warranty are fuses, major components provided by other manufacturers including, but not limited to, computers, rotating signs, power distribution panels, disconnect switches and components of rear-illuminated or lighted signs. The other manufacturer's warranty will apply to such components. Also excluded from this warranty are electronic signs or message centers and related controls. These items are covered by their own specific warranty. The warranty will be suspended as to units for which the purchaser is in default of payment in accordance with the agreed Terms of Payment. In the event the purchaser remits the full amount due in immediately available funds on a unit for which the warranty was suspended, the warranty will be reinstated for the remaining balance of the original warranty period without allowance for the time period of the suspension. The warranty does not apply to units that have been stolen.

THIS WARRANTY IS IN LIEU OF ALL OTHER WARRANTIES OF SELLER, EXPRESS OR IMPLIED, AND, EXCEPT TO THE EXTENT HEREIN PROVIDED, SELLER DOES NOT MAKE ANY WARRANTY WHATSOEVER INCLUDING, WITHOUT LIMITATION, ANY WARRANTY OF MERCHANTABILITY OR FITNESS FOR ANY PARTICULAR USE OR PURPOSE.

Fair-Play shall not be liable for any incidental, special or consequential damages nor any other loss that may arise in connection with its warranted equipment or any claims under this warranty. (Individual states may have limitations on the length of implied warranties.)

This warranty does not cover shipping damages or problems which result from improper installation of your equipment. (Promptly inspect shipment for visible or concealed damages and report immediately to the delivering carrier.)

Under no circumstances shall this warranty apply if the warranted products have been subject to abuse, misuse, neglect, sabotage, acts of terrorists, negligence, accident, or any casualties or abnormal conditions, including without limitation fire, civil disorders, war, flood, lightning or acts of God. Nor does this warranty cover labor or damage resulting from, or problems caused by, any repair, alteration, modification, or adjustment of the warranted scoreboards or components not performed by Fair-Play.

This warranty extends only to the original end-user purchaser of the warranted products, and is not transferable. For information on extended warranties contact your Fair-Play dealer. In the event authorized Fair-Play dealers make extensions to or provide additional service for Fair-Play products, Fair-Play assumes no liability therefore other than the specific warranty set forth above in this Limited Warranty.

Trans-Lux Midwest Corporation

Fair-Play Scoreboards - A Division of Trans-Lux Midwest Corporation  
For Service contact the Trans-Lux Help Desk  
1700 Delaware Avenue, Des Moines, Iowa 50317  
Telephone: 800-462-2716 • Fax: (515) 263-7105  
Internet Address - [www.fair-play.com](http://www.fair-play.com)

Effective 3-23-07 © 2007, Trans-Lux Midwest, All rights reserved.