

**THE MOST ACCURATE BATTERY POWERED SYSTEM**

# ISOMAG ™

## *The friendly magmeter*

### **ML 145**

(FLOWIZ™ FAMILY)

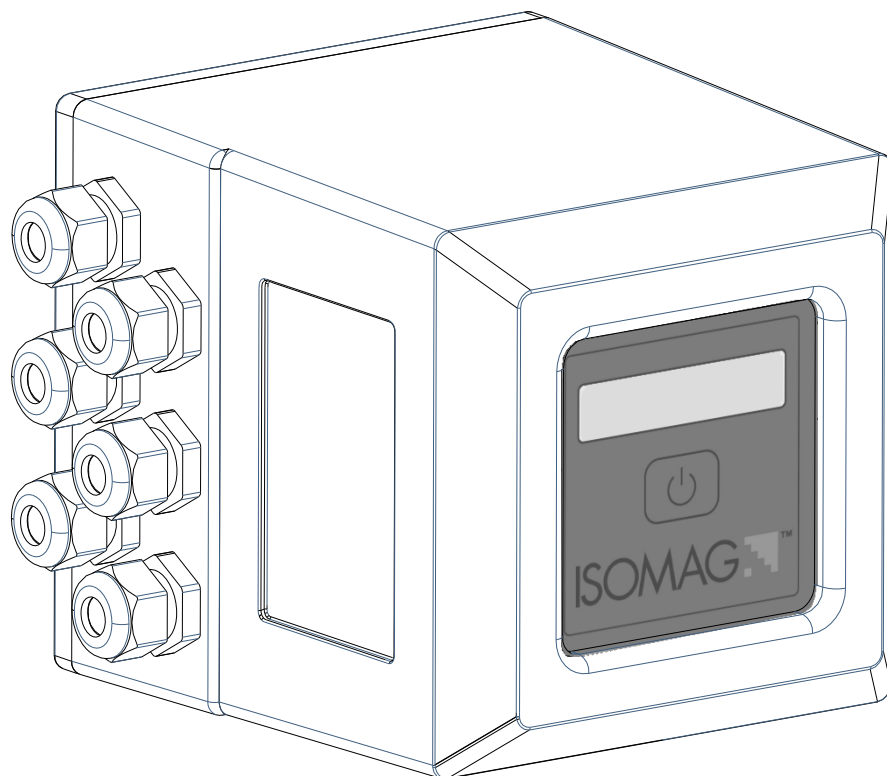

**Electromagnetic converter powered by  
batteries, solar panel or DC power**

Warranty conditions are available on this website:  
[www.isomag.eu](http://www.isomag.eu) only in English version

**ISOIL**   
INDUSTRIA  
*The solutions that count*

# INDEX

|                                  |    |
|----------------------------------|----|
| TECHNICAL DATA .....             | 3  |
| OVERALL FEATURES.....            | 3  |
| STANDARD FEATURES.....           | 3  |
| OPTIONAL FEATURES.....           | 4  |
| ACCURACY.....                    | 4  |
| OVERALL DIMENSIONS.....          | 5  |
| VISUALIZATION PAGES .....        | 6  |
| PCB LAYOUT .....                 | 7  |
| POWER SUPPLY .....               | 8  |
| ELECTRICAL CONNECTIONS .....     | 9  |
| DIGITAL INPUT / OUTPUT .....     | 10 |
| FUNCTION'S LIST.....             | 11 |
| MEASURE / SAMPLE FREQUENCY ..... | 14 |
| BATTERIES CONSUMPTION .....      | 15 |
| POWER TOOL SOFTWARE .....        | 16 |
| USER INTERFACE.....              | 17 |
| DATA LOGGER .....                | 18 |
| ACCURACY TABLE .....             | 19 |
| HOW TO ORDER .....               | 20 |

## TECHNICAL DATA

| <i>OVERALL FEATURES</i>     |  |
|-----------------------------|--|
| <b>Suitable For</b>         | <input type="checkbox"/> <b>ISOMAG sensors UP TP DN 800</b>  |
| <b>Minimum conductivity</b> | <input type="checkbox"/> <b>20 <math>\mu</math>S/cm</b>  |
| <b>Version</b>              | <input type="checkbox"/> <b>Compact</b><br><input type="checkbox"/> <b>Separate</b>                    |
| <b>Power consumption</b>    | <input type="checkbox"/> <b>0.08W With Batteries; Average 0.2W/Max 3W With solar panel or DC power</b> |
| <b>Altitude</b>             | <input type="checkbox"/> <b>-200 m up to 4000 m</b>  |
| <b>Ambient Temperature</b>  | <input type="checkbox"/> <b>-20... +60°C / -4... +140 °F</b>   |
| <b>Humidity Range</b>       | <input type="checkbox"/> <b>0÷100% (IP 67)</b>   |
| <b>Accuracy</b>             | <input type="checkbox"/> <b>See Table</b>  |

| <i>STANDARD FEATURES</i>   |  |
|----------------------------|--|
| <b>Housing materials</b>   | <input type="checkbox"/> <b>Painted Aluminium die casting</b>  |
| <b>Protection Rate</b>     | <input type="checkbox"/> <b>IP 67</b>  |
| <b>Power Supply</b>        | <input type="checkbox"/> <b>Mixed System Batteries and main Power Supply; n° 1 Size D Not Rechargeable Lithium Battery</b> |
| <b>Data Logger</b>         | <input type="checkbox"/> <b>MicroSD Memory Card 2 GBytes</b>   |
| <b>Data storage</b>        | <input type="checkbox"/> <b>F-Ram</b>  |
| <b>Protocols</b>           | <input type="checkbox"/> <b>ETP</b>  |
| <b>Galvanic Isolation</b>  | <input type="checkbox"/> <b>All the inputs/outputs are galvanically isolated from power supply up to 500 V</b>             |
| <b>Programming Plug In</b> | <input type="checkbox"/> <b>Protected plug in for the connection to PC (IF2X interface)</b>                                |
| <b>Bi-Directional</b>      | <input type="checkbox"/> <b>Yes</b>  |
| <b>Dual Range</b>          | <input type="checkbox"/> <b>Yes</b>  |
| <b>Diagnostic Funct.</b>   | <input type="checkbox"/> <b>Yes</b>  |
| <b>Empty Pipe Detect.</b>  | <input type="checkbox"/> <b>Yes</b>  |
| <b>CE Certification</b>    | <input type="checkbox"/> <b>Yes</b>  |

| <b>OPTIONAL FEATURES</b><br>(CHECK FOR MORE DETAILS 'HOW TO ORDER' ON LAST PAGE) |  |
|--|--|
| <b>Housing materials</b>   | <input type="checkbox"/> AISI304   |
| <b>Protection Rate</b>   | <input type="checkbox"/> IP 68   |
| <b>Sensor-Converter Connection Cable</b>   | <input type="checkbox"/> CABLE C015 - C016 (for separate version)                              |
| <b>Wires connections</b>   | <input type="checkbox"/> IP 68 Connectors  |
| <b>LCD Display</b>   | <input type="checkbox"/> Alphanumerical display: 2 lines x 16 characters NO back light         |
| <b>Power Supply</b>  | <input type="checkbox"/> Up to 6 Size D Not Rechargeable Lithium Battery+Main Power :10-30V--- |
| <b>Pulses/Alarm Outputs</b>  | <input type="checkbox"/> N°2 , 50 Hz, 100mA, 40 Vdc  |
| <b>Digital Input</b>   | <input type="checkbox"/> N°1 On/Off Input  |
| <b>Analog Output (NOT galvanically separated from Main Power)</b>                | <input type="checkbox"/> 0/4..20 mA (available ONLY with Main Power Supply)                    |

| <b>ACCURACY</b>                                 |  |
|---|--|
| <b>Measurements tolerance</b>                   | <input type="checkbox"/> Flow rate (volume) = $\pm 0,1\%$ v.l. |
| <b>Accuracy (whole system converter+sensor)</b> | <input type="checkbox"/> See table                             |

# OVERALL DIMENSIONS

## COMPACT VERSION

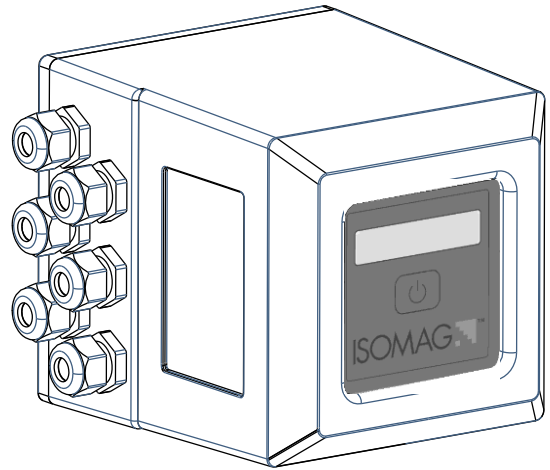
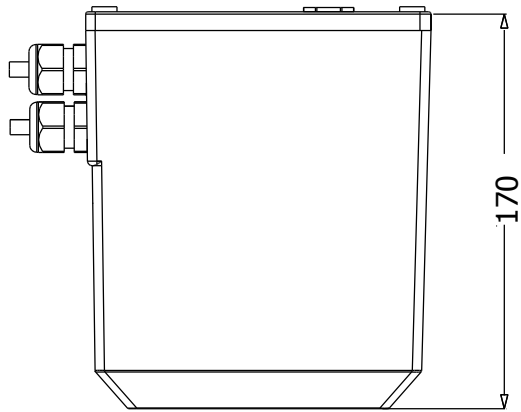

## SEPARATE VERSION

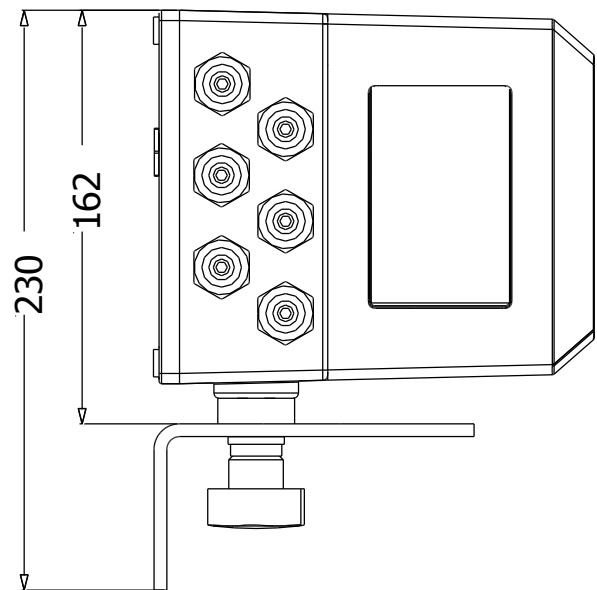
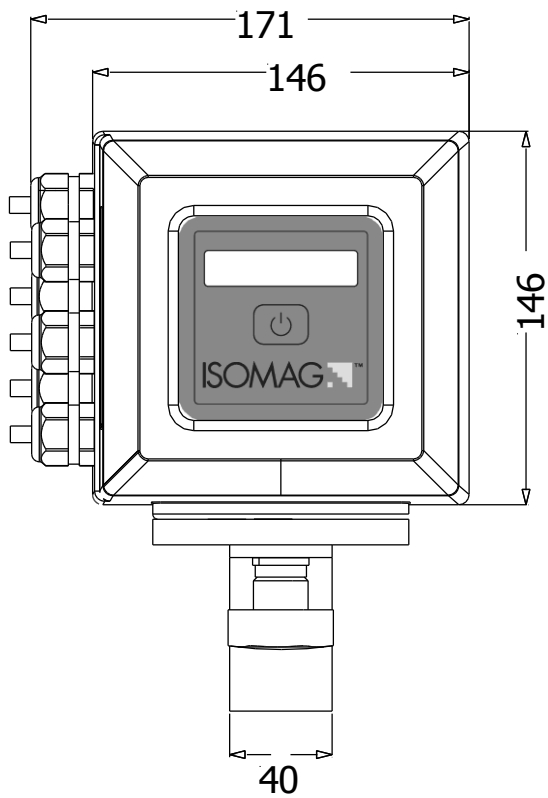

## VISUALIZATION PAGES

Different visualization possibilities by simply pressing a key 

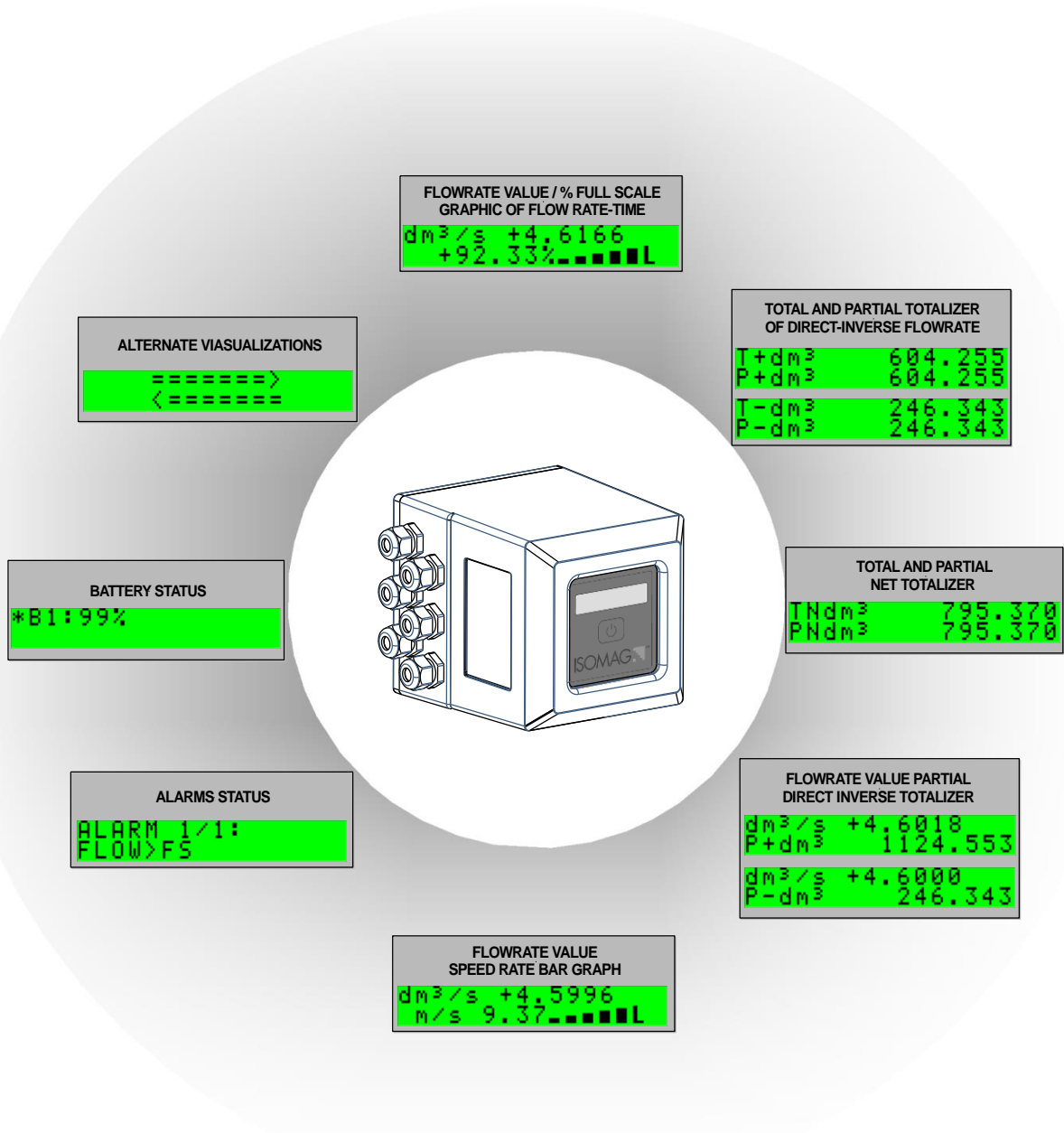

# PCB LAYOUT

SOCKET FOR ALTERNATIVE POWER SUPPLY  
(SOLAR PANEL OR COMMERCIAL BATTERIES)

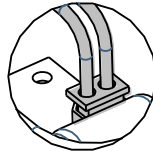

SWITCH ON/OFF CONVERTER DIP-SWITCHES

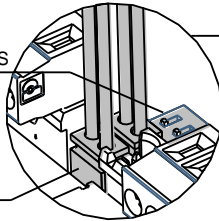

TERMINAL SOCKETS FOR BATTERIES



TERMINAL SOCKETS FOR IF23

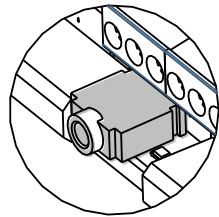

SWITCH ON/OFF INPUT POWER SUPPLY

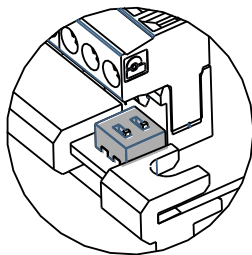

SOCKET FOR SD MEMORY CARD

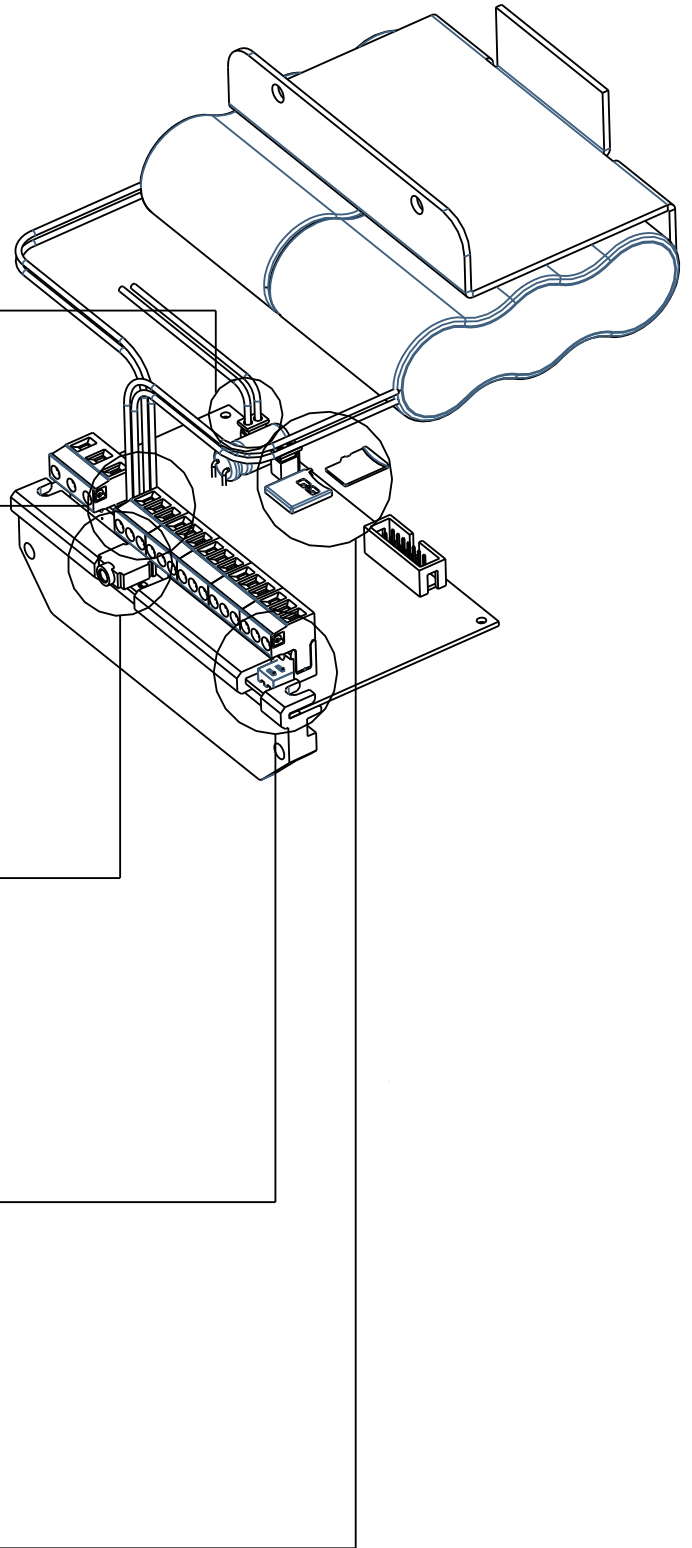
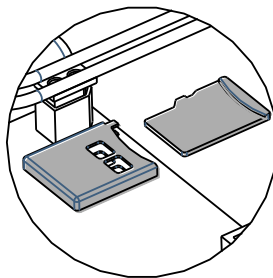

## POWER SUPPLY

### BY MAIN VOLTAGE

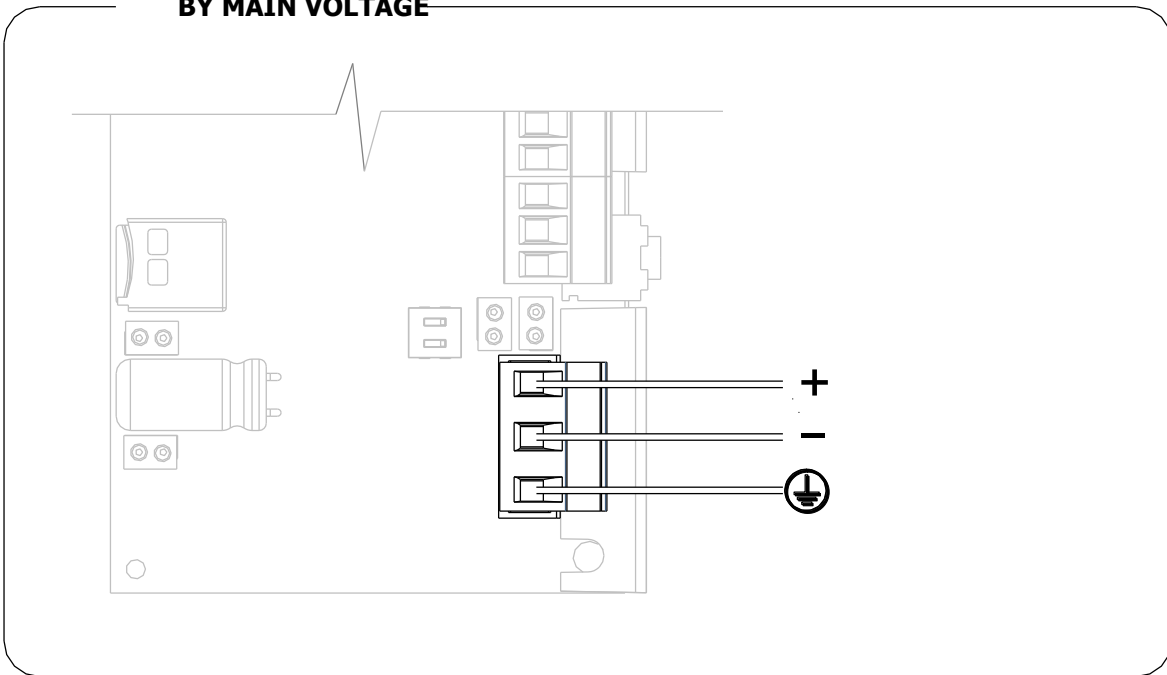

Auto detection of the power source: when main power supply is ON, batteries are excluded and the system operate in continuous sampling mode

### BY BATTERIES

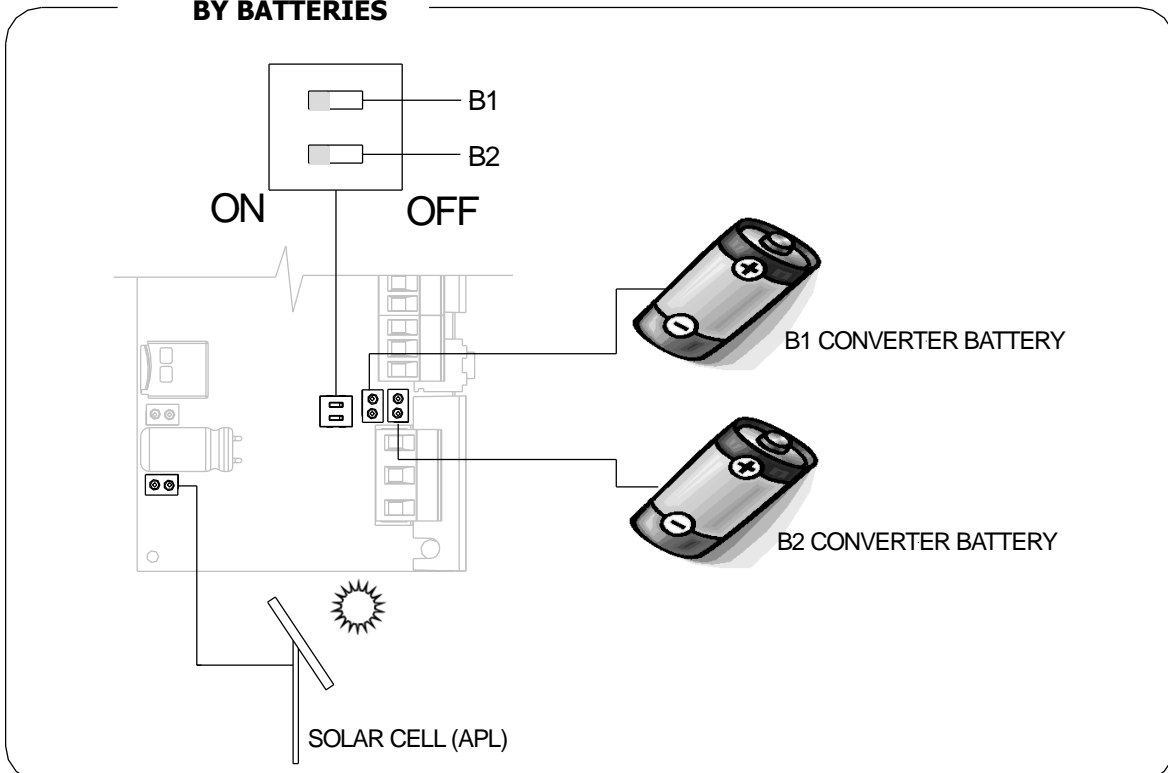

Note : Lithium batteries are subject to special transportation regulations according to "Regulation of Dangerous Goods, UN3090 and UN 3091". Special documentation is required to observe these regulations.



# ELECTRICAL CONNECTIONS

## TERMINAL BLOCK: COMPACT/SEPARATE VERSION

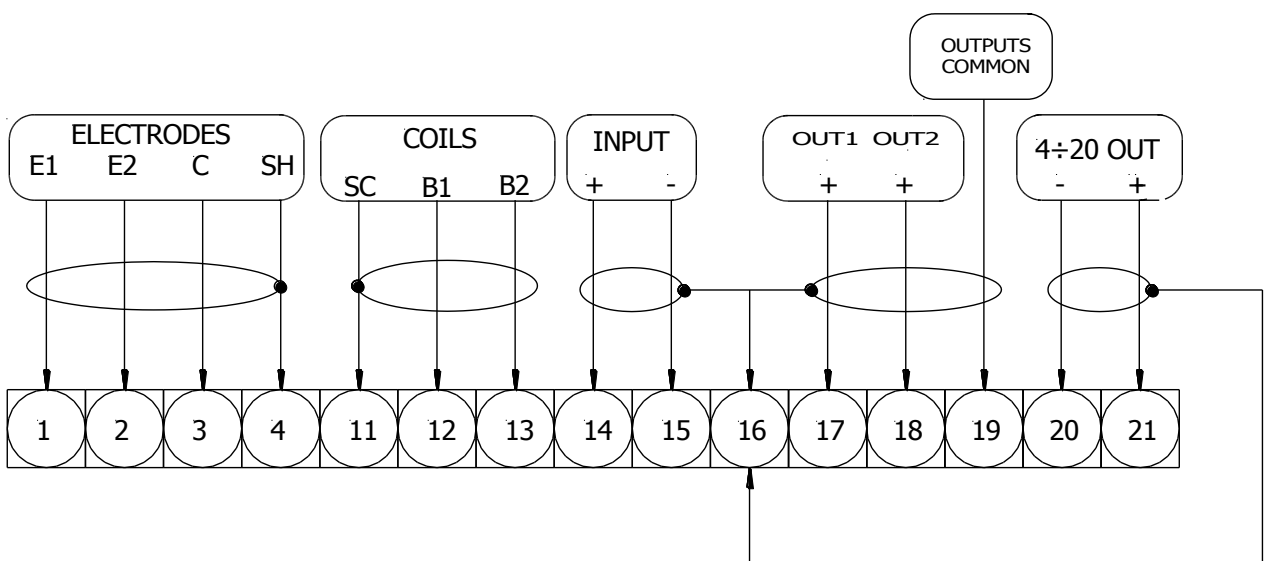
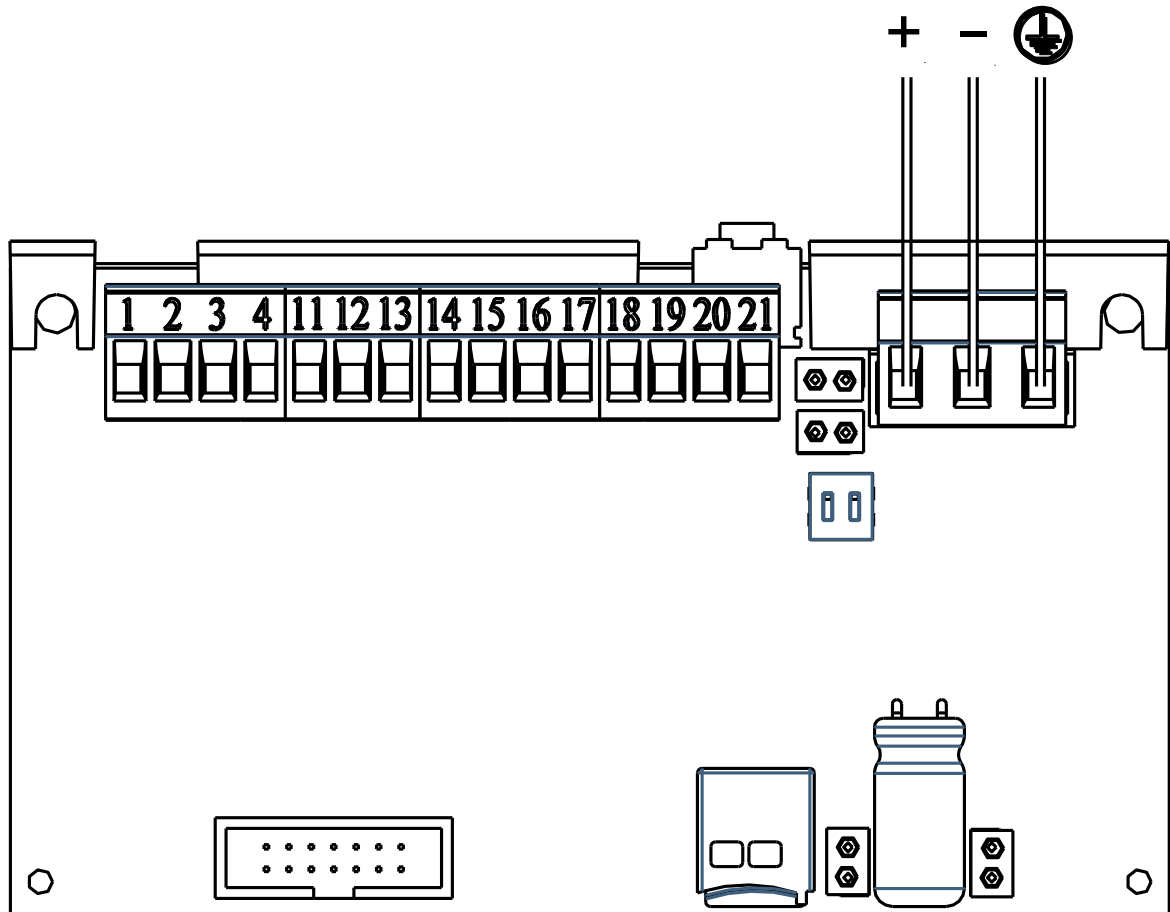

## DIGITAL INPUT / OUTPUT

### ON/OFF OUTPUT

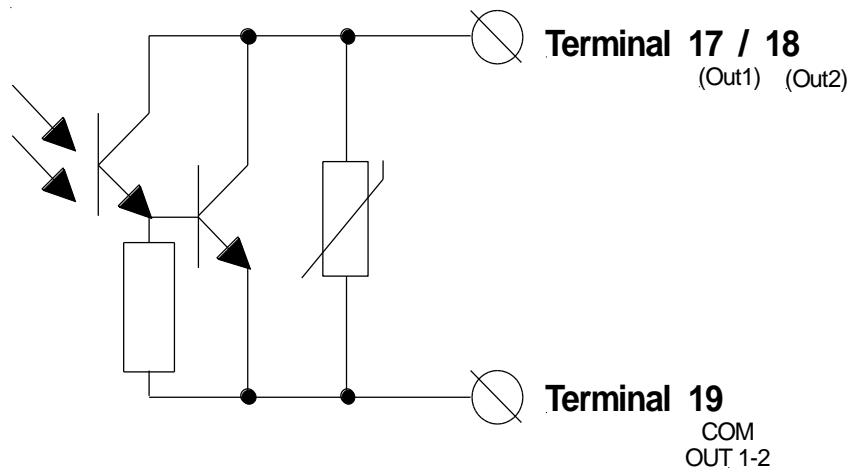

### ON/OFF INPUT

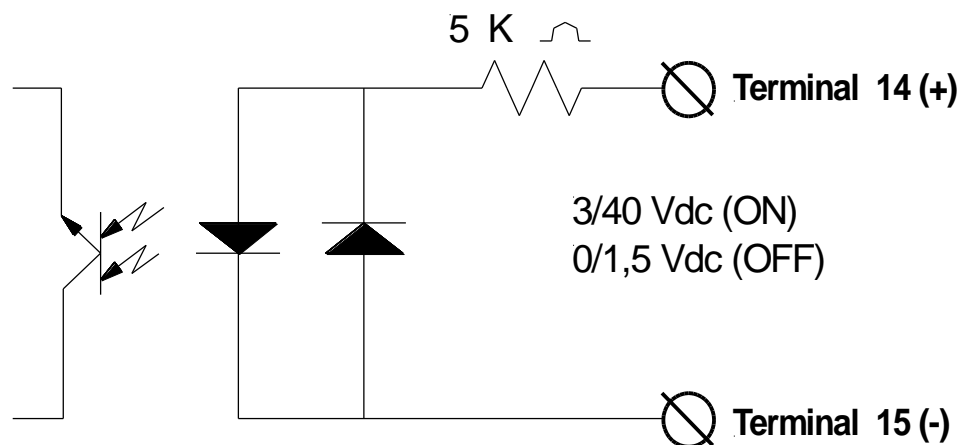

## FUNCTION'S LIST

```

MAIN MENU
1-Sensor
1-SENSOR
ND=mm      00025
KA=        -01.0000
Sens.type= 004
Ins.Position= 0
Ki=        1.0000
Kp=        1.0000
E.P.detect= 0N
E.P.thr.=  100
1Zero cal.
1Zero res.

```

- 1.1 Insert ND of sensor (0-3000)
- 1.2 Calibration data of sensor visualized on sensor's label
- 1.3 Sensors model: Enter the first two characters of the serial number of the sensor
- 1.4 Position for insertion sensors: 0=1/8DN, 1=1/2DN, 2=7/8DN
- 1.5 Automatic setting according to ID ( insertion meter only )
- 1.6 Automatic setting according to ID ( insertion meter only )
- 1.7 Enables the empty pipe detection function
- 1.8 Value of empty pipe sensibility detection
- 1.9\* Enables the automatic zero calibration system
- 1.10 Reset the preceding value

```

MAIN MENU
1-Sensor
2-Scales
2-SCALES
Fs =dm³/s  5.0000
Temp.u.meas.= "F
Tot1MU=dm³ 1.000
Pls1=dm³   1.00000
Pls2=dm³   1.00000
1Tpls1=ms  0010.0
1Tpls2=ms  0010.0

```

- 2.1\* Full scale value measure set for flowrate
- 2.2 Unit of measure of temperature
- 2.3\* Unit of measure and number of decimal totalizes
- 2.4\* Pulse value on channel 1
- 2.5\* Pulse value on channel 2
- 2.6\* Duration of the pulse generated on channel 1
- 2.7\* Duration of the pulse generated on channel 2

```

MAIN MENU
1-Sensor
2-Scales
3-Measure
3-MEASURE
Cut-off=%   00.0
Prof.=      SMART

```

- 3.1 Low flow zero threshold: 0-25% of full scale value
- 3.2\* Consumption profiles

```

MAIN MENU
1-Sensor
2-Scales
3-Measure
4-Alarms
4-ALARMS
Al.max+=%   000
Al.min+=%   000
1Al.max-=%  000
1Al.min-=%  000
Hyst.=%     03

```

- 4.1 Maximum value alarm set for direct flow rate
- 4.2 Minimum value alarm set for direct flow rate
- 4.3 Maximum value alarm set for reverse flow rate
- 4.4 Minimum value alarm set for reverse flow rate
- 4.5 Hysteresis threshold set for the minimum and maximum flow rate alarms

```

MAIN MENU
1-Sensor
2-Scales
3-Measure
4-Alarms
5-Inputs
5-INPUTS
T+ reset=   OFF
P+ reset=   OFF
T- reset=   OFF
P- reset=   OFF
1Count lock= OFF
1Calibration= OFF
Inp.pwr=    EXT
Alarm=      OFF

```

- 5.1\* Total direct (positive) flow totalise reset enable
- 5.2\* Partial direct (positive) flow totalise reset enable
- 5.3\* Total reverse (negative) flow totalise reset enable
- 5.4\* Partial reverse (negative) flow totalise reset enable
- 5.5 Totalise counting lock command
- 5.6\* Autozero calibration external command
- 5.7 Input power supply
- 5.8 Alarm from external signal (i.e. flooding/intrusion/..)

```

MAIN MENU
1-Sensor
2-Scales
3-Measure
4-Alarms
5-Inputs
6-Outputs

```

```

6-OUTPUTS
1 Out1= OFF 6.1* Output 1
1 Out2= PLS 6.2* Output 2
Out mA=4_22 6.3 4÷20 Output

```

```

5-Inputs
6-Outputs
7-Communication
7-COMMUNICATION
IF2 prot.= DPP 7.1 Choice of the communication protocol for the IF2 device
10-Diagnostic
11-Internal data

```

```

6-Outputs
7-Communication
8-Display
8-DISPLAY
1 Language= EN 8.1 Choice of the language: EN= English, IT=Italian, FR= French, SP= Spanish
1 D.time=s 060 8.2 Time for switch off display (shown with function 3.7 enabled)
Quick start= OFF 8.3 Visualization of "Quick start menu"
Disp.lock= OFF 8.4 lock of DISPLAY in ONE SPECIFIC visualization page
T+ reset 8.5* Total direct (positive) flow totalizer reset from keyboard
P+ reset 8.6* Partial direct (positive) flow totalizer reset from keyboard
T- reset 8.7* Total reverse (negative) flow totalizer reset enable from keyboard
P- reset 8.8* Partial reverse (negative) flow totalizer reset enable from keyboard

```

```

7-Communication
8-Display
9-Data logger
1 9-DATA LOGGER
1 2013/04/04 08:45 9.1* Date and time set
Acquisition= ON 9.2* Automatic data logger enable
Double int.= ON 9.3* choice of single (off) or double (on) interface
int.1 =00h10m00s 9.4* Interval time 1 for the data logging function
int.2 =00h01m00s 9.5* Interval time 2 for the data logging function
int.2 = HOURLY 9.6 Interval period 2 for the data logging function
T.ON =00d00h00m 9.7 Interval 2 start loggin time
T.OFF =00d00h00m 9.8 Interval 2 stop loggin time
Log T+= OFF 9.9 Enables the sending of direct total totalizer
Log P+= OFF 9.10 Enables the sending of direct partial totalizer
Log T-= OFF 9.11 Enables the sending of reverse total totalizer
Log P-= OFF 9.12 Enables the sending of reverse partial totalizer
Log NT= OFF 9.13 Enables the sending of net total totalizer
Log NP= OFF 9.14 Enables the sending of net partial totalizer
Log Q= OFF 9.15 Enables the sending of flow rate
Log STAT= OFF 9.16*Loggin of statistical data
M.units= OFF 9.17 Enables the sending of measure units ( technical units )
% values= OFF 9.18 Enables the sending of measure units ( % )
Separator= , 9.19 Symbol used as separator on CSV files

```

```

8-Display
9-Data logger
10-Diagnostic
10-DIAGNOSTIC
Sensor test
Self test
Simulation= OFF
Stand-by
Read SDC info
Firmware rev.

```

10.1 Perform a sensor test (SENSOR MUST BE CONNECTED)  
 10.2\* Converter auto-test  
 10.3\* Flow rate simulation enabling  
 10.4\* Stand-by function  
 10.5\* SD card status/info  
 10.6\* Show firmware revision of converter

```

8-Display
9-Data logger
10-Diagnostic
11-Internal data
11-INTERNAL DATA
L2 code= *****
Load fact.data
KS= +1.0000

```

11.1 Level 2 access code enter  
 11.2 Load factory data pre-set  
 11.3 Ks Coefficient

Note : all references to page number are linked to the operating manual .

## MEASURE / SAMPLE FREQUENCY

ML 145 can be programmed to measure in four different modes:

### REAL FLOW PROFILE

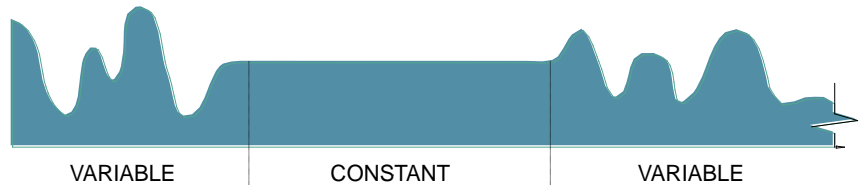

### CONTINUOUS SAMPLING

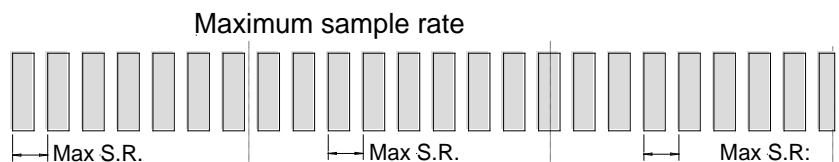

### AVERAGE SAMPLING

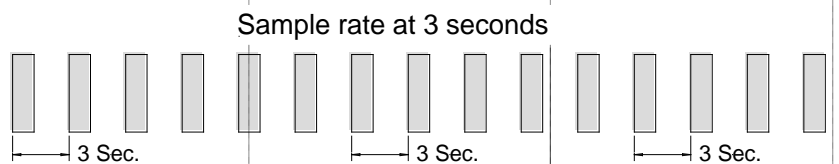

### MAX LIFE SAMPLING

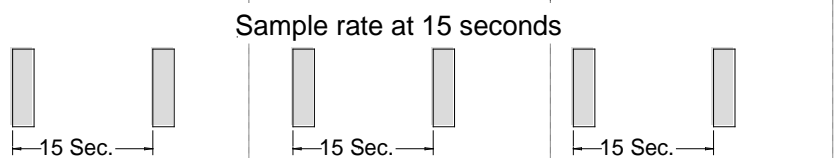

S.R.=SAMPLE RATE

### THE NEW SMART SAMPLING FUNCTION

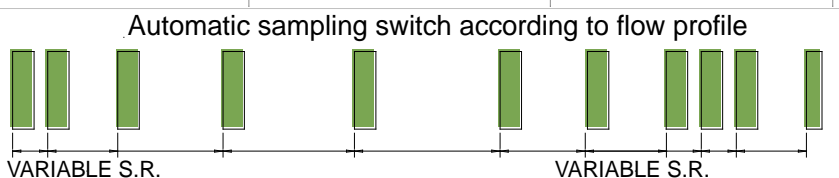

An internal algorithm allows the unit to automatically detect flow rate variations in the process. This capability determines the automatic setting of the sampling frequency. No variations means lower sampling frequency, with less power consumption; high variations means higher frequency to better follows the changes in the process.



## POWER TOOL SOFTWARE

Power tool is a software which allows to evaluate the instrument's battery life. The estimation is done with an easy guided procedure :

Connect the converter to the PC throughout the IF23 cable, then :

- launch the Power tool software
- select the relevant converter
- select "Get params from converter" or "Simulation" if the converter is not available
- waiting for the reading of converter's parameters (not in simulation mode)

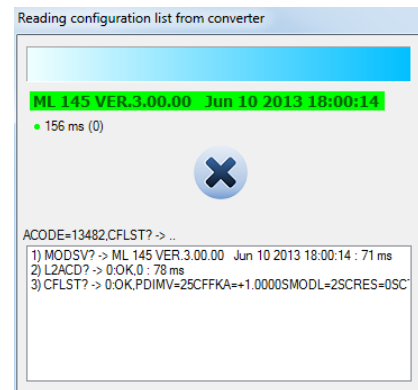
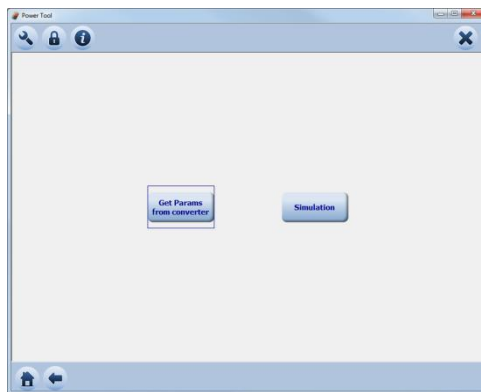

It is now possible to calculate the expected life battery; it is automatically updates after any parameters change. Once the procedure will be completed, the new configuration can be send to the converter by the relevant key.

Sensor data

GPRS data (not available on ML145)

Display activity

Battery configuration

Sampling mode and data logger interval

Data logger acquisition data

SMS data (not available on ML145)

Save a screen capture

Sends the changed settings to the converter



## USER INTERFACE

Besides the keyboard, the converter can be programmed by ISOCON INTERFACE: a real time interface designated to interface converter and PC.

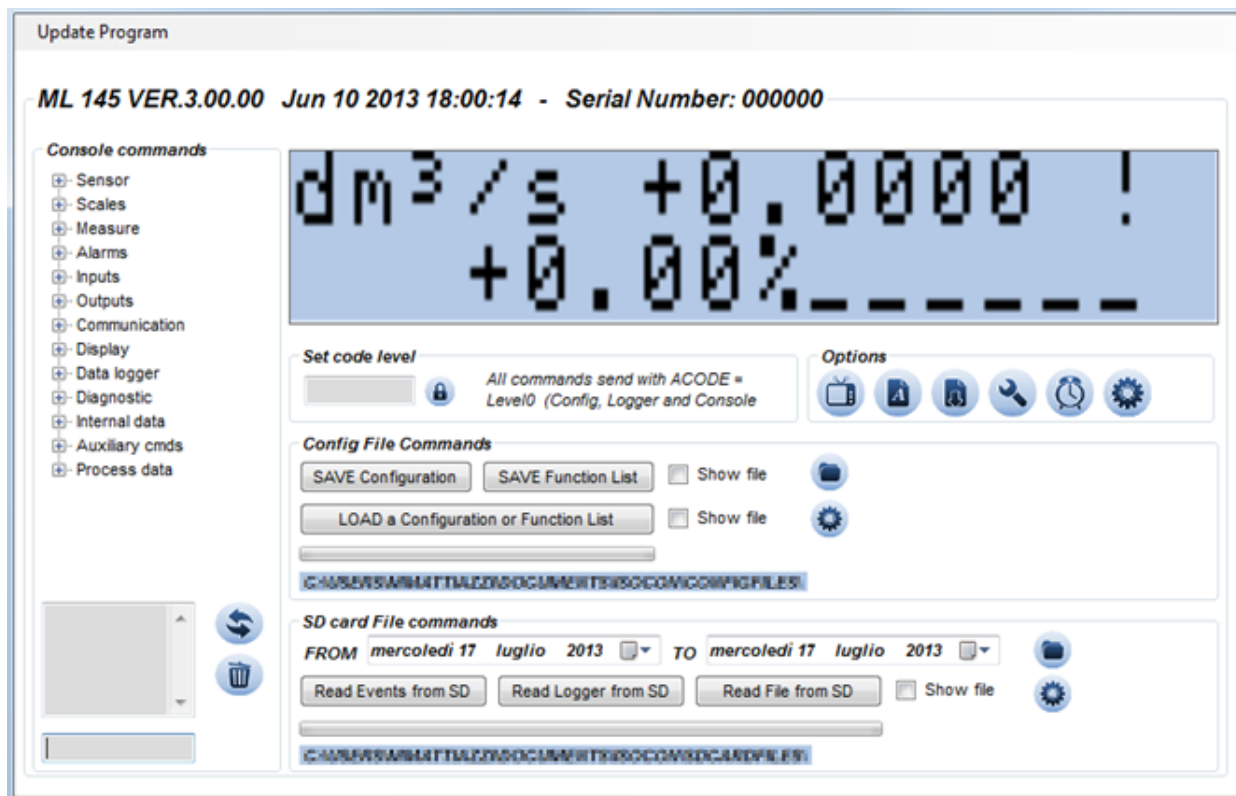



## ACCURACY TABLE

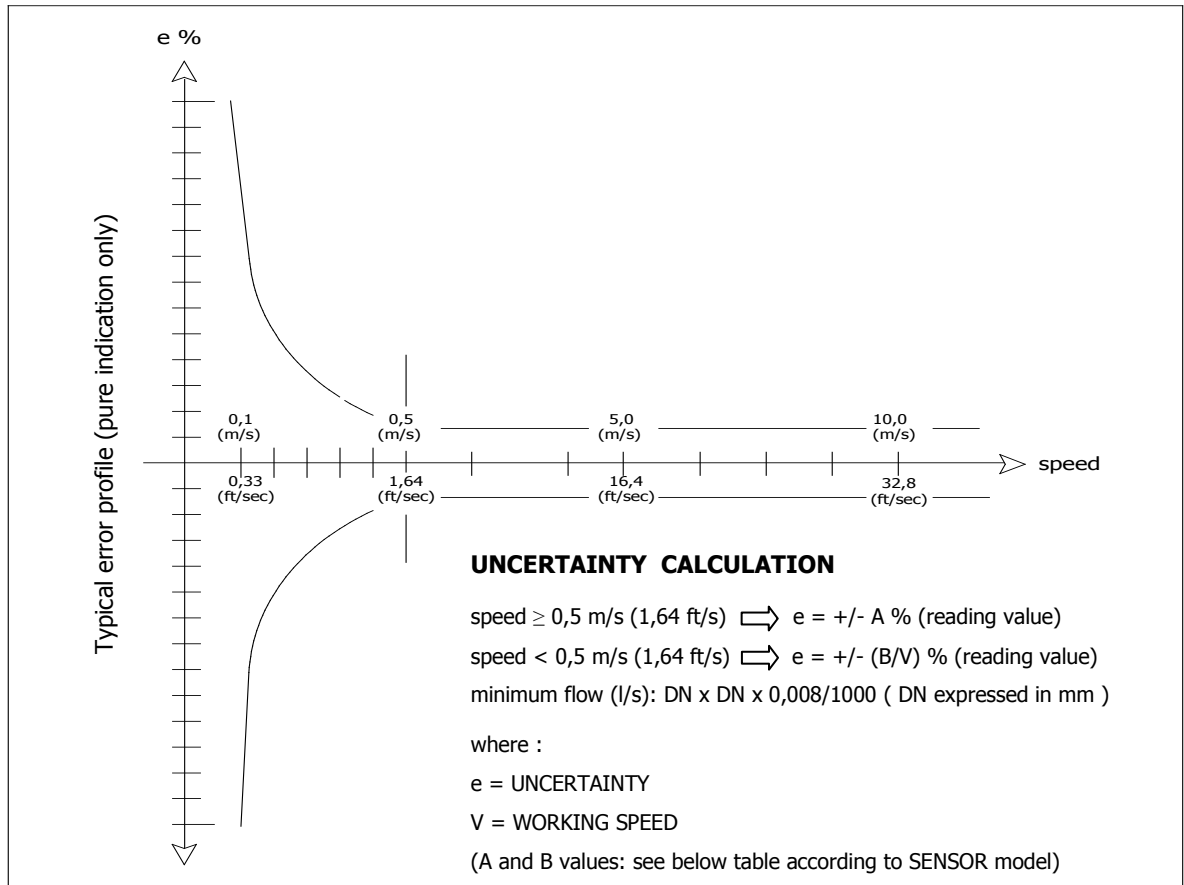

### FULL BORE SENSORS

| MS501/MS1000/MS2500 |        |         | MS5000 |        |         |
|---------------------|--------|---------|--------|--------|---------|
| A                   | B(m/s) | B(ft/s) | A      | B(m/s) | B(ft/s) |
| 0,5                 | 0,25*  | 0,82    | 2,0    | 1,0    | 3,28    |

### INSERTION SENSORS

**See MS 3770 / MS 3800 DATA SHEET**

Reference conditions below and as per internal testing procedures:

- Constant flow rate during the test
- Pressure: >30 Kpa
- Flow condition : fully developed flow profile
- Zero stability +/- 0,005 %

\* Special accuracy on request

## HOW TO ORDER

| CODE EXAMPLE   | DISPLAY  |
|--|--|
| <b>B</b>   | <b>A</b> Blind version (without display)   |
|  | <b>B</b> Alphanumerical display: 2 lines x 16 characters NO back light   |
| <b>HOUSING MATERIAL / PROTECTION RATE</b>                                  |  |
| <b>0</b>   | <b>0</b> Painted aluminium die casting , protection rate IP 67   |
|  | <b>1</b> AISI304 Stainless Steel housing, protection rate IP67 (NO ROTATABLE DISPLAY)  |
|  | <b>5</b> AISI304 Stainless Steel housing, protection rate IP68 1,5 meters under water (COMPACT VERSION ONLY, NO ROTATABLE DISPLAY)                                     |
|  | <b>6</b> Painted aluminium die casting IP 68 1,5 meters under water (COMPACT VERSION ONLY, NO ROTATABLE DISPLAY)   |
|  | <b>7</b> Painted aluminium die casting IP 68 1,5 meters under water (SEPARATE VERSION ONLY, NO ROTATABLE DISPLAY) COMPLETE WITH 2 CONNECTORS IP 68 FOR CABLE C015/C016 |
|  | <b>8</b> AISI 304 - IP 68 1,5 meters under water (SEPARATE VERSION ONLY, NO ROTATABLE DISPLAY) COMPLETE WITH 2 CONNECTORS IP 68 FOR CABLE C015/C016                    |
| <b>VERSION</b>   |  |
| <b>A</b>   | <b>A</b> Compact version with sensor MS  |
|  | <b>B</b> Separate version for wall mounting, complete with Aluminium mounting accessories, max length of C015/C016 = 20 m  |
|  | <b>D</b> Separate version for wall mounting, complete with AISI304 mounting accessories, max length of C015/C016 = 20 m  |
| <b>POWER SUPPLY</b>  |  |
| <b>1</b>   | <b>0</b> n° 1 LITHIUM BATTERY - WITHOUT MAIN POWER DC  |
|  | <b>1</b> n° 1 LITHIUM BATTERY - WITH MAIN POWER DC   |
|  | <b>2</b> n° 4 LITHIUM BATTERIES (1 + 1 PACK OF 3) - WITH MAIN POWER DC   |
|  | <b>4</b> n° 6 LITHIUM BATTERIES (2 X 3 PACKS ) - WITHOUT MAIN POWER DC   |
|  | <b>5</b> n° 3 LITHIUM BATTERIES (1 PACK OF 3) - WITHOUT MAIN POWER DC  |
|  | <b>6</b> n° 4 LITHIUM BATTERIES (1 + 1 PACK OF 3)- WITH MAIN POWER DC  |
|  | <b>7</b> WITHOUT BATTERIES WITH MAIN POWER DC  |
|  | <b>8</b> WITHOUT BATTERIES WITHOUT MAIN POWER DC (Batteries to be purchased locally)   |
|  | <b>9</b> n° 6 LITHIUM BATTERIES (2 X 3 PACKS ) - WITH MAIN POWER DC  |
|  | <b>a</b> n° 2 LITHIUM BATTERIES (1+1) - WITHOUT MAIN POWER DC  |
| <b>b</b> n° 5 LITHIUM BATTERIES (1+ 1 + 1 PACK OF 3) WITHOUT MAIN POWER DC |  |
| <b>OUTPUT</b>  |  |
| <b>A</b>   | <b>A</b> NONE  |
|  | <b>B</b> N° 2 on/off out (max 50 Hz - max 100 mA ) + N° 1 Digital Input  |
|  | <b>C</b> N° 1 out 4/20 mA ( Available ONLY with MAIN POWER DC option)  |
|  | <b>D</b> Option B + C  |
| <b>SPECIAL FEATURES</b>  |  |
| <b>1</b>   | <b>0</b> NONE  |
|  | <b>1</b> WITH ANTICONDENSE CAP   |
|  | <b>2</b> Connector for IP68 out connection (One piece , 10 contacts)   |
|  | <b>3</b> N° 1 IP 68 CONNECTOR FOR IF22 INTERFACE   |



ML145-B0A1A1 (Complete code example for order)

**The manufacturer reserves the right to make design improvements without notice.**