

PCSGRAPHIC ARTS GROUP

THE ORIGINAL MANUFACTURER · MADE IN EUROPE

CATALOGUE

» DRUPA 2016

CATALOGUE

Pressroom Consumable
Post press Consumable
Pressroom Chemical

KATALOG

Verbrauchsmaterialien für Druckerei
Verbrauchsmaterialien für Post Druckerei
Chemie für Druckerei

CATÁLOGO

Consumibles para Impresión
Consumibles para Post-impresión
Químicos para Impresión

CATALOGUE

Consomables pour l'impression
Consomables Post-impresion
Produits Chimiques pour impression



» NEW WEB

DURAFOIL

🇬🇧 CPC Consumables

🇪🇸 CPC Consumables



🇬🇧 The CP Tronic system requires consumable products in addition to the Ink Duct Foil. This extensive range of items requires periodical replacement as they form an essential part of the Ink Duct system.

APPLICATION & RANGE

- Tessamol Strip is a cellular foam placed along the bottom fold of the Ink Duct Foils to avoid seepage of excess ink into the ink metering system.
- Insulating Strip is a double-sided tape that is used to fasten the Ink Duct Foil on to the duct.
- Underliner Protective Foil and Sensor Protective Strips are an extra protective polyester tape placed between the Ink Duct Foil and the ink metering cams as an insurance against the contamination of the ink duct system by seepage of the ink.
- Ink Duct End Blocks are a pair of hard wearing Nylon seals that are fitted to each end of the ink duct.
- Scraper Cleaner is a component fixed to the Ink Duct End Block. As the ink roller rotates it the Scraper Cleaner forces excess ink to return to the duct and not to run over the end of the roller.

QUALITY

- Manufactured to original drawing specifications from high quality materials.

AVAILABILITY

- Large stock of products
Special sizes can be made to order.

www.pcsman.com

🇪🇸 El sistema CP Tronic de Heidelberg, requiere de otros productos complementarios además de los folios de tintero. Este extenso rango de productos también requiere sustitución periódica, siendo este cambio esencial para el buen funcionamiento del sistema del tintero.

APLICACIÓN Y GAMA

- Tessamol, es una tira de espuma celular situada a lo largo del pliegue inferior de los folios de tintero que evita la filtración del exceso de tinta en el sistema de regulación de ésta.
- Insulating Strip, son unas tiras de aislamiento en cinta de doble cara que se utiliza para fijar el folio de tintero en la bandeja de éste.
- Underliner Protective Foil y Sensor Protective Strips son unas cintas de poliéster de protección adicional, situadas entre el folio de tintero y los sistemas dosificadores de tinta para evitar la contaminación de los conductos del sistema de tinta por la filtración de ésta.
- Los Ink Duct End blocks, son el par de cuñas de nylon sólido que sellan los laterales o extremos del tintero.
- Scraper Cleaner son los rascadores que se fijan sobre los Ink Duct End Blocks. A la vez que el rodillo de tinta está rotando, el Scraper cleaner fuerza a los excesos de tinta a volver a la bandeja del tintero, evitando así que la tinta se desborde por los extremos del rodillo de tinta.

CALIDADES

- Fabricado según las especificaciones originales del fabricante de maquinaria y con materiales de alta calidad.

DISPONIBILIDAD

- Amplio stock para todos los productos y cantidades
Medidas especiales pueden ser fabricadas bajo pedido.



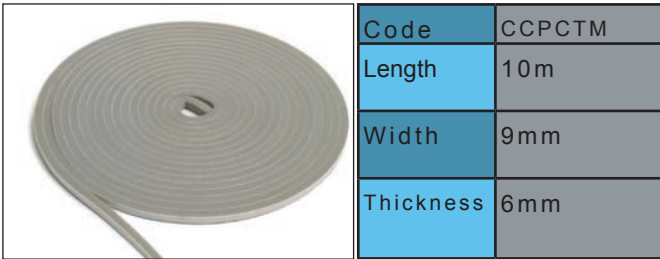

Code	CCPCTM
Length	10m
Width	9mm
Thickness	6mm

HEIDELBERG #00.580.1010
TESSAMOL STRIP

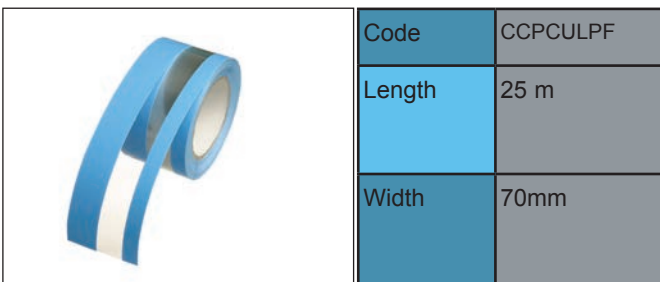

Code	CCPCULPF
Length	25 m
Width	70mm

HEIDELBERG #00.472.0006
UNDERLINER PROTECTIVE FOIL

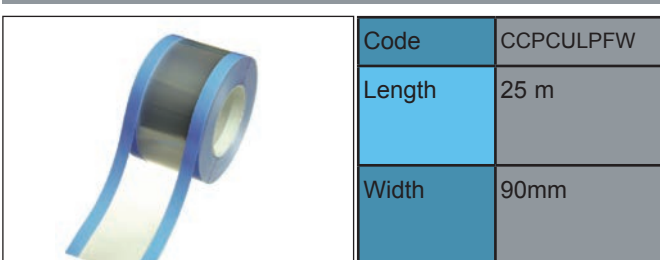

Code	CCPCULPFW
Length	25 m
Width	90mm

HEIDELBERG WEB OFFSET #00.472.0012
UNDERLINER PROTECTIVE FOIL #00.472.0023

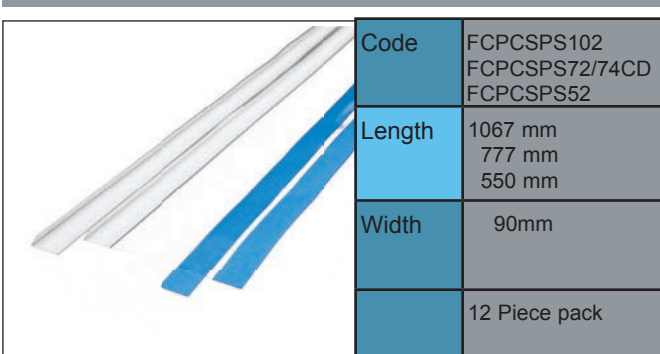

Code	FCPCSPS102 FCPCSPS72/74CD FCPCSPS52
Length	1067 mm 777 mm 550 mm
Width	90mm
	12 Piece pack

HEIDELBERG SM102 - FCPCSPS102 #82.008.119F
HEIDELBERG SM74 - FCPCSPS72/74CD
HEIDELBERG SM52 - FCPCSPS52
SENSOR PROTECTIVE STRIP



Code	FCPCULPF102 FCPCULPF72 FCPCULPFMO FCPCULPFGTO FCPCULPFQM
Length	1067mm 775mm 675mm 548mm 358mm
Width	70mm
	12 Piece pack

HEIDELBERG #00.472.0006
UNDERLINER PROTECTIVE FOIL

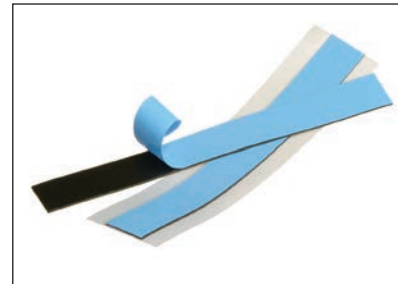

Code	CCPCIS
Length	150mm
Width	15mm

HEIDELBERG #91.008.044
DUCT INSULATING STRIP



Code	CCPCISR
Length	10 m
Width	15 mm

HEIDELBERG
DUCT INSULATING ROLL



Code: FCPCIDFSC
50 PIECE PACK

HEIDELBERG #91.008.033/A OFFSET
SCRAPER CLEANER



Code: FCPCIDFSCW
50 PIECE PACK

HEIDELBERG WEB OFFSET
WEB SCRAPER CLEANER #WM4ME008054

INK METERING DUCT

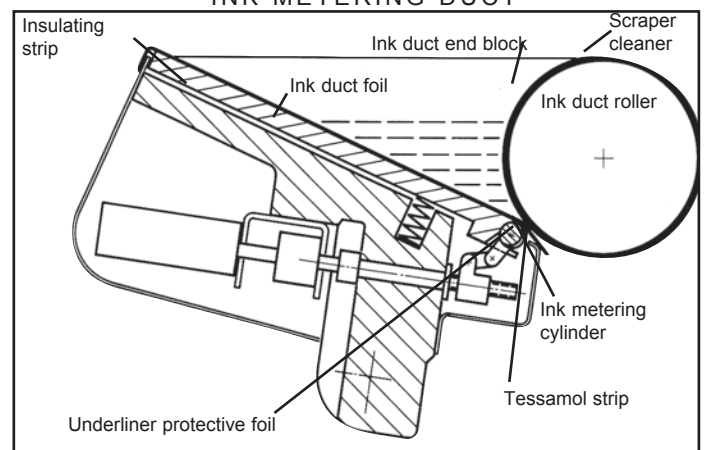



Code: COMPLETE

PAIR LEFT / RIGHT

HEIDELBERG
INK DUCT END BLOCK PLATE & SCREW



Code: CCPCIDEBS
Code: CCPCIDEBP

PAIR LEFT / RIGHT

CCPCIDEBS - INK DUCT END BLOCK SCREW - PAIR
FCPCIDEBP - INK DUCT END BLOCK PLATE - PAIR



Code: FCPCIDEB102

PAIR LEFT / RIGHT

SM102 / SM72 #91.008.013F/K03 #MV.025.468
INK DUCT END BLOCK

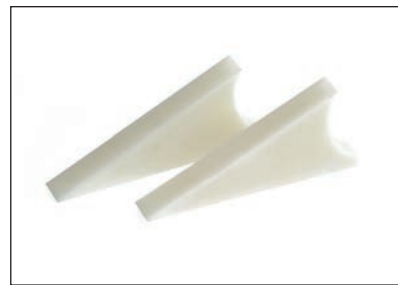

Code:
FCPCIDEBGTOCPC

PAIR LEFT / RIGHT

HEIDELBERG GTO CPC & CPT MODEL #MV.022.805
INK DUCT END BLOCK



Code: FCPCIDEB74

PAIR LEFT / RIGHT

HEIDELBERG SM74 LEFT #M2.008.113F/02 RIGHT
#M2.008.114F/02 INK DUCT END BLOCK



Code:
FCPCIDEBSM52

PAIR LEFT / RIGHT

HEIDELBERG SM52 DRIVE SIDE #G2.008.112 F/A
OPERATOR SIDE #G2.008.113 INK DUCT END BLOCK



Code: FCPCIDEBMO

PAIR LEFT / RIGHT

HEIDELBERG MO #63.008.113/A
INK DUCT END BLOCK



Code:
FCPCIDEB8PWL
FCPCIDEB8PWR

LEFT / RIGHT
SINGLE

HEIDELBERG 16&8 PAGE WEB #5E.008.214
OPERATOR SIDE INK DUCT END BLOCK



Code: FCPCIDEBGTO

PAIR LEFT / RIGHT

HEIDELBERG #69.008.012/02C #MV.037.346
INK DUCT END BLOCK



Code:
FCPCIDEB8PWSL
FCPCIDEB8PWSR

LEFT / RIGHT
SINGLE

HEIDELBERG 16&8 PAGE WEB #5E.008.216
DRIVE SIDE INK DUCT END BLOCK

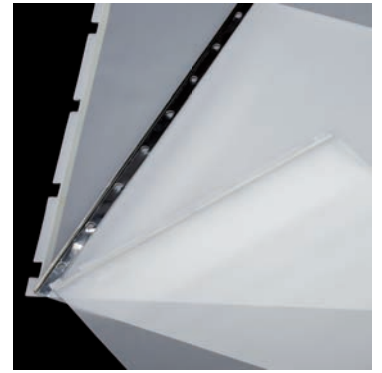

PCS GLOBAL DISTRIBUTION CENTRES

- SPAIN (EUROPE)
- HONG KONG
- USA



PCSGRAPHIC
ARTS GROUP

THE ORIGINAL MANUFACTURER · MADE IN EUROPE

T. +34 968 63 64 65
F. +34 968 63 64 66
Parque Industrial Alhama
Avda Suecia 4-9
30840 Alhama de Murcia
Murcia - SPAIN