

***VENT-O-MAT NCV-B & NCV-BK
Nozzle check valves***

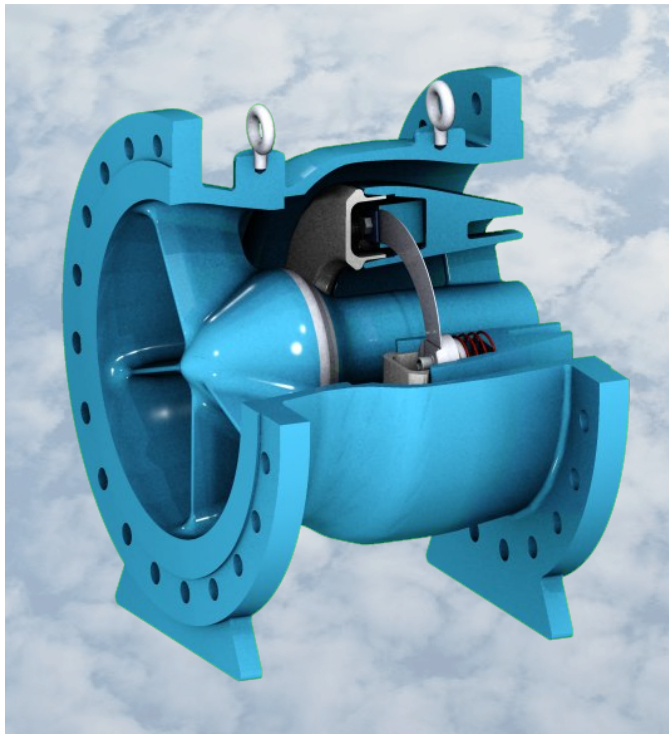

Vent-O-Mat[®] NCV-B

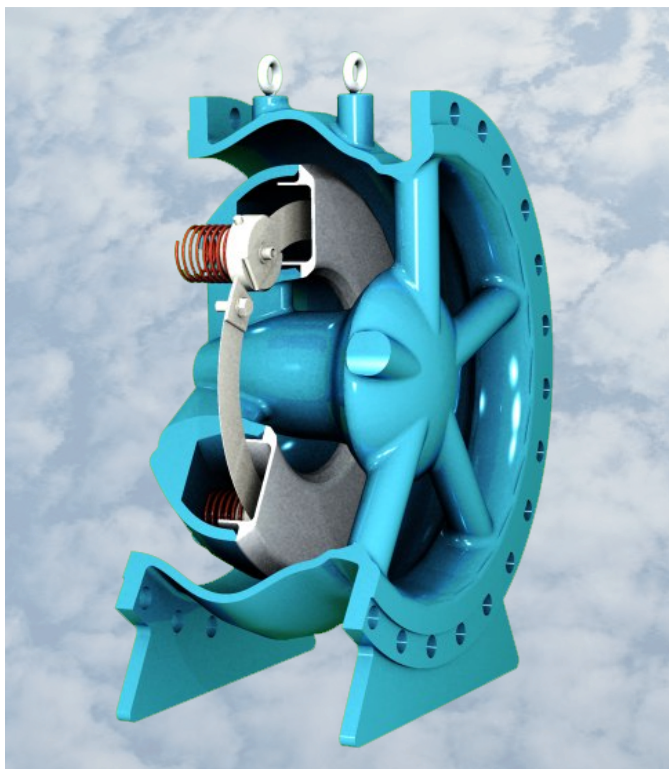

Vent-O-Mat[®] NCV-BK

Incorrect check valve selection can aggravate surge and water-hammer in pipeline systems resulting in what is known as “Check Valve Slam” causing transients which could exceed the pipeline’s working pressure by up to five times. Check valves can also be one of the biggest contributors to head loss within pipeline, which in turn increases power consumption. Vent-O-Mat’s range of nozzle check valves addresses both these concerns by providing a * non-slam valve with a very low pressure loss.

The valve utilises a ring-shaped disc as the closing member. Rapid * slam-free closure is achieved utilising friction free helical springs and radial guides. Annular ring type nozzle check valves outperform center shaft nozzle designs (mushroom type) in respect of dynamic and head loss performance because of the low mass of the moving parts (ring shaped disc) and the superior pressure recovery capabilities inherent in the two-port annulus configuration.

Design Features and Advantages

- Non-slam closure – The valve responds rapidly to changes in velocity and the disc will tend to move to the closed position while little to no reverse flow occurs.
- Low pressure loss - in the open position the annular disc forms two flow paths which increases the volume of flow through the valve
- Short closure time - the short stroke length reduces closure time
- Friction free opening and closing - helical springs and radial guides allow the disc to move from the open to closed position with limited resistance
- Tight shut-off – achieved by metal to metal sealing and tested in accordance with BS EN 12266.
- No scheduled maintenance
- * - note that slam in a pipeline is highly dependent on the design and characteristics of the pipeline as a whole and that it is not just dependant on having a non-slam check valve.

NCV-B

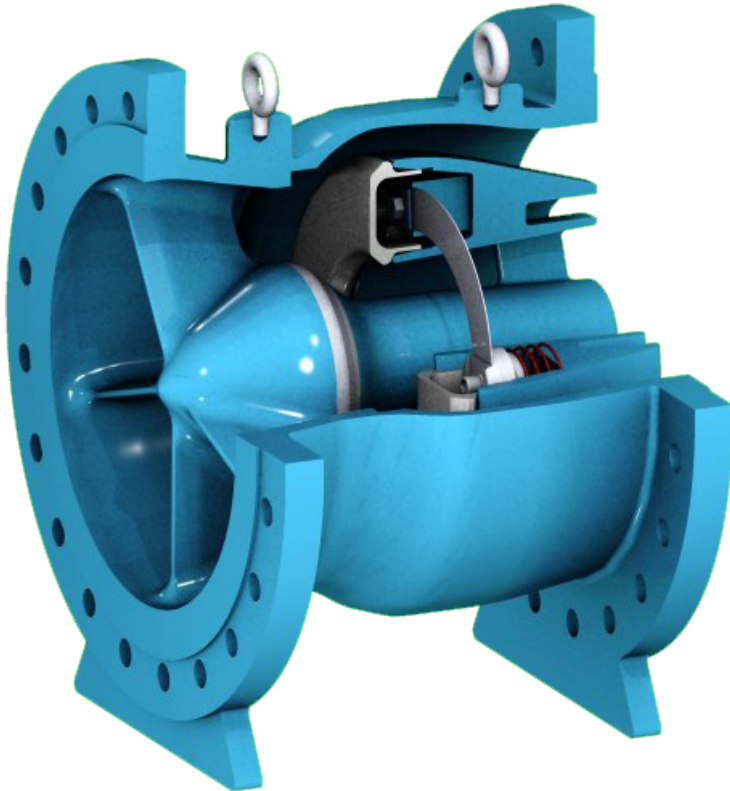

- Non-slam closure
- Rapid valve closure
- Very low pressure loss
- Tight shut off
- No resilient seats
- Maintenance free
- DN200 (8") - DN1200 (48")
- PN10 - Pn40 / ANSI 150 to ANSI 300

Face-to-Face Dimensions (mm/inches) and Weights (kg/lbs)

Valve Size		Face-to-Face		Weight PN10-PN16		Weight PN25		Weight PN40		Weight ANSI 300	
mm	inch	mm	inch	kg	lbs	kg	lbs	kg	lbs	kg	lbs
200	8	230	9.1	145	320	150	330	160	355	180	400
250	10	290	11.4	165	365	160	355	180	400	200	440
300	12	350	13.8	180	395	190	420	225	500	245	540
350	14	405	16.0	315	695	280	620	325	720	365	805
400	16	455	17.9	415	915	365	805	430	950	490	1080
450	18	520	20.5	480	1060	525	1160	575	1270	685	1510
500	20	570	22.4	540	1190	565	1245	630	1390	720	1590
600	24	685	27.0	900	1985	935	2065	1050	2315	1340	1955
700	28	800	31.5	1305	2875	1490	3285	1650	3640	1980	4365
800	32	910	35.8	1700	3750	1800	3970	2150	4740	2360	5205
900	36	1030	40.6	2430	5360	2885	6360	3300	7275	3570	7870
1000	40	1135	44.7	3240	7145	3500	7720	3950	8710	4080	9000
1200	48	1365	53.7	4320	9525	5220	11510	5800	12790	6000	13230



NCV-BK



- Economical short face-to-face
- Non-slam closure
- Rapid valve closure
- Low pressure loss
- Tight shut off
- No Resilient seats
- Maintenance free
- DN200 (8") to DN1200 (48")
- PN10 to PN16

Face-to-Face Dimensions (mm/inches) and Weights (kg/lbs)

Valve Size		Face-to-Face		Weights PN10-PN16	
mm	inch	mm	inch	kg	lbs
200	8	121	4.8	65	145
250	10	151	6.0	70	155
300	12	181	7.1	95	210
350	14	215	8.5	135	300
400	16	245	9.7	185	410
450	18	264	10.4	295	650
500	20	305	12.0	365	805
600	24	370	14.6	580	1280
700	28	430	16.9	745	1645
800	32	500	19.7	1000	2205
900	36	560	22.1	1550	3420
1000	40	680	25.6	2000	4410
1200	48	740	29.1	2800	6175

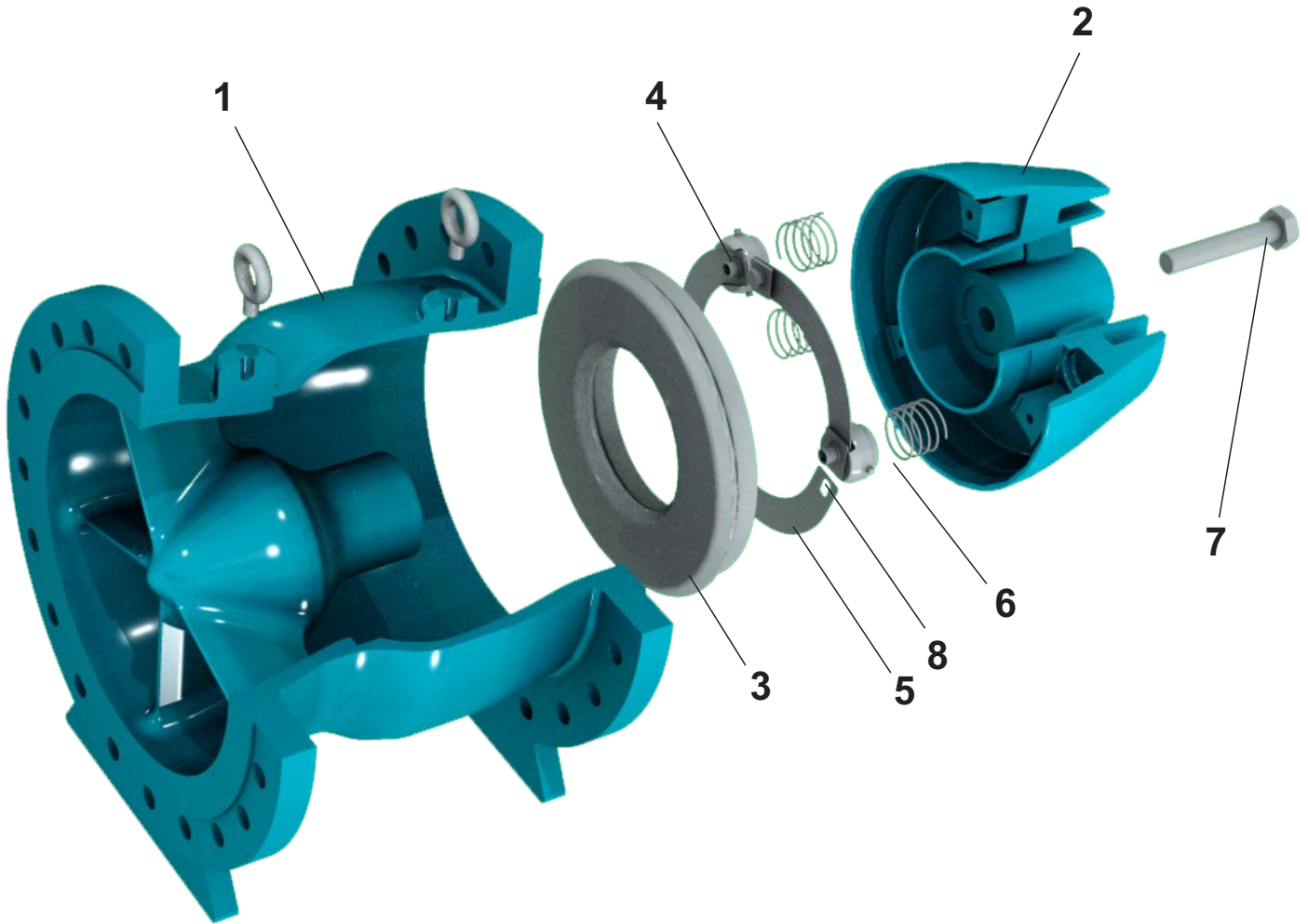

Item	Description	Material		
		Ductile Iron	Cast Steel	Stainless Steel
1	Valve Body	ASTM A536 65-45-12	ASTM A216 WCB	ASTM A351 CF8M
2	Flow Diffuser	ASTM A536 65-45-12	ASTM A216 WCB	ASTM A315 CF8M
3	Valve Disc	AISI 316	ASTM A350 CF8M	ASTM A351 CF8M
4	Spring Guide	AISI 316	AISI 316	AISI 316
5	Radial Guide	AISI 420 3/4 HARD	AISI 420 3/4 HARD	AISI 420 3/4 HARD
6	Helical Spring	ASTM A313-98	ASTM A313-98	ASTM A313-98
7	Tie Bolt	ASTM A193 B8M	ASTM A193 B8M	ASTM A193 B8M
8	Fasteners	ASTM A193 B8M	ASTM A193 B8M	ASTM A193 B8M

* All sizes are available with Stainless Steel 316 (SS316) weld deposit seats.



Specifications

The non-slam check valve will be double flanged and of a nozzle type design. The closing disc must have a ring-shaped design to minimise the mass of the moving parts. The disc must be guided utilising friction free stainless steel helical springs and radial guides to ensure rapid slam free closure.

The valve must fully open at low flow rates to minimise pressure drop during normal operating conditions and respond rapidly to changes in velocity that the disc is at the point of closure before reverse flow occurs.

The valve body and diffuser design must create a venturi shape to create a pressure differential across the disc to assist in opening the valve and ensuring a high pressure recovery resulting in a low pressure drop across the valve. The valve will have a single central bolt to secure the flow diffuser directly to the body.

The valve shall be designed, manufactured, assembled and tested in accordance with ISO 9001 and BS EN 12266 standards.

Applications

- Bulk water
- Pumping Stations
- Desalination plants
- Water distribution plants
- Chemical plants
- Coal fired power stations



DN350 NCV-BODY SEAT MACHINING



DN900 (36") PN25 NCV-B FLANGE MACHINING



DN400 (16") PN25 NCV-B

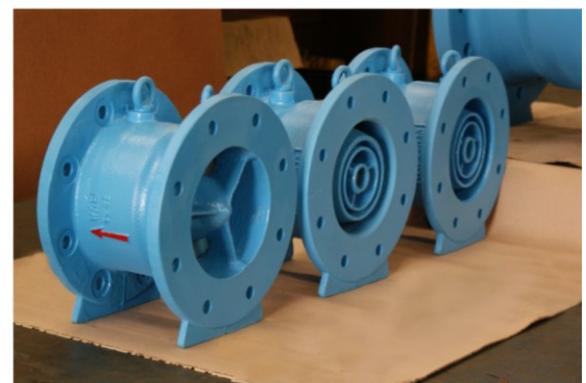

DN200 (8") NCV-B

VENTOMAT Nozzle Check Valve Engineering Data

Cv, Kv and Pressure Drop Calculation

$$Q = C_v \cdot \sqrt{\frac{\Delta P}{SG}}$$

$$Q = K_v \cdot \sqrt{\frac{\Delta P}{SG}}$$

Q: Water flow rate (US gpm)
 Cv: Valve flow co-efficient (US gpm)
 ΔP: Pressure drop (psi)
 SG: Specific Gravity of Water

Q: Water flow rate (m³/h)
 Kv: Valve flow co-efficient (m³/h)
 ΔP: Pressure drop (bar)
 SG: Specific Gravity of Water

Check Valve Cv and Kv Values

Valve Size (inch)	Valve Size (mm)	Cv Value NCV-B	Kv Value NCV-B	Cv Value NCV-BK	Kv Value NCV-BK
8	200	2320	2007	1164	1007
10	250	3285	2842	1820	1574
12	300	4361	3772	2621	2267
14	350	5922	5122	3567	3085
16	400	8028	6944	4659	4030
18	450	10175	8801	5897	5101
20	500	12633	10927	7280	6297
24	600	18210	15752	10484	9068
28	700	24812	21462	14270	12343
32	800	32524	28133	18638	16122
36	900	41280	35707	23589	20405
40	1000	51120	44218	29123	25191
48	1200	61452	53156	36275	36275

The Kv value expresses the amount of flow (m³/h) through a valve that would result in a pressure drop of 1 bar across a fully open valve (disc at 90°) at a temperature of 15°C

The Cv value expresses the amount of flow (usgpm) through a valve that would result in a pressure drop of 1 psi across a fully open valve (disc at 90°) at a temperature of 60°F

Note: Values as depicted above are purely theoretical (calculated through CFD analysis) and are in the process of being tested at the ESKOM Research and Innovation Centre Flow Laboratory.

The tests will be performed on the DN800 VENTOMAT nozzle check valve and values for other valves will be theoretically interpreted from these test results.

The Laboratory is an ISO 17025 accredited facility and all instrumentation that will be used for the tests will be certified according to the South African National Accreditation System (SANAS).



Technical Features and Engineering Design

Optimised Valve Geometry

The VENT-O-MAT Nozzle check valve was designed using CD-adapco's fully integrated CAE software package, STAR-CCM+ v12.0.

The main feature of the VENT-O-MAT Nozzle check valve is the extremely low head loss realized across the valve. When choosing a nozzle check valve it is a top consideration to keep in mind.

This low pressure loss leads to energy savings which makes it an attractive selection option when considering full lifecycle costs of running the plant.

The geometry of the valve was determined by using a simplified axisymmetric model that was parameterized to find the optimal geometry for the lowest head loss possible.

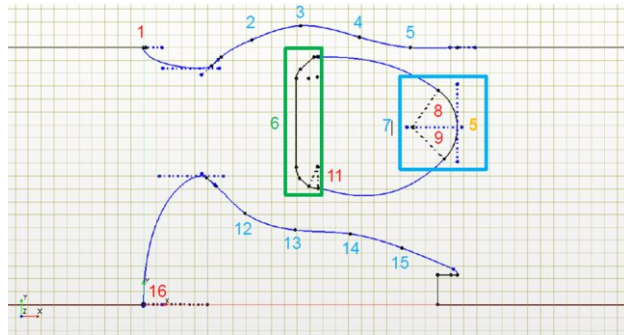

Parameterized 2D Axisymmetric Model

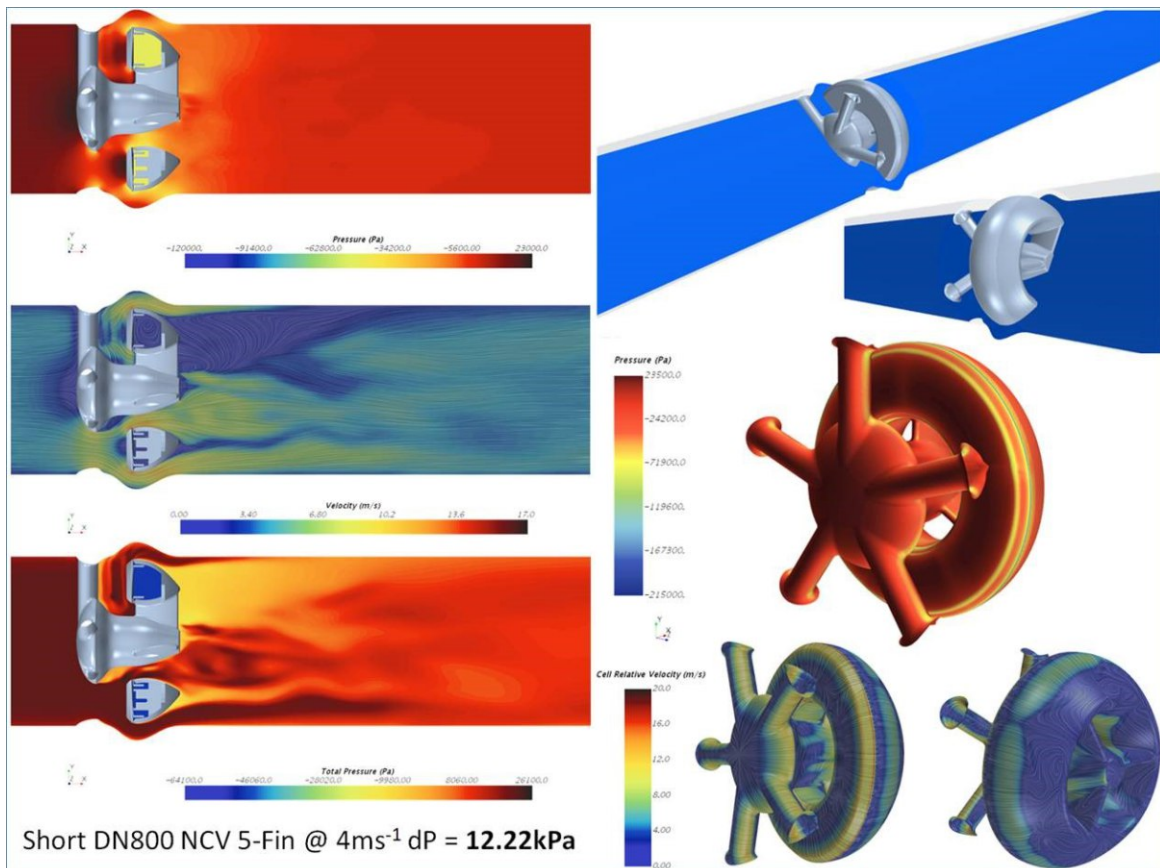

Images depicting the results of the CFD analysis and optimization

NCV-B Installation Dimensions

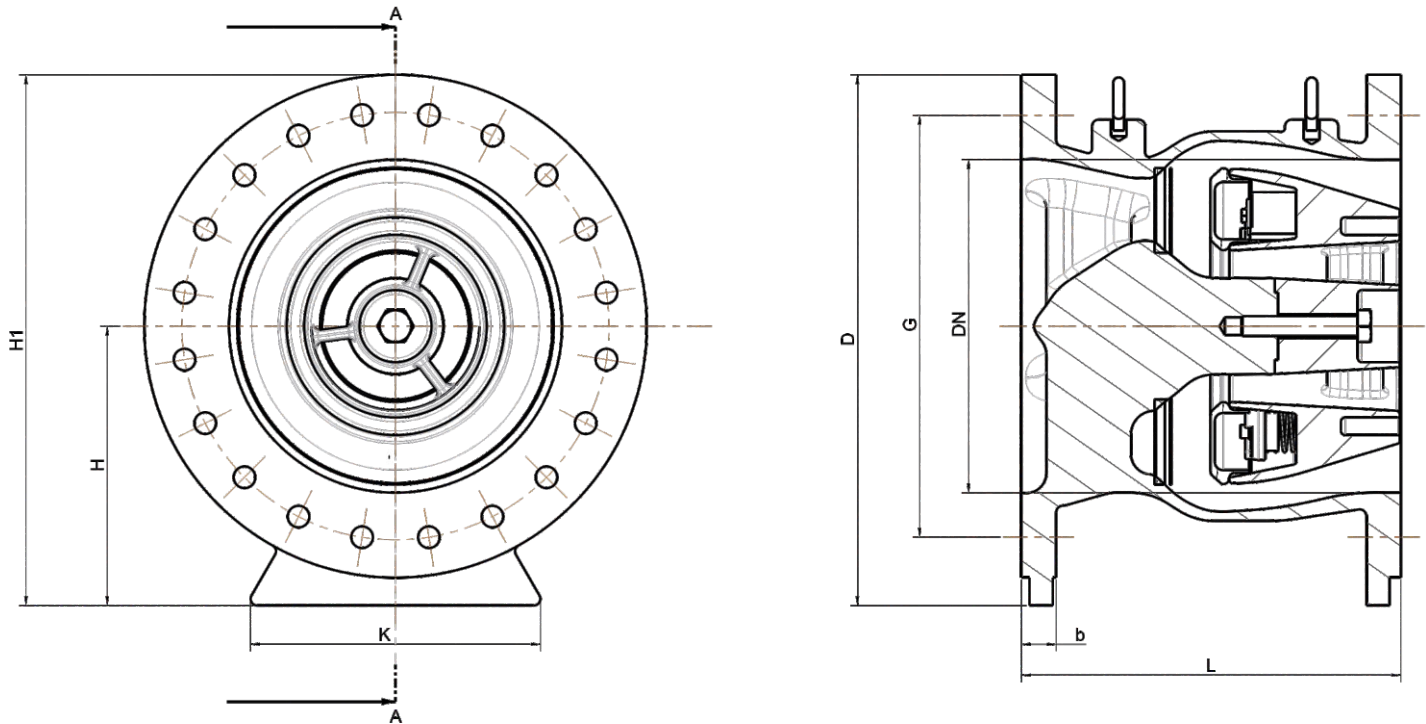

Size (mm)	PN10-PN16							PN25						
	L	b	G	D	K	H	H1	L	b	G	D	K	H	H1
DN200	230	20	295	340	201	193	363	230	22	310	360	201	193	361
DN250	290	22	355	405	250	230	433	290	24.5	370	425	250	230	422
DN300	350	24.5	410	460	314	260	490	350	27.5	430	485	314	260	487
DN350	405	26.5	470	520	358	313	573	405	30	490	555	358	313	556
DN400	455	28	525	580	412	340	630	455	32	550	620	412	340	615
DN450	520	30	585	640	463	391	711	520	34.5	565	670	463	391	665
DN500	570	31.5	650	717	419	435	776	570	36.5	660	730	419	435	741
DN600	685	36	770	840	519	503	923	685	42	770	845	519	503	881
DN700	800	39.5	840	910	596	587	1042	800	46.5	935	960	596	587	956
DN800	910	43	950	1025	692	650	1161	910	51	990	1085	692	650	1105
DN900	1030	46.5	1050	1125	783	730	1291	1030	55.5	1090	1185	783	730	1306
DN1000	1135	50	1170	1255	865	811	1437	1135	60	1210	1320	865	811	1344
DN1200	1365	57	1390	1485	965	820	1563	1365	69	1420	1530	965	820	1581

* Note: Installation dimensions on the PN40 NCV-B are available on request. Please consult the Aveng DFC technical department for further information.



NCV-BK Installation Dimensions

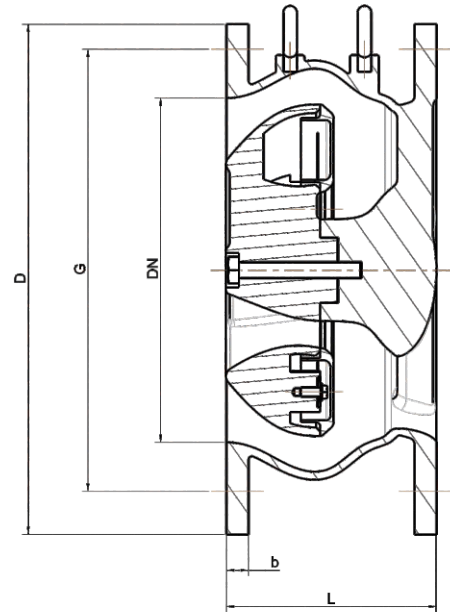
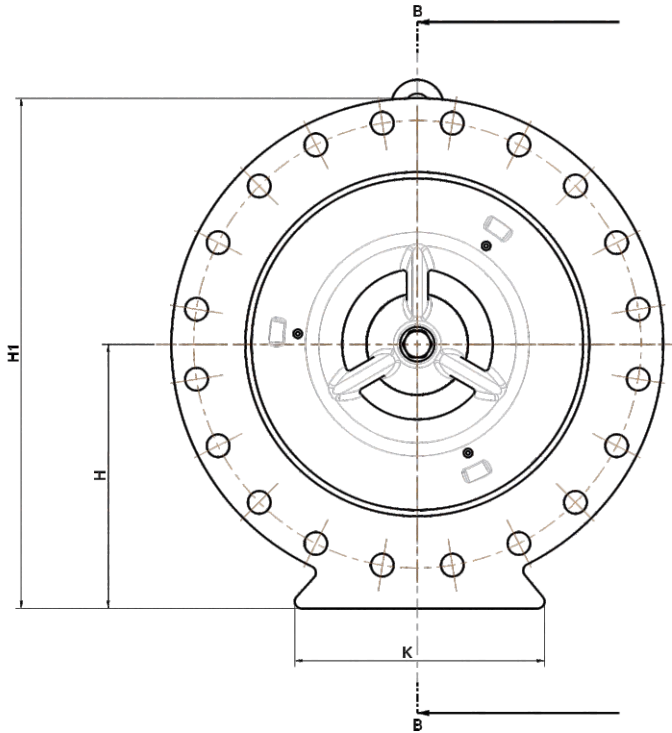

SECTION B-B

Size (mm)	PN16						
	L	b	G	D	K	H	H1
DN200	121	20	295	340	168	191	361
DN250	151	22	355	405	217	219	422
DN300	181	24	410	460	259	257	487
DN350	215	26.8	470	520	304	296	556
DN400	245	28	525	580	329	325	615
DN450	264	30	585	640	348	345	665
DN500	305	32	650	717	363	384	741
DN600	370	36	770	840	433	461	881
DN700	430	39.5	840	910	485	501	956
DN800	500	43	950	1025	696	593	1105
DN900	560	46.5	1020	1125	721	681	1306
DN1000	680	50	1170	1255	798	717	1344
DN1200	740	57	1309	1485	880	838	1581

Installation Recommendations

Horizontal Flow

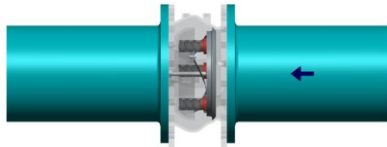

NCV-B and NCV-BK most suited for horizontal flow with disc directed towards the flow.

Vertical Flow

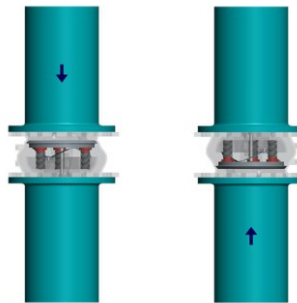

Valves suitable for vertical flow up and down.

For vertical flow please contact Aveng DFC with process conditions

4 Diameters Minimum

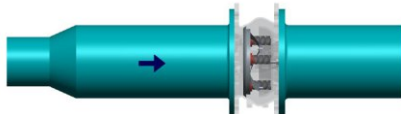

2 Diameters Minimum

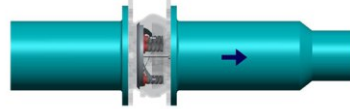

Check Valve should be installed a minimum of 4 diameters downstream of a reducer/expander or bend to ensure flow at valve is fully developed and turbulence is minimised.

Check Valve should be installed a minimum of 2 diameters upstream of a reducer or bend to avoid choked flow, which would cause the valve to only partially open

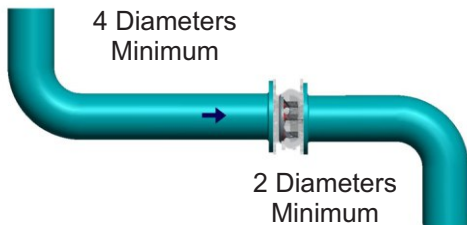

When installed near a throttling valve, the check valve should be installed a minimum of 3 diameters downstream, or 2 diameters upstream of the throttling valve.

Check valves can be installed close to an upstream or downstream non-throttling isolation valve (e.g. VOSA Full Port Wedge Gate Valves).

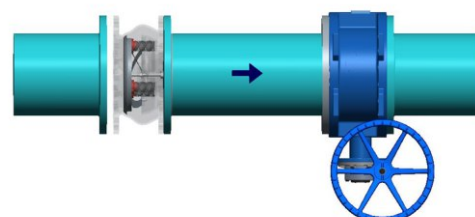
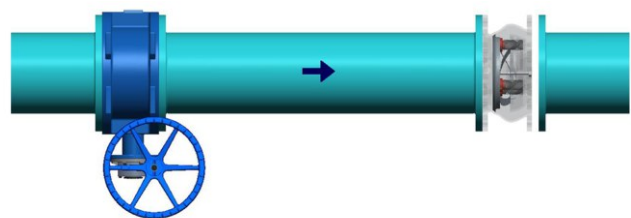

Note: Aveng DFC Check Valves are not piggable

➔ Indicates direction of flow

World Class Performance Water Valves

Vosa Resilient Seal Valve (RSV)

Robust resilient seal gate valves designed for water, slurry and sewage applications to SANS 664 specifications

- Available in sizes from 50mm to 300mm
- All RSV's rated to PN16

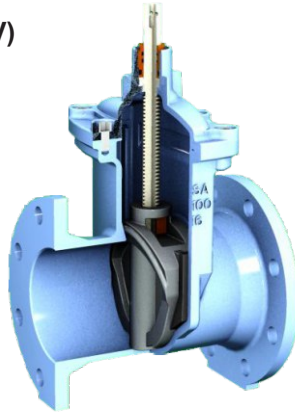

Vosa Butterfly Valve

High performance double eccentric butterfly valves to ensure less wear on seal and lower operating torque requirements.

- Available in sizes of 80mm to 300mm
- Pressure ratings vary from PN10 to PN40

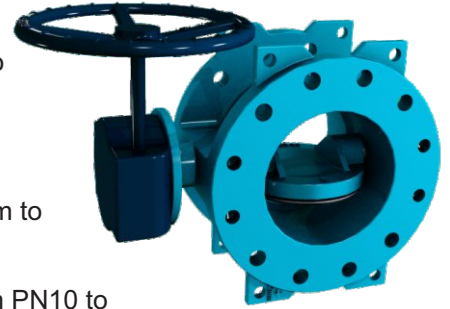

Vosa Wedge Gate Valve

Metal seated wedge gate valves for isolation and scouring purposes and used in water, mining, power, marine and general industries

- Available sizes from DN50 to DN1200
- Pressure range vary up to 64 bar depending on the size of the required valve



VENT-O-MAT Air Valves

Considered the world leaders in air transfer technology in water, slurry, tailings and sewage pipelines with the first ever integral "anti shock" technology for surge protection.

- RBX sizes 25mm to 200mm up to *100 Bar
- RBXc sizes 25mm to 300mm up to 25 Bar Same as RBX but with FBE coated ductile iron bodies
- RGX sizes 50mm to 300mm up to 25 Bar
- RGXII sizes 50mm to 200mm up to 16 Bar
- RPS sizes 15mm to 50mm up to 16 Bar



CLA-VAL Diaphragm Control Valve

Hydraulic operated, diaphragm actuated, single chambered globe pattern control valves. Most sold control valve in the world

- 2500 hydraulic functions available
- Sizes ranging from 25mm to 1200mm
- Pressure range available up to 40 bar

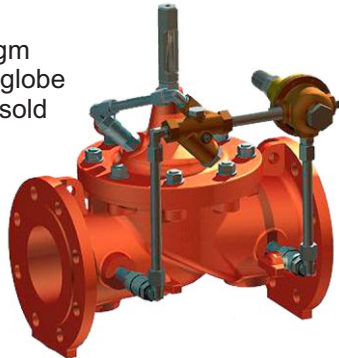

VENT-O-MAT Nozzle Check Valve

Characterized by "non-slam" closure, low pressure loss, metal to metal sealing and considered maintenance free.

- NCV-B (Long F/F) and NCV-BK (Short F/F) sizes DN200 - DN1200
- Pressure ratings from PN10 to PN40

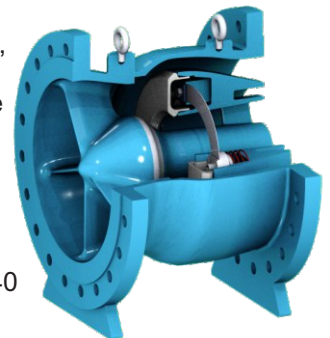

The Americas Operations

RF Valves Inc.
1342-A Charwood Road
Hanover, MD 21076, USA
Tel: +1-410-850-4404 Fax: +1-410-850-4464
email: contact@rfvalve.com
www.rfvalve.com

European Operations

RF Valves, Oy.
Tullitie 9,
53500 Lappeenranta, Finland
Tel: +358-20-758-1790 Fax: +358-20-785-1799
email: rfvalves@rftek.fi
www.rfvalve.com

African Operations

Dynamic Fluid Control (Pty) Ltd
32 Lincoln Road,
Industrial Sites, Benoni South, South Africa
Tel: +27-11-748-0200 Fax: +27-11-421-2749
email: dfc@dfc.co.za
www.dfc.co.za

Brazil Operations

Industria e Comercio de Valvulas do Brasil Ltda
Address: Rua Álvaro da Silveira, 40 - Santa Margarida
Belo Horizonte - Minas Gerais, Brasil
Tel : +55-31-3658-3656
Email address: rfq@rfvalve.com
www.rfvalve.com

Australian Operations - NSW

5 Vangeli St, Arndell Park, NSW, 2148
P.O. Box 156, Seven Hills, NSW, 1730
Tel: +61-2-8814-9699
Fax: +61-2-8814-9666
M: +61 (0) 499 922 686,
Email: sales@ventomat.com.au
Website: www.ventomat.com.au