

# CU 4500 Reservedele / spare parts

**BARON**®

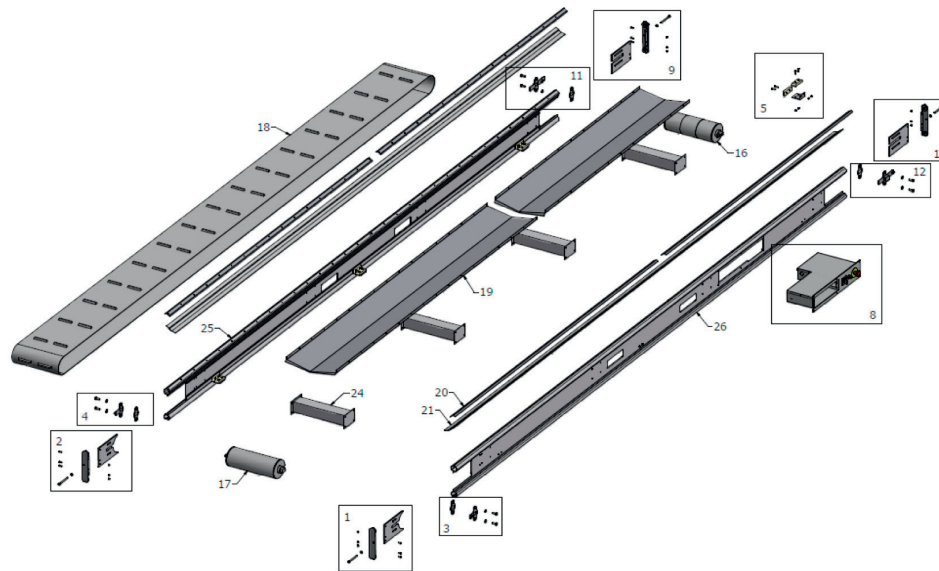

POS.	ARTIKEL / ARTICLE	BESKRIVELSE	DESCRIPTION
1	400.025.000	Indskudsplade m/bolt f/løstromle, højre	Insert plate w/bolt f/drum, right
2	400.030.000	Indskudsplade m/bolt f/løstromle, venstre	Insert plate w/bolt f/drum, left
3	400.035.000	Monteringsbeslag for løstromle, højre	Mounting bracket w/bolt f/drum, right
4	400.040.000	Monteringsbeslag for løstromle, venstre	Mounting bracket w/bolt f/drum, left
9	400.010.000	Indskudsplade m/bolt f/motor, venstre	Insert plate w/bolt f/motor, left
10	400.005.000	Indskudsplade m/bolt f/motor, højre	Insert plate w/bolt f/motor, right
11	400.020.000	Monteringsbeslag for motor, venstre	Mounting bracket w/bolt f/drum, left
12	400.015.000	Monteringsbeslag for motor, højre	Mounting bracket w/bolt f/drum, right
16	B.100.042.090	Tromlemotor 0,55 kW 3x240V 0.6 m/s	Motor 0,55kW 3x240V 0.6 m/s
17	B.100.048.000	Løstromle	Drum
19	453.130.000	Underløbsplade 2,5 m	Bottom plate stainless steel 2.5m
20	453.170.000	Topskinne 2,5 meter	Top profile stainless steel 2.5 m
21	453.179.450	Sideskørt PVC, 1m	PVC side protection 1 m
5	453.190.100	Båndstyr inkl. 4 nylon klodser	Belt guide complete
24	453.080.000	Tværvange	Connection piece
25	453.015.000	Sideprofil venstre 4500	Left side profile 4500
26	453.010.000	Sideprofil højre 4500	Right side profile 4500

POS.	ARTIKEL / ARTICLE	ØVRIGE RESERVEDELE	OTHER SPARE PARTS
18	453.180.500	Bælte 4500 glat	PVC belt 4500 no cleats
18	453.180.375	Bælte 4500 HD+	PVC belt 4500 HD+
18	453.180.420	Bælte 4500 HD+ 20 mm medbringer	PVC belt 4500 HD+ 20 mm cleats
18	453.180.440	Bælte 4500 HD+ 40 mm medbringer	PVC belt 4500 HD+ 40 mm cleats
18	453.180.460	Bælte 4500 HD+ 60 mm medbringer	PVC belt 4500 HD+ 60 mm cleats
18	453.180.445	Bælte 4500 HD+ 20 mm medbringer V form	PVC belt 4500 HD+ 20 mm V-chevron cleats
18	453.180.470	Bælte 4500 HD+ 40 mm medbringer bølge	PVC belt 4500 HD+ 40 mm wavy edge cleats
	B.000.010.010	Luftgummihjul (1 stk) til understel	Rubberwheel (1 pc) for undercarriage
	453.550.000	Lukkebeslag til understel og fødekasse	Catch for undercarriage and for hopper
8	B.100.030.040	CU-Unit 230V	CU-Unit 230V
8	B.100.030.041	CU-Unit 110V	CU-Unit 110V
8	B.100.030.042	CU-Unit 230V N	CU-Unit 230V N
8	B.100.030.040 R	CU-Unit 230V renoveret *	CU-Unit 230V renovated *
8	B.100.030.041 R	CU-Unit 110V renoveret *	CU-Unit 110V renovated *
8	B.100.030.042 R	CU-Unit 230V N renoveret *	CU-Unit 230V renovated *
	B.900.500.205	CU/CCU Nødstop Komplet	Emergency stop complete
	B.900.500.206	CU/CCU Omskifter Komplet	Changeover switch
	B.900.500.207	CU/CCU Potentiometer Komplet	Potentiometer complete
	B.900.500.208	CU/CCU Hartingstik IN Komplet	IN adaptor
	B.900.500.209	CU/CCU Hartingstik OUT Komplet	OUT adaptor
	B.900.500.210	CU/CCU Motorstik HAN/HUN Komplet	Motor adaptors male/female complete
	B.900.500.211	CU/CCU Kabel	CU/CCU cable
	B.100.045.000	Friktionstape t/tromlemotor	Friktionband for engine

\* Når lager haves.  
Subject to availability.