

Operating instructions

Vigilon Compact Control panel / Network node Fire detection and alarm system



Contents

Preface - - - - -	3	How to edit a device label - - - - -	27
Associated documents - - - - -	3	How to edit Input/output line label - - - -	28
Conventions - - - - -	3	How to edit a zone label- - - - -	28
Symbol Keys - - - - -	3	How to edit a local panel label- - - - -	29
Abbreviations - - - - -	3	How to edit custom label - - - - -	29
User responsibility - - - - -	4	Maintenance - - - - -	30
Daily - - - - -	4	Replacing the glass on a new	
Weekly - - - - -	4	Manual Call Point - - - - -	30
Quarterly - - - - -	4	Resetting the resettable element on a new	
Limitation of false alarm- - - - -	4	Manual Call Point - - - - -	30
Control and indicating equipment - - - -	5	Replacing the glass on an older	
Control panel - - - - -	5	Manual Call Point - - - - -	31
Compact Network Node- - - - -	5	Battery replacement- - - - -	32
Repeat panels - - - - -	5	Repair function - - - - -	32
Zonal Mimic panels - - - - -	5		
Description of controls and indications - -	6		
Normal condition - - - - -	9		
How to operate a 'U' button - - - - -	9		
Weekly tests - - - - -	10		
How to manually raise an alarm of FIRE -	11		
Automatic detection of FIRE- - - - -	12		
Fault conditions - - - - -	14		
Typical fault messages - - - - -	15		
Disablement conditions - - - - -	16		
Typical Disablement Messages - - - - -	17		
Menu controls- - - - -	18		
To carry out a display test - - - - -	19		
How to change your PIN code - - - - -	19		
How to view the historic events - - - - -	20		
Cards inside the control panel - - - - -	20		
How to save changes to memory - - - - -	21		
How to view active events- - - - -	21		
How to set the system clock- - - - -	22		
How to use the external printer - - - - -	22		
How to enable/disable a zone - - - - -	23		
How to enable/disable Sensing - - - - -	23		
How to enable/disable an IO line - - - - -	24		
How to enable/disable aux relay- - - - -	24		
Other enable/disable options - - - - -	24		
Viewing labels - - - - -	25		
How to view a device label - - - - -	25		
How to view a I/O line label - - - - -	25		
How to view a zone label - - - - -	26		
How to view the local panel label - - - - -	26		
To view or print a map- - - - -	27		
Editing labels - - - - -	27		

Preface

This is the third issue of the operating instructions for the Vigilon Compact fire detection and alarm system. This issue incorporates the operation of Vigilon Compact Network Node.

Associated documents

Vigilon Compact panel based system
- Installation instructions
Log Book

Conventions



This is a note to highlight important text that is normally hidden in the main text.



This is either a caution to prevent damage to the equipment or a warning to inform of dangerous conditions that may result in injury or death.

Symbol Keys



What you will see.



What you will hear.



A fire condition.



LED illuminated - On.



LED illuminated - Flashing.

Abbreviations

DEV - Loop device

LED - Light emitting diode (light)

MCP - Manual call point

NVM - Non Volatile Memory

OC or O/C - Open circuit

IO or I/O Input or Output

OS - Outstation (alternative name for a Loop device)

PSU - Power supply unit

SC or S/C - Short circuit

[Text] - Denotes menu options on display

Text - Denotes physical keys on keypad

User responsibility

Your fire alarm system should have been designed, installed and commissioned to your site specific requirements and in accordance with the requirements of BS5839 Part 1. You should have received instructions about your system during the handover stage and must make arrangements to ensure the system is regularly tested and maintained.

It is recommended that the **person responsible** for the fire alarm system should ensure the system is tested and maintained in accordance with the requirements of BS5839:Part 1 and become familiar with:

- the operation of controls and be able to interpret the indications given at the control panel
- keep up to date all documentation associated with the system.



Any servicing work on the Vigilon system must be carried out by a suitably trained person, please refer to your servicing organisation.

Daily

BS 5839:Part 1, states that the system should be inspected daily to ensure:

- That a normal indication is given at the control and indicating equipment.
- That any previously indicated **fault** conditions have received appropriate attention.
- All system events are entered into the Log Book for future reference.
- That the use of the 'area(s) that are inspected' has not changed since the system was designed.
- That no unsafe practices that could lead to fire are being undertaken.

Weekly

When testing the system there may be a need to isolate ancillary outputs and it is important to contact the alarm receiving centre before and after the weekly test.

- A different **manual call point** of the system should be tested to ensure the system is capable of operating under alarm conditions.
- The operation of the **alarm sounders** should be checked, which also reminds the occupants that there is a fire alarm system which gives a particular sound output.



The test should be performed at a regular time to avoid confusion between a test and a genuine fire alarm. The alarm receiving centre must be contacted before and after the test to check alarms are received and also to avoid unwanted alarms.

Quarterly

At quarterly intervals the system should be inspected and any work necessary should be performed by a trained maintenance engineer.



For help with service and maintenance please refer to your servicing organisation, see contact details entered in the log book.

Limitation of false alarm

It is recommended that the person responsible for the fire alarm system should arrange for suitable investigation and appropriate action on occasion of every false alarm. For a system having less than 40 automatic fire detectors installed, an in-depth investigation should be instigated on occurrence of two false alarms in any rolling 12 months. For a system having more than 40 automatic fire detectors an investigation should be instigated if there has been:

- one false alarm for every 20 installed detectors in the system in any rolling 12 months, or
- two or more false alarm occurrences from a single device.

Control and indicating equipment

On occurrence of a fire, fault or disablement event in the protect premises, the event is quickly indicated at a control and indicating equipment. The control and indicating equipments are installed in accessible location and can be operated by the person responsible for the fire system.

Control panel

The control panel is the heart of the system. It is normally located near to the main entry or exit point of the protected premises.

The control panel continuously monitors devices that are connected to each device loop. The device loop cable is routed through the protected premises to cover all areas with both ends of the loop terminating at the control panel. On the loop cable are installed devices such as fire sensors, that constantly monitor the environment for fire. Alarm devices on the loop provide alert and evacuation alarm to warn occupants in the protected premises in the event of a fire.



Zone indicators

Compact Network Node

A Compact network node provides central indications events in a Vigilon network system.

NA Some operations identified by the NA symbol covered in this manual are not applicable for the Compact Network Node.

Repeat panels

There may be one or more repeat panels installed in the protected premises to provide secondary indications of the system condition. The larger repeat panel additionally provide system controls. The repeat panels are usually located near to secondary entry and exit points of the protected premises.



Repeat panel
(provides system indications and controls)



Repeat indicator panel
(provides system indications)

Zonal Mimic panels

There may also be a number of mimic and zonal mimic panels installed in the protected premises, to provide visual indications in a graphical zonal format. Normally one is installed next to the main control panel. There may be additional panels installed in other areas of the protected premises. A mimic panel or zonal panel may be used to cover sub division of the premises.



A3 Zonal panel











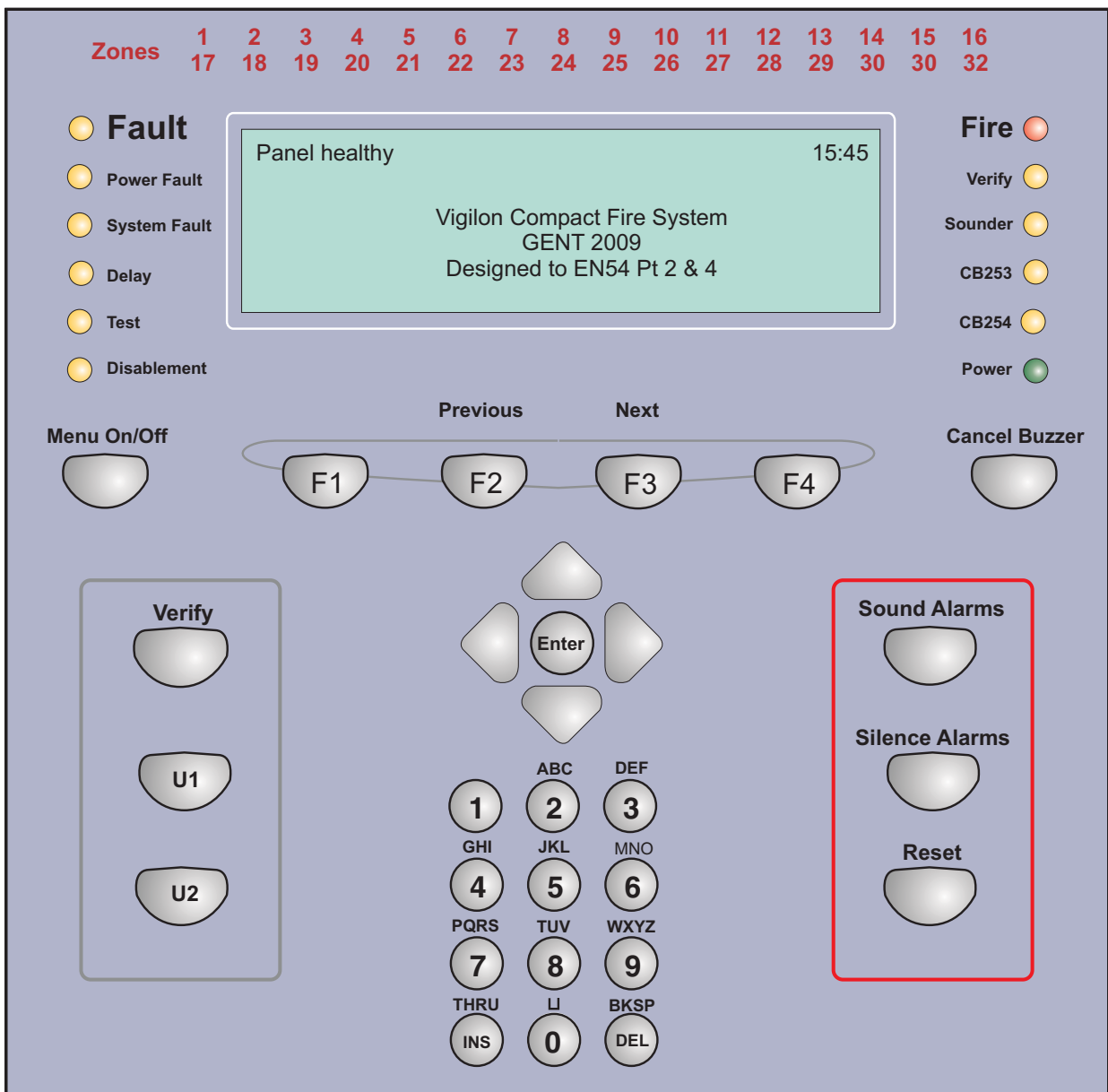





A3 Mimic panel

Operating instructions









Description of controls and indications

Open the front door to reveal the controls

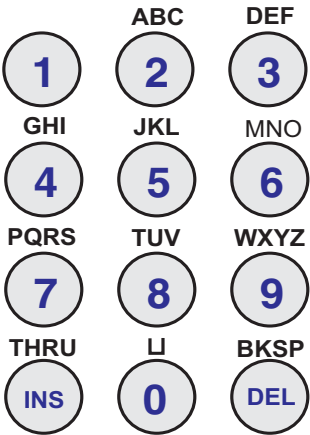

Indicators	Description
Display	The Display provides messages of the system status / events by means of 8 lines by 40 characters per line display.
Zones  (red)	Secret-until-lit fire zone indicators. When "Zones" text and number(s) are illuminated it indicates that a FIRE has been detected in the specified zone(s). NA <i>The Zone indicators are not applicable for a Compact Network node.</i>
Power  (green)	When illuminated it indicates that a supply to the panel is present.
Fire  (red)	When illuminated it indicates that a FIRE has been detected in the protected premises.
Verify  (amber)	When illuminated it indicates that the Verify button has been pressed and the alarm sounders in the system are delayed from sounding.
Fault  (amber)	When illuminated it indicates that a FAULT has been detected in the fire detection and alarm system.
System Fault  (amber)	When illuminated it indicates that a fault has occurred with the system processor. It is important to investigate this fault because the fire system may not be able to detect fires.
Disablement  (amber)	When illuminated it indicates that a part of the system has been disabled.
CB253 or CB254  (amber)	When illuminated it indicates command builds 253 or 254 has been activated.
Power Fault  (amber)	When illuminated it indicates the battery or mains supply to the panel has failed.
Sounder  (amber)	When illuminated (always with either the FAULT light or the DISABLEMENT light) it indicates that there is a sounder fault (flashing indication) or sounder disablement (steady indication).
Delay  (amber)	When illuminated it indicates that one or more delay blocks are setup on the panel.
Test  (amber)	When illuminated it indicates one or more zones are in Test mode.
Controls	Description
Menu On/Off 	Pressing Menu On/Off will enable/disable the on screen menu facility which gives access to the system menus.
F1 to F4 	The 'Fn' buttons are used to select functions and sub-functions of the system menus which appear on the display. Each option in the menus corresponds to one of the function buttons and pressing a button will select the option which appears above it on the display.

Operating instructions

<p>Cancel Buzzer</p> 	<p>The Cancel Buzzer button when pressed will stop the internal panel buzzer from sounding.</p>
<p>Sound Alarms</p> 	<p>Pressing the Sound Alarms button will sound all the system alarms. This button is only pressed in an emergency or at other agreed times, for example when conducting a sounder test or practice evacuation.</p>
<p>Silence Alarms</p> 	<p>Pressing the Silence Alarms button will silence the system alarms.</p>
<p>Reset</p> 	<p>Pressing the Reset button will clear any fires and return the panel to its normal state. If a fire condition occurs immediately after reset then the indicated device should be investigated.</p>
<p>Verify</p> 	<p>If the Verify facility has been set up, then pressing the Verify button in the event of a fire condition, increases the time delay before the sounders are activated. This gives the user time to investigate the cause of the alarm and the option of cancelling the alarm within the delay time period.</p>
	<p>These buttons can be configured during commissioning to action user-defined tasks, such as disablement of devices in areas where smoke may be generated or where plant shutdown is required.</p>
	<p>These four buttons are used to scroll the displayed text.</p>
	<p>These buttons allow data to be entered manually at the panel/node.</p> <p>When entering a label each press of a key will scroll the character string, for example:</p> <p>key 2 will scroll A B C 2 a b c.</p> <p>key 1 will scroll 1 ? , . ; & * /</p> <p>The bottom row of text keys explained:</p> <p>The  button is used to enter a SPACE between characters</p> <p>The INS key allows text to be moved one position to the right</p> <p>The DEL key allows a character to be deleted</p> <p>The BKSP button will delete previous character.</p> <p>When entering a data range, such as a range of devices</p> <p>The key THRU (-) is used to enter a range, for example 1 - 5.</p>
	<p>This button is pressed to acknowledge an entry of data such as a label.</p>

Normal condition

When a system is operating normally and the panel with no faults or disablements:

- the display shows a:
'Panel healthy' message at the control panel and
'Network Healthy' message at a Network node and
- only the 'Power' green indicator is lit.

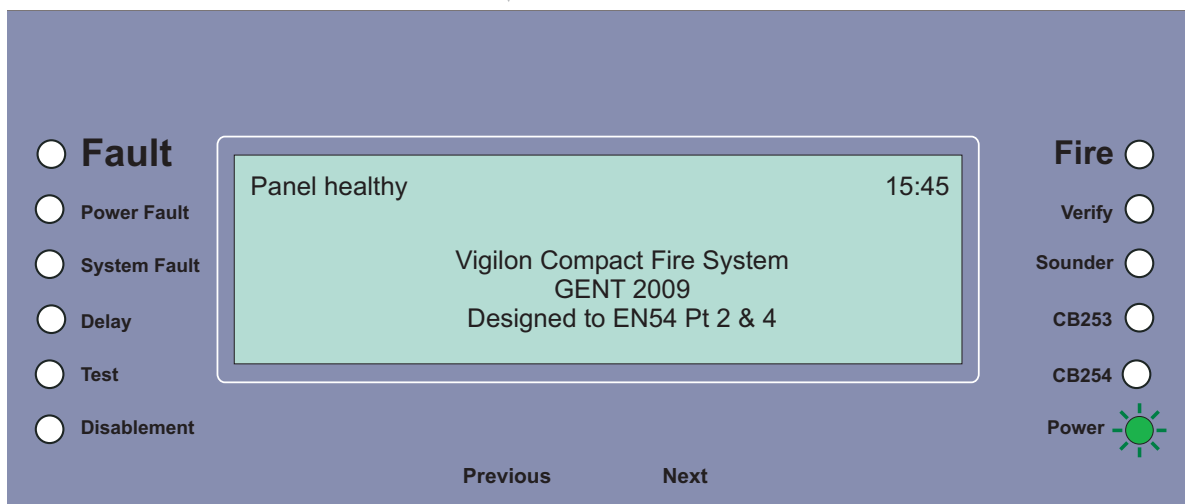
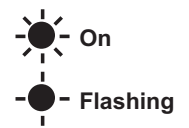

How to operate a 'U' button

The U1 and U2 buttons may have been configured during commissioning to action user-defined tasks, such as disablement of devices in areas where smoke may be generated or where plant shutdown is required. The function of these buttons should be written on the label that is fitted on the back of the outer door.

To activate a 'U' button.

You can activate the predefined task by operating the 'U' button.



Press:

n - can be 1 or 2.

Display reads what task is being carried out.

Operating instructions

Weekly tests

Every week during normal working hours the fire detection and alarm system should be tested. It is important to inform the alarm receiving centre of the fire test.

The weekly fire test can be carried out at a manual call point without breaking the call point glass.

- Insert the test key into the keyhole located on the bottom-centre front face of the call point and turn the key one quarter of a turn clockwise.
- Where an older manual call point is to be tested, insert a test key into the hole located on the underside of the call point and push the key into the call point to operate the cam mechanism. This will activate the call point.

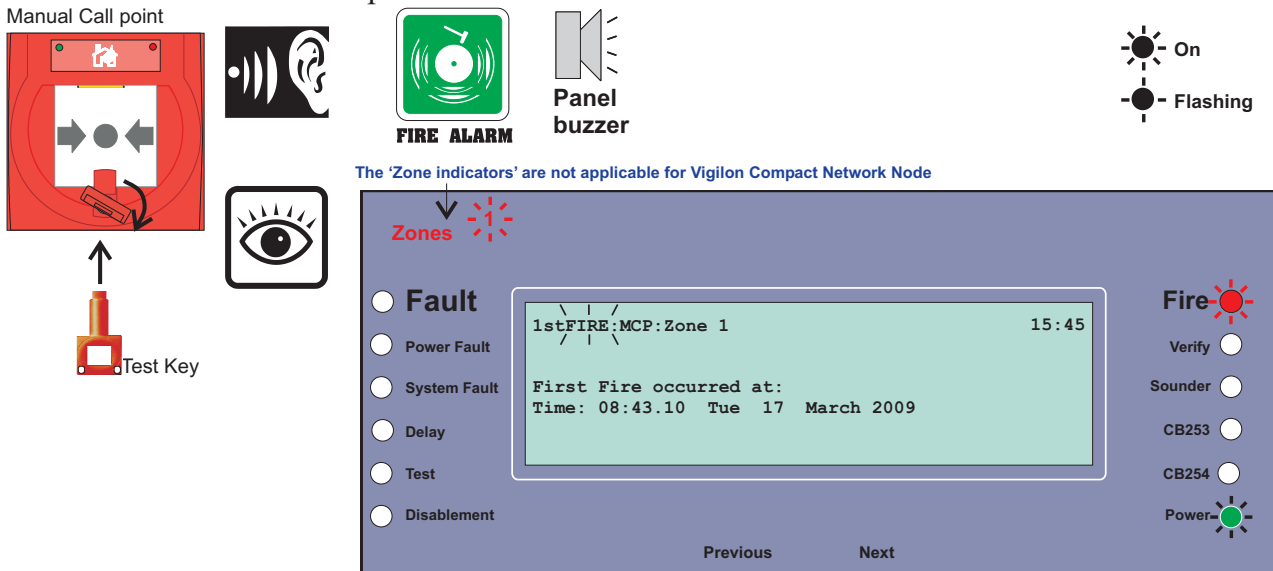

At this point the test key is retained in the call point.

- Check the alarms are sounding in the building and an indication is given of the fire event.
- Turn the key anticlockwise one quarter of a turn and remove it from the call point. For an older manual call point remove the test key from the call point.
- You will need to open the panel door to silence the alarms and reset the system.

To cancel buzzer

You can stop the panel buzzer from sounding.

Cancel Buzzer

Press:



Display reads: *'Buzzer cancelled'*

To silence alarms

When the test is complete, the alarm sounders can be silenced.

Silence Alarms

Press:



Display reads: *'Alarms silenced'*

To reset system

To return the system to normal condition clear any residual smoke or heat from sensors and replace the glass in any manual call points where the glass was broken.

Reset

Press:



Display reads *'System being Reset - please wait...'*

Record the event

Make an entry in the log book of the event for future reference.

How to manually raise an alarm of FIRE



If you see a fire in the protected premises and want to raise a fire alarm to warn occupants in the building, you can do this manually by:

- Going to the nearest manual call point that is located away from the fire hazard.
- Press hard with a thumb onto the centre of the glass until it breaks.

Manual Call point

The 'Zone indicators' are not applicable for Vigilon Compact Network Node

Zones

Fault

- Power Fault
- System Fault
- Delay
- Test
- Disablement

1stFIRE:MCP:Zone 1 15:45

First Fire occurred at:
Time: 08:43.10 Tue 17 March 2009

Fire

- Verify
- Sounder
- CB253
- CB254
- Power

Previous Next

To cancel panel buzzer

You can stop the panel buzzer from sounding.

Cancel Buzzer



Press:

Display reads:

'Buzzer cancelled'

To silence alarms

When the emergency is over the alarm sounders can be silenced.

Silence Alarms



Press:

Display reads:

'Alarms silenced'

To reset system

To return the system to normal condition clear any residual smoke or heat from devices and reset any fire inputs.

Reset



Press:

Display reads *'System being Reset - please wait...'*

Ensure the fire system is checked by your servicing organisation if there has been fire damage in the protected area.

Record the event

Make an entry in the log book of the event for future reference.

Automatic detection of FIRE



A fire in your protected premises is automatically sensed at any one of the fire detection devices installed in the building, such as a sensor or a fire input from an interface. The control panel actions the alarm sounders in the system and at the same time gives the details of the fire event. The event indication is repeated at all repeat indicator panels in the system.

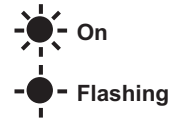

The 'Zone indicators' are not applicable for Vigilon Compact Network Node

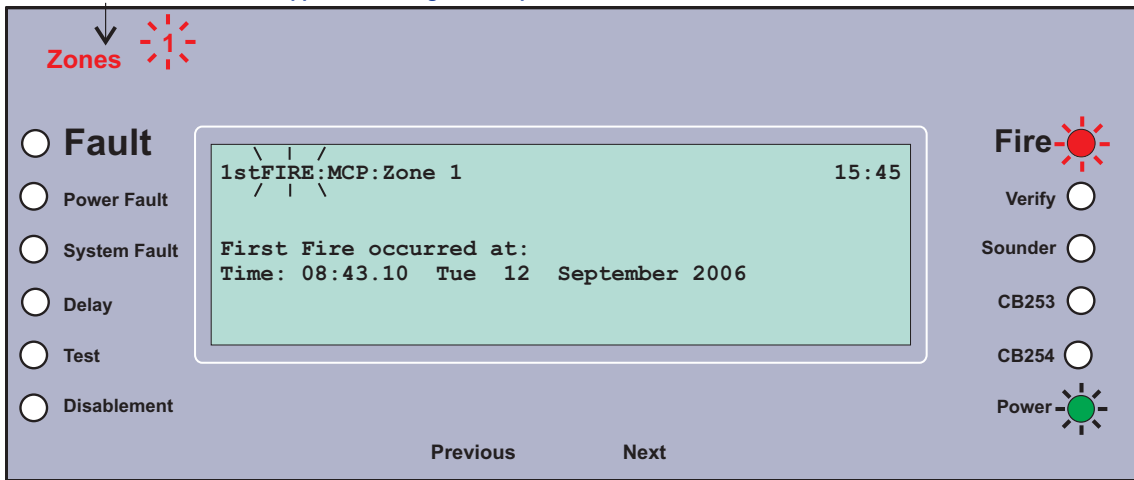

To cancel panel buzzer

You can stop the panel buzzer from sounding.

Cancel Buzzer



Press:

Display reads:

'Buzzer cancelled'

To silence alarms

When the emergency is over the alarm sounders can be silenced.

Silence Alarms



Press:

Display reads:

'Alarms silenced'

To reset system

To return the system to normal condition clear any residual smoke or heat from devices and reset any fire inputs.

Ensure the fire system is checked by your servicing organisation if there has been fire damage in the protected area.

Reset



Press:

Display reads: *'System being Reset - please wait....'*

Record the event Make an entry in the log book of the event for future reference.

Multiple fires

The 1st Fire will always appear at top of display. All subsequent fires appear beneath the 1st Fire.

The zonal indicators show zones in fire condition. If the panel is configured, the first zone to go into a fire condition may be indicated by a flashing zone number, all other zones in fire give a steady indication.

Use the [Previous] or [Next] buttons to scroll the fire events.

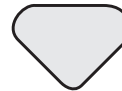

Zones 



The zone indicators are not applicable for Compact Network Node.

Each fire is logged in the Historic Events log, which can be recalled using the menus. See How to view the Historic Events.

To verify an alarm (If required by site procedures)

Upon receipt of a fire condition the alarm sounders in the system can be delayed from sounding by using the Verify button. This allows time to investigate the cause of the alarm.

Note, delayed sounders will operate after the verify period has timed-out.

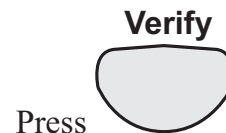

Press



Fault conditions

A fault in the system, such as failure of mains power to the panel or removal of any monitoring device will cause a Fault condition to appear at the control panel. The control panel will provide details of the event, this event indication is repeated at all repeat indicators, zonal and mimic panels in the system.





Panel
buzzer



On

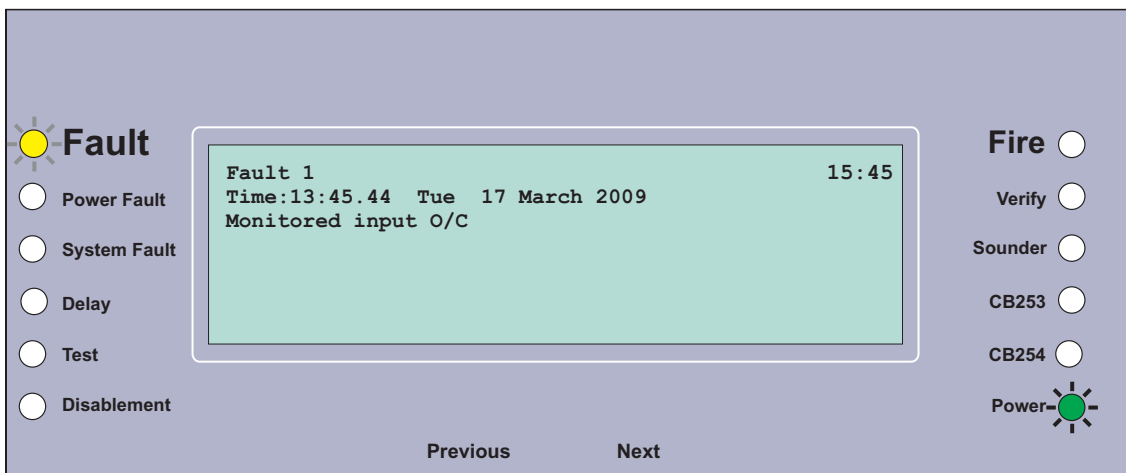

Flashing



To cancel fault buzzer

You can stop the panel buzzer from sounding.

Cancel Buzzer



Press:

Display reads:

'Buzzer cancelled'

What must be done?

You need to ensure the panel is returned to normal condition. All fault repairs must be undertaken by engineers responsible for the system. Refer to the contact details in the log book.

Record the event

Make an entry in the log book of the event for future reference.

Multiple faults

The number '*n*' following the word '*Fault*' located top left on the display denotes the number of faults present in the system.

Each fault is logged in the Historic Events log, which can be recalled using the menus. See How to view the Historic Events.



















Only the trained engineer who is responsible for the fire alarm system must attempt any fault rectification work. For advice please call your servicing organisation, see contact details in the Log book.

Typical fault messages

The table below shows some of the more typical fault messages and indications that may appear at the panel if there are faults in the system. It also gives the meaning and possible rectification action for each fault.

Flashing  On 

Message	Indication	Meaning	Action
Mains failed	Fault  Power fault 	The mains supply to the control panel has failed.	Restore the mains supply to the control panel.
Battery discharged n	Fault  Power fault 	The battery supply to the Control Panel has been fully discharged.	Check the battery and replace if necessary.
Battery disconnected	Fault  Power fault 	The battery supply to the Control Panel has been disconnected.	Reconnect the battery.
Monitored line input OC or SC	Fault 	The monitored line input has an open or short circuit fault.	Check the wiring and ensure the end of line device is connected in the circuit.
Master Alarm(s) OC or SC n	Fault  Sounder 	There is an open or short circuit fault on the master alarm wiring.	Check the wiring. Ensure the end-of-line device is connected in the circuit.
Lost Device	Fault  Sounder 	The Device is not communicating with the Control Panel via the Loop. Additional indication given if it is a Sounder device.	Check the connections to the device.
Sensor out of specification	Fault 	The device indicated is not functioning correctly.	Device needs replacing.
Wiring changed SC at card n	Fault 	There is a short circuit on the loop n wiring.	Identify the device where a cable fault has occurred and remove the fault.
Interface input OC /SC	Fault 	There is an open or short circuit on the input line of an interface.	Locate and remove the wiring fault. Ensure the end of line device is connected in the circuit.
Device Mains failed	Fault 	There is a mains supply failure at an interface unit, repeat panel or mimic panel	Check the fuse and mains supply to the equipment.
Device Battery fault	Fault 	The battery supply at an interface unit, repeat panel or mimic panel has failed the load test.	Check the battery and replace if necessary.

Disablement conditions

A disablement condition is the manual or automatic disablement of a part of the fire detection system. An automatic disablement may be pre-configured for your premises to disable smoke sensors during the normal working hours in areas where smoke or dust may be present. A manual disablement may be necessary where building work is being undertaken that could result in a false alarm.

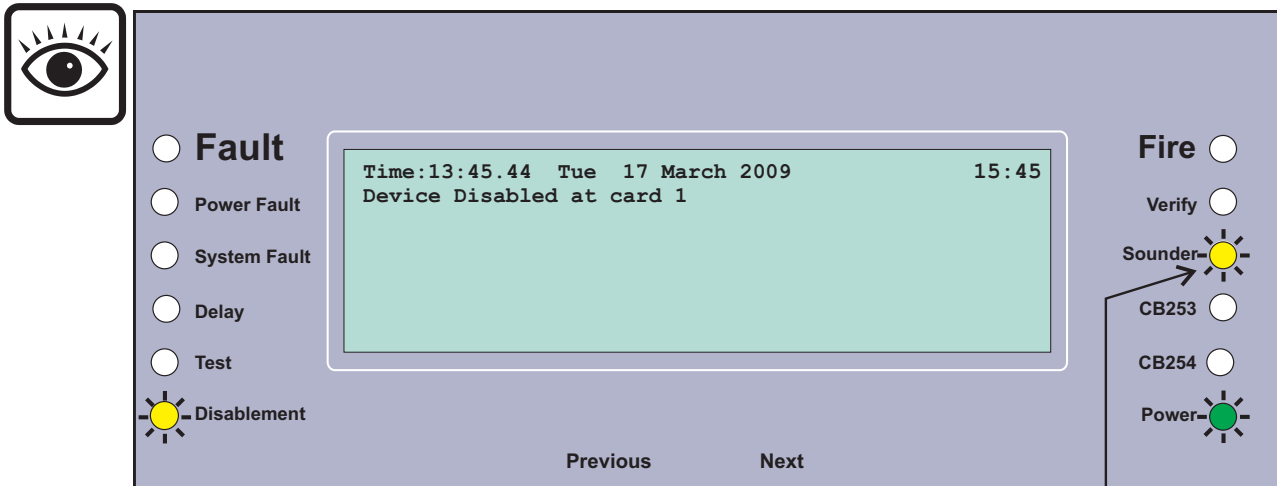
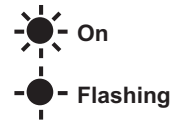

This indication is only given if a sector, sounder device or master alarms in the system are disabled.

What must be done?

Investigate the reason for the disablement and re-instate the devices if appropriate.

Record the event

Where necessary make an entry in the log book of the event for future reference.

Multiple Disablements









The number '*n*' following the word '*Disable*' located top left on the display denotes the number of disablements present in the system.

Each disablement is logged in the Historic Events log which can be recalled using the menus, see How to view the Historic Events.

Typical Disablement Messages

The following table shows some typical disablement messages and indications that may appear at the panel.

Flashing  On 

Message	Indication	Meaning	Action
Zone Disabled at card n	Disablement 	The zone specified has been manually or automatically disabled.	If manually disabled then investigate and if necessary re-enable the zone.
Device disabled at card n	Disablement  Sounder 	The device connected to the loop circuit has been manually or automatically disabled. Additional indication is given if it is a sounder device.	If manually disabled then investigate and if appropriate re-enable the device.
Sector disabled at card n	Disablement  Sounder 	The fire alarm sector on loop n has been manually or automatically disabled.	If manually disabled then investigate and if appropriate, re-enable the sector.
Disabled Aux Relay n	Disablement 	The auxiliary relay n in the control panel has been manually or automatically disabled	If manually disabled then investigate and if appropriate, re-enable the aux relay.
Master alarm(s) disabled	Disablement  Sounder 	The master alarms have been manually or automatically disabled.	If manually disabled then investigate and if appropriate, re-enable the master alarms.



Any changes to the setting of an automatic disablement must only be attempted by a trained engineer who is responsible for the fire alarm system, see contact details in the Log book.

Menu controls



Panel beeps
on button press



On



Flashing

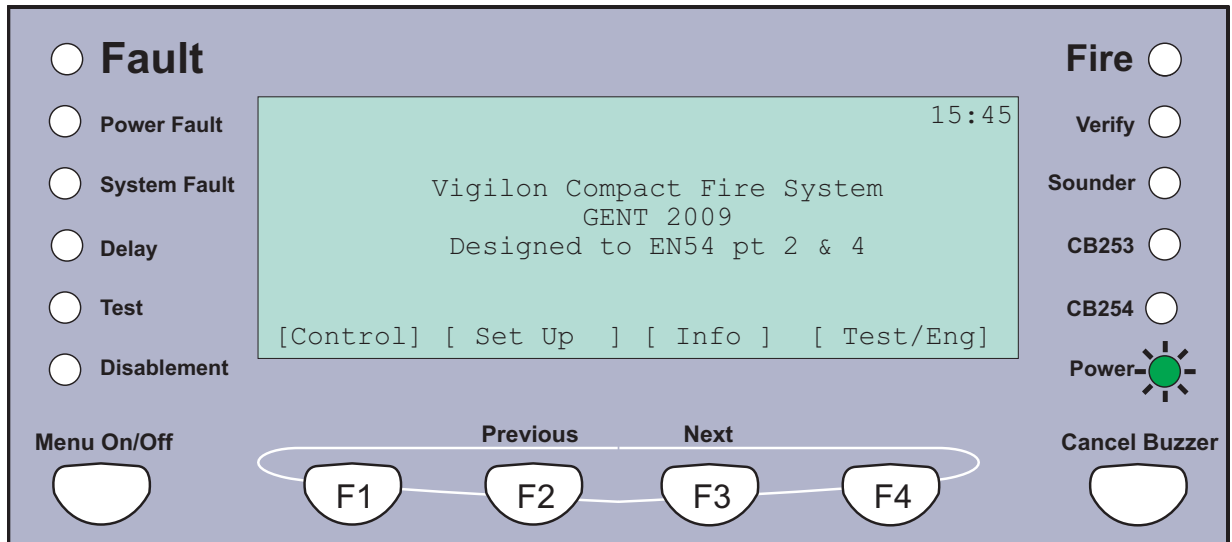

The **MENU ON/OFF** button facilitates the operation of the function keys F1 to F4. The menu prompts appear above the function keys on the display to prompt the user to make a selection.

At any level in a menu, single press of the **MENU ON/OFF** key aborts an operation. However as an alternative the **[Quit]** option can be selected to exit the function mode.

If the time taken between key presses exceeds **five minutes**, then the control panel will automatically remove the option display and give the system status indications.

The **[Params]** option is a Help function to provide information to the user regarding the type of input data required.

Most of the functions in the **[Control]**, **[Setup]** and **[TestEng]** menu options are protected with password entry. The password is programmed during the commissioning of the system and is passed on to the site person responsible for the fire alarm system.



Open access to controls under User code is undesirable. It is recommended that a customer password is setup.

When a **password** code is not set up, there is an open entry to operate the controls under **[User Code]**. Where this is true the instructions for entering the access code, password (or PIN) in the following instructions should be ignored.

To carry out a display test

You can test the message display and the indicators on the control panel.

- a. Press the **MENU ON/OFF** key and then the F4 key to select **[Test/Eng]**.
- b. Press the F1 key to select **[Disp Test]**. Check that the following things happen: The display clears, the indicators illuminate, the buzzer sounds two distinct tones and then the display shows the system status message. The display test lasts for 4 seconds.

How to change your PIN code



The following terms: **Password, PIN, Usercode and Access code** mean the same and are used interchangeably.

A Customer user PIN code (password) is normally set up by the servicing organisation during commissioning of the fire alarm system. The customer PIN code is set up for the end user. The person responsible for the fire alarm system should be aware of this PIN code. For security the PIN should be changed on a regular basis.

A previously created PIN can be changed by:

- a. Press the **MENU ON/OFF** button.
- b. Press the F4 button to select **[Test/Eng]**.
- c. Press the F4 button to select **[UserCode]**. Use the keypad to input your existing access code and then press the Enter button.
- d. Press the F1 button to select **[NewPass]**. Notice a message on the display '*Enter new access code*' with a flashing cursor above it. Ensure you memorise the new PIN code. Use the keypad to input a new PIN code and then press the **Enter** button. Notice '*New access code set up*' appears on the display.



Any changes made to the PIN code must be backed-up to the panel memory. If this is not done then the previous PIN is restored on resetting the panel, see section on How to save changes to memory.

It is not necessary to backup the password at a repeat panel.

How to view the historic events

Up to 255 events are stored in the Historic log of the panel. To view the Historic log.

- a. Press **MENU ON/OFF**.
- b. Press the F3 button to select **[Info]**.



Ignore step c. if an external printer is not fitted or is switched off.

- c. To display the event(s): Press the F1 button to select **[Display]**. Notice 'Display' appears on the display.
To print the event(s): Press the F2 button to select **[Print]**. Notice 'Print' appears on the display.
- d. Press the F2 button to select **[Historic]**. Notice 'Historic' followed by a flashing cursor appears on the display.
- e. Use the keypad to input an event number 1 to 255.
If you want to view events at another node in a networked system, then you will need to know the node number. Select **[Node]** and enter the node number.



Event '1' is always the most recent event.

- f. Press the F2 button to select **[Enter]**. Notice the required event(s) are displayed or printed depending on your selection.

Cards inside the control panel

The control panel uses the following card reference numbers.

- Card 0** is always the **Main controller board (MCB)**, also referred to as a local controller.
- Cards 1 or 2** are always the **Loop cards** that monitor and control the devices on loop circuits within the protected premises.
The loop cards are not applicable for Compact Network Node.
- Cards 9** can be a **Fibre network card** only
- Card 10** can be either **Fibre network card** or **Copper network card**
- Card 14** is always the **memory** that resides on the **Main controller board**.

How to save changes to memory

If you make any changes to a Labels or Password then you must save these to the NVM (Non Volatile Memory) or Memory of the panel.



Changes made to labels and password can be saved to the panel memory (NVM), this can only be done when there are no disablements present on the system.

The following procedures assume a customer password (PIN) is setup at the panel.

- a. Press the **MENU ON/OFF** button.
- b. Press the F2 button to select **[Set Up]**.
- c. Press the F4 button to select **[UserCode]**. Notice a message on the display *'Enter access code'* followed by a flashing cursor. Use the keypad to input your PIN code and then press the **Enter** button.
- d. Press the F4 button to select **<etc>** and then press the F3 button to select **[Save]**.



The 'Save' option is only available if Access level 2 PIN is set up.

- e. Press the F2 button to select **[Enter]**. Observe confirmation of data backed up.

How to view active events

An active event is an event that is still present and has not cleared. You can view all active Fire, Fault or Disablement events.

- a. Press **MENU ON/OFF**.
- b. Press the F3 button to select **[Info]**.



Ignore step c. if an external printer is not fitted or is switched off.

- c. To display the event(s): Press the F1 button to select **[Display]**. Notice *'Display'* appears on the display.
To print the event(s): Press the F2 button to select **[Print]**. Notice *'Print'* appears on the display.
- d. Press the F1 button to select **[Active]**. Notice *'Active'* appears on the display.
If you want to view events on the local panel card by card basis then press the F3 button to select **[Card]** notice *'on card'* appears on the display, then enter the card number.
If you want to view events at another node in a networked system, then you will need to know the node number. Press the F4 button to select **[Node]** and enter a node number from a range 1 to 255.
- e. Press the F2 button to select **[Enter]**. Notice all of the active Fire, Fault and Disablement events are displayed in turn. Press the F2 **[Previous]** and F3 **[Next]** button to scroll through the displayed events.
- f. Press the F4 button to select **[Quit]**, when viewing of events is complete.

How to set the system clock



An incorrect setting of the system clock will affect any time related sensor configuration and consequently results in incorrect event time information.

- a. Press the **MENU ON/OFF** key and then the F2 key to select **[Set Up]**.
- b. Press the F4 key to select **[User Code]**. Check that 'User Code' followed by a flashing cursor appears on the screen. Key in the PIN code and press the **Enter** button.
- c. Press the F1 key to select **[Set Clock]**. The system clock is displayed on the screen. Check that the hour digits are flashing.
- d. Press the F2 or F3 key to **[Retard]** or **[Advance]** to the desired setting.
- e. Press the F1 key to select **[Next]**. Check that the Minute digits are now flashing.
- f. Press the F2 or F3 key to **[Retard]** or **[Advance]** to the desired setting.
- g. Press the F1 key to select **[Next]**. Check that the Date digits are now flashing.
- h. Press the F2 or F3 key to **[Retard]** or **[Advance]** to the desired setting.
- i. Press the F1 key to select **[Next]**. Check that the Month digits are now flashing.
- j. Press the F2 or F3 key to **[Retard]** or **[Advance]** to the desired setting.
- k. Press the F1 key to select **[Next]**. Check that the Year is now flashing.
- l. Press the F2 or F3 key to **[Retard]** or **[Advance]** to the desired setting.
- m. Press the F4 key to select **[Enter]**. Check that the display now shows the new time and date.



Any changes made to the time and date will be automatically sent to the repeat panels in the system. The system clock adjusts automatically for Day light saving, if set up during commissioning. Now 'Save' the changes made to the clock settings.

How to use the external printer

These functions assume there is an external printer connected to the panel.

To Switch On the Printer

- a. Press the **MENU ON/OFF** key.
- b. Press the F1 key to select **[Control]**.
- c. Press the F3 key to select **[Printer]**. Check that 'Printer' appears on the screen.
- d. Press the F3 key to select **[On]** and then press the F2 key to select **[Enter]**. Check that the message 'Printer is on' appears on the display and a printout is given to show that the action has been successfully carried out.

To action a Paper Feed

- a. Press the **MENU ON/OFF** key.
- b. Press the F1 key to select **[Control]**.
- c. Press the F3 key to select **[Printer]**. Check that 'Printer' appears on the screen.
- d. Press the F2 key to select **[Paper Fd]**. Note the display and menu prompts are cleared.
- e. Check that the printer performs eight line feeds.

To conduct a Printer Test

- a. Press the **MENU ON/OFF** key.
- b. Press the F1 key to select **[Control]**.
- c. Press the F3 key to select **[Printer]**. Check that 'Printer' appears on the screen.
- d. Press the F1 key to select **[Test]**. Note the display and menu prompts are cleared.
- e. Check that the printer provides a listing of all the characters it is capable of printing.

To Switch Off the Printer

- a. Press the **MENU ON/OFF** key.
- b. Press the F1 key to select **[Control]**.
- c. Press the F3 key to select **[Printer]**. Check that 'Printer' appears on the screen.
- d. Press the F3 key to select **[Off]**.
- e. Press the F2 key to select **[Enter]**.
- f. Check that the message 'Printer is off' appears on the display to show that the action has been successfully carried out.

How to enable/disable a zone



These operations are not applicable for a Compact Network Node.

A zone is a subdivision of your premises protected by the fire alarm system. There can be up to 128 zones configured in a system. Any zone operation can be disabled or enabled. You will need the zone number, this you can find in the site specific documentation held by the person responsible for the fire alarm system.

- a. Press the **MENU ON/OFF** key.
- b. Press the F1 button to select **[Control]**.
- c. Press the F4 button to select **[UserCode]**. Notice a flashing cursor and a message on the display 'Enter access code'. Use the keypad to input your PIN code and then press the **Enter** button.
- d. To disable a zone: Press the F2 button to select **[Disable]**. This puts 'Disable' on the display. To enable a zone: Press the F1 button to select **[Enable]**. This puts 'Enable' on the display.
- e. Press the F4 button to select **<etc>** and then press the F2 button to select **[Zone]**. Notice 'Zone' appears on the display followed by a flashing cursor. Use the keypad to input a zone number or range (1-128).
- f. Press the F2 button to select **[Enter]**. Notice the action has been processed and a message appears on the display 'Zone n enabled' or 'Zone n disabled'. The Disablement light will be illuminated upon disablement of any zone.

How to enable/disable Sensing



These operations are not applicable for a Compact Network Node.



It is only possible to disable a Manual Call Point (MCP) individually, not as part of a range. Disabling a MCP is however, not recommended.

A sensing device such as sensor or MCP connected to the loop circuit of the system can be disabled/enabled. You will need the device number and loop number, this you can find in the site specific documentation, held by the person responsible for the fire alarm system.

- a. Press the **MENU ON/OFF** key.
- b. Press the F1 button to select **[Control]**.
- c. Press the F4 button to select **[UserCode]**. Notice a flashing cursor and a message on the display 'Enter access code'. Use the keypad to input your PIN code and then press the **Enter** button.
- d. To disable a device: Press the F2 button to select **[Disable]**. This puts 'Disable' on the display. To enable a device: Press the F1 button to select **[Enable]**. This puts 'Enable' on the display.
- e. Press the F1 button to select **[Sensing]**. Notice 'Device' followed by a flashing cursor appears on the display. Use the keypad to input an device number or range (1-200).
- f. Press the F2 button to select **[Loop]**. Notice 'Loop' followed by a flashing cursor on the display. Use the keypad to input a loop number or range (1-2).
- g. Press the F2 button to select **[Enter]**. Notice the action has been processed and confirmed by a message either: 'Device(s) enabled' or 'Device(s) disabled'. Notice that the Disablement light is illuminated upon disablement of any system device.

How to enable/disable an IO line



These operations are not applicable for a Compact Network Node.

There can be up to four input/output lines on an interface unit, which can be disabled or enabled. You will need the IO line, device and loop numbers, these numbers are normally in the site specific documents held by the person responsible for the fire system.



An output line of an interface unit, like the mains powered interface may be assigned to a sector. Such output line can only be disabled by disabling that sector, which has the effect of also disabling all other devices in the sector.

- a. Press the **MENU ON/OFF** key.
- b. Press the F1 button to select **[Control]**.
- c. Press the F4 button to select **[UserCode]**. Notice a flashing cursor and a message on the display 'Enter access code'. Use the keypad to input your PIN and then press the **Enter** button.
- d. To disable an IO line: Press the F2 button to select **[Disable]**, puts 'Disable' on the display. To enable an IO line: Press the F1 button to select **[Enable]**, puts 'Enable' on the display.
- e. Press the F2 button to select **[IO Line]**. Notice 'IO Line' followed by a flashing cursor appears on the display. Use the keypad to input an IO line number from a range 1 to 4.
- f. Press the F2 button to select **[Device]**. Notice 'Device' followed by a flashing cursor appears on the display. Use the keypad to input an device number from a range 1 to 200.
- g. Press the F2 button to select **[Loop]**. Notice 'Loop' followed by a flashing cursor appears on the display. Use the keypad to input a loop number from a range 1 to 2.
- h. Press the F2 button to select **[Enter]**. Notice the action has been processed and a message appears on the display: 'IO line disabled/enabled at Card n'. The disablement light will illuminate upon disablement of an IO line.

How to enable/disable aux relay

The control panel / network node has two auxiliary relays that provide voltage free contacts to control external equipment in the event of a fire or fault on the system. The operation of the relays can be disabled or enabled.

- a. Press the **MENU ON/OFF** key.
- b. Press the F1 button to select **[Control]**.
- c. Press the F4 button to select **[UserCode]**. Notice a flashing cursor and a message on the display 'Enter access code'. Use the keypad to input your PIN code and then press the **Enter** button.
- d. To disable auxiliary relay: Press the F2 button to select **[Disable]**. This puts 'Disable' on the display. To enable auxiliary relay: Press the F1 button to select **[Enable]**. This puts 'Enable' on the display.
- e. Press the F4 button three times selecting **<etc>** on each occasion and then press the F2 button to select **[Aux Rly]**. Notice 'Aux Rly' followed by a flashing cursor appears on the display. Use the keypad to input an auxiliary relay number or range (1-2).
- f. Press the F2 button to select **[Enter]**. Notice the action has been processed and a message appears on the display: 'Aux Rly n disabled/enabled'. The Disablement light will illuminate upon disablement of an auxiliary relay.

Other enable/disable options

There are other options such as Sounders, Command Build, Group, and Communication that are accessible for enablement and disablement, for further advice contact your servicing organisation, see the Log book for contact details.

Viewing labels

The identification label given to each system device can be checked. Devices such as fire sensors, alarm sounders, manual call points, interface units - including input/output lines may have been given labels, groups and the local panel may also have label. The label information can either be displayed or printed, if a printer is connected to the panel.

How to view a device label



This operation is not applicable for a Compact Network Node.

Each device is given a location label at the time the system is commissioned to identify its installation position. To view a device label you will need to know the device address and the loop on which it resides. You can find this information in the site specific documentation, held by the person responsible for the fire alarm system.

- a. Press the **MENU ON/OFF** button.
- b. Press the F3 button to select **[Info]**.



Ignore step c. if an external printer is not fitted or is switched off.

- c. To display a Device label: Press the F1 button to select **[Display]**. Notice 'Display' appears on the display. To print a Device label: Press the F2 button to select **[Print]**. Notice 'Print' on the display, then continue.
- d. Press the F4 button to select **<etc>**.
- e. Press the F2 button to select **[Label]**. Notice 'Label' appears on the display.
- f. Press the F3 button to select **[Device]**. Notice 'Device' followed by a flashing cursor appears on the display. Use the keypad to input a Device number or range (1-200).
- g. Press the F2 button to select **[Loop]**. Notice 'Loop' followed by a flashing cursor appears on the display. Use the keypad to input a loop number (1 or 2).
- h. Press the F2 button to select **[Enter]**. Notice the selected label information is either displayed or printed.

How to view a I/O line label



This operation is not applicable for a Compact Network Node.

An interface unit can have up to four input/output (IO) lines. Each line can be given a label that appears on the display during an event. To view an IO line label you will need to know the device address and the IO line number and the loop number of the interface. You can find this information in the site specific documentation, held by the person responsible for the fire alarm system.

- a. Press the **MENU ON/OFF** button
- b. Press the F3 button to select **[Info]**.



Ignore step c. if an external printer is not fitted or is switched off.

- c. To display an I/O line label: Press the F1 button to select **[Display]**. Notice 'Display' appears on the display.
To print an I/O line label: Press the F2 button to select **[Print]**. Notice 'Print' on the display, then continue.
- d. Press the F4 button to select **<etc>**
- e. Press the F2 button to select **[Label]**. Notice 'Label' appears on the display.
- f. Press the F2 button to select **[IO Line]**. Notice 'IO Line' followed by a flashing cursor appears on the display. Use the keypad to enter an input/output line number from a range 1 to 4.
- g. Press the F2 button to select **[Device]**. Notice 'Device' followed by a flashing cursor on the display. Use the keypad to input a Device number (1-200).
- h. Press the F2 button to select **[Loop]**. Notice 'Loop' followed by a flashing cursor appears on the display. Use the keypad to input a loop number (1 or 2).
- i. Press the F2 button to select **[Enter]**. Notice the selected label information is either displayed or printed.

How to view a zone label



This operation is not applicable for a Compact Network Node.

A zone is a subdivision of a building used for fire detection. To view a zone label you will need to know the zone number. You can find this information in the site specific documentation, held by the person responsible for the fire alarm system.

- a. Press the **MENU ON/OFF** button.
- b. Press the F3 button to select **[Info]**.



Ignore step c. if an external printer is not fitted or is switched off.

- c. To display a Zone label: Press the F1 button to select **[Display]**. Notice 'Display' appears on the display.
To print a Zone label: Press the F2 button to select **[Print]**. Notice 'Print' on the display, then continue.
- d. Press the F4 button to select **<etc>**.
- e. Press the F2 button to select **[Label]**. Notice 'Label' appears on the display.
- f. Press the F4 button once to select **<etc>**.
- g. Press the F1 key to select **[Zone]**. Notice 'Zone' followed by a flashing cursor appears on the display. Use the keypad to input a Zone number from a range 1-128.
- h. Press the F2 key to select **[Enter]**. Notice the selected label information is either displayed or printed.

How to view the local panel label

When there is a network of control panels and nodes connected together in a system and each panel/node is usually given an identification label, also referred to as the Local panel label.

- a. Press the **MENU ON/OFF** button.
- b. Press the F3 button to select **[Info]**.



Ignore step c. if an external printer is not fitted or is switched off.

- c. To display the local panel label: Press the F1 button to select **[Display]**. Notice 'Display' appears on the display.
To print the local panel label: Press the F2 button to select **[Print]**. Notice 'Print' appears on the display, then continue.
- d. Press the F4 button to select **<etc>**
- e. Press the F2 button to select **[Label]**. Notice 'Label' appears on the display.
- f. Press the F4 button once to select **<etc>**.
- g. Press the F2 key to select **[Local]**. Notice 'Local' appears on the display.
- h. Press the F2 key to select **[Enter]**. Notice the selected label information is either displayed or printed.

To view or print a map



The [Loop map] option is not applicable for Compact Network Node.

A map provides information on devices that are connected to a loop on the system or panels/nodes in a system.

- a. Press the **MENU ON/OFF** button.
- b. Press the F3 button to select **[Info]**.



Ignore step c. if an external printer is not fitted or is switched off.

- c. To display the loop map: Press the F1 button to select **[Display]**. Notice 'Display' appears on the display.
To print the loop map: Press the F2 button to select **[Print]**. Notice 'Print' appears on the display, then continue.
- d. Press the F4 button to select **<etc>**.
- e. Press the F4 button to select **[UserCode]**. Notice a message on the display 'Enter access code', followed by a flashing cursor. Use the keypad to input your PIN and then press **Enter** button.
- f. Press the F3 button to select **[Loop Map] or [Map]**.
- g. On selecting **[Map]** you have a choice of either **[Loop Map]** or **[Net Map]**.
- h. On selecting **[Loop Map]** notice 'Loop Map' followed by a flashing cursor appear on the display.

On selecting **[Net Map]** notice 'Node' followed by a flashing cursor appear on the display.
- i. Use the keypad to enter the loop number or node number and then press F3 to select **[Enter]**. Notice the map is either printed or displayed.

Editing labels



Any changes to labels must be backed up to the Memory, see the section 'How to save changes to the memory'.

How to edit a device label



This operation is not applicable for a Compact Network Node.

There can be up to 200 devices connected to a loop, devices like fire sensors and manual call points. Each device can be given a label to identify its location in the system. Devices in your system may have already been given labels and these labels can be changed. To edit a device label you will need to know the device number and the loop on which it resides. You can find this information in the site specific documentation, held by the person responsible for the fire system.

- a. Press the **MENU ON/OFF** button
- b. Press the F2 button to select **[Set Up]**.
- c. Press the F4 button to select **[UserCode]**. A message is displayed: 'Enter access code' followed by a flashing cursor. Use the keypad to input your PIN and then press the **Enter** button.
- d. Press the F4 button once to select **<etc>**.
- e. Press the F1 button to select **[Modify]**. Notice 'Modify' appears on the display.
- f. Press the F1 button to select **[Label]**. Notice 'Label' appears on the display.
- g. Press the F3 button to select **[Device]**. Notice 'Device' followed by a flashing cursor appears on the display.
- h. Use the keypad to input a Device number.
- i. Press the F2 button to select **[Loop]**. Notice 'Loop' followed by a flashing cursor on the display. Use the keypad to input a loop number either 1 or 2.
- j. Press the F2 button to select **[Enter]**. Notice the previous label appears on the display with a flashing first character to prompt the modification, if there is no label the line is blank.
- k. Using the keypad to enter a label of up to 32 characters in length (28 for MCP) and then press the **Enter** button.

How to edit Input/output line label



This operation is not applicable for a Compact Network Node.

Each input / output (IO) line of an interface unit can be given a label and a previously entered label can be modified. To edit an IO line label you will need to know the IO line number, interface device number and the loop number it is connected to. You can find this information in the site specific documentation, held by the person responsible for the fire alarm system.

- a. Press the **MENU ON/OFF** button.
- b. Press the F2 button to select **[Set Up]**.
- c. Press the F4 button to select **[UserCode]**. Notice a message on the display 'Enter access code', followed by a flashing cursor. Use the keypad to input your PIN and then press **Enter** button.
- d. Press the F4 button once to select **<etc>**
- e. Press the F1 button to select **[Modify]**. Notice 'Modify' appears on the display.
- f. Press the F1 button to select **[Label]**. Notice 'Label' appears on the display.
- g. Press the F2 button to select **[IO Line]**. Notice 'IO Line' followed by a flashing cursor on the display. Using the keypad enter an input/output number from a range 1 to 4.
- h. Press the F3 button to select **[Device]**. Notice 'Device' followed by a flashing cursor appears on the display. Use the keypad to input a Device number from the range 1 to 200.
- i. Press the F2 button to select **[Loop]**. Notice 'Loop' followed by a flashing cursor on the display. Use the keypad to input a loop number 1 or 2.
- j. Press the F2 button to select **[Enter]**. Notice the previous label appears on the display with a flashing first character to prompt the modification, if there is no label the line is blank.
- k. Using the keypad enter a label of up to 32 characters in length and then press the **Enter** button.

How to edit a zone label



This operation is not applicable for a Compact Network Node.

Each zone can be given a label and an entered label can be modified. To edit a zone label you will need to know the zone number. You can find this information in the site specific documentation, held by the person responsible for the fire alarm system.

- a. Press the **MENU ON/OFF** button.
- b. Press the F2 button to select **[Set Up]**.
- c. Press the F4 button to select **[UserCode]**. Notice a message on the display 'Enter access code', followed by a flashing cursor. Use the keypad to input your PIN and then press **Enter** button.
- d. Press the F4 button once to select **<etc>**
- e. Press the F1 button to select **[Modify]**. Notice 'Modify' appears on the display.
- f. Press the F1 button to select **[Label]**. Notice 'Label' appears on the display.
- g. Press the F4 button once to select **<etc>**.
- h. Press the F1 button to select **[Zone]**. Notice 'Zone' followed by a flashing cursor appears on the display. Using the keypad enter a number from a range 1 to 128.
- i. Press the F2 button to select **[Enter]**. Notice the previous label appears on the display with a flashing first character to prompt the modification, if there is no label the line is blank.
- j. Using the keypad to enter a label of up to 32 characters in length and then press the **Enter** button.

How to edit a local panel label

A label is normally given to the control panel to identify its location in a network. A previously entered label can be modified.

- a. Press the **MENU ON/OFF** button.
- b. Press the F2 button to select **[Set Up]**.
- c. Press the F4 button to select **[UserCode]**. Notice a message on the display '*Enter access code*', followed by a flashing cursor. Use the keypad to input the PIN and then press **Enter** button.
- d. Press the F4 button once to select **<etc>**.
- e. Press the F1 button to select **[Modify]**. Notice '*Modify*' appears on the display.
- f. Press the F1 button to select **[Label]**. Notice '*Label*' appears on the display.
- g. Press the F4 button once to select **<etc>**.
- h. Press the F2 button to select **[Local]**. Notice '*local*' appears on the display.
- i. Press the F2 button to select **[Enter]**. Notice the previous label appears on the display with a flashing first character to prompt the modification, if there is no label the line is blank.
- j. Using the keypad to enter a label of up to 40 characters in length and then press the **Enter** button.

How to edit custom label

A custom message or label is displayed beneath the *Designed to EN54 Pt 2 & 4* line on the panel. The message or label can be up to 40 characters in length and it can be contact information of the person responsible for the fire alarm system or it can have contact phone number of the servicing organisation. Example: "For service call: *phone number*".

A previously entered label can be modified.

- a. Press the **MENU ON/OFF** button.
- b. Press the F2 button to select **[Set Up]**.
- c. Press the F4 button to select **[UserCode]**. Notice a message on the display '*Enter access code*', followed by a flashing cursor. Use the keypad to input the PIN and then press **Enter** button.
- d. Press the F4 button once to select **<etc>**.
- e. Press the F1 button to select **[Modify]**. Notice '*Modify*' appears on the display.
- f. Press the F1 button to select **[Label]**. Notice '*Label*' appears on the display.
- g. Press the F4 button once to select **<etc>**.
- h. Press the F3 button to select **[Custom]**. Notice '*Custom*' appears on the display.
- i. Press the F2 button to select **[Enter]**. Notice the previous label appears on the display with a flashing first character to prompt the modification, if there is no label the line is blank.
- j. Using the keypad enter a label of up to 40 characters in length and press the **Enter** button.

Maintenance

Replacing the glass on a new Manual Call Point

- Disengage the front cover from the call point assembly using the end of the test key. Insert the key into the slots 'E' and from the bottom edge lift out the cover.
- Carefully remove broken glass from the call point.



Take appropriate precautions when clearing the broken glass to prevent injury.

- Insert the key in the keyhole and turn the key such that the tab is at position 'F' and then insert a new glass as shown. Ensure the glass has engaged into the yellow arm.
- Hook the front cover onto the top edge of the call point assembly and then push the bottom edge down until it clicks shuts. Check both hooks on the top of the front cover are locked onto the call point assembly.
- Turn the test key anticlockwise one quarter of a turn such that the glass is held under the yellow arm and to reset the call point for normal operation.

S4-34891 Spare MCP glass (Pack of 10)

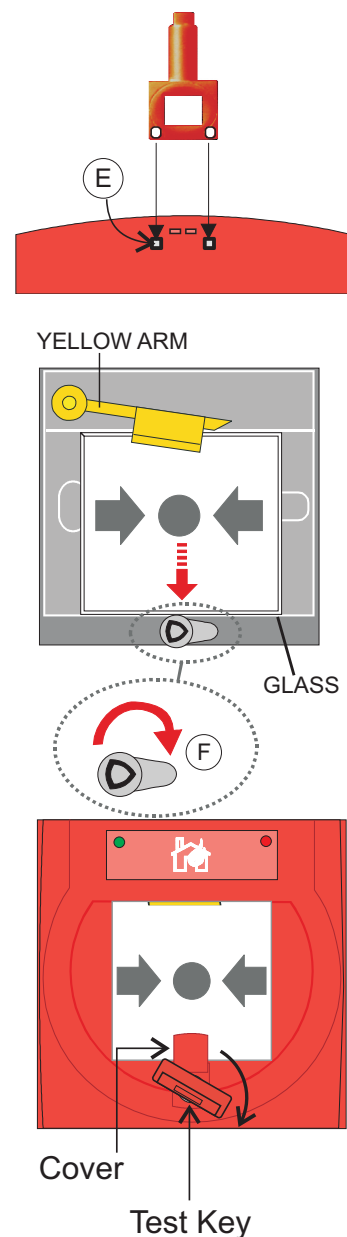

Resetting the resettable element on a new Manual Call Point

Slide the keyhole cover upwards to expose the keyhole. Insert the test key in the keyhole and turn it clockwise by one quarter of a turn. Then turn the test key anticlockwise by one quarter of a turn to reset the call point element.

Replacing the glass on an older Manual Call Point



Take appropriate precautions when clearing broken glass to prevent injury.



A weather resistant version of the manual call point may have two gaskets, there may be a Cover/glass gasket and a there will be a Spacer/cover gasket, which must be refitted in their respective positions.

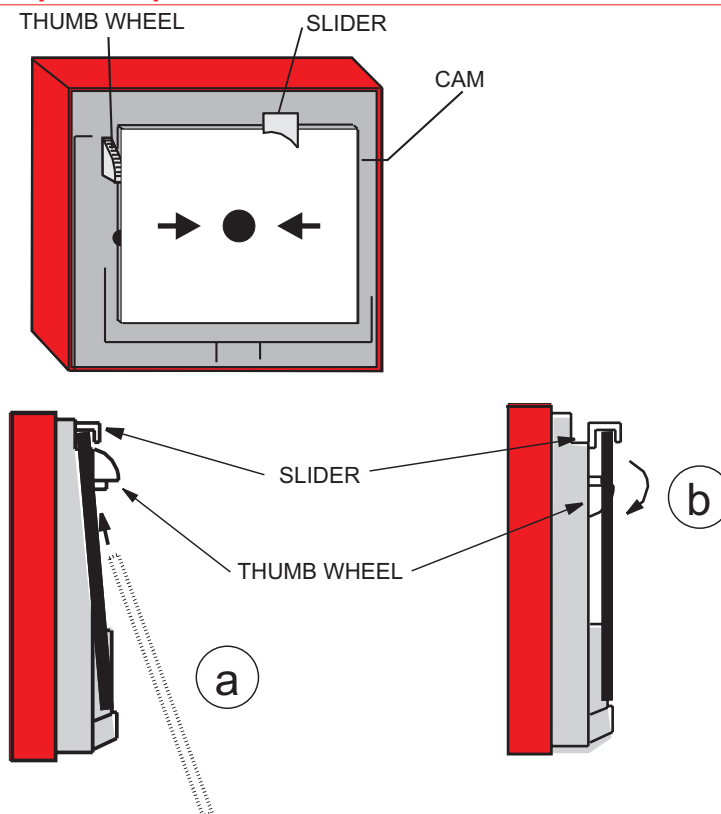

14112-09EN Spare MCP glass marked LPCB approved (Pack of 10)

These procedures assume the cover on the manual call point has been removed and any broken glass has been cleared.

- a. Feed the glass upward to push the cams down and fit it under the slider, locate bottom of glass into recess.
- b. Hold the bottom of glass in position and rotate the thumbwheel quadrant to raise the top of the glass.
- c. Fit the call point cover by hooking it into the top of the unit, making sure that the glass is properly seated (held down) tighten the cover fixing screw.
- d. Test that the manual call point functions correctly.

Operating instructions

Battery replacement

It is recommended where batteries are installed they must be replaced at 4 Yearly intervals from the date the system is first commissioned.



Any servicing work on the system must be carried out by a suitably trained person, such as an engineer from the servicing organisation.

Repair function



This operation is not applicable for a Compact Network Node.



Any wiring fault on the system must be rectified by an engineer from the servicing organisation, for contact details see the log book. A wiring fault will require correction to the wiring before running a [Repair] command at the main panel.

The repair function is accessible using customer (level 2) password, under normal circumstances it is unnecessary to use this function.

- Press the **MENU ON/OFF** key.
- Press the F1 button to select **[Test/Engl]**.
- Press the F4 button to select **[UserCode]**. Notice a flashing cursor and a message on the display 'Enter access code'. Use the keyboard to input your password and then press the **Enter** button.
- Press the F1 button to select **[Loop]** and F1 button to select **[Repair]** notice 'Loop' followed by a flashing cursor on the display. Use the keypad to input a loop number 1 or 2 and then the F2 button to select **[Enter]**.

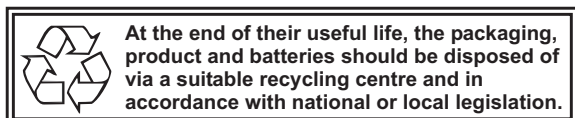
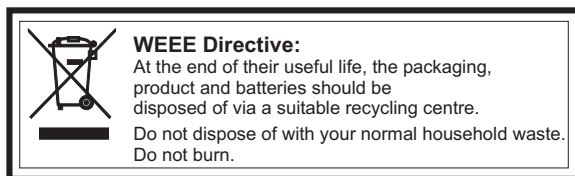

0832
Gent by Honeywell
Hamilton Industrial Park, 140 Waterside Road, Leicester LE5 1TN, UK
0832-CPD-1260
Vigilon Compact

EN54-2: 1997, A1:2006
Control and Indicating equipment for fire detection and fire alarm systems in buildings.

7.8 Output to fire alarm devices
7.11 Delays to action outputs
8.3 Fault signals from point
9.5 Disabling of each addressable point
10 Test condition

EN54-4: 1997, A1:2002, A2:2006
Power supply equipment for fire detection and fire alarm systems in buildings.

Other technical data: see documents in project file 7032, held by the manufacturer.

Gent by Honeywell reserves the right to revise this publication from time to time and make changes to the content hereof without obligation to notify any person of such revisions of changes.

GENT
by Honeywell

Hamilton Industrial Park, Waterside Road, Leicester LE5 1TN
Telephone: +44 (0)116 246 2000

Website: www.gent.co.uk
Fax (UK): +44 (0)116 246 2300