

Machinery Directive Passenger Lift



- **Complies with Machinery Directive 2006/42/EC**
- **Up to 6 stops**
- **Side Opening or Swing hinge landing doors**
- **Minimal Pit & Headroom Required**
- **Wide Range of Car Sizes**
- **250-400kg Capacity**
- **Wide Range of Finishes**
- **No separate machine room required**

Niche..... Our passion and purpose is the supply of specialist lifts that enable wheelchair users and the less able gain access to upper floors and up stairways, plus service, trolley and goods lifts for transporting goods in the range 5kgs to 2000kgs

We supply, install and service Niche products that meet your specific needs.

NICHE LIFTS—Focus and expertise working uniquely for YOU on Niche Products.

Machinery Directive Passenger Lift

Model Type	Machinery Directive Passenger Lift
Rated Load	250kg, 300kg, 350kg & 400kg
Rated Speed	0.15 m/s
Drive Type	Hydraulic 2:1 side acting
Number of Stops	6 stops maximum
Power Supply	230v, 1 phase, 50hz, RCD protected
Travel	9 metres maximum
Headroom	2600mm
Pit	175mm
Car & Shaft Sizes	See Tables enclosed
Car Finishes	Skin plate wall panels. Satin stainless steel car operating panel. Marmoleum floor covering. Painted ceiling.
Emergency Alarm	Hands free autodialer. Requires telephone line by others.
Controls & Signals	Tactile buttons to the car and landing. Door open and alarm buttons in the car. Position indicator display in the car and on the landings.
Configuration	Single entry, through car or adjacent.
Door Type	Two panel side opening doors on the car and landings. Bus stop type car doors with swing hinge landing doors available.
Door Protection	Full height light curtain with side opening car doors.
Control Cabinet	External to the lift within 5 metres of the lift shaft. 1800 high x 700 wide x 400 deep in steel with a powder coated finish.
Emergency Operation	Automatic return to the bottom floor in the event of power failure. Hand lowering valve.
Options	Plastic laminate or stainless steel wall panels. Stainless steel ceiling. Voice synthesiser. Lift shaft enclosure with powder coated steel panels or semi glazed.
Documentation	Owners guide issued on completion.
Training	Operation demonstrated on completion.
Compliance	Supply of machinery (safety) regulations 2008 EC Machinery Directive 2006/42/EC

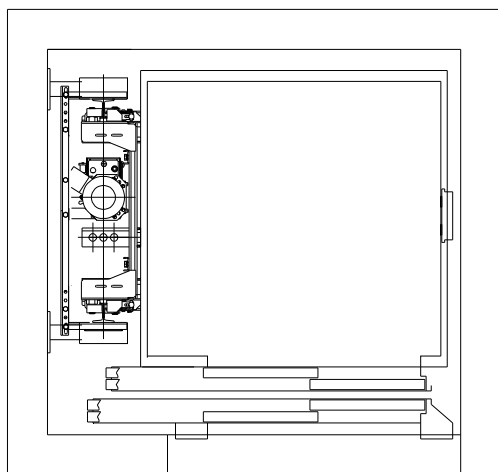
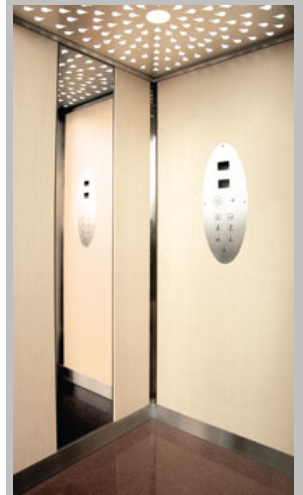

Standard Layouts

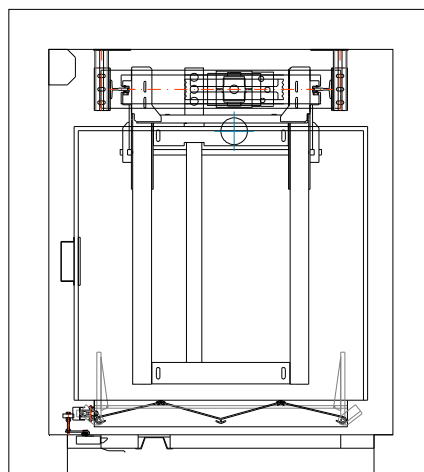

Bespoke Layouts

NicheTM
Lifts

Niche Lifts Ltd
Office 15-16
12 Farwig Lane
Bromley, Kent
BR1 3RB

Tel 020 8295 2852
Fax 020 8466 1695

www.nichelifts.com



Visit us at www.nichelifts.com

The information contained in this brochure was correct at the time of printing, due to continued development of our products we reserve the right to change the specification without prior notice

Machinery Directive Passenger Lift Layout Information

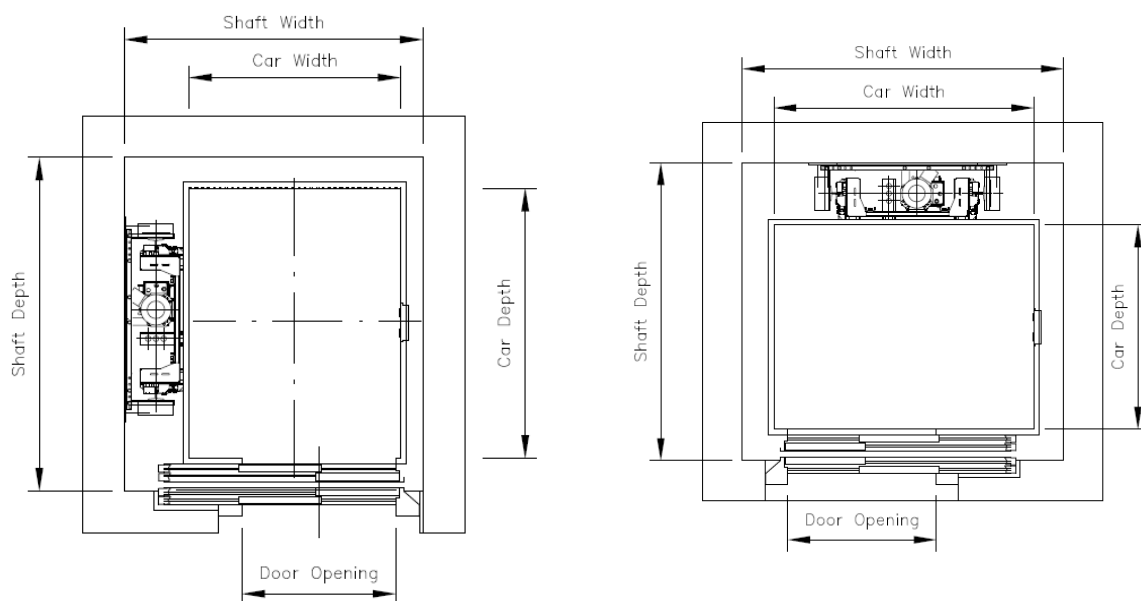

Automatic Car & Landing Doors Front Single Car Entrance, Ram to the rear

Accessibility	Capacity	Persons	Car Depth	Car Width	Shaft Depth	Shaft Width	Door Opening	
	250kg	3	750	1000	1250	1320	650	
			800				700	
			850				750	
	300kg	4	800	1000	1250	1370	700	
				1200				1400
				1250				1450
	350kg	4	900	1300	1500	1470	800	
				1200				1400
				1400				1600
	400kg	5	1000	1200	1400	1570	900	
				1300				1550
				1400				1600
450kg	5	1100	1000	1400	1670	800		
			1300				1550	
			1400				1600	

Automatic Car & Landing Doors Through Car, Ram to the side

Accessibility	Capacity	Persons	Car Width	Car Depth	Shaft Width	Shaft Depth	Door Opening	
	250kg	3	750	1000	1250	1320	650	
			800				700	
			850				750	
	300kg	4	800	1000	1250	1370	700	
				1200				1400
				1250				1450
	350kg	4	900	1300	1500	1470	800	
				1200				1400
				1400				1600
	400kg	5	1000	1200	1400	1570	900	
				1300				1550
				1400				1600
450kg	5	1100	1000	1400	1670	800		
			1300				1550	
			1400				1600	

NicheTM
Lifts

Niche Lifts Ltd
Office 15-16
12 Farwig Lane
Bromley, Kent
BR1 3RB

Tel 020 8295 2852
Fax 020 8466 1695

www.nichelifts.com





Visit us at www.nichelifts.com

The information contained in this brochure was correct at the time of printing, due to continued development of our products we reserve the right to change the specification without prior notice

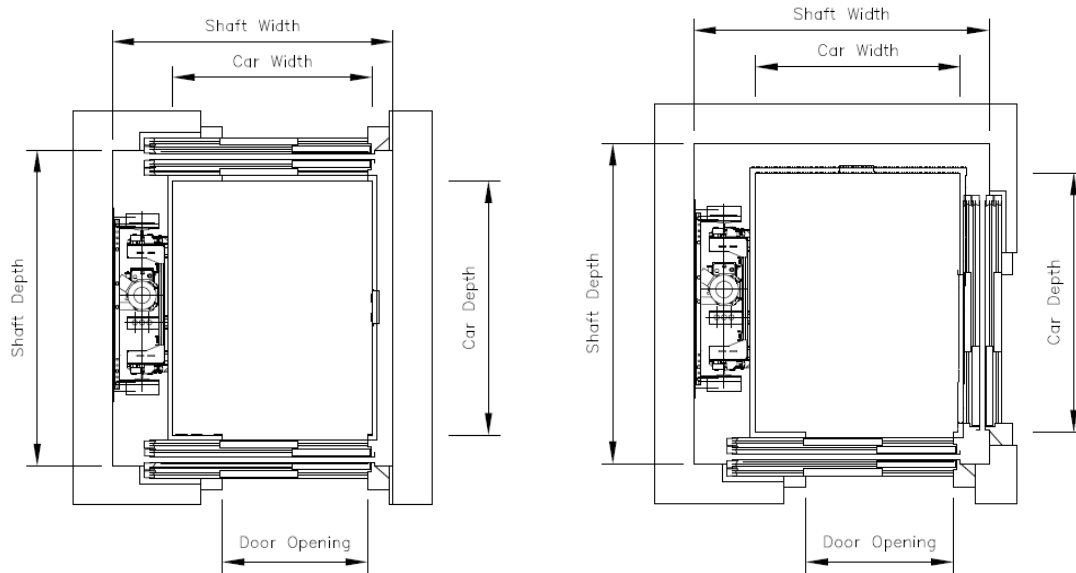
Machinery Directive Passenger Lift Layout Information



Automatic Car & Landing Doors Through Car, Ram to the side							
Accessibil-ity	Capacity	Persons	Car Width	Car Depth	Shaft Width	Shaft Depth	Door Opening
	250kg	3	750	1000	1250	1320	650
			800			1370	700
			850			1420	750
	300kg	4	800	1000	1250	1370	750
				1200	1400	1370	
				1250	1450	1370	
	350kg	4	900	1200	1400	1470	800
				1400	1600	1470	
	400kg	5	1000	1200	1400	1570	900
1100				1300	1550		
1400				1600	1670		
450kg	5	1000	1200	1400	1570	800	
			1100	1300	1550		
			1400	1600	1670		

Automatic Car & Landing Doors, Adjacent Arrangement								
Accessibil-ity	Capacity	Persons	Car Width	Car Depth	Shaft Width	Shaft Depth	Door Opening	
	250kg	3	750	1000	1400	1500	700	
			800		1400	1500		
			850		1500	1570		
	300kg	4	800	1000	1400	1500	700	
				1200	1480	1550		750
				1250		1600		750
	350kg	4	900	1200	1560	1650	800	
				1400		1750		
	400kg	5	1000	1200	1650	1650	800	
1100				1700	1800			
1400								
450kg	5	1000	1200	1650	1650	900		
			1100	1700	1800			
			1400					

NicheTM
Lifts

Niche Lifts Ltd
Office 15-16
12 Farwig Lane
Bromley, Kent
BR1 3RB

Tel 020 8295 2852
Fax 020 8466 1695

www.nichelifts.com



Visit us at www.nichelifts.com

The information contained in this brochure was correct at the time of printing, due to continued development of our products we reserve the right to change the specification without prior notice

Machinery Directive Passenger Lift Layout Information

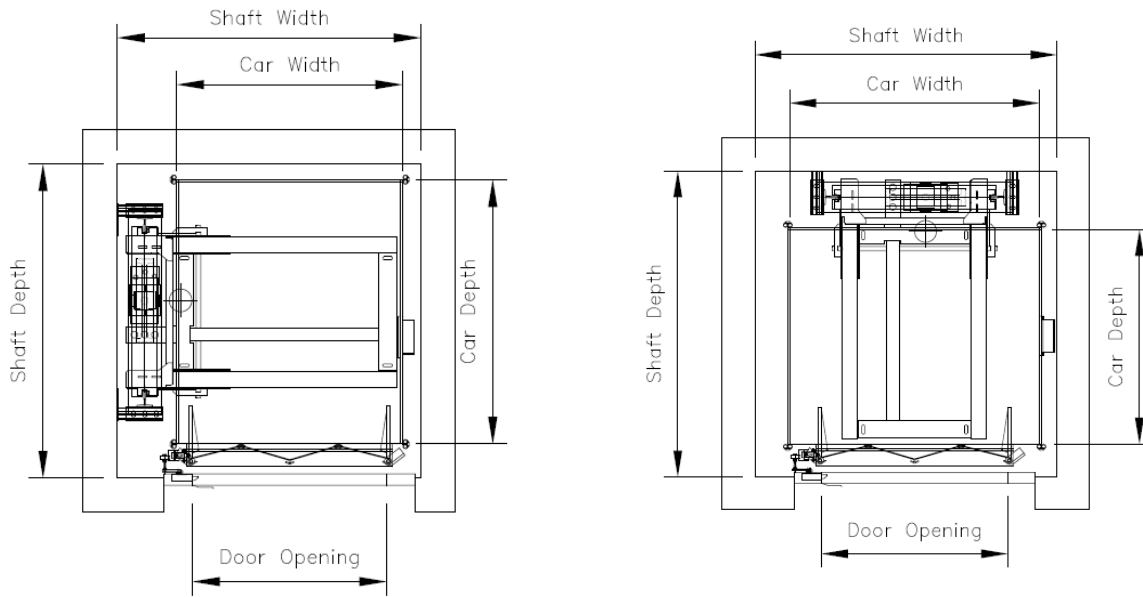

Cars with Bus Type Doors, Swing Hinge Landing Doors, Single Car Entrance, Ram to the side

Accessibility	Capacity	Persons	Car Width	Car Depth	Shaft Width	Shaft Depth	Door Opening
	250kg	3	750	1000	1140	1210	650
			800		1190		700
			850		1240		750
	300kg	4	800	1000	1190	1210	700
				1200		1410	
				1250		1460	
	350kg	4	900	1200	1320	1410	800
				1400		1610	
	400kg	5	1000	1200	1420	1410	900
1100				1510			
1400				1610			
450kg	5	1000	1200	1420	1410	900	
			1100		1510		
			1300	1520	1610		
			1400	1520	1610		

Cars with Bus Type Doors, Swing Hinge Landing Doors, Single Car Entrance, Ram to the rear

Accessibility	Capacity	Persons	Car Depth	Car Width	Shaft Depth	Shaft Width	Door Opening
	250kg	3	750	1000	930	1420	650
			800		980		700
			850		1030		750
	300kg	4	800	1000	980	1420	700
				1200		1620	
				1250		1670	
	350kg	4	900	1200	1080	1650	800
				1400		1850	
	400kg	5	1000	1200	1180	1650	900
1100				1750			
1400				1850			
450kg	5	1000	1200	1180	1650	900	
			1100		1750		
			1300	1280	1850		
			1400	1280	1850		

NicheTM
Lifts

Niche Lifts Ltd
Office 15-16
12 Farwig Lane
Bromley, Kent
BR1 3RB

Tel 020 8295 2852
Fax 020 8466 1695

www.nichelifts.com



Visit us at www.nichelifts.com

The information contained in this brochure was correct at the time of printing, due to continued development of our products we reserve the right to change the specification without prior notice

Machinery Directive Passenger Lift Layout Information

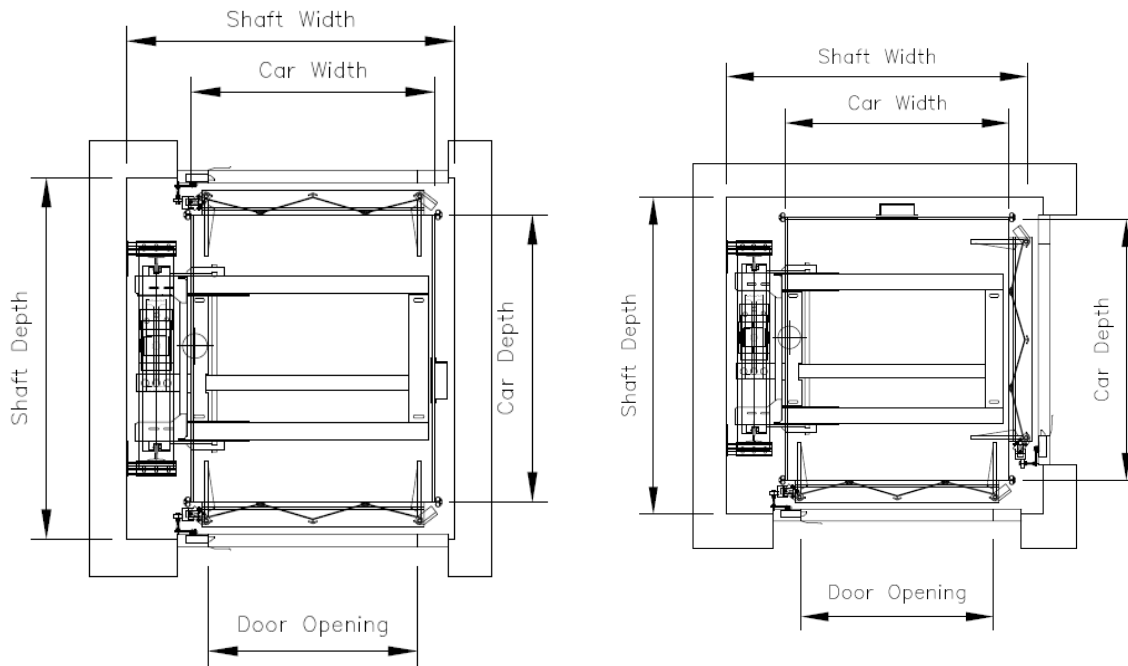

Cars with Bus Type Doors, Swing Hinge Landing Doors, Through Car, Ram to the side

Accessibility	Capacity	Persons	Car Width	Car Depth	Shaft Width	Shaft Depth	Door Opening
	250kg	3	750	1000	1140	1260	650
			800		1190		700
			850		1240		750
	300kg	4	800	1000	1190	1260	700
				1200		1460	
				1250		1510	
	350kg	4	900	1200	1320	1460	800
				1400		1660	
	400kg	5	1000	1200	1420	1460	900
				1100		1560	
				1400		1660	
	450kg	5	1000	1200	1420	1460	900
1100				1560			
1400				1660			

Cars with Bus Type Doors, Swing Hinge Landing Doors, Adjacent Arrangement

Accessibility	Capacity	Persons	Car Width	Car Depth	Shaft Width	Shaft Depth	Door Opening	
	250kg	3	750	1000	1170	1230	650/800	
			800		1220	1230	700/800	
			850		1270	1230	750/800	
	300kg	4	800	1000	1220	1230	1230	700/800
				1200		1430	700/900	
				1250		1480	700/900	
	350kg	4	900	1300	1350	1530	700/900	
				1400		1630	800/900	
	400kg	5	1000	1200	1450	1430	1430	900
1100				1550		1530		
1400				1630				
450kg	5	1000	1200	1450	1430	1430	900	
			1100		1550			1530
			1400		1630			

NicheTM
Lifts

Niche Lifts Ltd
Office 15-16
12 Farwig Lane
Bromley, Kent
BR1 3RB

Tel 020 8295 2852
Fax 020 8466 1695

www.nichelifts.com



Visit us at www.nichelifts.com

The information contained in this brochure was correct at the time of printing, due to continued development of our products we reserve the right to change the specification without prior notice

Machinery Directive Passenger Lift Car Models



Interior Model **Earth**

Walls

- Formica panels
- Satin stainless steel corners
- 1/2 Full height mirror to rear wall
- Satin stainless steel skirting
- Full height stainless steel car station

Ceiling

- Fluorescent lighting
- Satin stainless steel perforated plate soffit
- Acrylic resin diffuser

Flooring

- Granite effect flooring

Entrance

- Satin stainless steel

Formica



Iris Cream



Caramel



Sun



Wasabi



Tropical Blue



Tropical Blue



Interior Model **Air**

Walls

- Satin stainless steel
- 1/2 height rear mirror
- Satin stainless steel skirting
- Full height satin stainless steel car station

Ceiling

- Fluorescent lighting
- Satin stainless steel with Acrylic resin diffuser

Flooring

- Rubber flooring

Entrance

- Satin stainless steel

NicheTM
Lifts

Niche Lifts Ltd
Office 15-16
12 Farwig Lane
Bromley, Kent
BR1 3RB

Tel 020 8295 2852
Fax 020 8466 1695

www.nichelifts.com



Visit us at www.nichelifts.com

The information contained in this brochure was correct at the time of printing, due to continued development of our products we

Machinery Directive Passenger Lift Car Models



Interior Model *Spring*

Walls

- Melamine panels
- Satin stainless steel corners
- 1/2 height mirror to rear wall
- Satin stainless steel skirting
- Full height satin stainless steel car station

Ceiling

- LED Downlighters
- Painted plate ceiling

Flooring

- Rubber flooring

Entrance

- Satin stainless steel

Melamine



Orange



Blue



Maple

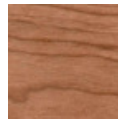

Orange

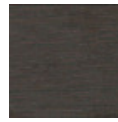

Weng

Interior Model *Ocean*

Walls

- Melamine 2042 colour panels
- 1/3 full height rear mirror
- Satin stainless steel skirting
- Full height car station

Ceiling

- Fluorescent lighting
- Stainless steel

Flooring

- Rubber flooring

Entrance

- Satin stainless steel

Melamine



Orange



Blue

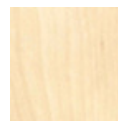

Maple

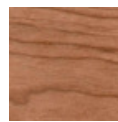

Orange

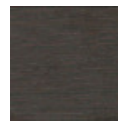

Weng



NicheTM Lifts

Niche Lifts Ltd
Office 15-16
12 Farwig Lane
Bromley, Kent
BR1 3RB

Tel 020 8295 2852
Fax 020 8466 1695

www.nichelifts.com



Visit us at www.nichelifts.com

The information contained in this brochure was correct at the time of printing, due to continued development of our products we