



Product Catalogue

Issue 46

2017/2018



Contents

2-8.	EXOR Brand	41-52.	eTOP500 Series
9-14.	JMobile Suite	53-58.	Food & Beverage
15-22.	eX700 Series	59-64.	Handhelds
23-26.	eXware Series	65-71.	eX700 Field Series
27-32.	eSMART Series	72.	IPC Products for PC-based automation
33-40.	eTOP500 Glass		

A large, stylized 'EXOR' logo in white, set against a blue background that appears to be a close-up of a device's casing.



EXOR Corporate

EXOR is a Global Designer and Manufacturer of HMI & HMI with Control solutions focused on enhancing the User Experience using sophisticated Industry 4.0 ready technology.

Founded in 1971 in Verona, Italy the company has steadily grown to over 150 employees in Italy, Germany, United States of America and India. An extensive network of trusted distributors covers an additional 40 countries worldwide.

Each EXOR branch employs local, skilled professionals to offer guidance, consultation and technical support in the time zone of the client. The main design of projects and their manufacture however, takes place in the headquarters in Italy. EXOR can therefore maintain strict control over the quality of service as well as product.

Software development has always been an important part of the offering from EXOR and being a company that controls hardware, software and firmware, our clients are given an unparalleled partnership in realizing their market objectives.

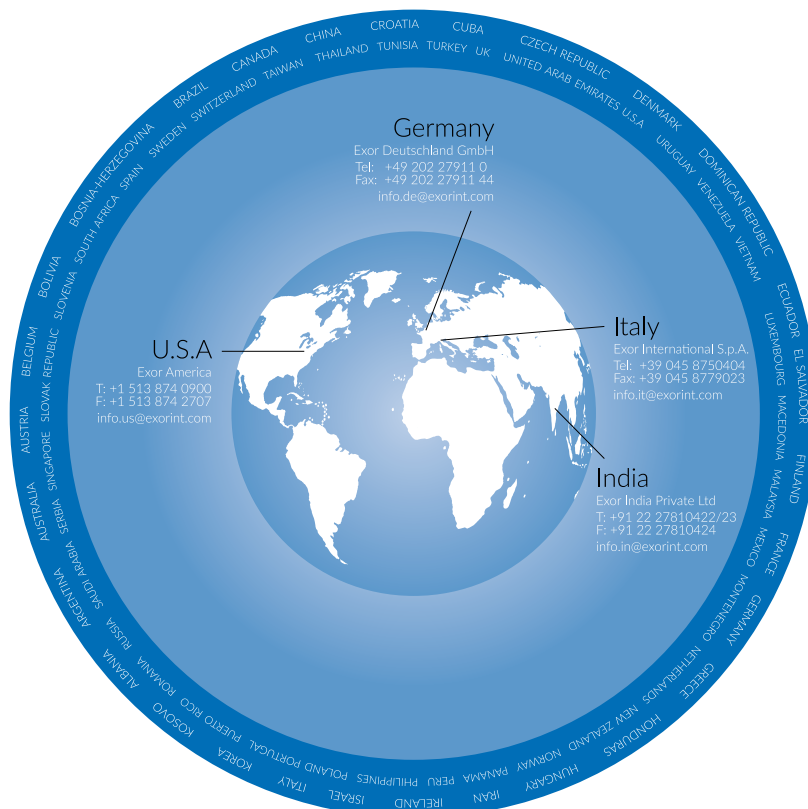

EXOR Research and Development

EXOR controls all the macro areas of product design and development.

Being the only Industrial Automation company that engineers to the level of System on Module, the research and development department of EXOR bring nearly 50 years of practical experience of resolving barriers to our clients' requirements by covering the following areas:

1. SOM development done to the micro and nano level. PCB design and FPGA use in product industrialization
2. BSP and HMI (soft PLC) software development, including firmware, soft PLC, multiple protocol communications
3. Mechanical design of plastic and die casting molding with extensive certification expertise.

This wealth of knowledge and the extensive pre zero series testing allow EXOR to confidently offer a no argument 5 year guarantee as standard (some models excluded) even as EXOR dramatically reduces the time to market for any client on the development of a new product or ecosystem.

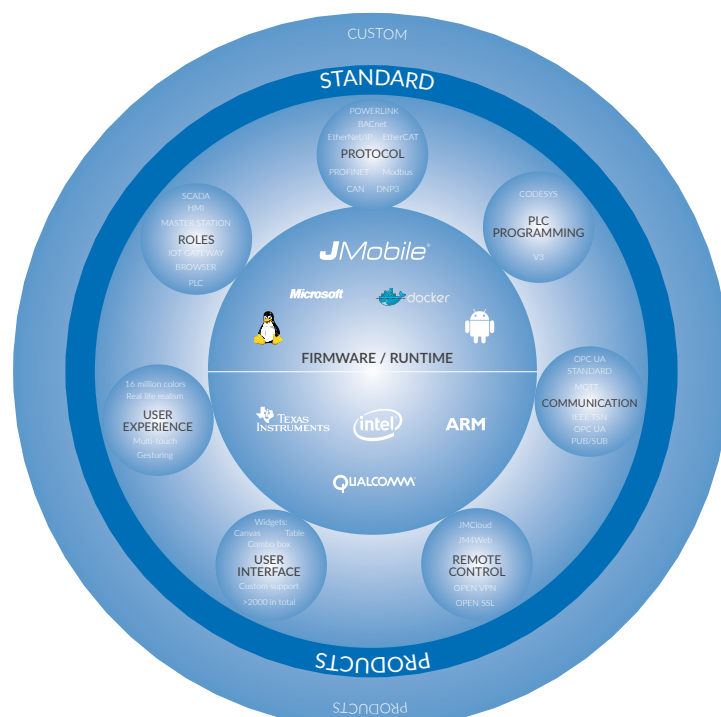



EXOR Production

With an output capacity of 100,000 SOM pieces and 60,000 final visualization products per year, EXOR maintains a strong internal competence in production.

EXOR is **QMS certified** with ISO9001:2015, **IECEX (QAR) certified** with IEC 80079-34:2013 and what we are extremely proud of, **Environmental certified** with ISO14001:2015.

This obvious high level of production skill allows several important advantages to our clients:

1. High levels of flexibility in production so as to help our clients manage their inventory position as efficiently as possible
2. Flexibility to peaks in demand, so that our clients can satisfy their final user in the most effective manner possible
3. Tremendously efficient Technical Support both pre and post sales as the circle of competence (R&D + Production + Quality Control + Technical support), each giving input and feedback to the other departments means our client will have their problem resolved quickly.

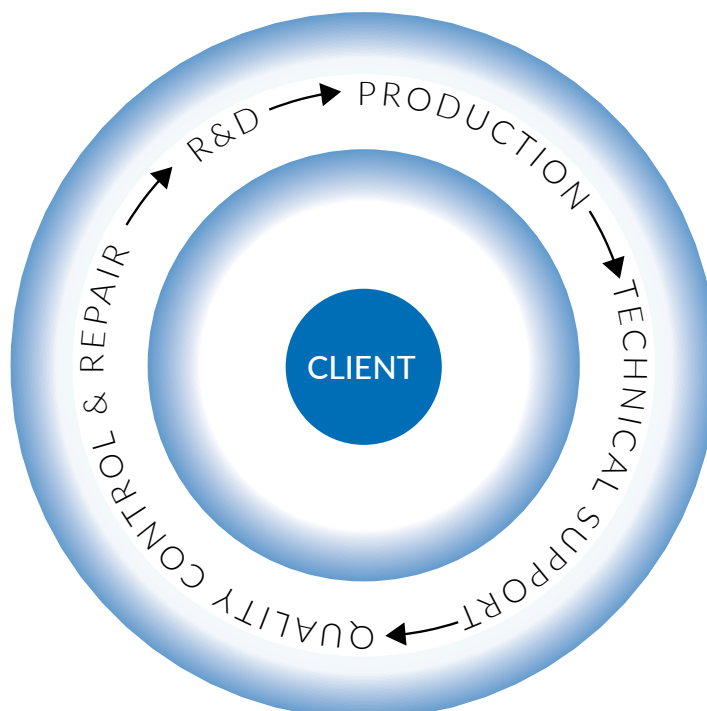



EXOR Support

The circle of competence with EXOR (R&D + Production + Quality Control + Technical support), being so complete means that EXOR can globally offer an extensive Technical Support with the following features:

- Free of charge for both phone and email support
- Support on developing JMobile applications
- Support on discontinued versions

Our basic Service Level Agreement is for a first reply by email within one hour of the problem being presented and technical support is closed only during local national holidays. This extensive and global coverage for technical support is so appreciated by our clients as survey after survey continue to demonstrate:

- **91%** of customer report EXOR technical support quality is **higher or much higher** than other technical support services
- **94%** of customer would **likely or very likely recommend EXOR** for his technical support
- **98%** of customer is **satisfied or very satisfied** for time for resolution

No one ever says that their technical support teams are not effective and so it is only after purchasing that the client will truly see the level of service offered. In the case of EXOR, our clients as witnessed in the above surveys, are provided with an extremely high level of competence and speed of execution. In the real world there will always be problems, the key is how important resolving these problems of our clients are to EXOR. The above survey results speak for themselves.

Italy: support.it@exorint.com

USA: support.us@exorint.com

India: support.in@exorint.com

Germany: support.de@exorint.com

Rest of the World: support.it@exorint.com



EXOS







JMobile Suite

The X Platform Software

JMobile V2.6

Highlights

- High User Interface Experience
- Create IIoT ecosystems with reduced risk
- From Shop Floor to Cloud / Big Data
- Deterministic Communication via TSN*
- Real Interoperability
- Great HTML5 interface with JM4web
- Efficient scripting with JavaScript
- Excluding variants, more than 50 communication protocols readily available for all platforms with gateway function
- Browser widget
- Integrated PLC runtime as an option for compact control solutions. Include full support of networked I/O
- Software and documentation available in 4 languages: EN, DE, FR, ZH
- Multi platform runtime: Linux ,Windows, Windows CE, HTML5



Overview

EXOR began developing the JMobile software in 2006 in close cooperation with a group of major clients: EXOR has invested over 300 of man-years in development. This trusting collaboration with the market has continued throughout the subsequent years and as a consequence has led to a unique software package, responding in a secure and stable manner to real needs.

The three principles that have guided and will continue to guide this development are:

- Remain open to the major fieldbus / protocols of communication
- Use open and universally recognized market technological standards such as HTML5, SVG, XML
- Maintain ease of use and extremely secure all integrations of market leading 3rd party software

These three principles working together leads EXOR and our customers to the best of all situations where the secure, solid JMobile backbone of highly critical software is able to contain and implement in use the software that is needed.

JMobile with a fully integrated CODESYS PLC has grown to permit communication to all I/O, Sensors, Motion devices via the major protocols of PROFINET, EtherCAT, POWERLINK, EtherNet/IP, Modbus amongst others. Transmitted using OPC UA standard and soon pub/sub* via various communication networks including TSN* JMobile covers the Connectivity, Device management, Process management and Data Visualization components of any platform.

Overview



JMobile also covers inside of a smart scada or as a simple IoT gateway, sending all data to higher Enterprise levels and external interfaces via the highly robust and secure OPC UA pub/sub or where deemed suitable a MQTT* broker. JMobile client-server architecture is based on current HTML5 web technologies with the QT engine and Scalable Vector Graphics. This provides users with advanced control and remote supervision from any browser, any device (smartphone, tablet, or computer).

This seamless communication which is already envied as a real technical achievement does not convey the completeness of JMobile. What began as a close contact with customers has remained so deeply engrained into the development process that the beautiful user experience is a defining attribute.

Through a rich set of symbols, widgets and advanced functions (e-mail, RSS, PDF Reporting, Scheduler, HTML5 Browser, Gesturing), incredible graphic images, Canvas, the main design element in HTML5 in association with Javascript, table design and layout for even the most extreme of data visualization needs, BACnet, CANopen and Network I/O stacks available for integrated PLC via CODESYS v3, PING for easier network diagnostics, DNP3 Outstation for all smartgrid applications, all the way down to Indexed Tags and a full FTP clientit is all intuitively easy to use.

New Features

- Multi touch and Gesturing
- Supports OPC UA Server and Client
- Enhanced realism for graphic images
- Advanced support for custom widgets
- Canvas widget: fully customized graphic objects
- Table widget: extreme table design and layout improving quick and accurate data acceptance
- Supports OPC UA Alarms, Historical Alarms and Trends
- Alarm management widgets: easier handling of options in Active alarms
- Communication via BACnet, DNP3 Outstation
- Protocols for Automation Direct, Emerson, Schneider, Delta
- FTP Client with the new actions FTPGet FTTPut
- Fastboot under 15 secs depending upon project complexity

*Road map for 2017

Ordering Information

Model	Part Number	Description
JM-Studio	Please contact our sales department	JMobile Suite programming software for project engineering.
JMobile PC Runtime	+SWLJ00R000001	JMobile PC Runtime for WIN32 Platform

JMobile 4 Web



Key features

- Pure Web Technology
- Created and Developed since 2010
- Based on HTML5/JS
- Ready for responsive design
- 100% HTML5 web HMI Interface
- Realtime Data Update (up to 10x per second)
- Multitouch Support
- Ready for iOS and Android
- Ready for most common Browsers for PC and Smart Devices
- Scalable SVG Vector Graphic
- Ease of Use. No HTML competence required
- Full JMobile library of over 2000 Widgets
- Available as Component for 3rd party platforms
- Trends Support
- Recipes
- Multilanguage
- Javascript

Overview

JM4web is the seamless connection between Industrial control applications and ubiquitous mobile devices such as smart phones and tablets. Developed some six years ago and subsequently continuously updated, it now provides the most comprehensive Pure Web Technology available, designed and maintained by EXOR, a company with 45 years experience in control applications.

With HTML5 and Javascript technology embedded in JMobile, all that is needed to remotely monitor and control applications is a web browser with HTML5 support: Firefox, Chrome, Safari and Microsoft EDGE

No "apps" needed when operating from mobile devices, hence reducing the risk of compatibility across various operating systems.

With JM4web you can have instant Web access to JMobile applications via the integrated Web server included in all JMobile runtime systems.

JM4web allows for creating the exact responsive user experience for the target mobile device. The Web server will detect the resolution of the connected client device and serve the appropriate pages.

JM4web is the ideal complement to the powerful remote connectivity and visualization tools already available in JMobile.

JMcloud

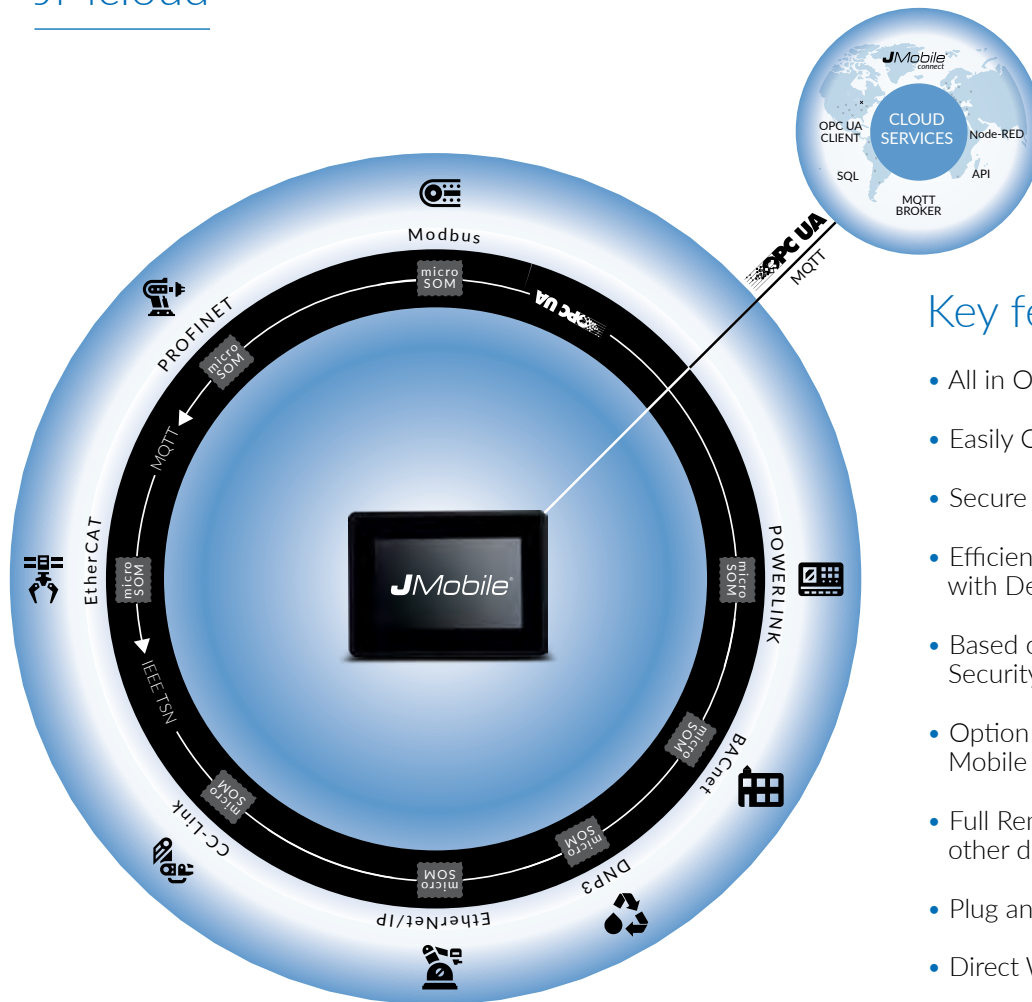

Key features

- All in One Solution
- Easily Connects to applications
- Secure VPN Tunnel
- Efficient server-based Connection with Devices
- Based on openVPN and OpenSSL for Security and Transparency
- Option for Web Access from Mobile Devices
- Full Remote Control of PLC, HMI and other devices
- Plug and Play solution
- Direct Web Access
- OPC UA, MQTT* support

Overview

JMcloud is a Secure Open VPN and SSL based solution that allows to remotely manage Industrial installation in an easy and yet extremely safe manner, avoiding expensive interventions on site.

Simply by entering the credentials of the JMcloud portal, you have direct access to the system and you will be able to perform maintenance and upgrade, using the JMobile platform.

After activating the secure VPN communication to the panel you can reach all the devices connected to the network, such as PLCs, inverters and I/O and you can manage and configure them via proprietary software.

JMobile client and JM4Web, integral parts of the X Platform, allow you to view the user interface through both desktop and mobile devices (smartphones and tablets), providing a full monitoring and preventive maintenance service.

JMcloud components:

- 1) JMcloud Connect is an application used to connect to the cloud service and view and connect to all devices enabled and belonging to that domain. This allows direct monitoring and remote control of all devices. The configuration and maintenance of devices are supported.
- 2) JMcloud Servers are the heart of the whole infrastructure. They store all the configuration data, the access policies, and keep track of the connections to the endpoints (HMI and PLC).
- 3) JMcloud Service is used by HMI for Cloud connection
 - a) For Series eTOP500/600, it comes as the HMI Cloud Enabler that uses the single Ethernet port for PLC and for Cloud connection. If however network separation is required there is the PLCM07 Hardware which uses two separate Ethernet ports, LAN for HMI/PLC and WAN for Cloud connection.
 - b) For the eSMART family (except eSMART107), it comes as a system service and uses the single Ethernet port for PLC and Cloud connection. If however network separation is required a router such as the eXware will be needed.
 - c) For the eX700 series, eXware and eSMART107, it comes as a system service and the possibility of network separation are already in built.
- 4) PLCM09 is a wireless modem plug in available for the eX700 and eXware. With 4 LED indicators on module and network status, a microSIM slot and powered via the plug in connection the PLCM09 adds the ability to communicate with all machines and systems worldwide.

Ordering Information

Model	Part Number	Description
HMI Cloud Enabler	+SWLH00R000000	Software solution for Series 500/600 HMI
PLCM07	+PLCM07U0P1	Plug-in Secure Cloud Connector (Compatible with eX700, eTOP500, eTOP500Glass and Food and Beverage Series)



eX700 Series

The Revolutionary IIoT Controller

eX700 Series Tech-Notes

Key Features



- Created Within the X Platform
- Industry 4.0 Product Concept
- HW and FW Optimised for Extremely Fast Operation
- System and Project Rapid Boot-Up
- OS Linux RT
- JMobile - the software that powers the X Platform
- CODESYS V3 with Ethernet I/O Stacks
- Multitouch and Gesturing
- Brilliant 2,100,000 pixel Display
- Wide Angle Visibility
- Beautiful 16,000,000 Colors
- Resistant to Scratches, UV and Chemicals
- Total Glass Design
- Network Separation possible via up to 3 Ethernet Networks with different IP addresses
- Plug in Modules for System Expansion
- IECEx*, ATEX*, DNV-GL, cULus, cULus Haz. Loc.*, RCM*

Highlights

A beautiful product, created within the X Platform and hence with an unsurpassed ability to offer access and scalability into Industry 4.0. The tremendous technical flexibility is backed by a company with 45 years in the industry and still with a market price at previous models.

The eX700 Series represents a ground breaking product to come to market:

[The Revolutionary IIoT Controller.](#)

The product's concept permits a prudent investment into the implementation of IIoT and hence Industry 4.0 compatibility.

As such it provides a true all-in-one solution covering many functions such as:

- As a powerful **Browser** with industry standard Web engine powering state of the art Chromium browser
- As a powerful **HMI** using JMobile inside with multi touch operation in a brilliant high resolution display
- As a **Gateway** with up to 3 Ethernet networks, OPC UA pub/sub* Server and Client, future TSN connectivity* and multiple protocols
- As a **PLC** with the CODESYS V3 can function as Master through major protocols

Technical Data



System Resources	
Display - Colors	5" TFT 16:9 LED - 64K
Resolution	800x480, WVGA
Brightness	300 Cd/m ² typ.
Dimming	to 0%
Touchscreen	True Glass Projected Capacitive, Multitouch
CPU	ARM Cortex-A8 - 1 GHz
Operating System	Linux RT
Flash	4 GB
RAM	512 MB
Real Time Clock, RTC Back-up, Buzzer	Yes
Interface	
Ethernet port	2 (port 0 - 10/100, port 1 - 10/100)
USB port	1 (Host V2.0, max. 500 mA)
Serial port	1 (RS-232, RS-485, RS-422, software configurable) Max 2 serial ports using plug-in modules.
SD card	Yes
Expansion	1 slot for plug in modules
Ratings	
Power supply	24 Vdc (10 to 32 Vdc)
Current Consumption	0.6 A at 24 Vdc (max.)
Input Protection	Electronic
Battery	Rechargeable Lithium battery, not user-replaceable
Environment Conditions	
Operating Temp	-20° to +60 °C (vertical installation) Plug-in modules and USB devices may limit max temperature to +50 °C
Storage Temp	-20°C to +70°C
Operating / Storage Humidity	5-85% RH, non condensing
Protection Class	IP66 (front), IP20 (rear)
Dimensions and Weights	
Faceplate LxH	147x107 mm (5.78x4.21")
Cutout AxB	136x96 mm (5.35x3.78")
Depth D+T	52+8 mm (2.40+0.31")
Weight	1.3 Kg
Approvals	
CE	Emission EN 61000-6-4, Immunity EN 61000-6-2 for installation in industrial environments
UL	cULus: UL61010-1 / UL61010-2-201
DNV-GL	Yes

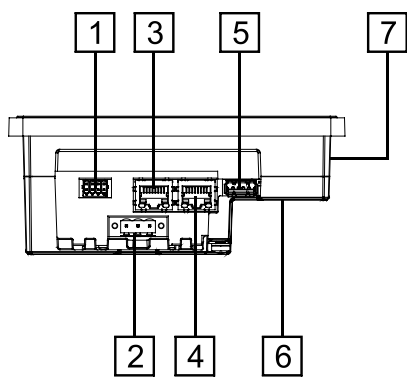

- 1 Serial port
- 2 Power supply
- 3 Ethernet port 1 (10/100 Mb)
- 4 Ethernet port 0 (10/100 Mb)
- 5 USB port 1
- 6 Expansion slots for plug-in modules
- 7 SD Card slot

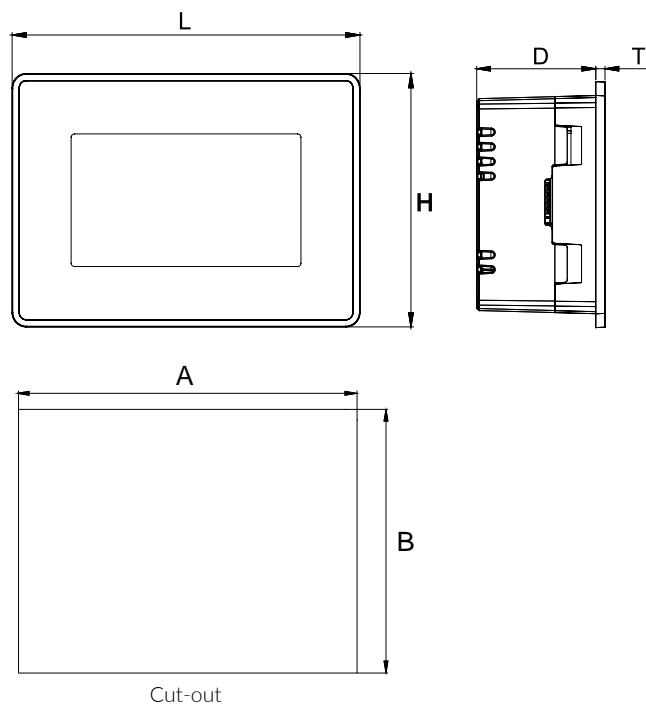

Ordering Information

Model	Part Number	Description
eX705	+EX705U5P1	5" widescreen TFT color with multitouch projected capacitive touchscreen. 2 Ethernet ports, 1 serial port, 1 USB port. JMobile runtime.

Technical Data



System Resources	
Display - Colors	7" TFT 16:9 LED - 16M
Resolution	800x480, WVGA
Brightness	500 Cd/m ² typ.
Dimming	to 0%
Touchscreen	True Glass Projected Capacitive, Multitouch
CPU	ARM Cortex-A9 dual core 800 MHz
Operating System	Linux RT
Flash	4 GB
RAM	1 GB
Real Time Clock, RTC Back-up, Buzzer	Yes
Interface	
Ethernet port	3 (port 0 - 10/100/1000, port 1 - 10/100, port 2 - 10/100)
USB port	2 (Host V2.0, max. 500 mA)
Serial port	1 (RS-232, RS-485, RS-422, software configurable) Max 3 serial ports using plug-in modules.
SD card	Yes
Expansion	2 slot for plug in modules
Ratings	
Power supply	24 Vdc (10 to 32 Vdc)
Current Consumption	0.7 A at 24 Vdc (max.)
Input Protection	Electronic
Battery	Rechargeable Lithium battery, not user-replaceable
Environment Conditions	
Operating Temp	-20° to +60 °C (vertical installation) Plug-in modules and USB devices may limit max temperature to +50 °C
Storage Temp	-20°C to +70°C
Operating / Storage Humidity	5-85% RH, non condensing
Protection Class	IP66 (front), IP20 (rear)
Dimensions and Weights	
Faceplate LxH	187x147 mm (7.36x5.79")
Cutout AxB	176x136 mm (6.93x5.35")
Depth D+T	47+8 mm (1.85+0.31")
Weight	1.5 Kg
Approvals	
CE	Emission EN 61000-6-4, Immunity EN 61000-6-2 for installation in industrial environments
UL	cULus: UL61010-1 / UL61010-2-201
DNV-GL	Yes

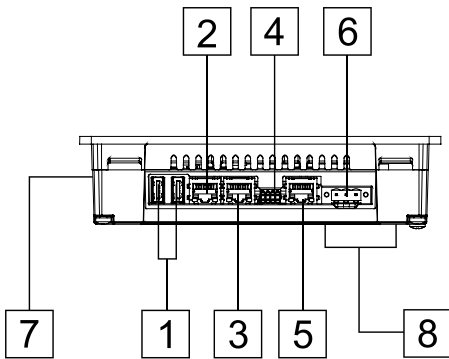

- 1 USB ports 1 and 2
- 2 Ethernet port 2 (10/100 Mb)
- 3 Ethernet port 1 (10/100 Mb)
- 4 Serial port
- 5 Ethernet port 0 (10/100/1000 Mb)
- 6 Power supply
- 7 SD Card slot
- 8 2 Expansion slots for plugin modules

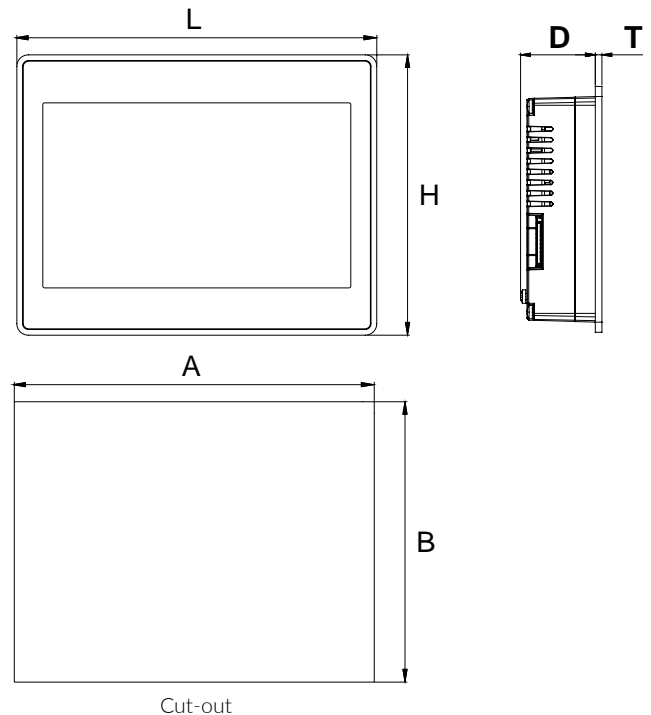

Ordering Information

Model	Part Number	Description
eX707	+EX707U5P1	7" widescreen TFT color with multitouch projected capacitive touchscreen. 3 Ethernet ports, 1 serial port, 2 USB ports. JMobile runtime.

Technical Data



System Resources	
Display - Colors	10.1" TFT 16:9 LED - 16M
Resolution	1280x800, WXGA
Brightness	500 Cd/m ² typ.
Dimming	to 0%
Touchscreen	True Glass Projected Capacitive, Multitouch
CPU	ARM Cortex-A9 dual core 800 MHz
Operating System	Linux RT
Flash	4 GB
RAM	1 GB
Real Time Clock, RTC Back-up, Buzzer	Yes
Interface	
Ethernet port	3 (port 0 - 10/100/1000, port 1 - 10/100, port 2 - 10/100)
USB port	2 (Host V2.0, max. 500 mA)
Serial port	1 (RS-232, RS-485, RS-422, software configurable) Max 3 serial ports using plug-in modules.
SD card	Yes
Expansion	2 slot for plug in modules
Ratings	
Power supply	24 Vdc (10 to 32 Vdc)
Current Consumption	1.0 A at 24 Vdc (max.)
Input Protection	Electronic
Battery	Rechargeable Lithium battery, not user-replaceable
Environment Conditions	
Operating Temp	-20° to +60 °C (vertical installation) Plug-in modules and USB devices may limit max temperature to +50 °C
Storage Temp	-20°C to +70°C
Operating / Storage Humidity	5-85% RH, non condensing
Protection Class	IP66 (front), IP20 (rear)
Dimensions and Weights	
Faceplate LxH	282x197 mm (11.10x7.80")
Cutout AxB	271x186 mm (10.67x7.32")
Depth D+T	56+8 mm (2.20+0.33")
Weight	2.5 Kg
Approvals	
CE	Emission EN 61000-6-4, Immunity EN 61000-6-2 for installation in industrial environments
UL	cULus: UL61010-1 / UL61010-2-201
DNV-GL	Yes

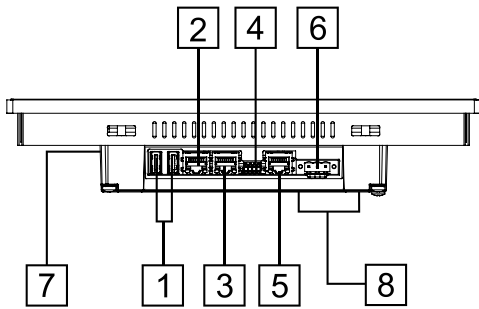

- 1 USB ports 1 and 2
- 2 Ethernet port 2 (10/100 Mb)
- 3 Ethernet port 1 (10/100 Mb)
- 4 Serial port
- 5 Ethernet port 0 (10/100/1000 Mb)
- 6 Power supply
- 7 SD Card slot
- 8 2 Expansion slots for plugin modules

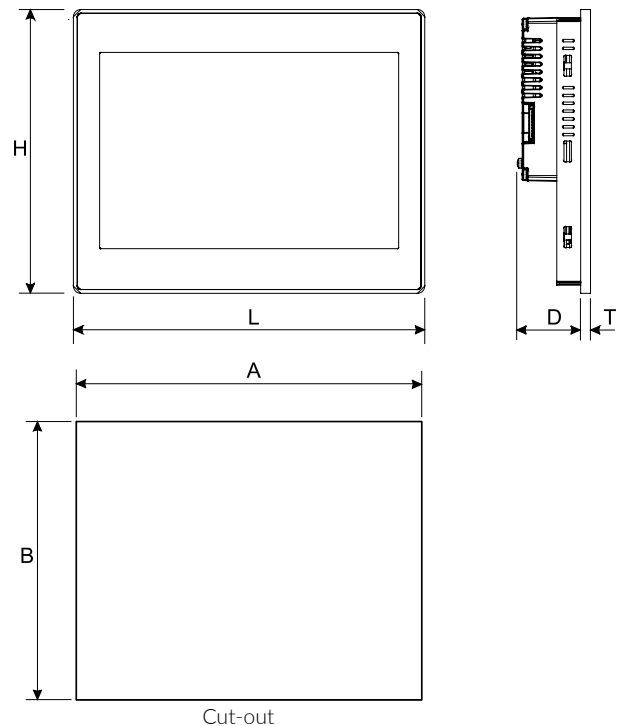

Ordering Information

Model	Part Number	Description
eX710	+EX710U5P1	10.1" widescreen TFT color with multitouch projected capacitive touchscreen. 3 Ethernet ports, 1 serial port, 2 USB ports. JMobile runtime.

Technical Data



System Resources	
Display - Colors	15,6" TFT LED - 16M
Resolution	1366x768, HD
Brightness	400 Cd/m ² typ.
Dimming	to 0%
Touchscreen	True Glass Projected Capacitive, Multitouch
CPU	ARM Cortex-A9 quad core 800 MHz
Operating System	Linux RT
Flash	8 GB
RAM	2 GB
Real Time Clock, RTC Back-up, Buzzer	Yes
Interface	
Ethernet port	3 (port 0 - 10/100/1000, port 1 - 10/100, port 2 - 10/100)
USB port	2 (Host V2.0, max. 500 mA)
Serial port	1 (RS-232, RS-485, RS-422, software configurable) Max 3 serial ports using plug-in modules.
SD card	Yes
Expansion	2 slot for plug in modules
Ratings	
Power supply	24 Vdc (10 to 32 Vdc)
Current Consumption	1.2 A at 24 Vdc (max.)
Input Protection	Electronic
Battery	Rechargeable Lithium battery, not user-replaceable
Environment Conditions	
Operating Temp	-20° to +60 °C (vertical installation) Plug-in modules and USB devices may limit max temperature to +50 °C
Storage Temp	-20°C to +70°C
Operating / Storage Humidity	5-85% RH, non condensing
Protection Class	IP66 (front), IP20 (rear)
Dimensions and Weights	
Faceplate LxH	422x267 mm (16.6x10.5")
Cutout AxB	411x256 mm (16.18x10")
Depth D+T	56+8 mm (2.20+0.33")
Weight	4.1 Kg
Approvals	
CE	Emission EN 61000-6-4, Immunity EN 61000-6-2 for installation in industrial environments
UL	cULus: UL61010-1 / UL61010-2-201
DNV-GL	Yes

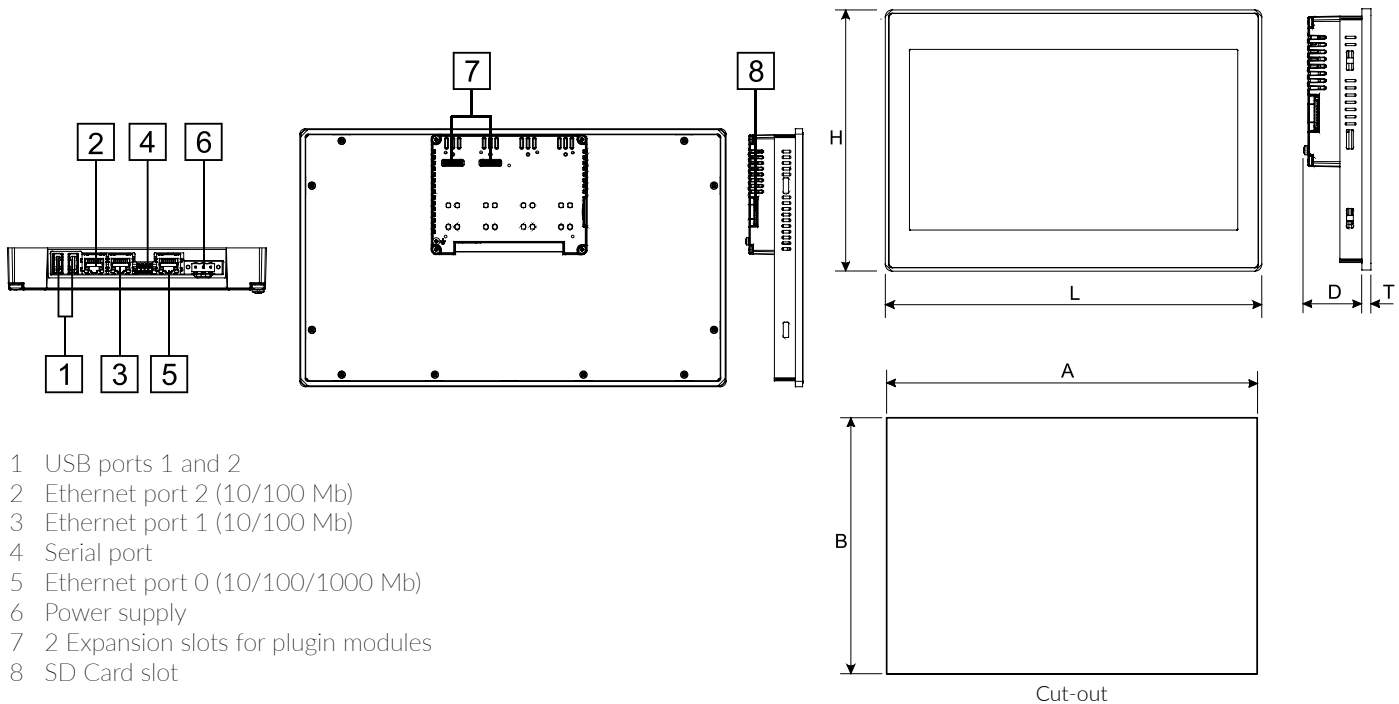

Ordering Information

Model	Part Number	Description
eX715	+EX715U5P1	15.6" widescreen TFT color with multitouch projected capacitive touchscreen. 3 Ethernet ports, 1 serial port, 2 USB ports. JMobile runtime.

Technical Data



System Resources	
Display - Colors	21,5" TFT LED - 16M
Resolution	1920x1080, full HD
Brightness	300 Cd/m ² typ.
Dimming	to 0%
Touchscreen	True Glass Projected Capacitive, Multitouch
CPU	ARM Cortex-A9 quad core 800 MHz
Operating System	Linux RT
Flash	8 GB
RAM	2 GB
Real Time Clock, RTC Back-up, Buzzer	Yes
Interface	
Ethernet port	3 (port 0 - 10/100/1000, port 1 - 10/100, port 2 - 10/100)
USB port	2 (Host V2.0, max. 500 mA)
Serial port	1 (RS-232, RS-485, RS-422, software configurable) Max 3 serial ports using plug-in modules.
SD card	Yes
Expansion	2 slot for plug in modules
Ratings	
Power supply	24 Vdc (10 to 32 Vdc)
Current Consumption	1.7 A at 24 Vdc (max.)
Input Protection	Electronic
Battery	Rechargeable Lithium battery, not user-replaceable
Environment Conditions	
Operating Temp	-20° to +60 °C (vertical installation) Plug-in modules and USB devices may limit max temperature to +50 °C
Storage Temp	-20°C to +70°C
Operating / Storage Humidity	5-85% RH, non condensing
Protection Class	IP66 (front), IP20 (rear)
Dimensions and Weights	
Faceplate LxH	552x347 mm (21,7x13,66")
Cutout AxB	541x336 mm
Depth D+T	56+8.5 mm
Weight	6.1 Kg
Approvals	
CE	Emission EN 61000-6-4, Immunity EN 61000-6-2 for installation in industrial environments
UL	cULus: UL61010-1 / UL61010-2-201
DNV-GL	Yes

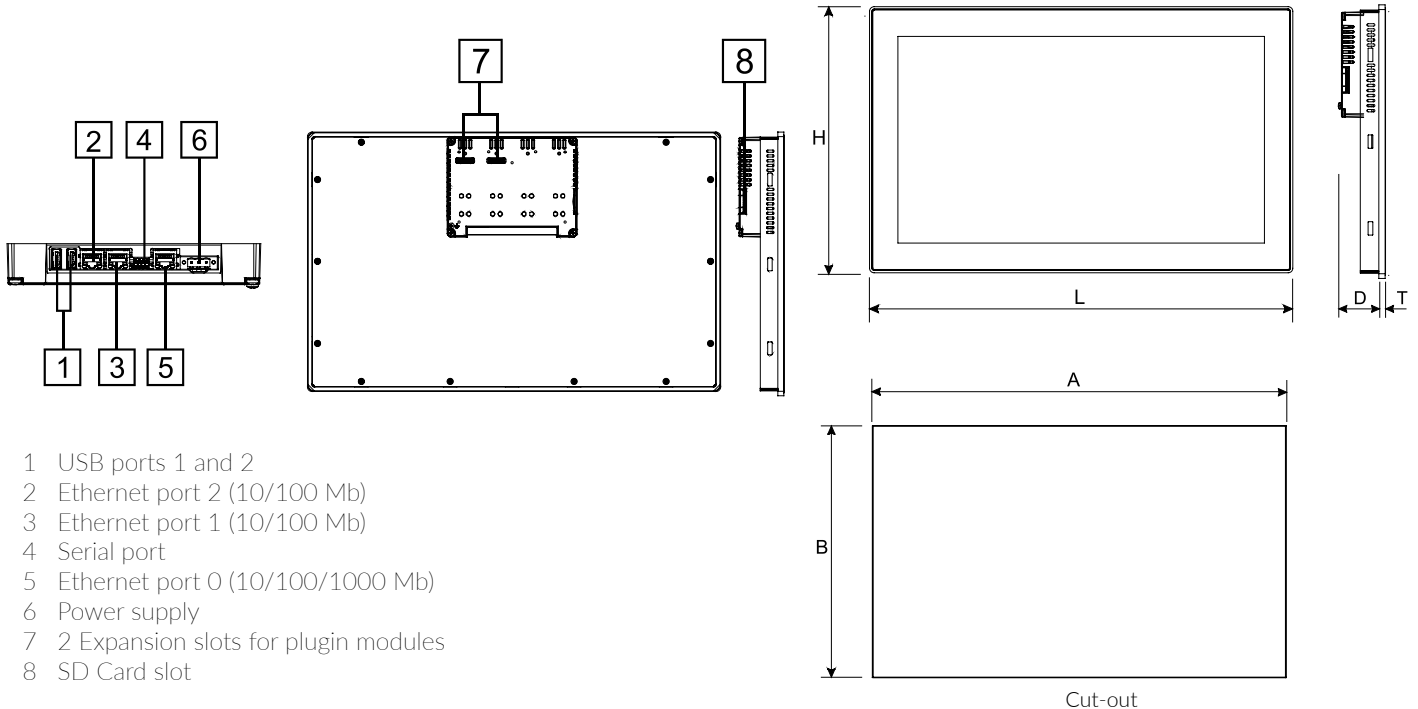

Ordering Information

Model	Part Number	Description
eX721	+EX721U5P1	21.5" widescreen TFT color with multitouch projected capacitive touchscreen. 3 Ethernet ports, 1 serial port, 2 USB ports. JMobile runtime.

Technical Data



Model	Part Number	Description
PLCM01	+PLCM01U0P1	Plug-in module CAN
PLCM02	+PLCM02U001	Plug-in module KNX/EIB (TP interface)
PLCM03	+PLCM03U0P1	Plug-in module RS-232
PLCM04	+PLCM04U0P1	Plug-in module RS-422/485 with optical insulation
PLCM05	+PLCM05U0P2	Plug-in extender for use with PLIO03/PLIO04 (only for eX705)
PLCM06	+PLCM06U0P1	Plug-in module Profibus DP slave 12 MB
CODESYS V3 SoftPLC	+SWLC00R000000	CODESYS V3 activation license
PLIO03	+PLIO03U0P1	I/O Module with 20 DI 24VDC, 12 DO 24VDC 0,5 A, 8 AI (4 diff or 8 single or 4 PT100 or 4 TC), 4 AO, 1 PT100 Cold Junct
PLIO04	+PLIO04U0P1	I/O Module with 10 DI 24VDC, 10 DO SSR 1.4 A, 4 Programmable AI voltage/PT100/TC, 4 AI voltage, 1 PT100
PLIO06	+PLIO06U0P1	Compact I/O module. 8 DI, 6 DO, 1 Relay Output
PLIO07	+PLIO07U001	Compact I/O module. 2 Relay Outputs



eXware Series

First Step IIoT Compatibility

eXware Tech-Note

Key Features

- Plug and Forget integration into existing infrastructure
- Device data flow easily configured
- JMobile protocols and gateway functions
- JM4web HTML5 interface for web HMI
- Optional CODESYS V3: supports network stacks and local I/O expandability
- Direct OPC UA communications
- JMcloud secure remote connectivity
- Plug-in module for system expansion
- 2 Ethernet ports for physical separation of the OT and IT networks
- Rugged and Beautiful all metal design
- Wide operating temperature range
- System settings by web browser
- Trusted and secure Linux-based operating system
- Secure HTTPS/TLS encrypted data transmissions
- Mobile Communication via PLCM09 2G/3G modem*
- Support for Geo-Localization*
- IoT data distribution via MQTT*

*Road map for 2017



Overview

The eXware represents a prudent first step into the implementation of IIoT and Industry 4.0 compatibility. Acting as the **central element in IIoT landscape** the eXware can communicate between automation devices, cloud, fog and applications.

This central role offers companies the chance to start at a uncomplicated level in IIoT and yet allows enormous future expansion into more complex aspects of Industry 4.0 as the workforce gains knowledge of this form of digital thread process and control.

For **maximum security** the physical separation of the OT and IT networks with two ethernet ports has been provided and this avoids simultaneous attacks. Secure HTTPS/TLS encrypted data transmissions with signed and packet transfer ensures against data theft and eavesdropping.

Seamless integration is achieved with the vast library of protocols that is common with JMobile software. Existing installations are easily employed and upgraded when necessary and very little programming skill is needed given the brilliant User Interface of JMobile.

Through use as a **gateway**, a **powerful HMI**, a **PLC with CODESYS V3** or a **secure router**, the eXware facilitates data intensive and complex IIoT applications to be enabled.

Technical Data



Functions	
Role/Application	Gateway, HMI, PLC, secure router - all data intensive IIoT applications
OT Networks	All Major Protocols: PROFINET, EtherNet/IP, EtherCAT, POWERLINK, Modbus, DNP3, BACnet, etc
Data Communication	OPC UA standard (pub/sub over TSN*)
Cloud Connectivity	Node-RED*, Bluemix*, Azure*, AWS*, Docker*
Operating System	Linux
Security	HTTPS, TLS
System Resources	
CPU	ARM Cortex-A8 1 GHz
Operating System	Linux RT
Flash	4 GB
RAM	512 MB
Real Time Clock, RTC Back-up, Buzzer	Yes
Interface	
Ethernet port	2 (port 0 - 10/100, port 1 - 10/100)
USB port	1 (Host v. 2.0, max. 500 mA)
Serial port	1 (RS-232, RS-485, RS-422, software configurable) Max 2 serial ports using plug-in modules.
SD card	Yes
Expansion	1 slot for plug-in modules
Ratings	
Power supply	24 Vdc (10 to 32 Vdc)
Current Consumption	0.5 A max. at 24 Vdc
Input Protection	Electronic
Battery	Yes
Environment Conditions	
Operating Temp	-20°C to +60°C Plug-in modules and USB devices may limit max temperature to +50 °C.
Storage Temp	-20°C to +70°C
Operating / Storage Humidity	5 - 85% RH, non condensing
Protection Class	IP20
Dimensions and Weights	
Faceplate LxH	45x134 mm (1.77x5.27")
Depth D+T	102 mm (4.01")
Weight	0.6 Kg
Mounting	TS35 DIN Rail
Approvals	
CE	Emission EN 61000-6-4 Immunity EN 61000-6-2 for installation in industrial environments

*Road map for 2017

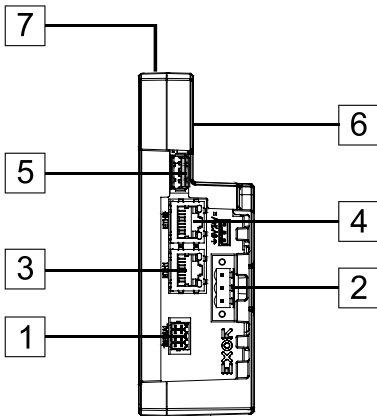

- 1 Serial port
- 2 Power supply
- 3 Ethernet port 1 (10/100 Mb)
- 4 Ethernet port 0 (10/100 Mb)
- 5 USB port 1
- 6 Expansion slots for plug-in modules
- 7 SD Card slot

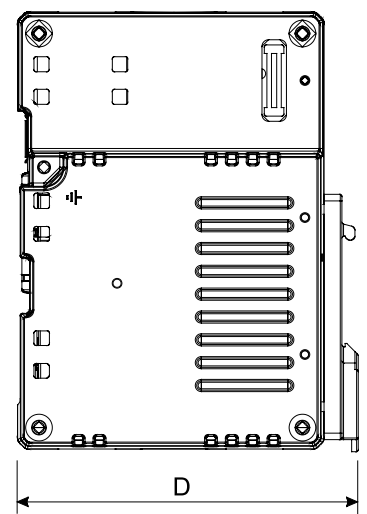
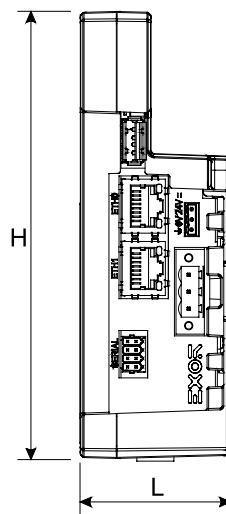

Ordering Information

Model	Part Number	Description
eXware 703	+EXW703U0P1	IIoT controller and Gateway, 2 Ethernet ports, 1 serial port, 1 USB port

Technical Data



Model	Part Number	Description
PLCM01	+PLCM01U0P1	Plug-in module CAN
PLCM02	+PLCM02U001	Plug-in module KNX/EIB (TP interface)
PLCM03	+PLCM03U0P1	Plug-in module RS-232
PLCM04	+PLCM04U0P1	Plug-in module RS-422/485 with optical insulation
PLCM06	+PLCM06U0P1	Plug-in module Profibus DP slave 12 MB
CODESYS V3 SoftPLC	+SWLC00R000000	CODESYS V3 activation license
PLIO03	+PLIO03U0P1	I/O Module with 20 DI 24VDC, 12 DO 24VDC 0,5 A, 8 AI (4 diff or 8 single or 4 PT100 or 4 TC), 4 AO, 1 PT100 Cold Junct
PLIO04	+PLIO04U0P1	I/O Module with 10 DI 24VDC, 10 DO SSR 1.4 A, 4 Programmable AI voltage/PT100/TC, 4 AI voltage, 1 PT100
PLIO06	+PLIO06U0P1	Compact I/O module. 8 DI, 6 DO, 1 Relay Output
PLIO07	+PLIO07U001	Compact I/O module. 2 Relay Outputs



eSMART Series

Stripped Down Essential Power

eSMART Series Tech-Notes

Key Features

- JMobile programmable
- Browser Programming Widget
- Chromium Web Browser
- OS Linux RT
- HW and FW Optimised for Extremely Fast Operation
- Supports HTML5 and JS
- Resistive Touchscreen
- Powerful CPU
- High Memory Resources
- Extended voltage range 10-32 Vdc
- OPC UA Server and Client
- Vast Library of Protocols
- Extremely Robust Design
- cULus, cULus Haz. Loc.*, ATEX*, DNV-GL*, by request eSMART107



Highlights

The eSMART series of products combine the power of JMobile - the software inside X Platform with an outstandingly robust design.

With very specific applications in mind we have stripped down the eSMART to only the essential components and have created a truly class leading product.

Stripped down does not mean that the product is not robust. In fact it maintains a IP66 protection rating for the front of the unit and is approved at cULus level. Pending we have DNV-GL, cULus Haz. Loc. and ATEX, allowing use in the most hazardous of environments.

Stripped down does not mean a cheap looking ugly product. The eSMART series is without doubt the most elegant in its class. No other fully plastic housed product can match the eSMART quality.

Stripped down does not mean reduction in high level functionality. Although the display is not at the incredible real life level of the eX700 series, the unique connectivity ability of JMobile - the software inside X Platform, allows the eSMART to communicate with a vast library of critical protocols as well as OPC UA standard and pub/sub* server and client.

Technical Data



System Resources	
Display - Colors	4.3" TFT 16:9 - 64K
Resolution	480x272
Brightness	200 Cd/m ² typ.
Dimming	Yes
Touchscreen	Resistive
CPU	ARM Cortex-A8 - 300 MHz
Operating System	Linux 3.12
Flash	2 GB
RAM	256 MB
Real Time Clock, RTC Back-up, Buzzer	Yes
Interface	
Ethernet port	1 (port 0 - 10/100)
USB port	1 (Host v. 2.0, max. 500 mA)
Serial port	1 (RS-232, RS-485, RS-422, software configurable)
SD card	No
Expansion	No
Ratings	
Power supply	24 Vdc (10*/18 to 32 Vdc)
Current Consumption	0.25 A max. at 24 Vdc
Input Protection	Automatic
Battery	Yes (Supercapacitor)
Environment Conditions	
Operating Temp	0 to 50 °C (vertical installation)
Storage Temp	-20°C to +70°C
Operating / Storage Humidity	5-85% RH, non condensing
Protection Class	IP66, Type 2 and 4X (front); IP20 (rear)
Dimensions and Weights	
Faceplate LxH	147x107 mm (5.78x4.21")
Cutout AxB	136x96 mm (5.35x3.78")
Depth D+T	29+5 mm (1.14+0.19")
Weight	Approx 0.4 Kg
Approvals	
CE	Emission EN 61000-6-4, Immunity EN 61000-6-2 for installation in industrial environments Emission EN 61000-6-3, Immunity EN 61000-6-1 for installation in residential environments
UL	cULus: UL508

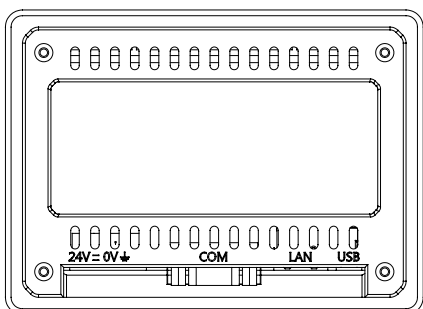
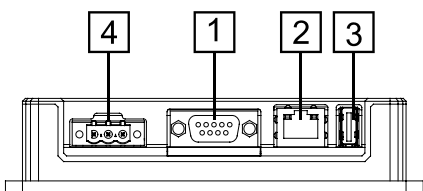

- 1 Serial Port
- 2 Ethernet Port
- 3 USB port (vers. 2.0 - 1.1)
- 4 Power Supply

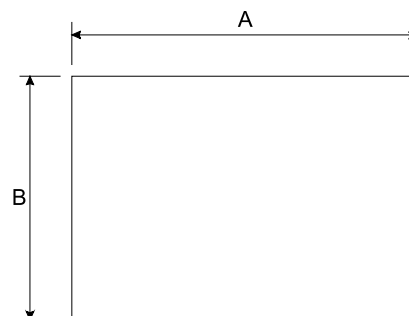
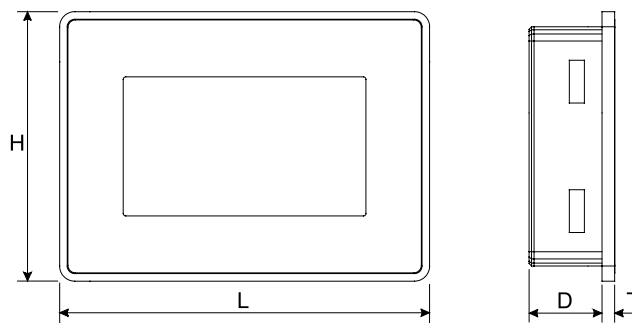

Cut-out

*Previsto per il 2017

Ordering Information

Model	Part Number	Description
eSMART04	+ESMA04U301	4" widescreen TFT color touchscreen with Ethernet and USB interfaces. JMobile runtime

Technical Data



System Resources	
Display - Colors	7" TFT 16:9 - 64K
Resolution	800x480, WVGA
Brightness	200 Cd/m ² typ.
Dimming	Yes
Touchscreen	Resistive
CPU	ARM Cortex-A8 - 1 GHz
Operating System	Linux 3.12
Flash	4 GB
RAM	512 MB
Real Time Clock, RTC Back-up, Buzzer	Yes
Interface	
Ethernet port	1 (port 0 - 10/100)
USB port	1 (Host v. 2.0, max. 500 mA)
Serial port	1 (RS-232, RS-485, RS-422, software configurable)
SD card	No
Expansion	No
Ratings	
Power supply	24 Vdc (10*/18 to 32 Vdc)
Current Consumption	0.3 A at 24 Vdc (max.)
Input Protection	Automatic
Battery	Yes (Supercapacitor)
Environment Conditions	
Operating Temp	0 to 50 °C (vertical installation)
Storage Temp	-20°C to +70°C
Operating / Storage Humidity	5-85% RH, non condensing
Protection Class	IP66, Type 2 and 4X (front); IP20 (rear)
Dimensions and Weights	
Faceplate LxH	187x147 mm (7.36x5.79")
Cutout AxB	176x136 mm (6.93x5.35")
Depth D+T	29+5 mm (1.14+0.19")
Weight	Approx 0.6 Kg
Approvals	
CE	Emission EN 61000-6-4, Immunity EN 61000-6-2 for installation in industrial environments Emission EN 61000-6-3, Immunity EN 61000-6-1 for installation in residential environments
UL	cULus: UL508

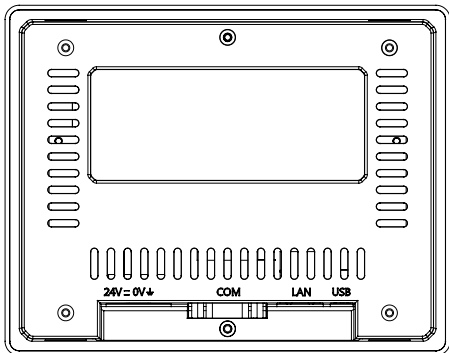
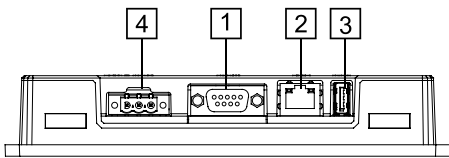

- 1 Serial Port
- 2 Ethernet Port
- 3 USB port (vers. 2.0 - 1.1)
- 4 Power Supply

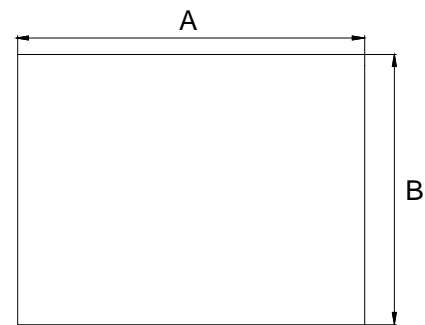
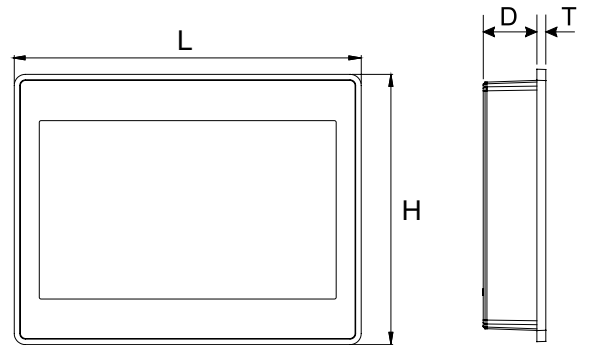

Cut-out

*Previsto per il 2017

Ordering Information

Model	Part Number	Description
eSMART07M	+ESMA07MU301	7" widescreen TFT color touchscreen with Ethernet and USB interfaces. JMobile runtime

Technical Data



System Resources	
Display - Colors	10.1" TFT 16:9 - 64K
Resolution	1024x600, WVGA
Brightness	200 Cd/m ² typ.
Dimming	Yes
Touchscreen	Resistive
CPU	ARM Cortex-A8 - 1 GHz
Operating System	Linux 3.12
Flash	4 GB
RAM	512 MB
Real Time Clock, RTC Back-up, Buzzer	Yes
Interface	
Ethernet port	1 (port 0 - 10/100)
USB port	1 (Host v. 2.0, max. 500 mA)
Serial port	1 (RS-232, RS-485, RS-422, software configurable)
SD card	No
Expansion	No
Ratings	
Power supply	24 Vdc (10*/18 to 32 Vdc)
Current Consumption	0.38 A at 24 Vdc (max.)
Input Protection	Automatic
Battery	Yes (Supercapacitor)
Environment Conditions	
Operating Temp	0 to 50 °C (vertical installation)
Storage Temp	-20°C to +70°C
Operating / Storage Humidity	5-85% RH, non condensing
Protection Class	IP66, Type 2 and 4X (front); IP20 (rear)
Dimensions and Weights	
Faceplate LxH	282x197 mm (11.10x7.80")
Cutout AxB	271x186 mm (10.66x7.32")
Depth D+T	29+6 mm (1.14+0.23")
Weight	Approx 1.0 Kg
Approvals	
CE	Emission EN 61000-6-4, Immunity EN 61000-6-2 for installation in industrial environments Emission EN 61000-6-3, Immunity EN 61000-6-1 for installation in residential environments
UL	cULus: UL508

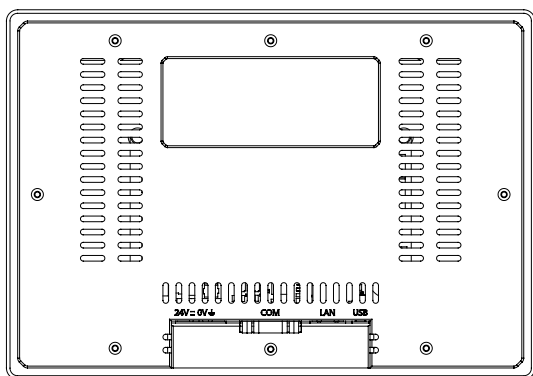
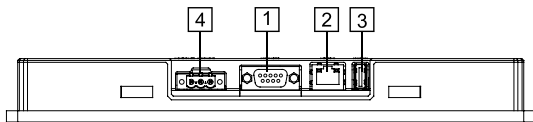

- 1 Serial Port
- 2 Ethernet Port
- 3 USB port (version 2.0 - 1.1)
- 4 Power Supply

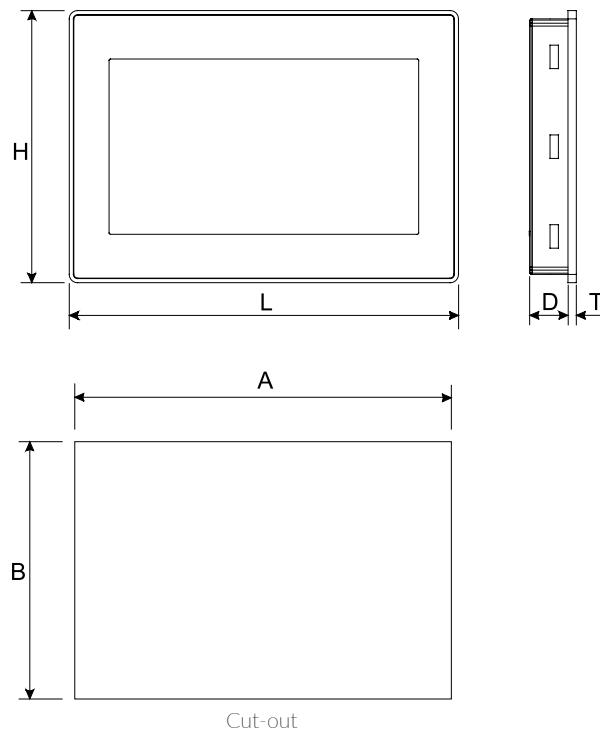

*Previsto per il 2017

Ordering Information

Model	Part Number	Description
eSMART10	+ESMA10U301	10" widescreen TFT color touchscreen with Ethernet and USB interfaces. JMobile runtime.

Technical Data



System Resources	
Display - Colors	7" TFT 16:9 - 64K
Resolution	800x480, WVGA
Brightness	200 Cd/m ² typ.
Dimming	to 0%
Touchscreen	Resistive
CPU	ARM Cortex-A9 dual core - 800 MHz
Operating System	Linux RT
Flash	4 GB
RAM	1 GB
Real Time Clock, RTC Back-up, Buzzer	Yes, Yes, No
Interface	
Ethernet port	2 (port 0 - 10/100/1000, port 1 - 10/100)
USB port	2 (Host V2.0, max. 100 mA)
Serial port	2 (RS-232), 2 (RS-422/RS-485 isolated), 2 (CAN 2.0b isolated)
SD card	No
Expansion	No
Ratings	
Power supply	24 Vdc (10 to 32 Vdc)
Current Consumption	0.3 A at 24 Vdc (max.)
Input Protection	Electronic
Battery	Yes (Supercapacitor)
Environment Conditions	
Operating Temp	0 to +50°C (vertical installation)
Storage Temp	-20°C to +70°C
Operating / Storage Humidity	5-85% RH, non condensing
Protection Class	IP66 (front); IP20 (rear)
Dimensions and Weights	
Faceplate LxH	187x147 mm (7.36x5.79")
Cutout AxB	176x136 mm (6.93x5.35")
Depth D+T	29+5 mm (1.14+0.19")
Weight	0.875 Kg
Approvals	
CE	Emission EN 61000-6-4, Immunity EN 61000-6-2 for installation in industrial environments

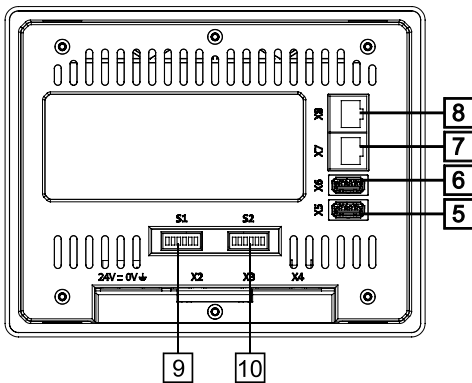
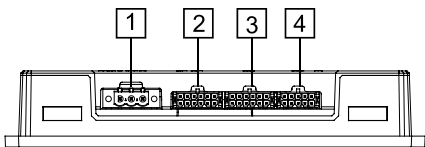

- 1 Power Supply
- 2 Serial port RS-485 + CAN
- 3 Serial port RS-485 + CAN
- 4 Serial port 2x RS-232
- 5 USB port
- 6 USB port
- 7 Ethernet port 0 (10/100/1000 Mb)
- 8 Ethernet port 1 (10/100 Mb)
- 9 DIP switch port configuration
- 10 DIP switch port configuration

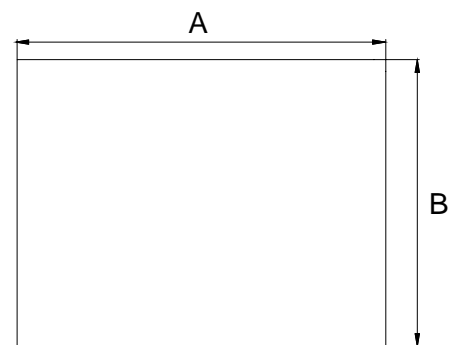
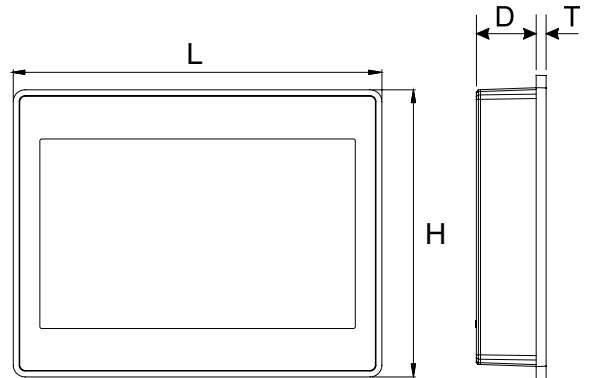

Cut-out

Ordering Information

Model	Part Number	Description
eSMART107	+ESMA107U301	7" TFT color with touchscreen. 2 Ethernet ports, 2 CAN ports, 4 serial ports, 2 USB ports. JMobile runtime.



eTOP500 Glass

The Choice for Extreme Conditions

eTOP500 Glass Series Tech-Notes



Key Features

- Proven Long Term Reliability
- Brilliant Displays Readable in Full Sunlight
- PCAP Touchscreen
- All Metal Enclosure
- Coated Board Protection
- Protection Class True IP69K
- Extended operating temperature
- Module Design Plug Ins for Fieldbus + Networks
- Optional CODESYS integrated PLC
- DNV-GL, IECEx, ATEX
- cULus, cULus Haz. Loc.

Highlights

For over six years this product has been serving our customers in environments that are not only harsh for the working of the device but where its reliable operation can be critical for the safety of operators.

The eTOP500 Glass has lived up to this challenge, with a class leading performance rate it has become the choice for extreme conditions.

What sets the model apart is the combination of the rugged design with the use of JMobile software which renders the operation of the HMI extremely easy: an important point when the surroundings are difficult.

Connecting to a vast array of networks and protocols is achieved via the module design so again aiding the implementation of these HMI within existing architecture.

Technical Data



System Resources	
Display - Colors	7" TFT 16:9 LED - 64K
Resolution	800x480, WVGA
Brightness	400 Cd/m ² typ.
Dimming	to 0%
Touchscreen	True Glass Projected Capacitive
CPU	ARM Cortex-A8 - 600 MHz
Operating System	Microsoft Windows CE 6.0
Flash	128 MB
RAM	256 MB
Real Time Clock, RTC Back-up, Buzzer	Yes
Interface	
Ethernet port	2 (port 0 - 10/100, port 1 - 10/100) with integrated Switch
USB port	2 (port 1 - Host V2.0, port 2 - Host V2.0/1.1)
Serial port	1 (RS-232, RS-485, RS-422, software configurable) Max 3 serial ports using plug-in modules.
SD card	Yes
Expansion	2 slot for plug in modules
Ratings	
Power supply	24 Vdc (10 to 32 Vdc)
Current Consumption	0.8 A at 24 Vdc (max.)
Input Protection	Automatic
Battery	Rechargeable Lithium battery, not user-replaceable
Environment Conditions	
Operating Temp	-20 to +60 °C (vertical installation)
Storage Temp	-40 to +85 °C
Operating / Storage Humidity	5-85% RH, non condensing
Protection Class	IP69K (front), IP20 (rear)
Dimensions and Weights	
Faceplate LxH	187x147 mm (7.36x5.79")
Cutout AxB	176x136 mm (6.93x5.35")
Depth D+T	47+8 mm (1.85+0.31")
Weight	Approx 1.0 Kg
Approvals	
CE	Emission EN 61000-6-4 Immunity EN 61000-6-2 for installation in industrial environments
UL	cULus: UL508
UL	cULus: Class I Div. 2
ATEX, IECEx	Zone 2/22
DNV-GL	Yes
RCM	Yes

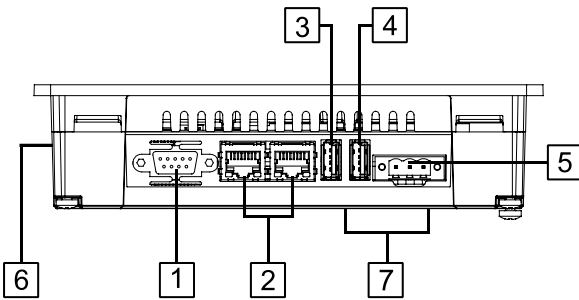

- 1 Serial Port
- 2 2x Ethernet Port
- 3 USB port (version 2.0 - 1.1)
- 4 USB port (version 2.0 High speed only)
- 5 Power Supply
- 6 SD Card Slot
- 7 2x Expansion slot for Plugin module

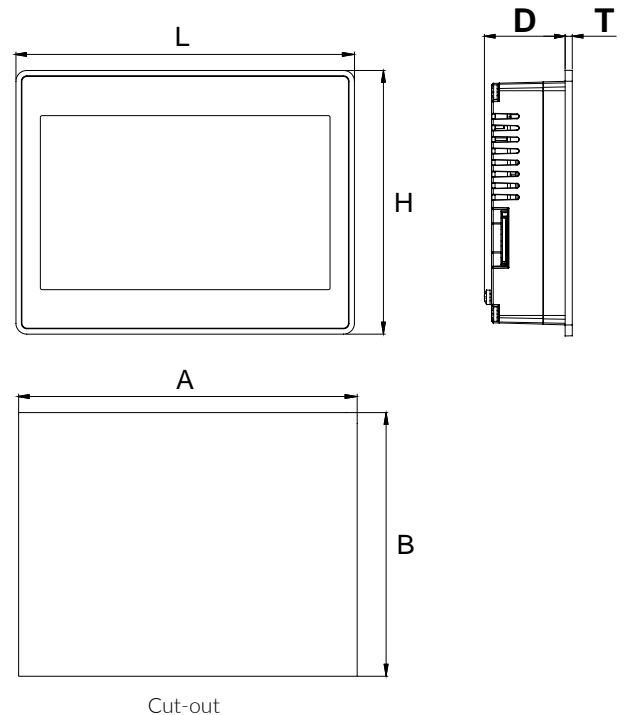

Ordering Information

Model	Part Number	Description
eTOP507G	+ETOP507U5P1	7" widescreen TFT color projected capacitive touchscreen with Ethernet and USB interfaces. JMobile runtime.

Technical Data



System Resources	
Display - Colors	7" TFT 16:9 LED - 64K
Resolution	800x480, WVGA
Brightness	400 Cd/m ² typ.
Dimming	to 0%
Touchscreen	True Glass Projected Capacitive
CPU	ARM Cortex-A8 - 1 GHz
Operating System	Microsoft Windows CE 6.0
Flash	256 MB
RAM	256 MB
Real Time Clock, RTC Back-up, Buzzer	Yes
Interface	
Ethernet port	2 (port 0 - 10/100, port 1 - 10/100) with integrated Switch
USB port	2 (port 1 - Host V2.0, port 2 - Host V2.0/1.1)
Serial port	1 (RS-232, RS-485, RS-422, software configurable) Max 3 serial ports using plug-in modules.
SD card	Yes
Expansion	2 slot for plug in modules
Ratings	
Power supply	24 Vdc (10 to 32 Vdc)
Current Consumption	0.9 A at 24 Vdc (max.)
Input Protection	Automatic
Battery	Rechargeable Lithium battery, not user-replaceable
Environment Conditions	
Operating Temp	-20 to +60 °C (vertical installation)
Storage Temp	-40 to +85 °C
Operating / Storage Humidity	5-85% RH, non condensing
Protection Class	IP69K (front), IP20 (rear)
Dimensions and Weights	
Faceplate LxH	187x147 mm (7.36x5.79")
Cutout AxB	176x136 mm (6.93x5.35")
Depth D+T	47+8 mm (1.85+0.31")
Weight	Approx 1.0 Kg
Approvals	
CE	Emission EN 61000-6-4 Immunity EN 61000-6-2 for installation in industrial environments
UL	cULus: UL508
UL	cULus: Class I Div. 2
ATEX, IECEx	Zone 2/22
DNV-GL	Yes
RCM	Yes

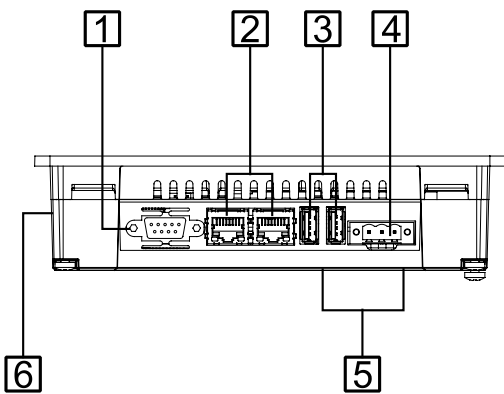

- 1 Serial Port-
- 2 2x Ethernet Port
- 3 2x USB Port
- 4 Power Supply
- 5 2x Expansion slots for Plugin modules
- 6 SD Card Slot for removable card

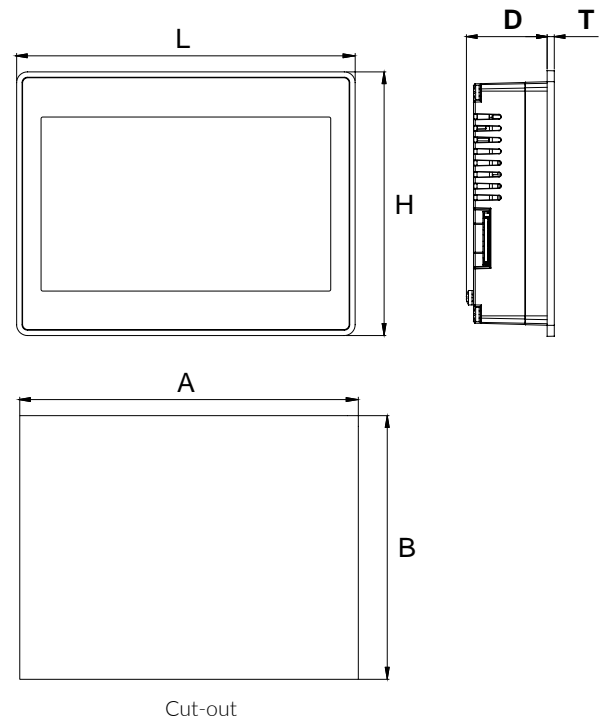

Ordering Information

Model	Part Number	Description
eTOP507MG	+ETOP507MU5P1	7" widescreen TFT color projected capacitive touchscreen with Ethernet and USB interfaces. JMobile runtime.

Technical Data



System Resources	
Display - Colors	10.1" TFT 16:9 LED - 64K
Resolution	1280x800, WXGA
Brightness	600 Cd/m ² typ.
Dimming	to 0%
Touchscreen	True Glass Projected Capacitive
CPU	ARM Cortex-A8 - 1 GHz
Operating System	Microsoft Windows CE 6.0
Flash	256 MB
RAM	256 MB
Real Time Clock, RTC Back-up, Buzzer	Yes
Interface	
Ethernet port	2 (port 0 - 10/100, port 1 - 10/100) with integrated Switch
USB port	2 (port 1 - Host V2.0, port 2 - Host V2.0/1.1)
Serial port	1 (RS-232, RS-485, RS-422, software configurable) Max 3 serial ports using plug-in modules.
SD card	Yes
Expansion	2 slot for plug in modules
Ratings	
Power supply	24 Vdc (10 to 32 Vdc)
Current Consumption	1.0 A at 24 Vdc (max.)
Input Protection	Automatic
Battery	Rechargeable Lithium battery, not user-replaceable
Environment Conditions	
Operating Temp	-20 to +60 °C (vertical installation)
Storage Temp	-20 to +70 °C
Operating / Storage Humidity	5-85% RH, non condensing
Protection Class	IP69K (front), IP20 (rear)
Dimensions and Weights	
Faceplate LxH	282x197 mm (11.10x7.80")
Cutout AxB	271x186 mm (10.67x7.32")
Depth D+T	52+8 mm (2.20+0.33")
Weight	Approx 2.7 Kg
Approvals	
CE	Emission EN 61000-6-4 Immunity EN 61000-6-2 for installation in industrial environments
UL	cULus: UL508
UL	cULus: Class I Div. 2
ATEX, IECEx	Zone 2/22
DNV-GL	Yes
RCM	Yes

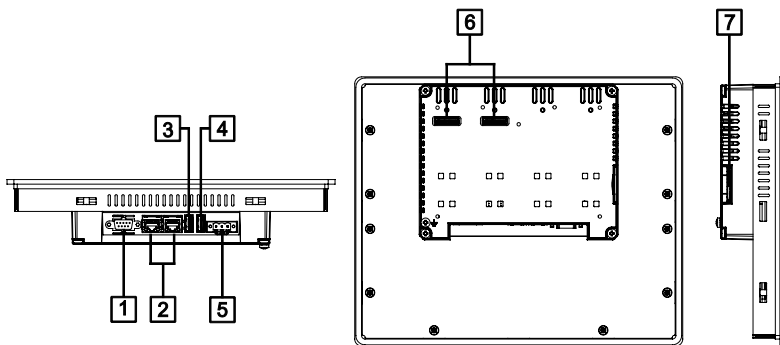

- 1 Serial Port
- 2 2x Ethernet Port
- 3 USB port (version 2.0 - 1.1)
- 4 USB port (version 2.0 High speed only)
- 5 Power Supply
- 6 2x Expansion slot for Plugin module
- 7 SD Card Slot

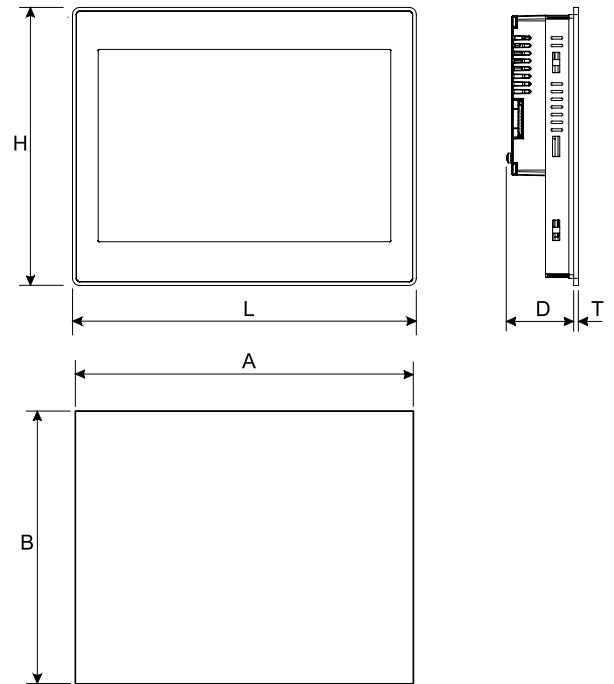

Cut-out

Ordering Information

Model	Part Number	Description
eTOP510G	+ETOP510U5P1	10.1" widescreen TFT color with projected capacitive touchscreen. Ethernet and USB interfaces. JMobile runtime.

Technical Data



System Resources	
Display - Colors	15" TFT LED - 64K
Resolution	1024x768, XGA
Brightness	1500 Cd/m ² typ
Dimming	to 0%
Touchscreen	True Glass Projected Capacitive
CPU	ARM Cortex-A8 - 1 GHz
Operating System	Microsoft Windows CE 6.0
Flash	256 MB
RAM	256 MB
Real Time Clock, RTC Back-up, Buzzer	Yes
Interface	
Ethernet port	2 (port 0 - 10/100, port 1 - 10/100) with integrated Switch
USB port	2 (port 1 - Host V2.0, port 2 - Host V2.0/1.1)
Serial port	1 (RS-232, RS-485, RS-422, software configurable) Max 3 serial ports using plug-in modules.
SD card	Yes
Expansion	2 slot for plug in modules
Ratings	
Power supply	24 Vdc (10 to 32 Vdc)
Current Consumption	1.4 A at 24 Vdc (max.)
Input Protection	Automatic
Battery	Rechargeable Lithium battery, not user-replaceable
Environment Conditions	
Operating Temp	-20 to +60 °C (vertical installation)
Storage Temp	-40 to +85 °C
Operating / Storage Humidity	5-85% RH, non condensing
Protection Class	IP69K (front), IP20 (rear)
Dimensions and Weights	
Faceplate LxH	392x307 mm (15.43x12.08")
Cutout AxB	381x296 mm (15x11.65")
Depth D+T	56+8.5 mm (2.20+0.33")
Weight	Approx 4.0 Kg
Approvals	
CE	Emission EN 61000-6-4 Immunity EN 61000-6-2 for installation in industrial environments
UL	cULus: UL508
UL	cULus: Class I Div. 2
ATEX, IECEx	Zone 2/22
DNV-GL	Yes
RCM	Yes

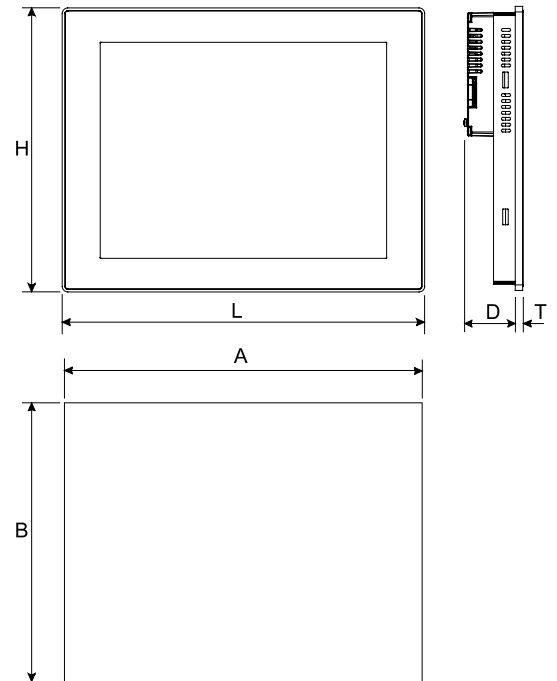
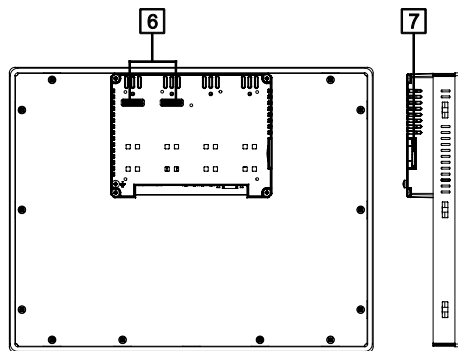
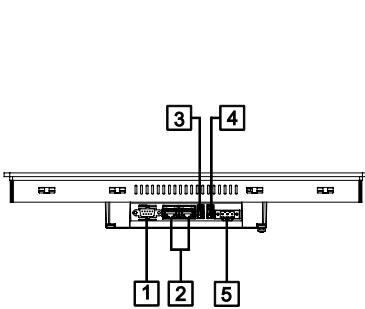

Cut-out

- 1 Serial Port
- 2 2x Ethernet Port
- 3 2x USB Port
- 4 Power Supply
- 5 2x Expansion slots for Plugin modules
- 6 2x Plug-in slots
- 7 SD Card Slot for removable card

Ordering Information

Model	Part Number	Description
eTOP515G	+ETOP515U5P1	15" widescreen TFT color projected capacitive touchscreen with Ethernet and USB interfaces. JMobile runtime.

Technical Data



Model	Part Number	Description
PLCM01	+PLCM01U0P1	Plug-in module CAN
PLCM02	+PLCM02U001	Plug-in module KNX/EIB (TP interface)
PLCM03	+PLCM03U0P1	Plug-in module RS-232
PLCM04	+PLCM04U0P1	Plug-in module RS-422/485 with optical insulation
PLCM06	+PLCM06U0P1	Plug-in module Profibus DP slave 12 MB
PLCM07	+PLCM07U0P1	Plug-in Secure Cloud Connector
CODESYS V3 SoftPLC	+SWLC00R000000	CODESYS V3 activation license
PLCM01-CDS	+PLCM01U0P2	Plug-in module CAN + CODESYS V2
PLCM02-CDS	+PLCM02U002	Plug-in module KNX/EIB (TP interface) + CODESYS V2
PLCM05-CDS	+PLCM05U0P1	Plug-in module CODESYS V2
PLIO03	+PLIO03U0P1	I/O Module with 20 DI 24VDC, 12 DO 24VDC 0,5 A, 8 AI (4 diff or 8 single or 4 PT100 or 4 TC), 4 AO, 1 PT100 Cold Junct
PLIO04	+PLIO04U0P1	I/O Module with 10 DI 24VDC, 10 DO SSR 1.4 A, 4 Programmable AI voltage/PT100/TC, 4 AI voltage, 1 PT100
PLIO06	+PLIO06U0P1	Compact I/O module. 8 DI, 6 DO, 1 Relay Output
PLIO07	+PLIO07U001	Compact I/O module. 2 Relay Outputs



eTOP500 Series

Solid as a Rock

eTOP500 Series Tech-Notes

Key features



- 5 Year Warranty
- Innovative mechanical design and all-metal enclosure
- Available in different sizes from 4.3" to 15"
- High-performance touchscreen HMI's
- Brilliant displays with LED technology all in full color
- Gateway function, remote installation of application and remote assistance
- Ethernet, USB, serial ports and MPI integrated
- Optional plug-in modules for fieldbus systems and networks
- Support SD Card
- Coating on all Electronic Boards
- Optional IEC 61131-3 integrated PLC (CODESYS V2 or V3)
- Front available in three colors (White/Black/Silver)
- Special versions for special applications

Overview

- Powerful and intuitive programming with JMobile Studio
- Support of a wide range of communication drivers
- Data display as numerical, text, bargraph, analog gauges and graphic image formats
- Data acquisition and trend presentation
- Recipe data handling
- Full support of multilanguage applications
- Powerful script language
- Alarm handling
- User and group access control
- Monitoring and remote control
- Report printing to USB printer
- Optional IEC 61131-3 integrated PLC (CODESYS V2 or V3)
- Rich set of HMI features: dynamic objects, data acquisition, alarm handling, Multilanguage applications, recipes, tag editor and tag database, user and password, scripting...
- Rich symbol library and project templates
- On-line and off-line simulation for applications
- Advanced HMI objects: e-mail, RSS feeds, Scheduler, Rotating menu, IP Video input

Technical Data



System Resources	
Display - Colors	4.3" TFT 16:9 LED - 64K
Resolution	480x272, WQVGA
Brightness	150 Cd/m ² typ.
Dimming	to 0%
Touchscreen	Resistive
CPU	ARM Cortex-A8 - 600 MHz
Operating System	Microsoft Windows CE 6.0
Flash	128 MB
RAM	256 MB DDR
Real Time Clock, RTC Back-up, Buzzer	Yes, Yes, No
Interface	
Ethernet port	2 (port 0 - 10/100, port 1 - 10/100) with integrated Switch
USB port	1 (port 1 - Host V2.0)
Serial port	1 (RS-232, RS-485, RS-422, MPI software configurable)
SD card	Yes
Expansion	1 slot for plug in modules
Ratings	
Power supply	24 Vdc (10 to 32 Vdc)
Current Consumption	0.55 A at 24 Vdc (max.)
Input Protection	Automatic
Battery	Rechargeable Lithium battery, not user-replaceable
Environment Conditions	
Operating Temp	-0 to +50 °C
Storage Temp	-20 to +70 °C
Operating / Storage Humidity	5-85% RH, non condensing
Protection Class	IP66 (front), IP20 (rear)
Dimensions and Weights	
Faceplate LxH	147x107 mm (5.78x4.21")
Cutout AxB	136x96 mm (5.35x3.78")
Depth D+T	56+4 mm (2.40+0.16")
Weight	Approx 1.0 Kg
Approvals	
CE	Emission EN 61000-6-4 Immunity EN 61000-6-2 for installation in industrial environments
UL	cULus: UL508
UL	cULus: Class I Div. 2
DNV-GL	Yes
RCM	Yes

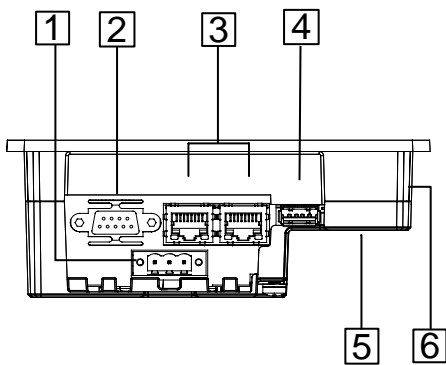

- 1 Power Supply
- 2 Serial Port
- 3 2 Ethernet Ports
- 4 USB Port
- 5 Expansion slot for Plugin module
- 6 SD Card Slot

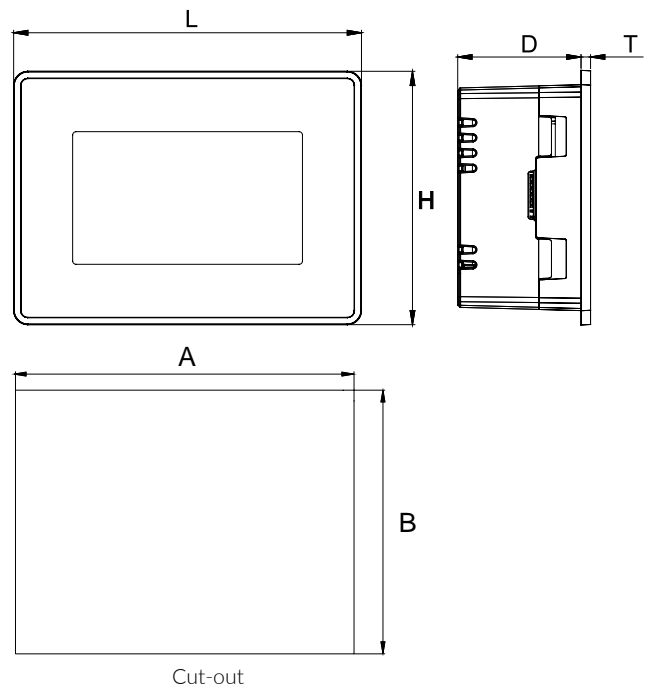

Ordering Information

Model	Part Number	Description
eTOP504-White	ETOP504U1P1	4.3" TFT color touchscreen panel with Ethernet interface, White front panel. JMobile run-time.
eTOP504-Silver	ETOP504U2P1	4.3" TFT color touchscreen panel with Ethernet interface. Silver front panel. JMobile run-time.
eTOP504-Black	ETOP504U3P1	4.3" TFT color touchscreen panel with Ethernet interface
PROTFOIL-04-GL	R-PROT11	Disposable protection foil for 3.5"/3.8"/4.3" eTOP touch panels (10 pieces)
PROTFOIL-04-UV	R-PROT17	Disposable protection foil for 3.5"/3.8"/4.3" eTOP touch panels (10 pieces). UV resistant

Technical Data

System Resources	
Display - Colors	5.7" TFT LED - 64K
Resolution	320x240, QVGA
Brightness	200 Cd/m ² typ.
Dimming	to 0%
Touchscreen	Resistive
CPU	ARM Cortex-A8 - 600 MHz
Operating System	Microsoft Windows CE 6.0
Flash	128 MB
RAM	256 MB DDR
Real Time Clock, RTC Back-up, Buzzer	Yes, Yes, No
Interface	
Ethernet port	2 (port 0 - 10/100, port 1 - 10/100) with integrated Switch
USB port	1 (port 1 - Host V2.0, port 2 - Host V2.0/1.1)
Serial port	1 (RS-232, RS-485, RS-422, MPI software configurable)
SD card	Yes
Expansion	2 slot for plug in modules
Ratings	
Power supply	24 Vdc (10 to 32 Vdc)
Current Consumption	0.65 A at 24 Vdc (max.)
Input Protection	Automatic
Battery	Rechargeable Lithium battery, not user-replaceable
Environment Conditions	
Operating Temp	-0 to +50 °C
Storage Temp	-20 to +70 °C
Operating / Storage Humidity	5-85% RH, non condensing
Protection Class	IP66 (front), IP20 (rear)
Dimensions and Weights	
Faceplate LxH	187x147 mm (7.36x5.79")
Cutout AxB	176x136 mm (6.93x5.35")
Depth D+T	47+4 mm (1.85+0.16")
Weight	Approx 1.0 Kg
Approvals	
CE	Emission EN 61000-6-4 Immunity EN 61000-6-2 for installation in industrial environments
UL	cULus: UL508
UL	cULus: Class I Div. 2
DNV-GL	Yes
RCM	Yes

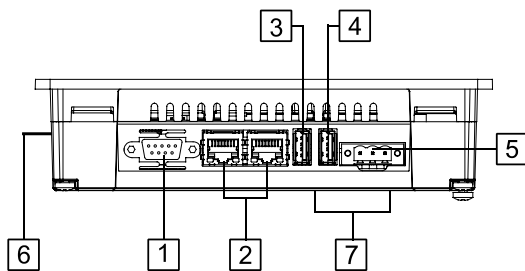

- 1 Serial Port
- 2 2x Ethernet Port
- 3 USB port (version 2.0 - 1.1)
- 4 USB port (version 2.0 High speed only)
- 5 Power Supply
- 6 SD Card Slot
- 7 2x Expansion slot for Plugin module

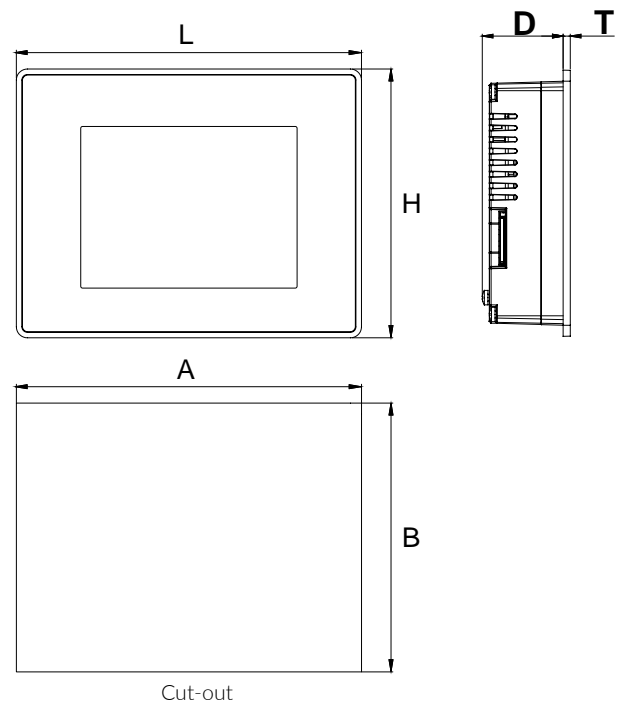

Ordering Information

Model	Part Number	Description
eTOP506-White	ETOP506U1P1	5.7" TFT color touchscreen with Ethernet and USB interfaces. White front panel. JMobile run-time.
eTOP506-Silver	ETOP506U2P1	5.7" TFT color touchscreen with Ethernet and USB interfaces. Silver front panel. JMobile run-time.
eTOP506-Black	ETOP506U3P1	5.7" TFT color touchscreen with Ethernet and USB interfaces. Black front panel. JMobile run-time.
PROTFOIL-07-GL	R-PROT12	Disposable protection foil for 5.7" and 7" eTOP touch panels (10 pieces).
PROTFOIL-07-UV	R-PROT18	Disposable protection foil for 5.7" and 7" eTOP touch panels (10 pieces). UV resistant.

Technical Data

System Resources	
Display - Colors	7" TFT 16:9 LED - 64K
Resolution	800x480, WVGA
Brightness	300 Cd/m ² typ.
Dimming	to 0%
Touchscreen	Resistive
CPU	ARM Cortex-A8 - 600 MHz
Operating System	Microsoft Windows CE 6.0
Flash	128 MB
RAM	256 MB DDR
Real Time Clock, RTC Back-up, Buzzer	Yes, Yes, No
Interface	
Ethernet port	2 (port 0 - 10/100, port 1 - 10/100) with integrated Switch
USB port	1 (port 1 - Host V2.0, port 2 - Host V2.0/1.1)
Serial port	1 (RS-232, RS-485, RS-422, MPI software configurable)
SD card	Yes
Expansion	2 slot for plug in modules
Ratings	
Power supply	24 Vdc (10 to 32 Vdc)
Current Consumption	0.7 A at 24 Vdc (max.)
Input Protection	Automatic
Battery	Rechargeable Lithium battery, not user-replaceable
Environment Conditions	
Operating Temp	-0 to +50 °C
Storage Temp	-20 to +70 °C
Operating / Storage Humidity	5-85% RH, non condensing
Protection Class	IP66 (front), IP20 (rear)
Dimensions and Weights	
Faceplate LxH	187x147 mm (7.36x5.79")
Cutout AxB	176x136 mm (6.93x5.35")
Depth D+T	47+4 mm (1.85+0.16")
Weight	Approx 1.0 Kg
Approvals	
CE	Emission EN 61000-6-4 Immunity EN 61000-6-2 for installation in industrial environments
UL	cULus: UL508
UL	cULus: Class I Div. 2
DNV-GL	Yes
RCM	Yes

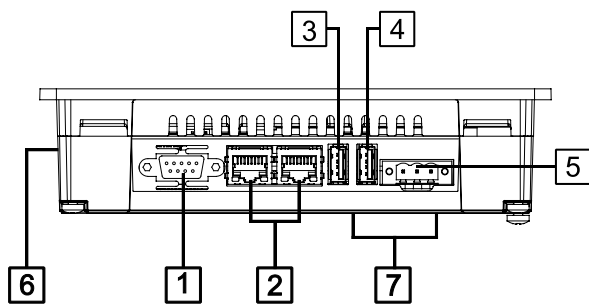

- 1 Serial Port
- 2 2x Ethernet Port
- 3 USB port (version 2.0 - 1.1)
- 4 USB port (version 2.0 High speed only)
- 5 Power Supply
- 6 SD Card Slot
- 7 2x Expansion slot for Plugin module

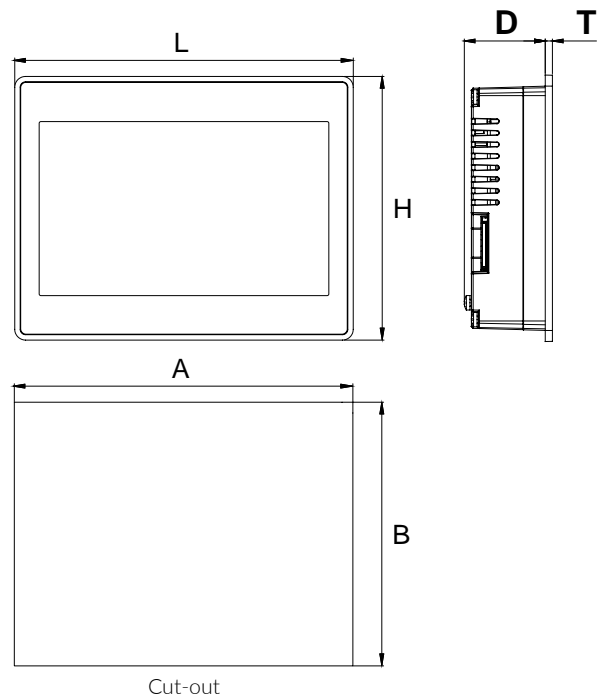

Ordering Information

Model	Part Number	Description
eTOP507-White	+ETOP507U1P3	7" widescreen TFT color touchscreen with Ethernet and USB interfaces. White front panel. JMobile run-time.
eTOP507-Silver	+ETOP507U2P3	7" widescreen TFT color touchscreen with Ethernet and USB interfaces. Silver front panel. JMobile run-time.
eTOP507-Black	+ETOP507U3P3	7" widescreen TFT color touchscreen with Ethernet and USB interfaces. Black front panel. JMobile run-time.
PROTFOIL-07-GL	R-PROT12	Disposable protection foil for 5.7" and 7" eTOP touch panels (10 pieces).
PROTFOIL-07-UV	R-PROT18	Disposable protection foil for 5.7" and 7" eTOP touch panels (10 pieces). UV resistant.

Technical Data



System Resources	
Display - Colors	7" TFT 16:9 LED - 64K
Resolution	800x480, WVGA
Brightness	300 Cd/m ² typ.
Dimming	to 0%
Touchscreen	Resistive
CPU	ARM Cortex-A8 - 1 GHz
Operating System	Microsoft Windows CE 6.0
Flash	256 MB
RAM	256 MB DDR
Real Time Clock, RTC Back-up, Buzzer	Yes, Yes, No
Interface	
Ethernet port	2 (port 0 - 10/100, port 1 - 10/100) with integrated Switch
USB port	1 (port 1 - Host V2.0, port 2 - Host V2.0/1.1)
Serial port	1 (RS-232, RS-485, RS-422, MPI software configurable)
SD card	Yes
Expansion	2 slot for plug in modules
Ratings	
Power supply	24 Vdc (10 to 32 Vdc)
Current Consumption	0.7 A at 24 Vdc (max.)
Input Protection	Automatic
Battery	Rechargeable Lithium battery, not user-replaceable
Environment Conditions	
Operating Temp	-0 to +50 °C
Storage Temp	-20 to +70 °C
Operating / Storage Humidity	5-85% RH, non condensing
Protection Class	IP66 (front), IP20 (rear)
Dimensions and Weights	
Faceplate LxH	187x147 mm (7.36x5.79")
Cutout AxB	176x136 mm (6.93x5.35")
Depth D+T	47+4 mm (1.85+0.16")
Weight	Approx 1.0 Kg
Approvals	
CE	Emission EN 61000-6-4 Immunity EN 61000-6-2 for installation in industrial environments
UL	cULus: UL508
UL	cULus: Class I Div. 2
DNV-GL	Yes
RCM	Yes

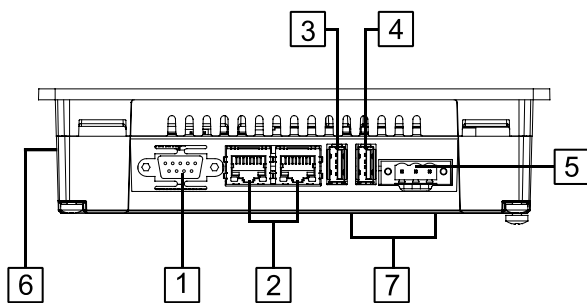

- 1 Serial Port
- 2 2x Ethernet Port
- 3 USB port (version 2.0 - 1.1)
- 4 USB port (version 2.0 High speed only)
- 5 Power Supply
- 6 SD Card Slot
- 7 2x Expansion slot for Plugin module

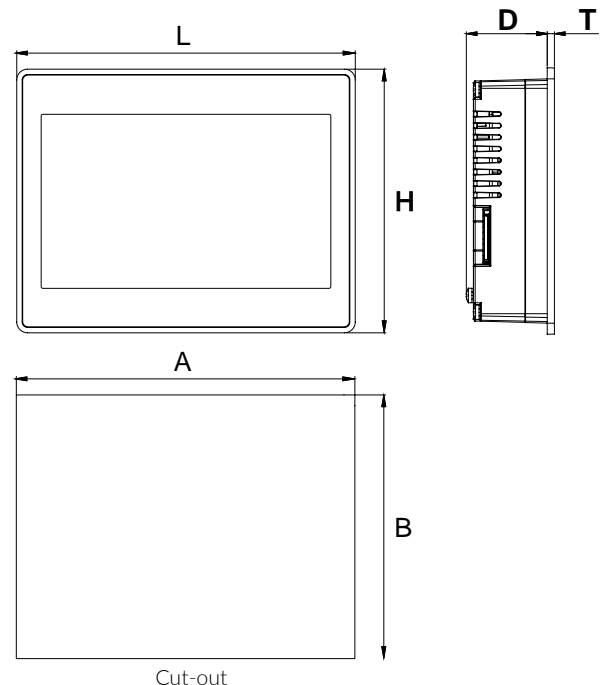

Ordering Information

Model	Part Number	Description
eTOP507-White	+ETOP507U1P3	7" widescreen TFT color touchscreen with Ethernet and USB interfaces. White front panel. JMobile run-time.
eTOP507-Silver	+ETOP507U2P3	7" widescreen TFT color touchscreen with Ethernet and USB interfaces. Silver front panel. JMobile run-time.
eTOP507-Black	+ETOP507U3P3	7" widescreen TFT color touchscreen with Ethernet and USB interfaces. Black front panel. JMobile run-time.
PROTFOIL-07-GL	R-PROT12	Disposable protection foil for 5.7" and 7" eTOP touch panels (10 pieces).
PROTFOIL-07-UV	R-PROT18	Disposable protection foil for 5.7" and 7" eTOP touch panels (10 pieces). UV resistant.

Technical Data

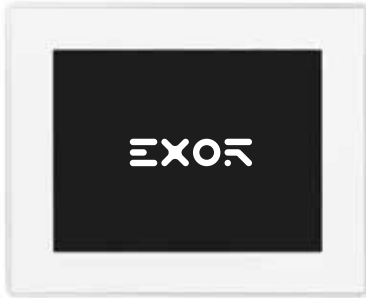

System Resources	
Display - Colors	10"4 TFT LED - 64K
Resolution	800x600, SVGA
Brightness	300 Cd/m ² typ.
Dimming	to 0%
Touchscreen	Resistive
CPU	ARM Cortex-A8 - 1 GHz
Operating System	Microsoft Windows CE 6.0
Flash	256 MB
RAM	256 MB DDR
Real Time Clock, RTC Back-up, Buzzer	Yes, Yes, No
Interface	
Ethernet port	2 (port 0 - 10/100, port 1 - 10/100) with integrated Switch
USB port	1 (port 1 - Host V2.0, port 2 - Host V2.0/1.1)
Serial port	1 (RS-232, RS-485, RS-422, MPI software configurable)
SD card	Yes
Expansion	2 slot for plug in modules
Ratings	
Power supply	24 Vdc (10 to 32 Vdc)
Current Consumption	1 A at 24 Vdc (max.)
Input Protection	Automatic
Battery	Rechargeable Lithium battery, not user-replaceable
Environment Conditions	
Operating Temp	-0 to +50 °C
Storage Temp	-20 to +70 °C
Operating / Storage Humidity	5-85% RH, non condensing
Protection Class	IP66 (front), IP20 (rear)
Dimensions and Weights	
Faceplate LxH	287x232 mm (11.3x9.13")
Cutout AxB	276x221 mm (10.86x8.70")
Depth D+T	56+4 mm (2.20+0.16")
Weight	Approx. 2.1 Kg
Approvals	
CE	Emission EN 61000-6-4 Immunity EN 61000-6-2 for installation in industrial environments
UL	cULus: UL508
UL	cULus: Class I Div. 2
DNV-GL	Yes
RCM	Yes

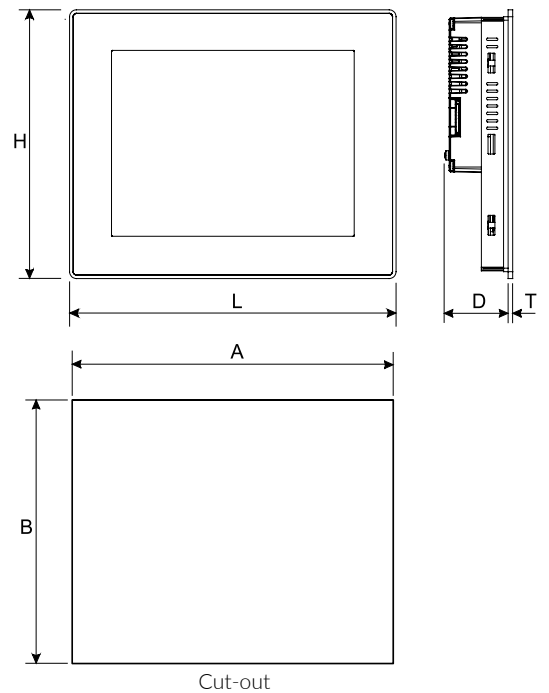
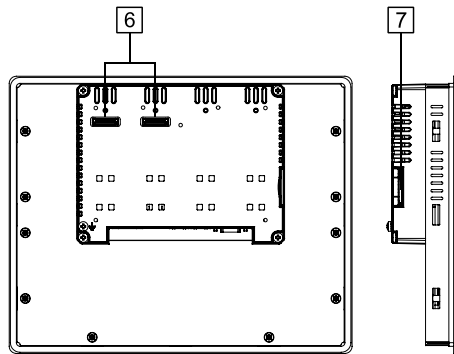
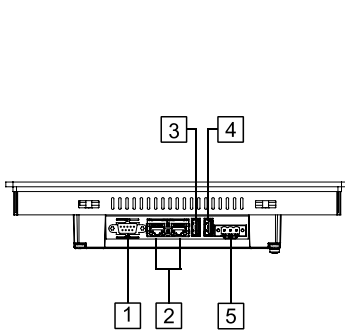

- 1 Serial Port
- 2 2x Ethernet Port
- 3 USB port (version 2.0 - 1.1)
- 4 USB port (version 2.0 High speed only)
- 5 Power Supply
- 6 2x Expansion slot for Plugin module
- 7 SD Card Slot

Ordering Information

Model	Part Number	Description
eTOP510-White	+ETOP510U1P1	10"4 TFT color touchscreen with Ethernet and USB interfaces. White front panel. JMobile run-time.
eTOP510-Silver	+ETOP510U2P1	10"4 TFT color touchscreen with Ethernet and USB interfaces. Silver front panel. JMobile run-time.
eTOP510-Black	+ETOP510U3P1	10"4 TFT color touchscreen with Ethernet and USB interfaces. Black front panel. JMobile run-time.
PROTFOIL-10-GL	R-PROT14	Disposable protection foil for 10"4 eTOP touch panels (10 pieces).
PROTFOIL-10-UV	R-PROT20	Disposable protection foil for 10"4 eTOP touch panels (10 pieces). UV resistant.

Technical Data

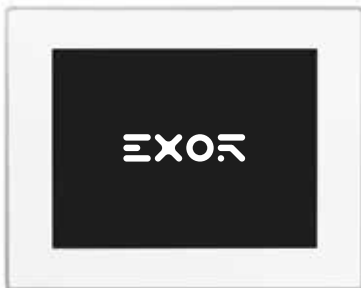

System Resources	
Display - Colors	12"1 TFT LED - 64K
Resolution	800x600, SVGA
Brightness	300 Cd/m ² typ.
Dimming	to 0%
Touchscreen	Resistive
CPU	ARM Cortex-A8 - 1 GHz
Operating System	Microsoft Windows CE 6.0
Flash	256 MB
RAM	256 MB DDR
Real Time Clock, RTC Back-up, Buzzer	Yes, Yes, No
Interface	
Ethernet port	2 (port 0 - 10/100, port 1 - 10/100) with integrated Switch
USB port	1 (port 1 - Host V2.0, port 2 - Host V2.0/1.1)
Serial port	1 (RS-232, RS-485, RS-422, MPI software configurable)
SD card	Yes
Expansion	2 slot for plug in modules
Ratings	
Power supply	24 Vdc (10 to 32 Vdc)
Current Consumption	1.05 A at 24 Vdc (max.)
Input Protection	Automatic
Battery	Rechargeable Lithium battery, not user-replaceable
Environment Conditions	
Operating Temp	-0 to +50 °C
Storage Temp	-20 to +70 °C
Operating / Storage Humidity	5-85% RH, non condensing
Protection Class	IP66 (front), IP20 (rear)
Dimensions and Weights	
Faceplate LxH	336x267 mm (13.22x10.51")
Cutout AxB	326x256 mm (12.83x10.07")
Depth D+T	56+4 mm (2.20+0.16")
Weight	Approx. 2.8 Kg
Approvals	
CE	Emission EN 61000-6-4 Immunity EN 61000-6-2 for installation in industrial environments
UL	cULus: UL508
UL	cULus: Class I Div. 2
DNV-GL	Yes
RCM	Yes

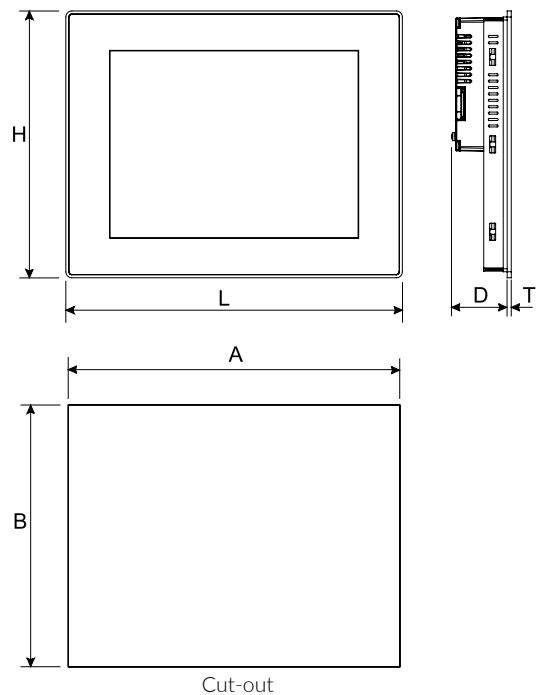
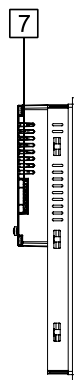
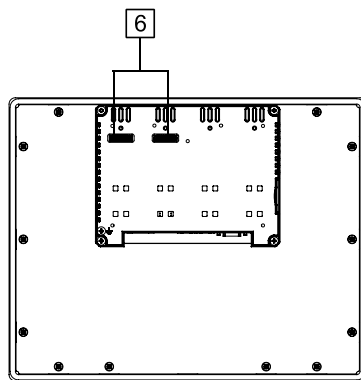
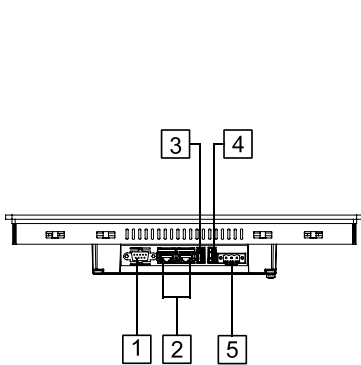

- 1 Serial Port
- 2 2x Ethernet Port
- 3 USB port (version 2.0 - 1.1)
- 4 USB port (version 2.0 High speed only)
- 5 Power Supply
- 6 2x Expansion slot for Plugin module
- 7 SD Card Slot

Ordering Information

Model	Part Number	Description
eTOP512-White	+ETOP512U1P1	12"1 TFT color touchscreen with Ethernet and USB interfaces. White front panel. JMobile run-time.
eTOP512-Silver	+ETOP512U2P1	12"1 TFT color touchscreen with Ethernet and USB interfaces. Silver front panel. JMobile run-time.
eTOP512-Black	+ETOP512U3P1	12"1 TFT color touchscreen with Ethernet and USB interfaces. Black front panel. JMobile run-time.
PROTFOIL-15-GL	R-PROT13	Disposable protection foil for 12"1 eTOP touch panels (10 pieces).
PROTFOIL-13-UV	R-PROT21	Disposable protection foil for 12"1 eTOP touch panels (10 pieces). UV resistant.

Technical Data



System Resources		
Display - Colors	13"3 TFT 16:9 LED - 64K	
Resolution	1280x800, WXGA	
Brightness	300 Cd/m ² typ.	
Dimming	to 0%	
Touchscreen	Resistive	
CPU	ARM Cortex-A8 - 1 GHz	
Operating System	Microsoft Windows CE 6.0	
Flash	256 MB	
RAM	256 MB DDR	
Real Time Clock, RTC Back-up, Buzzer	Yes, Yes, No	
Interface		
Ethernet port	2 (port 0 - 10/100, port 1 - 10/100) with integrated Switch	
USB port	1 (port 1 - Host V2.0, port 2 - Host V2.0/1.1)	
Serial port	1 (RS-232, RS-485, RS-422, MPI software configurable)	
SD card	Yes	
Expansion	2 slot for plug in modules	
Ratings		
Power supply	24 Vdc (10 to 32 Vdc)	
Current Consumption	1.15 A at 24 Vdc (max.)	
Input Protection	Automatic	
Battery	Rechargeable Lithium battery, not user-replaceable	
Environment Conditions		
Operating Temp	-0 to +50 °C	
Storage Temp	-20 to +70 °C	
Operating / Storage Humidity	5-85% RH, non condensing	
Protection Class	IP66 (front), IP20 (rear)	
Dimensions and Weights		
Faceplate LxH	336x267 mm (13.22x10.51")	
Cutout AxB	326x256 mm (12.83x10.07")	
Depth D+T	56+4 mm (2.20+0.16")	
Weight	Approx. 2.8 Kg	
Approvals		
CE	Emission EN 61000-6-4 Immunity EN 61000-6-2 for installation in industrial environments	
UL	cULus: UL508	
UL	cULus: Class I Div. 2	
DNV-GL	Yes	
RCM	Yes	

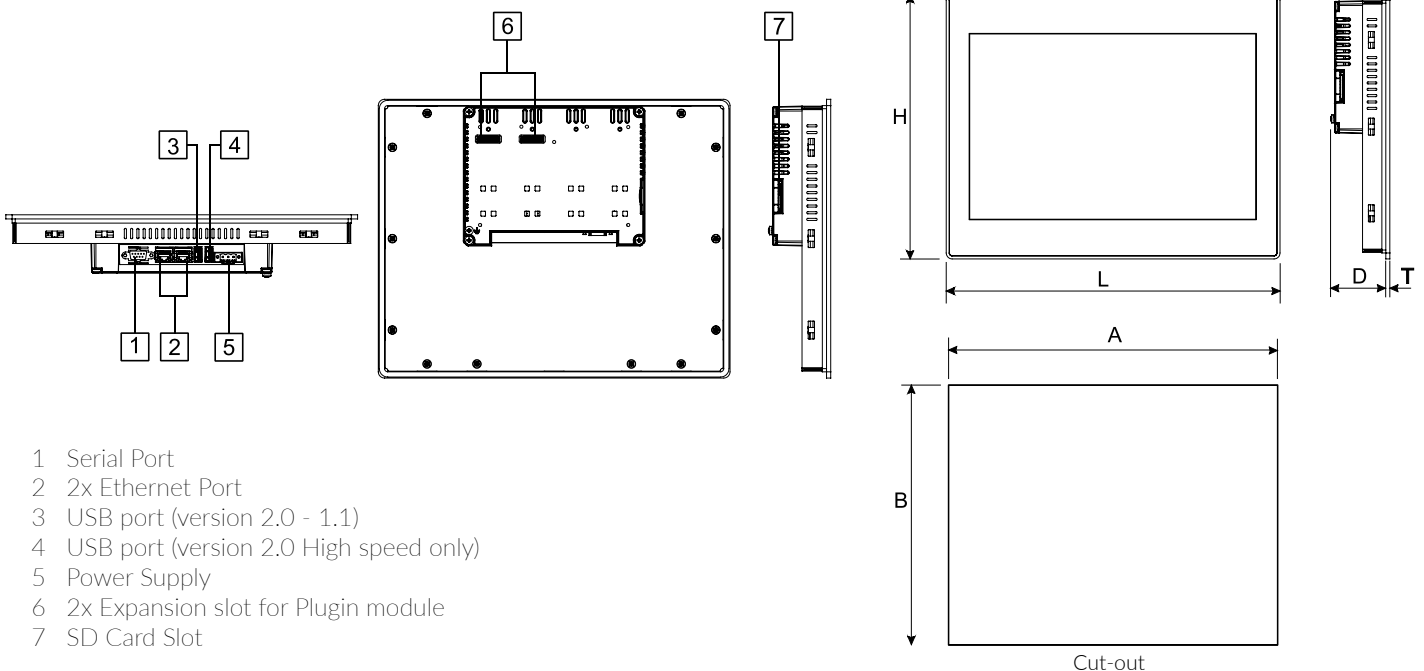

Ordering Information

Model	Part Number	Description
eTOP513-White	+ETOP513U1P1	13"3 widescreen TFT color touchscreen with Ethernet and USB interfaces. White front panel. JMobile run-time.
eTOP513-Silver	+ETOP513U2P1	13"3 widescreen TFT color touchscreen with Ethernet and USB interfaces. Silver front panel. JMobile run-time.
eTOP513-Black	+ETOP513U3P1	13"3 widescreen TFT color touchscreen with Ethernet and USB interfaces. Black front panel. JMobile run-time.
PROTFOIL-13-GL	R-PROT15	Disposable protection foil for 13"3 widescreen eTOP touch panels (10 pieces).
PROTFOIL-13-UV	R-PROT21	Disposable protection foil for 13"3 widescreen eTOP touch panels (10 pieces). UV resistant.

Technical Data



System Resources	
Display - Colors	15" TFT LED - 64K
Resolution	1024x768, XGA
Brightness	300 Cd/m ² typ.
Dimming	to 0%
Touchscreen	Resistive
CPU	ARM Cortex-A8 - 1 GHz
Operating System	Microsoft Windows CE 6.0
Flash	256 MB
RAM	256 MB DDR
Real Time Clock, RTC Back-up, Buzzer	Yes, Yes, No
Interface	
Ethernet port	2 (port 0 - 10/100, port 1 - 10/100) with integrated Switch
USB port	1 (port 1 - Host V2.0, port 2 - Host V2.0/1.1)
Serial port	1 (RS-232, RS-485, RS-422, MPI software configurable)
SD card	Yes
Expansion	2 slot for plug in modules
Ratings	
Power supply	24 Vdc (10 to 32 Vdc)
Current Consumption	1.25 A at 24 Vdc (max.)
Input Protection	Automatic
Battery	Rechargeable Lithium battery, not user-replaceable
Environment Conditions	
Operating Temp	-0 to +50 °C
Storage Temp	-20 to +70 °C
Operating / Storage Humidity	5-85% RH, non condensing
Protection Class	IP66 (front), IP20 (rear)
Dimensions and Weights	
Faceplate LxH	392x307 mm (15.43x12.08")
Cutout AxB	381x296 mm (15x11.65")
Depth D+T	60+4 mm (2.36+0.16")
Weight	Approx 3.5 Kg
Approvals	
CE	Emission EN 61000-6-4 Immunity EN 61000-6-2 for installation in industrial environments
UL	cULus: UL508
UL	cULus: Class I Div. 2
DNV-GL	Yes
RCM	Yes

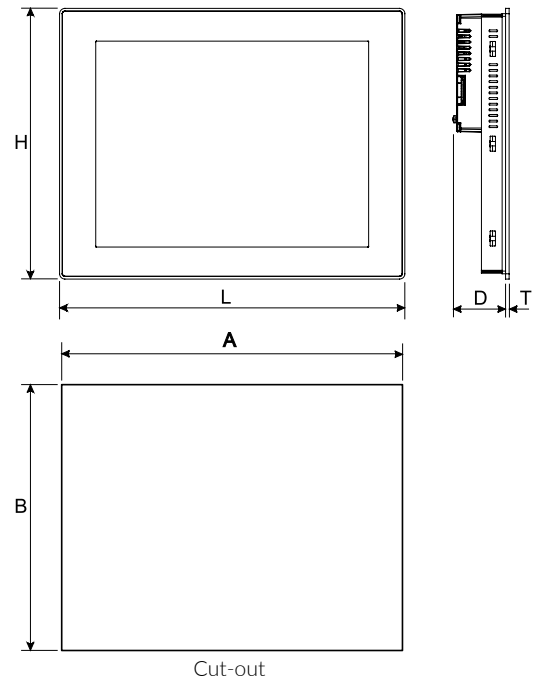
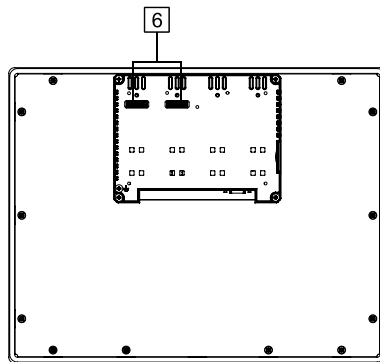
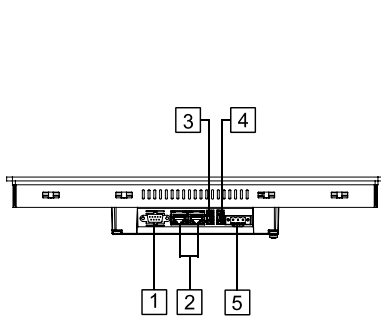

- 1 Serial Port
- 2 2x Ethernet Port
- 3 USB port (version 2.0 - 1.1)
- 4 USB port (version 2.0 High speed only)
- 5 Power Supply
- 6 2x Expansion slot for Plugin module
- 7 SD Card Slot

Ordering Information

Model	Part Number	Description
eTOP515-White	+ETOP515U1P1	15" TFT color touchscreen with Ethernet and USB interfaces. White front panel. JMobile run-time.
eTOP515-Silver	+ETOP515U2P1	15" TFT color touchscreen with Ethernet and USB interfaces. Silver front panel. JMobile run-time.
eTOP515-Black	+ETOP515U3P1	15" TFT color touchscreen with Ethernet and USB interfaces. Black front panel. JMobile run-time.
PROTFOIL-15-GL	R-PROT16	Disposable protection foil for 15" widescreen eTOP touch panels (10 pieces).
PROTFOIL-15-UV	R-PROT22	Disposable protection foil for 15" widescreen eTOP touch panels (10 pieces). UV resistant.

Technical Data

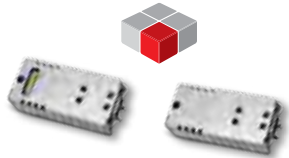

Model	Part Number	Description
PLCM01	+PLCM01U0P1	Plug-in module CAN
PLCM02	+PLCM02U001	Plug-in module KNX/EIB (TP interface)
PLCM03	+PLCM03U0P1	Plug-in module RS-232
PLCM04	+PLCM04U0P1	Plug-in module RS-422/485 with optical insulation
PLCM05	+PLCM05U0P2	Plug-in extender for use with PLIO03/PLIO04 (only for eTOP504)
PLCM06	+PLCM06U0P1	Plug-in module Profibus DP slave 12 MB
PLCM07	+PLCM07U0P1	Plug-in Secure Cloud Connector
CODESYS V3 SoftPLC	+SWLC00R000000	CODESYS V3 activation license
PLCM01-CDS	+PLCM01U0P2	Plug-in module CAN + CODESYS V2
PLCM02-CDS	+PLCM02U002	Plug-in module KNX/EIB (TP interface) + CODESYS V2
PLCM05-CDS	+PLCM05U0P1	Plug-in module CODESYS V2
PLIO03	+PLIO03U0P1	I/O Module with 20 DI 24VDC, 12 DO 24VDC 0,5 A, 8 AI (4 diff or 8 single or 4 PT100 or 4 TC), 4 AO, 1 PT100 Cold Junct
PLIO04	+PLIO04U0P1	I/O Module with 10 DI 24VDC, 10 DO SSR 1.4 A, 4 Programmable AI voltage/PT100/TC, 4 AI voltage, 1 PT100
PLIO06	+PLIO06U0P1	Compact I/O module. 8 DI, 6 DO, 1 Relay Output
PLIO07	+PLIO07U001	Compact I/O module. 2 Relay Outputs



Food and Beverage

The Real World, True Standard

Food and Beverage Tech-Notes

Key Features

- Ease of Cleaning
- Real World IP69K Rating
- Glass Strength with Polyester Coating
- High Pressure 80°C Water Resistant
- Perfect Stainless Steel Bezel Design
- Acid Chemical Resistant
- Food Compliant Gasket
- Front panel and gasket guidelines:
 - DIN EN1672-2
 - EHEDG / FDA 21 CFR 177.2006



Highlights

In every country, legislation requires that handling, preparation, processing and packaging of food is done hygienically: hygienic machinery in hygienic premises.

How to comply with these requirements, however, is left to the industry and even to the individual company.

The outstanding 7" and 15"* Food and Beverage HMI from EXOR is the best choice for each of the stakeholders in the purchase of this product:

- The Business Owner – An attractive HMI panel that demonstrates the company's commitment to hygiene.
- The Business Manager – Adherence to all directives and laws as well as the possibility to construct an Industry 4.0 compliant machine
- The Final User Operator – Direct and rapid cleaning at the same moment as the machine is cleaned, without any precautionary intervention for the control interface.

Technical Data



System Resources	
Display - Colors	7" TFT 16:9 LED - 64K
Resolution	800x480, WVGA
Brightness	400 Cd/m ² typ.
Dimming	to 0%
Touchscreen	True Glass Projected Capacitive
CPU	ARM Cortex-A8 - 1 GHz
Operating System	Microsoft Windows CE 6.0
Flash	256 MB
RAM	256 MB
Real Time Clock, RTC Back-up, Buzzer	Yes
Interface	
Ethernet port	2 (port 0 - 10/100, port 1 - 10/100) with integrated Switch
USB port	2 (Host V2.0, max. 500 mA)
Serial port	1 (RS-232, RS-485, RS-422, software configurable)
SD card	Yes
Expansion	2 slot for plug in modules
Ratings	
Power supply	24 Vdc (10 to 32 Vdc)
Current Consumption	0.9A at 24Vdc (max.)
Input Protection	Electronic
Battery	Rechargeable Lithium battery, not user-replaceable
Environment Conditions	
Operating Temp	-20° to +60 °C
Storage Temp	-40 to +85 °C
Operating / Storage Humidity	5-85% RH, non condensing
Protection Class	IP69K (front), IP20 (rear)
Dimensions and Weights	
Faceplate LxH	217x177 mm
Cutout AxB	176x136 mm (6.93x5.35")
Depth D+T	44 + 12.3 mm
Weight	2.5 Kg
Approvals	
CE	Emission EN 61000-6-4 Immunity EN 61000-6-2 for installation in industrial environments
UL	cULus: UL508

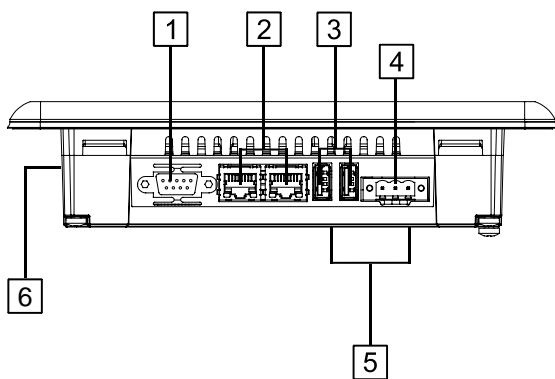

- 1 Serial Port
- 2 2x Ethernet Port
- 3 2x USB Port
- 4 Power Supply
- 5 2x Expansion slots for Plugin modules
- 6 SD Card Slot for removable card

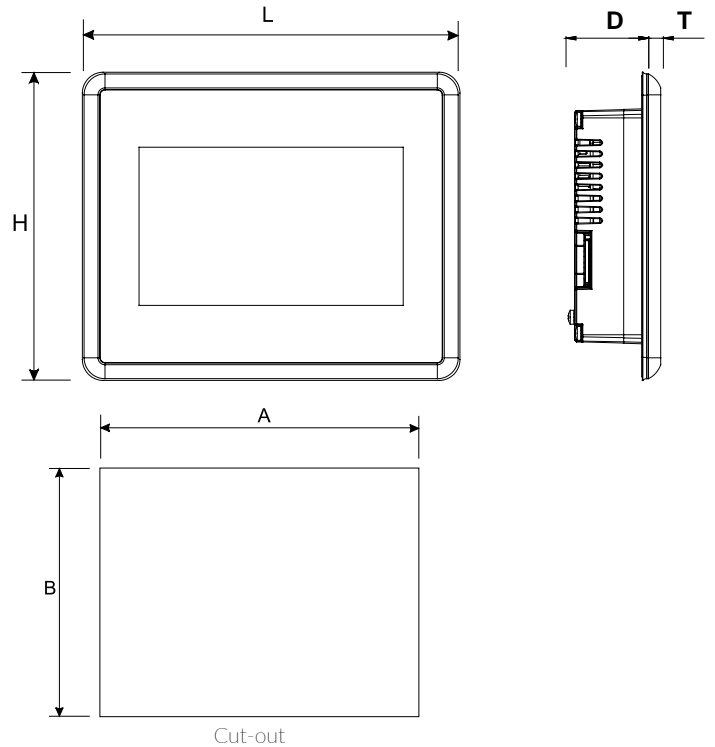

Ordering Information

Model	Part Number	Description
eTOP507MFB	+ETOP507MU1F1	7" widescreen TFT color projected capacitive touchscreen. Stainless steel bezel. Ethernet and USB interfaces. JMobile runtime. White front panel.
eTOP507MFB	+ETOP507MU4F1	7" widescreen TFT color projected capacitive touchscreen. Stainless steel bezel. Ethernet and USB interfaces. JMobile runtime. Blue front panel

Technical Data



System Resources	
Display - Colors	15,6" TFT LED - 16M
Resolution	1366x768, HD
Brightness	400 Cd/m ² typ.
Dimming	to 0%
Touchscreen	True Glass Projected Capacitive, Multitouch
CPU	ARM Cortex-A9 quad core 800 MHz
Operating System	Linux RT
Flash	8 GB
RAM	2 GB
Real Time Clock, RTC Back-up, Buzzer	Yes
Interface	
Ethernet port	3 (port 0 - 10/100/1000, port 1 - 10/100, port 2 - 10/100)
USB port	2 (Host V2.0, max. 500 mA)
Serial port	1 (RS-232, RS-485, RS-422, software configurable) Max 3 serial ports using plug-in modules.
SD card	Yes
Expansion	2 slot for plug in modules
Ratings	
Power supply	24 Vdc (10 to 32 Vdc)
Current Consumption	1.2 A at 24 Vdc (max.)
Input Protection	Electronic
Battery	Rechargeable Lithium battery, not user-replaceable
Environment Conditions	
Operating Temp	-20° to +60 °C (vertical installation)
Storage Temp	-30°C to +80°C
Operating / Storage Humidity	5-85% RH, non condensing
Protection Class	IP69K (front), IP20 (rear)
Dimensions and Weights	
Faceplate LxH	450x295mm
Cutout AxB	411x256 mm (16.18x10")
Depth D+T	56+8 mm (2.20+0.33")
Weight	4.1 Kg
Approvals	
CE	Emission EN 61000-6-4, Immunity EN 61000-6-2 for installation in industrial environments

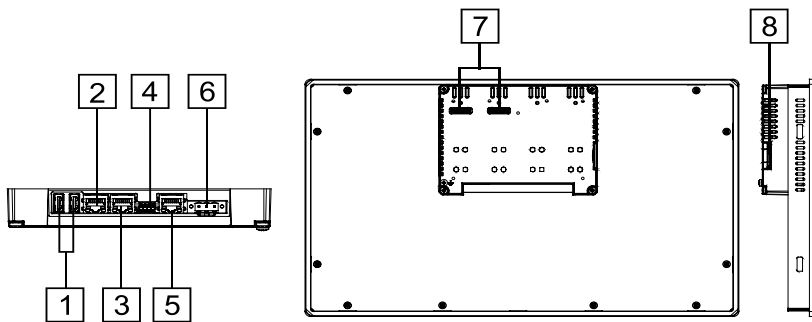

- 1 USB ports 1 and 2
- 2 Ethernet port 2 (10/100 Mb)
- 3 Ethernet port 1 (10/100 Mb)
- 4 Serial port
- 5 Ethernet port 0 (10/100/1000 Mb)
- 6 Power supply
- 7 2 Expansion slots for plugin modules
- 8 SD Card slot

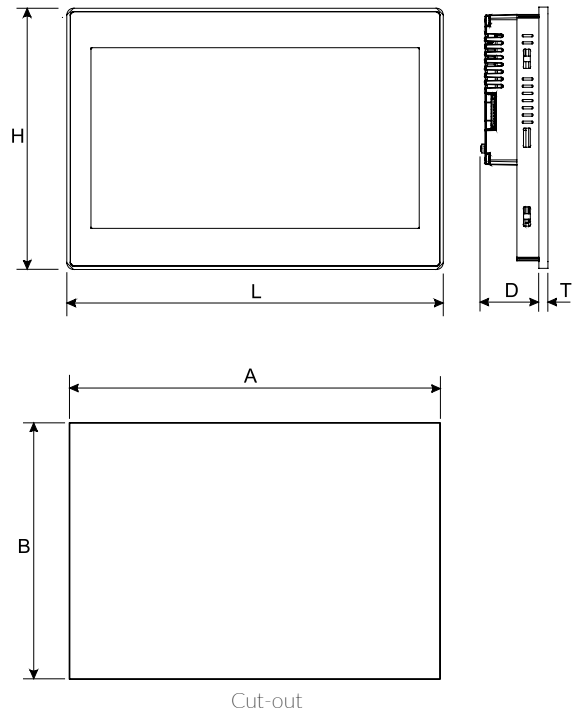

Ordering Information

Model	Part Number	Description
eX715FB	TBC	TBC

Technical Data



Model	Part Number	Description
PLCM01	+PLCM01U0P1	Plug-in module CAN
PLCM02	+PLCM02U001	Plug-in module KNX/EIB (TP interface)
PLCM03	+PLCM03U0P1	Plug-in module RS-232
PLCM04	+PLCM04U0P1	Plug-in module RS-422/485 with optical insulation
PLCM06	+PLCM06U0P1	Plug-in module Profibus DP slave 12 MB
PLCM07	+PLCM07U0P1	Plug-in Secure Cloud Connector
CODESYS V3 SoftPLC	+SWLC00R000000	CODESYS V3 activation license
PLCM01-CDS	+PLCM01U0P2	Plug-in module CAN + CODESYS V2
PLCM02-CDS	+PLCM02U002	Plug-in module KNX/EIB (TP interface) + CODESYS V2
PLCM05-CDS	+PLCM05U0P1	Plug-in module CODESYS V2
PLIO03	+PLIO03U0P1	I/O Module with 20 DI 24VDC, 12 DO 24VDC 0,5 A, 8 AI (4 diff or 8 single or 4 PT100 or 4 TC), 4 AO, 1 PT100 Cold Junct
PLIO04	+PLIO04U0P1	I/O Module with 10 DI 24VDC, 10 DO SSR 1.4 A, 4 Programmable AI voltage/PT100/TC, 4 AI voltage, 1 PT100
PLIO06	+PLIO06U0P1	Compact I/O module. 8 DI, 6 DO, 1 Relay Output
PLIO07	+PLIO07U001	Compact I/O module. 2 Relay Outputs



Handhelds

Secure Mobility HMI in your Hand

H4 Handheld Tech-Note



Key Features

- Certified Wireless Safety SIL2
- JMobile Integrated
- Easy to Program
- Stunning Design/Ergonomics
- Multiple Integrated Keys
- Potentiometers
- Handwheel
- State Selector
- Bluetooth Safety
- Additional WiFi Connectivity
- Magnets to Hang Devices in Convenient place
- Up to 50 m Connection

Overview

The H4 Handheld device is a true HMI in your hand: powerful and easy to program to your needs it remains the perfect choice for safe mobile requirements.

The wireless option leads to many positive features being enhanced:

- Higher Safety in all areas with no pendant wires to causes issues
- Less injury risks
- No broken cable downtime
- Far less physical fatigue of operator
- Increased concentration of operator

The wireless connection is provided by a Unique electronic key which allows for multiple handheld – machine connections to take place simultaneously without any concern for connectivity and of course safety.

Technical Data



System Resources	
Display - Colors	TFT LED - 64K
Resolution	480x272
Brightness	300 Cd/m ² typ.
Dimming	to 0%
Touchscreen	Resistive
CPU	ARM Cortex-A8 - 600 MHz
Operating System	Microsoft Windows CE 6.0
Flash	128 MB
RAM	256 MB
Real Time Clock, RTC Back-up	Yes
Handwheel	Yes
Potentiometer	2
State Selector Switch	16 positions
Emergency stop	Yes
Enabling Switch	3 positions
Interface	
Ethernet	Wi-Fi 802.11
USB port	1 Host V2.0
Bluetooth	Reserved for safety functions
Ratings	
Power supply (charging station)	24 Vdc (18 to 30 Vdc)
Current Consumption	0.25 A at 24 Vdc (max.)
Input Protection	Automatic
Battery	Rechargeable Lithium battery, not user-replaceable
Environment Conditions	
Operating Temp	+5 to +45°C
Storage Temp	-20 to +70°C
Operating / Storage Humidity	5-85% RH, non condensing
Protection Class	IP64
Dimensions and Weights	
Faceplate LxH	220x144 mm
Depth D+T	63 mm
Weight	Approx 0.8 Kg
Approvals	
CE	Emission EN 61000-6-4 Immunity EN 61000-6-2 for installation in industrial environments 2006/42/EC, EN ISO 13849-1:2008, EN 62061 :2005/A1:2013, EN 60204-1:2006/A1:2009
Safety	Emergency Stop cat 3, PL d / SIL 2
Safety functions	Enabling cat 3, PL d / SIL 2 State selector, cat 1, PL c / SIL 1

- 1 Token receptacle
- 2 Stop pushbottom
- 3 Enabling device
- 4 State Selector
- 5 Potentiometers
- 6 Handwheel
- 7 Membrane Keypad
- 8 Touchscreen pen
- 9 Mounting magnets
- 10 Status LED's
- 11 Battery Recharging Contacts

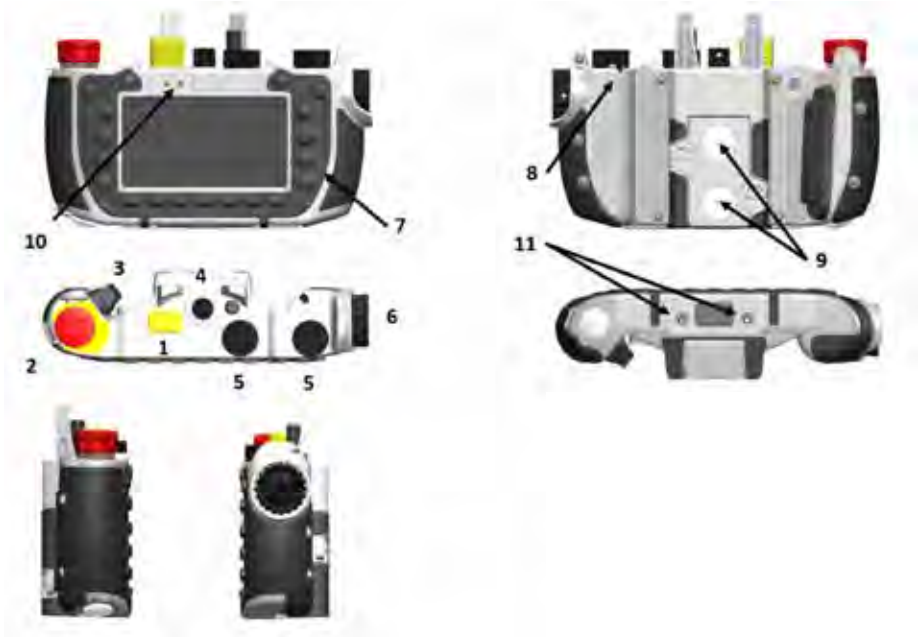

Ordering Information

Model	Part Number	Description
H4	+H4SISTEMA001	Wireless handheld, 5" TFT color touchscreen, emergency stop button, enabling switch, state selector, handwheel, JMobile runtime. Package includes H4 handheld, Receiving station, Charging station with spare battery, Antenna, Token

H3 Handheld Tech-Note

Key features

- Handheld HMI device with Safety Functions
- Compact and Lightweight
- Ergonomic design
- Programming tool “Drag&Drop”
- High reliability from industrial grade components
- Create user interfaces for all application areas
- Supports a great number of communication protocols
- Resistive touchscreen and keypad with tactile feedback
- USB Ports
- Emergency Stop button and 3-position Enabling Switch
- Integrated Handwheel, available as option
- Integrated 16-position selector and potentiometers
- Connection box, available as option
- Device Holder, available as option
- Cable length 5, 10, 20 meters
- Low Power Consumption
- Extended sales and support network



Overview

ON3 is an independent brand company specialized in safety products for Factory Automation.

ON3 handhelds are engineered and supported by EXOR International S.p.A.

For further information: www.On3.eu

Technical Data



System Resources	
Display - Colors	TFT LED - 64K
Resolution	480x272
Brightness	300 Cd/m ² typ.
Dimming	to 0%
Touchscreen	Resistive
CPU	ARM Cortex-A8 - 600 MHz
Operating System	Microsoft Windows CE 6.0
Flash	128 MB
RAM	256 MB
Real Time Clock, RTC Back-up	Yes
Handwheel	Yes (option)
Potentiometer	2
State Selector Switch	16 positions
Emergency stop	Yes, Hardwired
Enabling Switch	Hardwired, 3-positions
Interface	
Ethernet	10/100 Mbit (selected models)
USB port	1 Host V2.0
Serial	1 RS-232, RS-422, RS-485 (selected models)
Ratings	
Power supply (charging station)	24 Vdc (18 to 30 Vdc)
Current Consumption	0.25 A at 24 Vdc (max.)
Input Protection	Automatic
Battery	Rechargeable Lithium battery, not user-replaceable
Environment Conditions	
Operating Temp	+5 to +45°C
Storage Temp	-20 to +70°C
Operating / Storage Humidity	5-95% RH, non condensing
Protection Class	IP64
Dimensions and Weights	
Faceplate LxH	220x130 mm
Depth D+T	50 mm
Weight	Approx 0.8 Kg, (not including cable)
Approvals	
CE	Emission EN 61000-6-4 Immunity EN 61000-6-2 for installation in industrial environments
UL	cULus: UL508 (only +EP3H3REJ2H0YE2, +EP3H3REJ4H0YE2)

- 1 Cable
- 2 Emergency stop push-button
- 3 Enabling device
- 4 State Selector
- 5 Screen
- 6 Potentiometers
- 7 Handwheel (Optional)
- 8 Membrane Keypad
- 9 Touchscreen pen
- 10 Sticker
- 11 Mounting magnets
- 12 Status LED's
- 13 Rubber cup for USB
- 14 Protecting covers
- 15 Hand Grip

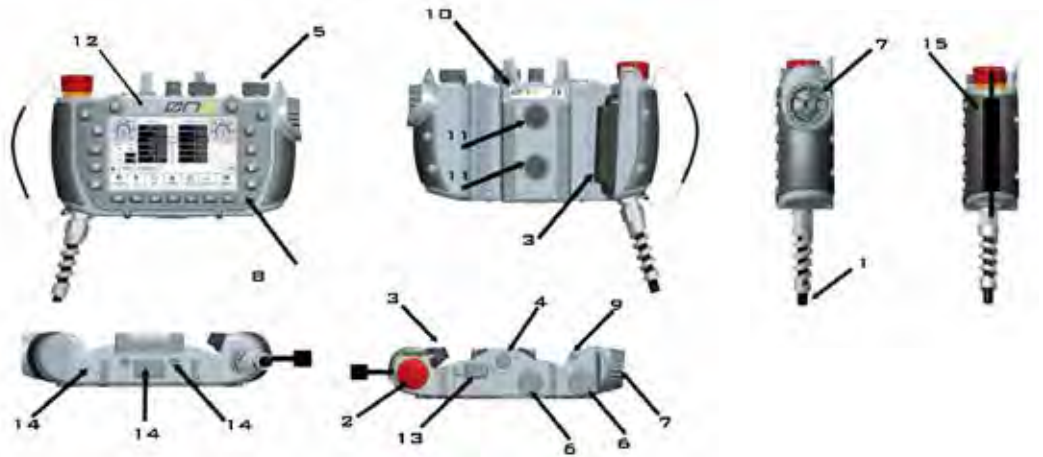

Ordering Information

Model	Part Number	Description
H3	+EP3H3REJ200YE1	HMI H3 0N3 WIRED 10 m ETHERNET JM
H3	+EP3H3REJ400YE1	HMI H3 0N3 WIRED 20 m ETHERNET JM
H3	+EP3H3REJ2H0YE1	HMI H3 0N3 WIRED 10 m ETH+HANDWHEEL JM
H3	+EP3H3REJ4H0YE1	HMI H3 0N3 WIRED 20 m ETH+HANDWHEEL JM
H3	+EP3H3RSJ200YE1	HMI H3 0N3 WIRED 10 m SERIAL JM
H3	+EP3H3RSJ2H0YE1	HMI H3 0N3 WIRED 10 m SERIAL+HANDWHEEL JM
H3	+EP3H3REJ2H0YE2	HMI H3 0N3 10 m ETH+HANDWHEEL CIRCULAR CONNECTOR JM - UL APPROVAL
H3	+EP3H3REJ4H0YE2	HMI H3 0N3 20 m ETH+HANDWHEEL CIRCULAR CONNECTOR JM - UL APPROVAL
H3	+EP3H00000X0YA2	CONNECTION BOX H3 CIRCULAR CONNECTOR - UL APPROVAL
H3	+EP3H00000B0YA0	STANDBY STATION H3 - HOLDER FOR H3



eX700 Field Series

Beautiful Power

eX700 Field Series Tech-Note Preliminary

Key features

- Patented Design
- TFT Superior Optical Performance
- Brightness 400 cd/m²
- 150° Wide Angle View
- Rugged Capacitive Multitouch
- Moisture and Water Support
- RJ45-IP67 Cat5e Shielded Plug
- Optional IP69K
- Ultra Thin Design 15mm
- 3 wireless communication
- Visualization in Pure Web Browser
- Open platform for Linux applications
- Performing HTML5-compatible browser with graphic accelerator
- JMobile runtime with OPC UA Server and Client
- Optional CODESYS V3 PLC for integrated HMI and control applications
- Optional full set of sensors (light, proximity, pressure, altitude, temperature, humidity, vibration, acceleration and inclination)



Highlights

An outstandingly beautiful and ideal field installation product, with tremendous technical flexibility backed by a company with 45 years in the industry.

The eX700 Field represents a ground breaking product to come to market: [The IIoT Panel](#)

The beauty of the eX700 Field is plain to see. Thin design, a single mounting and cable, minimum border with a superior optical performance all add to the “look” of a product unique to the market.

Yet the beauty of design is not only skin deep. High-resolution display (available HD and Full HD) with multitouch PCAP touchscreen. Power-over-Ethernet (PoE) for maximum simplicity of connection using standard CAT5 wiring. Full IP protection with the use of dedicated connectors for the maximum flexibility of installation, from mounting arm to a simple M22 hole.

The product also includes a full set of environment and motion sensors to make this device a true IIoT edge device for Industry 4.0 applications: vibrations, temperature, light, proximity, pressure, humidity and even a camera the collection of IIoT data is made easy.

The eX700 Field product family has been optimized for use as an embedded browser or as a JMobile HMI device.

Technical Data



System Resources	
Display - Colors	5" TFT - 16M
Resolution	800x480
Brightness	300 cd/m ² typ. (high brightness as option)
Dimming	to 0%
Touchscreen	Projected capacitive - Multitouch
CPU	ARM Cortex-A9 dual core - 800 MHz
Operating System	Linux RT
Flash	4 GB
RAM	1 GB
Real Time Clock, RTC Back-up, Buzzer	Yes, Yes, No
Interface	
Ethernet port	10/100 PoE 802.3af/at
USB port	1 (Host v. 2.0, request special connector)
Serial port	-
SD card	-
Expansion	-
Ratings	
Power supply	802.3af/at
Current Consumption	10 W max (to be confirmed)
Input Protection	-
Battery	Yes (rechargeable)
Environment Conditions	
Operating Temp	-30° to +55° C (vertical installation)
Storage Temp	-30°C to +85°C
Operating / Storage Humidity	5-85% RH, non-condensing
Protection Class	Front: IP67 (requires appropriate connectors and cables)
Dimensions and Weights	
Faceplate LxH	148.3x105.1 mm
Cutout	-
Depth D+T+T	15.6 mm
Weight	0.8 Kg
Approvals	
CE	Emission EN 61000-6-4, Immunity EN 61000-6-2 for installation in industrial environment

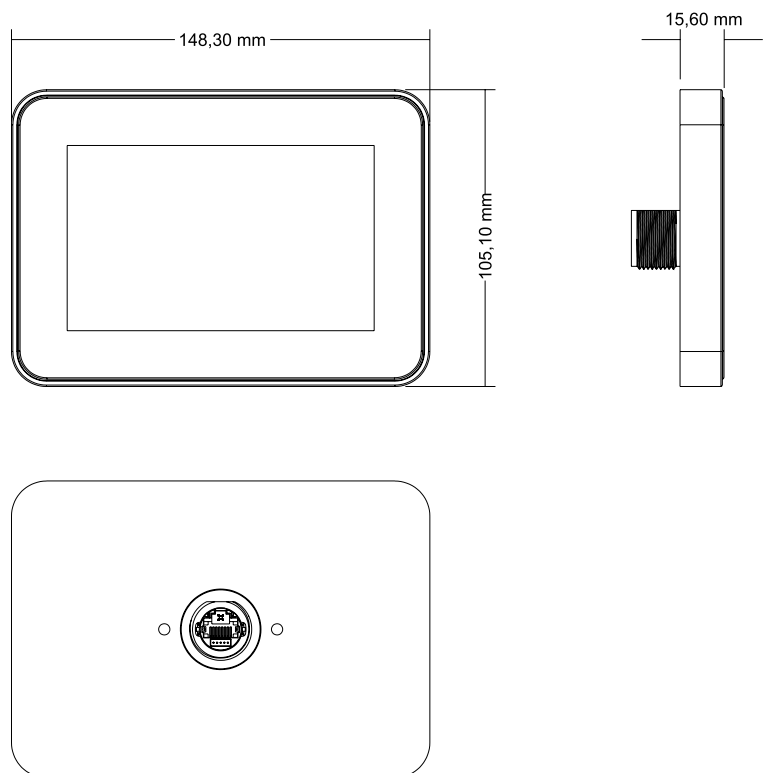

Ordering Information

Model	Part Number	Description
eX705 Field	+EXF705UH2S01	Field-ready HMI 5" TFT with PCAP touchscreen

Technical Data



System Resources	
Display - Colors	7" TFT - 16M
Resolution	1024x600
Brightness	400 cd/m ² typ. (high brightness as option)
Dimming	to 0%
Touchscreen	Projected capacitive - Multitouch
CPU	ARM Cortex-A9 dual core - 800 MHz
Operating System	Linux RT
Flash	4 GB
RAM	1 GB
Real Time Clock, RTC Back-up, Buzzer	Yes, Yes, No
Interface	
Ethernet port	10/100 PoE 802.3af/at
USB port	1 (Host v. 2.0, request special connector)
Serial port	-
SD card	-
Expansion	-
Ratings	
Power supply	802.3af/at
Current Consumption	10 W max
Input Protection	-
Battery	Yes (rechargeable)
Environment Conditions	
Operating Temp	-30° to +60°C
Storage Temp	-30°C to +85°C
Operating / Storage Humidity	5-85% RH, non-condensing
Protection Class	Front: IP67 (requires appropriate connectors and cables)
Dimensions and Weights	
Faceplate LxH	195.2x131.6 mm
Cutout	-
Depth D+T+T	15.6 mm
Weight	0.7 Kg
Approvals	
CE	Emission EN 61000-6-4, Immunity EN 61000-6-2 for installation in industrial environment

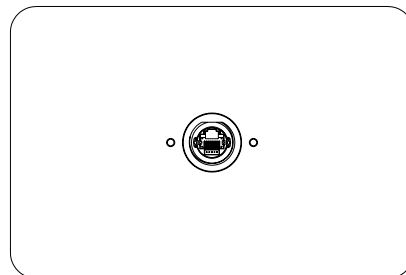
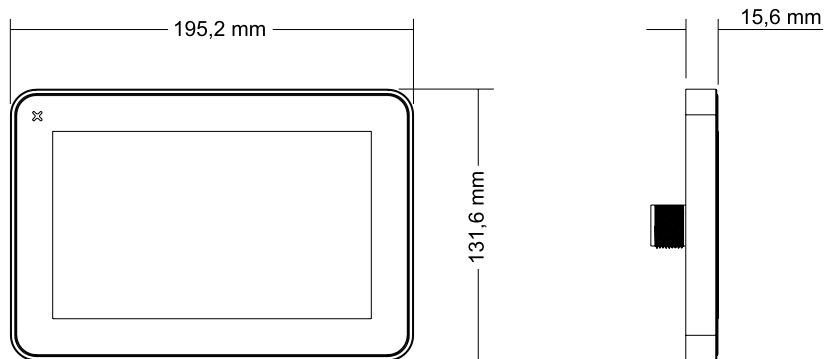

Ordering Information

Model	Part Number	Description
eX707 Field	+EXF707UH1S01	Field-ready HMI 7" TFT with PCAP touchscreen, Ethernet port PoE

Technical Data



System Resources	
Display - Colors	10.1" TFT - 16M
Resolution	1280x800
Brightness	400 cd/m ² typ. (high brightness as option)
Dimming	to 0%
Touchscreen	Projected capacitive - Multitouch
CPU	ARM Cortex-A9 dual core - 800 MHz
Operating System	Linux RT
Flash	4 GB
RAM	1 GB
Real Time Clock, RTC Back-up, Buzzer	Yes, Yes, No
Interface	
Ethernet port	10/100 PoE 802.3af/at
USB port	1 (Host v. 2.0, request special connector)
Serial port	-
SD card	-
Expansion	-
Ratings	
Power supply	802.3af/at
Current Consumption	15 W max
Input Protection	-
Battery	Yes (rechargeable)
Environment Conditions	
Operating Temp	-30° to +60°C
Storage Temp	-30°C to +85°C
Operating / Storage Humidity	5-85% RH, non-condensing
Protection Class	Front: IP67 (requires appropriate connectors and cables)
Dimensions and Weights	
Faceplate LxH	264.5x183.1 mm
Cutout	-
Depth D+T+T	15.6 mm
Weight	1.2 Kg
Approvals	
CE	Emission EN 61000-6-4, Immunity EN 61000-6-2 for installation in industrial environment

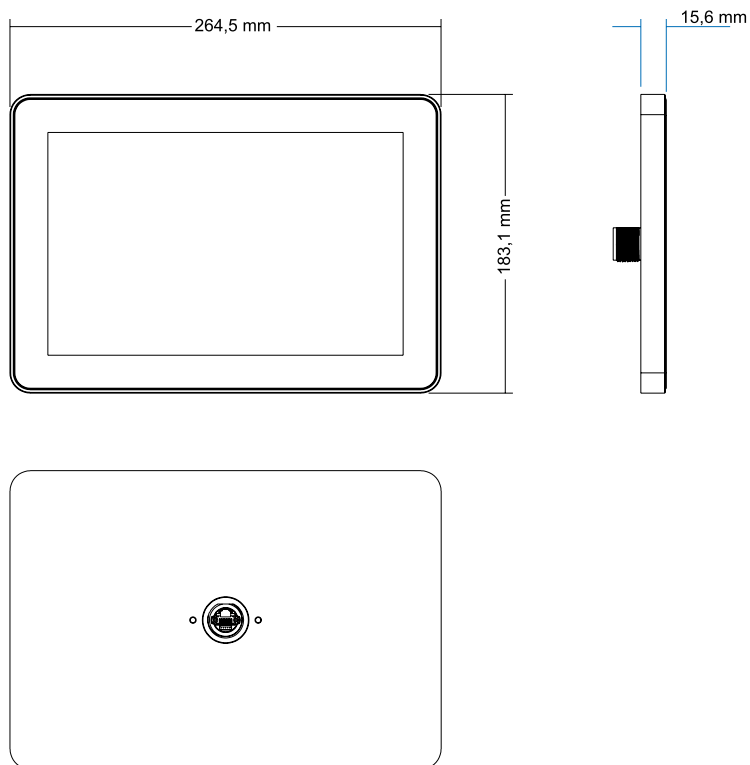

Ordering Information

Model	Part Number	Description
eX710 Field	+EXF710UH1S01	Field-ready HMI 10.1" TFT with PCAP touchscreen, Ethernet port PoE

Technical Data



System Resources	
Display - Colors	15.6" TFT - 16M
Resolution	+EXF715UH1S01: 1366x768 +EXF715UF1S01: 1920x1080
Brightness	400 cd/m ² typ. (high brightness as option)
Dimming	to 0%
Touchscreen	Projected capacitive - Multitouch
CPU	ARM Cortex-A9 quad core - 800 MHz
Operating System	Linux RT
Flash	4 GB
RAM	1 GB
Real Time Clock, RTC Back-up, Buzzer	Yes, Yes, No
Interface	
Ethernet port	10/100 PoE 802.3af/at
USB port	1 (Host v. 2.0, request special connector)
Serial port	-
SD card	-
Expansion	-
Ratings	
Power supply	802.3af/at
Current Consumption	20 W max
Input Protection	-
Battery	Yes (rechargeable)
Environment Conditions	
Operating Temp	-30° to +60°C
Storage Temp	-30°C to +85°C
Operating / Storage Humidity	5-85% RH, non-condensing
Protection Class	Front: IP67 (requires appropriate connectors and cables)
Dimensions and Weights	
Faceplate LxH	398,6x248 mm
Cutout	-
Depth D+T+T	25.5 mm
Weight	4.0 Kg
Approvals	
CE	Emission EN 61000-6-4, Immunity EN 61000-6-2 for installation in industrial environment

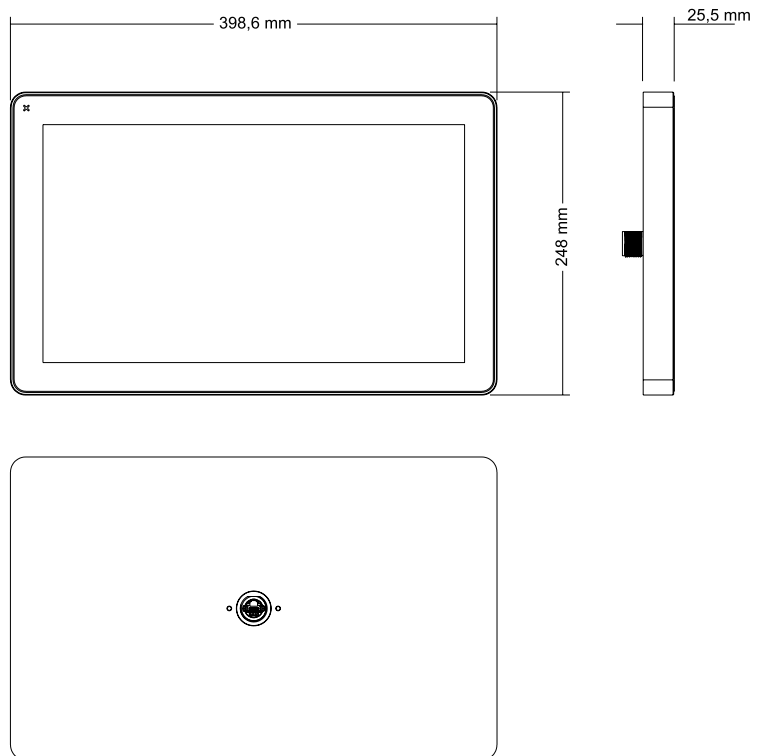

Ordering Information

Model	Part Number	Description
eX715 Field	+EXF715UH1S01	Field-ready HMI 15.6" 1366x768 TFT with PCAP touchscreen, Ethernet port PoE
eX715 Field	+EXF715UF1S01	Field-ready HMI 15.6" 1920x1080 TFT with PCAP touchscreen, Ethernet port PoE

Technical Data



System Resources	
Display - Colors	21.5" TFT - 16M
Resolution	1920x1080
Brightness	400 cd/m² typ. (high brightness as option)
Dimming	to 0%
Touchscreen	Projected capacitive - Multitouch
CPU	ARM Cortex-A9 quad core - 800 MHz
Operating System	Linux RT
Flash	4 GB
RAM	1 GB
Real Time Clock, RTC Back-up, Buzzer	Yes, Yes, No
Interface	
Ethernet port	10/100 PoE 802.3af/at
USB port	1 (Host v. 2.0, request special connector)
Serial port	-
SD card	-
Expansion	-
Ratings	
Power supply	802.3af/at
Current Consumption	20 W max to be confirmed
Input Protection	-
Battery	Yes (rechargeable)
Environment Conditions	
Operating Temp	-30° to +60° C
Storage Temp	-30° to +85° C
Operating / Storage Humidity	5-85% RH, non-condensing
Protection Class	Front: IP67 (requires appropriate connectors and cables)
Dimensions and Weights	
Faceplate LxH	534,1x325,6 mm
Cutout	-
Depth D+T+T	25.1 mm
Weight	6.0 Kg to be confirmed
Approvals	
CE	Emission EN 61000-6-4, Immunity EN 61000-6-2 for installation in industrial environment

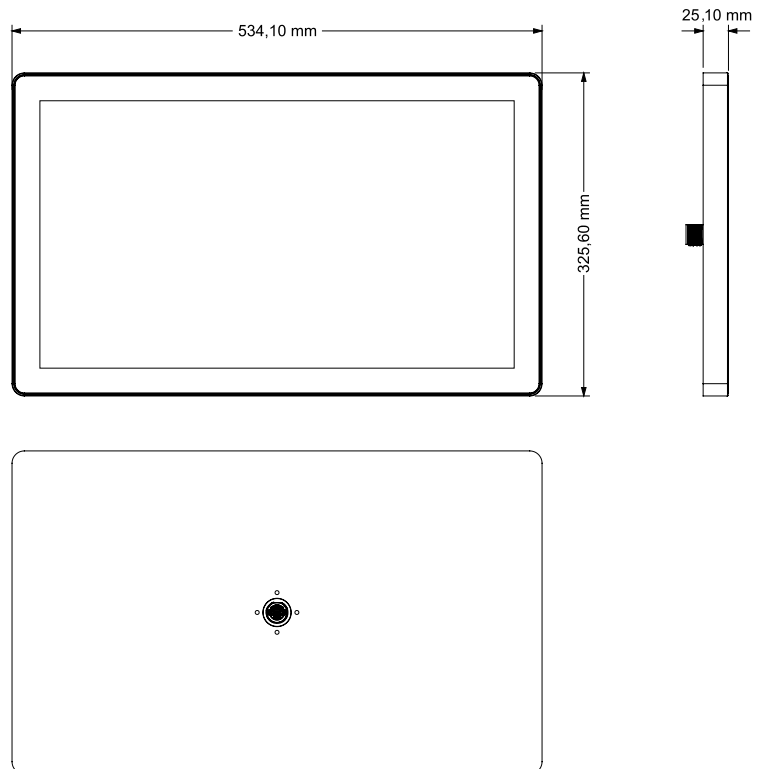

Ordering Information

Model	Part Number	Description
eX721 Field	To be defined	Field-ready HMI 21.5" 1920x1080 TFT with PCAP touchscreen, Ethernet port PoE

IPC Products for PC-based automation



Key Features

EXOR International offers a complete range of fanless computers dedicated to automation.

All products are available in wide and flexible range of configurations. You will have the product that fit your needs.

All products have a robust mechanical construction that will suit the most demanding applications.

The catalog includes a wide choice of:

- Panel PC
- Box PC
- Panel Monitor

Products can be configured with different choice of CPU, RAM, disk and operating systems.

PC offered by EXOR International are the ideal platform for running applications based on JMobile PC Runtime.

An application integrating HMI on a powerful hardware platform is ready in all cases where the embedded HMIs do not meet all requirements.

You will find detailed and up-to-date information on PC products in our web site: www.exorint.com

