

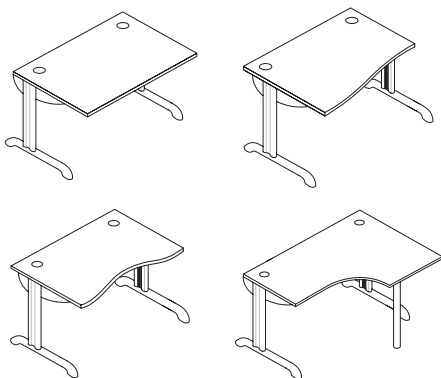

solo desks datasheet & environmental report

Extent of Range

Fixed height stand alone desk



Delivery

This range is assembled on site by the Flexiform installation team, wrapped for protection.

Product Warranty

10 years from installation.

Features

Type: Single fixed height freestanding desk.

Frame: Folded steel modesty panel.

Legs: Cantilever leg constructed from tubular steel and folded profiles.

Tops: MFC fixed top with porthole to feed cables.

Screens: Clamps to desktop. Screens are not included.

Components: Cable tray.

Dimensions

Height: 720mm.

Widths: 800mm, 1000mm, 1200mm, 1400mm, 1600mm and 1800mm.

Depth: Rectangular top: 800mm, workstation top: 1200mm, single wave top: 1000mm, double wave top: 900mm.







Materials

MFC Top Panels: 25mm melamine faced chipboard (M.F.C) with 2mm ABS matching edging or contrasting edging. British standard 476 class 1 surface spread of flame. Meets E1 European standards on Formaldehyde emissions.

Steel: Powder coated steel with minimum paint coverage thickness of 35 Microns. Indentation, cross cut+adhesion and bend tested.











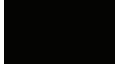
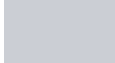

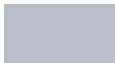





MFC Finishes

Standard Flexiform finishes. Additional colour options available (may incur an upcharge).

	White 25mm MFC with matching edge. Code: WHM
	Grey 25mm MFC with matching edge. Code: MOG
	Oak 25mm MFC with matching edge. Code: MOK
	Beech 25mm MFC with matching edge. Code: MOB
	Romano Cherry 25mm MFC with matching edge. Code: RCM
	Maple 25mm MFC with matching edge. Code: MOM
	Walnut 25mm MFC with matching edge. Code: MOW
	White 25mm MFC with contrasting oak edge. Code: WHO
	White 25mm MFC with contrasting multiplex edge. Code: WHX

Steel Finishes

Standard Flexiform finishes. Additional colour options available (may incur an upcharge).

	Black. RAL9011 Code: BLS
	Silver. RAL9006 Code: JOS
	Graphite Grey. RAL7024 Code: GGS
	Pale Grey. RAL7035 Code: PGS
	White. RAL9016 Code: JWS
	Arrow Red. RAL3001 Code: ARG
	Carmine Red. RAL3002 Code: CRS
	Deep Orange. RAL2011 Code: ORS
	Zinc Yellow. RAL1018 Code: ZYS
	Fern Green. RAL6018 Code: FGB
	Water Blue. RAL5021 Code: WBS
	Sky Blue. RAL5015 Code: SBB
	Ultramarine Blue. RAL5002 Code: UBS
	Signal Blue. RAL5005 Code: SBS
	Regal Blue. RAL5012. Code: RBS
	Pastel Mauve. RAL4009. Code: PMS
	Pastel Turquoise. RAL6034. Code: PTS
	Tauben Blue. RAL5014. Code: TGS
	Khaki Green. RAL6013. Code: KGS

Product Carbon Footprint

Our carbon footprint data is based on a life cycle assessment on a 1400mm x 800mm Solo desk. Product weight: 34.7kg. Information extracted from report 'Product Carbon Footprint and Environmental Impact Assessments' prepared by Eco3, 2017.

Carbon Footprint: 45Kg CO_{2e}.

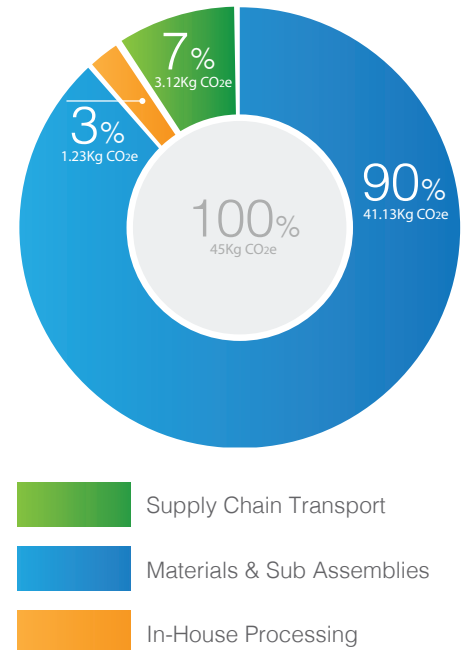

Product Environmental Certification



Product Certification

BS EN 527 - 1 2011 Type C and BS EN ISO 9241:1999 - Part 5

flexiform