

AQUACUT

Quattro

USA

Fluid Abrasion Unit

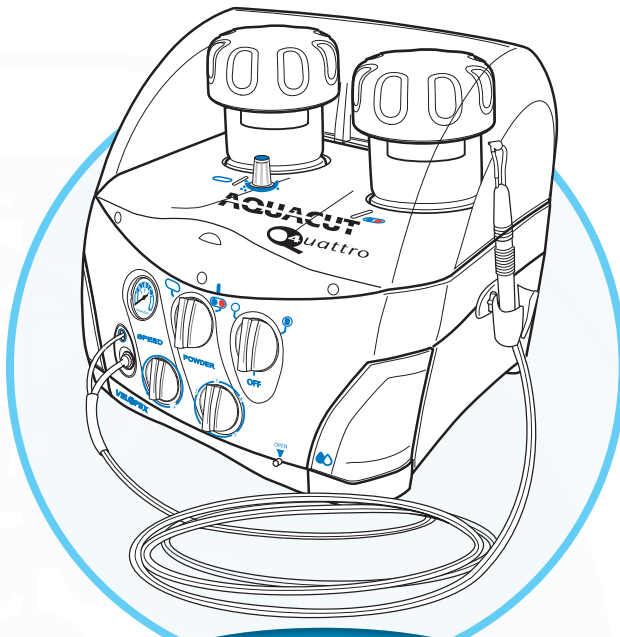

AA007000+

Installation, Operation Maintenance and Service Manual

WARNING:

Do not connect to the air supply
before reading this manual.

USA Aquacut Quattro
Technical Manual Iss. 9

I/LIT0021P Issued 03/06/2014

Indications For Use and Contraindications

Indications For Use

The Aquacut Quattro can be used for:

- preparation for pit and fissure sealants.
- removal of composites for restoration.
- cavity preparation.
- cleaning, polishing and stain removal.
- etching.

Contraindications For Use

The Aquacut Quattro is not intended for removal of scaling or calculus.
The Aquacut Quattro is not intended for cutting or removal of amalgam.

WARNING: Special consideration must be given to the use of the Aquacut Quattro on patients who have:

- | | |
|--|-----------|
| 1. Respiratory difficulties | 2. Asthma |
| 3. Blocked nasal passages | 4. A cold |
| 5. Restricted sodium diet | |
| 6. Any other medical problem that may prevent the patient from breathing through the nose. | |

Any patient suffering from any of the above conditions should contact their physician before having treatment with the Aquacut Quattro.

Please refer to INTRODUCTION: SAFETY WARNINGS, Pg 5, and read these safety notes carefully before attempting to use the machine.

It is strongly recommended that initial training is carried out on glass slides and extracted teeth before patient treatment with the Aquacut Quattro is attempted.

INTRODUCTION	PAGE
INDICATIONS FOR USE AND CONTRAINDICATIONS	2
CONTENTS	3
SAFETY WARNINGS	5
TABLE OF SYMBOLS	7
TECHNICAL DESCRIPTION	8
CONTENTS OF THE PACKAGING	9
AQUACUT PARTS AND FEATURES	
EXTERNAL AQUACUT QUATTRO FEATURES	10
REAR VIEW OF AQUACUT QUATTRO	11
FOOT PEDAL	11
HANDPIECE	12
POWDER CARTRIDGES	13
INSTALLATION	
SITING THE AQUACUT QUATTRO	14
ATTACHING THE FOOT PEDAL	15
FILLING THE FLUID TANK	15
ASSEMBLING THE HANDPIECE	17
FITTING THE DISPOSABLE FEEDLINE AND TIP	17
CONNECTING THE AIR SUPPLY	18
INSTALLATION TEST	19
REMOVING THE DOSING CHAMBER LIDS	20
INSERTING THE POWDER CARTRIDGES	20
PREPARING THE AQUACUT QUATTRO FOR FIRST USE	22

OPERATION

FIRST STEPS TO MASTERING THE AQUACUT QUATTRO	23
SUGGESTED TREATMENT METHODS	24
PREPARATIONS BEFORE TREATMENT	25
TREATMENTS	26
- Cleaning.	
- Fissure Caries.	
- Cavity Preparation.	
- Removal of Composite Restorations.	
- Bonding Orthodontic Brackets.	

MAINTENANCE

STERILISING THE HANDPIECE	31
HANDPIECE MAINTENANCE	32
TWIN TUBE ASSEMBLY MAINTENANCE	32
PURGING THE AQUACUT QUATTRO	33
CLEANING THE AQUACUT QUATTRO	34

SERVICE

INTERNAL VIEW OF THE AQUACUT QUATTRO	35
INTERNAL FILTER ASSEMBLY	36
CONTROL BLOCK	37
ANNUAL SERVICE CHECKS	38
REPLACING THE POWDER PINCH TUBE	38
REPLACING THE AIR FILTERS	39
TEST PROCEDURE	40
TROUBLESHOOTING	41
RECOMMENDED ACCESSORIES	44

ATTENTION- Please read all the following important warnings before using the Aquacut Quattro:

Only qualified dentists and dental hygienists should use the Aquacut Quattro on patients.

Before using the Aquacut Quattro:

- a) Read the manual thoroughly.
- b) Make sure the operator of the unit, any assistants, the patient, and anyone else in the room wear eye protection to BS EN 166 IF 4/5.
- c) Make sure the operator of the unit, any assistants, and anyone else in the room, except the patient, wear respiratory masks to BS EN 149 FF2S.
- d) Make sure you are in full control of the handpiece, and are aiming the handpiece nozzle in a safe direction.
- e) Make sure you have selected the correct powder for the treatment you are performing. **Incorrect selection of powder can cause hard tissue damage.**
- f) Use a high speed intra-oral aspirator during treatment. An extra-oral aspirator can be used in addition if desired.
- e) Ensure machine has adjusted to room temperature ($>15^{\circ}\text{C}$) before operating if coming from a cold environment

Patients should consult their physician before having treatment with the Aquacut Quattro if they have:

- a) Respiratory difficulties
- b) Asthma
- c) Blocked nasal passages
- d) A cold
- e) A restricted sodium diet
- f) Any other medical problem preventing breathing through the nose.

ALWAYS AIM TOWARDS THE INCISAL EDGE OF THE TOOTH.

The Aquacut Quattro may cause soft tissue damage, including inflammation, bleeding, and creation of an air embolism. The Aquacut Quattro may cause hard tissue damage, including etching or abrasion of enamel or exposed root surfaces of the teeth.

The disposable feedline and tip should be changed for each patient treatment to prevent cross-contamination. Ensure that new tips are fitted firmly onto the nozzle. Used feedlines and tips should be discarded. Attempts to reuse the Aquacut Quattro feedlines and tips, or to use them with any other micro abrasion machines could be hazardous.

Safety Warnings

In most cases the plastic tip should last long enough for one treatment. However, during prolonged treatments the tip may need replacing to prevent erratic flow of fluid.

Do not use the handpiece if the hole in the tip of the nozzle has worn to the outer edge, or if the swan neck tube has been perforated.

Sterilise the handpiece before first use and between each patient treatment.

The Aquacut Quattro should never be connected to a running water supply as this will flood the machine. Fluid is supplied to the unit via the fluid tank.

All powders supplied by Velopex are sterile until opened, and the containers are not reusable.

The powder lines and handpiece should be purged/primed each time you switch between the powder chambers using the powder selector dial (See MAINTENANCE: PURGING THE AQUACUT, Pg 33).

The Aquacut Quattro produces fine powder dust when in use. Protect sensitive equipment from this dust.

Only use parts and consumables supplied by Velopex. Non-Velopex products may damage the unit or alter the performance.

Site the foot pedal carefully so it cannot be operated by accident. Always close the foot pedal safety cover when not in use. Accidental operation can cause a uncontrolled and dangerous high pressure stream of abrasive powder.

Do not place the unit in direct sunlight.

When turning the Aquacut Quattro on and off, ensure that the nozzle is aimed into the inlet of your evacuation unit, and that the evacuation unit is switched on.





When turning the Aquacut Quattro off, wait for the machine to depressurise before attempting to remove the dosing chamber lids. Depressurising takes roughly 30 seconds.

Safety Warnings

When performing maintenance tasks, remove all powder cartridges before opening the service compartment.

If the Aquacut Quattro is dropped or otherwise damaged, it must not be used until it has been inspected by a Velopex Representative or Authorised Distributer.

If the Aquacut Quattro ceases to operate correctly, or if you experience a deterioration in performance, see SERVICE:TROUBLESHOOTING, Pg41.

SYMBOL	
OFF	Air Supply Off
I	Air Supply On
II	Secondary Gas Supply On
	Left Powder Select
	Right Powder Select
I—5	Powder Flow Volume Control
- - +	Cutting Speed Volume Control
	Fluid Supply Tank
	Pressure Gauge - A: 2 to 3.5 bar - B: 4 to 5 bar - C: 6 to 7 bar
	Fluid Volume Control

AIR SUPPLY REQUIREMENTS

Clean dry air to ISO 8573 Class 1.4.1. Pressure between 5 bar (72psi) and 7 bar (100psi). Maximum flow rate +70 l/min. 4mm O/D input connection

Technical Description

READ THIS MANUAL FULLY BEFORE ATTEMPTING TO INSTALL OR USE THE AQUACUT QUATTRO MACHINE.

The Aquacut Quattro is a fluid abrasion unit which cuts by emitting a stream of air, fluid and powder from its handpiece. It can be loaded with up to two different powders for use in cutting and cleaning operations. The only supply the unit requires is clean, dry air of 5-7 bar which conforms to **ISO 8573.1 class 1.4.1**. The incoming air to the Aquacut Quattro is internally regulated to 7 bar. The Aquacut Quattro is operated by pressing the foot pedal in three modes: Dry, Wash and Cut/Clean. The air supply, speed, powder chamber, powder volume, and fluid volume can all be adjusted using the five controls available. The handpiece can be removed from the airline for sterilisation.

The overall dimensions of the AQUACUT QUATTRO are:

Width	250mm
Height	240mm
Depth	230mm
Net weight	7.5kgs

The AQUACUT QUATTRO is a class IIa medical device.

TYPICAL CUTTING PERFORMANCE THROUGH IMM OF GLASS.

0.5mm Dia nozzle, 29 micron aluminium oxide.

Speed A, Powder volume 1-2:	10 seconds.
Speed C, Powder volume 4-5:	5 seconds.

0.6mm Dia nozzle, 53 micron aluminium oxide.

Speed A, Powder volume 1-2:	6 seconds.
Speed C, Powder volume 4-5:	2 seconds.

0.8mm Dia nozzle, 53 micron aluminium oxide.

Speed A, Powder volume 1-2:	3 seconds
Speed C, Powder volume 4-5:	1.5 seconds

ENVIRONMENTAL CONDITIONS FOR TRANSPORT AND STORAGE.

The AQUACUT QUATTRO should be kept within the Temperature range -10°C and $+40^{\circ}\text{C}$ (14°F and 104°F) and below 80% humidity.

Contents Of The Packaging

- A. 1 x Aquacut Quattro fluid abrasion unit.
- B. 1 x Three-position foot pedal.
- C. 1 x Silver 0.6mm handpiece.
- D. 1 x Gold 0.8mm handpiece.
- E. 1 x Quick release twin feed tube assembly.
- F. 1 x 500ml Aquacut Quattro Cleaning/Cutting Fluid.
- G. 2 x Cartridge of gamma irradiated aluminium oxide, 53 micron (Red).
- H. 2 x Cartridge of gamma irradiated aluminium oxide. 29 micron (Blue).
- I. 1 x Cartridge of gamma irradiated fine granular sodium bicarbonate(Clear).
- J. 1 x Cartridge of gamma irradiated Sylc for Aquacut(Green)
- K. 1 x Quick Start Guide
- L. 1 x Pack of 5 glass slides.
- M. 1 x Nozzle cleaning wire.
- N. 1 x 2 metre length 4mm air input hose.
- O. 1 x Powder storage pot.
- P. 1 x Pack of 50 disposable feedlines.
- Q. 1 x Pack of 50 disposable tips.
- R. 1 x Pack of 5 spare handpiece parts.
- S. 1 x Tube removal tool.

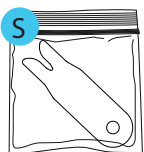
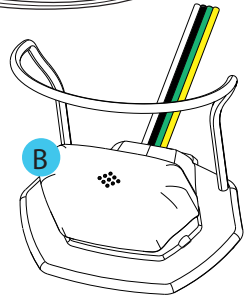
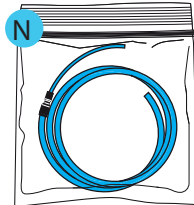
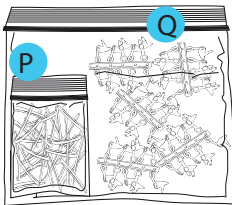
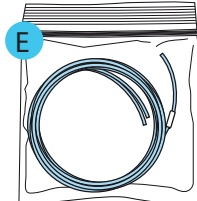
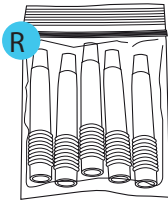
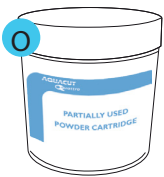
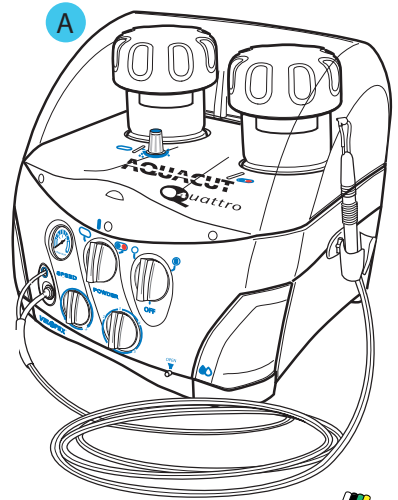

External Aquacut Quattro Features

1. Compartment Release Button.
2. On/Off Selector.
3. Powder Volume Control.
4. Powder Selector.
5. Air Speed Control.
6. Powder Out Connector.
7. Fluid Out Connector.
8. Air Speed Gauge.
9. Handpiece Storage Tank.
10. Foot Pedal.
11. Foot Pedal Lifting Arch.
12. Fluid Volume Control.
13. Left Dosing Chamber.
14. Left Dosing Chamber Lid.
15. Protective Cover.
16. Right Dosing Chamber Lid.
17. Right Dosing Chamber.
18. Handpiece.
19. Handpiece Holder.
20. Fluid Tank.

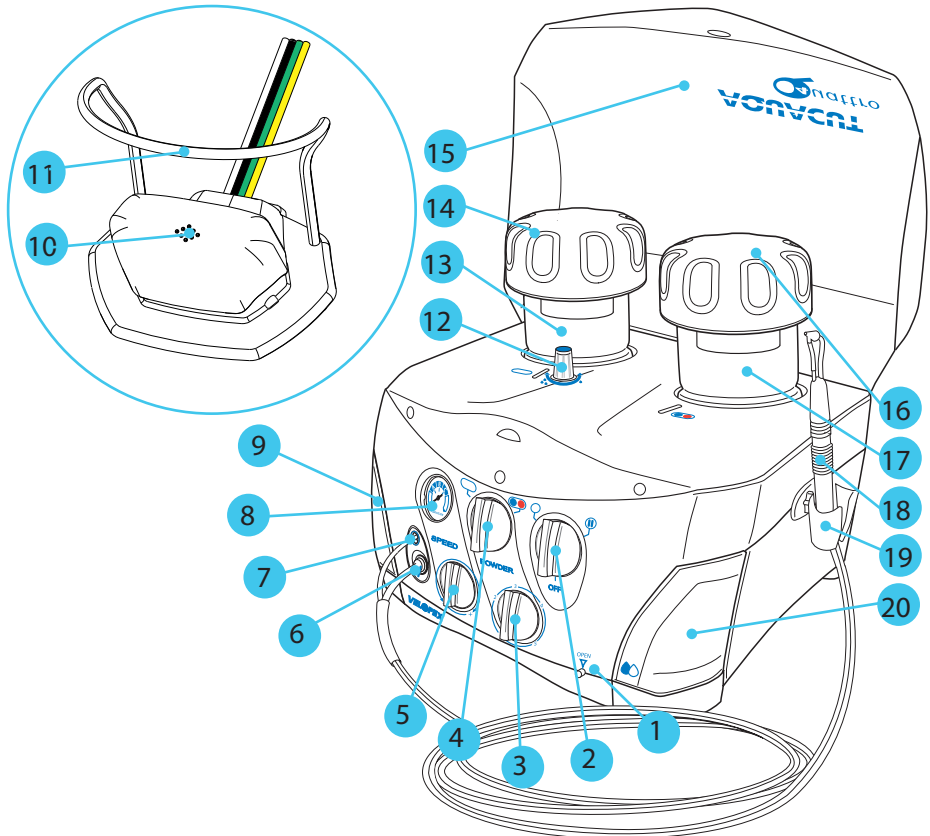

Rear View Of Aquacut Quattro

- 21. Foot Pedal Connection (White).
- 22. Foot Pedal Connection (Black).
- 23. Foot Pedal Connection (Green).
- 24. Foot Pedal Connection (Yellow).
- 25. Main Air Connection (Blue).
- 26. Secondary Gas Supply (Not used at this time).
- 27. Blanking Plug

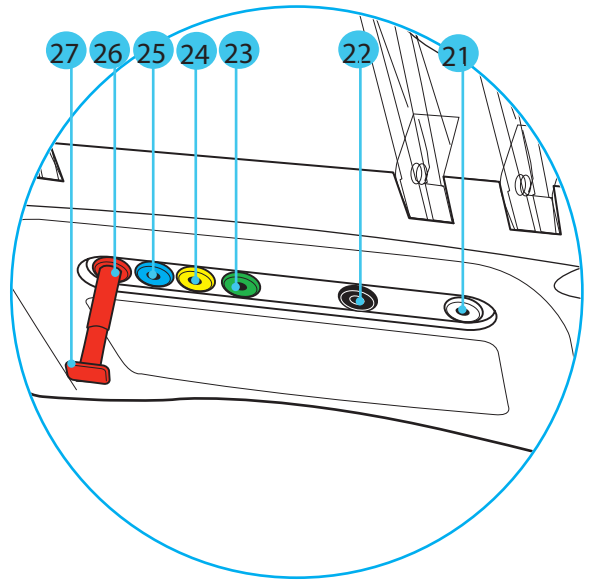

Foot Pedal

10. Foot Pedal

- Position 1: Air (Dry)
- Position 2: Fluid & Air (Wash)
- Position 3: Powder & Fluid & Air (Cut/Polish)

11. Foot Pedal Lifting Arch.

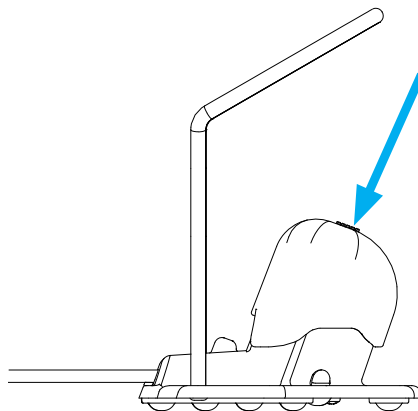
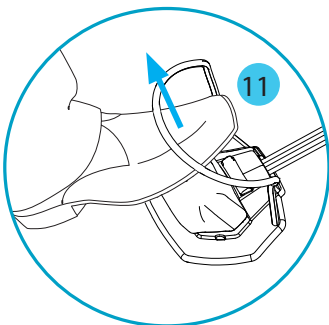

Handpiece



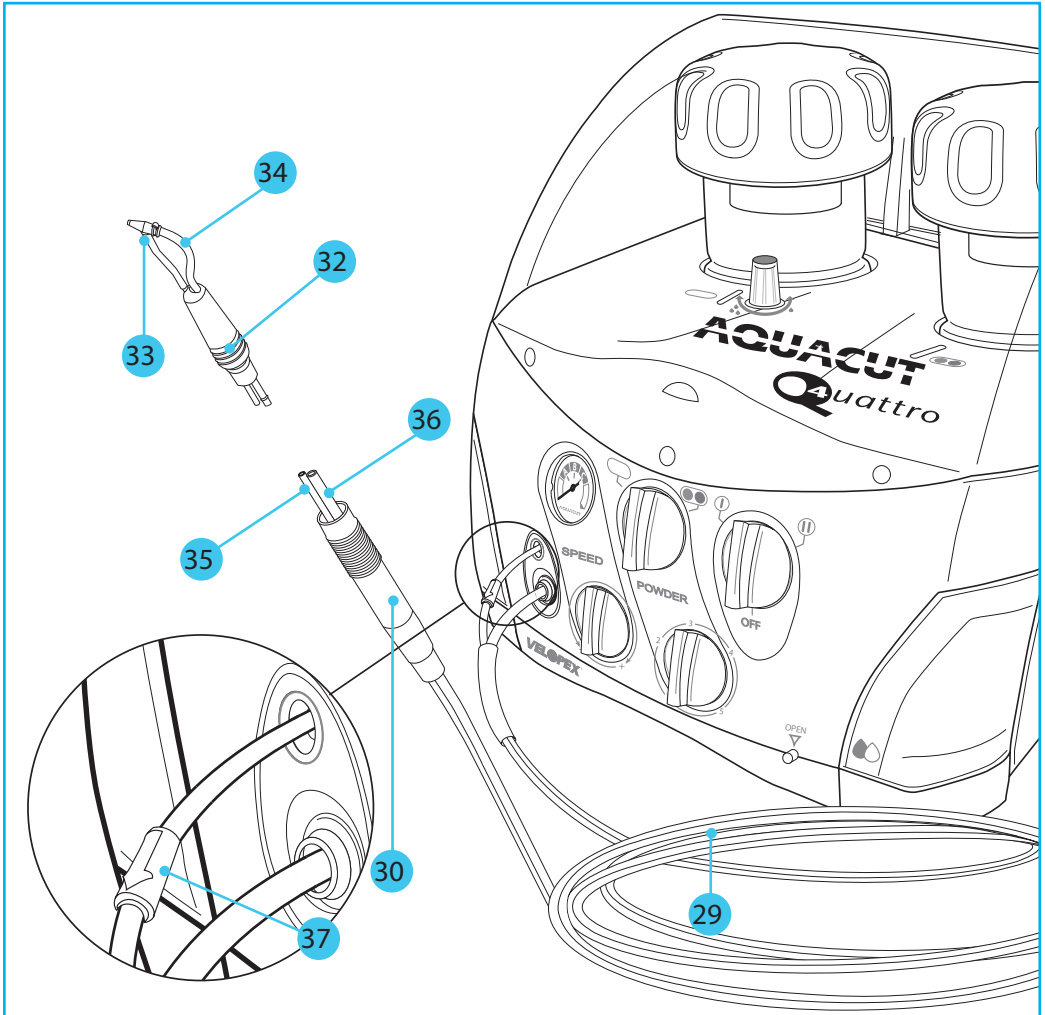



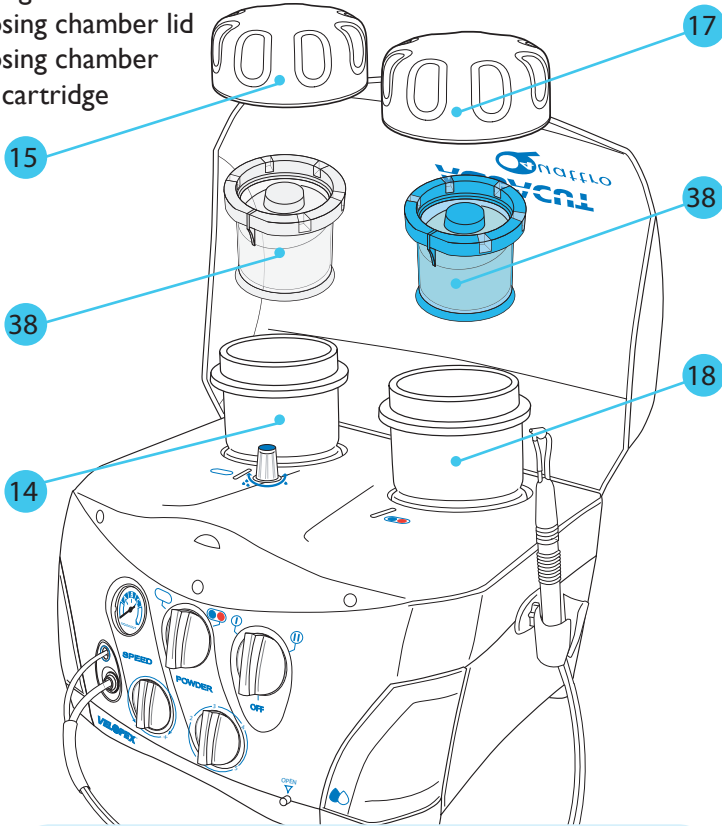

- 29. Twin Tube
- 30. Handle
- 31. Cotter
- 32. Hand Grip
- 33. Feedline and Tip
- 34. Nozzle
- 35. Fluid Connection
- 36. Powder Connection
- 37. Check Valve



Powder Cartridges

- 14. Left dosing chamber
- 15. Left dosing chamber lid
- 17. Right dosing chamber lid
- 18. Right dosing chamber
- 38. Powder cartridge



	Sodium bicarbonate	Cleaning – polishing	Left powder chamber 
	Sylc	Cleaning – polishing	Left powder chamber 
	29 micron aluminium oxide	Cutting – cavity preparation and composite preparation	Right powder chamber 
	53 micron aluminium oxide		Right powder chamber 

Siting The Aquacut Quattro

Remove the Aquacut Quattro from its box and recycle the packaging.

If you are using the Aquacut Quattro with the Velopex Patient Treatment Centre, place the machine on the top shelf of the trolley, following the instructions received with the trolley. See SERVICE:RECOMMENDED ACCESSORIES, Pg44.

If you do not have a specialised trolley, place the machine securely on a **rigid, sturdy desk** or table top.

Do not place the machine close to, or allow it to hang over, the edge of the table top. The machine is designed to have all the controls within easy reach of the dentist when situated in this way.

The unit should be kept within a temperature range of +15°C and +40°C, and should also be kept below 80% humidity.

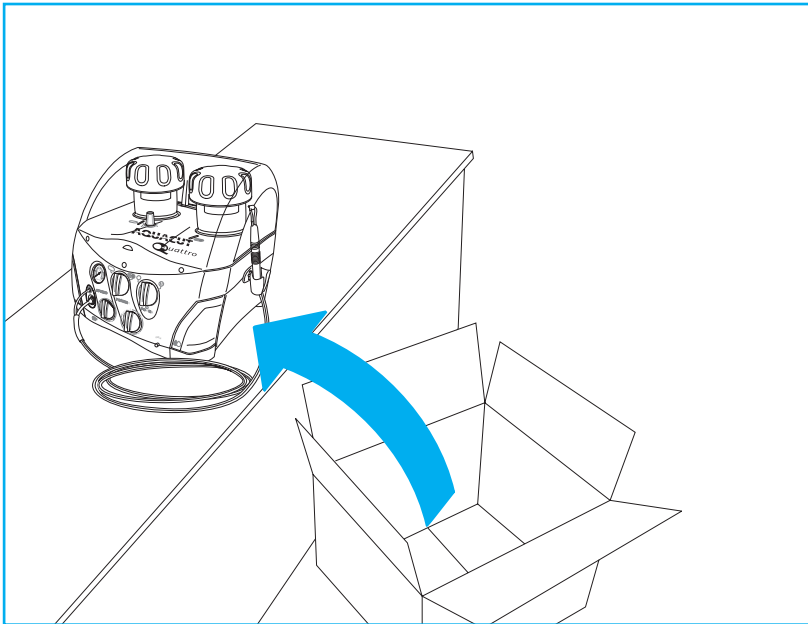

Attaching The Foot Pedal

WARNING: Accidental operation of the foot pedal can be hazardous. To avoid this, make sure the foot pedal cover is always shut when the foot pedal is not in use.

- A) See PARTS AND FEATURES: FOOT PEDAL, Pg | I. Place the foot pedal on the floor near the machine and within easy reach of the dentist.
- B) Connect the foot pedal to the back of the machine by pushing each coloured tube into its colour-corresponding connector.

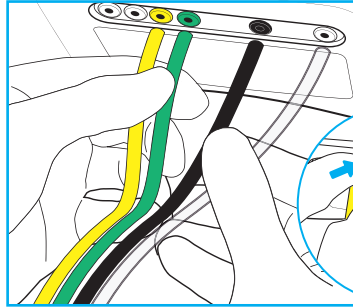
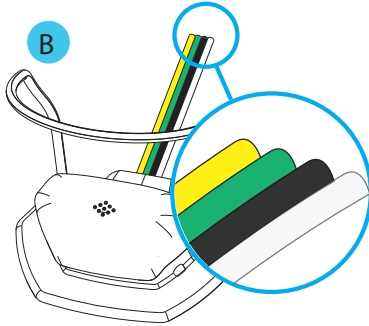

TIP: To disconnect, push the coloured connector in to the machine, and gently pull the tube out.

Filling The Fluid Tank

A, B, C) Press the compartment release button to open the service compartment. The top of the machine will swing upwards slightly. This allows access to the fluid tank.

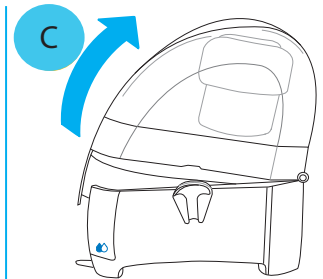
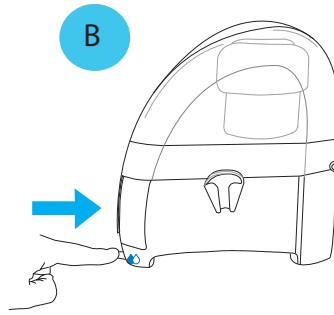
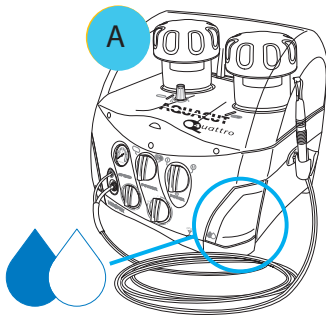

Filling The Fluid Tank

D) Open fluid compartment.

E, F, G) Peel back the lid and fill with the supplied 500ml Aquacut Quattro Cleaning/Cutting Fluid. Do not overfill. Replace the lid.

H) Slide the fluid tank back into the service compartment. **NOTE:** Ensure that the fluid tube is correctly inserted through the fluid tank lid as shown below. Close the fluid compartment.

I) Close the machine, press down on the top of the machine until it click shut.

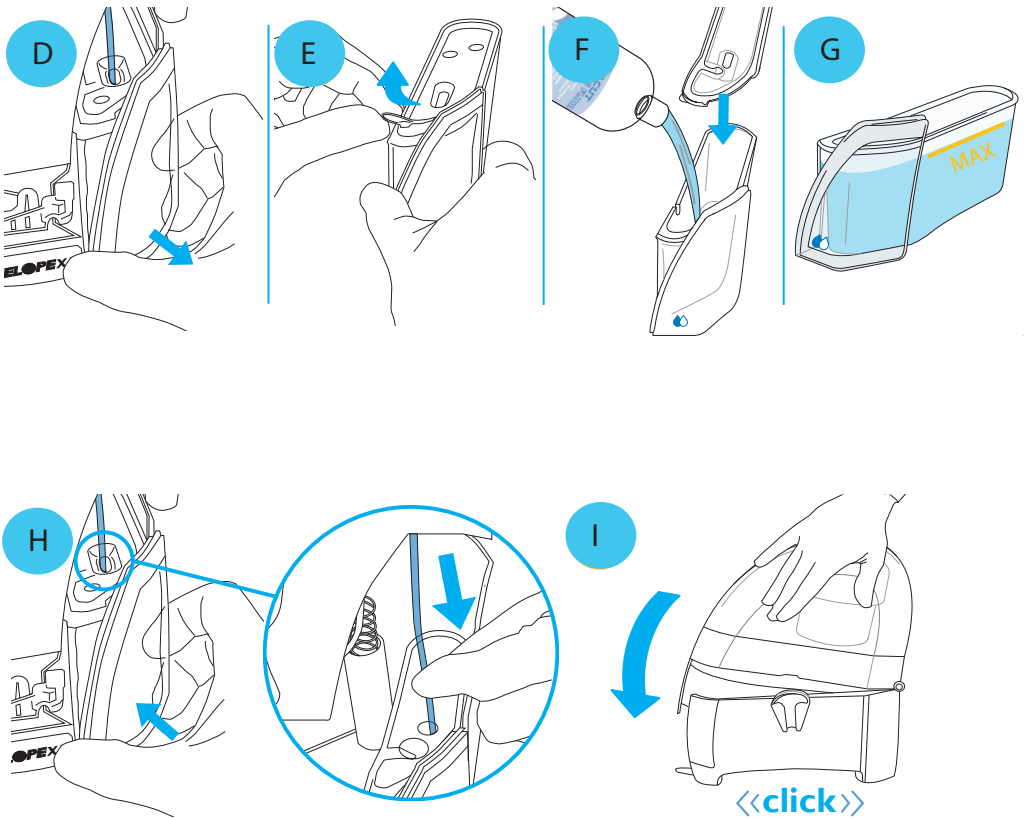

Assembling The Handpiece

- A) See PARTS AND FEATURES: HANDPIECE, Pg 12. Slide the handpiece handle onto the twin tube. This goes at the end of the tube without a check valve.
- B) Push the twin tubes firmly onto the nozzle tubes. The small twin tube pushes onto the small nozzle tube, and the large twin tube pushes onto the large nozzle tube. Make sure the tubes are securely in place.
- C) Slide the handle onto the handpiece until it is securely in place.
- D) Push the free end of the smaller twin tube into the powder out connector on the machine
- E) Push the free end of the larger twin tube into the fluid out connector on the machine.

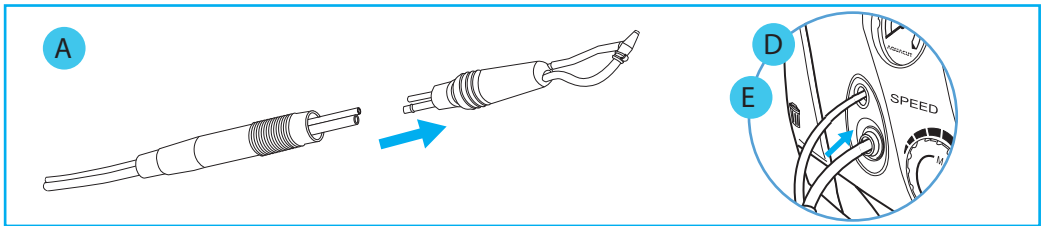

The handpiece should be sterilised before use and between each subsequent use. See MAINTENANCE: STERILISING THE HANDPIECE, Pg 31.

Fitting The Disposable Feedline And Tip

- A) Take a new tip and fold over the locking tab as shown.
- B) Push the tip onto the nozzle until firmly engaged.
- C) Rotate the tip so that the free end points toward the handpiece
- D) Push one end of the feedline onto the end of the handpiece.
- E) Push the other end of the feedline onto the tip.

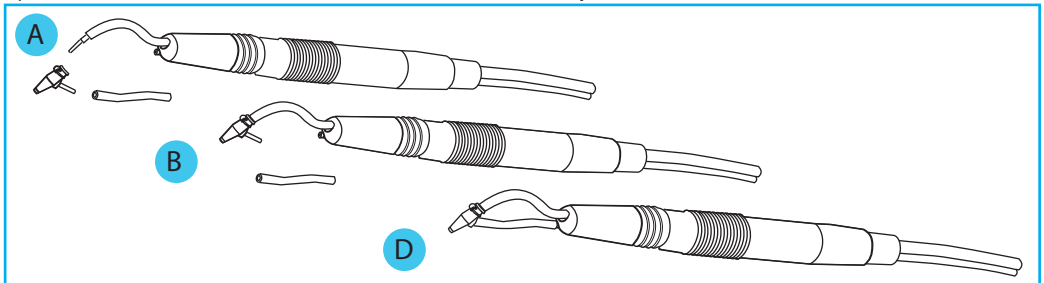
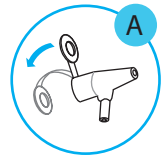

The tips and feedlines are for one time use only, and a new tip and feedline should be used for each patient. To switch tips and feedlines, remove the existing feedline and tip and discard. Then follow the steps above. Purge the fluid through the system (See MAINTENANCE: PURGING THE AQUACUT QUATTRO, Pg 33).

Connecting To The Air Supply

See PARTS AND FEATURES: REAR VIEW OF THE AQUACUT QUATTRO, Pg 11. The Aquacut Quattro needs a supply of clean, dry, breathing quality air of 5-7 bar to ISO 8573.1 class 1.4.1. The practice's existing air supply system/compressor can be used provided fitted with a water removing filter and shut-off valve in the supply line.

- A) Connect the blue air supply tube to the machine by pushing it fully into the blue connector.
- B) The red connector can be used to connect to a secondary gas supply.

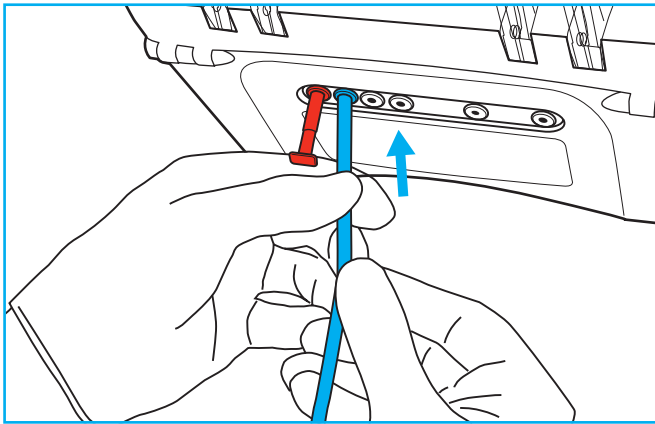

If you wish to connect a secondary gas, please contact Velopex for advice before proceeding. Currently we recommend using a blanking plug when the secondary supply is not in use.

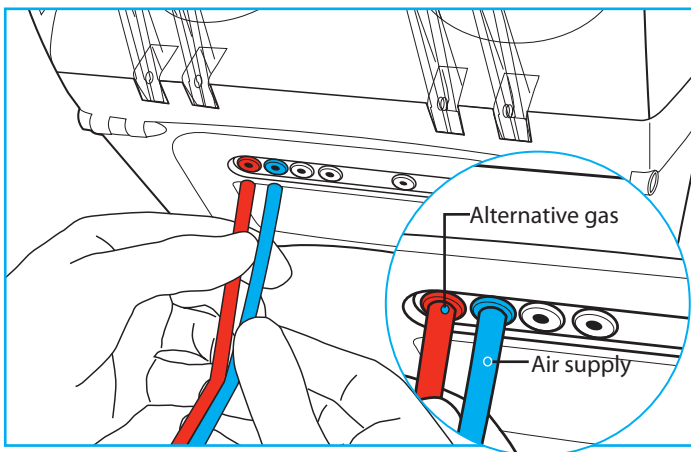

Installation Test

Before adding the powder to complete installation of the Aquacut Quattro, you can check that the installation has been performed correctly using the following procedure:

- A) Check that the machine is off.
- B) Sterilise the handpiece. Refer to MAINTENANCE: STERILISING THE HANDPIECE, Pg 31.
- C) Fit the 0.6mm silver handpiece to the machine. Fit a new disposable feedline and tip.
- E) Check that the fluid tank has been filled.
- G) Make sure you are in full control of the handpiece before turning the machine on.
- H) Switch the On/Off selector to position I.
- I) Press the foot pedal down to the DRY position (See PARTS AND FEATURES: FOOT PEDAL, Pg 11). Check that air comes out of the nozzle. There should be no fluid or powder.
- J) Press the foot pedal down to the WASH position. Check that you can see water being drawn up the fluid tube. After a few seconds you should observe the flow of air change to a fine mist.
- K) Turn the Fluid volume dial, observing the spray. Place a paper towel under the nozzle at a distance of 25-30mm to make the effect easier to see. The Fluid volume range varies between:
 - DROPLET - Small quantity of water. Very fine mist.
 - SPRAY - Larger quantity of water. Heavier spray.
- L) Press the foot pedal fully down to the CUT position. You should hear the vibrator start to operate. The nozzle will continue to spray a mixture of fluid and water, but no powder as this has not yet been installed.
- M) Turn the Speed dial, observing the Speed gauge. The speed range is:
 - A - Low energy, gentle cleaning/polishing action.
 - B - Medium energy, medium cutting action.
 - C - High energy, very fast cutting action.
- N) Switch the machine off.

If your observations do not match the procedure above, check that all INSTALLATION sections have been completed correctly. If installation problems continue to occur, contact a Velopex Representative or Authorised Distributor for assistance.

Removing The Dosing Chamber Lids

- A) Ensure the unit is turned off and fully depressurised. If the machine has been ON recently, allow 30 seconds for depressurising before attempting to remove the lids.
- B) Unscrew the dosing chamber lids anti-clockwise 2/3 of a turn to relieve the pressure. Then unscrew a further turn and lift off.
- C) Close the dosing chamber by turning lids clockwise. Turn firmly until a strong resistance is felt from the seal engaging with the top of the chamber. Continue to turn the lid until you feel the lid tighten against a stop. **Always make sure the lids are fully closed before pressurising the machine.**

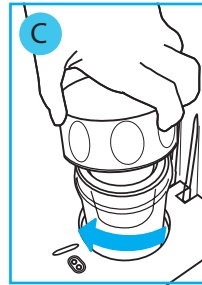
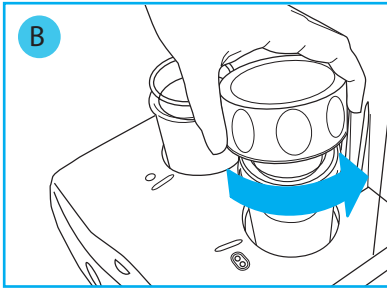

Inserting The Powder Cartridges

- A) See PARTS AND FEATURES: POWDER CARTRIDGES, Pg 13. Refer to the table at the bottom to make sure that you fit the correct powder cartridge in the correct chamber.
- B) Peel away the yellow sealing tab on the cartridge.
- C) Pull out the yellow draw tab on the cartridge.

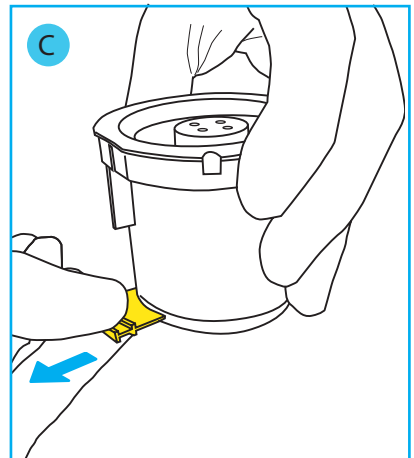
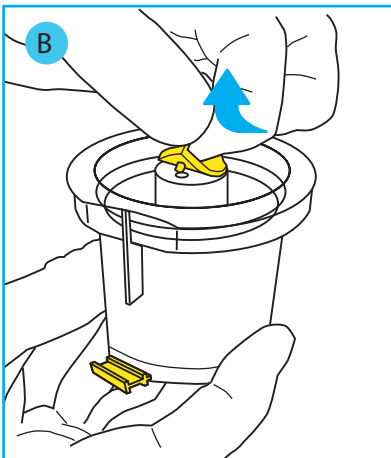

Inserting The Powder Cartridges

- D) Line up the rib on the outside of the powder cartridge with the slot on the inside of the dosing chamber.
- E) Slide the powder cartridge down into the dosing chamber until it sits comfortably inside.
- F) If the cartridge sits unevenly or above the top of the dosing chamber, then lift it out and re-insert. Check that the rib of the powder cartridge slides down the slot in the dosing chamber.
- G) Close the dosing chamber lid.

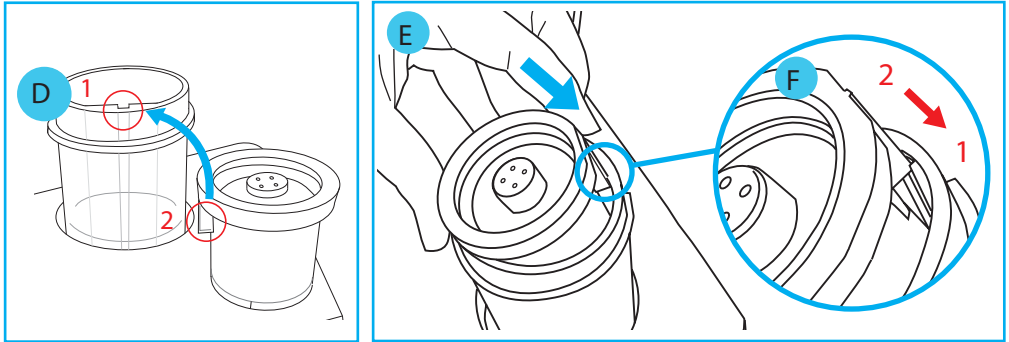

- H) To remove a powder cartridge, open the dosing chamber lid and gently lift the cartridge out of the machine. If the cartridge still contains some powder and will be used again, place the cartridge carefully into the powder storage pot supplied.

All powder cartridges supplied by Velopex are gamma irradiated. The contents are sterile until opened. Powder cartridges must not be refilled as the cartridges are not reusable.

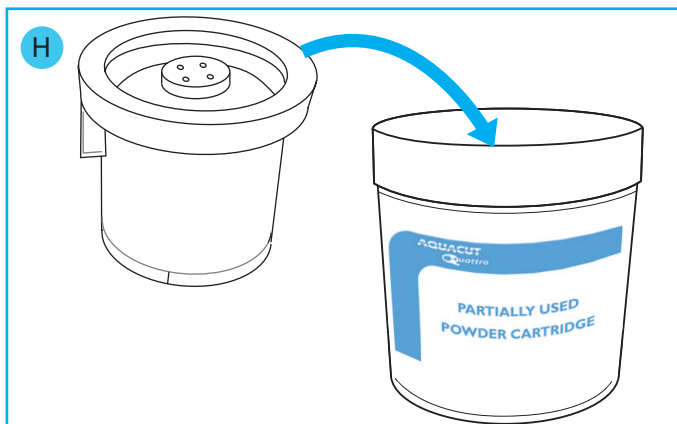

Preparing the Aquacut Quattro For First Use

When training with the Aquacut Quattro, powder could cause mess and damage to sensitive equipment if the user is not accustomed to operating the machine. For first use, either work near a sink or lay out a towel on the worksurface. Aim the handpiece nozzle into the inlet of your evacuation unit. Always wear goggles when operating the Aquacut Quattro. See INTRODUCTION: SAFETY WARNINGS, Pg 5.

- A) Check that all of the INSTALLATION sections have been completed and the INSTALLATION TEST has been successful.
- B) Fit the left dosing chamber with a sodium bicarbonate powder cartridge. Fit the right dosing chamber with either a 29 or 53 micron aluminium oxide powder cartridge.
- C) Switch the powder selection dial to the left dosing chamber.
- D) Make sure you are in full control of the handpiece.
- E) Switch the On/Off selector to position I.
- F) Press the foot pedal fully down to the CUT position. You should hear the vibrator start to operate. The nozzle should start to spray a mixture of air, fluid and powder.
- N) Turn the Powder volume dial, observing the spray. On a paper towel, you should see a ring of white powder inside an outer ring of fluid. The powder volume range varies between:
 - 1 - Low powder content, slow cutting/cleaning
 - 3 - Medium powder content, cutting
 - 5 - High powder content, very fast cutting
- O) Turn the Powder selection dial to the right dosing chamber to check that the other powder flows.
- P) The powder needs to be purged whenever you switch between powder chambers or replace the powder cartridges. The fluid needs to be purged before first use and at the start of every day. See MAINTENANCE: PURGING THE AQUACUT, Pg 33.
- Q) The Aquacut Quattro is now ready for use. Turn off the machine.

The OPERATION section contains training procedures to get started, and recommended settings for different uses.

If your observations do not match the results above, refer to the SERVICE section for a full test procedure and troubleshooting tips. Alternatively, refer the problem to a Velopex Representative or Authorised Distributed.

Use only original Velopex consumable products (powders, handpieces etc.). Other makes may damage the Aquacut Quattro or negatively alter performance.

CLEANING TRAINING WITH GLASS SLIDES

The glass microscope slides provided with your machine are similar in hardness to tooth enamel. Observing the effects of the settings on a glass slide gives a visual display of the speed of cleaning and polishing. Note: when using polishing powder, no marks will be made on the glass.

- A) Set up a suitable work area - a sink or a towel laid out on the worksurface.
- B) Ensure you are in full control of the handpiece and are aiming it in a safe direction.
- C) Turn the On/Off Selector to I.
- D) Set the powder type to sodium bicarbonate (Left Dosing Chamber).
- E) Set the powder volume to 1.
- F) Set the speed to A.
- G) Switch on the aspirator and hold the glass slide in front of its inlet tube.
- H) Aim the handpiece nozzle at the glass slide, 1.5mm from the surface, 30-45° from perpendicular.
- I) Press the foot pedal down to the CUT position.
- J) Make light strokes across the slide as if the handpiece were a paintbrush.
- K) Observe how the powder rebounds from the surface of the slide. Practice moving the inlet of the aspirator with the handpiece to efficiently collect any waste powder.
- L) Move the foot pedal between polish, wash and dry positions to observe the results.
- M) Try using this technique to polish a drinks can. The paint will be removed with no damage to the metal underneath.

CUTTING TRAINING WITH GLASS SLIDES

These steps show how the Aquacut Quattro cuts through tooth enamel. Observing the effects on the slide show the size/shape of the various cutting techniques available.

- A) Follow steps A to C above.
- B) Set the powder type to aluminium oxide (Right Dosing Chamber).
- C) Set the powder volume to 3.
- D) Set the speed to B.
- E) Switch on the aspirator and hold the glass slide in front of its inlet tube.
- F) Aim the cutting tip at the glass slide, 1-2mm from the surface, 35-45° from perpendicular.
- G) Try making cuts of 2 seconds duration. Vary the angle and distance of the nozzle from the glass slide until the required results can be achieved predictably.
- H) Try varying the powder volume, powder type, speed, and fluid volume to explore the full range of cleaning and cutting possibilities.
- I) The next step is to use the above techniques to practise cleaning and cutting an extracted tooth. Experiment with the settings until you are confident you can achieve predictable, satisfactory results.

Suggested Treatment Methods

The following treatment suggestions have been prepared with the help of experienced practising dentists. The methods of treatment are advisory, and each dentist will quickly develop their own preferences in terms of speed, powder type, powder volume, fluid volume, and the angle of the cutting nozzle.

TREATMENT TIPS

The end of the cutting nozzle should be held approximately 1.5mm from the working surface. Avoid holding the nozzle at a right angle to the surface, as this will cause the powder to rebound and blur the view of the area. Angle the cutting tip towards the aspirator and instruct the Dental Assistant to follow the nozzle with the aspirator.

The Aquacut Quattro operates with low noise, and has no vibration or heat at the cutting tip. Its ability to cut wet and dry gives it a high flexibility of use.

Local anaesthetic can be offered to nervous patients, however it is generally not required as fluid abrasion is painless in most cases.

The following treatments use a range of settings. Start at the lower end of the recommended settings and work up as you build proficiency.

The Aquacut Quattro has three dynamic controls which alter the cutting speed/cleaning rate. These are the speed, the powder volume, and the fluid volume. By increasing one setting as you decrease another, you can maintain the same cutting speed/cleaning rate but alter the treatment provided. Use less powder and more speed to improve viewing of the working area. Use more powder and less speed for sensitive areas.

CLEANING ACCESSORY

The Velopex Dental Air Abrasion Cabinet offers a simple aid in support of your Aquacut abrasion unit to enable abrasion procedures to be done outside of the mouth. Preparation of dental attachments such as crowns, bridges or brackets can be cleaned and abraded before they are cemented in the mouth. Pg. 44

Preparations Before Treatment

WARNING:All people in the operating area must wear eye protection to BS EN 166 IF 415

WARNING:All people in the operating area except for the patient must wear respiratory masks to EN 149 FFP2S

1. It is recommended that a light coating of petroleum jelly is smeared around the patient's lips to prevent cracking and to retain some of the outflowing abrasive powder.
2. Rubber dam should be used to protect adjacent teeth and soft tissue.
3. Non-metal Matrix strips should be used to protect adjacent teeth during interproximal preparations.
4. A bib should be used to protect the patient's clothes from any out-flow of the material from the mouth during the course of a treatment.

5. Use a high-speed intra-oral aspirator, preferably with a flared tip.

6. An extra-oral evacuator can also be used with the extraction cone sited below the patient's chin.
7. **IMPORTANT:** To avoid unnecessary damage, when switching from Aluminium Oxide to Sodium Bicarbonate you must purge the powder. See MAINTENANCE: PURGING THE AQUACUT, Pg 33.

Please read INTRODUCTION: SAFETY WARNINGS, Pg 5 carefully before using the Aquacut Quattro.

CLEANING/STAIN REMOVAL

Settings:

Powder -	Sodium Bicarbonate (clear container).
Nozzle -	0.6mm diameter or 0.8mm diameter.
Speed -	Low A to High B.
Powder Flow -	1-3

This treatment is particularly easy when using the Aquacut Quattro and gives a superior finish to the teeth. Where the teeth have been stained by coffee and/or smoking, fluid abrasion comes into its own.

The fine particles of sodium bicarbonate penetrate the micro crevices of the tooth surface and the particulate beam easily follows the contours of the tooth surface, enabling the staining to be removed very quickly and with no discomfort to the patient.

The settings as listed above will create a wide particulate beam of high velocity and medium particulate density. This is to prevent removal of the tooth enamel but provide sufficient power to remove staining.

The cutting nozzle should be held approximately 4mm from the surface of the tooth at an angle of approximately 45 degrees. By moving the nozzle further away from the surface of the tooth, the rate of removal of staining can be slowed down. Move the handpiece slowly over the tooth surface.

The most effective way to use fluid abrasion for this procedure is to use the handpiece of the Aquacut Quattro as if it were a paintbrush, making light strokes across the surface of the tooth until the surface is clean. With experience, the dentist will be able to work with a high degree of control, the learning curve being similar to that when first using a high speed drill.

FISSURE CARIES TREATMENT

Settings:

Powder -	29 micron Aluminium Oxide (blue container).
Nozzle -	0.5mm diameter or 0.6mm diameter.
Speed -	High A.
Powder Flow -	I

The Aquacut Quattro is of particular use for treating fissure caries.

Hold the cutting nozzle about 2mm from the surface of the tooth and direct the particulate beam at the caries. Use it in short bursts, sweeping it along the vein until all the dark caries is removed and the sound tooth structure is revealed.

The beauty of the procedure is its speed and the absolute control possible, ensuring that the minimum amount of tooth structure is removed.

The newly prepared surface, being dry and abraded, is now ready for restorative materials. Normally local anaesthetic is not necessary for the above treatment.

NOTE: If there is soft caries present in the dentine, a rotary instrument may have to be used, or use the Sodium Bicarbonate on “cleaning” setting. This is because soft and moist caries are resilient and therefore not so effectively removed by the use of fluid abrasion.

NOTE: Stop the process periodically to check progress visually

CAVITY PREPARATION

Settings:

Powder -	53 micron Aluminium Oxide (red container).
Nozzle -	0.6mm diameter or 0.8mm diameter.
Speed -	Mid B to Mid C.
Powder Flow -	3 to 5.

The procedure for the preparation of a cavity with the Aquacut Quattro will depend on the size of the cavity and the extent and type of caries.

For small cavities, the cutting nozzle should be held at an angle of between 35 degrees and 45 degrees to the surface being abraded, and about 2mm or 3mm from the surface.

The best approach is to use a slow circular motion over the affected area until sound tooth structure is revealed. The tooth is now ready to be filled in the normal way.

For larger cavities, a combination of the Aquacut Quattro and a rotary instrument may be of benefit. This is because fluid abrasion is a technique designed to produce a very conservative cut with a working area of less than 2mm diameter. Finally, the surface of the cavity should then be finished using the Aquacut Quattro to ensure a suitable key for the bonding agent.

NOTE: Fluid abrasion is not a suitable technique for shaping undercuts for amalgam restorations. Traditional rotary instruments should be used for this application.

REMOVAL OF COMPOSITE RESTORATIONS.

Settings:

Powder -	53 micron Aluminium Oxide (red container).
Nozzle -	0.6mm diameter or 0.8mm diameter.
Speed -	Mid B to Mid C.
Powder Flow -	3 to 5.

The Aquacut Quattro is very useful for the removal of old composite restorations.

Hold the cutting nozzle at an angle of about 45 degrees to the surface of the old composite restoration and about 2mm or 3mm from the surface.

The best approach is to use a slow circular motion over the old restoration beginning at the edge, particularly at the failed margin, until all the old composite has been removed and the cavity preparation completed.

The new restorative can now be applied in the normal manner without any further treatment. Follow the manufacturer's recommendations with regard to the use of acid etch with bonding systems.

BONDING ORTHODONTIC BRACKETS

Settings:

Powder -	29/53 micron Aluminium Oxide (blue/red container).
Nozzle -	0.6mm diameter or 0.8mm diameter.
Speed -	B.
Powder Flow -	I.

The enamel of the tooth to be treated can be “etched” to the exact size of the orthodontic bracket at the place of attachment.

This is achieved by holding the cutting nozzle 2mm above the surface of the tooth and gently moving it in a circular motion over the required area. This will result in a dry “etched” surface, ready to accept the bonding agent, and the risk of saliva contamination is greatly reduced because the aluminium oxide dries the surrounding mucosa.

The same technique can be used to clean the orthodontic brackets.

Sterilising The Handpiece

The handpiece is supplied clean, but not sterile. **The handpiece should be sterilised before first use, and between all subsequent uses.**

Do not use an ultra-sonic washer.

- A) Remove and discard the disposable feedline and tip (See INSTALLATION: FITTING THE DISPOSABLE FEEDLINE AND TIP, Pg 17).
- B) Disassemble the handpiece parts (See PARTS AND FEATURES: HANDPIECE, Pg 12). For safety, treat used handpiece equipment as if it is contaminated with infectious material. Wash all of the parts thoroughly in mild soapy water, removing any debris or blockages.
- C) Alternatively, place handpiece parts in automatic washer/disinfector baskets following manufacturer's recommendations. Wash in a slightly alkaline or neutral pH detergent, as recommended by the manufacturer.
- D) When cleaning is completed the handpiece must be sterilised. To steam sterilise/autoclave the handpiece effectively, the two channels through the handpiece must be clear and unblocked.
- E) Check the flow from the nozzles. If the channels are blocked, use the cleaning wire to clear them.

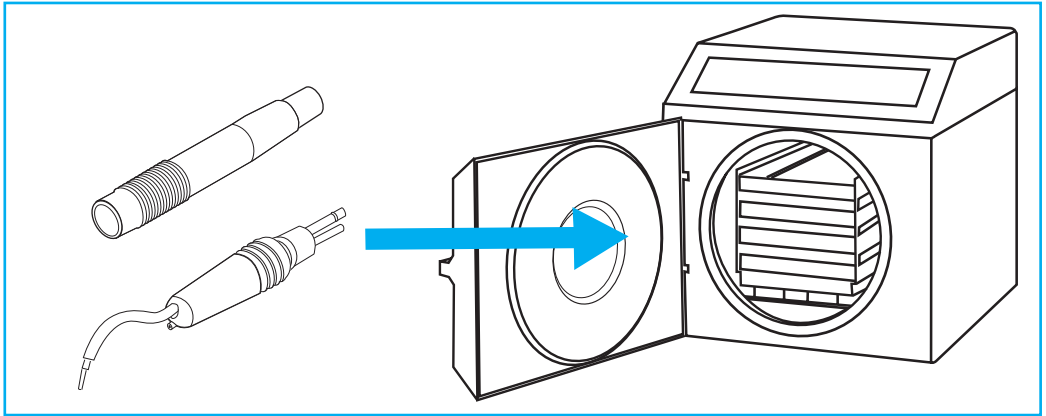

F) Place the handpiece in a steam steriliser/autoclave. The handpiece must be sterilised to a minimum of 134°C at 2 bar for 3.5 minutes. This will ensure a Sterility Assurance Level (SAL) of 1×10^{-6} . Dry for a minimum of 3 minutes using vacuum drying.

G) A suitable sterilisation pouch should be used to maintain sterility. The plastic parts should be replaced after 20 cycles. The handpiece should be replaced when cutting efficiency is impaired.

This cleaning and sterilising procedure satisfies UK Health Technical Memorandum 2030 Washers-Disinfectors and UK Health Technical Memorandum 2010 Sterilisation.

Handpiece Maintenance

Blockages

If the abrasive powder ceases to flow from the nozzle while cutting is in progress, the nozzle may have become blocked with abrasive particles. Turn off and depressurise the machine. Now remove the handpiece and clear the blockage by inserting a length of 0.35mm wire (supplied) through the nozzle from the tip.

Inspection

Regularly inspect the cutting nozzle and handpiece for excessive wear or damage. Do not use a Handpiece if the hole in the tip of the nozzle is worn to the outer edge or if the abrasive perforates the swan neck tube.

Twin Tube Assembly Maintenance

Cleaning

The Twin Tube Assembly must not be autoclaved. Wash the Twin Tube Assembly in mild soapy water and rinse thoroughly. Allow to dry completely before use. Always purge the tubes with Powder and Fluid thoroughly before use.

Inspection

Ensure the Twin Tubes are in good condition and fit together correctly with the Handpiece. Test the Check Valve is functioning. The valve prevents fluid being forced back down the tube during use.

Check 1 - With the twin tube filled with fluid, disconnect the tube at the Fluid Out connection, (item 7). Hold the handpiece up vertically and check that the fluid in the tube does not drip from the disconnected end. Reconnect the tube.

Check 2 – With the machine in the ‘ready to use’ condition, press the ‘Wash’ control on the foot pedal and gently press the plastic tip on the end of the nozzle down onto a flat surface (e.g. a glass slide). The fluid should be prevented from blowing back down the fluid line past the handpiece. The joint between the plastic tip and feedline may also disconnect.

Replace the whole check valve assembly if any faults are found. The twin tube assembly should be replaced annually.

PURGING THE FLUID

When re-filling the Fluid Tank, the smaller tube of the twin assembly will need to be purged of any air that may have entered the system.

- A) Turn the powder setting to I. This will prevent unnecessary powder being expelled from the handpiece.
- B) Point the handpiece in a safe direction (e.g. the inlet of the evacuation unit).
- C) Press the foot pedal “WASH” centre position for at least 10 seconds.
- D) The machine will expel air from the handpiece and purge the fluid through the line.
- E) The procedure is complete when a continuous fine mist sprays from the nozzle and no air pockets can be seen in the smaller tube.
- F) Reset the powder volume as desired.

We recommend that the Fluid Tank is checked and re-filled daily as a matter of surgery procedure to prevent running out of fluid whilst working. Depending on usage this may also be carried out at the beginning of the afternoon session.

Always purge the fluid for 20 seconds before initial use and at the start of every day.

PURGING THE POWDER

This will empty the feed tube and handpiece of any previously used powder and charge them with the new powder.

- A) Hold the handpiece and direct the nozzle into the inlet of the evacuation unit.
- B) Press the ‘CUT’ (bottom) position of the foot pedal for at least 10 seconds.
- C) Observe the flow of abrasive powder as it is emitted from the nozzle.
- D) The procedure is complete when the flow of powder is uniform.

This charges the feed tube and handpiece with the new abrasive powder and flushes out any previous powder. We recommend that this procedure is carried out every time the powder is changed.

Cleaning The Aquacut Quattro

Wipe the casing, the dosing chambers, and their lids clean with a damp cloth, ensuring no liquid gets inside the machine. The inside of the dosing chambers, lids and the powder cartridges must be kept dry at all times.

WARNING: under no circumstances must any other cleaning agent, including surface wipes containing alcohol, come into contact with the case or the dosing chambers.

The Dosing Chambers and Dosing Chamber Lids are made of special materials and are repeatedly pressurised. They should be checked for any visible damage whenever the powder is changed. If there is any damage visible, do not use the Aquacut Quattro unit until it has been inspected by a Velopex Representative or Authorised Distributor.

Internal View Of The Aquacut Quattro

- 1. Compartment release button
- 9. Storage compartment
- 21. Fluid tank
- 39. Internal filters
- 40. Control block
- 41. Selector pinch block
- 42. Outlet connector
- 43. Fluid Tank Dip Tube
- 44. Service Release Latch

OPENING THE SERVICE COMPARTMENT:

Full access is only required for service tasks. Push the compartment release button to open the machine. Remove the storage compartment then reach into the machine and push the service release latch right. The latch will disengage. Open the compartment fully, making sure the top section rests on a flat surface. To close the machine, lift the top section back over the base, ensuring that the fluid tank dip tube is inserted into the fluid tank. Press down on the top of the machine until it clicks shut.

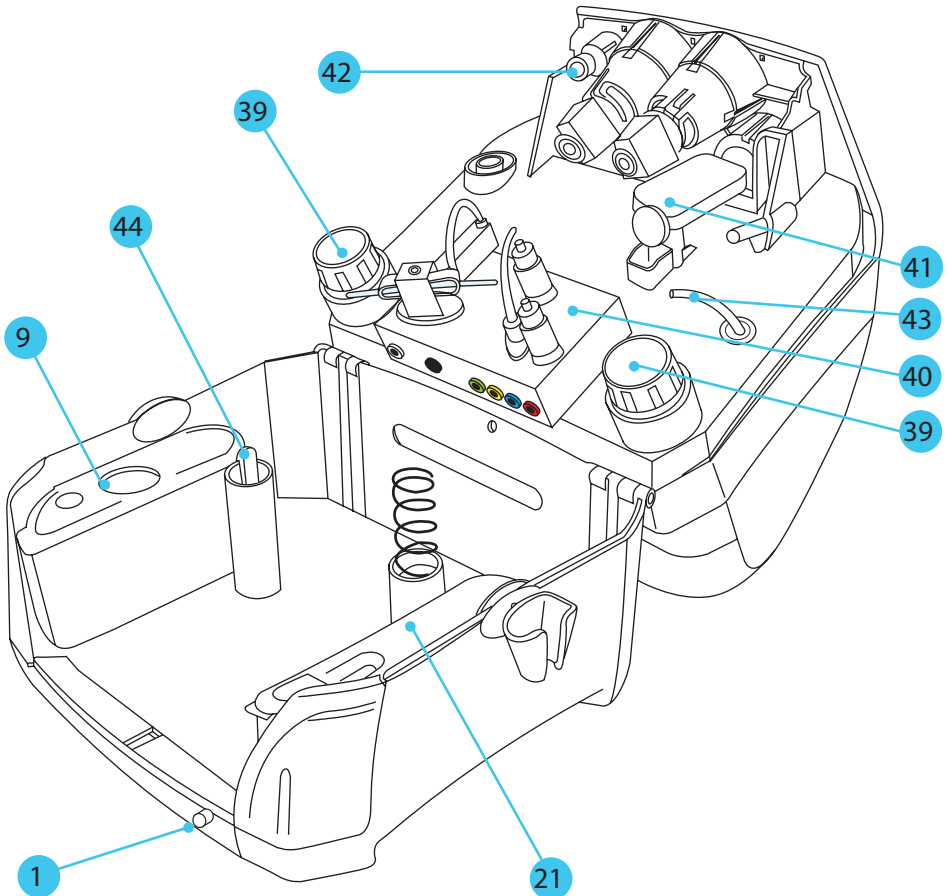

Internal Filter Assembly

- 45. Filter cover.
- 46. Spring.
- 47. Filter element.
- 48. One way valve plug.
- 49. Filter base.

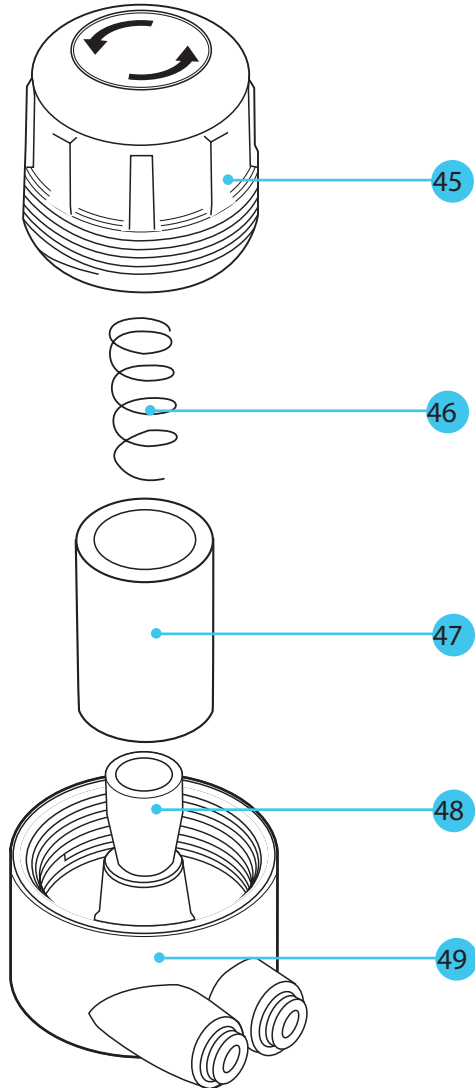

Control Block

50. Cut pinch valve (Clear tube)

51. Cut pinch block

52. Fluid Control Valve

40. Control block

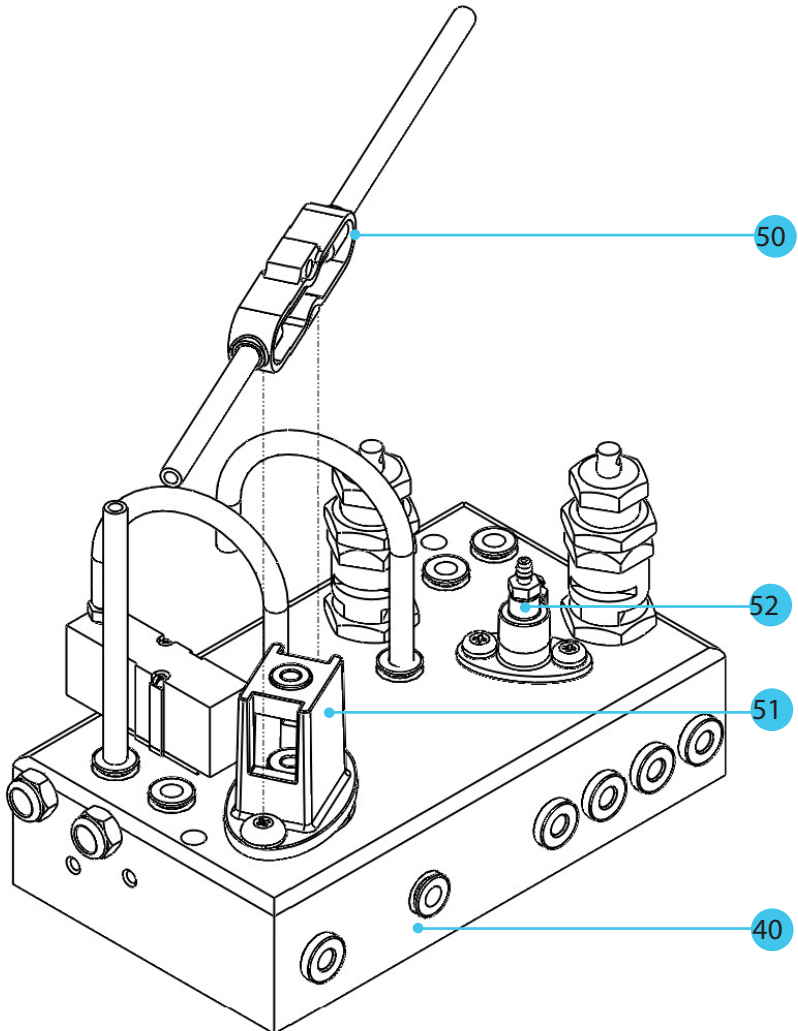

Service Checks

ANNUAL SERVICE AND SAFETY CHECK.

To ensure your Aquacut Quattro continues to function safely and reliably, it is important that you contact your supplier or Velopex and book an annual service and safety check.

The dosing chambers and lids should be replaced every 2 years.

Replacing The Powder Pinch Tube

See SERVICE: CONTROL BLOCK, Pg 37.

The powder pinch tube should be replaced annually.

The Aquacut Quattro also has 2 internal air filters. These should be visually inspected at the same time and, if necessary, the filter elements can be replaced. These tubes and filter elements can be easily replaced without the need for specialist tools. The procedure should take no longer than 15 minutes.

NOTE: For spare parts you will need to specify the machine Serial Number shown on the technical label on the back of the machine.

WARNING: Turn off the air supply at the wall outlet and disconnect the air/secondary gas tubes at the rear of the machine before attempting any maintenance.

All tubes on the Aquacut Quattro are connected using collet fittings as on the foot pedal and airline connectors. To disconnect the abrasive tubes, push the coloured connector in, and then gently pull the tube out.

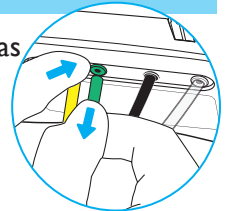

To replace the powder pinch tube proceed as follows:-

WARNING: Remove all powder pots before opening the machine

- A) Press the Release Catch and allow the front of the machine to open.
- B) Undo the Service Release Catch. See SERVICE: INTERNAL VIEW OF THE AQUACUT QUATTRO, Pg 35. Supporting the machine, lift the upper part of the machine fully over until the cover rests on the work surface and the inside is presented.
- C) Locate the Powder pinch valve, which has the clear Powder tube running through it.
- D) Disconnect both ends of the clear tube from their collet lock fittings (see above).
- E) Slide the Powder pinch tube out of the pinch block.

Replacing The Powder Pinch Tube

- F) Slide the new Powder tube through the pinch valve.
- G) Route the new tube into the same position as the old one. Push the ends of the new tube back into their collet lock fittings
- H) Close the service compartment.
- I) Discard the old pinch tube.

NOTE: It is important to now test the machine to check that it is operating correctly. See SERVICE: TEST PROCEDURE, Pg 40.

Replacing The Air Filters

Check the condition of the Internal Air Filters whenever performing maintenance tasks which require opening the service compartment. Replace them if they appear heavily soiled or wet. See SERVICE: INTERNAL FILTER ASSEMBLY, Pg 36.

- A) Remove the cover by turning clockwise.
- B) Remove the old filter element and discard.
- C) Place a new filter element in the filter base.
- D) Replace the cover and close by turning anti-clockwise.
- E) Close the service compartment.

Test Procedure

After performing any maintenance on the Aquacut Quattro, or if a fault is suspected, the following procedure can be used to check that the machine is in working order. If a fault or problem is found, please see **SERVICE:TROUBLESHOOTING**, Pg 41. During testing, it is advisable to point the handpiece into a sink to contain the powder.

- A) Fit the left dosing chamber with a cartridge of sodium bicarbonate powder.
- B) Ensure the right dosing chamber does not contain any powder cartridges.
- C) Wear safety goggles.
- D) Turn the powder selection dial to the left dosing chamber.
- E) Switch the machine on by turning the On/Off selector to I. Check that there are no audible air leaks or loss of pressure.
- F) Aim the nozzle at a paper towel, at a distance of about 25mm.
- G) Press the foot pedal down to the DRY position. Air should blow out of the nozzle, but no water or powder.
- H) Press the foot pedal down to the WASH position. On the paper towel you should see a ring of fluid appear, but no powder.
- I) Press the foot pedal down to the CUT position. On the paper towel, you should see a small ring of powder inside an outer ring of fluid.
- J) Turn the machine off.
- K) Remove the sodium bicarbonate powder cartridge from the left dosing chamber.
- L) Fit the right dosing chamber with a cartridge of 29 or 53 micron aluminium oxide.
- M) Turn the powder selection dial to the right dosing chamber.
- N) Repeat steps E to I.
- O) Still pressing CUT, turn the speed dial clockwise and check that the speed of flow increases. Turn the speed dial anticlockwise and check that the speed of flow decreases.
- P) Turn the powder volume dial clockwise and check that the flow of powder becomes denser. Turn the powder volume dial anticlockwise and check that the flow of powder becomes less dense.
- Q) Turn the fluid volume dial clockwise and check that the flow of fluid becomes more dense. Turn the fluid volume dial anticlockwise and check that the flow of fluid becomes less dense.
- R) Switch the machine off. Allow it to depressurise and refit the powder cartridges as required.

If your observations match those detailed above, the machine is operating correctly and is ready for use. If any of the above steps are not possible because a feature does not work, or if your observations do not match those detailed above, refer to **SERVICE:TROUBLESHOOTING**, Pg 41, or alternatively seek advice from a Velopex Representative or Authorised Distributor.

If you are having problems with your Aquacut Quattro, please follow the steps below before proceeding further as these will often resolve general faults.

1. Ensure that the compressed air supply is at the specified pressure, connected and on.
2. Ensure that the unit is switched on.
3. Check that none of the controls are set to minimum, and that you have selected the correct dosing chamber.
4. Check that the colour coded foot pedal hoses have been correctly connected to their matching terminals on the back of the machine.
5. Fill the fluid tank and check the fluid tube is fully submerged in fluid.
6. Ensure the powder chambers are correctly loaded with powder pots, and that the powder pots contain an ample level of powder.
7. Check the Dosing Chamber Lids are screwed on securely and correctly.
8. Check that there is no water or wet air contaminating the pneumatic system. This can occur if the compressed air source is not filtered effectively enough. If this is the case, change the air line filters, clean or replace the air line, and contact a Velopex Representative or Authorised Dealer who will be able to assess the damage to the Aquacut Quattro unit.

Symptom:

No air flow through the nozzle.

Action:

1. Ensure that the speed dial is turned up to at least "A". This should give a detectable airflow.
2. Check that the nozzle is not blocked. If blocked remove the handpiece and clear the blockage with a cleaning wire.
3. Ensure the twin tube is straight and has no kinks or folds.
4. If the Internal Filters are not changed they can become soiled, blocking the air line. See SERVICE: REPLACING THE AIR FILTERS, Pg 39.
5. If the Powder Pinch Tube is worn it will not operate, preventing air from flowing to the nozzle. This can be resolved by replacing the part. See SERVICE: REPLACING THE POWDER PINCH TUBE, Pg 38.

Symptom:

No powder flow through the nozzle when the foot pedal is pressed down to the “CUT” position.

Action:

1. Check that you have selected the correct Dosing Chamber, loaded correctly with a Powder Cartridge. Make sure that the Powder Cartridge is not empty.
2. Turn the Powder Volume control up to maximum.
3. Check that there are no objects blocking the foot pedal from moving normally.
4. Depressurise the machine. Remove the Dosing Chamber Lids and look inside them. In the centre of each lid you should see a circular rubber bump. If you do not see this on the lid it will need to be replaced.
5. Press the foot pedal down to the DRY or WASH position. You should hear the noise of air flowing through the machine. Now press the foot pedal down to the CUT position. You should hear the noise increase as the vibrator starts to operate. If you do not hear an increase in noise, then the vibrator may be faulty. Please contact a Velopex Representative or Authorised Distributor for further help.

Symptom:

Irregular flow or no flow of cutting fluid to the tip.

Action:

1. Check that the fluid volume control is not set to minimum. Rotate clockwise to increase fluid volume.
2. Change the feedline and tip. In most cases the plastic tip should last long enough for an individual patient treatment. However prolonged treatment or failure to change feedline and tip between treatments will wear the feedline and tip, causing reduced or uncontrolled flow. See INSTALLATION: FITTING THE DISPOSABLE FEEDLINE AND TIP, Pg 23.
3. Ensure the plastic tip is firmly engaged on the cutting nozzle.
4. Check the fluid tank is filled and the fluid tube is fully submerged in the fluid.
5. The check valve (Item 36) could be blocked or stuck. Disconnect the fluid connection and purge the line. This should unblock the valve. If this is not effective, replace the check valve.
6. Check for a blockage in the supply line. Look at the clear twin tube for any material blocking the tube.
7. If there are also air bubbles in the fluid tube this can indicate a leaking joint. Look along the tube to see where the air bubbles are appearing to find the source of the leak. Check the joint and replace if necessary.

Symptom:

Audible air leak and fall in performance

Action:

1. Ensure that the dosing chamber lids are tightly closed. If the dosing chamber lids are loose or not correctly sealed, a large amount of air will leak from the machine. Turn the unit off and carefully wipe the inner Lid seal and Dosing Chamber sealing faces. Screw the lids on tightly until they have reached the end of their thread.
2. Replace pinch tube assembly. See MAINTENANCE: REPLACING THE POWDER PINCH TUBE, Pg 39.

NOTE: IF THE FAULT CANNOT BE LOCATED AND REPAIRED BY REFERRING TO THIS TROUBLESHOOTING GUIDE IT WILL BE NECESSARY TO ACQUIRE THE SERVICES OF A VELOPEX REPRESENTATIVE OR AUTHORISED DEALER FOR A MORE THOROUGH DIAGNOSIS.

Recommended Accessories

Description

Part No

Equipment

Breathing air filter unit	I/FIT 8200F
Shut off tap	I/FIT 820IF
Pressure regulator	I/FIT 8202F
6mm Hose	I/ROL8014F
4mm Hose	I/ROL8006F
6mm to 4mm Converter	I/FIT8290F
Replacement Upper Filter Element	I/FIT8355F
Replacement Lower Filter Element	I/FIT8354F
Aquacut Stand	I/ASS0045F
Velopex Dental Air Abrasion Cabinet	I/MAC6200F

Consumables

Sodium Bicarbonate Cartridges, Pack of 4	I/PDR 8014F
29 micron Aluminium Oxide Cartridges, Pack of 4	I/PDR 8025F
53 micron Aluminium Oxide Cartridges, Pack of 4	I/PDR 8024F
500ml Fluid Bottle	I/PAC 8200F
Glass Slides (for cutting practice)	I/MIC 0010F
Feedlines and Tips, Pack of 50	I/ASS 8007F

WARNING:All replacement parts and consumables must be sourced from Velopex to ensure correct and safe functioning of the Aquacut Quattro.

Spare Parts

Handpiece - 0.4mm Green	I/ASS 8189F
Handpiece – 0.6mm Silver	I/ASS 8191F
Handpiece – 0.8mm Gold	I/ASS 8192F
Fluid Tank and Lid	I/ASS 8194F
Storage Tank and Lid	I/ASS 8193F
Dosing Chamber Lid	I/ASS 8003F
Nozzle Cleaning Wire	I/FIT 8073F
Powder Storage Pot	I/ASS 8197F
Internal Filter Elements, Pack of 2	I/FIT 8198F
Twin Tube (with check valve)	I/ASS 8020F
Check Valve	I/ASS 8004F
Foot pedal assembly	I/FIT8196F



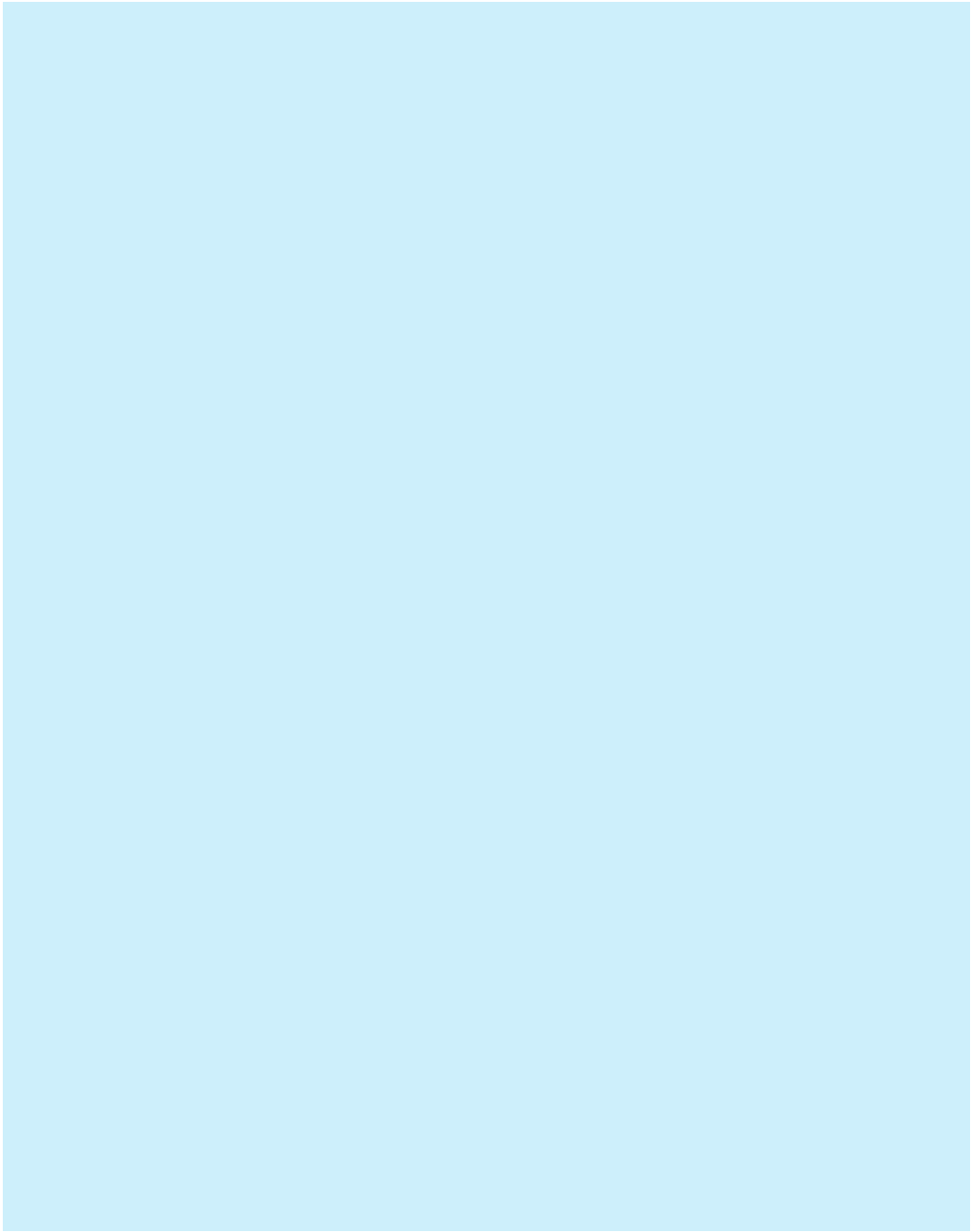

AQUACUT

Quattro

Fluid Abrasion Unit

velopex[®]
www.velopex.com

FDA 9051184
CE 0120



Medivance Instruments Ltd
Barretts Green Road
Harlesden, London
NW10 7AP
Tel: +44 (0) 20 8965 2913
Fax: +44 (0) 20 8963 1270

Velopex is a trademark of
Medivance Instruments Ltd.

OFFICE: USA
Velopex International
105 East 17th Street
Saint Cloud
Florida 34769
Tel: +1 (407) 957 3900
Fax: +1 (407) 957 3927