

John Guest Limited

Horton Road, West Drayton, Middlesex UB7 8JL, England
Tel: 01895 449233 Fax: 01895 420321. www.johnguest.com

JG John Guest® **JG** and **Speedfit**® are registered trademarks of
John Guest International Limited ' Copyright 2008.



 **John Guest**®

Speedfit® Air Products



*Compressed Air Systems
Pneumatic Fittings
LLDPE Tube*

January 2008

John Guest[®]

The John Guest Group has a long established reputation as a world leading manufacturer of push-in fittings, tube and other fluid control products. A reputation built on producing consistently high quality products with an ongoing commitment to value engineering and product development.



Quality Manufacture

A commitment to quality is at the heart of the John Guest philosophy.

The strictest control is maintained by virtue of the fact that design and manufacture is carried out in modern purpose built manufacturing centres in west London and at Maidenhead in Berkshire.



THE QUEEN'S AWARDS
FOR ENTERPRISE:
INNOVATION
2005

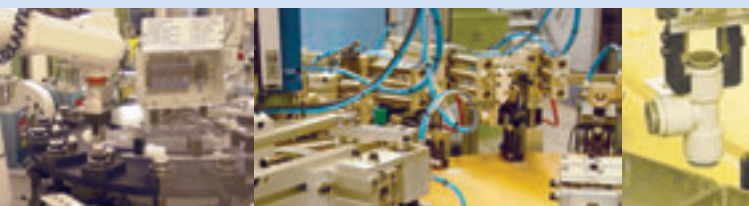

Maintaining control over the whole process from initial tool design and tool making through to final assembly and testing ensuring that only products of the highest quality are produced.

The company believe it is this commitment to quality that has led to it receiving prestigious awards from many of the world's leading testing and approvals organisations.

John Guest is a preferred supplier to many international companies.



Since 1989

Contents

Compressed Air Pipe and Fittings

 <p>Compressed Air Products</p>	A push fit system of fittings and pipe which means a compressed air supply can be installed quickly and easily with much reduced production down time	05 - 24
---	---	----------------

Pneumatic Fittings

 <p>Metric Size Fittings</p>	Metric Size Fittings in 4 to 12mm sizes. Selected items have Superthread. A unique thread with integral seal suitable for 5 different thread forms.	25 - 40
 <p>Miniature Fittings</p>	Miniature Fittings, specially designed for miniature pneumatics applications.	43 - 44
 <p>Banjo Flow Controls</p>	Banjo Flow Controls, compact envelope size and precise adjustment.	41 - 42
 <p>Imperial Size Fittings</p>	Inch Size Fittings in 5/32" to 1/2" sizes.	45 - 56

Speedfit[®] Air Products

Tubing



LLDPE Tube

Strong but flexible and available in 9 colours.

59 - 60

Accessories

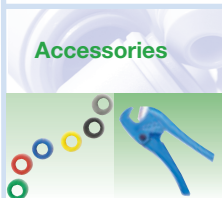

Accessories

Tube Cutters, Flow Bend Clips, Collet Covers and Tube Inserts

57 - 58

Technical Specification

Compressed Air Products

23 - 24

Pneumatics Fittings

61 - 62

Product Selection and Installation, Maintenance and Replacement, Cleaners and Sanitising, and Warranty

63 - 64

The easy to use push fit system for Compressed Air

The John Guest range of push-in fittings and pipe provide the ideal connection from compressor receiver to air line service components through to complete ring main and take off points. A compressed air system can be installed quickly and easily, compared with other installation methods, time savings of at least 50% are easily achievable.



No need to prepare threaded pipe or solvent, all the connections can be made with a simple push-in action. The system is then immediately ready for use. Complex systems can be assembled much more rapidly than with traditional methods and because fittings are easy to disconnect, systems can be altered or extended with much reduced production down time.

The fittings are produced in either a tough engineering plastics material or in brass in sizes 12mm to 28mm. They are intended for use with John Guest nylon pipe but can also be used with copper or aluminium pipe.



- Installation time reduced by at least 50%
- **Safe, secure, leakproof**
- **Easy to alter or extend a system**
- **Lightweight and easy to handle**
- **No corrosion, reduced maintenance**

COMPRESSED AIR SYSTEM

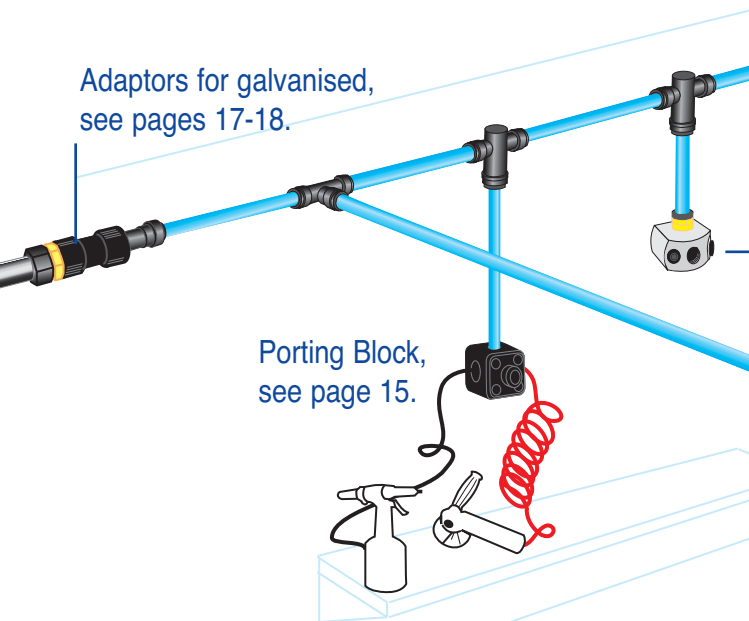

Complex systems easy to produce.



1. Cut pipe square



2. Push pipe into fitting

Speedfit® Air Products

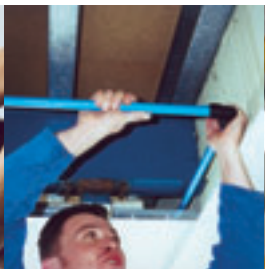
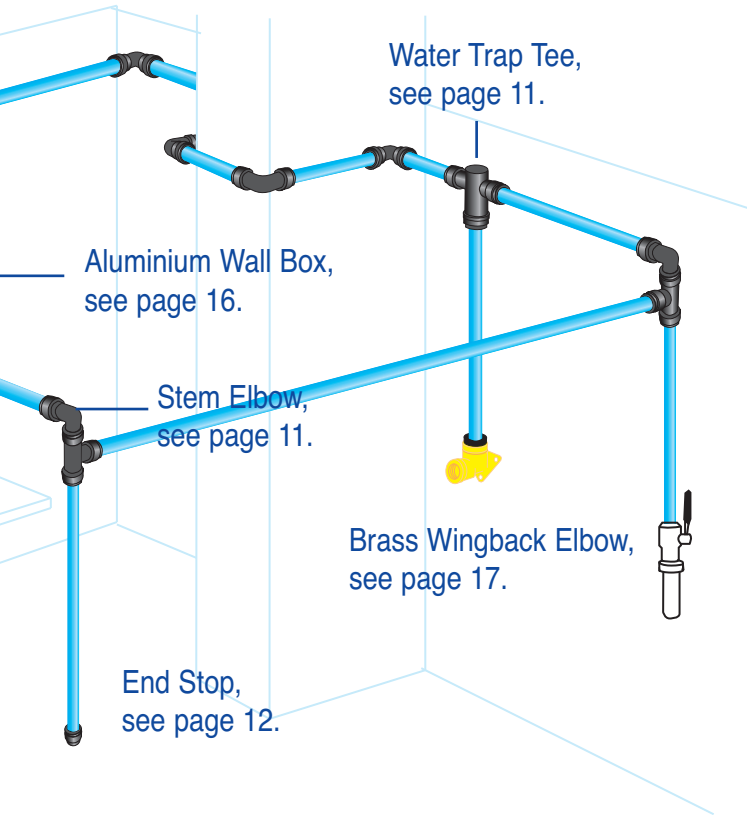

3. Easy to use in confined spaces



4. Complex systems easy to achieve



5. System complete in 2 days

EASY TO MAKE A CONNECTION

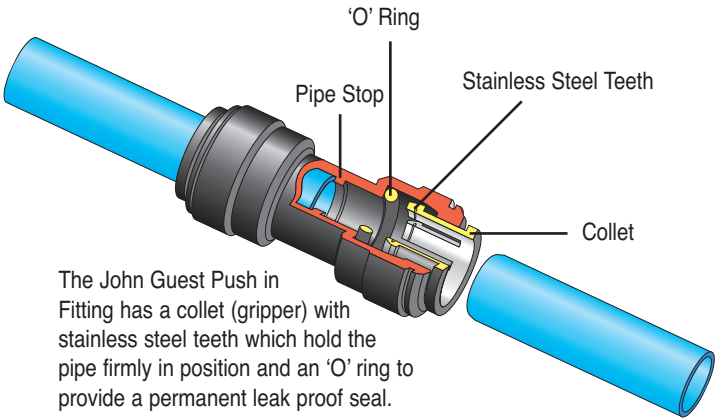

The John Guest Push in Fitting has a collet (gripper) with stainless steel teeth which hold the pipe firmly in position and an 'O' ring to provide a permanent leak proof seal.

THREE EASY STEPS

Fittings and pipe should be kept clean and undamaged before use.

Cut the pipe square.
We recommend the use of the JG Pipe Cutter.

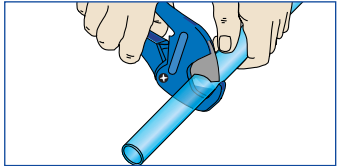

DO NOT use a hacksaw. To avoid damage to the 'O' ring remove burrs and sharp edges.

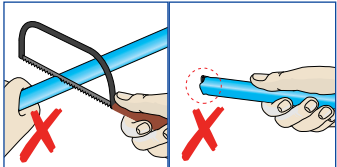

Push up to pipe stop.

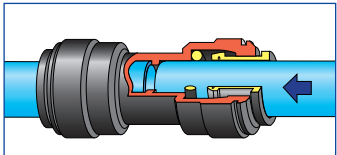

Pull to check secure.
Test the system before use.

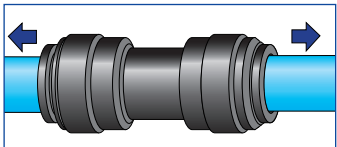

To disconnect, ensure the system is depressurised. Push the collet towards the fitting and remove the pipe. The fitting can be reused.

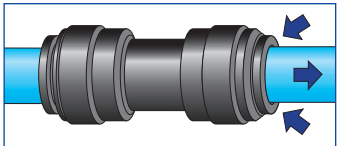

28MM FITTINGS

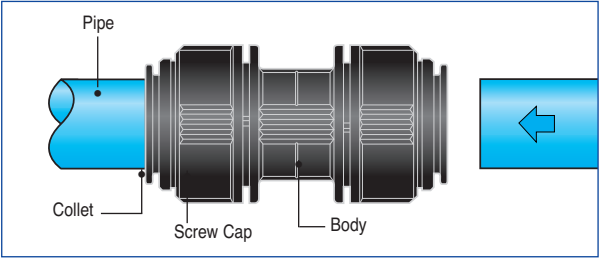

28mm fittings also have a collet with stainless steel teeth and an 'O' ring.

After inserting the pipe, a screw cap is turned approx 1/4 turn. This locks the collet in place and reduces lateral and sideways movement of the pipe.

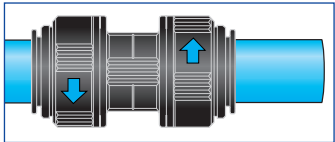

To disconnect, turn the screw cap 1/4 turn, push in the collet and remove the pipe. The fitting and pipe can be reused.

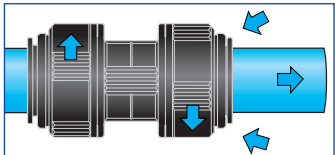

Nylon, Copper & Aluminium Pipe

Whilst we recommend the use of John Guest Rigid Nylon Pipe, John Guest Fittings can also be used with copper or aluminium pipe.



UNIQUE FEATURES

STEM ELBOW

Designed to simplify pipe connections in restricted spaces, the Stem Elbow gives an instant swivel fitting so a pipe can be orientated in any direction.



Can be used with an elbow to make 'U' turn connection.

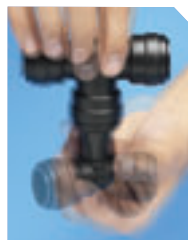
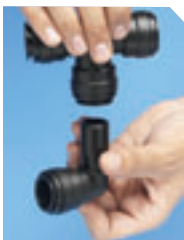

Please note a collet cover cannot be used on a Speedfit end assembled with the stem of a 22mm Stem Elbow.

Can be used with a Tee.

WATER TRAP TEE

The new Water Trap Tee from John Guest solves the on-going problem of moisture in a compressed air system and provides the easy alternative to the need to install "Swan Necks".

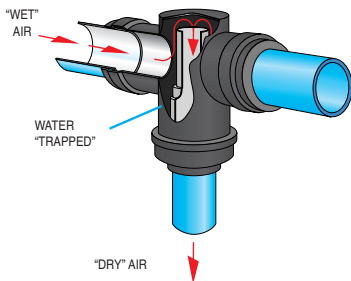

The ingenious inside arrangement of the fitting allows air to flow, with minimum head loss, from the main to take-off point without allowing water to follow. The moisture is retained in the line to be drawn off at some suitable location.

Installation

It is of vital importance for the correct function of the Water Trap Tee that the air distribution system be nearly horizontal and that the outlet port be facing downwards.

Speedfit® Air Products

WATER TRAP TEE CONVERTOR

The Water Trap Tee Convertor is a simple convenient way of converting a standard John Guest 28mm Tee to a Water Trap Tee.

This will stop condensing water entering the vertical take off spur.

The air supply needs to be installed with the correct fall and water drain points regularly vented.

To Assemble

Use either John Guest 28mm Nylon Pipe or 28mm copper pipe. The pipe to be cut square and be free of burrs.

Press the shorter spigot into the pipe. The fit on copper pipe will be loose, this will not affect the function.

Push the pipe and convertor up to the pipe stop of the centre leg of the tee.

Turn the screw cap approx 1/4 turn to lock the pipe in position.

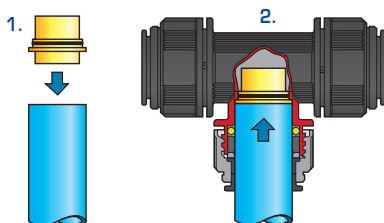

END STOP

The End Stop can be used to provide a permanent connection or a temporary shut off. Because it is easy to disconnect the fitting from the pipe, the End Stop can be put in place to be removed at a later date to allow a system to be extended or modified.



COMPRESSED AIR FITTINGS

A push fit system of fittings and pipe which means a compressed air system can be installed quickly and easily with much reduced production down time. It is also easy to rearrange and extend a system.

STRAIGHT ADAPTOR



PART NO.	PIPE OD	THREAD BSP
PM011213E	12	3/8
PM011214E	12	1/2
PM011513E	15	3/8
PM011514E	15	1/2
PM011516E	15	3/4
PM011814E	18	1/2
PM012216E	22	3/4

EQUAL ELBOW



PART NO.	PIPE OD
PM0312E	12
PM0315E	15
PM0318E	18
PM0322E	22
PM0328E	28

STRAIGHT CONNECTOR



PART NO.	PIPE OD
PM0412E	12
PM0415E	15
PM0418E	18
PM0422E	22
PM0428E	28

Speedfit® Air Products

EQUAL TEE



PART NO.	PIPE OD
PM0212E	12
PM0215E	15
PM0218E	18
PM0222E	22
PM0228E	28

REDUCING TEE



PART NO.	PIPE OD ENDS	TUBE OD BRANCH
PM3018AE	18	15
PM3022AE	22	15

STEM ADAPTOR



Converts push fit end to male thread

PART NO.	STEM OD	THREAD BSP
PM051213E	12	3/8
PM051214E	12	1/2
PM051513E	15	3/8
PM051514E	15	1/2
PM051814E	18	1/2
PM052214E	22	1/2
PM052216E	22	3/4

John Guest Adaptability

Standard *Super Speedfit*® products can be coupled together to form integral new fittings.

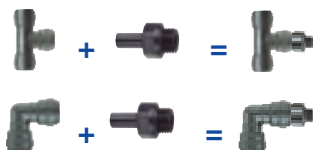

STEM ELBOW



Stem can swivel in any direction, see page 11.

PART NO.	PIPE OD	STEM OD
PM221212E	12	12
PM221515E	15	15
PM221818E	18	18
PM222222E	22	22

REDUCER



PART NO.	STEM OD	PIPE OD
PM061512E	15	12
PM061815E	18	15
PM062215E	22	15
PM062218E	22	18
PM062815E	28	15
PM062822E	28	22

WATER TRAP TEE



Solves the problem of moisture in a compressed air system, see page 11.

PART NO.	PIPE OD ENDS
PMTT22E	22

PORTING BLOCK



PART NO.	
JG-L-WSK	5 1/2" Connections

ALUMINIUM WALL BOX



PART NO.	SIZE
JGWALLBOX 1/2	1/2
JGWALLBOX 3/4	3/4

1/2 or 3/4 female thread on the top.
Both products have 3 x 1/2" female threads on the side.

U-BEND



PART NO.	SIZE
PMUB15E	15

END STOP



NEW

PART NO.	PIPE OD
PM4612E	12
PM4615E	15
PM4622E	22

Provides permanent or temporary shut off, see page 12.

PLUG



PART NO.	STEM OD	COLOUR
PM0812R	12	RED
PM0815E	15	BLACK
PM0818E	18	BLACK
PM0822E	22	BLACK
PM0828E	28	BLACK

COMPRESSED AIR FITTINGS

BRASS FITTINGS

WATER TRAP TEE CONVERTOR



PART NO.	SIZE
WTC28	28

Converts a standard tee to a water trap tee, see page 12.

BRASS WINGBACK ELBOW



PART NO.	PIPE OD	THREAD
PM15WB	15	1/2 BSP
PM22WB	22	3/4 BSP

BRASS STRAIGHT ADAPTOR



PART NO.	PIPE OD	THREAD
MM011504N	15	1/2 BSPT
MM012206N	22	3/4 BSPT
MM012808N	28	1 BSPT

MALE BRASS STEM ADAPTOR



PART NO.	STEM OD	THREAD
MM051504N	15	1/2 BSPT
MM052206N	22	3/4 BSPT
MM052818N	28	1 BSP
MM052226N	22	3/4 NPT
MM052228N	22	1 NPT
MM052828N	28	1 NPT

Converts push fit end to male thread.

FEMALE BRASS STEM ADAPTOR



PART NO.	STEM OD	THREAD
MM501514N	15	1/2 BSP
MM502216N	22	3/4 BSP

Converts push fit end to female thread.

Easy to extend a galvanised system.



Using a Straight Adaptor.



Using a Female Stem Adaptor.



Using a Male Stem Adaptor.

John Guest fittings and pipe can form a stand alone system or be used to modify or extend an existing galvanised system.

COMPRESSED AIR PIPE

RIGID NYLON PIPE



PART NO.	SIZE MM X M
PA-RM1209-3M-20B	12 x 3
PA-RM1512-3M-20B	15 x 3
PA-RM1814-3M-20B	18 x 3
PA-RM2218-3M-20B	22 x 3
PA-RM2823-3M-10B	28 x 3

ALUMINIUM PIPE

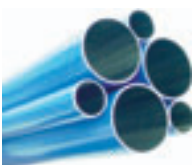

PART NO.	SIZE MM X M
AL-RM1513-3M-20B	15 x 3
AL-RM1816-3M-20B	18 x 3
AL-RM2220-3M-20B	22 x 3
AL-RM2826-3M-10B	28 x 3

ALUMINIUM PIPE CUTTER



PART NO.	PIPE OD
JG-AL-CUTTER15	15
JG-AL-CUTTER18	18
JG-AL-CUTTER22	22
JG-AL-CUTTER28	28

DEBURRING TOOL



PART NO.	PIPE OD
JG-DEBURR	

ACCESSORIES

RELEASE AID



PART NO.	PIPE OD
----------	---------

15RA	15
22RA	22
28RA	28

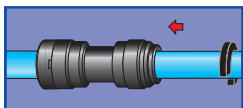

The action of pressure in a system could increase the grip of the collet. The Release Aid allows a firmer grip on the collet while removing the pipe.

COLLET COVERS



PART NO.	PIPE OD	COLOURS
----------	---------	---------

PM1912E	12	BLACK
PM1915E	15	BLACK
PM1918E	18	BLACK
PM1922E	22	BLACK

Collet Covers prevent accidental removal or tampering with piping. The pipe can be inserted with the Collet Cover already attached to the fitting or the cover can slide into position afterwards.

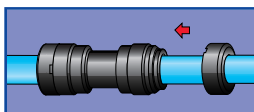

We recommend covers be fitted when pipework is hidden inside walls, ceilings etc.

Collet Covers can be removed to allow the pipe to be disconnected as and when required.

PIPE CLIPS AND SPACERS



CLIP

PART NO.	PIPE OD	COLOURS
----------	---------	---------

PC15E	15	BLACK
PC22E	22	BLACK
PC28E	28	BLACK

SPACER

PART NO.	COLOURS
----------	---------

PCSE	BLACK
------	-------

For Pipe cutters see pages 59-60.



INSTALLING A SYSTEM

Thermoplastics have different properties to steel pipes and so different techniques need to be employed for the installation of the system. For example plastic pipe expands considerably more than metallic pipe, so the method of constraining the pipe needs to be suitable for this expansion to take place. If the pipe is constrained at both ends it will buckle and generate side loads and stress in the pipe. This can be alleviated by an expansion bend in the pipe work. Pipe should be able to slide through mounting brackets. Plastic pipe work is much lighter than that of steel pipe work and so the mountings do not need to be as robust and using John Guest connectors means that the system can be easily modified to any new requirements quickly and without significant specialist tools such as threading equipment and pipe benders. Using John Guest connectors means that no solvents or adhesives need to be employed in the installation. The coefficient of linear expansion of Rigid Nylon pipe is approximately 0.00012 metre per metre length per °C.

John Guest compressed air equipment is suitable to use above ground and below ground but we would strongly suggest that if it is installed below ground that it is installed in conduit so that the pipe can expand with temperature fluctuations and can easily be removed for service or maintenance. John Guest Ltd. would remind all persons involved with installation and service of compressed air systems that reference should be made to “Approved Code of Practice - Safety of Pressure Systems” available from HMSO in the United Kingdom. For installation in other countries, the appropriate Codes of Practice should apply.

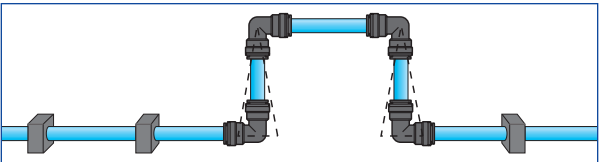

On long pipe runs, it is advisable to install an expansion bend, as shown in the diagram.

Condensate and dirt in the system

It is always desirable to have clean dry air at the outlets of a compressed air system, as condensate and dirt will affect the performance and life of ancillary equipment. We would strongly recommend that a filter be fitted to the system to clean the air and that John Guest Water Trap Tees be used to trap any residue condensate and this should be taken to a “drain off” facility to extract it from the system.

When installing a compressed air system, it is advisable to first attach the horizontal pipe clips and only attach the clips to the vertical pipes after a small amount of pressure has been applied to the system. This will ensure that the vertical pipes have positioned themselves correctly before they are clipped.

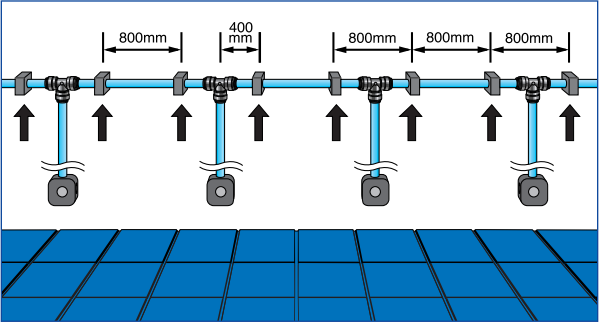

Phase 1: System without pressure

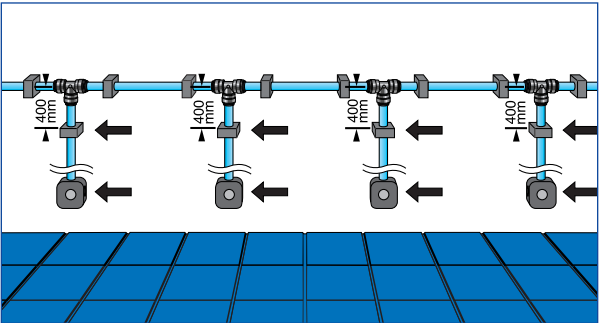

Phase 2: System with pressure

When installing around a column or pillar, maintain a distance of approximately 10cm between the wall and the pipe. Always maintain a distance of 400mm between the fittings and the pipe clip.

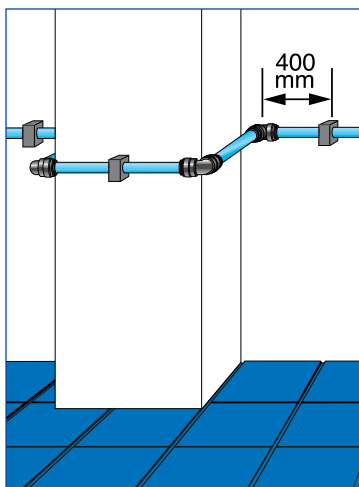

Column/Pillar
smaller than 1 metre

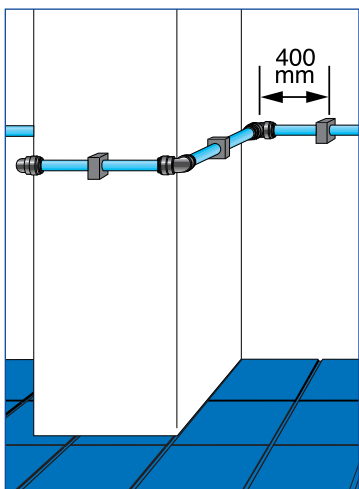
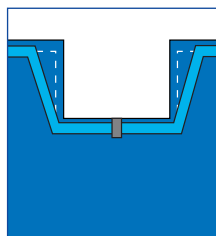

Column/Pillar larger
than 1 metre

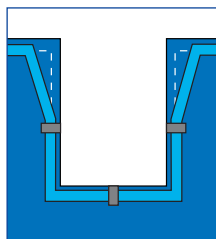

Note: All compressed air systems should be equipped with an air line water trap, we recommend our PMTT22E Water Trap Tee for this purpose (as shown on page 11 of this brochure).

TECHNICAL SPECIFICATION -

Working Temperature Range

Minimum Working Temperature -20°C

Maximum Working Temperature +70°C

The above is for use with air. For below 0°C please consult our Customer Service Department.

Working Pressure

The John Guest Compressed Air System is suitable for the following temperatures and pressures

Temperature

+ 23°C

+ 70°C

Pressure

10 BAR

7 BAR

The above ratings are for air. For use with other fluids or at other temperatures and pressures please contact our Customer Service Department.

Pipe Types

John Guest fittings are intended for use with John Guest nylon pipe but are also suitable for use with a wide range of plastic and soft metal pipes including UPVC, ABS, Polyethylene, Nylon, mild steel and copper to the tolerances set out below. Soft plastic pipe, such as Nylon to have a minimum wall thickness of 1.5mm. The pipe must have a good quality surface and be damage free.

Pipe Tolerances

The John Guest fittings featured in this brochure are intended for pipes with outside diameters to the following tolerances

Size

12mm to 28mm OD

Tolerance

+0.05 to -0.10mm OD

Maximum Torque Values

The following maximum torque values should be applied.

Size

3/8"

1/2"

3/4"

1"

Plastic threads

3.0Nm

3.0Nm

4.0Nm

N/A

Metal threads

N/A

4.0Nm

5.0Nm

N/A

It is recommended that all installations are checked prior to use to determine that a seal has been made. The maximum torque figures quoted for use with John Guest fittings are dependant on the mating thread conforming to the relevant British or International thread standard.

Do not over tighten plastic fittings as this could cause undue stress and eventual failure. Recommended torque figures are shown above and must be adhered to. John Guest recommend OEM Customers consider replacing threaded 'ports' with the modern method of using John Guest Cartridge Systems.

COMPRESSED AIR SYSTEM

Material Specification

The fittings are made up of three components:

Bodies are produced in strong engineering plastic or in brass.

'O' Rings are Nitrile rubber.

Collets are produced in acetal copolymer with stainless steel teeth.

Applications

Pipe and fittings should be kept clean and undamaged before use. These products are designed for use with air. For other applications please contact our Customer Services Department.

The system is not recommended for use with explosive gases, petroleum spirits and other fuels or for central heating systems.

Installations - Our Recommendations

The pressure rating and installation guidelines of the tubing employed must also be considered during the design of compressed air system.

Pipe should be supported at minimum 800mm to prevent excessive load being applied to the fitting. These supports should not be closer than 25mm from the end of the fitting.

John Guest fittings and pipe should only be connected after the air receiver and not direct to a compressor.

We recommend collect covers be fitted when pipework is hidden inside walls and ceilings.

It is recommended that all pipe and fittings installations are pressure tested after installation and before handing over to the final user.

Side Loads

Fittings should not be subject to excessive side loads and should not be used as support brackets. Tubing and fitting should be adequately supported to prevent excessive side loads.

Note: Aluminum pipe should NOT be connected direct to a compressor.



John Guest®

PNEUMATICS FITTINGS

Super Speedfit push-in fittings have been specially designed for miniature pneumatics applications. They provide a fast and secure way of connecting tubes and offer considerable advantages over conventional fittings.

Complex tubing systems can be assembled more rapidly than with traditional methods and because Super Speedfit fittings are easy to disconnect, fault finding and maintenance become much easier operations.

They are particularly useful for development, testing or training programmes where systems may need to be constantly reconfigured.

To make a connection, the tube is simply pushed in by hand; the unique John Guest collet locking system holds the tube firmly in place without deforming it or restricting flow.

**See easy to make a connection
on page 09-10.**

**Technical Specification shown
on pages 61-62.**



Speedfit® Air Products

USER BENEFITS

- Specially designed for pneumatics
- Suitable for plastic and soft metal tubes
- Grips before it seals
- Quick disconnection and reusable
- No tools needed
- Quality Manufacturer - ISO 9001 listed since 1989
- Superior flow characteristics

- Collet cover prevents accidental disconnection and allows colour coding



- Fittings with prefix PM or PI are produced exclusively in Food and Drug Administration approved materials and are therefore recommended for food quality applications.



PNEUMATICS

Metric Size Fittings

SuperThread

Selected metric size items have SuperThread, a unique thread seal developed by John Guest to enable male adaptors to be used with a variety of female thread forms. John Guest fittings with brass bodies incorporating the SuperThread can be used with BSP (Parallel), BSPT (Taper), NPTF, PF and PT metal thread forms.

The special Polyurethane seal feature means no sealant need be applied to make an airtight joint. There is no danger of tape entering the system.

Fittings with SuperThread also have countersunk throughbores to provide superior flow characteristics.

The design allows for a smaller compact body and reduced hexagon size.

Maximum Torque Values for SuperThread are shown on page 62.

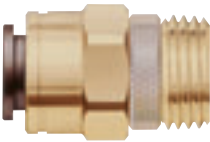

***SuperThread* fits all these metal thread forms.**

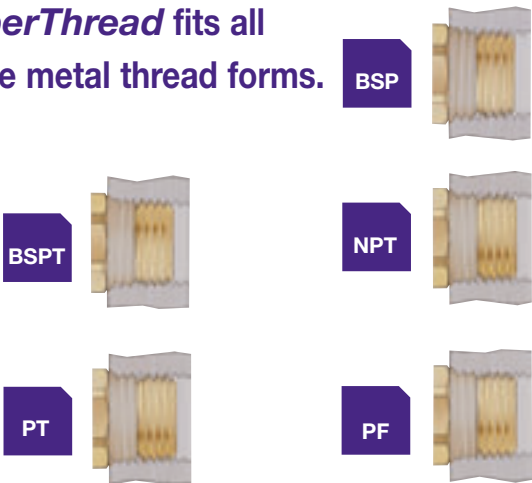

STRAIGHT ADAPTOR SUPERTHREAD



With integral seal.

Thread can be used with BSP, BSPT, NPT, PF and PT.

PART NO.	TUBE OD	SUPER THREAD
RM010411	4	x 1/8
RM010412	4	x 1/4
RM010511	5	x 1/8
RM010512	5	x 1/4
RM010611	6	x 1/8
RM010612	6	x 1/4
RM010811	8	x 1/8
RM010812	8	x 1/4
RM010813	8	x 3/8
RM011012	10	x 1/4
RM011013	10	x 3/8
RM011014	10	x 1/2
RM011213	12	x 3/8
RM011214	12	x 1/2

STRAIGHT ADAPTOR METRIC THREAD



PART NO.	TUBE OD	METRIC THREAD
RM0104M5	4	x M5
RM0105M5	5	x M5
RM0106M5	6	x M5

BRASS STRAIGHT ADAPTOR BSP THREAD



PART NO.	TUBE OD	THREAD BSP
MM010411	4	1/8
MM010611	6	1/8
MM010612	6	1/4
MM010812	8	1/4

STRAIGHT ADAPTOR

BSP THREAD



PART NO.	TUBE OD	THREAD BSP
PM010411E	4 x	1/8
PM010412E	4 x	1/4
PM010511E	5 x	1/8
PM010512E	5 x	1/4
PM010611E	6 x	1/8
PM010612E	6 x	1/4
PM010811E	8 x	1/8
PM010812E	8 x	1/4
PM010813E	8 x	3/8
PM011012E	10 x	1/4
PM011013E	10 x	3/8
PM011014E	10 x	1/2
PM011213E	12 x	3/8
PM011214E	12 x	1/2

STRAIGHT ADAPTOR

BSPT THREAD



PART NO.	TUBE OD	THREAD BSPT
PM010401E	4 x	1/8
PM010402E	4 x	1/4
PM010501E	5 x	1/8
PM010502E	5 x	1/4
PM010601E	6 x	1/8
PM010602E	6 x	1/4
PM010801E	8 x	1/8
PM010802E	8 x	1/4
PM010803E	8 x	3/8
PM011002E	10 x	1/4
PM011003E	10 x	3/8
PM011004E	10 x	1/2
PM011203E	12 x	3/8
PM011204E	12 x	1/2

PART NO.	TUBE OD	THREAD NPTF
----------	------------	----------------

PM010622E 6 x 1/4

EQUAL STRAIGHT CONNECTOR



PART NO.	TUBE OD
RM0404E	4
RM0405E	5
RM0406E	6
RM0408E	8
RM0410E	10
RM0412E	12

EQUAL STRAIGHT CONNECTOR



PART NO.	TUBE OD
PM0404E	4
PM0405E	5
PM0406E	6
PM0408E	8
PM0410E	10
PM0412E	12

REDUCING STRAIGHT CONNECTOR



PART NO.	TUBE OD	TUBE OD
PM200604E	6	4
PM200804E	8	4
PM200806E	8	6
PM201004E	10	4
PM201006E	10	6
PM201008E	10	8
PM201208E	12	8
PM201210E	12	10

EQUAL ELBOW



PART NO.	TUBE OD
RM0304E	4
RM0305E	5
RM0306E	6
RM0308E	8
RM0310E	10
RM0312E	12

EQUAL ELBOW



PART NO.	TUBE OD
PM0304E	4
PM0305E	5
PM0306E	6
PM0308E	8
PM0310E	10
PM0312E	12

For accessories see page 57-58.



REDUCING ELBOW CONNECTOR



PART NO.	TUBE OD	TUBE OD
PM210604E	6	4
PM210804E	8	4
PM210806E	8	6
PM211004E	10	4
PM211006E	10	6
PM211008E	10	8
PM211208E	12	8
PM211210E	12	10

STEM ELBOW



PART NO.	TUBE OD	STEM OD
PM220404E	4	4
PM220505E	5	5
PM220606E	6	6
PM220808E	8	8
PM221010E	10	10
PM221212E	12	12

SWIVEL ELBOW

SUPERTHREAD



With integral seal.

Thread can be used with BSP, BSPT, NPT, PF and PT.

PART NO.	TUBE OD	SUPER THREAD
RM090411	4	x 1/8
RM090412	4	x 1/4
RM090511	5	x 1/8
RM090512	5	x 1/4
RM090611	6	x 1/8
RM090612	6	x 1/4
RM090811	8	x 1/8
RM090812	8	x 1/4
RM090813	8	x 3/8
RM091012	10	x 1/4
RM091013	10	x 3/8
RM091014	10	x 1/2
RM091213	12	x 3/8
RM091214	12	x 1/2

SWIVEL ELBOW

METRIC THREAD



PART NO.	TUBE OD	METRIC THREAD
RM0904M5	4	x M5
RM0905M5	5	x M5
RM0906M5	6	x M5

SWIVEL ELBOW

BSP THREAD



PART NO.	TUBE OD	THREAD BSP
MM090411	4	1/8
MM090611	6	1/8
MM090612	6	1/4
MM090812	8	1/4

SWIVEL ELBOW

BSP THREAD



PART NO.	STEM OD	THREAD BSP
PM090411E	4	x 1/8
PM090412E	4	x 1/4
PM090511E	5	x 1/8
PM090512E	5	x 1/4
PM090611E	6	x 1/8
PM090612E	6	x 1/4
PM090811E	8	x 1/8
PM090812E	8	x 1/4
PM090813E	8	x 3/8
PM091012E	10	x 1/4
PM091013E	10	x 3/8
PM091014E	10	x 1/2
PM091213E	12	x 3/8
PM091214E	12	x 1/2

For sizes 15mm
to 28mm see
pages 13-19.



SWIVEL ELBOW

BSPT THREAD



PART NO.	TUBE OD	THREAD BSPT
PM090401E	4 x	1/8
PM090402E	4 x	1/4
PM090501E	5 x	1/8
PM090502E	5 x	1/4
PM090601E	6 x	1/8
PM090602E	6 x	1/4
PM090801E	8 x	1/8
PM090802E	8 x	1/4
PM090803E	8 x	3/8
PM091002E	10 x	1/4
PM091003E	10 x	3/8
PM091004E	10 x	1/2
PM091203E	12 x	3/8
PM091204E	12 x	1/2

EQUAL TEE



PART NO.	TUBE OD
RM0204E	4
RM0205E	5
RM0206E	6
RM0208E	8
RM0210E	10
RM0212E	12

EQUAL TEE



PART NO.	TUBE OD
PM0204E	4
PM0205E	5
PM0206E	6
PM0208E	8
PM0210E	10
PM0212E	12

SWIVEL TEE

CENTRE LEG BSP THREAD



PART NO.	TUBE OD	THREAD BSP
PM100411E	4 x	1/8
PM100412E	4 x	1/4
PM100511E	5 x	1/8
PM100512E	5 x	1/4
PM100611E	6 x	1/8
PM100612E	6 x	1/4
PM100811E	8 x	1/8
PM100812E	8 x	1/4
PM100813E	8 x	3/8
PM101012E	10 x	1/4
PM101013E	10 x	3/8
PM101014E	10 x	1/2
PM101213E	12 x	3/8
PM101214E	12 x	1/2

SWIVEL TEE

CENTRE LEG BSPT THREAD



PART NO.	TUBE OD	THREAD BSPT
PM100401E	4 x	1/8
PM100402E	4 x	1/4
PM100501E	5 x	1/8
PM100502E	5 x	1/4
PM100601E	6 x	1/8
PM100602E	6 x	1/4
PM100801E	8 x	1/8
PM100802E	8 x	1/4
PM100803E	8 x	3/8
PM101002E	10 x	1/4
PM101003E	10 x	3/8
PM101004E	10 x	1/2
PM101203E	12 x	3/8
PM101204E	12 x	1/2

SWIVEL TEE

SUPERTHREAD



PART NO.	TUBE OD	SUPER THREAD
RM100611	6 x	1/8
RM100612	6 x	1/4

With integral seal.

Thread can be used with BSP, BSPT, NPT, PF and PT.

SWIVEL MALE RUN TEE BSP THREAD



PART NO.	TUBE OD	THREAD BSP
PM110411E	4 x	1/8
PM110412E	4 x	1/4
PM110511E	5 x	1/8
PM110512E	5 x	1/4
PM110611E	6 x	1/8
PM110612E	6 x	1/4
PM110811E	8 x	1/8
PM110812E	8 x	1/4
PM110813E	8 x	3/8
PM111012E	10 x	1/4
PM111013E	10 x	3/8
PM111014E	10 x	1/2
PM111213E	12 x	3/8
PM111214E	12 x	1/2

SWIVEL MALE RUN TEE BSPT THREAD



PART NO.	TUBE OD	THREAD BSPT
PM110401E	4 x	1/8
PM110402E	4 x	1/4
PM110501E	5 x	1/8
PM110502E	5 x	1/4
PM110601E	6 x	1/8
PM110602E	6 x	1/4
PM110801E	8 x	1/8
PM110802E	8 x	1/4
PM110803E	8 x	3/8
PM111002E	10 x	1/4
PM111003E	10 x	3/8
PM111004E	10 x	1/2
PM111203E	12 x	3/8
PM111204E	12 x	1/2

BRASS BULKHEAD CONNECTOR

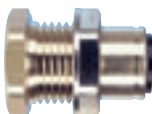

PART NO.	TUBE OD
RM070411	4
RM070511	5
RM070612	6
RM070812	8
RM071013	10
RM071214	12

BULKHEAD CONNECTOR



PART NO.	TUBE OD
RM1206	6
RM1208	8

BULKHEAD CONNECTOR



PART NO.	TUBE OD
PM1204E	4
PM1205E	5
PM1206E	6
PM1208E	8
PM1210E	10
PM1212E	12

REDUCER



PART NO.	STEM OD	TUBE OD
PM060504E	5	4
PM060604E	6	4
PM060605E	6	5
PM060804E	8	4
PM060805E	8	5
PM060806E	8	6
PM061006E	10	6
PM061008E	10	8
PM061208E	12	8
PM061210E	12	10

For sizes 15mm
to 28mm see
pages 13-19.



ENLARGER



PART NO.	TUBE OD	STEM OD
PM130405E	5 x	4

PLUG



PART NO.	STEM OD
PM0804R	4
PM0805R	5
PM0806R	6
PM0808R	8
PM0810R	10
PM0812R	12

4mm - 12mm sizes in red.

8mm size also available in black Part No. PM0808E

STEM ADAPTOR

SUPERTHREAD

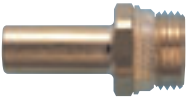

With integral seal.

Thread can be used with BSP, BSPT, NPT, PF and PT.

PART NO.	TUBE OD	SUPER THREAD
RM050411	4 x	1/8
RM050412	4 x	1/4
RM050511	5 x	1/8
RM050512	5 x	1/4
RM050611	6 x	1/8
RM050612	6 x	1/4
RM050811	8 x	1/8
RM050812	8 x	1/4
RM050813	8 x	3/8
RM051012	10 x	1/4
RM051013	10 x	3/8
RM051014	10 x	1/2
RM051213	12 x	3/8
RM051214	12 x	1/2

STEM ADAPTOR

METRIC THREAD



PART NO.	TUBE OD	METRIC THREAD
RM0504M5	4 x	M5
RM0505M5	5 x	M5
RM0506M5	6 x	M5

STEM ADAPTOR

BSP THREAD



PART NO.	STEM OD	THREAD BSP
PM050411E	4 x	1/8
PM050412E	4 x	1/4
PM050511E	5 x	1/8
PM050512E	5 x	1/4
PM050611E	6 x	1/8
PM050612E	6 x	1/4
PM050811E	8 x	1/8
PM050812E	8 x	1/4
PM050813E	8 x	3/8
PM051012E	10 x	1/4
PM051013E	10 x	3/8
PM051014E	10 x	1/2
PM051213E	12 x	3/8
PM051214E	12 x	1/2

STEM ADAPTOR

BSPT THREAD



PART NO.	STEM OD	THREAD BSPT
PM050401E	4 x	1/8
PM050402E	4 x	1/4
PM050501E	5 x	1/8
PM050502E	5 x	1/4
PM050601E	6 x	1/8
PM050602E	6 x	1/4
PM050801E	8 x	1/8
PM050802E	8 x	1/4
PM050803E	8 x	3/8
PM051002E	10 x	1/4
PM051003E	10 x	3/8
PM051004E	10 x	1/2
PM051203E	12 x	3/8
PM051204E	12 x	1/2

TWO-WAY DIVIDER



PART NO.	TUBE OD
RPM2304E	4
RM2306E	6
RM2308E	8
RM2312E	12

For accessories see page 57-58.



TWO-WAY DIVIDER



PART NO.	TUBE OD
PM2304E	4
PM2308E	8
PM2310E*	10

*new

TUBE TO HOSE STEM



PART NO.	STEM OD	HOSE ID
PM250604E	6	4
PM250806E	8	6
PM251008E	10	8

FEMALE ADAPTOR



PART NO.	TUBE OD	THREAD
PM450411E	4 x	1/8 BSP
PM450611E	6 x	1/8 BSP
PM450612E	6 x	1/4 BSP
PM450812E	8 x	1/4 BSP
PM4508F4S	8 x	7/16X20UNF
PM4508C5S	8 x	1/2-16UNS
PM451015FE	10 x	5/8 BSP

OFFSET CONNECTOR



PART NO.	TUBE OD	TUBE OD
NC657	12	8

For sizes 15mm to 28mm see pages 13-19.



Banjo Stem and Bodies

Maximum Torque Values for threads on Banjo Stems are shown on page 62.



SINGLE BANJO BODY



Designed to be used with Banjo Stems listed below.

PART NO.	TUBE OD	THREAD
RM150411E	4	x 1/8
RM150511E	5	x 1/8
RM150611E	6	x 1/8
RM150812E	8	x 1/4
RM151013E	10	x 3/8
RM151214E	12	x 1/2

BANJO STEM SINGLE



Designed for use with John Guest Banjo Bodies. Sealing washers not required on Stem and Body assemblies.

PART NO.	STEM THREAD BSP
RM1611	1/8
RM1612	1/4
RM1613	3/8
RM1614	1/2

BANJO STEM DOUBLE



Designed for use with John Guest Banjo Bodies. Sealing washers not required on Stem and Body assemblies.

PART NO.	STEM THREAD BSP
RM1711	1/8
RM1712	1/4
RM1713	3/8
RM1714	1/2

Banjo Flow Control

Banjo Flow Controls are designed for installation directly into cylinder ports to give precise control. They regulate the speed of pneumatic cylinders and other actuators.

John Guest Controls provide a neat compact assembly which can be orientated to a suitable position for the circuit arrangement prior to tightening.

The design offers especially precise adjustment through the control needle which is captive within its housing.

Suitable for both soft metal and plastic tubing.

Maximum Torque Values are shown on page 62.

Technical Specifications

ISO 1219-1 : 1991

Temperature Range 5°C - 70°C
Working Pressure Range 0.5 Bar to 10 Bar

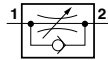

Materials used

Acetal Copolymer, Brass, Stainless Steel and Nitrile.

Filtration

Air supply should be filtered to 50 micron.

Typical Response Curve

Response curve for Banjo Flow Control with Screwdriver slot.
 Pattern No. BFC360611E

1 scfm = 28.3 litres/min.
 or 28317 cc/min.
 @ 1 atmosphere discharge

(For 6mm x 1/8 BSP Banjo Flow Control)

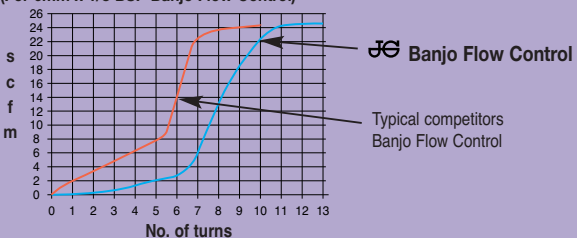

Speedfit® Air Products

BANJO FLOW CONTROL MANUAL ADJUSTMENT



PART NO.	TUBE OD	THREAD
CFM3604M5E	4 x	M5
CFM360411E	4 x	1/8 BSP
CFM360611E	6 x	1/8 BSP
CFM360612E	6 x	1/4 BSP
CFM360812E	8 x	1/4 BSP

BANJO FLOW CONTROL SCREWDRIVER SLOT



PART NO.	TUBE OD	THREAD
LM1503M3E	3 x	M3
BFC3604M5E	4 x	M5
BFC360411E	4 x	1/8 BSP
BFC360611E	6 x	1/8 BSP
BFC360612E	6 x	1/4 BSP
BFC360812E	8 x	1/4 BSP
BFC361013E	10 x	3/8 BSP
BFC361214E	12 x	1/2 BSP

Miniature Fittings

A new range of 4mm fittings especially designed for miniature pneumatics applications.

LM fittings are suitable for use with plastic (Polyethylene, Nylon and Polyurethane) and soft metal (copper and mild steel) tubes with an outside diameter of 4mm +0.05/ - 0.07. The tube to have a smooth outer surface and be free from burrs.

Tube inserts should be used for soft or thin wall tubing or when using Polyurethane tube above 10 Bar to a maximum of 16 Bar.

M3 and M5 threaded ends are designed to be hand tightened. They should not be tightened above the maximum torque figures shown on page 62.



STRAIGHT ADAPTOR METRIC THREAD



PART NO.	TUBE OD		THREAD
LM0103M3*	3	x	M3
LM0104M3	4	x	M3
LM0104M5	4	x	M5

*new

STRAIGHT ADAPTOR SUPERTHREAD



PART NO.	TUBE OD		THREAD
LM010411	4	x	1/8

With integral seal.

Thread can be used with BSP, BSPT, NPT, PF and PT.

EQUAL STRAIGHT CONNECTOR



PART NO.	TUBE OD
LM0403E*	3
LM0404E	4

*new

Speedfit® Air Products

EQUAL TEE



PART NO.	TUBE OD
LM0203E*	3
LM0204E	4

*new

EQUAL ELBOW



PART NO.	TUBE OD
LM0303E*	3
LM0304E	4

*new

SWIVEL ELBOW

METRIC THREAD



PART NO.	TUBE OD		METRIC THREAD
LM0903M3*	3	x	M3
LM0904M3	4	x	M3
LM0904M5	4	x	M5

*new

TUBE INSERT



PART NO.	TUBE OD
LMTS04	4

PNEUMATICS

Imperial Size Fittings

Produced in a grey acetal copolymer in sizes 5/32" to 1/2". They provide a fast, secure way of connecting tube using the well established Speedfit Concept.

STRAIGHT ADAPTOR BSPT THREAD



PART NO.	TUBE OD	THREAD BSPT
PM010401S	5/32	x 1/8
PM010402S	5/32	x 1/4
PI010601S	3/16	x 1/8
PI010602S	3/16	x 1/4
PI010801S	1/4	x 1/8
PI010802S	1/4	x 1/4
PM010801S	5/16	x 1/8
PM010802S	5/16	x 1/4
PM010803S	5/16	x 3/8
PI011202S	3/8	x 1/4
PI011203S	3/8	x 3/8
PI011603S	1/2	x 3/8
PI011604S	1/2	x 1/2

STRAIGHT ADAPTOR BSP THREAD



For use with spot face ports.

PART NO.	TUBE OD	THREAD BSP
PI010812S	1/4	x 1/4
PI011212S	3/8	x 1/4

STRAIGHT ADAPTOR BSP THREAD



With special large seal for use with chamfered face ports.

PART NO.	TUBE OD	THREAD BSP
NCPI011211S	3/8	x 1/8
NCPI011212S	3/8	x 1/4

Speedfit® Air Products

STRAIGHT ADAPTOR NPTF THREAD



PART NO.	TUBE OD	THREAD NPTF
PM010421S	5/32 x	1/8
PM010422S	5/32 x	1/4
PI010621S	3/16 x	1/8
PI010821S	1/4 x	1/8
PI010822S	1/4 x	1/4
PI010823S	1/4 x	3/8
PM010821S	5/16 x	1/8
PM010822S	5/16 x	1/4
PM010823S	5/16 x	3/8
PI011221S	3/8 x	1/8
PI011222S	3/8 x	1/4
PI011223S	3/8 x	3/8
PI011224S	3/8 x	1/2
PI011623S	1/2 x	3/8
PI011624S	1/2 x	1/2
PI012026S	5/8 x	3/4

EQUAL STRAIGHT CONNECTOR



PART NO.	TUBE OD
PM0404S	5/32
PI0406S	3/16
PI0408S	1/4
PM0408S	5/16
PI0412S	3/8
PI0416S	1/2

REDUCING STRAIGHT CONNECTOR



PART NO.	TUBE OD	TUBE OD
PI200806S	1/4	- 3/16
PM200804S	5/16	- 5/32
PI201006S	5/16	- 3/16
PI201008S	5/16	- 1/4
PI201206S	3/8	- 3/16
PI201208S	3/8	- 1/4
PI201210S	3/8	- 5/16
PI201610S	1/2	- 5/16
PI201612S	1/2	- 3/8

EQUAL ELBOW



PART NO.	TUBE OD
PM0304S	5/32
PI0306S	3/16
PI0308S	1/4
PM0308S	5/16
PI0312S	3/8
PI0316S	1/2

REDUCING ELBOW



PART NO.	TUBE OD	TUBE OD
PM210804S	5/16	- 5/32
PI211006S	5/16	- 3/16
PI211008S	5/16	- 1/4
PI211206S	3/8	- 3/16
PI211208S	3/8	- 1/4
PI211210S	3/8	- 5/16
PI211610S	1/2	- 5/16
PI211612S	1/2	- 3/8

STEM ELBOW



PART NO.	STEM OD	TUBE OD
PM220404S	5/32	- 5/32
PI220606S	3/16	- 3/16
PI220808S	1/4	- 1/4
PM220808S	5/16	- 5/16
PI221206S	3/8	- 3/16
PI221208S	3/8	- 1/4
PI221210S	3/8	- 5/16
PI221212S	3/8	- 3/8
PI221616S	1/2	- 1/2

For accessories see page 57-58.



RIGID ELBOW

NPTF THREAD



PART NO.	TUBE OD	THREAD NPTF
PI480821S	1/4	x 1/8
PI480822S	1/4	x 1/4
PI480823S	1/4	x 3/8
PI481222S	3/8	x 1/4
PI481223S	3/8	x 3/8
PI482024S	5/8	x 1/2

SWIVEL ELBOW

BSPT THREAD



PART NO.	TUBE OD	THREAD BSPT
PI090601S	3/16	x 1/8
PI090801S	1/4	x 1/8
PI090802S	1/4	x 1/4
PM090801S	5/16	x 1/8
PM090802S	5/16	x 1/4
PM090803S	5/16	x 3/8
PI091202S	3/8	x 1/4
PI091203S	3/8	x 3/8
PI091603S	1/2	x 3/8
PI091604S	1/2	x 1/2

SWIVEL ELBOW

NPTF THREAD



PART NO.	TUBE OD	THREAD NPTF
PM090421S	5/32	x 1/8
PM090422S	5/32	x 1/4
PI090621S	3/16	x 1/8
PI090821S	1/4	x 1/8
PI090822S	1/4	x 1/4
PM090821S	5/16	x 1/8
PM090822S	5/16	x 1/4
PM090823S	5/16	x 3/8
PI091222S	3/8	x 1/4
PI091223S	3/8	x 3/8
PI091623S	1/2	x 3/8
PI091624S	1/2	x 1/2

EQUAL TEE



PART NO.	TUBE OD
PM0204S	5/32
PI0206S	3/16
PI0208S	1/4
PM0208S	5/16
PI0212S	3/8
PI0216S	1/2

REDUCING TEE



PART NO.	TUBE OD ENDS	TUBE OD BRANCH
PI301208S	3/8	- 1/4
PI301612S	1/2	- 3/8

SWIVEL BRANCH TEE BSPT THREAD



PART NO.	TUBE OD	THREAD BSPT
PI100601S	3/16	x 1/8
PI100801S	1/4	x 1/8
PI100802S	1/4	x 1/4
PM100801S	5/16	x 1/8
PM100802S	5/16	x 1/4
PM100803S	5/16	x 3/8
PI101202S	3/8	x 1/4
PI101203S	3/8	x 3/8
PI101603S	1/2	x 3/8
PI101604S	1/2	x 1/2

SWIVEL BRANCH TEE NPTF THREAD



PART NO.	TUBE OD	THREAD NPTF
PM100421S	5/32	x 1/8
PM100422S	5/32	x 1/4
PI100621S	3/16	x 1/8
PI100821S	1/4	x 1/8
PI100822S	1/4	x 1/4
PM100821S	5/16	x 1/8
PM100822S	5/16	x 1/4
PM100823S	5/16	x 3/8
PI101222S	3/8	x 1/4
PI101223S	3/8	x 3/8
PI101623S	1/2	x 3/8
PI101624S	1/2	x 1/2

SWIVEL MALE RUN TEE BSPT THREAD



PART NO.	TUBE OD	THREAD BSPT
PI110601S	3/16	x 1/8
PI110801S	1/4	x 1/8
PI110802S	1/4	x 1/4
PM110801S	5/16	x 1/8
PM110802S	5/16	x 1/4
PM110803S	5/16	x 3/8
PI111202S	3/8	x 1/4
PI111203S	3/8	x 3/8
PI111603S	1/2	x 3/8
PI111604S	1/2	x 1/2

SWIVEL MALE RUN TEE NPTF THREAD



* Obtained by using an Equal Tee and a Stem Adaptor.

PART NO.	TUBE OD	THREAD NPTF
PM110421S	5/32	x 1/8*
PM110422S	5/32	x 1/4*
PI110621S	3/16	x 1/8
PI110821S	1/4	x 1/8
PI110822S	1/4	x 1/4
PM110821S	5/16	x 1/8*
PM110822S	5/16	x 1/4
PM110823S	5/16	x 3/8*
PI111222S	3/8	x 1/4
PI111223S	3/8	x 3/8
PI111623S	1/2	x 3/8*
PI111624S	1/2	x 1/2*

John Guest **Adaptability**

Standard **Super Speedfit** products can be coupled together to form integral new fittings.

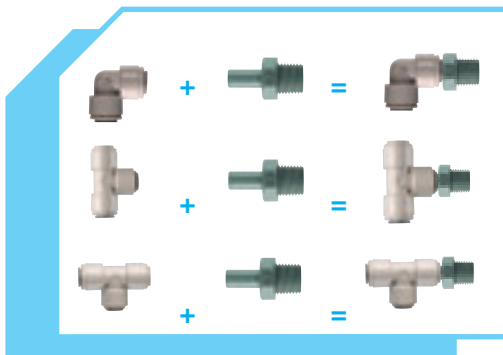

FEMALE ADAPTOR BSP THREAD - FLAT END

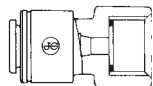

PART NO.	TUBE OD	THREAD BSP
----------	---------	------------

PI451014FS	5/16	x 1/2
PI451015FS	5/16	x 5/8
PI451213S	3/8	x 3/8
PI451214FS	3/8	x 1/2
PI451215FS	3/8	x 5/8
PI451613S	1/2	x 3/8
PI451615FS	1/2	x 5/8

FEMALE ADAPTOR NPTF THREAD

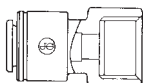

PART NO.	TUBE OD	THREAD NPTF
----------	---------	-------------

PI450822S	1/4	x 1/4
PI451222S	3/8	x 1/4

THREE WAY DIVIDER



PART NO.	TUBE OD INLET	TUBE OD OUTLET
----------	---------------	----------------

PI491612S	1/2	- 3/8
-----------	-----	-------

TWO-WAY DIVIDER



PART NO.	TUBE OD
----------	---------

PI2308S	1/4
PM2308S	5/16
PI2312S	3/8
PI2316S*	1/2

*new

UNEQUAL TWO-WAY DIVIDER



PART NO.	TUBE OD INLET	TUBE OD OUTLET
PI241210S	3/8	- 5/16

BULKHEAD CONNECTOR



PART NO.	TUBE OD
PM1204S	5/32
PI1206S	3/16
PI1208S	1/4
PM1208S	5/16
PI1212S	3/8
PI1216S	1/2

REDUCING BULKHEAD CONNECTOR



PART NO.	TUBE OD	TUBE OD
PI121208S	3/8	- 1/4

For accessories
see pages 57-58.



STEM ADAPTOR

BSPT THREAD



PART NO.	STEM OD	THREAD BSPT
PM050401S	5/32	x 1/8
PM050402S	5/32	x 1/4
PI050601S	3/16	x 1/8
PI050801S	1/4	x 1/8
PI050802S	1/4	x 1/4
PM050801S	5/16	x 1/8
PM050802S	5/16	x 1/4
PM050803S	5/16	x 3/8
PI051202S	3/8	x 1/4
PI051203S	3/8	x 3/8
PI051603S	1/2	x 3/8
PI051604S	1/2	x 1/2

STEM ADAPTOR

BSP THREAD



PART NO.	STEM OD	THREAD BSP
PM050812S	5/16	x 1/4
PI051212S	3/8	x 1/4
PI051213S	3/8	x 3/8

STEM ADAPTOR

NPTF THREAD



PART NO.	STEM OD	THREAD NPTF
PM050421S	5/32	x 1/8
PM050422S	5/32	x 1/4
PI050621S	3/16	x 1/8
PI050821S	1/4	x 1/8
PI050822S	1/4	x 1/4
PI050823S	1/4	x 3/8
PM050821S	5/16	x 1/8
PM050822S	5/16	x 1/4
PM050823S	5/16	x 3/8
PI051222S	3/8	x 1/4
PI051223S	3/8	x 3/8
PI051623S	1/2	x 3/8
PI051624S	1/2	x 1/2

REDUCER



PART NO.	STEM OD	TUBE OD
PI060605S	3/16	- 5/32
PI061006S	5/16	- 3/16
PI061008S	5/16	- 1/4
PI061206S	3/8	- 3/16
PI061208S	3/8	- 1/4
PI061210S	3/8	- 5/16
PI061610S	1/2	- 5/16
PI061612S	1/2	- 3/8

ENLARGER



PART NO.	TUBE OD	STEM OD
PI131012S	3/8	- 5/16
PI131216S	1/2	- 3/8

OFFSET CONNECTOR



PART NO.	TUBE OD	TUBE OD
NC641	1/2	- 5/16

U-BEND



PART NO.

TUBE
OD

PIUB16S

1/2

CROSS



PART NO.

TUBE
OD

PI4712S

3/8

END STOP



PART NO.

TUBE
OD

PI4608S

1/4

PI4612S

3/8

PLUG



PART NO.	STEM OD
PM0804S	5/32
PI0806S	3/16
PI0808S	1/4
PM0808S	5/16
PI0812S	3/8
PI0816S	1/2

TUBE TO HOSE STEM



PART NO.	STEM OD	HOSE ID
PI250806S	1/4	- 3/16
PI250808S	1/4	- 1/4
PI250810S	1/4	- 5/16
PI251006S	5/16	- 3/16
PI251008S	5/16	- 1/4
PM250808S	5/16	- 5/16
PI251012S	5/16	- 3/8
PI251208S	3/8	- 1/4
PI251210S	3/8	- 5/16
PI251212S	3/8	- 3/8
PI251216S	3/8	- 1/2
PI251612S	1/2	- 3/8
PI251616S	1/2	- 1/2

TUBE TO HOSE ELBOW



PART NO.	STEM OD	HOSE ID
PI290808S	1/4	- 1/4
PI290810S	1/4	- 5/16
PI291008S	5/16	- 1/4
PM290808S	5/16	- 5/16
PI291208S	3/8	- 1/4
PI291210S	3/8	- 5/16

ACCESSORIES

COLLET COVERS

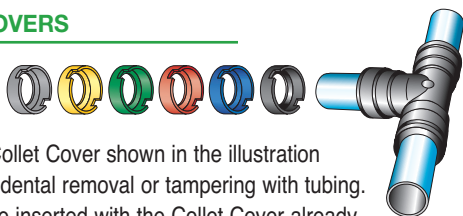

The slip-on Collet Cover shown in the illustration prevents accidental removal or tampering with tubing. Tubing can be inserted with the Collet Cover already attached to the fittings or the cover can slide into position afterwards. The cover is easily removed when required and comes in a variety of colours for colour coding.

Colours available - Suffix indicates colours

E = Black Y = Yellow B = Blue R = Red S = Grey G = Green

IMPERIAL SIZE

PART NO.	TUBE OD
PM1904S	5/32
PI1906S	3/16
PI1908S	1/4
PM1908S	5/16
PI1912S	3/8
PI1916S	1/2

Please indicate by suffix, colour required or grey will be supplied.

METRIC SIZE

PART NO.	TUBE OD
PM1904E	4
PM1905E	5
PM1906E	6
PM1908E	8
PM1910E	10
PM1912E	12
PM1915E	15
PM1918E	18
PM1922E	22

15mm to 22mm sizes available in black as standard, white red or blue

Please indicate by suffix, colour required or black will be supplied.

FLOW BEND CLIP



Designed to support tube and eliminate kinking.

PART NO.	TUBE OD
PM2608S	8mm/5/16
PM2610S	10mm/3/8

HEAVY DUTY PIPE CUTTER



PART NO.	PART NO.
HDC	HDC BLADE ONLY

For up to and including 28mm pipe

PIPE CUTTER



Suitable for up to 22mm tube.

PART NO.

JG-TS

TUBE CUTTER



Suitable for up to 12mm tube.

PART NO.

TS NIP

PART NO.

BLADES

TUBE INSERT



PART NO.

TSI250S

TSI312S

TSI375S

TUBE
ID

1/4

5/16

3/8

COLLET LOCKING TOOL



PART NO.

ICLT/2

SIZE

3/16 to 1/2

LOCKING CLIP



Secures the collet in its position to prevent an accidental disconnection of the tube.

PART NO.

PIC1808R

PMC1808R

PIC1812R

PIC1816R

PMC1815R

TUBE
OD

1/4

5/16

3/8

1/2

15mm

LLDPE TUBING

John Guest Linear Low Density Polyethylene Tubing is suitable for a wide range of temperature and pressures, has a broad chemical compatibility and is made from non contaminating materials.

The tubing is suitable for pneumatics applications maximum pressure 10 Bar @ 20°C. At elevated temperatures, (50°C), mineral oil used in some systems will degrade LLDPE tube and therefore, LLDPE tube used in pneumatic circuits should be periodically checked and replaced if necessary.

Minimum Order Quantities

Popular items highlighted in red are generally in stock and available in minimum order quantities of 2 coils. Other items may be subject to a longer lead time and are available in minimum order quantities of 50 coils.

4MM OD x 2.5MM ID - 100M COILS

PART NO.	COLOUR
----------	--------

PE-04025-0100M-N	Natural
PE-04025-0100M-B	Blue
PE-04025-0100M-R	Red
PE-04025-0100M-E	Black
PE-04025-0100M-W	White
PE-04025-0100M-G	Green
PE-04025-0100M-Y	Yellow
PE-04025-0100M-O	Orange
PE-04025-0100M-V	Violet

6MM OD x 4MM ID - 100M COILS

PART NO.	COLOUR
----------	--------

PE-0604-0100M-N	Natural
PE-0604-0100M-B	Blue
PE-0604-0100M-R	Red
PE-0604-0100M-E	Black
PE-0604-0100M-W	White
PE-0604-0100M-Y	Yellow
PE-0604-0100M-G	Green
PE-0604-0100M-O	Orange
PE-0604-0100M-V	Violet

8MM OD x 6MM ID) - 100M COILS

PART NO.	COLOUR
PE-0806-0100M-N	Natural
PE-0806-0100M-B	Blue
PE-0806-0100M-E	Black
PE-0806-0100M-W	White
PE-0806-0100M-R	Red
PE-0806-0100M-Y	Yellow
PE-0806-0100M-G	Green
PE-0806-0100M-O	Orange
PE-0806-0100M-V	Violet

10MM OD x 7MM ID - 100M COILS

PART NO.	COLOUR
PE-1007-0100M-N	Natural
PE-1007-0100M-B	Blue
PE-1007-0100M-R	Red
PE-1007-0100M-E	Black
PE-1007-0100M-W	White
PE-1007-0100M-G	Green
PE-1007-0100M-Y	Yellow
PE-1007-0100M-O	Orange
PE-1007-0100M-V	Violet

12MM OD x 9MM ID - 100M COILS

PART NO.	COLOUR
PE-1209-0100M-N	Natural
PE-1209-0100M-B	Blue
PE-1209-0100M-R	Red
PE-1209-0100M-E	Black
PE-1209-0100M-Y	Yellow
PE-1209-0100M-W	White
PE-1209-0100M-G	Green
PE-1209-0100M-O	Orange
PE-1209-0100M-V	Violet

15MM OD x 11.5MM ID - 100M COILS

PART NO.	COLOUR
PE-15115-0100M-B	Blue
PE-15115-0100M-R	Red
PE-15115-0100M-G	Green

Inch size tube is also available.
See separate catalogue.

TECHNICAL SPECIFICATION -

Working Temperature Range (Air)

Minimum Working Temperature = -20°C

Maximum Working Temperature = +70°C

Also suitable for vacuum.

Working Pressure

Super Speedfit fittings are suitable for the following pressure.

Temperature	Size	
	4mm- 8mm 5/32" - 5/16"	10mm - 12mm 3/8" - 1/2"
- 20°C	16 Bar	10 Bar
+23°C	16 Bar	10 Bar
+70°C	10 Bar	7 Bar

The above ratings are for air when **Super Speedfit** fittings are used with John Guest Nylon Tube. For use with other fluids or other tube or at other temperatures and pressures, please consult our Customer Services Department.

Tube Types

Plastic Tube

Polyethylene, Nylon and Polyurethane conforming to the tolerances shown below. For soft tubing or thin wall tube we recommend the use of tube inserts.

The recommended minimum ID of Nylon tubes is shown in the table below.

Braided Tube

Use of Tube to Hose Stems and Elbows is essential when using braided tube. Use of clamps to retain braided tube on barbs is recommended.

Metal Tube (soft)

Brass, copper or mild steel conforming to the tolerances below.

Metal Tube (hard)

We do not recommend Super Speedfit Fittings for hard metal tubes.

It is essential that outside diameters be free from score marks and that the tube be deburred before inserting into the fitting.

Tube Tolerances

Super Speedfit fittings are offered for Nylon tube with the following dimensions:-

Size (Inches)	5/32 - 3/16	1/4 - 1/2
Tolerance (Inches)	+0.001 / -0.003	+0.001 / -0.004
Size (mm)	4mm- 5mm	6mm - 22mm
Tolerance (mm)	+0.05 / -0.07	+0.05 / -0.10

PNEUMATICS FITTINGS

Side Loads

Fittings should not be subject to excessive side loads and should not be used as support brackets. Tubing and fitting should be adequately supported to prevent excessive side loads.

Material Specifications

The fittings are made up of three components:

Bodies

Bodies are produced in an acetal copolymer engineering plastic, especially suitable for pneumatics and corrosion free applications. Selected bodies and body parts are brass.

'O' rings

Are Nitrile rubber.

Collets

Are produced in acetal copolymer with stainless steel teeth.

Chemicals

For use with chemicals or other potentially aggressive liquids, please refer to our Customer Services Department.

Super Speedfit fittings are not recommended for use with explosive gases, petroleum spirits, and other fuels or for central heating heating systems.

Installation and System Testing

Fittings and tube should be kept clean and undamaged before use.

All tube and fittings installations must be pressure tested after installation to ensure system integrity before handing over to the final user. See also "Easy to make a connection" on page 09.

Maximum Torque Value in Nm

	M3	M5	1/8	1/4	3/8	1/2
Plastic Threads	-	-	1.5	1.5	3.0	3.0
Metal Threads						
LM Range	0.5	1.5	6.0	-	-	-
Superthread	-	-	6.0	10.0	10.0	10.0
Banjo Systems	-	-	6.0	10.0	10.0	10.0
Banjo Flow Controls	-	1.5	4.0	10.0	-	-
Metric threaded Fittings	-	0.7	-	-	-	-

A. It is recommended that all installations are checked prior to use to determine that a seal has been made.

B. The maximum torque figures quoted for the use with John Guest fittings are dependent on the mating thread conforming to the relevant British or international thread standard.

Do not over tighten plastic fittings as this could cause undue stress and eventual failure. Recommended torque figures are shown above and must be adhered to. John Guest recommend OEM Customers consider replacing threaded 'ports' with the modern method of using John Guest Cartridge Systems.

PRODUCT SELECTION AND INSTALLATION

John Guest fittings and related products are specifically designed and manufactured by John Guest to the Technical Specification set out in the John Guest Product Catalogues. All John Guest fittings and related products should be selected, installed, used and maintained in accordance with these Technical Specifications. It is the customer's / user's responsibility to ensure that John Guest fittings and related products are suitable for their intended applications, are properly installed and maintained and are used in accordance with the Technical Specifications. It is also the customer's / user's responsibility to provide it's own customers with any relevant technical information about John Guest products it supplies them. If you have any questions about our technical specifications, please contact us.

Maintenance and Replacement Intervals

John Guest products generally require little maintenance but as a minimum we recommend routine visual inspection. Frequency of visual inspection will depend on severity of application and risk of failure. If after visual inspection John Guest products appear to be damaged, cracked, charred, discoloured, heat distorted, corroded or leaking they should be replaced.

Product life is affected by the severity of the application, the hostility of the working environment, and contact with aggressive chemicals or liquids. It is therefore, important that specific replacement intervals be considered by specifiers/users/customers based on previous service life or when failure could result in unacceptable downtime, damage or injury risk.

Speedfit® Air Products

The company has a policy of continuous research and development and reserves the right to amend without notice the specification and design of all products illustrated in this catalogue. John Guest reserve the right to change the colour and shape of products. Photographs are for illustration purposes only.

Cleaners and Sanitising Acetal Fittings

Our advice to customers is to use cleaners and sanitising agents that are above pH4 and low in hypochlorite level. Acetal fittings and parts that are cleaned and/or sanitised should be rinsed immediately with copious amounts of clean tap water to remove all traces of the cleaners. Details of which products are made from acetal are shown in our catalogues but generally John Guest products incorporating acetal are designated by the part number prefix PI, PM, CI, CM and RM. Polypropylene fittings offer greater resistance to aggressive chemicals than acetal fittings. Polypropylene does not have the same mechanical properties as acetal and John Guest polypropylene fittings are generally designated by the part number prefix PP. Our material suppliers recommend ECOLAB Oasis 133 as a suitable external cleaner for acetal products manufactured by John Guest.

Warranty

While we give a warranty against defects in manufacture or materials, it is the responsibility of the specifier to ensure that fittings and related products are suitable for their application. The installation must be carried out correctly in accordance with our recommendations, complying with recognised codes of practice and relevant national standards, and be properly maintained. Please refer to our terms and conditions of sale.