

The Mediatek logo is a white parallelogram with the word "MEDIATEK" in black, uppercase, sans-serif font inside it.

MEDIATEK

Facing Test Challenges in Upcoming AI/5G-based Systems – Opportunity for Radical Ideas

SWTW Asia 2018

Harry H. Chen

IC Testing Scientist

Computing and Artificial Intelligence Technology Group

October 19, 2018

Outline

- **MediaTek Overview**
- **AI/5G-enabled Systems**
- **Test Challenges**
- **Systems Orientation**
- **New Opportunities**

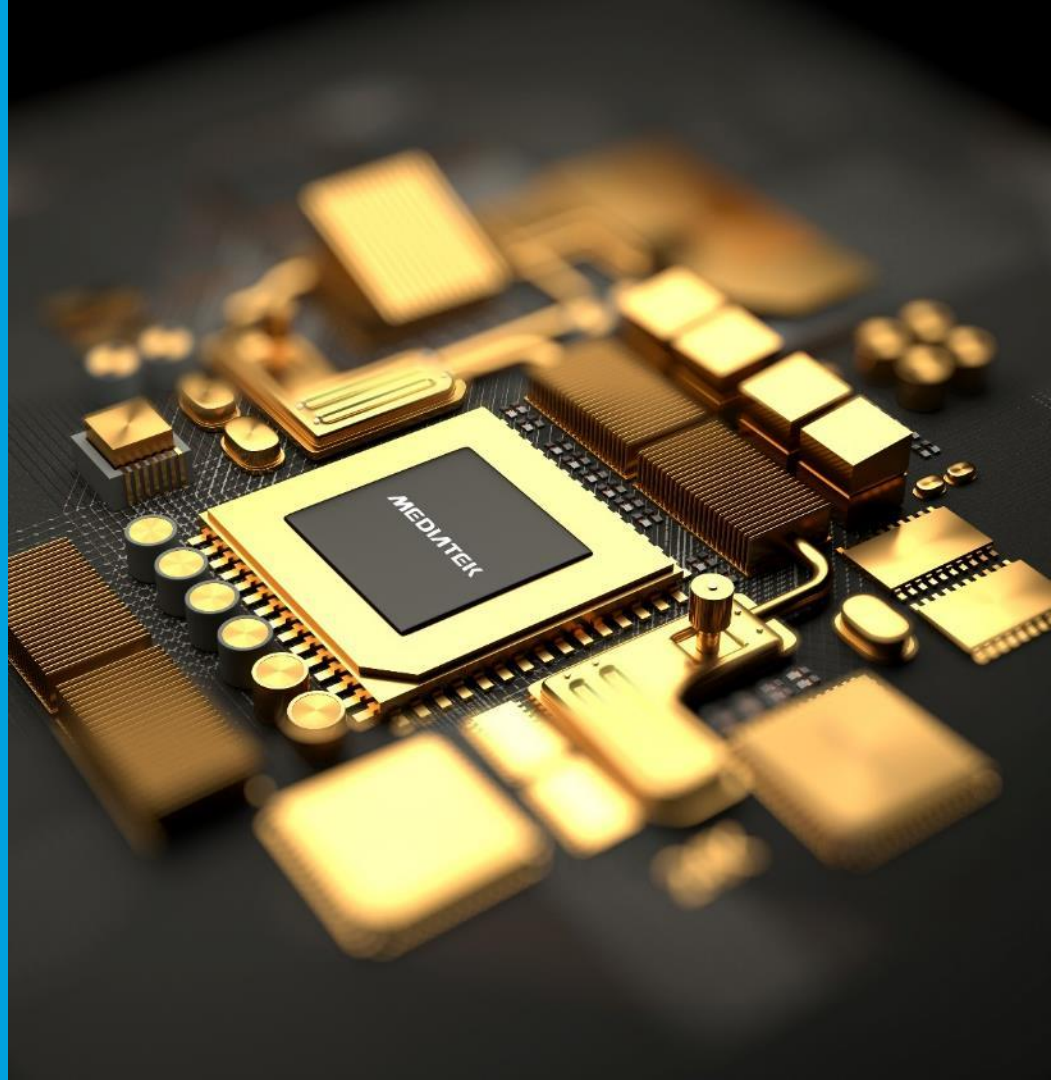

MEDIA TEK
GROUP

MEDIA TEK
MediaTek Inc.

AIROHA
Airoha Technology Corp.

ECONET
EcoNet (HK) Limited

ILITEK
ILI Technology Corp.

Mstar
semiconductor
MStar Semiconductor, Inc.

NEPHOS
Nephos Inc.

RICHTEK
Richtek Technology Corp.

SigmStar
SigmaStar Technology, Inc.



MediaTek Group Global Presence

16,000+ employees



World's **4th** largest fabless
IC design company

13th of top 25
semiconductors
globally, top 4 in Asia

7.8 Bn MediaTek Group
revenue in 2017 (USD)

Ship about **1.5 billion**
chips a year

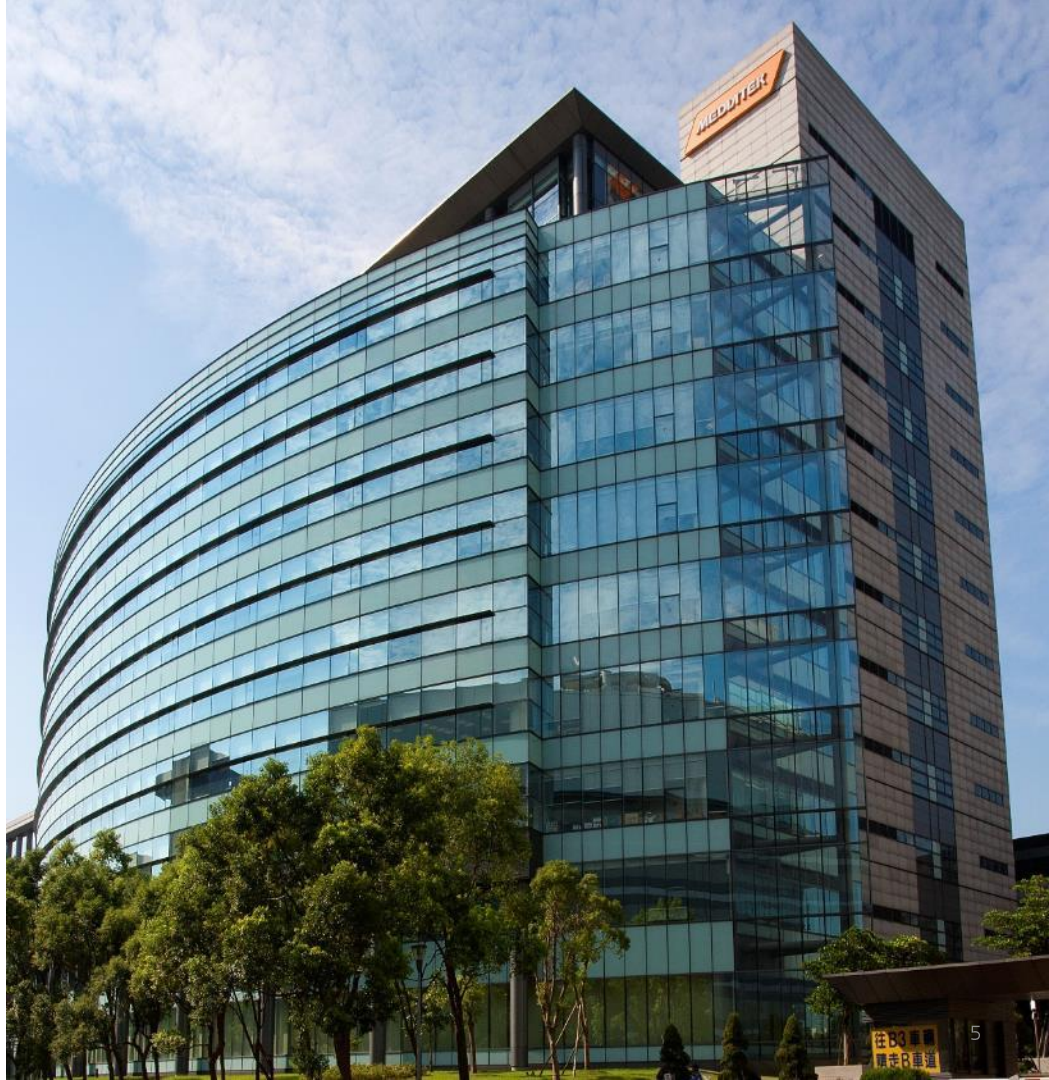

20%

MediaTek is all around you

annually around one out of five households globally acquired a product powered by a MediaTek SoC

Source: 2015 World Bank data, United Nations Statistical Division. Population and Vital Statistics Report (various years).

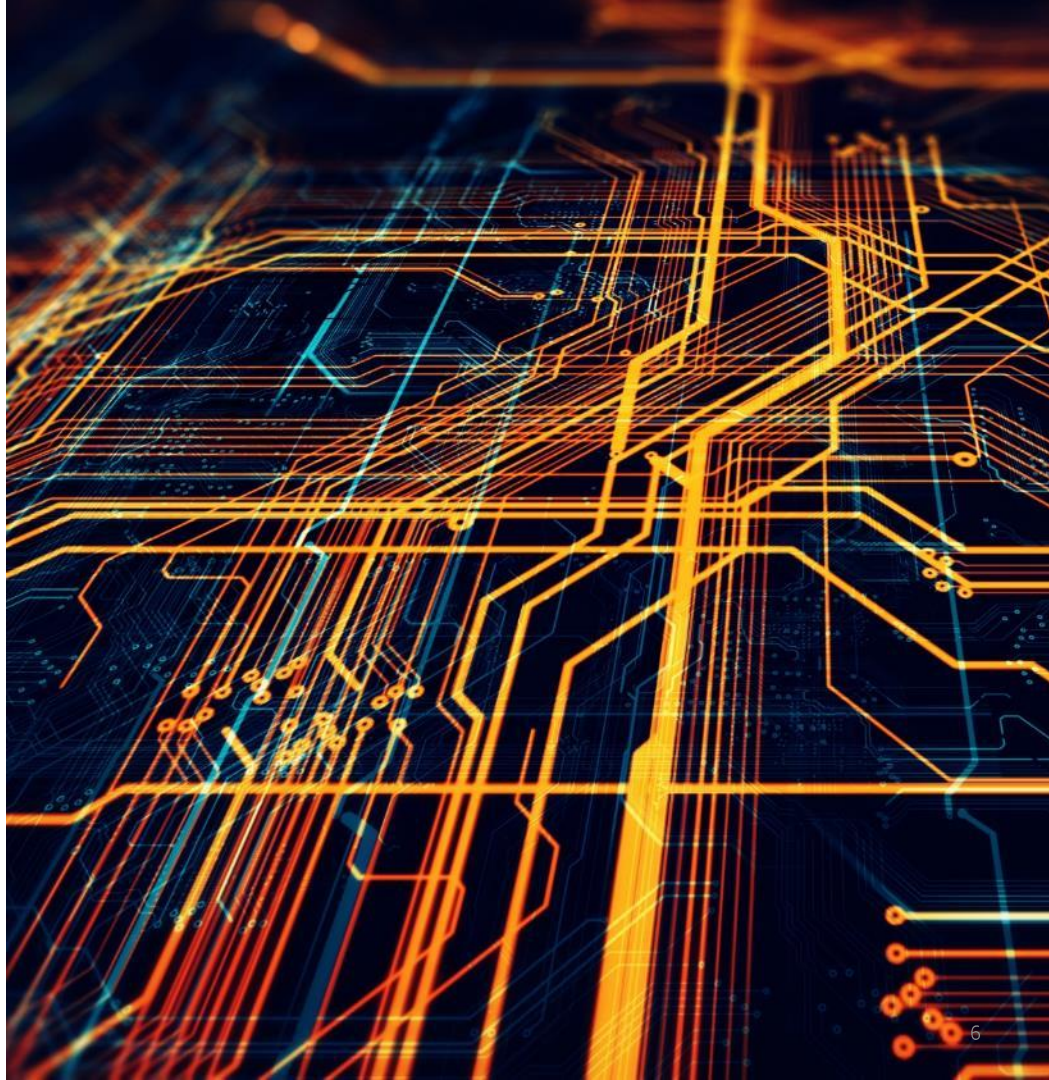

Fully Committed to Technology

>US\$ 13 billion R&D investment in the past 15 years

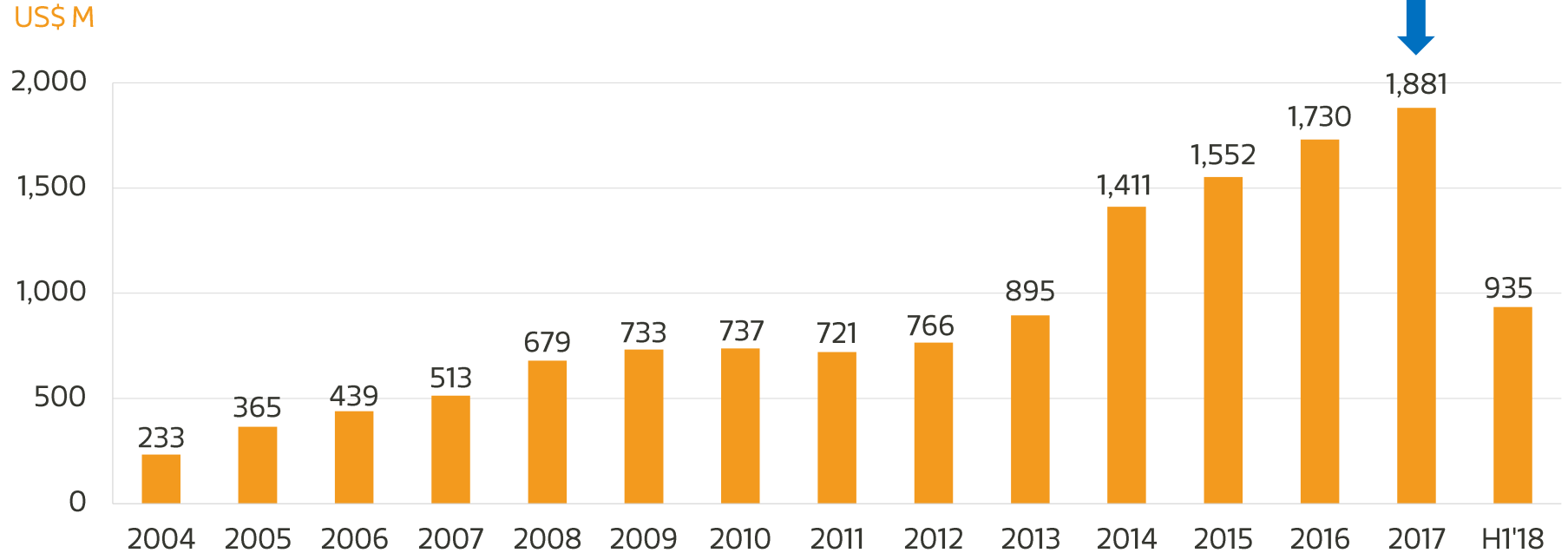

* Include SBC before 2008

Core Technologies Enable Intelligent Devices with Leading Customers



MediaTek, the Edge AI enabler

MediaTek is the **ONLY** company which supports the broad-range consumer products

- Developed based on our wide range technology portfolio
- Across different platforms and OSes (Android, Linux, RTOS, Others)

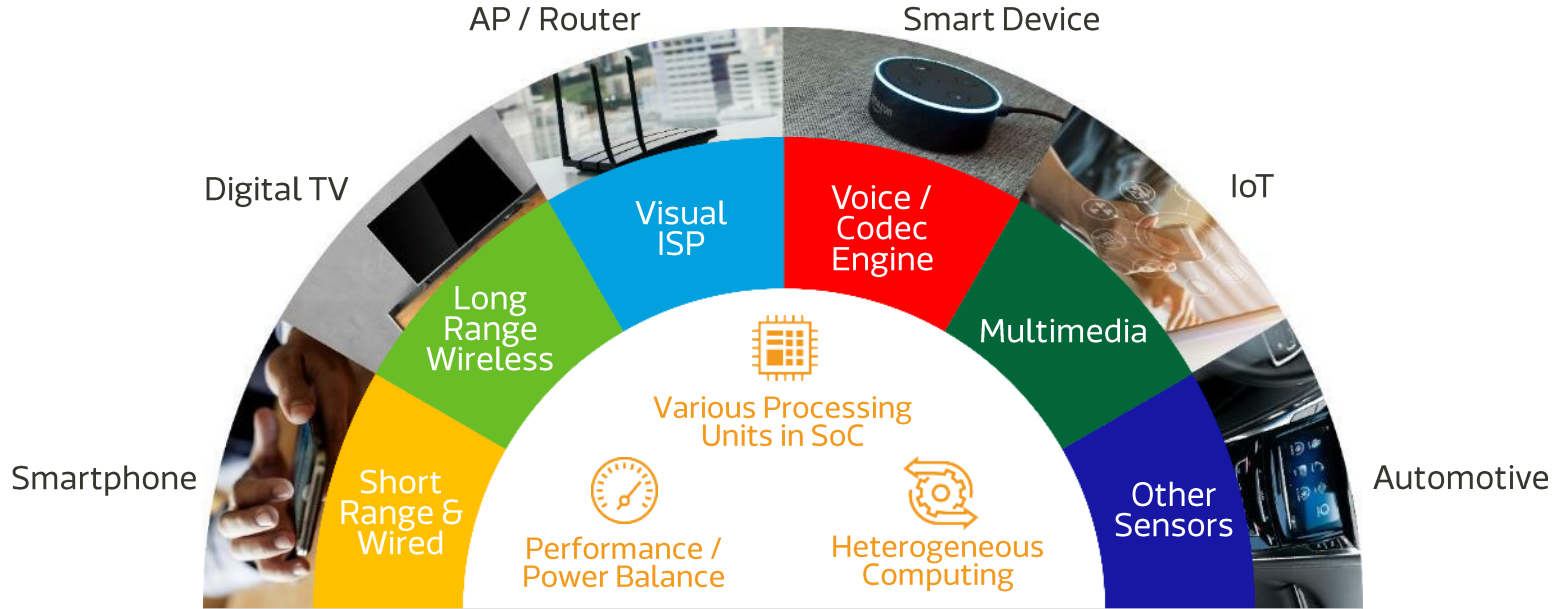

AI

**Computational
Intelligence**

5G

**High Data Rate
Mobility**



Future of Smart Everything

Wearables

Health

**Smart
Homes**

**Smart
Cities**

Automotive

**Industrial
Automation**

Finance



AI + 5G require semiconductor advances

ARTIFICIAL INTELLIGENCE

(AI)

Early artificial intelligence stirs excitement.

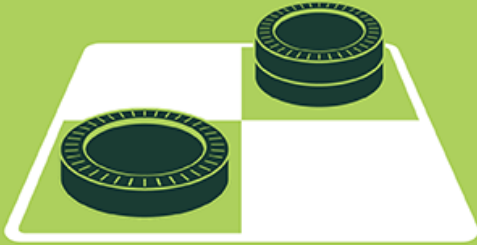

MACHINE LEARNING

(ML)

Machine learning begins to flourish.



DEEP LEARNING

(DL)

Deep learning breakthroughs drive AI boom.



AlphaGo
Vision & Speech
Self-driving Cars

Source: www.datasciencecentral.com/profiles/blogs/artificial-intelligence-vs-machine-learning-vs-deep-learning

1950's

1960's

1970's

1980's

1990's

2000's

2010's

DL demands heavy-duty computation

- Performance per watt on various architectures

CPU 1.5 GOPs/W

GPU 24.0 GOPs/W

ASIC 452 GOPs/W

Brain 20 PetaOPs @20W

Giga = 10^9
Peta = 10^{15}
= 1M Giga

- Wasted energy moving data

processor \Leftrightarrow memory

- Brain has CIM architecture

analog, asynchronous, event-driven

- AI is trending towards approximate computing

- ❖ Leading-edge nm SoC
- ❖ Processor + HBM SiP

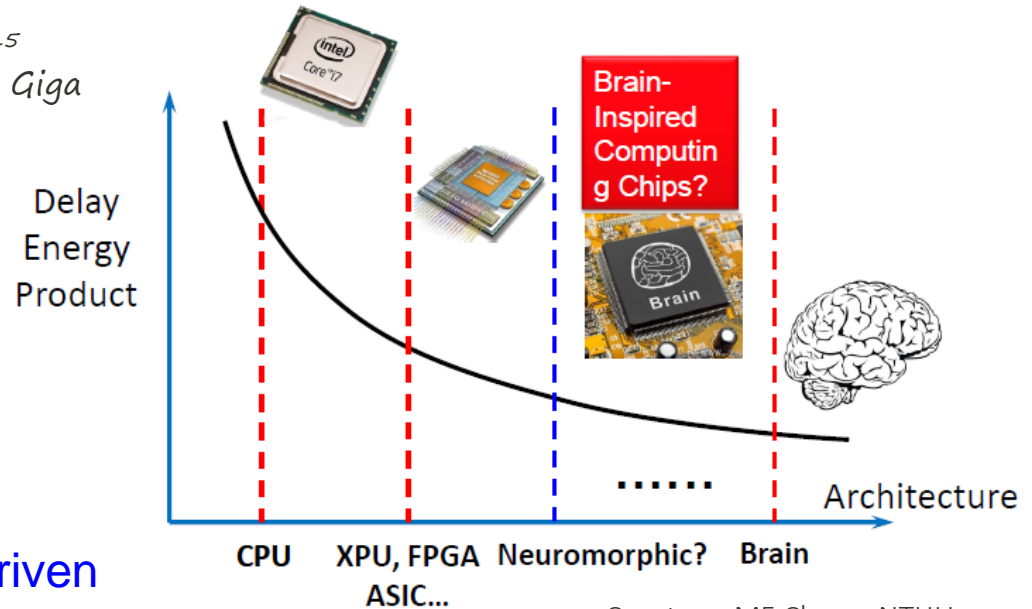

CIM = Compute-In-Memory

An example of CIM using Resistive-RAM

□ 1T1R Matrix-vector Multiplication

- Input: WL signal
- Weight: RRAM
- No Leakage current

Courtesy: MF Chang, NTHU

- ❖ Variability and reliability issues remain to be solved
- ❖ But new device types are coming

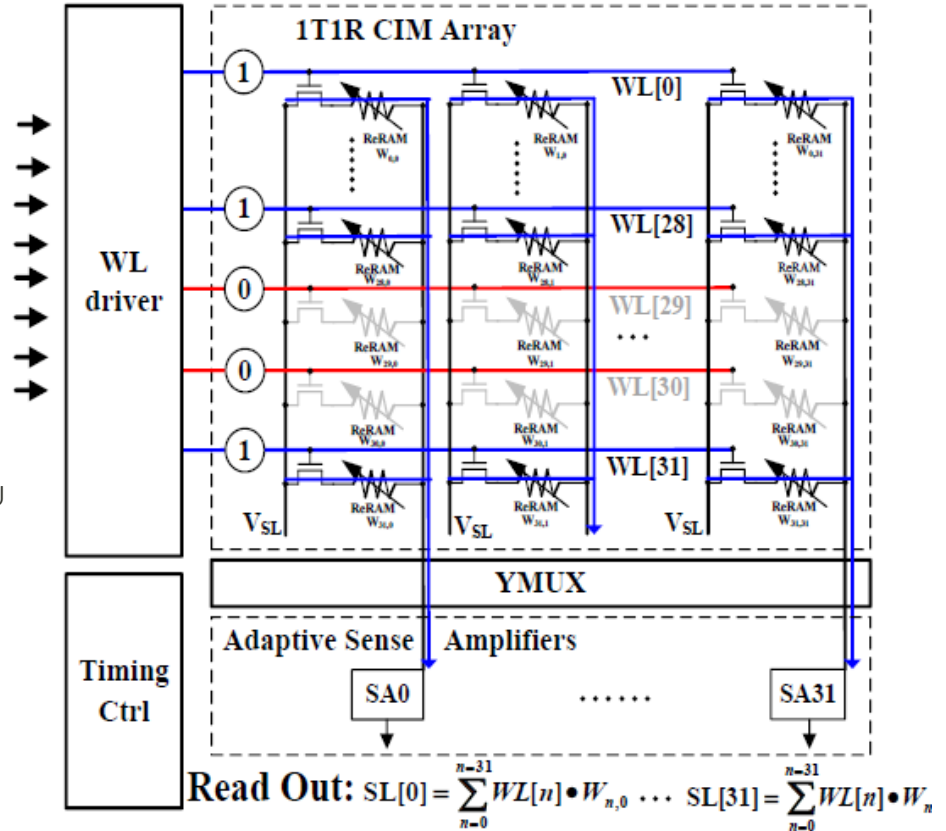

AI + 5G require semiconductor advances

1000x
Mobile Data
Volumes

10x-100x
Connected Devices

5x
Lower Latency

- ❖ *Leading-edge nm SoC*
- ❖ *Advanced DSP + AIP*
- ❖ *mmWave (6~100 GHz) RF*
- ❖ *MIMO, antenna in package*

10x-100x
End-user Data Rates

10x
Battery Life for Low
Power Devices

**MediaTek integrated
Fan-Out (MiFO)**

PMIC + AiP

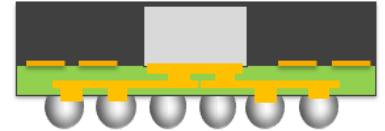

2G

3G

4G

5G

Testing advanced technologies for AI + 5G

- ***Hard and Expensive!***
- Testing of SoC and SiP as individual components
- Testing the complex end-use system containing the components

Self-driving car

- Electro-mechanical
- HW + SW
- Optical, RF, GPS
- Networking
- Integrated decisions

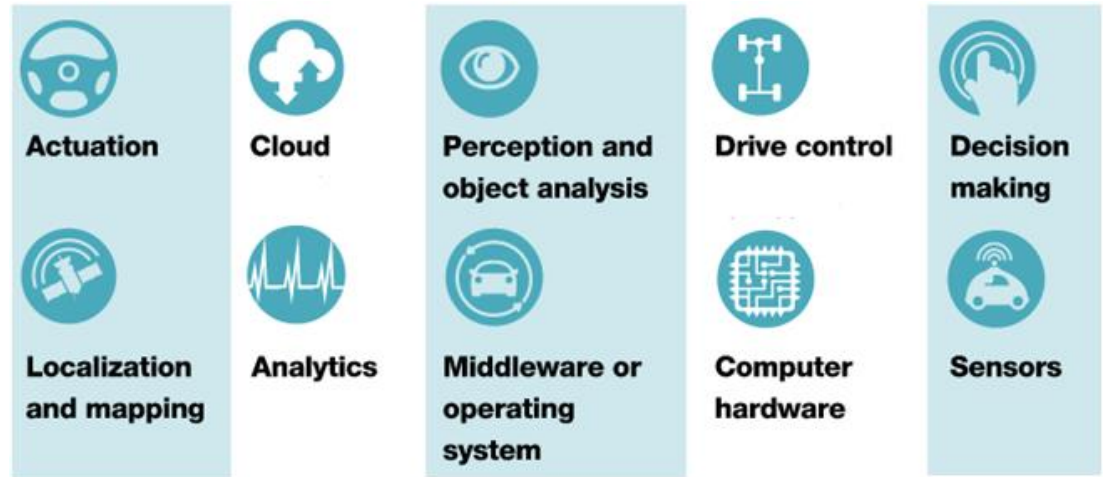

Source: McKinsey

Component testing challenges

- Increased process variation and aging effects
- Power restrictions shrink operating margins
- More subtle escapes into system – “marginal defects”
- KGD assembly, interconnect, test access
- Multi-domain: analog, digital, optical, mechanical
- Power and thermal integrity
- Non-matched component interactions
- Failure diagnosis

SoC

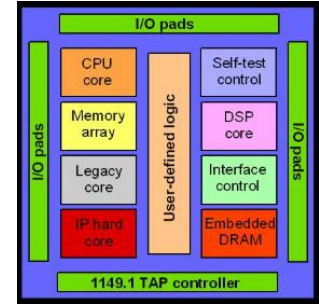

SiP

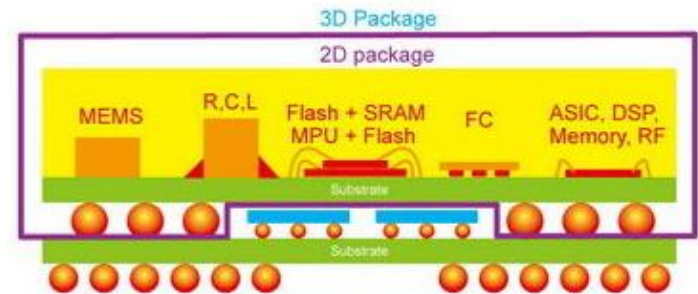

Unfavorable test cost trend

Leveraging Advanced Manufacturing to Address Challenges in the Automotive Memory Market

SWTW 2018

Brett Debenham
Sr. Director, Test/Probe Central Engineering, Micron

"Emerging Test Methods -- How Auto IC Requirements, Adaptive Testing and Multichip Products are Changing the Industry"

Phil Nigh | Test Strategy & Methodology

phil.nigh@globalfoundries.com

SWTW

June 2017



GLOBALFOUNDRIES

- **ASIC / SOC / CPU testing – will the probe electrical environment allow us to drive all testing content back to wafer test ?**

- **Target probe size & pitch & probe count & current density ?**
 - 20um size ? 40um pitch ? 30K probe count ?
- **Noise (e.g., full test without package-level capacitors)**
- **HSS test at >28G ... probe & external loopback ?**
- **RF frequency requirements ... >40GHz**

- **Test Temperature requirements (Automotive ... >105C ?)**

Pad Size/Probe Card Complexity Trend

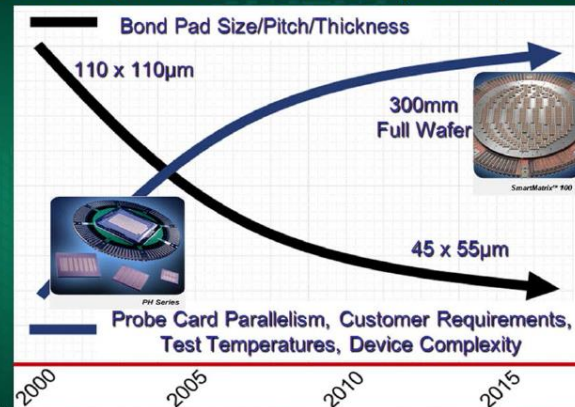

20

June 9 - 12, 2013
IEEE Workshop

Since SWTW 2013...

- DRAM 1TD wafer test is mainstream
- -40C to 150C automotive temperature requirements
- Reduced probe pad size and pitch
- Higher die-per-wafer, higher parallelism = greater power and thermal management overhead

Is 100% component testing good enough?

- Short answer: *NO*
- Does not guarantee quality and reliability of the *integrated system*
- Dramatic increase in system complexity!
 - SoC, SiP hardware devices
 - Embedded software, HW/SW interactions
 - Additional requirements related to *safety* and *security*

SEMICONDUCTOR ENGINEERING

Automakers Take On More Responsibility

OCTOBER 8TH, 2018 - BY: KEVIN FOGARTY

Carmakers traditionally have left verification, validation and testing of chips and subsystems to their suppliers. ... But as the amount of electronic content increases and the complexity of these systems grows, not to mention the deployment of these devices in safety-critical systems, carmakers are taking on a much bigger role to ensure these components work in the context of other systems.

Testing complex SoC

- Deep-nm: structural testing wall ~500 DPPM
- Less control of process & lithography variations
 - **Marginal Defects**
 - Failure only under certain (Volt, Temp, Workload) conditions
 - Escape production scan test under stable ATE environment
- Multi-core/power/clock design complexity
 - **SW** interact with **weak HW** under tight power supply margin
- Structural DFT blocks system-level interactions
 - **Test Gap**
 - Cross-domain interactions, stressed scenarios

ATE Structural Test vs. System Traffic Test

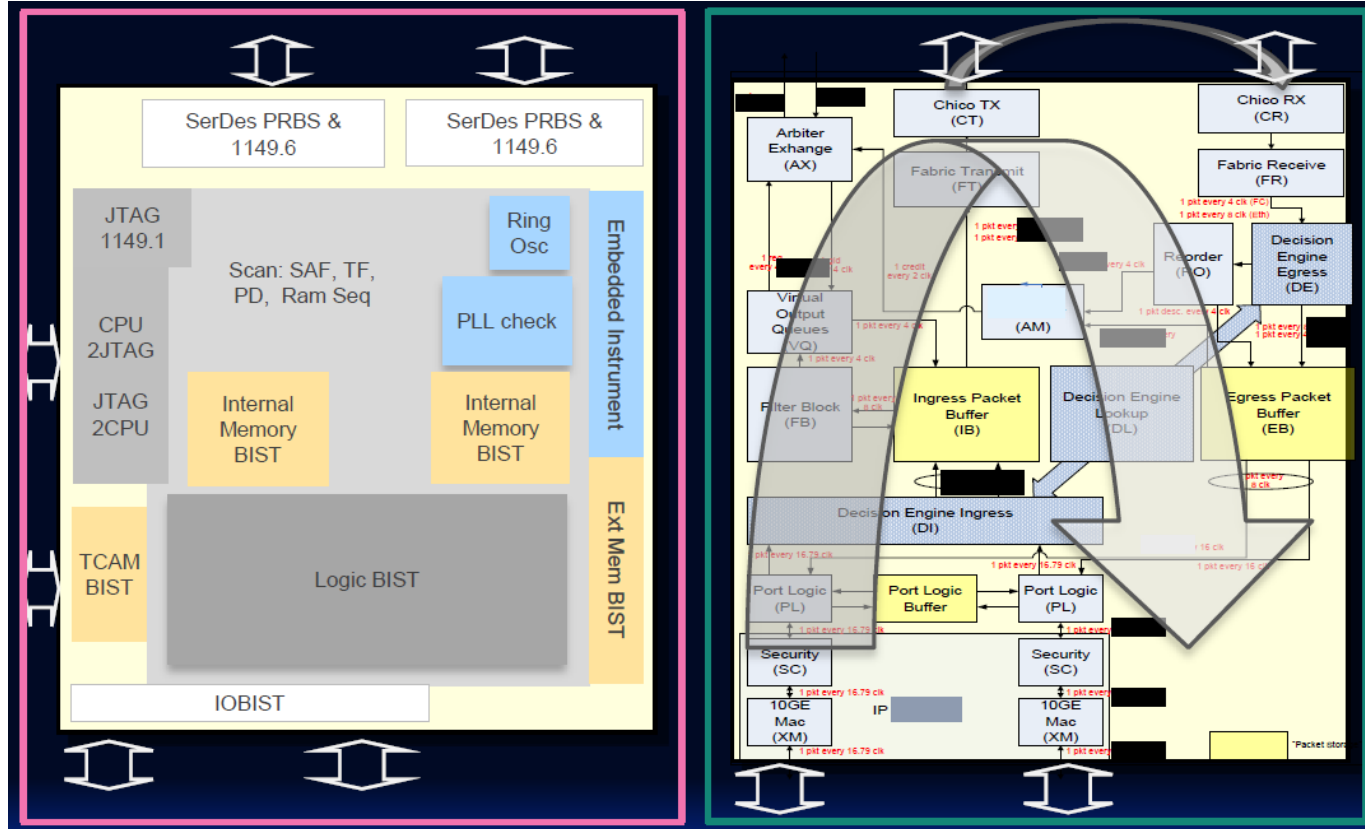

Courtesy: Zoe Conroy, Cisco

System-level failures

- Unanticipated scenarios involving marginal HW & SW
- Application-dependent, compound failing causes

Bill Eklow on Microprocessor Reliability
ieeeComputerSociety • 195 views • 3 years ago



Distinguished manufacturing engineer at Cisco, Bill Eklow examines [application-enabled defects](https://youtu.be/rbQGpslB7rE) ...
<https://youtu.be/rbQGpslB7rE>

... scaling gives rise to design complexity and more subtle defects
*... system failures due to escapes from ATE running traditional tests, i.e., **NTFs***

Ex: soft errors induced by particular application's memory access behavior

... need new system-level test and diagnosis methods

Re-think the role of testing in complex systems

A complex system of systems

- external interactions
- internal monitoring
- self regulation & healing

*autonomic nervous
& immune systems*

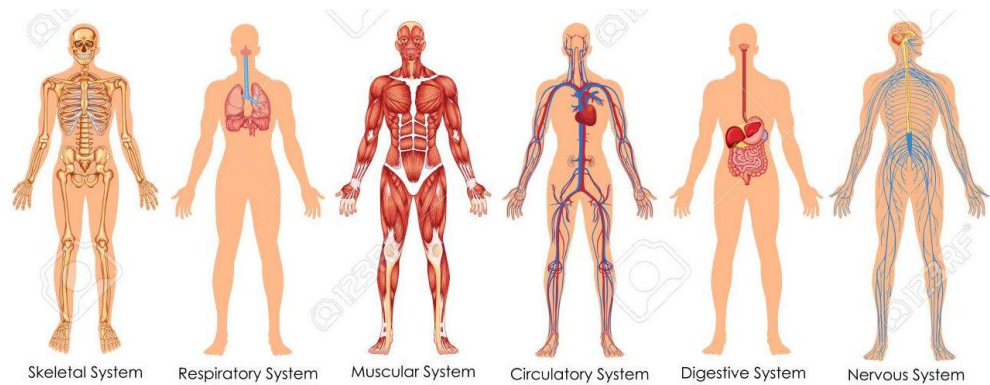

Same principles should guide the future role of test

- external functions
- **embedded sensors everywhere**
- **continuous testing, adapt, repair**

Human brain



It's already started ...

DL neural network

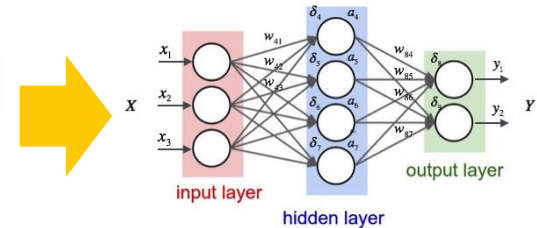

Research in self-aware systems

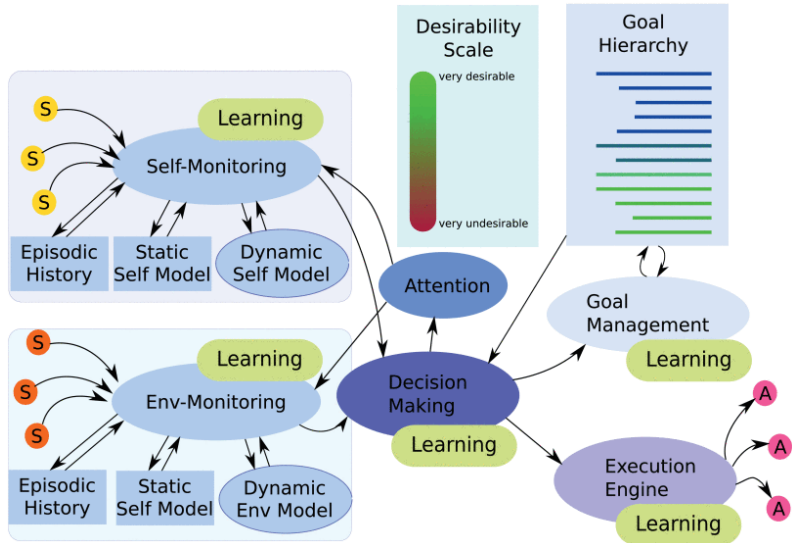

A. Jantsch, et al., "Self-Awareness in Systems on Chip - A Survey," IEEE Design & Test, vol. 34, no. 6, pp. 8-26, Nov. 2017.

**Testing becomes part of system design spec,
reducing or eliminating the need for and
associated cost of external test**

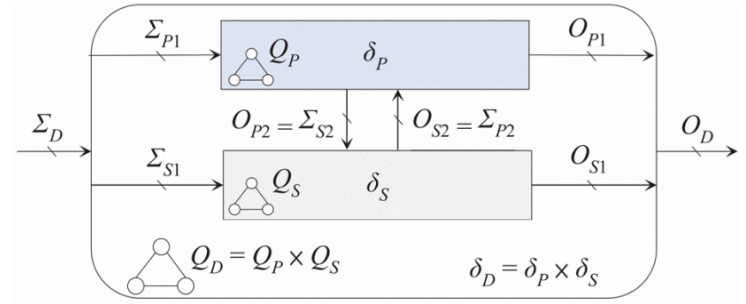

Symbiotic primary P and secondary S
 P : system function
 S : monitor P , test, repair

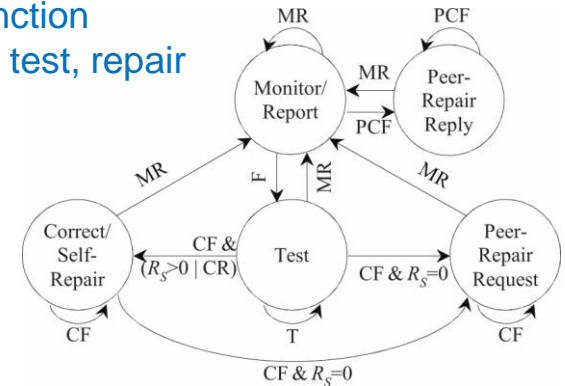

C-W. Wu, et al., "Symbiotic system models for efficient IOT system design and test," ITC-Asia 2017.

B-Y. Lin, et al., "Highly reliable and low-cost symbiotic IOT devices and systems," ITC 2017.

Growing need for system-level test (SLT)

- Augment, not replace structural test
- Run system application scenarios (system functional test)
- Catch subtle escapes (save reputation, RMA expense)
- ATE (LV) overkill recovery (boost test yield)

- But SLT has associated costs
 - Test development, debug, diagnosis
 - Potentially limits volume throughput if long test times
(addressed by massively parallel SLT platforms @5000 UPH)

SLT challenges – lack of methodology

	<u>Structural Test</u>	<u>SLT</u>
Fault model	SA, TD (IDDQ/BR/SDD/CA)	X
Fault coverage	☑	X
DFT	SCAN, BIST	X
ATPG	☑	X
Failure	Deterministic	no-trouble-found hard to diagnosis

SA = stuck-at
TD = transition delay
IDDQ = CMOS static leakage
BR = interconnect bridging
SDD = small delay defect
CA = cell aware

Multi-facet SLT methodology

1. System-level fault model
 - Coverage, fault simulation, ATPG
2. System-level DFT
 - Reduce error latency
 - More accurate diagnosis
3. System-level data analytics
 - Enable adaptive SLT

System-level fault model (SL-FM)

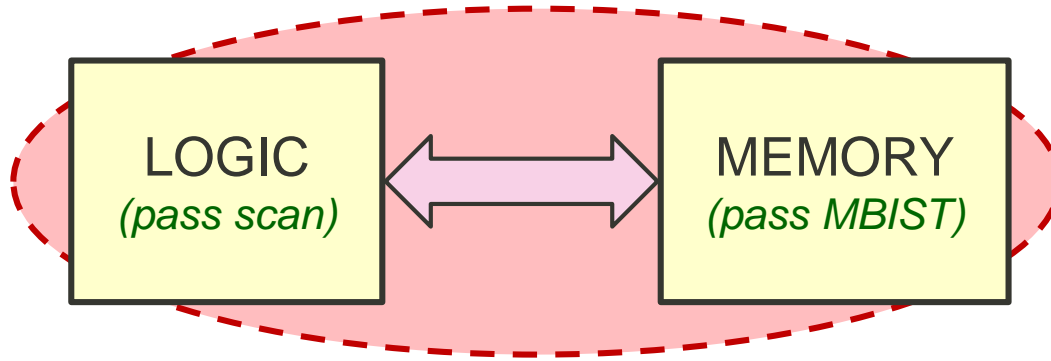

Random soft bit errors during memory access in some application scenarios

- Not “fault at single fixed location”
- Faulty behavior is probabilistic
- Focus on likely scenarios of faulty behavior
 - Implicated components and their interactions
 - Create targeted patterns to exercise scenarios

Model at system-level of abstraction

Not low structural level

- Components
- Resources
- Dependencies
- Constraints
- Actions
- Scenarios

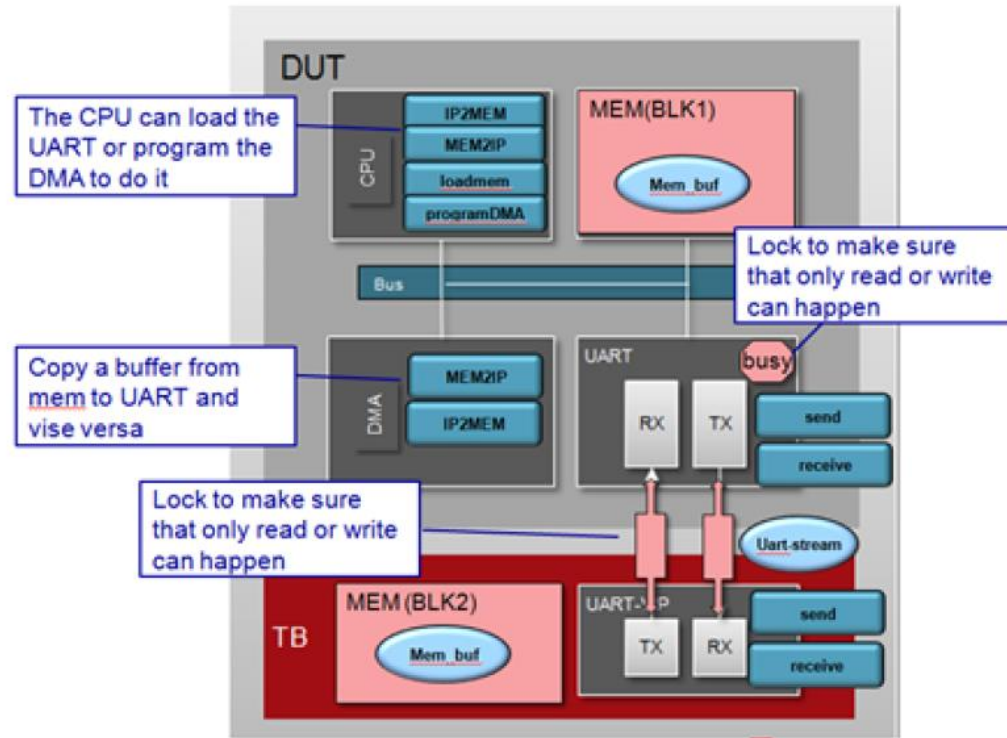

Source: PERSPEC model, Cadence Design Systems

Leverage design verification domain

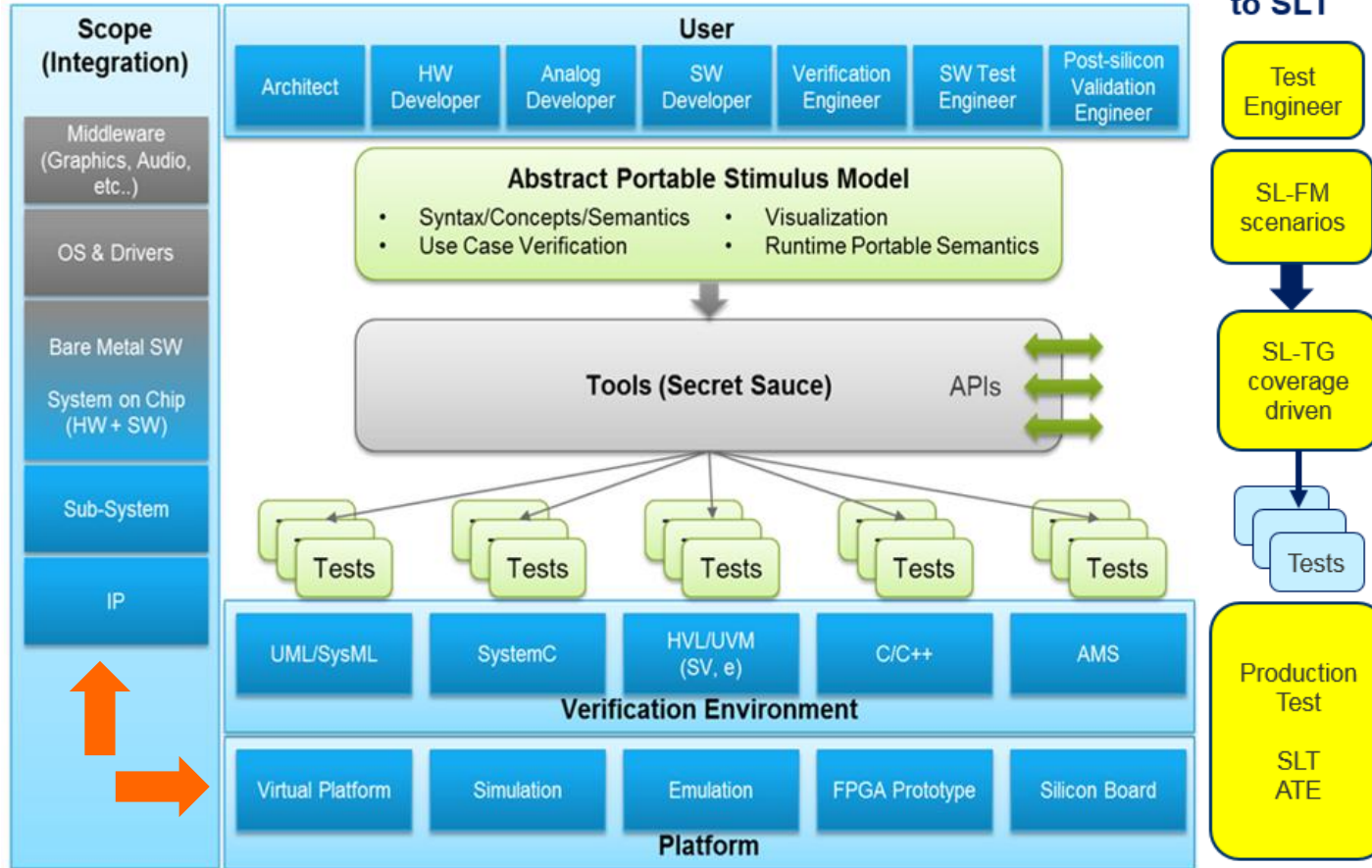

PSS = Portable Test and Stimulus Standard

Accellera → IEEE

System-level testability (SL-DFT)

- Complex system failures pose difficulties
 - Big effort to attribute to SW (80%) or HW causes
 - Long error latency impedes accurate diagnosis
- **SL-DFT** adds controllability and observability without disrupting normal system operation
- **Embedded sensors and logic** for system profiling and post-silicon debug
- Embedded SW can be made self-checking to reduce error latency and enable better diagnosis

QED (Quick Error Detection) for post-silicon debug

Subhasish Mitra, Stanford University

- Various SW instrumentation techniques to reduce error latency
- Add small HW checkers for faster performance

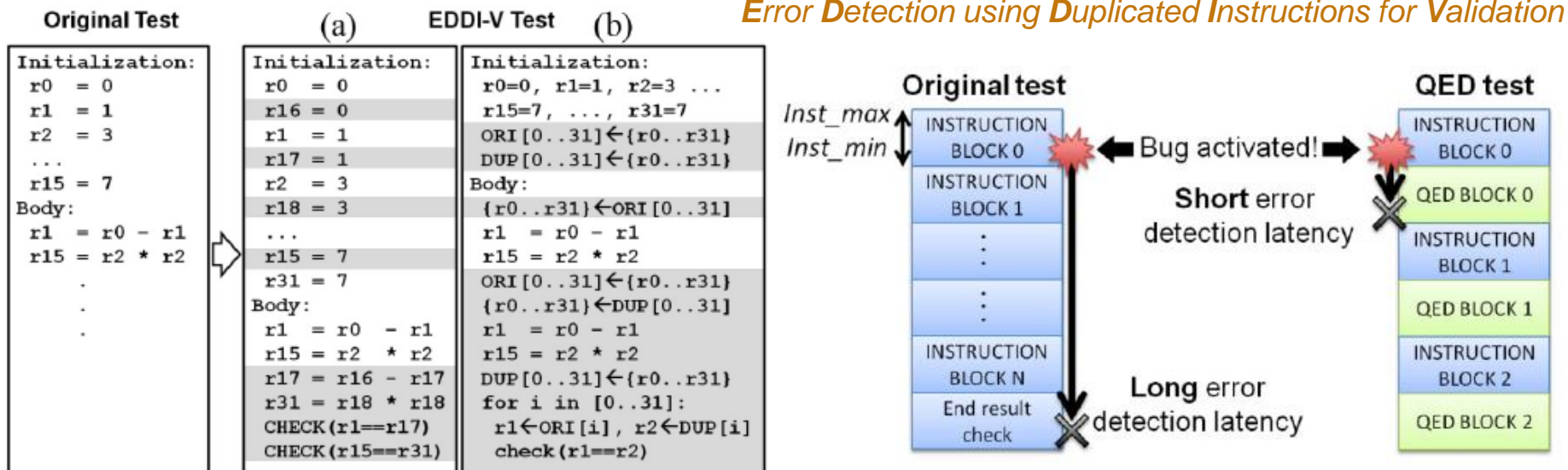

SLT flow

- Build SL-FM scenarios
 - Failure diagnosis aided by SL-DFT
 - Test gaps
 - Margin analysis
- SL-TG produce short & targeted patterns to cover SL-FM scenarios

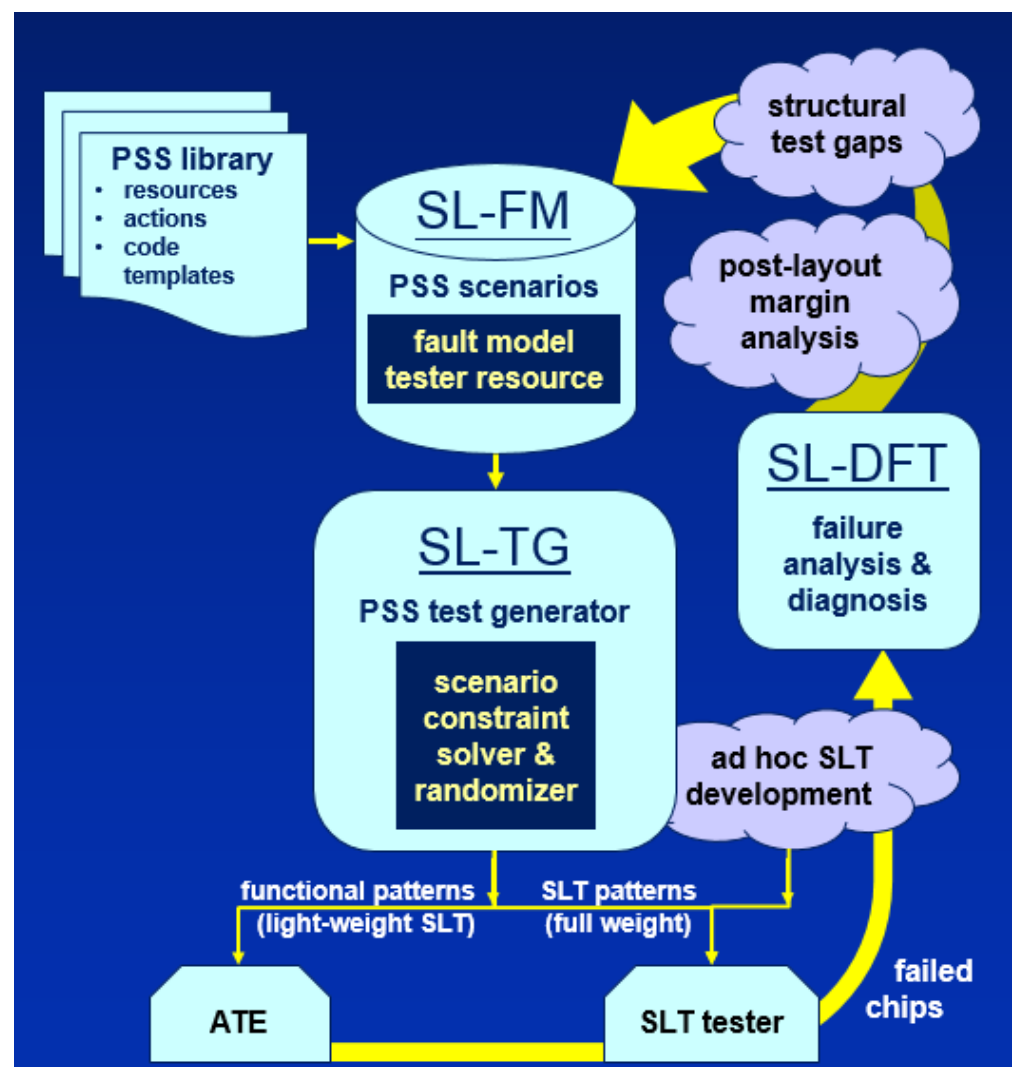

Adaptive SLT → ↓cost, ↑quality

- Sharing data across the supply chain
- Require trust relationship to exist among the players
- What if component suppliers also compete with each other?

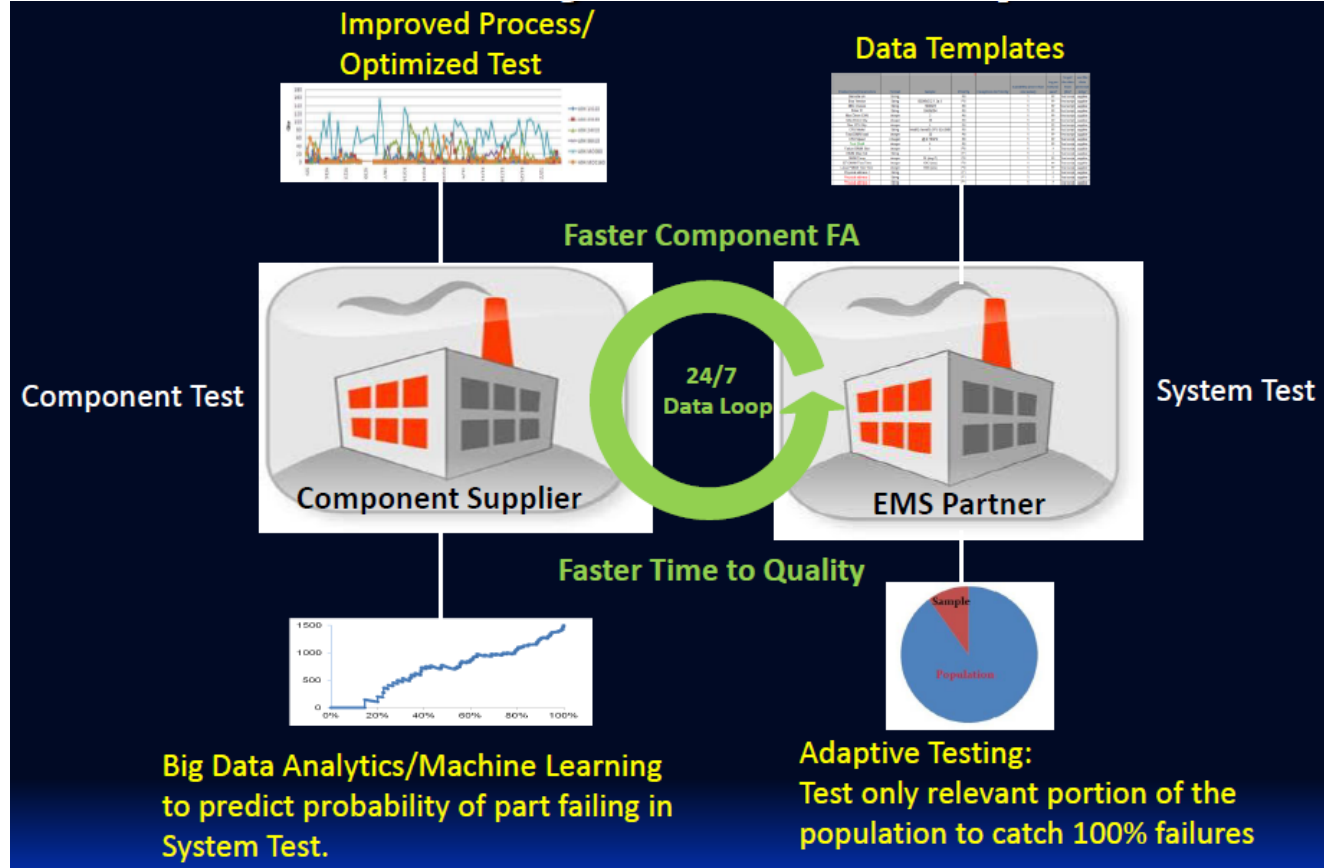

Can wireless alleviate wafer probe test

- High volume of test data generated by embedded sensors
- Probe size/pitch/count are already under heavy strain
- Why not **wireless test data access**? To complement probe, not replace

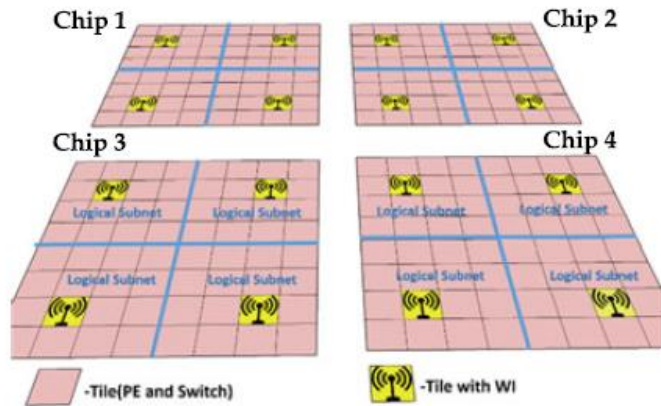

S. Shamim, et al., "A Wireless Interconnection Framework for Seamless Inter and Intra-chip Communication in Multichip Systems," IEEE Trans. on Computers., vol. 66, no. 3, pp. 389-402, Mar. 2017.

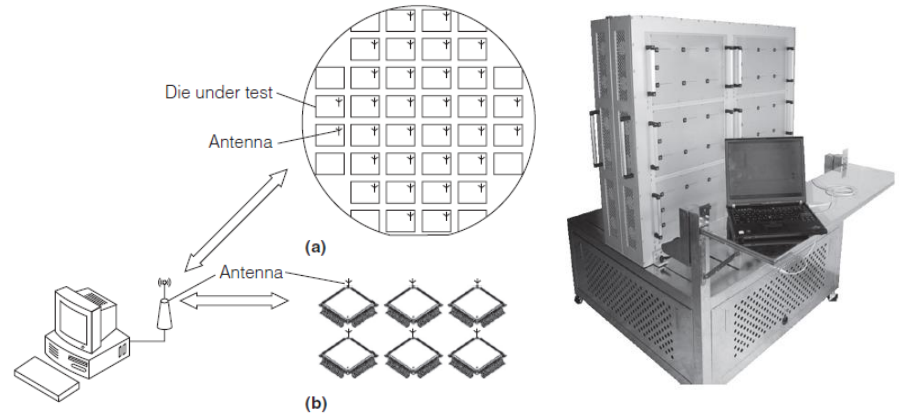

Y-T. Hsing, et al., "Economic Analysis of the HOY Wireless Test Methodology," IEEE Design & Test, vol. 27, no. 3, pp. 20-30, May 2010.

Conclusion

- **Complex AI/5G-based systems pose an enormous test challenge**
- **Existing test methods become too costly to scale up**
- **Must shift to system-oriented approach to test**
- **Explore radical opportunities or prepare to be disrupted**
- **AI + 5G may also provide boost to big test data analytics**
- **System-orientation will require more trust and collaboration**