



Kohlangaz

GAS FIRES 2014





Kohlangaz

WELCOME TO KOHLANGAZ

At Kohlangaz we know how important it is to create a stylish and relaxing living environment. That's why we've developed this collection of versatile and affordable gas fires to complement all tastes and lifestyles.

I believe our success stems from a combination of innovative design, investment in technology and the highest quality manufacturing standards. As a result all Kohlangaz fires carry a 2 year guarantee to reflect my belief in their quality and durability, and our experienced Kohlangaz retailers are hand-picked to give you the very best advice and service.

This brochure has been designed to make the purchase of your new Kohlangaz fire as simple as possible.

I hope you will find it both informative and inspiring.



Michael Jones



All Kohlangaz gas fires carry the peace of mind of a **2 Year Guarantee** and the reassurance of a flame supervision device on all models. This device immediately cuts off the gas supply in the unlikely event of the flame being extinguished through blockage.

Our 2 Year Guarantee is subject to terms and conditions including annual services and annual replacement of the oxy-pilot assembly carried out by a Gas Safe Register engineer.

bsi. Product Testing & Certification

All our gas fires are independently tested, approved and verified by the British Standards Institution (BSI) to meet the most up to date standards for performance, safety and efficiency.

The BSI is an independent organisation. They are not owned by the government, industry or shareholders, which means that they can be totally objective with regards testing and certification. This gives their assessments more authority than those of an organization that has a vested interest in promoting its members.

They have some of the most experienced and knowledgeable staff in the world and are recognised internationally for their technical expertise, quality services and in-depth knowledge of gas, electrical, oil and solid fuel product testing and certification.

The wide-ranging capability of their testing facilities and the broad expertise and knowledge of their testing and certification staff ensures our products are rigorously tested with the utmost integrity.



BFM Europe
BRITISH FIRE MANUFACTURERS



Today BFM Europe is the fastest growing domestic fire producer in the country with an unequalled reputation for quality and services.

Every Kohlangaz branded gas fire is developed and manufactured in Britain at our purpose built, state-of-the-art facility in Stoke-on-Trent.

Contents

An introduction to High Efficiency fires 3
Before you begin 4

Fires suitable for brick chimney
(Class 1) & pre-fabricated (Class 2) flue types

 Langley Slimline 5
Gosford 6
 Gosford Plus 7
 Gosford HE 8

Fires suitable for pre-cast, brick chimney
(Class 1) & pre-fabricated (Class 2) flue types

Delamere 9
 Delamere Plus 10
Marbury 11
 Marbury Plus 12
Thetford 13

Fires suitable for homes
without a chimney or flue

 Durlston Balanced Flue 14

Kohlangaz fire accessories 15

highefficiency

Get up to 94% net efficiency from your gas fire...

Kohlangaz Fires have set new industry standards with the introduction of the Kohlangaz HE high efficiency range: exceptional heat output combined with lower running costs compared to standard gas fires.

Our team has invested in developing the technology to meet the key objective of producing gas fires that save energy and as a result, help to keep costs down.

How does a Kohlangaz HE fire work? HE inset gas fires provide a higher efficiency as they produce both radiant and convected heat. Radiant heat is generated by the fuel bed and reflected into the room. At the same time convected heat is produced from cool air which is drawn through a heat exchanger and emitted through a canopy at the top of the fire as warm room air.



Before you begin...

Type of Chimney or Flue

The type of chimney or flue you have dictates the type of fire you can have. But if you're not sure, then take a look at your roof and compare it with the simple guide below. It's worth remembering that a full depth fire often requires a traditional chimney or rebate on the fire surround, whilst a slimline fire will fit virtually any chimney or flue.



Brick Chimney

Apart from products designed for "no chimney" applications, all Kohlangaz products will fit brick chimneys. They are easily recognisable by a chimney stack with accompanying terracotta pot or gas terminal.



Pre-Fabricated Flue

Pre-fabricated flues are easily identifiable by a metal flue and terminal on the roof and a metal flue box behind the fire.



Pre-Cast Flue

Pre-cast flues can be identified by a ridge vent or metal flue tube and terminal on the roof. Constructed from concrete or clay blocks they form a rectangular section flue. All Kohlangaz fires featuring this icon are only suitable for pre-cast flues conforming to BS EN 1858.

Can't see a Chimney or Flue?

If you can't see a chimney or flue like the ones described above, then you will require a Balanced Flue fire.

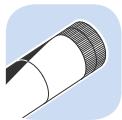

Balanced Flue

Balanced Flue fires use a horizontal pipe to vent directly outside. An electricity supply is not required for Balanced Flue products.

Controls



Manual Control

A simple and discreet control system located behind the fire's fascia or fret on inset fires.



Slide Control

Convenient control that eliminates the necessity of bending down.

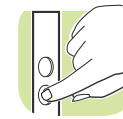

Easy Flame Control (EFC)

Discreet, easy access buttons are used to ignite the fire and adjust heat and flame height.



Fully Automatic Remote Control

The remote control handset is used to light the fire as well as to adjust the flame height and heat output.

Power Supply

Every fire in this brochure is suitable for natural gas only.



Natural Gas

If you have a gas meter then you will have natural gas



LPG

LPG is the most popular alternative to natural gas

Langley Slimline

The Langley Slimline has been specifically designed to fit a standard Pre-Cast flue without compromising style and performance. It features a contemporary curved black steel fascia, framing a beautifully realistic log fuel effect and is operated by a fully automatic remote control system.

Specifications

Max. Heat Input	5.0kW
Max. Heat Output	3.1kW
Air Vent Required	Not normally

71%
NET EFFICIENCY

Type Fuel Control Effects Back Panel



Dimensions

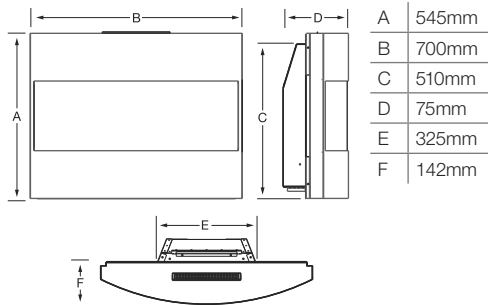

Kohlangaz
2
Year Guarantee



Watch the video

Langley Slimline

Kohlangaz
2
 Year Guarantee



Gosford with Standard trim and Daisy fret in silver



Gosford

The Gosford features one of the most realistic coal effects on the market and offers an amazing 4kW of heat. This open fronted fire is able to deliver a higher output through the use of a heat exchanger which draws in the cool room air and converts it to warm convected air. Manual or slide control models are available and you can create your own style with a choice of any Kohlangaz trim, fret or fascia (see page 15).

Specifications

Max. Heat Input	6.9kW
Max. Heat Output	4.0kW
Air Vent Required	Not normally

Type	Fuel	Control	Effects	Back Panel

Dimensions

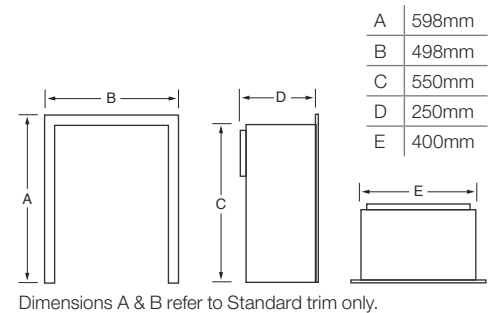









Gosford Plus

The Gosford Plus is our first full depth open-fronted high efficiency gas fire. You can now achieve the look of a real open coal fire at an incredible 74% net efficiency. Suitable for installation into standard chimneys or pre-fabricated flues the Gosford Plus comes in a choice of manual, slide, easy flame or remote control and can be styled to suit your home with our wide range of trims and frets (see page 15).

Specifications

Max. Heat Input	6.9kW
Max. Heat Output	4.6kW
Air Vent Required	Not normally

74%
NET EFFICIENCY

Type	Fuel	Control	Effects	Back Panel
				
				
				
				

Dimensions

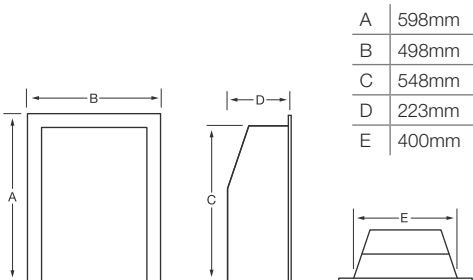

Dimensions A & B refer to Standard trim only.



Kohlangaz
2
Year Guarantee



Watch the video

Gosford Plus with Standard trim and Grace fret in silver

Kohlangaz
2
Year Guarantee



Gosford HE with Standard trim and Balmoral fret in black



Gosford HE

If you're looking for a gas fire with efficiency in mind this has to be the product for you. The Gosford HE glass fronted fire features our most realistic full depth coal effect fuel bed and boasts an incredible net efficiency of 89%. With a massive 4kW output the Gosford HE keeps your heat high and your fuel costs low. You can choose your preferred trim and fret combination to suit your décor, see page 15 for more details.

Specifications

Max. Heat Input	5.0kW
Max. Heat Output	4.0kW
Air Vent Required	Not normally

89%
NET EFFICIENCY

Type	Fuel	Control	Effects	Back Panel

*Only available with manual control model.

Dimensions

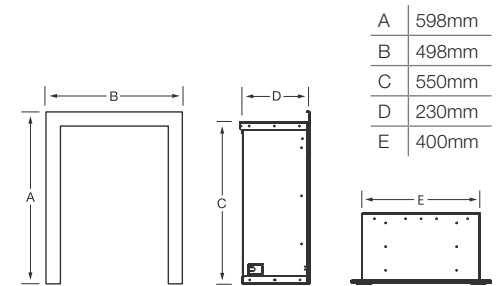











Dimensions A & B refer to Standard trim only.

Delamere

The Delamere features an outstanding coal or optional pebble fuel effect and a beautiful flame picture. This open-fronted fire provides a maximum heat output of 3.3kW and can be installed into most chimneys or flues, including pre-cast (BS EN 1858) when fitted with a 3" rebated fire surround. Customise the Delamere with our extensive range of trims, frets and fascias (see page 15).

Specifications

Max. Heat Input	6.9kW
Max. Heat Output	3.3kW
Air Vent Required	Not normally

Type	Fuel	Control	Effects	Back Panel
				
				
				

Dimensions

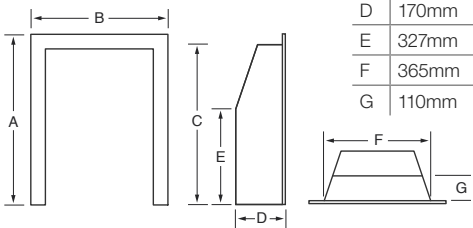

A	598mm
B	498mm
C	550mm
D	170mm
E	327mm
F	365mm
G	110mm

Dimensions A & B refer to Standard trim only.

Kohlangaz

2

Year Guarantee



Delamere with pebble fuel effect, Standard trim and Daisy fret in silver



Watch the video

Delamere with coal fuel effect, Standard trim and Daisy fret in brass

Kohlangaz
2
Year Guarantee



Delamere Plus with coal fuel effect, Standard trim and Blenheim fret in brass

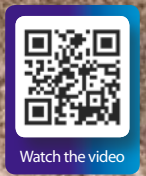

Watch the video



Delamere Plus with pebble fuel effect and Contemporary fascia in polished silver









Delamere Plus

The Delamere Plus boasts an amazing 70% net efficiency and can be installed in to almost any chimney or flue, including pre-cast when fitted with a 3" rebated fire surround. This open-fronted gas fire features a highly realistic coal fuel effect and is available as a manual or slide controlled fire. A pebble fuel effect is available as an optional extra.

Specifications

Max. Heat Input	6.9kW
Max. Heat Output	4.4kW
Air Vent Required	Not normally

70%
NET EFFICIENCY

Type	Fuel	Control	Effects	Back Panel
				
				
				

Dimensions

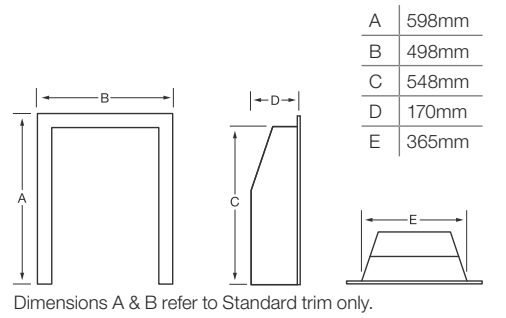









Marbury

The slimline Marbury gas fire features an attractive coal fuel bed and dancing flame effect. It is suitable for installation in to almost any home since it will fit a standard brick chimney, pre-fabricated flue or pre-cast (BS EN 1858). This fire can be purchased as a manual control fire or as a convenient slide control. A pebble fuel effect is available as an optional extra. See page 15 for trim and fret combinations.

Specifications

Max. Heat Input	6.5kW
Max. Heat Output	3.3kW
Air Vent Required	Not normally

Type	Fuel	Control	Effects	Back Panel
				
				
				

Dimensions

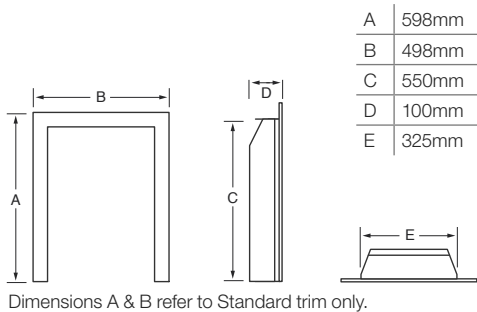

Kohlangaz
2
Year Guarantee



Marbury with pebble fuel effect and Contemporary fascia in polished silver



Marbury with coal fuel effect and Contemporary fascia in polished silver

Please note that the Contemporary fascia shown on this page is not suitable for slide control versions.

Kohlangaz
2
Year Guarantee



Marbury Plus with coal fuel effect, Standard trim and Balmoral fret in brass



Watch the video



Marbury Plus with pebble fuel effect, Standard trim and Grace fret in silver









Marbury Plus

The Marbury Plus is one of the most efficient open-fronted slimline gas fires available today and with a heat output of up to 4.1kW it is also one of the warmest products suitable for a pre-cast flue. The Marbury Plus is available in a choice of manual or our easy access Easy Flame control systems. This extremely versatile fire can be styled with a wide range of Kohlangaz trims, frets or fascias and with an optional pebble fuel bed it is easy to create a look to suit your existing décor. See page 15 for more information about Kohlangaz accessories.

Specifications

Max. Heat Input	6.5kW
Max. Heat Output	4.1kW
Air Vent Required	Not normally

70%
NET EFFICIENCY

Type	Fuel	Control	Effects	Back Panel
				
				
				

Dimensions

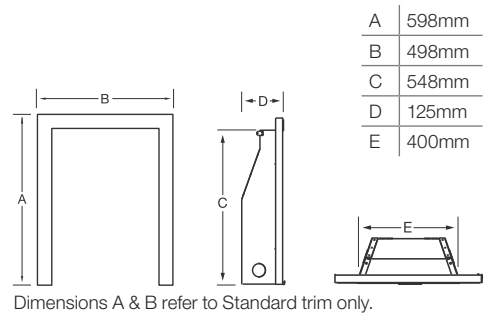









Thetford

The Thetford features one of the deepest looking fuel beds on a slimline gas fire. Designed for easy installation in to any chimney or flue, including pre-cast (BS EN 1858), this stylish fire is both versatile and affordable. This model comes with a choice of Standard trim which can be teamed with any Kohlangaz fret, or upgrade to one of our Contemporary fascias (see page 15). A pebble fuel effect is available as an optional extra.

Specifications

Max. Heat Input	6.5kW
Max. Heat Output	3.3kW
Air Vent Required	Not normally

Type	Fuel	Control	Effects	Back Panel
				
				
				

Dimensions

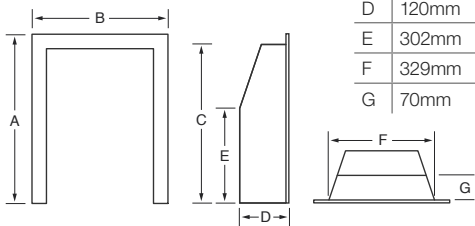

A	598mm
B	498mm
C	550mm
D	120mm
E	302mm
F	329mm
G	70mm

Dimensions A & B refer to Standard trim only.

Kohlangaz
2
Year Guarantee



Thetford with coal fuel effect, Standard trim and Blenheim fret in brass



Watch the video

Thetford with pebble fuel effect, Standard trim and Grace fret in silver

Kohlangaz
2
Year Guarantee



Durlston Balanced Flue with Standard trim and Grace fret in silver



Watch the video







Durlston Balanced Flue

The Durlston Balanced Flue is the perfect solution for those who like the look of a full depth fire but don't have a standard chimney or flue in their home. At 94% net this glass fronted fire is the most efficient product in our range and offers an impressive 4.0kW heat output. The Durlston Balanced Flue comes in a choice of manual or Easy Flame control and can be teamed with any Kohlangaz trim and fret. This fire can be installed easily into most standard cavity walls when fitted with a 3" rebated fire surround.

Specifications

Max. Heat Input	4.6kW
Max. Heat Output	4.0kW
Air Vent Required	No

94%
NET EFFICIENCY

Type	Fuel	Control	Effects	Back Panel
				
				

*Only available with manual control model.

Dimensions

A	598mm	D	185mm	G	406mm
B	498mm	E	120mm	H	150mm
C	551mm	F	423mm	I	625mm max* 285mm min*

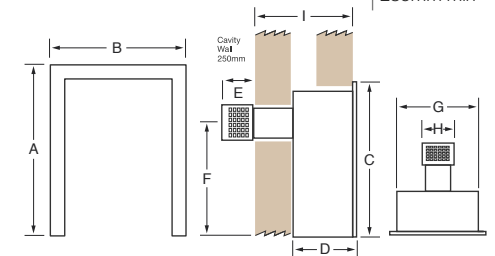

Dimensions A & B refer to Standard trim only. *These dimensions differ on EFC models. Please refer to the installation manual for more details. An optional flue extension is available to increase the maximum flue length to 1010mm on manual control models and 973mm on EFC models.

Kohlangaz Fire Accessories

Contemporary fascias*



Polished Silver

Brushed Silver

Not available with slide control, EFC, Gosford Plus or Durlston Balanced Flue models.

Arcadia fascias*



Gold

Silver

Embrace fascias*



Gold

Silver

Black Nickel

*Not available with EFC models.

Blenheim frets



Brass



Antique Brass



Black



Chrome

Balmoral frets



Brass



Black

Grace frets



Brass



Chrome

Daisy frets



Brass



Black



Polished Silver

Standard trims



Brass



Polished Silver



Brushed Silver



Black



Gold



Silver

Ultimo trims*

Kohlangaz



Find us on Facebook,
Twitter, Pinterest & YouTube

WARNING BFM Europe Limited is a Gas Safe Register company. We recommend that all of our fires are installed by Gas Safe Register engineers in accordance with our instructions.

DISCLAIMER Our policy is one of constant development and improvement. We therefore reserve the right to revise designs and specifications of our products without formal notice, patents pending. We always recommend our products be viewed in an approved showroom before purchase. Whilst we have taken every care in the preparation of this brochure it is not intended to replace the installation manual which provides more detailed information.

Photography is for illustration purposes only and although every effort has been made to ensure accurate reproduction of typical installations and flame pictures they may vary according to fire model and flue types. We accept no liability for any loss or damage arising directly or indirectly from the use of this brochure. We recommend that all our fires are used in conjunction with central heating and not as a primary source of heat. In the interests of personal safety a suitable fireguard is recommended when children, the elderly and the infirm are present. (This brochure is copyright 2014 and must not be reproduced in whole or in any part without prior written permission).

We would like to thank OER Fireplaces (01782 319350) for providing the fire surrounds used in this brochure.



Watch the video

www.kohlangazfires.co.uk

Go direct to the Kohlangaz website on your smart phone or tablet device, just scan in this QR code.



**MADE
IN BRITAIN**



BFM Europe
BRITISH FIRE MANUFACTURERS

BFM Europe Ltd, Gordon Banks Drive, Trentham Lakes, Stoke-on-Trent ST4 4TJ
Tel: 01782 339000 www.kohlangazfires.co.uk Email: sales@bfm-europe.com