

# CHECK VALVE CATALOGUE



**ISO 9001 Certified**



# EVR Means Quality

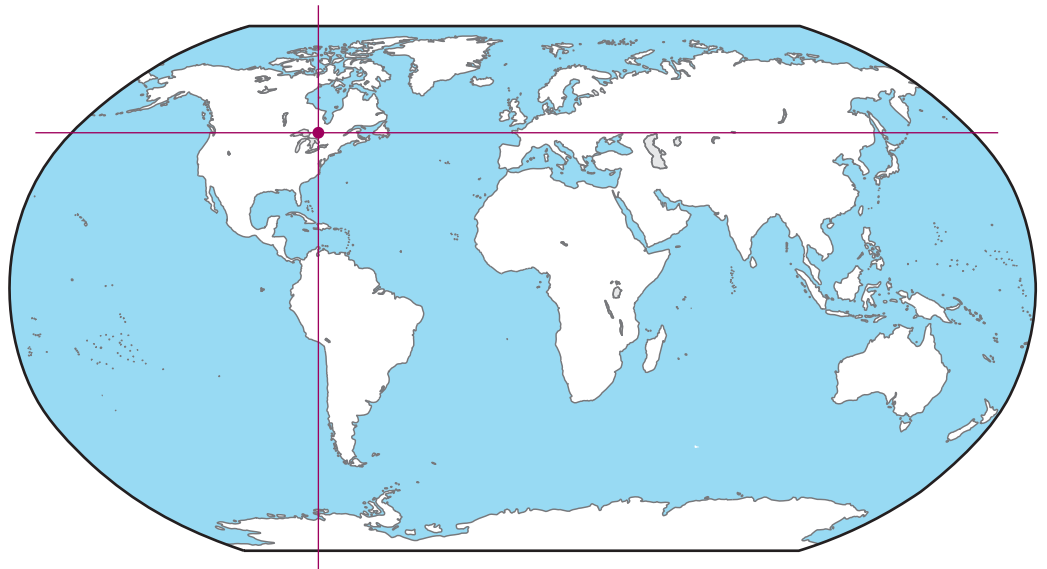

Located in Sudbury, Ontario, the heart of the largest concentration of mining and pulp and paper activities in Canada, Elasto-Valve Rubber Products Inc. provides expert solutions to your process piping problems. A full range of elastomeric piping products, featuring the latest in innovative design and materials, serves the varied needs of mining, pulp and paper, food processing, water and waste treatment, marine and petrochemical industries.

## **Our Goal is Excellence**

Our mission at EVR Products is to safely manufacture quality products, at a reasonable price, and in a timely manner. We are dedicated to customer satisfaction in all areas and vow to exceed our customers' expectations. We will achieve our goal through effective communication, outstanding customer service, and world class products.

## **An Assurance of Quality**

EVR's quality management system is registered to ISO9001 and CSA Z299.3-85 standards. We have ABS type approval and National CRN registration for our SJ-21 style expansion joints in all provinces except for Alberta where specific sizes are registered. To ensure control is maintained, hydrostatic, vacuum, and valve testing are performed in-house to customer specifications. We take pride in the fact that world-renowned companies have audited our quality system and we have been accepted as their trusted supplier of quality rubber products.

## **Our Check Valves**

EVR has been producing elastomeric check valves since 1994 and has manufactured numerous check valves for both municipal services and industrial applications. Recognizing the need for maintenance free Check Valves, EVR has developed the Duckbill Check Valve which is now being used world wide.

## **EVR Check Valve Benefits**

- Maintenance costs are minimal (no parts to freeze, corrode or lubricate)
- All elastomer construction eliminates the worries of rusted or seized hinge mechanisms
- Head loss is considered to be minimal, allowing increased flow patterns
- Manufactured with engineered elastomers designed to inhibit barnacle and sea life growth

For your check valve projects, specify EVR check valves for years of maintenance free operation.



6" (150mm) CPO Diffuser check valves complete with coal tar epoxy coated risers installed in the Indian Ocean on a sewage distribution facility. The project was installed at the Cobala Marine Outfall.  
Location: Mumbai, India.



24" (600 mm) CPO slip on check valves back flow prevention sump  
Location: Cork, Ireland



400 mm EVR Wastop has been used for over 5 years in many different European countries. This is an application in Holyhead, England. EVR is proud to be North America's Distributor for Wastop Check Valve.



CPO style check valve was built to withstand 5 meters of back pressure on the Deep Tunnel Sewage System, Changi Outfall Singapore.  
Project Owner: Public Utilities Board Singapore



24" (600mm) CPJ enclosed body check valve, portrays the various options that EVR can offer to the industry. Flush ports are standard on all EVR jacketed check valves. Flange drilling is available in all types.

- Quiet operation
- Zero maintenance
- Design prevents backflow
- Will seal around solids
- Designed to withstand wear
- Tough enough for abrasive slurries

The Series CPF Flanged Check Valve is designed to be efficient, quiet and tough. It requires no external power sources, thereby reducing operating costs. The simple design means there are no moving mechanical parts to break down or jam, reducing maintenance costs.

CPF Valves easily handle corrosive or abrasive materials such as raw sewage, sludges or slurries. Their flexible design allows solids to pass through unhindered and can even seal around solids trapped in the valve.

Series CPF Flanged Check Valves are versatile and can be installed either horizontally or vertically. Drilling is available in all flange standards.



#### Typical Applications

Sewer Interceptors - Wet Wells - Mine Tailing Systems - Dredging - Scrubber Systems - Outfall Lines - Wet/Dry Wells

Manufactured with an integral full-faced rubber flange connection and metal backing flange, Series CPF check valves can be attached directly to a tank, pipe, or headwall.

The CPF Series valve allows material to flow through...

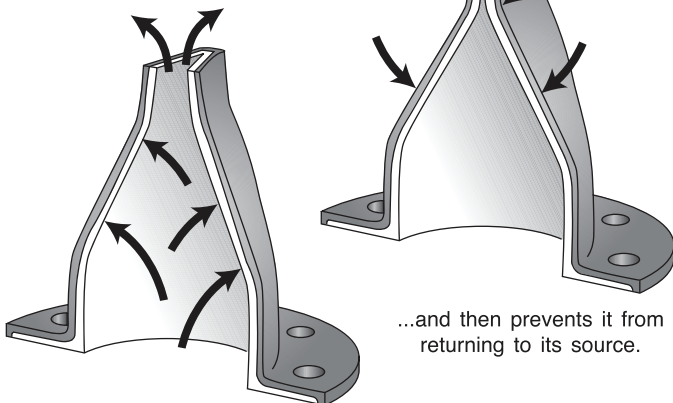

...and then prevents it from returning to its source.

The heart of the Elasto-Valve Series CPF Backflow Preventer is a fabric reinforced rubber "duckbill" sleeve manufactured with top quality materials. This flexible sleeve provides maximum flow with a minimum pressure drop across the valve at all times.

Unlike conventional check valves - which require frequent maintenance to replace worn seats, hinge pins, balls or flappers - there is little or no maintenance with CPF Valves.

Available in a variety of styles and reinforced elastomers, the Elasto-Valve Series CPF Backflow Preventer can be adapted to almost any application.

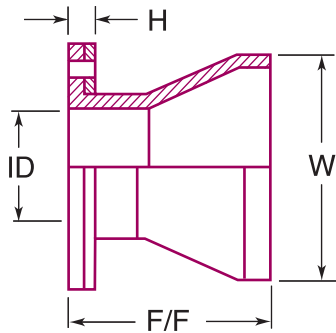

Drilling available in all flange standards.

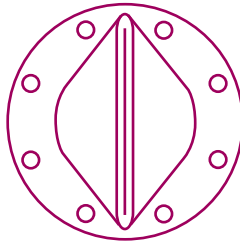

For engineering specifications or when placing your order, please provide the following information:

	Minimum	Maximum
Flow Rate	<input type="text"/>	<input type="text"/>
Flow Velocity	<input type="text"/>	<input type="text"/>
Line Pressure	<input type="text"/>	<input type="text"/>
Back Pressure	<input type="text"/>	<input type="text"/>
Media	<input type="text"/>	
Discharge:	<input type="checkbox"/> Atmosphere	<input type="checkbox"/> Water
Type of Backing Ring:	<input type="checkbox"/> SS304	<input type="checkbox"/> SS316
	<input type="checkbox"/> Carbon Steel	<input type="checkbox"/> Other

ID <sup>1</sup>	1	1-1/2	2	2-1/2	3	4	5	6	8	10	12	14	16
F/F <sup>1</sup>	3	3-7/8	5-1/4	6-1/4	7-1/2	9	11	12	14	16	18	20	23
H <sup>1</sup>	7/8	7/8	7/8	7/8	1-1/8	1-1/8	1-1/8	1-3/8	1-3/8	1-3/8	1-3/8	1-3/8	1-3/8
W <sup>1*</sup>	2-1/8	2-5/8	3-7/8	4-5/8	5-1/2	7-3/8	8-3/4	10-1/2	13-3/4	17	19-5/8	24-3/4	26-1/2
Weight <sup>2</sup>	2.5	4	5	8	11	15	17	21	25	37	59	75	124
ID <sup>1</sup>	18	20	24	28	30	32	36	42	48	54	60	63	72
F/F <sup>1</sup>	25	32	41	44	46	52	58	61	70	74	80	88	97
H <sup>1</sup>	1-3/8	1-7/8	1-7/8	1-7/8	1-7/8	1-7/8	1-7/8	2-3/8	2-3/8	2-3/8	2-3/8	2-3/8	2-3/8
W <sup>1*</sup>	29-3/4	31-1/2	43	46	49	51	55-1/4	66-1/4	74-1/2	78-1/4	85	92	105
Weight <sup>2</sup>	205	315	400	475	551	602	654	950	997	1070	1271	1310	1480

1 - inches      2 - pounds (approx.)

Dimensions can be revised to suit custom specifications.

\*Dimensions are for clearance purposes only. Actual product dimensions may vary based upon specific application requirements. Consult factory for other sizes.

### Elastomer Selection Guide

#### Ethylene Propylene Rubber (EPDM)

Most effective for applications involving water, steam or diluted acids.

#### Viton (FKM)

Resists solvents, halogenated hydrocarbons, oxygen, weather, ozone, oils and chemicals.

#### Buna N (NBR)

Resistant to kerosene, moderate chemicals, fats, oils, grease and many hydrocarbons.

#### Pure Gum Rubber (PGR) / Natural Rubber (NR)

Good abrasion resistance, tensile strength and resiliency. Also suitable when dealing with organic acids, alcohols, ketones and most moderate chemicals.

#### Hypalon (CSM)

Resists strong acids and bases, ozone, weathering, heat and oxidizing chemicals.

#### Butyl (CIIR)

Good resistance to animal and vegetable fats, strong and oxidizing chemicals, oils, heat and greases.

#### Neoprene (CR)

Generally resistant to oil and grease, moderate chemicals, fats, many hydrocarbons and ozone. Resistant to barnacle growth.

When placing your order, please indicate sleeve material by appending elastomer abbreviation (CR, NR, etc) to the model name.  
IE: Series CPF-CR

300mm CPF / CPO DUCKBILL CHECK VALVE

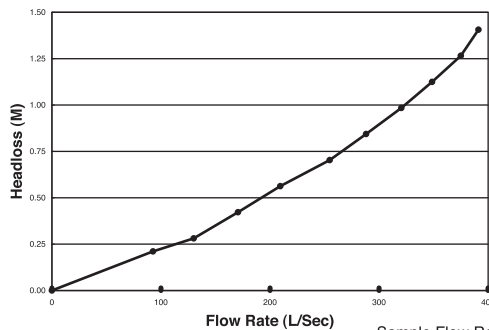

600mm CPF / CPO DUCKBILL CHECK VALVE

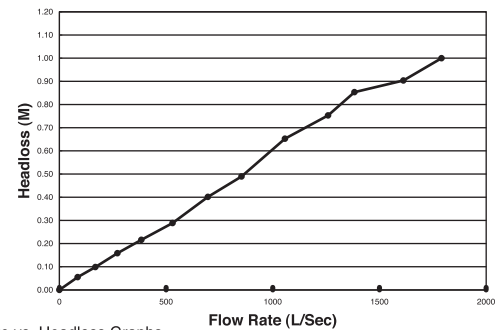

Sample Flow Rate vs. Headloss Graphs.  
Other valve sizes available upon request.  
Based on flow testing at Utah State University.

### Warranty Policy

All products manufactured by Elasto-Valve Rubber Products Inc. (EVR) are guaranteed against defects resulting from faulty workmanship or materials for one (1) year from date of shipment to Buyer. If any such product is found to be defective by reason of faulty workmanship or materials, then upon written notice and return of the product, and at EVR's sole discretion, the defective product will be replaced or repaired by EVR free of charge at EVR's factory. Claims for labour costs and other expenses required to replace and/or transport such defective product or to repair damage resulting from the use thereof will not be allowed by EVR. Our liability does not include consequential damages and is limited to the price paid for the defective product. EVR shall not be bound by any other warranty other than the above set forth unless such warranty shall be agreed in writing by EVR. All EVR literature is published in good faith and is believed to be reliable at time of print; however, due to product design changes EVR reserves the right to make alterations from published materials at any time. Formal approval drawings are available to confirm individual products upon request at time of order.

Distributed by:

### ELASTO-VALVE RUBBER PRODUCTS INC.

1691 Pioneer Road, Sudbury,  
Ontario Canada P3G 1B2  
Tel. (705)523-2026 - Fax. (705)523-2033  
Toll Free 1-800-461-6331 (N.A.)  
Website: [www.evrproducts.com](http://www.evrproducts.com)  
E-mail: [sales@evrproducts.com](mailto:sales@evrproducts.com)

ISO 9001 Certified



- Quiet operation
- Zero maintenance
- Design prevents backflow
- Will seal around solids
- Designed to withstand wear
- Tough enough for abrasive slurries

The Series CPI In-Line Check Valve is designed to be efficient, quiet and tough. It requires no external power sources, thereby reducing operation costs. The valve's simple design means there are no moving mechanical parts to break down or jam reducing maintenance costs.

CPI Valves easily handle corrosive or abrasive materials such as raw sewage, sludges or slurries. Their flexible design allows solids to pass through unhindered and can even surround solids trapped in the valve.

Series CPI In-Line Check Valves are versatile and can be installed either horizontally or vertically. Drilling is available in all flange standards.

The series CPI/IN is also available as an insert type check valve. An internal clamp is used to fasten the check valve to the inside of an existing pipe.



### Typical Applications

Sewer Interceptors - Wet Wells - Mine Tailing Systems - Dredging - Scrubber Systems - Outfall Lines - Wet/Dry Wells

Manufactured with an integral full-faced rubber flange connection, CPI valves are mounted between existing pipe flanges, thereby eliminating the need for a valve body.

The CPI Series valve allows material to flow through...

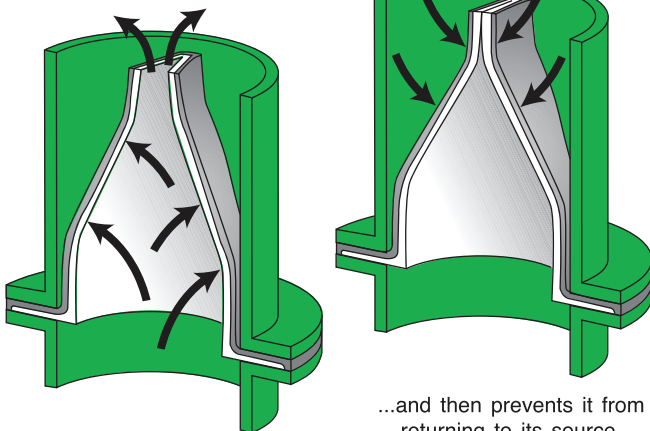

...and then prevents it from returning to its source.

The heart of the Elasto-Valve Series CPI Backflow Preventer is a fabric reinforced rubber "duckbill" sleeve manufactured with top quality materials. This flexible sleeve provides maximum flow with a minimum pressure drop across the valve at all times.

Unlike conventional check valves - which require frequent maintenance to replace worn seats, hinge pins, balls or flappers - there is little or no maintenance with CPI Valves.

Available in a variety of styles and reinforced elastomers, the Elasto-Valve Series CPI Backflow Preventer can be adapted to almost any application.

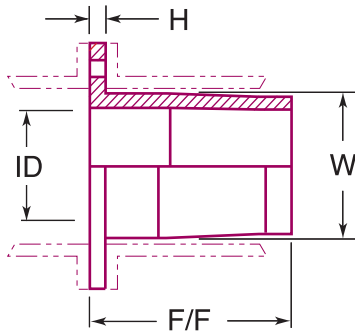

Drilling available in all flange standards.

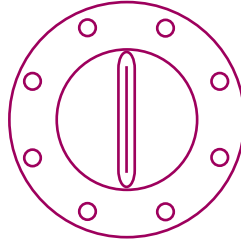

For engineering specifications or when placing your order, please provide the following information:

	Minimum	Maximum
Flow Rate	<input type="text"/>	<input type="text"/>
Flow Velocity	<input type="text"/>	<input type="text"/>
Line Pressure	<input type="text"/>	<input type="text"/>
Back Pressure	<input type="text"/>	<input type="text"/>
Media	<input type="text"/>	<input type="text"/>

PIPE SIZE	2	3	4	5	6	8	10	12	14	16	18	20	24
ID <sup>1</sup>	1-1/4	2-1/4	3	4	5	6-5/8	8-5/8	10	11-1/2	13-1/2	15-1/4	17	20-1/2
F/F <sup>1</sup>	6	7-1/2	13	14-1/2	16	18	20	21	22	24	27	30	33
H <sup>1</sup>	1/2	1/2	3/4	3/4	3/4	3/4	3/4	1	1	1	1	1-3/16	1-3/8
W <sup>1*</sup>	1-7/8	2-7/8	3-7/8	4-7/8	5-7/8	7-5/8	9-5/8	11-7/8	12-3/4	14-3/4	16-3/4	18-3/4	22-3/4

1 - inches    2 - psi

Dimensions can be revised to suit custom specifications. Consult factory for other sizes.

\*Dimensions are for clearance purposes only. Actual product dimensions may vary based upon specific application requirements.

### Elastomer Selection Guide

#### Ethylene Propylene Rubber (EPDM)

Most effective for applications involving water, steam or diluted acids.

#### Viton (FKM)

Resists solvents, halogenated hydrocarbons, oxygen, weather, ozone, oils and chemicals.

#### Buna N (NBR)

Resistant to kerosene, moderate chemicals, fats, oils, grease and many hydrocarbons.

#### Pure Gum Rubber (PGR) / Natural Rubber (NR)

Good abrasion resistance, tensile strength and resiliency. Also suitable when dealing with organic acids, alcohols, ketones and most moderate chemicals.

#### Hypalon (CSM)

Resists strong acids and bases, ozone, weathering, heat and oxidizing chemicals.

#### Butyl (CIIR)

Good resistance to animal and vegetable fats, strong and oxidizing chemicals, oils, heat and greases.

#### Neoprene (CR)

Generally resistant to oil and grease, moderate chemicals, fats,

When placing your order, please indicate sleeve material by appending elastomer abbreviation (CR, NR, etc) to the model name.  
IE: Series CPI-CR

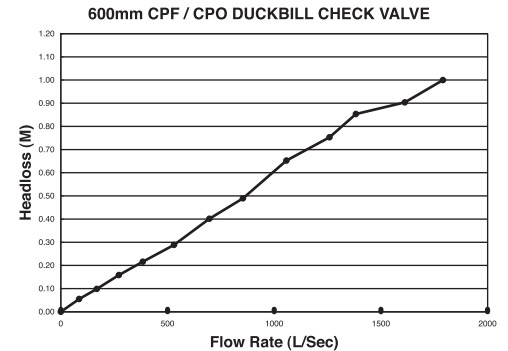
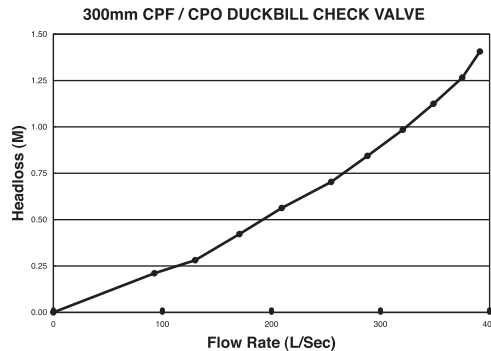

Sample Flow Rate vs. Headloss Graphs. (Note: Adjust flow rate down for CPI valves) Other valve sizes available upon request. Based on flow testing at Utah State University.

### Warranty Policy

All products manufactured by Elasto-Valve Rubber Products Inc. (EVR) are guaranteed against defects resulting from faulty workmanship or materials for one (1) year from date of shipment to Buyer. If any such product is found to be defective by reason of faulty workmanship or materials, then upon written notice and return of the product, and at EVR's sole discretion, the defective product will be replaced or repaired by EVR free of charge at EVR's factory. Claims for labour costs and other expenses required to replace and/or transport such defective product or to repair damage resulting from the use thereof will not be allowed by EVR. Our liability does not include consequential damages and is limited to the price paid for the defective product. EVR shall not be bound by any other warranty other than the above set forth unless such warranty shall be agreed in writing by EVR. All EVR literature is published in good faith and is believed to be reliable at time of print; however, due to product design changes EVR reserves the right to make alterations from published materials at any time. Formal approval drawings are available to confirm individual products upon request at time of order.

Distributed by:

### ELASTO-VALVE RUBBER PRODUCTS INC.

1691 Pioneer Road, Sudbury,  
Ontario Canada P3G 1B2  
Tel. (705)523-2026 - Fax. (705)523-2033  
Toll Free 1-800-461-6331 (N.A.)  
Website: [www.evrproducts.com](http://www.evrproducts.com)  
E-mail: [sales@evrproducts.com](mailto:sales@evrproducts.com)

ISO 9001 Certified





- Quiet operation
- Zero maintenance
- Design prevents backflow
- Will seal around solids
- Designed to withstand wear
- Tough enough for abrasive slurries



The Series CPJ Jacket Check Valve is designed to be efficient, quiet and tough. It requires no external power sources, thereby reducing operation costs. The valve's simple design means there are no moving mechanical parts to break down or jam, reducing maintenance costs.

CPJ Valves easily handle corrosive or abrasive materials such as raw sewage, sludges or slurries. Their flexible design allows solids to pass through unhindered and can even surround solids trapped in the valve.

Series CPJ Jacket Check Valves are versatile and can be installed either horizontally or vertically. Drilling is available in all flange specifications. Contact EVR to discuss your requirements.

#### Typical Applications

Sewer Interceptors - Wet Wells - Mine Tailing Systems - Dredging - Scrubber Systems - Outfall Lines - Wet/Dry Wells

The rugged full metal body and one-piece rubber valve combine quiet performance with lasting durability. The modular design of CPJ Series Valves allows them to fit easily into existing piping systems.

The CPJ Series valve allows material to flow through...

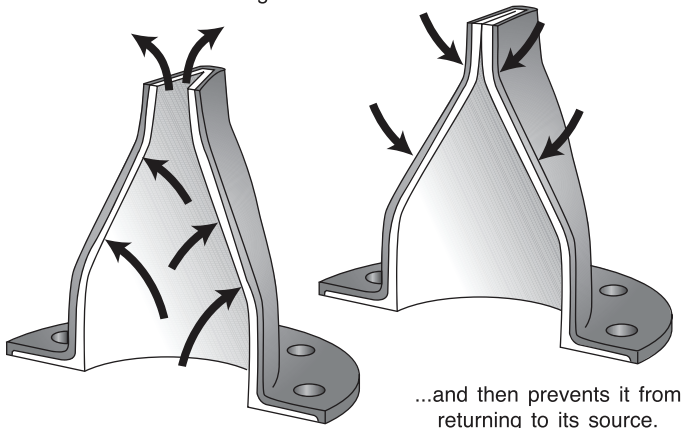

...and then prevents it from returning to its source.

The heart of the Elasto-Valve Series CPJ Backflow Preventer is a fabric reinforced rubber "duckbill" sleeve manufactured with top quality materials. This flexible sleeve provides maximum flow with a minimum pressure drop across the valve at all times.

Unlike conventional check valves - which require frequent maintenance to replace worn seats, hinge pins, balls or flappers - there is little or no maintenance with CPJ Valves.

Available in a variety of styles and reinforced elastomers, the Elasto-Valve Series CPJ Backflow Preventer can be adapted to almost any application.

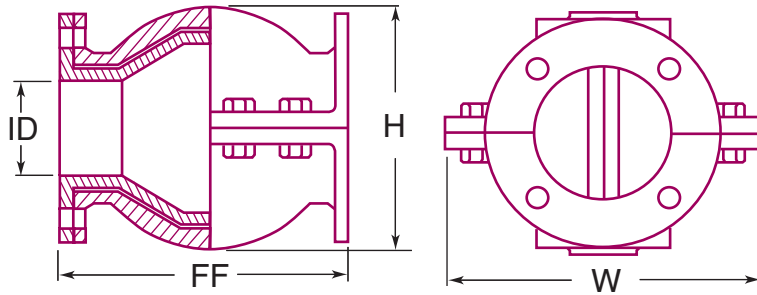

For engineering specifications or when placing your order, please provide the following information:

	Minimum	Maximum
Flow Rate	<input type="text"/>	<input type="text"/>
Flow Velocity	<input type="text"/>	<input type="text"/>
Line Pressure	<input type="text"/>	<input type="text"/>
Back Pressure	<input type="text"/>	<input type="text"/>
Media	<input type="text"/>	
Material of Body:	<input type="checkbox"/> Iron	<input type="checkbox"/> Aluminum

ID <sup>1</sup>	1	1-1/4	1-1/2	2	2-1/2	3	4	5	6	8	10	12	14	16	18	20	24
F/F <sup>1</sup>	4-1/2	5-1/2	6-1/2	8-1/2	9-1/2	11-1/4	11-3/4	15-3/4	19	21	23	25	29	33	38	41-1/2	49-1/2
H <sup>1</sup>	4-1/4	4-5/8	5	7-1/8	7-1/2	8-1/8	10-5/8	11-1/2	13-1/2	18	22-3/8	25	27-1/2	29	32-5/8	36-1/2	47
W <sup>*</sup>	5-3/4	6-1/4	6-1/2	8-1/2	9	10	11-3/4	11-3/4	15-1/4	17-1/2	19-3/8	21-1/2	24	25	28-1/4	29	37-1/2
Weight <sup>2</sup> (Cast Iron)	9	11	17	32	40	51	88	137	180	257	440	640	790	930	1285	1714	2110

1 - inches    2 - pounds (approx.)

Dimensions can be revised to suit custom specifications.  
Consult factory for other sizes.

\*Dimensions are for clearance purposes only. Actual product dimensions may vary based upon specific application requirements.

### Elastomer Selection Guide

#### Ethylene Propylene Rubber (EPDM)

Most effective for applications involving water, steam or diluted acids.

#### Viton (FKM)

Resists solvents, halogenated hydrocarbons, oxygen, weather, ozone, oils and chemicals.

#### Buna N (NBR)

Resistant to kerosene, moderate chemicals, fats, oils, grease and many hydrocarbons.

#### Pure Gum Rubber (PGR) / Natural Rubber (NR)

Good abrasion resistance, tensile strength and resiliency. Also suitable when dealing with organic acids, alcohols, ketones and most moderate chemicals.

#### Hypalon (CSM)

Resists strong acids and bases, ozone, weathering, heat and oxidizing chemicals.

#### Butyl (CIIR)

Good resistance to animal and vegetable fats, strong and oxidizing chemicals, oils, heat and greases.

#### Neoprene (CR)

Generally resistant to oil and grease, moderate chemicals, fats, many hydrocarbons and ozone. Resistant to barnacle growth.

When placing your order, please indicate sleeve material by appending elastomer abbreviation (CR, NR, etc) to the model name.  
IE: Series CPJ-CR

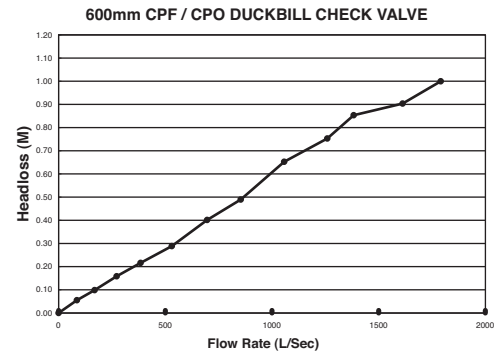
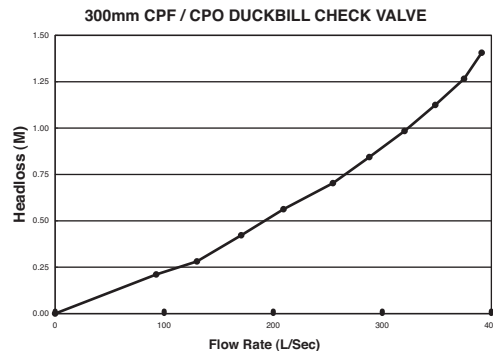

Sample Flow Rate vs. Headloss Graphs.  
Other valve sizes available upon request.  
Based on flow testing at Utah State University.

### Warranty Policy

All products manufactured by Elasto-Valve Rubber Products Inc. (EVR) are guaranteed against defects resulting from faulty workmanship or materials for one (1) year from date of shipment to Buyer. If any such product is found to be defective by reason of faulty workmanship or materials, then upon written notice and return of the product, and at EVR's sole discretion, the defective product will be replaced or repaired by EVR free of charge at EVR's factory. Claims for labour costs and other expenses required to replace and/or transport such defective product or to repair damage resulting from the use thereof will not be allowed by EVR. Our liability does not include consequential damages and is limited to the price paid for the defective product. EVR shall not be bound by any other warranty other than the above set forth unless such warranty shall be agreed in writing by EVR. All EVR literature is published in good faith and is believed to be reliable at time of print; however, due to product design changes EVR reserves the right to make alterations from published materials at any time. Formal approval drawings are available to confirm individual products upon request at time of order.

Distributed by:

### ELASTO-VALVE RUBBER PRODUCTS INC.

1691 Pioneer Road, Sudbury,  
Ontario Canada P3G 1B2  
Tel. (705)523-2026 - Fax. (705)523-2033  
Toll Free 1-800-461-6331 (N.A.)  
Website: [www.evrproducts.com](http://www.evrproducts.com)  
E-mail: [sales@evrproducts.com](mailto:sales@evrproducts.com)

ISO 9001 Certified



- Quiet operation
- Zero maintenance
- Design prevents backflow
- Will seal around solids
- Designed to withstand wear
- Tough enough for abrasive slurries

The Series CPO Slip-On Check Valve is designed to be efficient, quiet and tough. It requires no external power sources, thereby reducing operation costs. The valve's simple design means there are no moving mechanical parts to break down or jam, reducing maintenance costs.

CPO Valves easily handle corrosive or abrasive materials such as raw sewage, sludges or slurries. Their flexible design allows solids to pass through unhindered and can even surround solids trapped in the valve.

Series CPO Slip-On Check Valves are versatile and can be installed either horizontally or vertically.



#### Typical Applications

Sewer Interceptors - Wet Wells - Mine Tailing Systems - Dredging - Scrubber Systems - Outfall Lines - Wet/Dry Wells

Designed to mount directly on existing piping, the Series CPO Valve is held in place with durable stainless steel clamps.

The CPO Series valve allows material to flow through...

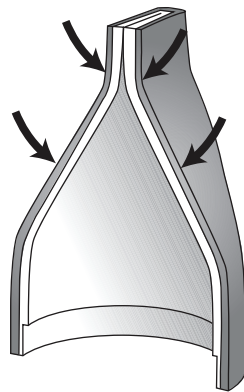
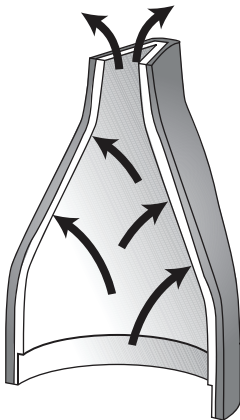

...and then prevents it from returning to its source.

The heart of the Elasto-Valve Series CPO Backflow Preventer is a fabric reinforced rubber "duckbill" sleeve manufactured with top quality materials. This flexible sleeve provides maximum flow with a minimum pressure drop across the valve at all times.

Unlike conventional check valves - which require frequent maintenance to replace worn seats, hinge pins, balls or flappers - there is little or no maintenance with CPO Valves.

Available in a variety of styles and reinforced elastomers, the Elasto-Valve Series CPO Backflow Preventer can be adapted to almost any application.

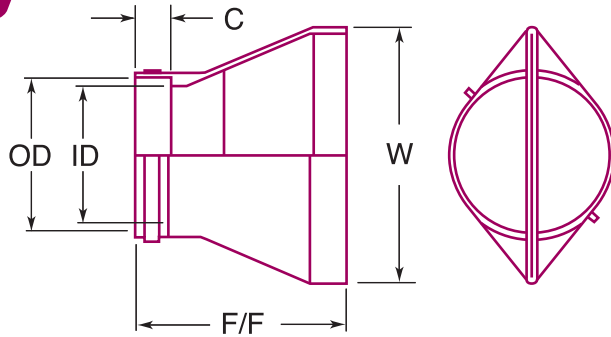

For engineering specifications or when placing your order, please provide the following information:

	Minimum	Maximum
Flow Rate	<input type="text"/>	<input type="text"/>
Flow Velocity	<input type="text"/>	<input type="text"/>
Line Pressure	<input type="text"/>	<input type="text"/>
Back Pressure	<input type="text"/>	<input type="text"/>
Media	<input type="text"/>	
Mounting Pipe:	<input type="text"/> I.D.	<input type="text"/> O.D.
Discharge:	<input type="checkbox"/> Atmosphere	<input type="checkbox"/> Water
Type of Clamp:	<input type="checkbox"/> SS316	<input type="checkbox"/> Other

ID <sup>1</sup>	1/2	3/4	1	1-1/2	2	2-1/2	3	4	5	6	8	10	12	14	16	18
F/F <sup>1</sup>	2-1/2	3	3-1/4	4-1/2	5-3/4	7-1/2	9	12	13	15	17	18	24	26-1/2	28	31
C <sup>1</sup>	1	1	1	1	1-1/2	2	3	3	3	4	4	4	6	6	6	6
W <sup>1*</sup>	1	1-1/2	2-1/8	2-5/8	3-7/8	4-5/8	5-1/2	7-3/8	8-3/4	10-1/2	13-3/4	17	19-5/8	24-3/4	26-1/2	29-3/4
Weight <sup>2</sup>	.25	.75	1.5	3.8	4.75	7.6	10.45	14.25	16.15	20	23.75	35.15	56	71.25	118	195
ID <sup>1</sup>	20	24	28	30	32	36	42	48	54	60	63	70	72	78	84	94
F/F <sup>1</sup>	32	41	44	46	52	58	61	70	74	80	88	95	97	100	102	105
C <sup>1</sup>	8	8	8	10	10	10	12	12	12	12	12	14	14	18	18	18
W <sup>1*</sup>	31-1/2	43	46	49	51	55-1/4	66-1/4	74-1/2	78-1/4	85	92	100	105	107	111	150
Weight <sup>2</sup>	299	380	451	523	572	621	902	947	1016	1207	1245	1300	1356	1500	1750	2000

1 - inches    2 - pounds (approx.)

\*Dimensions are for clearance purposes only. Actual product dimensions may vary based upon specific application requirements.

Dimensions can be revised to suit custom specifications. Consult factory for other sizes.

### Elastomer Selection Guide

**Ethylene Propylene Rubber (EPDM)**  
Most effective for applications involving water, steam or diluted acids.

**Viton (FKM)**  
Resists solvents, halogenated hydrocarbons, oxygen, weather, ozone, oils and chemicals.

**Buna N (NBR)**  
Resistant to kerosene, moderate chemicals, fats, oils, grease and many hydrocarbons.

**Pure Gum Rubber (PGR) / Natural Rubber (NR)**  
Good abrasion resistance, tensile strength and resiliency. Also suitable when dealing with organic acids, alcohols, ketones and most moderate chemicals.

**Hypalon (CSM)**  
Resists strong acids and bases, ozone, weathering, heat and oxidizing chemicals.

**Butyl (CIIR)**  
Good resistance to animal and vegetable fats, strong and oxidizing chemicals, oils, heat and greases.

**Neoprene (CR)**  
Generally resistant to oil and grease, moderate chemicals, fats,

When placing your order, please indicate sleeve material by appending elastomer abbreviation (CR, NR, etc) to the model name.  
e.g: Series CPO-CR

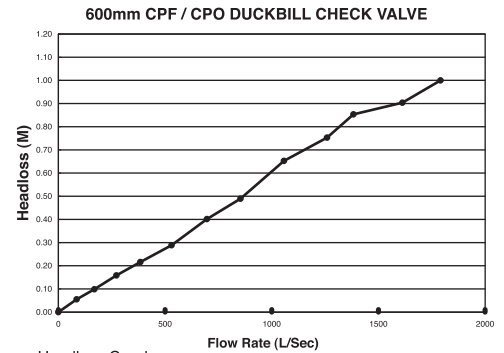
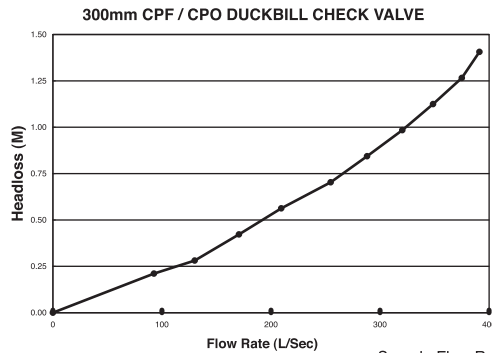

Sample Flow Rate vs. Headloss Graphs.  
Other valve sizes available upon request.  
Based on flow testing at Utah State University.

### Warranty Policy

All products manufactured by Elasto-Valve Rubber Products Inc. (EVR) are guaranteed against defects resulting from faulty workmanship or materials for one (1) year from date of shipment to Buyer. If any such product is found to be defective by reason of faulty workmanship or materials, then upon written notice and return of the product, and at EVR's sole discretion, the defective product will be replaced or repaired by EVR free of charge at EVR's factory. Claims for labour costs and other expenses required to replace and/or transport such defective product or to repair damage resulting from the use thereof will not be allowed by EVR. Our liability does not include consequential damages and is limited to the price paid for the defective product. EVR shall not be bound by any other warranty other than the above set forth unless such warranty shall be agreed in writing by EVR. All EVR literature is published in good faith and is believed to be reliable at time of print; however, due to product design changes EVR reserves the right to make alterations from published materials at any time. Formal approval drawings are available to confirm individual products upon request at time of order.

Distributed by:

**ELASTO-VALVE RUBBER PRODUCTS INC.**  
1691 Pioneer Road, Sudbury,  
Ontario Canada P3G 1B2  
Tel. (705)523-2026 - Fax. (705)523-2033  
Toll Free 1-800-461-6331 (N.A.)  
Website: [www.evrproducts.com](http://www.evrproducts.com)  
E-mail: [sales@evrproducts.com](mailto:sales@evrproducts.com)

ISO 9001 Certified



- **Protects against flooding**
- **Eliminates reverse flows through piping systems**
- **Controls the spread of odour & gases**
- **Easy to install, even in existing pipes and chambers**
- **No mechanical parts**
- **Self-cleaning - minimal maintenance**



### Typical Applications

The WaStop backflow valve consists of two parts, the elastomer sleeve (rubber membrane) and the pipe.

The pipe is made of either plastic or stainless steel. The standard sleeve is made of a specially formulated blend of elastomers which gives it exceptional shape retention and chemical resistance. The sleeve folds up and out of the way with very little pressure. Inversely the sleeve is able to resist several meters of pressure in the opposite direction.

The WaStop can be used to prevent sewer gas, effluent, sand or seaweed backflow into cellars or storm water drains. The WaStop can be used to protect against overflows in manholes, storm water drains, storm water tanks, sewage works, drainage pipes, culvert systems and ditches. The WaStop can even be used for water tower overflow pipes to protect against the entrance of animals and insects.

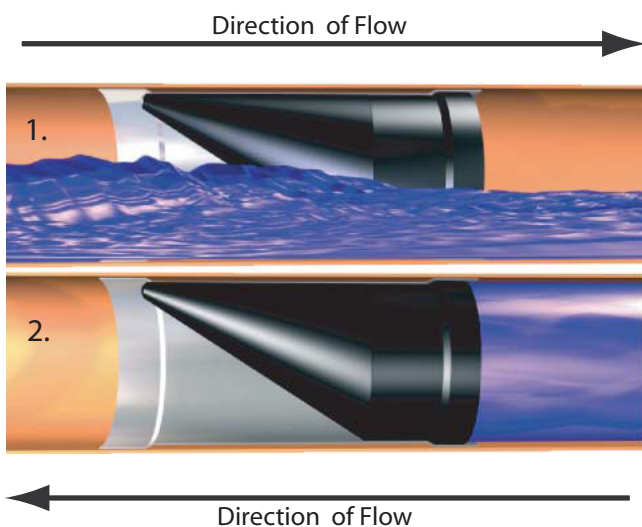

### How the Valve Works

1. Flow into the inlet side of the valve causes a small pressure build-up against the rubber sleeve which in turn causes the sleeve to open just enough to allow the liquid to flow unhindered.

2. Reverse flow fills the 'cone' portion of the elastomeric sleeve, pressing it against the inside walls of the pipe and creating a seal. Neither fluid nor gases can pass back into the inlet side of the pipe.

**Insertion in existing pipe**

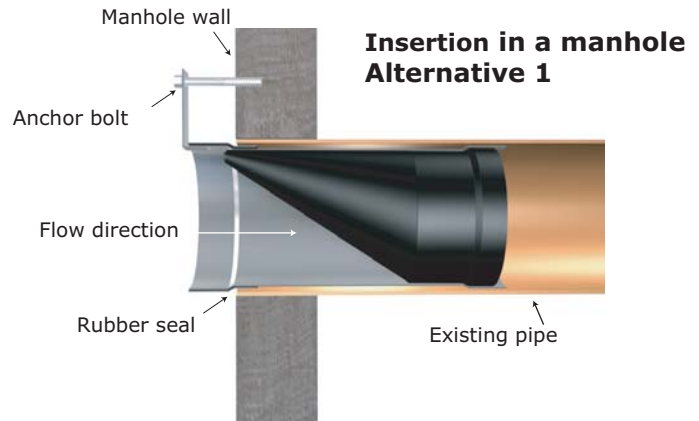
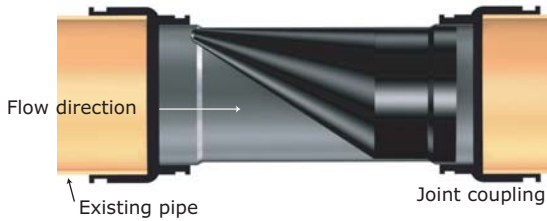

**Insertion in a manhole Alternative 2**

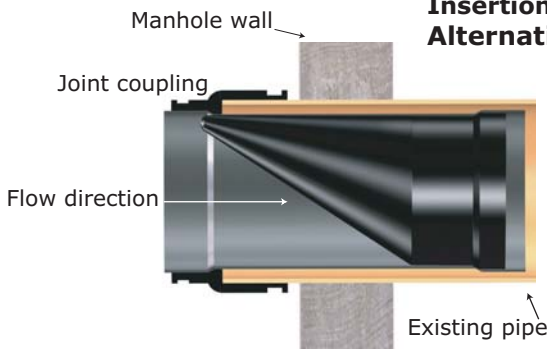

**Dimensions**

DN	ID	L
110	4"	9.5"
160	6"	12"
200	8"	16"
250	10"	18"
300	12"	24"
400	16"	31"
500	20"	39"
600	24"	47"
800	32"	59"
1000	40"	83"

Sample Flow Rate vs. Headloss Graphs.  
Other valve sizes available upon request.  
Based on flow testing by Vattenfall Utveckling AB.

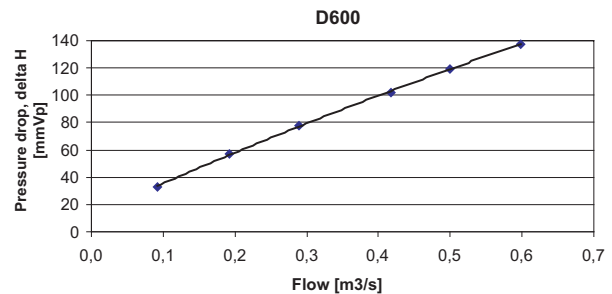
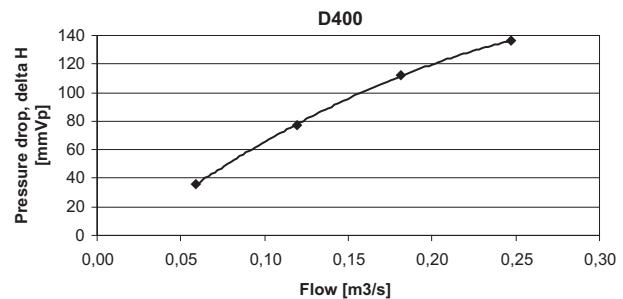
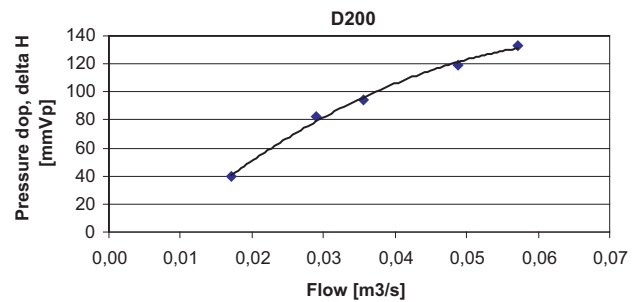

**Warranty Policy**

All products manufactured by Elasto-Valve Rubber Products Inc. (EVR) are guaranteed against defects resulting from faulty workmanship or materials for one (1) year from date of shipment to Buyer. If any such product is found to be defective by reason of faulty workmanship or materials, then upon written notice and return of the product, and at EVR's sole discretion, the defective product will be replaced or repaired by EVR free of charge at EVR's factory. Claims for labour costs and other expenses required to replace and/or transport such defective product or to repair damage resulting from the use thereof will not be allowed by EVR. Our liability does not include consequential damages and is limited to the price paid for the defective product. EVR shall not be bound by any other warranty other than the above set forth unless such warranty shall be agreed in writing by EVR. All EVR literature is published in good faith and is believed to be reliable at time of print; however, due to product design changes EVR reserves the right to make alterations from published materials at any time. Formal approval drawings are available to confirm individual products upon request at time of order.

Distributed by:

**ELASTO-VALVE RUBBER PRODUCTS INC.**

1691 Pioneer Road, Sudbury,  
Ontario Canada P3G 1B2  
Tel. (705)523-2026 - Fax. (705)523-2033  
Toll Free 1-800-461-6331 (N.A.)  
Website: [www.evrproducts.com](http://www.evrproducts.com)  
E-mail: [sales@evrproducts.com](mailto:sales@evrproducts.com)

ISO 9001 Certified



## CHECK VALVE SPECIFICATION SHEET

PLEASE COMPLETE AND FAX BACK TO EVR AT (705) 523-2033

**NOTE:** Failure to fill in all details may result in a delay to quotation. For extreme operating conditions, the pricing may be affected.

<b>Date:</b>	
<b>Reference Quote (if applicable):</b>	
<b>Company:</b>	
<b>Project Name (if known):</b>	
<b>Contact Name/Title:</b>	
<b>Contact Information:</b>	

### REQUIRED APPLICATION DETAILS

*Provide as much information as possible. We may not be able to process your order if any fields are left blank.  
Please ensure that the units of measurement are specified.*

<b>Expected media passing through valve</b>			
<b>List any additional trace chemicals that could be found in the media</b>			
<b>Inlet Pressure</b> (m of H2O, ft of head, psig)			
<b>Maximum Back Pressure</b>	0 - 5m (7 psi)	5 - 10m (14 psi)	Greater than 10m - Specify: <input style="width: 50px;" type="text"/>
<b>Media Temperature</b> (°C/°F)	A: Less than -40F (-40C)	B: - 40F to 180F (82C)	C: Greater than 180F
<i>If A or C above, please specify:</i>			
<b>Flow Rate</b> (l/s, GPM)	Minimum <input style="width: 100px;" type="text"/>		Maximum <input style="width: 100px;" type="text"/>
<b>Provide detailed description of the application</b> (e.g. storm water run-off)			

### ADDITIONAL APPLICATION DETAILS







*If unknown, please mark as "N/A".*

<b>Expected media density</b> (lb/cu.in, kg/cu.m)	
<b>Preferred Elastomer (if known)</b>	
<b>Location of valve</b> (e.g. end of pipe in culvert)	

**Please attach any other additional information that is relevant to the application (e.g. elevation drawings, specification sheets, etc.)**

### VALVE SELECTION DETAILS

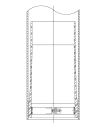
*Please identify the required valve and provide all the applicable details.  
Complete pipe information is essential in order to correctly size the valve for quotation.*

	CPO	CPF	CPJ	CPI	CPI-IN	WASTOP
<b>Please select choice of valve</b>						
<b>Quantity Required</b>	<input style="width: 50px;" type="text"/>	<input style="width: 50px;" type="text"/>	<input style="width: 50px;" type="text"/>	<input style="width: 50px;" type="text"/>	<input style="width: 50px;" type="text"/>	<input style="width: 50px;" type="text"/>
<b>Pipe Style</b> (Concrete, FRP, ABS, etc...)	<input style="width: 50px;" type="text"/>	<input style="width: 50px;" type="text"/>	<input style="width: 50px;" type="text"/>	<input style="width: 50px;" type="text"/>	<input style="width: 50px;" type="text"/>	<input style="width: 50px;" type="text"/>
<b>Pipe Inside Diameter (ID)</b> Include Units of Measurement	<input style="width: 50px;" type="text"/>	<input style="width: 50px;" type="text"/>	<input style="width: 50px;" type="text"/>	<input style="width: 50px;" type="text"/>	<input style="width: 50px;" type="text"/>	<input style="width: 50px;" type="text"/>
<b>Pipe Outside Diameter (OD)</b> Include Units of Measurement	<input style="width: 50px;" type="text"/>	<input style="width: 50px;" type="text"/>	<input style="width: 50px;" type="text"/>	<input style="width: 50px;" type="text"/>	<input style="width: 50px;" type="text"/>	<input style="width: 50px;" type="text"/>
<b>Flange Drilling</b> (ANSI B16.7 150#, AS2129 Table "D", etc...)		<input style="width: 50px;" type="text"/>	<input style="width: 50px;" type="text"/>	<input style="width: 50px;" type="text"/>		
<b>Retaining Rings Required?</b>		<input type="checkbox"/> YES <input type="checkbox"/> NO	<input type="checkbox"/> YES <input type="checkbox"/> NO	<input type="checkbox"/> YES <input type="checkbox"/> NO		
<b>Clamps Required?</b>	<input type="checkbox"/> YES <input type="checkbox"/> NO				<input type="checkbox"/> YES <input type="checkbox"/> NO	

QD-86 REV5-March/2013 ISO 9001 + CSA-Z299.3-1985



# ELASTO VALVE'S PRODUCT RANGE INCLUDES...

## PINCH VALVES



## PRESSURE SENSORS



## RUBBER CHECK VALVES



## EXPANSION JOINTS



### AS WELL AS....

- FLUE DUCT EXPANSION JOINTS
- METAL EXPANSION JOINTS
- EXPANSION LOOPS & METAL HOSE
- TEFLON EXPANSION JOINTS
- PINCH VALVE REPLACEMENT SLEEVES

#### Warranty Policy

All products manufactured by Elasto-Valve Rubber Products Inc. (EVR) are guaranteed against defects resulting from faulty workmanship or materials for one (1) year from date of shipment to Buyer. If any such product is found to be defective by reason of faulty workmanship or materials, then upon written notice and return of the product, and at EVR's sole discretion, the defective product will be replaced or repaired by EVR free of charge at EVR's factory. Claims for labour costs and other expenses required to replace and/or transport such defective product or to repair damage resulting from the use thereof will not be allowed by EVR. Our liability does not include consequential damages and is limited to the price paid for the defective product. EVR shall not be bound by any other warranty other than the above set forth unless such warranty shall be agreed in writing by EVR. All EVR literature is published in good faith and is believed to be reliable at time of print; however, due to product design changes EVR reserves the right to make alterations from published materials at any time. Formal approval drawings are available to confirm individual products upon request at time of order.

Distributed by:

**ELASTO-VALVE RUBBER PRODUCTS INC.**  
1691 Pioneer Road, Sudbury,  
Ontario Canada P3G 1B2  
Tel. (705)523-2026 - Fax. (705)523-2033  
Toll Free 1-800-461-6331 (N.A.)  
Website: [www.evrproducts.com](http://www.evrproducts.com)  
E-mail: [sales@evrproducts.com](mailto:sales@evrproducts.com)

ISO 9001 Certified

