

FEEDING & COIL HANDLING EQUIPMENT

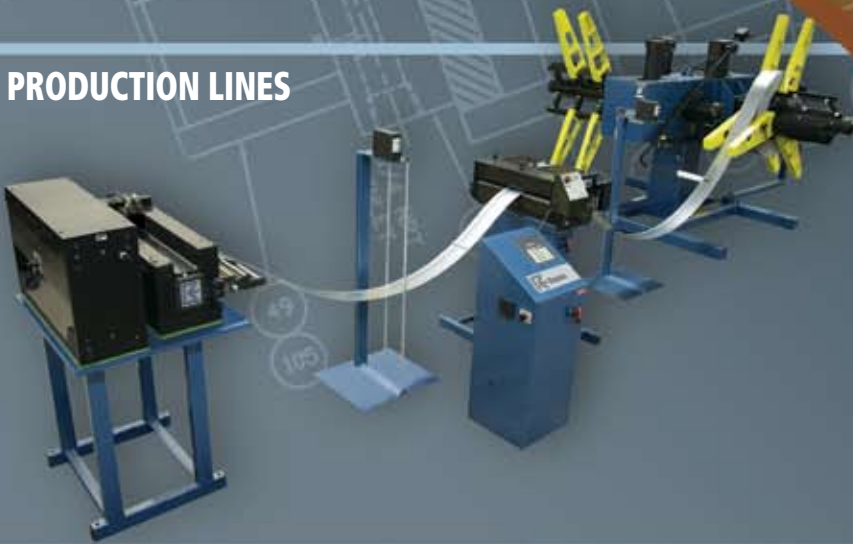

**EUROPEAN
PRODUCT LINE**

PRODUCTION LINES



INDIVIDUAL PRODUCTS



CUSTOM SOLUTIONS



compliance
on products
shown
is complete
or in-progress

INDEX:

Air Feeds	2
Servo Feeds	4
Straighteners	6
Stock Reels	7
Cutters	8
Cut-To-Length	8

Air Feeds

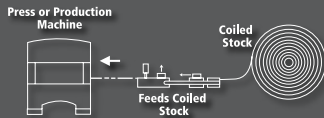

Rapid-Air Feeds

Rapid-Air gives you more choices.

Accessories and options.

Many accessories and options tailor Rapid-Air feeds to a variety of applications to feed metals, wire, plastic, fabric, you name it; and in most any shape including – flat, round, extrusions, etc.

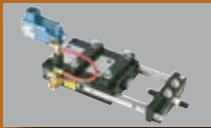

Electric actuating valve.

An alternate to the standard actuating valve provided with each feed. Electric valve 2-way, normally open, one size for series A & B feeds, one for Series C, D, F, H, J & W feeds, and another with quick exhaust for Series L, P, FX & LX. A.C. or D.C. solenoid available.



Custom stock & feed clamps.

To accommodate special material configurations, such as extrusions, delicate surfaces or soft, pliable materials. Rubber, leather, nylon and vinyl are among the clamp insert materials available.



Special wear plates.

Replaceable wear plates can be grooved to accommodate special shapes and sizes.



Anti-buckling guides.

Specialty designed guides to prevent buckling of very thin flat or wire stock feeding at high speeds and/or long progressions.



Belt feed.

Enables feeds to accurately feed very limp delicate stock, including metals, teflon and other tapes, foil strips, fabrics, paper, photographic film and gasket materials. Material (even skeleton) is sandwiched between two endless belts to move it into or out of a press or other machines.

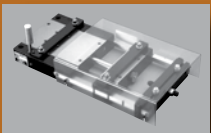

Safety guards.

See-through high-strength plastic safety guard shields the moving mechanism. For applications where safety requirements include machine guarding.

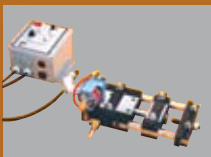

Multi-stroke control.

Provides longer stroke progressions between press strokes by cycling feed several times prior to a press stroke. Equipped with electric valve and fittings. Standard control variable up to 9 feed cycles - other control models available. All feed series can be used with the multi-stroke control.



Pilot release stock clamp.

The spring-loaded stock clamp, optional with all Rapid-Air feeds, is recommended for most applications. For unusual requirements, the pilot release stock clamp is available. An electric signal actuates the pilot release clamp so that it lifts completely to allow for free movement of stock to position material when pilots are used. Solenoid valve not included. Order separately from Rapid-Air.

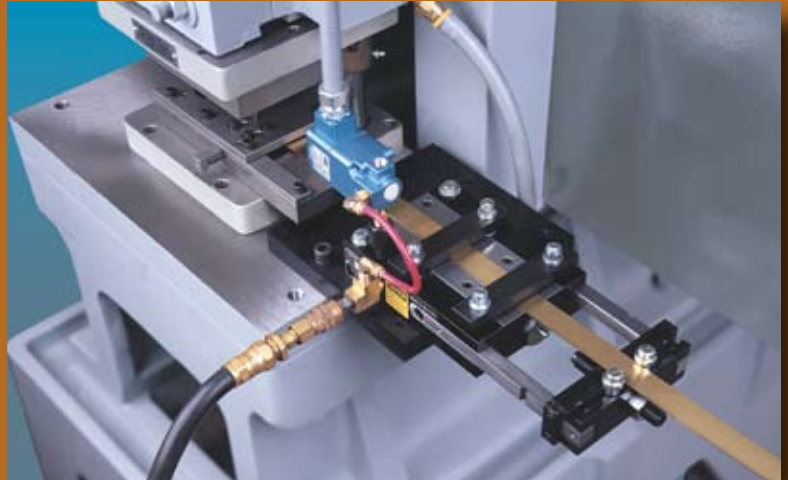

Rapid-Air units are simple to service. All internal parts are readily accessible. Please visit our web site at www.rapidair.com. Service manuals are available for download. AutoCAD assembly files may be e-mailed to you for design assist. (English language only)

Model Selection

Model	Max Material Width	Max Stroke Length*1	Stock Thickness*2	Speed Cycles/Min. (recom.)*3	Pulling Capacity*4
A2	38,1mm (1-1/2")	50mm (2")	0,051-1,02mm (0,002" - 0,040")	260	9,1kg (20 lbs)
A4	38,1mm (1-1/2")	101,6mm (4")	0,051-1,02mm (0,002" - 0,040")	200	9,1kg (20 lbs)
A6	38,1mm (1-1/2")	152mm (6")	0,051-1,02mm (0,002" - 0,040")	160	9,1kg (20 lbs)
B2	63,5mm (2-1/2")	50mm (2")	0,051-1,02mm (0,002" - 0,040")	230	9,1kg (20 lbs)
B4	63,5mm (2-1/2")	101,6mm (4")	0,051-0,89mm (0,002" - 0,035")	175	9,1kg (20 lbs)
C3	76,2mm (3")	76,2mm (3")	0,076-1,91mm (0,003" - 0,075")	195	20,5kg (45 lbs)
C6	76,2mm (3")	152mm (6")	0,076-1,57mm (0,003" - 0,062")	140	20,5kg (45 lbs)
D3	101,6mm (4")	76,2mm (3")	0,076-1,91mm (0,003" - 0,075")	175	20,5kg (45 lbs)
D6	101,6mm (4")	152mm (6")	0,076-1,57mm (0,003" - 0,062")	135	20,5kg (45 lbs)
W6	50,8mm (2")	152mm (6")	0,076-2,29mm (0,003" - 0,090")	140	45,5kg (100 lbs)
W12	50,8mm (2")	305mm (12")	0,076-1,57mm (0,003" - 0,062")	85	45,5kg (100 lbs)
F4	152mm (6")	101,6mm (4")	0,1-1,91mm (0,004" - 0,075")	160	45,5kg (100 lbs)
F6	152mm (6")	152mm (6")	0,1-1,91mm (0,004" - 0,075")	130	45,5kg (100 lbs)
F8	152mm (6")	203mm (8")	0,1-1,57mm (0,004" - 0,062")	105	45,5kg (100 lbs)
F12	152mm (6")	305mm (12")	0,1-1,27mm (0,004" - 0,050")	70	45,5kg (100 lbs)
H4	203mm (8")	101,6mm (4")	0,1-1,91mm (0,004" - 0,075")	160	45,5kg (100 lbs)
H8	203mm (8")	203mm (8")	0,1-1,57mm (0,004" - 0,062")	105	45,5kg (100 lbs)
H12	203mm (8")	305mm (12")	0,1-1,27mm (0,004" - 0,050")	70	45,5kg (100 lbs)
J4	254mm (10")	101,6mm (4")	0,1-1,91mm (0,004" - 0,075")	135	45,5kg (100 lbs)
J12	254mm (10")	305mm (12")	0,1-1,14mm (0,004" - 0,045")	60	45,5kg (100 lbs)
FX6	152mm (6")	152mm (6")	0,13-3,81mm (0,005" - 0,150")	105	66kg (145 lbs)
FX12	152mm (6")	305mm (12")	0,13-3,81mm (0,005" - 0,150")	60	66kg (145 lbs)
L6	305mm (12")	152mm (6")	0,13-2,29mm (0,005" - 0,090")	105	66kg (145 lbs)
L12	305mm (12")	305mm (12")	0,13-2,29mm (0,005" - 0,090")	60	66kg (145 lbs)
LX12	305mm (12")	305mm (12")	0,13-3,18mm (0,005" - 0,125")	50	114kg (250 lbs)

*1 Electric Actuating Valve is recommended for feeds that have stroke length over 203mm (8"). Add "E" to model number.

*2 Thinner materials and/or long strokes with thin materials possible by using anti-buckling guides. Maximum thickness capacity increases by same percentage as stock width decreases (up to max. of 150%).

*3 Approximate at maximum stroke length. Heavy stock requires slower speeds.

*4 At 6,9 bar (100 psi). (Includes allowance for normal friction of moving parts).

Add "W" to Model A or B for replaceable wear plates (standard on all other models).

Add "P" to model no. for feed with control port only. Add "S" to model no. for feed with end-of-stroke sensors.

Feeds should always draw material from a free loop, supplied by a powered reel or powered straightener.

Air Feeds

Specifications and Dimensions

Compact and versatile. Conveniently and easily mounted where you need them.

Specifications and Dimensions

Model	A	B	C	D	E	F	G	H	J	K	L
A2	220mm (8,69")	81mm (3,22")	31mm (1,24")	88mm (3,50")	68mm (2,69")	9mm (0,38")	66mm (2,62")	3mm (1/8")	8mm (0,33")	33mm (1,31")	12mm (0,50")
A4	322mm (12,69")	81mm (3,22")	31mm (1,24")	88mm (3,50")	68mm (2,69")	9mm (0,38")	66mm (2,62")	3mm (1/8")	8mm (0,33")	33mm (1,31")	12mm (0,50")
A6	423mm (16,69")	81mm (3,22")	31mm (1,24")	88mm (3,50")	68mm (2,69")	9mm (0,38")	66mm (2,62")	3mm (1/8")	8mm (0,33")	33mm (1,31")	12mm (0,50")
B2	220mm (8,69")	107mm (4,22")	31mm (1,24")	88mm (3,50")	68mm (2,69")	9mm (0,38")	91mm (3,62")	3mm (1/8")	8mm (0,33")	33mm (1,31")	12mm (0,50")
B4	322mm (12,69")	107mm (4,22")	31mm (1,24")	88mm (3,50")	68mm (2,69")	9mm (0,38")	91mm (3,62")	3mm (1/8")	8mm (0,33")	33mm (1,31")	12mm (0,50")
C3	311mm (12,25")	139mm (5,50")	43mm (1,73")	139mm (5,50")	104mm (4,12")	12mm (0,50")	114mm (4,50")	6mm (1/4")	9mm (0,39")	38mm (1,53")	15mm (0,62")
C6	463mm (18,25")	139mm (5,50")	43mm (1,73")	139mm (5,50")	104mm (4,12")	12mm (0,50")	114mm (4,50")	6mm (1/4")	9mm (0,39")	38mm (1,53")	15mm (0,62")
D3	311mm (12,25")	165mm (6,50")	43mm (1,73")	139mm (5,50")	104mm (4,12")	12mm (0,50")	139mm (5,50")	6mm (1/4")	9mm (0,39")	38mm (1,53")	15mm (0,62")
D6	463mm (18,25")	165mm (6,50")	43mm (1,73")	139mm (5,50")	104mm (4,12")	12mm (0,50")	139mm (5,50")	6mm (1/4")	9mm (0,39")	38mm (1,53")	15mm (0,62")
W6	506mm (19,94")	127mm (5,00")	50mm (1,98")	146mm (5,75")	109mm (4,31")	17mm (0,69")	107mm (4,25")	6mm (1/4")	13mm (0,53")	66mm (2,62")	14mm (0,56")
W12	811mm (31,94")	127mm (5,00")	50mm (1,98")	146mm (5,75")	109mm (4,31")	17mm (0,69")	107mm (4,25")	6mm (1/4")	13mm (0,53")	66mm (2,62")	14mm (0,56")
F4	396mm (15,62")	234mm (9,25")	50mm (1,98")	146mm (5,75")	109mm (4,31")	15mm (0,62")	190mm (7,50")	6mm (1/4")	13mm (0,53")	54mm (2,16")	14mm (0,56")
F6	498mm (19,62")	234mm (9,25")	50mm (1,98")	146mm (5,75")	109mm (4,31")	15mm (0,62")	190mm (7,50")	6mm (1/4")	13mm (0,53")	54mm (2,16")	14mm (0,56")
F8	599mm (23,62")	234mm (9,25")	50mm (1,98")	146mm (5,75")	109mm (4,31")	15mm (0,62")	190mm (7,50")	6mm (1/4")	13mm (0,53")	54mm (2,16")	14mm (0,56")
F12	803mm (31,62")	234mm (9,25")	50mm (1,98")	146mm (5,75")	109mm (4,31")	15mm (0,62")	190mm (7,50")	6mm (1/4")	13mm (0,53")	54mm (2,16")	14mm (0,56")
H4	396mm (15,62")	285mm (11,25")	50mm (1,98")	146mm (5,75")	109mm (4,31")	15mm (0,62")	241mm (9,50")	6mm (1/4")	13mm (0,53")	54mm (2,16")	14mm (0,56")
H8	599mm (23,62")	285mm (11,25")	50mm (1,98")	146mm (5,75")	109mm (4,31")	15mm (0,62")	241mm (9,50")	6mm (1/4")	13mm (0,53")	54mm (2,16")	14mm (0,56")
H12	803mm (31,62")	285mm (11,25")	50mm (1,98")	146mm (5,75")	109mm (4,31")	15mm (0,62")	241mm (9,50")	6mm (1/4")	13mm (0,53")	54mm (2,16")	14mm (0,56")
J4	396mm (15,62")	336mm (13,25")	50mm (1,98")	146mm (5,75")	109mm (4,31")	15mm (0,62")	292mm (11,50")	6mm (1/4")	13mm (0,53")	54mm (2,16")	14mm (0,56")
J12	803mm (31,62")	336mm (13,25")	50mm (1,98")	146mm (5,75")	109mm (4,31")	15mm (0,62")	292mm (11,50")	6mm (1/4")	13mm (0,53")	54mm (2,16")	14mm (0,56")
FX6	593mm (23,38")	254mm (10,00")	62mm (2,48")	187mm (7,38")	136mm (5,38")	15mm (0,62")	203mm (8,00")	12mm (1/2")	16mm (0,66")	97mm (3,84")	22mm (0,88")
FX12	898mm (35,38")	254mm (10,00")	62mm (2,48")	187mm (7,38")	136mm (5,38")	15mm (0,62")	203mm (8,00")	12mm (1/2")	16mm (0,66")	97mm (3,84")	22mm (0,88")
L6	593mm (23,38")	419mm (16,50")	62mm (2,48")	187mm (7,38")	136mm (5,38")	25mm (1,00")	355mm (14,00")	12mm (1/2")	16mm (0,66")	97mm (3,84")	38mm (1,53")
L12	898mm (35,38")	419mm (16,50")	62mm (2,48")	187mm (7,38")	136mm (5,38")	25mm (1,00")	355mm (14,00")	12mm (1/2")	16mm (0,66")	97mm (3,84")	38mm (1,53")
P6	594mm (23,39")	520mm (20,48")	62mm (2,48")	187mm (7,38")	136mm (5,38")	25mm (1,00")	457mm (18,00")	12mm (1/2")	16mm (0,66")	97mm (3,84")	38mm (1,53")
LX12	898mm (35,39")	457mm (18,00")	75mm (2,98")	200mm (7,88")	152mm (6,00")	25mm (1,00")	355mm (14,00")	12mm (1/2")	16mm (0,66")	91mm (3,59")	56mm (2,24")

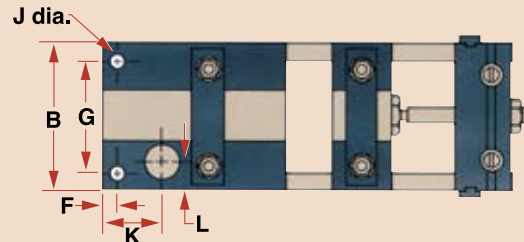
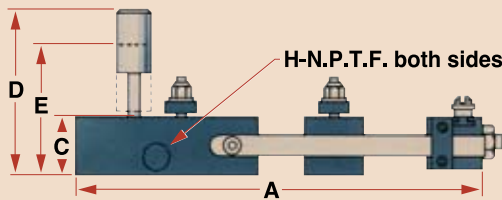

NOTE: CAD files available on request.

Air Consumption and Speed by Model Series

FEED AIR CONSUMPTION

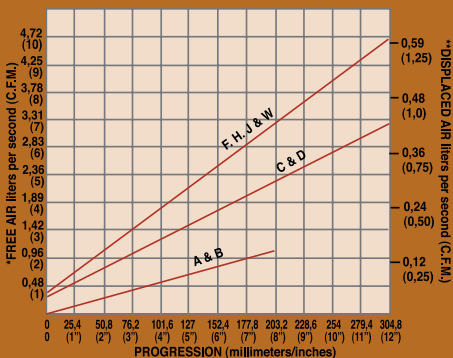

FEED AIR CONSUMPTION

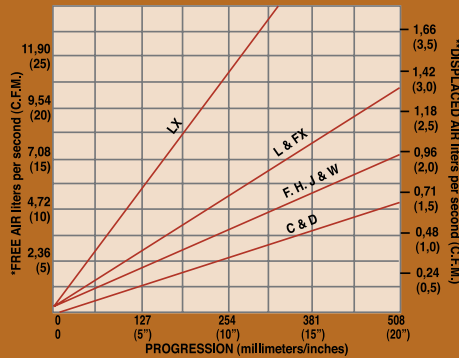

SPEED VS. PROGRESSION

The following graph indicates recommended maximum speeds anticipated for various progressions within each feed series (using an average stock thickness for each series). Feeding heavier stock would lower the maximum speed limit accordingly.

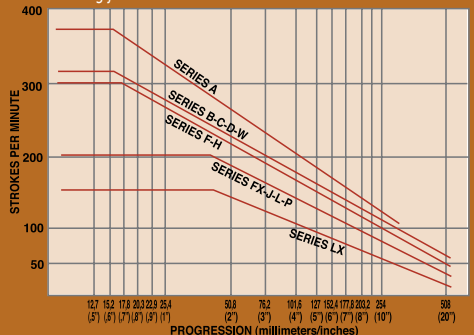

* FREE AIR at 6.9 bar (100 psi) – 100 cycles/min.
** FEED DISPLACEMENT liters per second (C.F.M.) – 100 cycles at operating pressure

* FREE AIR at 6.9 bar (100 psi) – 100 cycles/min.
** FEED DISPLACEMENT liters per second (C.F.M.) – 100 cycles at operating pressure

Servo Feeds

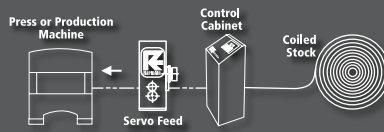

Model Selection

How to select the Rapid-Air Servo Feed model that is right for you.

Primary considerations in selecting a servo feed should be material thickness, width and press speed. Once the model series has been selected, review the description in the Model Selection Guide below for features associated with that model. If questions remain, call a Rapid-Air sales engineer for guidance.



Model Selection

Model	Max Material Width	Max Thickness Capacity at Full Width	Max Feed Roll Opening	Standard Roll Type
Smart MiniServo				Hardened & Ground Standard
SMS2	51mm (2")	1,02mm (0,040")	1,52mm (0,060")	
SMS4	102mm (4")	1,02mm (0,040")	1,52mm (0,060")	
SMS8	203mm (8")	0,79mm (0,031")	1,52mm (0,060")	
Standard 100T Series				
106T	152mm (6")	2,66mm (0,105")	3,81mm (0,150")	
112T	305mm (12")	2,03mm (0,080")	3,81mm (0,150")	
118T	457mm (18")	1,65mm (0,065")	3,81mm (0,150")	
Heavy Duty 100TX Series				
106TX	152mm (6")	3,55mm (0,140")	3,81mm (0,150")	
112TX	305mm (12")	3,18mm (0,125")	3,81mm (0,150")	
118TX	457mm (18")	2,92mm (0,115")	3,81mm (0,150")	
Standard 200T Series				
208T	203mm (8")	2,66mm (0,105")	4,57mm (0,180")	
212T	305mm (12")	2,41mm (0,095")	4,57mm (0,180")	
218T	457mm (18")	2,15mm (0,085")	4,57mm (0,180")	
224T	610mm (24")	1,91mm (0,075")	4,57mm (0,180")	
Heavy Duty 200TX Series				
208TX	203mm (8")	3,18mm (0,125")	4,57mm (0,180")	
212TX	305mm (12")	3,18mm (0,125")	4,57mm (0,180")	
218TX	457mm (18")	2,54mm (0,100")	4,57mm (0,180")	
224TX	610mm (24")	2,54mm (0,100")	4,57mm (0,180")	

A.C. power appropriate for country of use standard.

Performance Data

The relationship between strokes per minute and feed length for each model.

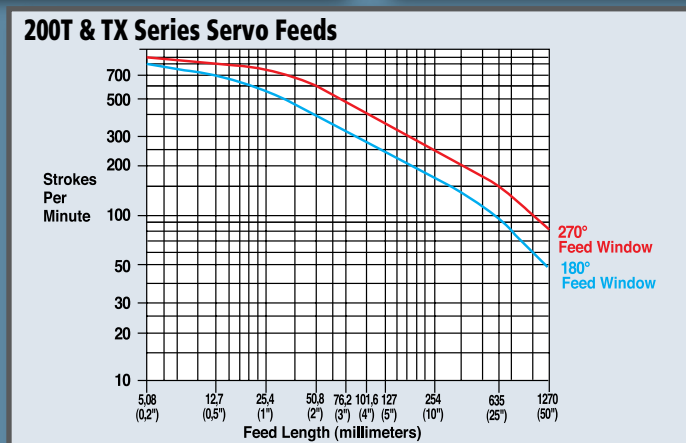
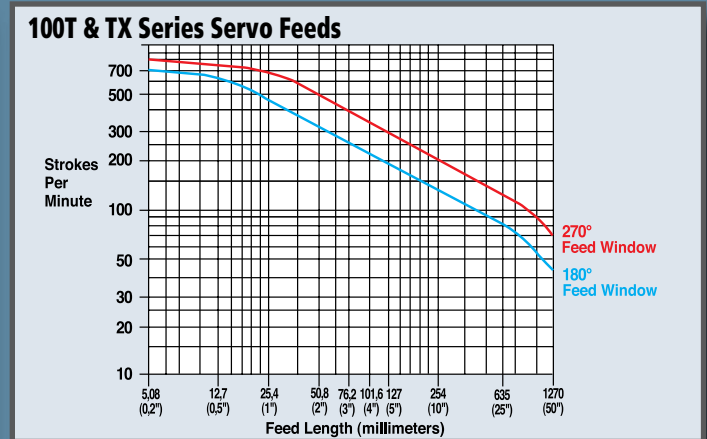
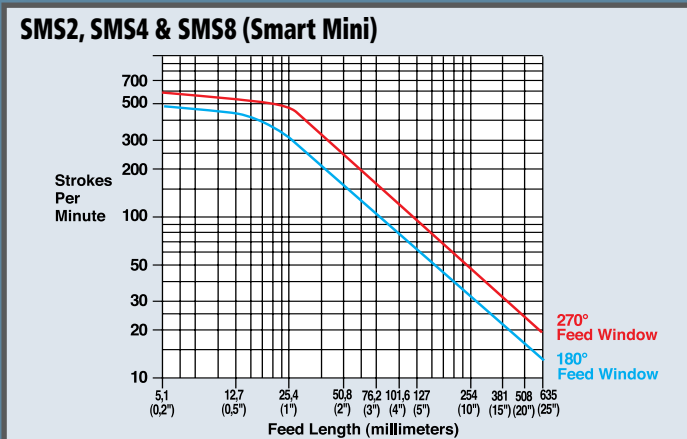

Speed charts are only intended to be a guide for potential production rates. Charts represent max. S.P.M. with mechanical pilot release or no pilot release. Using air pilot release limits speed to 300 S.P.M. with adequate air supply.

Servo Feeds

Dimensions

Envelope drawings.

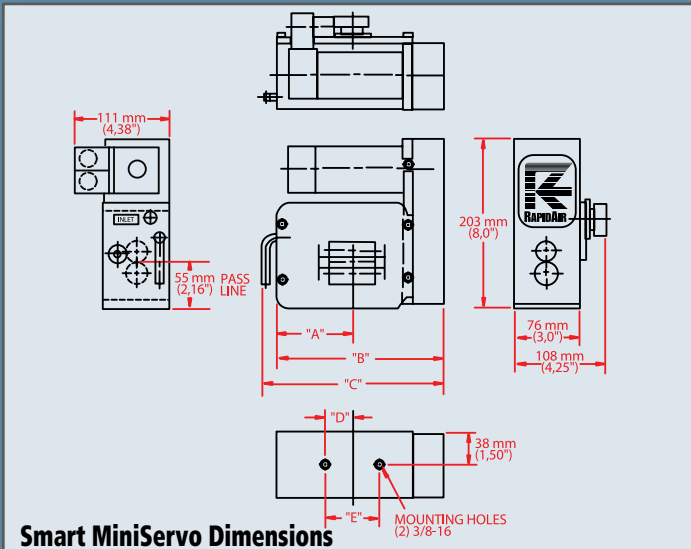

Model	"A"	"B"	"C"	"D"	"E"
SMS2	89mm (3,50")	198mm (7,80")	216mm (8,50")	38mm (1,50")	76mm (3,00")
SMS4	114mm (4,50")	249mm (9,80")	267mm (10,50")	38mm (1,50")	76mm (3,00")
SMS8	165mm (6,50")	351mm (13,80")	368mm (14,50")	38mm (1,50")	76mm (3,00")

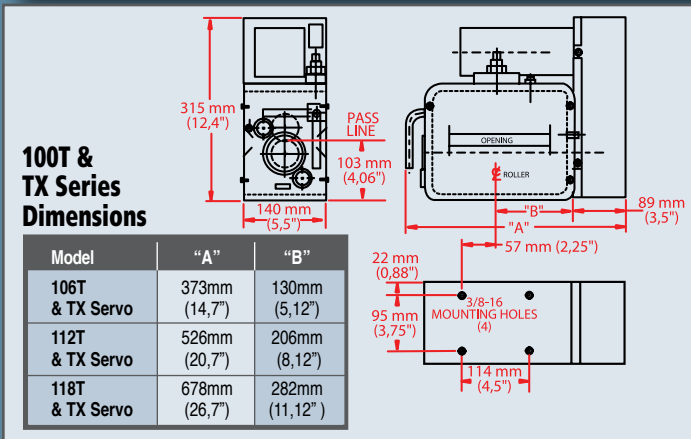

Model	"A"	"B"
106T & TX Servo	373mm (14,7")	130mm (5,12")
112T & TX Servo	526mm (20,7")	206mm (8,12")
118T & TX Servo	678mm (26,7")	282mm (11,12")

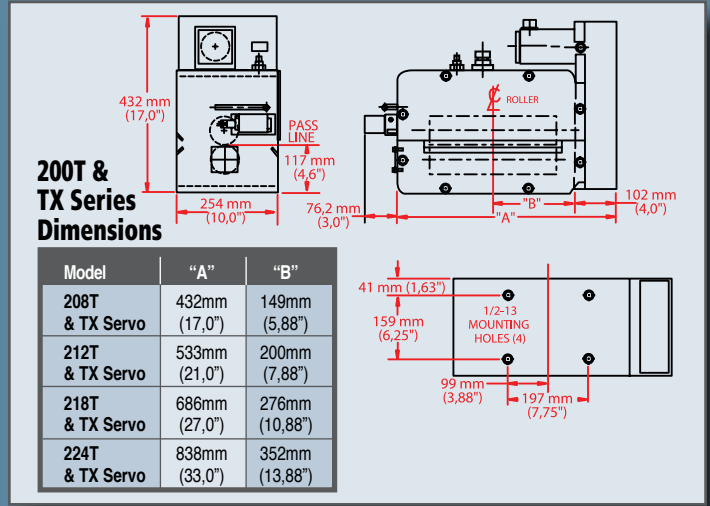

Model	"A"	"B"
208T & TX Servo	432mm (17,0")	149mm (5,88")
212T & TX Servo	533mm (21,0")	200mm (7,88")
218T & TX Servo	686mm (27,0")	276mm (10,88")
224T & TX Servo	838mm (33,0")	352mm (13,88")

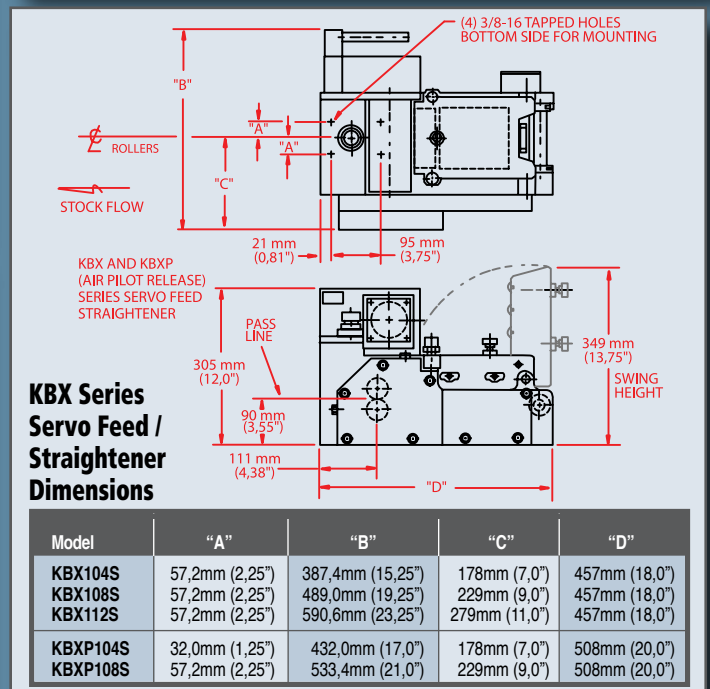

Model	"A"	"B"	"C"	"D"
KBX104S	57,2mm (2,25")	387,4mm (15,25")	178mm (7,0")	457mm (18,0")
KBX108S	57,2mm (2,25")	489,0mm (19,25")	229mm (9,0")	457mm (18,0")
KBX112S	57,2mm (2,25")	590,6mm (23,25")	279mm (11,0")	457mm (18,0")
KBXP104S	32,0mm (1,25")	432,0mm (17,0")	178mm (7,0")	508mm (20,0")
KBXP108S	57,2mm (2,25")	533,4mm (21,0")	229mm (9,0")	508mm (20,0")

Control Cabinet

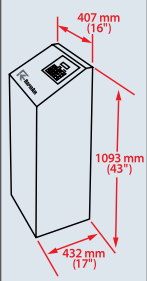

Servo Feed/Straightener Combos

Save floor space and economize.

Model KBX104S



Model Selection

Model	Max Material Width	Max Thickness Capacity at Full Width	Max Feed Roll Opening
Heavy Duty KBX100S Series KBX104S KBX108S KBX112S	102mm (4")	2,03mm (0,080")	3,81mm (0,150")
	203mm (8")	1,78mm (0,070")	3,81mm (0,150")
	305mm (12")	1,52mm (0,060")	3,81mm (0,150")
Piloted Heavy Duty KBXP100S Series KBXP104S KBXP108S	102mm (4")	2,03mm (0,080")	3,81mm (0,150")
	203mm (8")	1,78mm (0,070")	3,81mm (0,150")

A.C. power appropriate for country of use standard.

Straighteners

Model Selection and Dimensions

Model Selection

Model	Max Material Width	Effective Straightening Range	Max Speed per min
SA3	76mm (3")	0,051-0,76mm (0,002" - 0,030")	1778cm (700")
SA3M	76mm (3")	0,051-0,76mm (0,002" - 0,030")	3556cm (1400")
SB4	102mm (4")	0,076-1,27mm (0,003" - 0,050")	1778cm (700")
SB4M	102mm (4")	0,076-1,27mm (0,003" - 0,050")	3556cm (1400")
SBX4	102mm (4")	0,10-2,03mm (0,004" - 0,080")	2100cm (825")
SBX8	203mm (8")	0,10-1,78mm (0,004" - 0,070")	2100cm (825")
SBX12	305mm (12")	0,10-1,52mm (0,004" - 0,060")	2100cm (825")
SBX4M	102mm (4")	0,10-2,03mm (0,004" - 0,080")	4200cm (1650")
SBX8M	203mm (8")	0,10-1,78mm (0,004" - 0,070")	4200cm (1650")
SBX12M	305mm (12")	0,10-1,52mm (0,004" - 0,060")	4200cm (1650")
SCX6	152mm (6")	0,15-2,54mm (0,006" - 0,100")	2100cm (825")
SCX12	305mm (12")	0,15-2,29mm (0,006" - 0,090")	2100cm (825")
SCX18	457mm (18")	0,15-2,03mm (0,006" - 0,080")	2100cm (825")
SCX24	610mm (24")	0,15-1,65mm (0,006" - 0,065")	2100cm (825")
SCX6M	152mm (6")	0,15-2,54mm (0,006" - 0,100")	4200cm (1650")
SCX12M	305mm (12")	0,15-2,29mm (0,006" - 0,090")	4200cm (1650")
SCX18M	457mm (18")	0,15-2,03mm (0,006" - 0,080")	4200cm (1650")
SCX24M	610mm (24")	0,15-1,65mm (0,006" - 0,065")	4200cm (1650")
SCX6H	152mm (6")	0,15-2,03mm (0,006" - 0,080")	10400cm (4100")
SCX12H	305mm (12")	0,15-1,78mm (0,006" - 0,070")	10400cm (4100")
SCX18H	457mm (18")	0,15-1,52mm (0,006" - 0,060")	10400cm (4100")
SCX24H	610mm (24")	0,15-1,40mm (0,006" - 0,055")	10400cm (4100")
SD6	152mm (6")	0,15-3,18mm (0,006" - 0,125")	2100cm (825")
SD12	305mm (12")	0,15-3,18mm (0,006" - 0,125")	2100cm (825")
SD18	457mm (18")	0,15-2,54mm (0,006" - 0,100")	2100cm (825")
SD24	610mm (24")	0,15-2,29mm (0,006" - 0,090")	2100cm (825")

Straightening range based on low carbon steel, commercial grade.
A.C. power appropriate for country of use standard.

High-torque, quick response drive in a compact package.

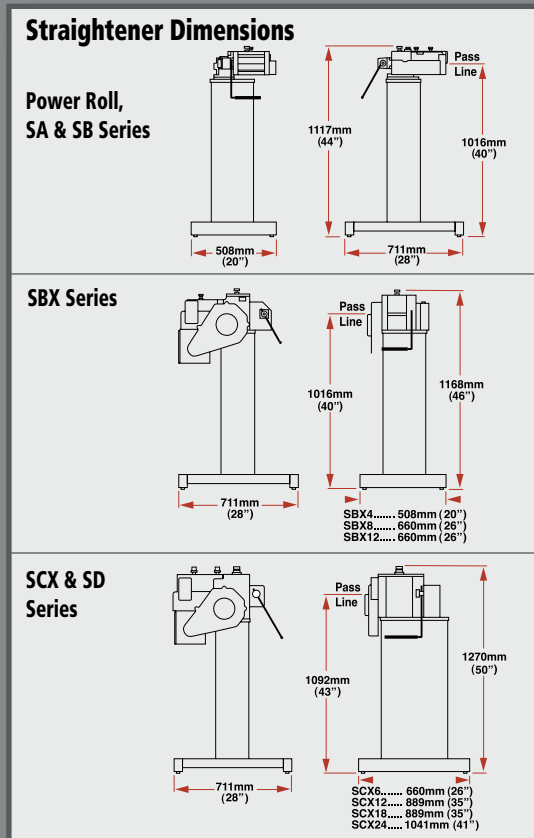

Equipment To Expand Your Straightening Capabilities

Standard material flow direction. (Facing straightener control)
SA and SB straighteners flow left to right. SBX, SCX and SD straighteners flow right to left. All models are available with opposite flow direction. Please specify when ordering. Factory convertible.

Entrance/exit cascade rolls.
Fully adjustable entrance and/or exit cascade rolls are available for all models.

Optional heavy-duty dancer arm.
Dancer arm with adjustable counterweight available for SCX and SD models.

Optional loop controls.
All straightener models are equipped with an external plug connector which allows simple connection of the Rapid-Air loop control systems.



Rapid-Roll Power Rolls

An ideal pulling source.

If you don't need straightening capabilities, but do require a pulling source to maintain a free loop for consistent feeding, Rapid-Roll is the answer. Many different models are available to meet flat or wire stock requirements.

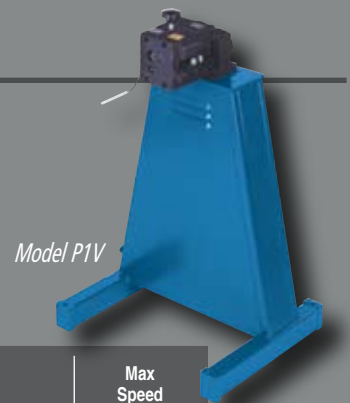

Model Selection

Model	Max Material Width	Recommended Operating Range	Speed	Max Speed per min
P1V	38mm (1-1/2")	0,0127-1,91mm (0,0005" - 0,075")	Standard	1778cm (700")
P1M	38mm (1-1/2")	0,0127-1,91mm (0,0005" - 0,075")	Medium	3556cm (1400")
P4V	102mm (4")	0,0127-1,52mm (0,0005" - 0,060")	Standard	1778cm (700")
P4M	102mm (4")	0,0127-1,52mm (0,0005" - 0,060")	Medium	3556cm (1400")
P1W	wire	0,127-3,81mm (0,005" - 0,150")	Standard	1778cm (700")
P1WM	wire	0,127-3,81mm (0,005" - 0,150")	Medium	3556cm (1400")

A.C. power appropriate for country of use standard.

Stock Reels

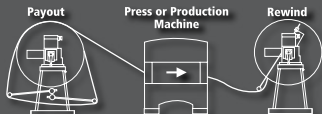

100 Series Stock Reels

The most complete selection available from any source.
Powered and non-powered. Adjustable and fixed centers.
 Max. capacities 22-227kg (50-500 lbs.).

We build our stock reels for lasting durability featuring heavy duty shafts with full bearing support to handle heavy coil loads day in and day out, rugged coil centering arms, and sturdy all steel cabinets and support bases. The options and accessories for each of our models enables you to configure a reel practically any way you want for dependable payoff of coil stock.

Powered reels.

Electric drive-powered reels are made for ease of operation with innovative standard features such as our proportional control system. This top-of-the-line patented system features variable speed capability, electronic loop height adjustment and loop sensing arm range control. A.C. power appropriate for country of use standard.

*Non-powered.

Non-powered reels are available in all sizes, 22kg (50 lbs.) capacity to 227kg (500 lbs.) capacity. All have adjustable mechanical drag brakes. Add NF for non-powered fixed center or NA for non-powered adjustable center.



Model R24A
Powered Reel



Model R24NF
Non-Powered Reel

Model Selection

Powered Model*	Max Coil Weight	Max Coil OD	Max Material Width	Center Diameter	Powered Max Speed
Adjustable Center					
R23A	34kg (75 lbs)	457mm (18")	102mm (4")	76-254mm (3" - 10")	80rpm
R24A	34kg (75 lbs)	610mm (24")	102mm (4")	76-305mm (3" - 12")	80rpm
R25A	34kg (75 lbs)	762mm (30")	102mm (4")	76-305mm (3" - 12")	80rpm
R34A	68kg (150 lbs)	610mm (24")	102mm (4")	127-406mm (5" - 16")	50rpm
R35A	68kg (150 lbs)	762mm (30")	102mm (4")	127-406mm (5" - 16")	50rpm
R36A	68kg (150 lbs)	915mm (36")	102mm (4")	127-406mm (5" - 16")	50rpm
R45A	114kg (250 lbs)	762mm (30")	152mm (6")	229-508mm (9" - 20")	50rpm
R46A	114kg (250 lbs)	915mm (36")	152mm (6")	229-508mm (9" - 20")	50rpm
R56A	227kg (500 lbs)	915mm (36")	152mm (6")	229-508mm (9" - 20")	33rpm
R58A	227kg (500 lbs)	1220mm (48")	152mm (6")	229-508mm (9" - 20")	33rpm

100 Series Single Hydraulic Stock Reels

Hydraulic Model Selection

Powered Model	Max Coil Weight	Max Coil OD	Max Material Width	Center Diameter	Powered Max Speed
Hydraulic Reel Adjustable Center					
RH34A	68kg (150 lbs)	610mm (24")	102mm (4")	127-406mm (5" - 16")	80rpm
RH35A	68kg (150 lbs)	762mm (30")	102mm (4")	127-406mm (5" - 16")	80rpm
RH36A	68kg (150 lbs)	915mm (36")	102mm (4")	127-406mm (5" - 16")	80rpm
RH45A	114kg (250 lbs)	762mm (30")	152mm (6")	229-508mm (9" - 20")	80rpm
RH46A	114kg (250 lbs)	915mm (36")	152mm (6")	229-508mm (9" - 20")	80rpm
RH56A	182kg (400 lbs)	915mm (36")	152mm (6")	229-508mm (9" - 20")	70rpm
RH58A	182kg (400 lbs)	1220mm (48")	152mm (6")	229-508mm (9" - 20")	70rpm

The smooth running capability of our hydraulic reel means superior performance when handling delicate materials. The light tensioning capability offers an outstanding alternative for difficult rewind applications.



Model RH34F

100 Series Powered, Non-Powered and Hydraulic Dimensions

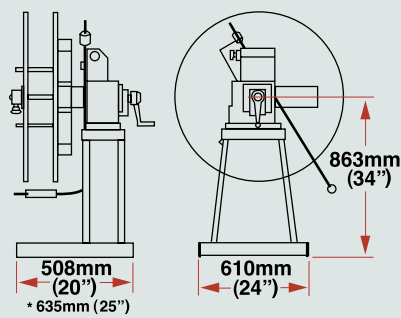

*R50 Series

Loop Controls

LLS Series Double Lo-Loop Space-Saver, payout or rewind (patented).

An entirely new way of looking at the placement of equipment in a stamping plant. With many types and sizes of material it is now possible to place a reel of material



100 Series

very close to a feed mounted on a press and still maintain a substantial amount of material in reserve for interference free feeding of material. It is also now possible to feed directly from a non-powered reel without a concern for slippage caused by the high jerk created by the speed of feeding from a high inertial load of material on the reel. The Rapid-Air Lo-Loop keeps the reel moving at the proper speed of rotation needed for smooth operation.



Cutters and Cut-To-Length

Pivoting Arm Cutters and Reciprocating Blade

For a variety of applications. Accurate, automated for precise, high-speed high volume repetitive jobs.

Rapid-Air offers a full range of pneumatic stock cutters that provide outstanding application flexibility and efficiency in handling your routine or specialty shearing and cut-to-length jobs. Choose from a small pivoting arm model for light gauge material up to a cutter that exerts 3636kg (8000 lbs) of force for 610mm (24") wide flat stock. It can be a stand-alone press or base-mounted unit, or part of a fully synchronized cut-to-length system.



Model Selection

Cut range based on low carbon steel, commercial grade.

	Cutter Only Model	CTL Cutter Model	Max. Stock Width	Max. Thickness Capacity at Full Width	Cutter Blade Opening	Max. Force @ 100 psi (6.9 bar)
Pivoting Arm Flat Stock Cutters	SCR125	SCR125S	32mm (1-1/4")	1,02mm (0,040")	3,43mm (0,135")	636kg (1400 lbs)
	SCL125	SCL125S	32mm (1-1/4")	1,02mm (0,040")	3,43mm (0,135")	636kg (1400 lbs)
Pivoting Arm Round Stock Cutters	RSC14	RSC14S	4,32mm dia (0,170" dia)	4,32mm dia (0,170" dia)	5,08mm (0,200")	636kg (1400 lbs)
	RSC25	RSC25S	6,35mm dia (0,250" dia)	6,35mm dia (0,250" dia)	7,92mm (0,312")	1136kg (2500 lbs)
Reciprocating Flat Stock Cutters	FSC4	FSC4S	102mm (4")	1,02mm (0,040")	3,81mm (0,150")	545kg (1200 lbs)
	FSC6	FSC6S	152mm (6")	1,17mm (0,046")	4,57mm (0,180")	909kg (2000 lbs)
	FSC8	FSC8S	203mm (8")	1,40mm (0,055")	2,29mm (0,090")	1100kg (2400 lbs)
	FSC12	FSC12S	302mm (12")	1,73mm (0,068")	2,54mm (0,100")	1818kg (4000 lbs)
	FSC18	FSC18S	457mm (18")	2,03mm (0,080")	4,57mm (0,180")	1365/2727kg (3000/6000 lbs)
	FSC24	FSC24S	610mm (24")	2,29mm (0,090")	2,29mm (0,090")	1818/3636kg (4000/8000 lbs)

Flat stock pivoting arm cutters

Models
SCR 125 & SCL125
Flat stock up to
32mm (1-1/4") wide

- Pivot arm adjusts laterally for cutting blade clearance.



- Eight cutting edges per blade can be used before resharpening.



- Stock guides included on flat stock models.
- Custom guides available.

C-T-L Machines

Accurate, automated stock cutting for precise, high-speed high volume repetitive jobs.

A Rapid-Air cut-to-length machine with servo feed, or servo feed straightener (KBX100), is a real production booster for both long or short length stamping operations. These integrated units may provide a maximum feed stroke of up to 2537cm (999") or more, and handle maximum stock widths up to 610mm (24").

A Rapid-Air cut-to-length machine combines an air operated stock cutter and a Rapid-Air feed or a programmable Rapid-Roll feed with a control system. All of this is mounted in one convenient, easy-to-use, low cost package for use on simple cut-off operations.

Consult our application engineers regarding special control programs and feed-cutter combinations available to meet your specific needs.



Model
CTL FSC24S +
MB30 + 224T



Model
CTL SCL125S +
CB16A + A2S

Model Selection with Air Feed

Cut-To-Length Model	Cutter Width	Max Stock Width	Max Cutter Thickness
FSC4SEB+CB16C+C3S	102mm (4")	76mm (3")	1,02mm (0,040")
FSC4SEB+CB16C+C6S	102mm (4")	76mm (3")	1,02mm (0,040")
FSC4SEB+CB16C+D3S	102mm (4")	102mm (4")	1,02mm (0,040")
FSC4SEB+CB16C+D6S	102mm (4")	102mm (4")	1,02mm (0,040")
FSC6EB+CB16C+F4S	152mm (6")	152mm (6")	1,17mm (0,046")
FSC6EB+CB16C+F6S	152mm (6")	152mm (6")	1,17mm (0,046")
FSC6EB+CB16C+F8S	152mm (6")	152mm (6")	1,17mm (0,046")
FSC8EB+CB16C+H4S	203mm (8")	203mm (8")	1,40mm (0,055")
FSC8EB+CB16C+H8S	203mm (8")	203mm (8")	1,40mm (0,055")
FSC12SEB+MB24C+L6S	305mm (12")	305mm (12")	1,73mm (0,068")
FSC12SEB+MB24C+L12S	305mm (12")	305mm (12")	1,73mm (0,068")
FSC12SEB+MB24C+L16S	305mm (12")	305mm (12")	1,73mm (0,068")
SCL125S+CB16A+A2S	32mm (1-1/4")	32mm (1-1/4")	1,02mm (0,040")
SCL125S+CB16A+A4S	32mm (1-1/4")	32mm (1-1/4")	1,02mm (0,040")
SCL125S+CB16A+A6S	32mm (1-1/4")	32mm (1-1/4")	1,02mm (0,040")
SCL125S+CB16A+A8S	32mm (1-1/4")	32mm (1-1/4")	1,02mm (0,040")
* RSC14S+CB16A+A2S	4,32mm dia (0,170" dia)	4,32mm dia (0,170" dia)	4,32mm dia (0,170" dia)
* RSC14S+CB16A+A4S	4,32mm dia (0,170" dia)	4,32mm dia (0,170" dia)	4,32mm dia (0,170" dia)
* RSC25S+CB16A+W6S	6,35mm dia (0,250" dia)	6,35mm dia (0,250" dia)	6,35mm dia (0,250" dia)
* RSC25S+CB16A+W12S	6,35mm dia (0,250" dia)	6,35mm dia (0,250" dia)	6,35mm dia (0,250" dia)

* Consult factory with actual specifications prior to ordering.

Reciprocating blade cutters

- Solid structural parts hold long-term alignment and cutting accuracy.
- Precision machined operating components are all housed inside the cutter.
- No external cylinders, valves or hoses.

- Adjustable stock guide rollers.
- Safety guard - stock must pass underneath the guard before reaching recessed cutting area.

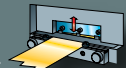

- Quick, simple blade adjustment.
- Upper blade lowers on a cam assembly.
- Thumbscrews position lower blade front-to-back.

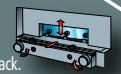

- Easy blade removal.
- Four blade edges can be used before resharpening.
- Tool steel blades are standard.
- Carbide insert, titanium nitride coated and other type blades available.

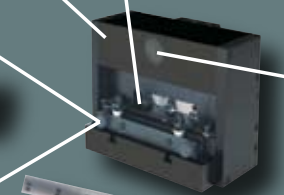

- Internal pneumatic piston system includes integrated quick exhaust and muffler.
- 457mm (18") and 610mm (24") cutters include selectable tonnage control.

Models FSC4, 6, 8, 12, 18, 24
Flat stock up to 610mm (24") wide

Model Selection with Servo Feed

CTL Model	Cutter Width	Max Stock Width	Max Cutter Thickness
FSC4S+CB16+SMS4	102mm (4")	102mm (4")	1,02mm (0,040")
FSC4S+CB16+106T	102mm (4")	102mm (4")	1,02mm (0,040")
FSC4S+CB16+KBX104S	102mm (4")	102mm (4")	1,02mm (0,040")
FSC6S+CB16+106T	152mm (6")	152mm (6")	1,17mm (0,046")
FSC6S+CB16+208T	152mm (6")	152mm (6")	1,17mm (0,046")
FSC6S+CB16+KBX104S	152mm (6")	102mm (4")	1,17mm (0,046")
FSC6S+CB16+KBX108S	152mm (6")	152mm (6")	1,17mm (0,046")
FSC8S+CB16+SMS8	203mm (8")	203mm (8")	1,40mm (0,055")
FSC8S+CB16+208T	203mm (8")	203mm (8")	1,40mm (0,055")
FSC8S+CB16+KBX108S	203mm (8")	203mm (8")	1,40mm (0,055")
FSC12S+MB24+112T	305mm (12")	305mm (12")	1,73mm (0,068")
FSC12S+MB24+212T	305mm (12")	305mm (12")	1,73mm (0,068")
FSC12S+MB24+KBX112S	305mm (12")	305mm (12")	1,73mm (0,068")
FSC18S+MB30+118T	457mm (18")	457mm (18")	2,03mm (0,080")
FSC18S+MB30+218T	457mm (18")	457mm (18")	2,03mm (0,080")
FSC24S+MB330+224T	610mm (24")	610mm (24")	2,29mm (0,090")
SCL125S+CB16+SMS2	32mm (1,25")	32mm (1,25")	1,02mm (0,040")
* RSC14S+CB16+SMS2	4,32mm dia (0,170" dia)	32mm (1,25") grooved rolls	4,32mm dia (0,170" dia)
SCL125S+CB16+106T	32mm (1,25")	32mm (1,25")	1,02mm (0,040")
* RSC14S+CB16+106T	4,32mm dia (0,170" dia)	32mm (1,25") grooved rolls	4,32mm dia (0,170" dia)
* RSC25S+CB16+106T	6,35mm dia (0,250" dia)	32mm (1,25") grooved rolls	6,35mm dia (0,250" dia)

* Consult factory with actual specifications prior to ordering.
A.C. power appropriate for country of use standard.

AUTHORIZED RAPID-AIR DISTRIBUTOR:



4601 KISHWAUKEE ST. • ROCKFORD, IL 61109-2925
PHONE: (815) 397-2578 • FAX: (15) 398-3887 • WWW.RAPIDAIR.COM