

flexiform



FREESTOR
SPECIFICATION GUIDE



freestor

Our most popular range, Freestor is available as side filers, tambours, acoustic tambours, hinged door, lockers and combination units to tailor storage across the office while keeping continuity.



freestor hinged door storage



Pictured Right: Freestor hinged door storage.
1000mm (w) x 475mm (d) x 1677mm (h).
Finish: pale grey steel.FSL167710PGS07PGS.

HOW TO SPECIFY HINGED DOOR STORAGE

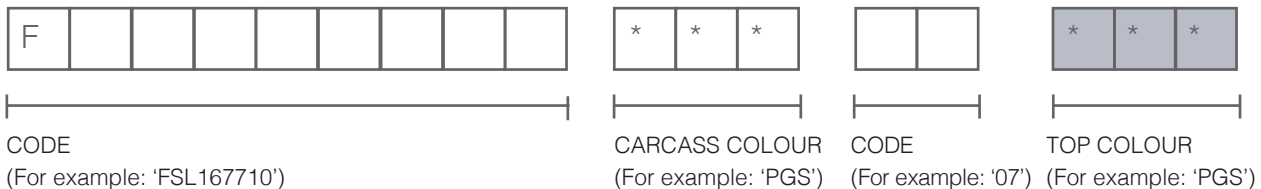

For example, to specify an all pale grey 1000mm (w) x 475mm (d) x 1677mm (h) hinged door storage (pictured above) the code would be FSL167710PGS07PGS. When ordering a hinged door storage consider our components range.

For storage which meets desk height, select 740mm high storage (includes MFC top as standard).

IMPORTANT NOTE: Hinged Door Storage is all steel with a MFC top as an option. If a steel top is required select the desired steel colour in the *** section labelled 'Top Colour'. If an MFC top is required select a MFC colour. MFC tops incur an additional cost.

Steel Finishes

Silver	JOS	Waterblue	WBS
Graphite	GGG	Sky Blue	SBB
Pale Grey	PGS	Regal Blue	RBS
White	JWS	Signal Blue	SBS
Black	BLS	Ultramarine Blue	UBS
Arrow Red	ARG	Tauben Blue	TGS
Carmin Red	CRS	Pastel Turquoise	PTS
Deep Orange	ORS	Pastel Mauve	PMS
Zinc Yellow	ZYS	Khaki Green	KGS
Fern Green	FGB		

MFC Finishes/ Matching Edge

Light Oak	MOK
White	WHM
Beech	MOB
Maple	MOM
Grey	MOG
Walnut	MOW
Romano Cherry	RCM

MFC Finishes/ Contrasting Edge

White/ Oak Edge	WHO
White/ Multiplex Edge	WHX

freestor storage /hinged door

2007mm High Hinged Door Storage.

Available in 800mm wide or 1000mm wide.

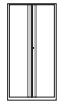
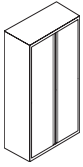

WIDTH



DEPTH



HEIGHT

FSL200708***04***

800mm

475mm

2007mm

FSL200710***04***

1000mm

475mm

2007mm

Accessories.

You may want to order these items.

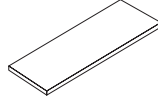

PLAIN SHELF

FSLCPLS0840BLS01

FSLCPLS1040BLS06

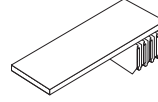

LATERAL PLAIN SHELF

FSLCULP0840BLS01

FSLCULP1040BLS04

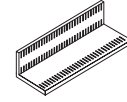

SLOTTED FILING SHELF

FSLCFXS0840BLS01

FSLCFXS1040BLS04

1677mm High Hinged Door Storage.

Available in 800mm wide or 1000mm wide.

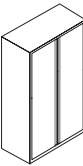

WIDTH



DEPTH



HEIGHT

FSL167708***07***

800mm

475mm

1677mm

FSL167710***07***

1000mm

475mm

1677mm

Accessories.

You may want to order these items.

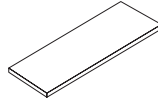

PLAIN SHELF

FSLCPLS0840BLS01

FSLCPLS1040BLS06

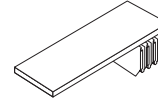

LATERAL PLAIN SHELF

FSLCULP0840BLS01

FSLCULP1040BLS04

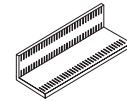

SLOTTED FILING SHELF

FSLCFXS0840BLS01

FSLCFXS1040BLS04

1322mm High Hinged Door Storage.

Available in 800mm wide or 1000mm wide.

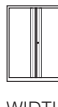
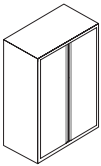

WIDTH



DEPTH



HEIGHT

FSL132208***09***

800mm

475mm

1322mm

FSL132210***09***

1000mm

475mm

1322mm

Accessories.

You may want to order these items.

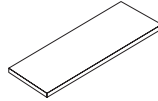

PLAIN SHELF

FSLCPLS0840BLS01

FSLCPLS1040BLS06

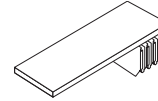

LATERAL PLAIN SHELF

FSLCULP0840BLS01

FSLCULP1040BLS04

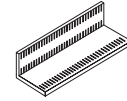

SLOTTED FILING SHELF

FSLCFXS0840BLS01

FSLCFXS1040BLS04

1110mm High Hinged Door Storage with MFC Top.

Available in 800mm wide, 825mm wide or 1000mm wide.

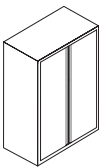

WIDTH



DEPTH



HEIGHT

FSL111008***27***

800mm

475mm

1110mm

FSL11100825***27***

825mm

475mm

1110mm

FSL111010***27***

1000mm

475mm

1110mm

Accessories.

You may want to order these items.

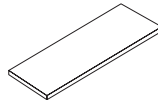

PLAIN SHELF

FSLCPLS0840BLS01

FSLCPLS082540BLS01

FSLCPLS1040BLS06

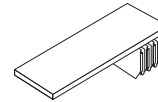

LATERAL PLAIN SHELF

FSLCULP0840BLS01

FSLCULP082540BLS01

FSLCULP1040BLS04

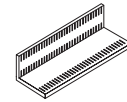

SLOTTED FILING SHELF





FSLCFXS0840BLS01

FSLCFXS082540BLS01

FSLCFXS1040BLS04

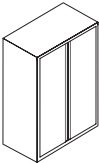
1090mm High Hinged Door Storage with MFC Top.

Available in 800mm wide, 825mm wide or 1000mm wide.

			
	WIDTH	DEPTH	HEIGHT
FSL109008***26***	800mm	475mm	1090mm
FSL10900825***26***	825mm	475mm	1090mm
FSL109010***26***	1000mm	475mm	1090mm



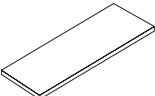
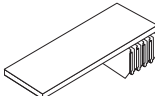
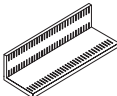

Accessories.

You may want to order these items.

		
PLAIN SHELF	LATERAL PLAIN SHELF	SLOTTED FILING SHELF
FSLCPLS0840BLS01	FSLCULP0840BLS01	FSLCFXS0840BLS01
FSLCPLS082540BLS01	FSLCULP082540BLS01	FSLCFXS082540BLS01
FSLCPLS1040BLS06	FSLCULP1040BLS04	FSLCFXS1040BLS04

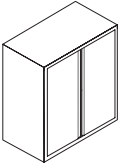
1017mm High Hinged Door Storage.

Available in 800mm wide or 1000mm wide.

			
	WIDTH	DEPTH	HEIGHT
FSL101708***10***	800mm	475mm	1017mm
FSL101710***10***	1000mm	475mm	1017mm



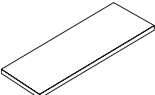
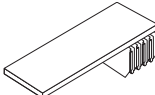
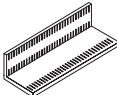

Accessories.

You may want to order these items.

		
PLAIN SHELF	LATERAL PLAIN SHELF	SLOTTED FILING SHELF
FSLCPLS0840BLS01	FSLCULP0840BLS01	FSLCFXS0840BLS01
FSLCPLS1040BLS06	FSLCULP1040BLS04	FSLCFXS1040BLS04

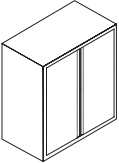
740mm High Hinged Door Storage with MFC Top.

Available in 800mm wide, 825mm or 1000mm wide.

			
	WIDTH	DEPTH	HEIGHT
FSL074008***24***	800mm	475mm	740mm
FSL07400825***24***	825mm	475mm	740mm
FSL074010***24***	1000mm	475mm	740mm



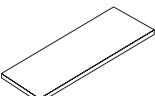
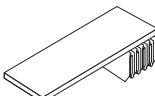
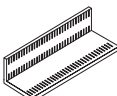

Accessories.

You may want to order these items.

		
PLAIN SHELF	LATERAL PLAIN SHELF	SLOTTED FILING SHELF
FSLCPLS0840BLS01	FSLCULP0840BLS01	FSLCFXS0840BLS01
FSLCPLS082540BLS01	FSLCULP082540BLS01	FSLCFXS082540BLS01
FSLCPLS1040BLS06	FSLCULP1040BLS04	FSLCFXS1040BLS04

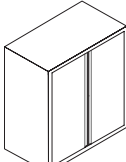
720mm High Hinged Door Storage with MFC Top.

Available in 800mm wide or 1000mm wide.

			
	WIDTH	DEPTH	HEIGHT
FSL072008***25***	800mm	475mm	720mm
FSL07200825***25***	825mm	475mm	720mm
FSL072010***25***	1000mm	475mm	720mm

Accessories.

You may want to order these items.

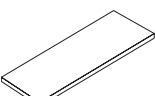
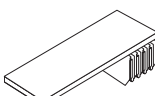
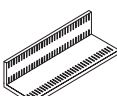
		
PLAIN SHELF	LATERAL PLAIN SHELF	SLOTTED FILING SHELF
FSLCPLS0840BLS01	FSLCULP0840BLS01	FSLCFXS0840BLS01
FSLCPLS082540BLS01	FSLCULP082540BLS01	FSLCFXS082540BLS01
FSLCPLS1040BLS06	FSLCULP1040BLS04	FSLCFXS1040BLS04

freestor side filer storage



Pictured Right: Side filer storage.
1000mm (w) x 475mm (d) x 1017mm (h).
Finish: pale grey steel. FSL101710PGS11PGS.

HOW TO SPECIFY SIDE FILER STORAGE

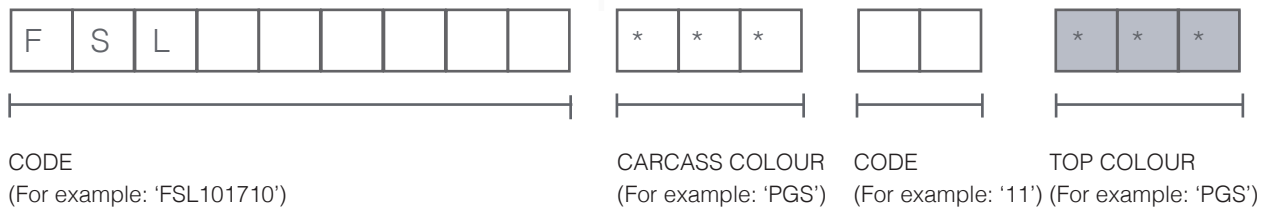

For example, to specify an all pale grey 1000mm (w) x 475mm (d) x 1017mm (h) side filer storage (pictured above) the code would be FSL101710PGS11PGS. When ordering a side filer storage consider components. All internal drawers are black inside. It is compulsory that a counterbalance weight is ordered when more than one pull out drawer is fitted.

IMPORTANT NOTE: Side Filer Storage is all steel with a MFC top as an option. If a steel top is required select the desired steel colour in the *** section labelled 'Top Colour'. If an MFC top is required select a MFC colour. MFC tops incur an additional cost.

Steel Finishes

Silver	JOS	Waterblue	WBS
Graphite	GGG	Sky Blue	SBB
Pale Grey	PGS	Regal Blue	RBS
White	JWS	Signal Blue	SBS
Black	BLS	Ultramarine Blue	UBS
Arrow Red	ARG	Tauben Blue	TGS
Carmin Red	CRS	Pastel Turquoise	PTS
Deep Orange	ORS	Pastel Mauve	PMS
Zinc Yellow	ZYS	Khaki Green	KGS
Fern Green	FGB		

MFC Finishes/ Matching Edge

Light Oak	MOK
White	WHM
Beech	MOB
Maple	MOM
Grey	MOG
Walnut	MOW
Romano Cherry	RCM





MFC Finishes/ Contrasting Edge

White/ oak edge	WHO
White/ Multiplex edge	WHX

freestor storage /side filer

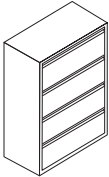
1322mm High Side Filer Storage.

4x 12" (305mm) drawers.

			
	WIDTH	DEPTH	HEIGHT
FSL132208***08***	800mm	475mm	1322mm
FSL132210***08***	1000mm	475mm	1322mm



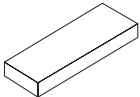
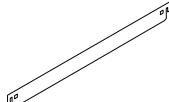
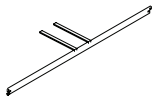

Accessories.

You may want to order these items for drawers.

		
COUNTERBALANCE WEIGHT	FRONT-TO-BACK FILING RAILS	SIDE-TO-SIDE FILING RAILS
FSTORBAL08	FSLATFFS08FB***01	FSLATFFS08SS***01
FSTORBAL10	FSLATFFS10FB***03	FSLATFFS10SS***03

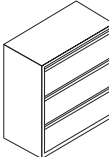
1017mm High Side Filer Storage.

3x 12" (305mm) drawers.

			
	WIDTH	DEPTH	HEIGHT
FSL101708***11***	800mm	475mm	1017mm
FSL101710***11***	1000mm	475mm	1017mm



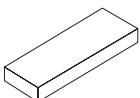
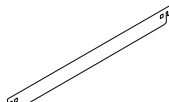
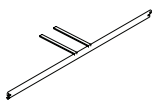

Accessories.

You may want to order these items for drawers.

		
COUNTERBALANCE WEIGHT	FRONT-TO-BACK FILING RAILS	SIDE-TO-SIDE FILING RAILS
FSTORBAL08	FSLATFFS08FB***01	FSLATFFS08SS***01
FSTORBAL10	FSLATFFS10FB***03	FSLATFFS10SS***03

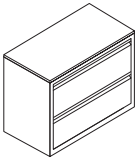
740mm High Side Filer Storage with MFC Top.

2x 12" (305mm) drawers.

			
	WIDTH	DEPTH	HEIGHT
FSL074008***22***	800mm	475mm	740mm
FSL074010***22***	1000mm	475mm	740mm



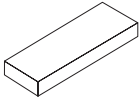
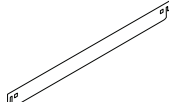
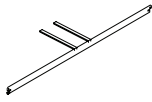

Accessories.

You may want to order these items for drawers.

		
COUNTERBALANCE WEIGHT	FRONT-TO-BACK FILING RAILS	SIDE-TO-SIDE FILING RAILS
FSTORBAL08	FSLATFFS08FB***01	FSLATFFS08SS***01
FSTORBAL10	FSLATFFS10FB***03	FSLATFFS10SS***03

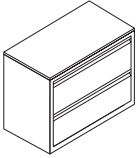
720mm High Side Filer Storage with MFC Top.

2x 12" (305mm) drawers.

			
	WIDTH	DEPTH	HEIGHT
FSL072008***12***	800mm	475mm	720mm
FSL072010***12***	1000mm	475mm	720mm

Accessories.

You may want to order these items for drawers.

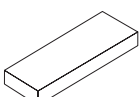
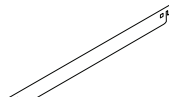
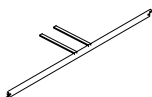
		
COUNTERBALANCE WEIGHT	FRONT-TO-BACK FILING RAILS	SIDE-TO-SIDE FILING RAILS
FSTORBAL08	FSLATFFS08FB***01	FSLATFFS08SS***01
FSTORBAL10	FSLATFFS10FB***03	FSLATFFS10SS***03

freestor combination storage



Pictured Right: Freestor lateral combination unit.
1000mm (w) x 475mm (d) x 2007mm (h).
Finish: pale grey steel. FSL200710PGS01PGS.

HOW TO SPECIFY COMBINATION STORAGE

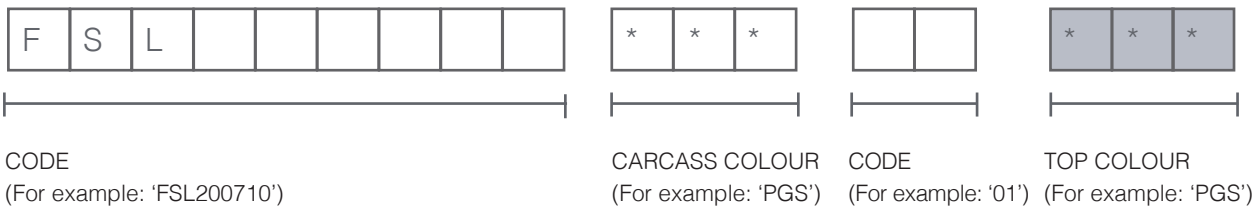

For example, to specify an all pale grey 1000mm (w) x 475mm (d) x 2007mm (h) combination storage unit (pictured above) the code would be FSL200710PGS01PGS. When ordering a combination storage unit consider storage filing rails and shelving. All drawers are finished in black inside. It is compulsory that a counterbalance weight is ordered when more than one pull out drawer is fitted.

IMPORTANT NOTE: Combination Storage is all steel with a MFC top as an option. If a steel top is required select the desired steel colour in the *** section labelled 'Top Colour'. If an MFC top is required select in an MFC colour. MFC tops incur an additional cost.

Steel Finishes			MFC Finishes/ Matching Edge			MFC Finishes/ Contrasting Edge	
Silver	JOS	Waterblue	WBS	Light Oak	MOK	White/ Oak Edge	WHO
Graphite	GGs	Sky Blue	SBB	White	WHM	White/ Multiplex Edge	WHX
Pale Grey	PGS	Regal Blue	RBS	Beech	MOB		
White	JWS	Signal Blue	SBS	Maple	MOM		
Black	BLS	Ultramarine Blue	UBS	Grey	MOG		
Arrow Red	ARG	Tauben Blue	TGS	Walnut	MOW		
Carmine Red	CRS	Pastel Turquoise	PTS	Romano Cherry	RCM		
Deep Orange	ORS	Pastel Mauve	PMS				
Zinc Yellow	ZYS	Khaki Green	KGS				
Fern Green	FGB						

freestor storage /combination storage

2007mm High Combination Storage.

3x 12" (305mm) drawers and 39" (990mm) hinged doors.

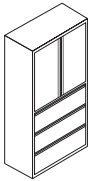

WIDTH



DEPTH



HEIGHT

FSL200708***01***
FSL200710***01***

800mm	475mm	2007mm
1000mm	475mm	2007mm

Accessories.

You may want to order these items.

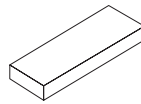

COUNTERBALANCE WEIGHT

FSTORBAL08
FSTORBAL10

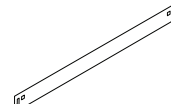

FRONT-TO-BACK FILING RAILS

FSLATFFS08FBBSL01
FSLATFFS10FBBSL03

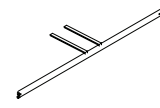

SIDE-TO-SIDE FILING RAILS

FSLATFFS08SSBSL01
FSLATFFS10SSBSL03

2007mm High Combination Storage.

4x 12" (305mm) drawers and 2x 13" (330mm) flippers plus shelf.

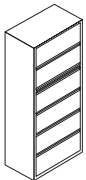

WIDTH



DEPTH



HEIGHT

FSL200708***02***
FSL200710***02***

800mm	475mm	2007mm
1000mm	475mm	2007mm

Accessories.

You may want to order these items.

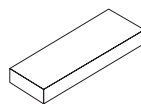

COUNTERBALANCE WEIGHT

FSTORBAL08
FSTORBAL10

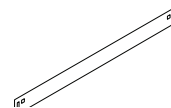

FRONT-TO-BACK FILING RAILS

FSLATFFS08FBBSL01
FSLATFFS10FBBSL03

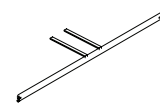

SIDE-TO-SIDE FILING RAILS

FSLATFFS08SSBSL01
FSLATFFS10SSBSL03

2007mm High Combination Storage.

3x 12" (305mm) drawers and 3x 13" (330mm) flippers.

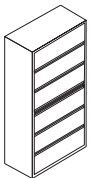

WIDTH



DEPTH



HEIGHT

FSL200708***03***
FSL200710***03***

800mm	475mm	2007mm
1000mm	475mm	2007mm

Accessories.

You may want to order these items.

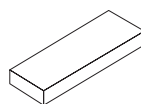

COUNTERBALANCE WEIGHT

FSTORBAL08
FSTORBAL10

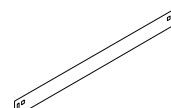

FRONT-TO-BACK FILING RAILS

FSLATFFS08FBBSL01
FSLATFFS10FBBSL03

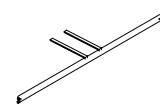

SIDE-TO-SIDE FILING RAILS

FSLATFFS08SSBSL01
FSLATFFS10SSBSL03

1677mm High Combination Storage.

4x 12" (305mm) drawers and 1x 13" (330mm) flipper plus shelf.

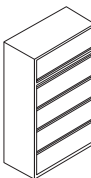

WIDTH



DEPTH



HEIGHT

FSL167708***05***
FSL167710***05***

800mm	475mm	1677mm
1000mm	475mm	1677mm

Accessories.

You may want to order these items.

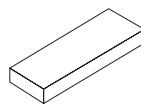

COUNTERBALANCE WEIGHT

FSTORBAL08
FSTORBAL10

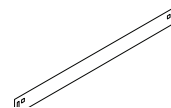

FRONT-TO-BACK FILING RAILS

FSLATFFS08FBBSL01
FSLATFFS10FBBSL03

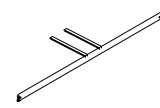

SIDE-TO-SIDE FILING RAILS

FSLATFFS08SSBSL01
FSLATFFS10SSBSL03

1677mm High Combination Storage.

3x 12" (305mm) drawers and 2x 13" (330mm) flippers.

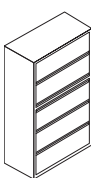

WIDTH



DEPTH



HEIGHT

FSL167708***06***
FSL167710***06***

800mm	475mm	1677mm
1000mm	475mm	1677mm

Accessories.

You may want to order these items.

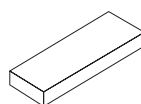

COUNTERBALANCE WEIGHT

FSTORBAL08
FSTORBAL10

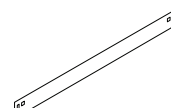

FRONT-TO-BACK FILING RAILS

FSLATFFS08FBBSL01
FSLATFFS10FBBSL03

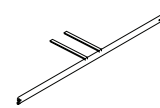

SIDE-TO-SIDE FILING RAILS

FSLATFFS08SSBSL01
FSLATFFS10SSBSL03

freestor tambour storage



Pictured Right: tambour storage.
1000mm (w) x 475mm (d) x 2007mm (h).
Finishes: silver steel with silver shutters.
FS200710JOSPLSLJOS.

HOW TO SPECIFY TAMBOUR STORAGE

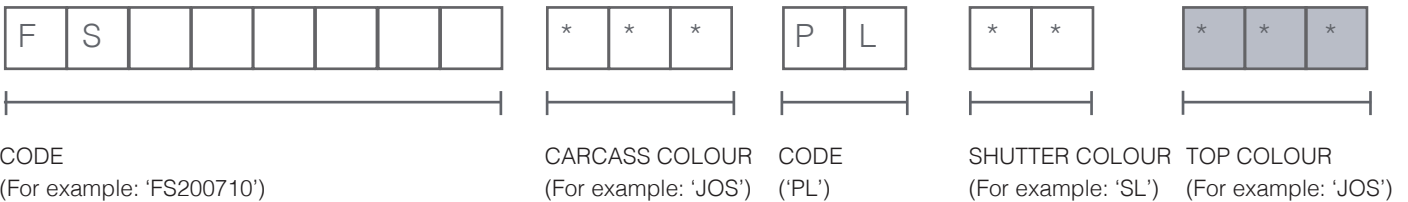

For example, to specify an all silver 1000mm (w) x 475mm (d) x 2007mm (h) tambour storage unit (pictured above) the code would be FS200710JOSPLSLJOS. When ordering a tambour unit please consider various components.

Silver tambours may appear to shade slightly in certain lights, this is due to the manufacturing process and is unavoidable.

IMPORTANT NOTE: Tambour Storage is all steel with a MFC top as an option. If a steel top is required enter the desired steel colour in the *** section labelled 'Top Colour'. If an MFC top is required enter in an MFC colour. MFC tops incur an additional cost.

Steel Finishes

Silver	JOS	Waterblue	WBS
Graphite	GGs	Sky Blue	SBB
Pale Grey	PGS	Regal Blue	RBS
White	JWS	Signal Blue	SBS
Black	BLS	Ultramarine Blue	UBS
Arrow Red	ARG	Tauben Blue	TGS
Carmines Red	CRS	Pastel Turquoise	PTS
Deep Orange	ORS	Pastel Mauve	PMS
Zinc Yellow	ZYS	Khaki Green	KGS
Fern Green	FGB		

MFC Finishes/ Matching Edge

Light Oak	MOK
White	WHM
Beech	MOB
Maple	MOM
Grey	MOG
Walnut	MOW
Romano Cherry	RCM

Tambour Shutter Finishes

Silver (Add 5%)	SL
Light Grey	LG
Dark Grey	DG
White	WH
Black	BK

MFC Finishes/ Contrasting Edge

White/ Oak Edge	WHO
White/ Multiplex Edge	WHX

freestor storage /tambour storage

2007mm High Tambour Storage Unit.

Available in 800mm or 1000mm wide.



WIDTH



DEPTH



HEIGHT

FS200708***PL****	800mm	475mm	2007mm
FS200710***PL****	1000mm	475mm	2007mm

Accessories.

You may want to order these items.

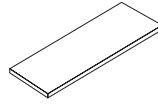

PLAIN SHELF

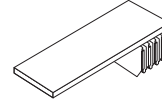

LATERAL PLAIN SHELF
WITH SUSPENSION RAIL

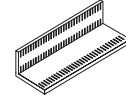

SLOTTED SHELF

FSCPLS0840***01	FSCULP0840BLS01	FSCFXS0840***01
FSCPLS1040***06	FSCULP1040BLS06	FSCFXS1040***04

1720mm High Tambour Storage Unit.

Available in 800mm or 1000mm wide.

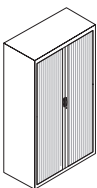

WIDTH



DEPTH



HEIGHT

FS172008***PL****	800mm	475mm	1720mm
FS172010***PL****	1000mm	475mm	1720mm

Accessories.

You may want to order these items.

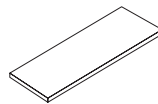

PLAIN SHELF

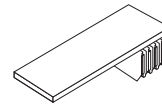

LATERAL PLAIN SHELF
WITH SUSPENSION RAIL

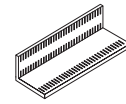

SLOTTED SHELF

FSCPLS0840***01	FSCULP0840BLS01	FSCFXS0840***01
FSCPLS1040***06	FSCULP1040BLS06	FSCFXS1040***04

1677mm High Tambour Storage Unit.

Available in 800mm or 1000mm wide.

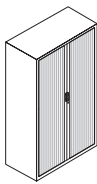

WIDTH



DEPTH



HEIGHT

FS167708***PL****	800mm	475mm	1677mm
FS167710***PL****	1000mm	475mm	1677mm

Accessories.

You may want to order these items.

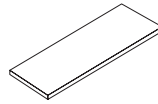

PLAIN SHELF

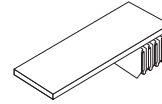

LATERAL PLAIN SHELF
WITH SUSPENSION RAIL

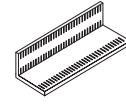

SLOTTED SHELF

FSCPLS0840***01	FSCULP0840BLS01	FSCFXS0840***01
FSCPLS1040***06	FSCULP1040BLS06	FSCFXS1040***04

1490mm High Tambour Storage Unit.

Available in 800mm or 1000mm wide.

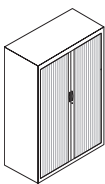

WIDTH



DEPTH



HEIGHT

FS149008***PL****	800mm	475mm	1490mm
FS149010***PL****	1000mm	475mm	1490mm

Accessories.

You may want to order these items.

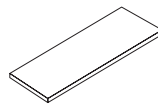

PLAIN SHELF

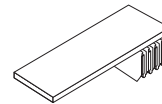

LATERAL PLAIN SHELF
WITH SUSPENSION RAIL

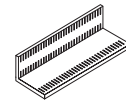

SLOTTED SHELF

FSCPLS0840***01	FSCULP0840BLS01	FSCFXS0840***01
FSCPLS1040***06	FSCULP1040BLS06	FSCFXS1040***04

1322mm High Tambour Storage Unit.

Available in 800mm or 1000mm wide.

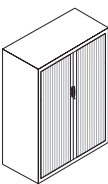

WIDTH



DEPTH



HEIGHT

FS132208***PL****	800mm	475mm	1322mm
FS132210***PL****	1000mm	475mm	1322mm

Accessories.

You may want to order these items.

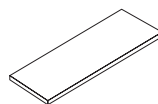

PLAIN SHELF

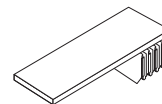

LATERAL PLAIN SHELF
WITH SUSPENSION RAIL

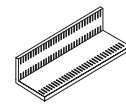

SLOTTED SHELF

FSCPLS0840***01	FSCULP0840BLS01	FSCFXS0840***01
FSCPLS1040***06	FSCULP1040BLS06	FSCFXS1040***04

1200mm High Tambour Storage Unit.

Available in 800mm or 1000mm wide.

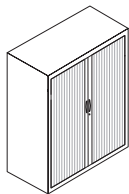

WIDTH



DEPTH



HEIGHT

FS120008***PL****
FS120010***PL****

800mm	475mm	1200mm
1000mm	475mm	1200mm

Accessories.

You may want to order these items.

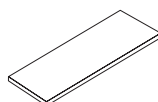

PLAIN SHELF

FSCPLS0840***01
FSCPLS1040***06

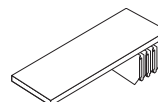

LATERAL PLAIN SHELF
WITH SUSPENSION RAIL

FSCULP0840BLS01
FSCULP1040BLS06

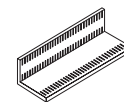

SLOTTED SHELF

FSCFXS0840***01
FSCFXS1040***04

1110mm High Tambour Storage Unit with MFC Top.

Available in 800mm, 825mm or 1000mm wide.

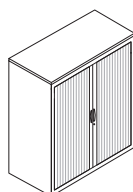

WIDTH



DEPTH



HEIGHT

FS111008***PL****
FS11100825***PL****
FS111010***PL****

800mm	475mm	1110mm
825mm	475mm	1110mm
1000mm	475mm	1110mm

Accessories.

You may want to order these items.

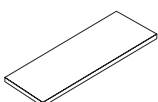

PLAIN SHELF

FSCPLS0840***01
FSCPLS082540***01
FSCPLS1040***01

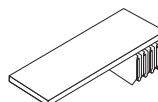

LATERAL PLAIN SHELF
WITH SUSPENSION RAIL

FSCULP0840BLS01
FSCULP082540BLS01
FSCULP1040BLS06

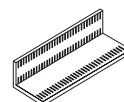

SLOTTED SHELF

FSCFXS0840***01
FSCFXS082540***01
FSCFXS1040***03

1090mm High Tambour Storage Unit with MFC Top.

Available in 800mm, 825mm or 1000mm wide.

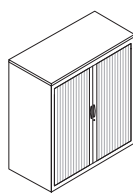

WIDTH



DEPTH



HEIGHT

FS109008***PL****
FS10900825***PL****
FS109010***PL****

800mm	475mm	1090mm
825mm	475mm	1090mm
1000mm	475mm	1090mm

Accessories.

You may want to order these items.

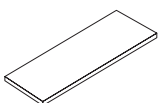

PLAIN SHELF

FSCPLS0840***01
FSCPLS082540***01
FSCPLS1040***01

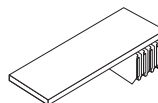

LATERAL PLAIN SHELF
WITH SUSPENSION RAIL

FSCULP0840BLS01
FSCULP082540BLS01
FSCULP1040BLS06

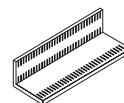

SLOTTED SHELF

FSCFXS0840***01
FSCFXS082540***01
FSCFXS1040***03

1017mm High Tambour Storage Unit.

Available in 800mm or 1000mm wide.

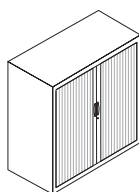

WIDTH



DEPTH



HEIGHT

FS101708***PL****
FS101710***PL****

800mm	475mm	1017mm
1000mm	475mm	1017mm

Accessories.

You may want to order these items.

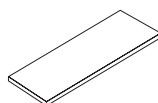

PLAIN SHELF

FSCPLS0840***01
FSCPLS1040***06

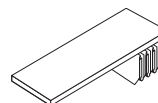

LATERAL PLAIN SHELF
WITH SUSPENSION RAIL

FSCULP0840BLS01
FSCULP1040BLS06

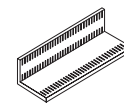

SLOTTED SHELF

FSCFXS0840***01
FSCFXS1040***04

740mm High Tambour Storage Unit with MFC Top.

Available in 800mm, 825mm or 1000mm wide.

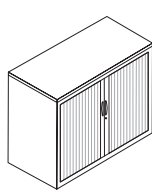

WIDTH



DEPTH



HEIGHT

FS074008***PL****
FS07400825***PL****
FS074010***PL****

800mm	475mm	740mm
825mm	475mm	740mm
1000mm	475mm	740mm

Accessories.

You may want to order these items.

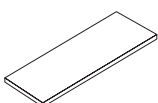

PLAIN SHELF

FSCPLS0840***01
FSCPLS082540***01
FSCPLS1040***01

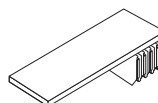

LATERAL PLAIN SHELF
WITH SUSPENSION RAIL

FSCULP0840BLS01
FSCULP082540BLS01
FSCULP1040BLS06

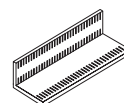

SLOTTED SHELF

FSCFXS0840***01
FSCFXS082540***01
FSCFXS1040***03

720mm High Tambour Storage Unit with MFC Top.

Available in 800mm, 825mm or 1000mm wide.

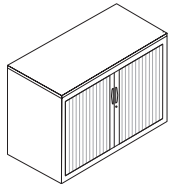

WIDTH



DEPTH



HEIGHT

FS072008***PL****	800mm	475mm	720mm
FS07200825***PL****	825mm	475mm	720mm
FS072010***PL****	1000mm	475mm	720mm

Accessories.

You may want to order these items.

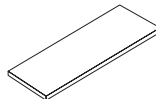

PLAIN SHELF

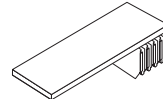

LATERAL PLAIN SHELF WITH SUSPENSION RAIL

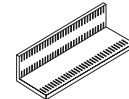

SLOTTED SHELF

FSCPLS0840***01	FSCULP0840BLS01	FSCFXS0840***01
FSCPLS082540***01	FSCULP082540BLS01	FSCFXS082540***01
FSCPLS1040***01	FSCULP1040BLS06	FSCFXS1040***03

715mm High Tambour Storage Unit.

Suitable for customers own tops.

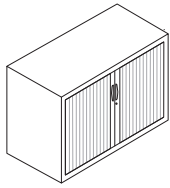

WIDTH



DEPTH



HEIGHT

FS071508***PL**000	800mm	475mm	715mm
FS071510***PL**000	1000mm	475mm	715mm

Accessories.

You may want to order these items.

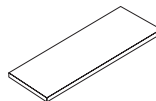

PLAIN SHELF

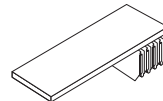

LATERAL PLAIN SHELF WITH SUSPENSION RAIL

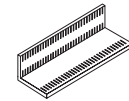

SLOTTED SHELF

FSCPLS0840***01	FSCULP0840BLS01	FSCFXS0840***01
FSCPLS1040***06	FSCULP1040BLS06	FSCFXS1040***04

695mm High Tambour Storage Unit.

Suitable for customers own tops.

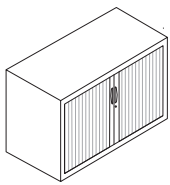

WIDTH



DEPTH



HEIGHT

FS069508***PL**000	800mm	475mm	695mm
FS069510***PL**000	1000mm	475mm	695mm

Accessories.

You may want to order these items.

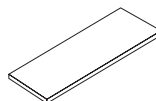

PLAIN SHELF

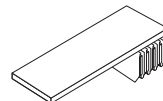

LATERAL PLAIN SHELF WITH SUSPENSION RAIL

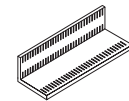

SLOTTED SHELF

FSCPLS0840***01	FSCULP0840BLS01	FSCFXS0840***01
FSCPLS1040***06	FSCULP1040BLS06	FSCFXS1040***04

/tambour coat storage

2007mm High Tambour Coat Storage Unit.

Ventilated back. Comes with 1 fitted adjustable shelf. Order hangers separately (5 or 10 pack).

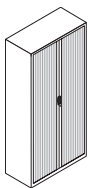

WIDTH



DEPTH



HEIGHT

FSROBE08 *** PL ** **	800mm	600mm	2007mm
FSROBE10 *** PL ** **	1000mm	600mm	2007mm

Hangers

HANGERPACK05	N/A	N/A	N/A
HANGERPACK10	N/A	N/A	N/A

freestor acoustic tambour storage



Pictured Right: tambour storage.
1000mm (w) x 475mm (d) x 1322mm (h).
Finishes: white steel with creamy white shutters.
FS132210JWSASCWJWS.

HOW TO SPECIFY TAMBOUR STORAGE

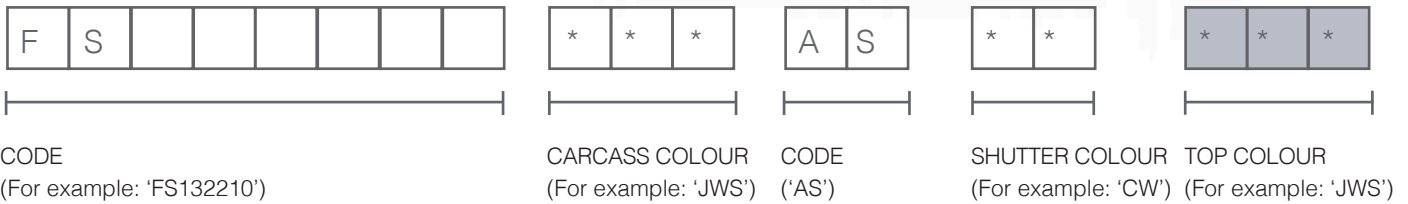

For example, to specify an all white 1000mm (w) x 475mm (d) x 1322mm (h) tambour storage unit (pictured above) the code would be FS132210JWSASCWJWS. When ordering a tambour unit please consider various components.

IMPORTANT NOTE: Tambour Storage is all steel with a MFC top as an option. If a steel top is required enter the desired steel colour in the *** section labelled 'Top Colour'. If an MFC top is required enter in an MFC colour. MFC tops incur an additional cost.

**Please note, Freestor Acoustic Tambours have a minimum order quantity of 5.
The 5 units are required to be the same height, width and colour tambour shutters.**

Steel Finishes

Silver	JOS	Waterblue	WBS
Graphite	GGG	Sky Blue	SBB
Pale Grey	PGS	Regal Blue	RBS
White	JWS	Signal Blue	SBS
Black	BLS	Ultramarine Blue	UBS
Arrow Red	ARG	Tauben Blue	TGS
Carmin Red	CRS	Pastel Turquoise	PTS
Deep Orange	ORS	Pastel Mauve	PMS
Zinc Yellow	ZYS	Khaki Green	KGS
Fern Green	FGB		

MFC Finishes/ Matching Edge

Light Oak	MOK
White	WHM
Beech	MOB
Maple	MOM
Grey	MOG
Walnut	MOW
Romano Cherry	RCM

Tambour Shutter Finishes

Silver	SL
Creamy White	CW

MFC Finishes/ Contrasting Edge

White/ Oak Edge	WHO
White/ Multiplex Edge	WHX

freestor storage /acoustic tambour storage

2007mm High Tambour Storage.

Available in 800mm or 1000mm wide.

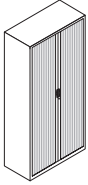

WIDTH



DEPTH



HEIGHT

FS200708*** AS *****
FS200710*** AS *****

800mm	475mm	2007mm
1000mm	475mm	2007mm

Accessories.

You may want to order these items.

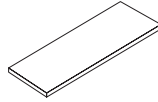

PLAIN SHELF

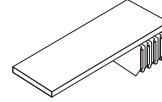

LATERAL PLAIN SHELF
WITH SUSPENSION RAIL

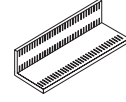

SLOTTED SHELF

FSCPLS0840***01
FSCPLS1040***06

FSCULP0840BLS01
FSCULP1040BLS06

FSCFXS0840***01
FSCFXS1040***04

1322mm High Tambour Storage.

Available in 800mm or 1000mm wide.

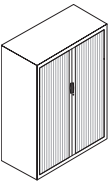

WIDTH



DEPTH



HEIGHT

FS132208*** AS *****
FS132210*** AS *****

800mm	475mm	1322mm
1000mm	475mm	1322mm

Accessories.

You may want to order these items.

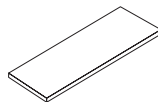

PLAIN SHELF

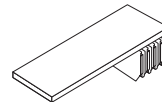

LATERAL PLAIN SHELF
WITH SUSPENSION RAIL

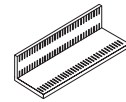

SLOTTED SHELF

FSCPLS0840***01
FSCPLS1040***06

FSCULP0840BLS01
FSCULP1040BLS06

FSCFXS0840***01
FSCFXS1040***04

1200mm High Tambour Storage Unit.

Available in 800mm or 1000mm wide.

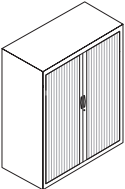

WIDTH



DEPTH



HEIGHT

FS120008*** AS *****
FS120010*** AS *****

800mm	475mm	1200mm
1000mm	475mm	1200mm

Accessories.

You may want to order these items.

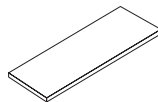

PLAIN SHELF

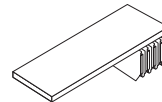

LATERAL PLAIN SHELF
WITH SUSPENSION RAIL

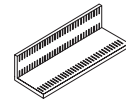

SLOTTED SHELF

FSCPLS0840***01
FSCPLS1040***06

FSCULP0840BLS01
FSCULP1040BLS06

FSCFXS0840***01
FSCFXS1040***04

1110mm High Tambour Storage Unit with MFC Top.

Available in 800mm, 825mm or 1000mm wide.

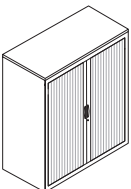

WIDTH



DEPTH



HEIGHT

FS111008*** AS *****
FS11100825*** AS *****
FS111010*** AS *****

800mm	475mm	1110mm
825mm	475mm	1110mm
1000mm	475mm	1110mm

Accessories.

You may want to order these items.

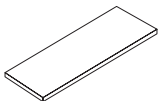

PLAIN SHELF

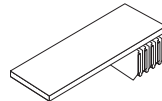

LATERAL PLAIN SHELF
WITH SUSPENSION RAIL

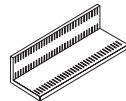

SLOTTED SHELF

FSCPLS0840***01
FSCPLS082540***01
FSCPLS1040***01

FSCULP0840BLS01
FSCULP082540BLS01
FSCULP1040BLS06

FSCFXS0840***01
FSCFXS082540***01
FSCFXS1040***03

freestor accent lockers



Pictured Right: 8 door locker with bottom drawers, post slots, soft close hinges and cam lock with silver plate.
800mm (w) x 475mm (d) x 1742mm (h)
Finishes: pale grey silver. LKR4CDEHPGSPGS

HOW TO SPECIFY ACCENT LOCKERS

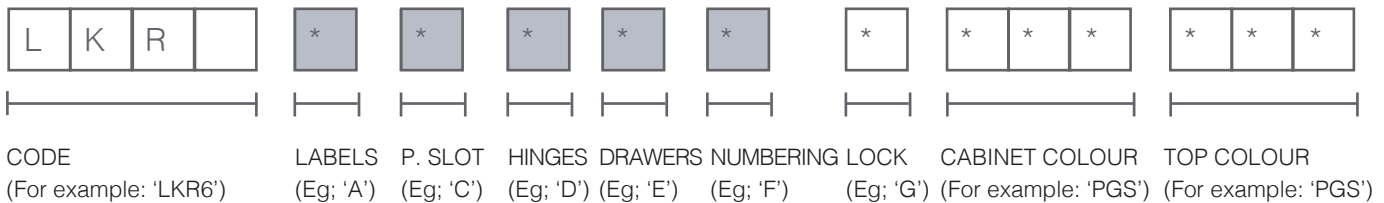

For example, to specify an 8 door locker with bottom drawers, post slots, soft close hinges and cam lock with silver plate. Locker: 800mm (w) x 475mm (d) x 1742mm (h) pictured above, the code would be LKR4CDEHPGSPGS. This range is designed to provide a flexible way of specifying lockers exactly how you want them. If no additional elements are required, move on to the next option. For example, if no labels are required, do not enter 'A' or 'B'; and move on to option 'C'. All interior shelves, trays, number plates are ordered separately. Some locks may need additional items such as cards and software.

If an MFC top is specified on units 1-6, add 10mm to the overall height.

IMPORTANT NOTE: Locker Storage is all steel and can come with a MFC top. If a steel top is required select the desired steel colour in the *** section labeled 'Top Colour'. If an MFC top is required select a MFC colour. MFC tops incur an additional cost.

Steel Finishes

Silver	JOS	Waterblue	WBS
Graphite	GGG	Sky Blue	SBB
Pale Grey	PGS	Regal Blue	RBS
White	JWS	Signal Blue	SBS
Black	BLS	Ultramarine Blue	UBS
Arrow Red	ARG	Tauben Blue	TGS
Carmin Red	CRS	Pastel Turquoise	PTS
Deep Orange	ORS	Pastel Mauve	PMS
Zinc Yellow	ZYS	Khaki Green	KGS
Fern Green	FGB		

MFC Finishes/ Matching Edge

Light Oak	MOK
White	WHM
Beech	MOB
Maple	MOM
Grey	MOG
Walnut	MOW
Romano Cherry	RCM

MFC Finishes/ Contrasting Edge

White/ Oak Edge	WHO
White/ Multiplex Edge	WHX

freestor storage /accent lockers

2150mm High Locker Storage.

10 individual lockers. Opening aperture width with the clearance between hinge knuckle and door stop.

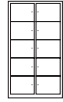
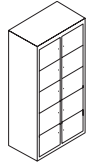

WIDTH



OPENING APERTURE



INTERNAL WIDTH



DEPTH



INTERNAL DEPTH

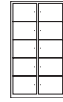

HEIGHT

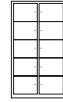

INTERNAL HEIGHT

LKR2 *****

800mm

300mm

356mm

475mm

450mm

2150mm

380mm

LKR1 *****

1000mm

400mm

456mm

475mm

450mm

2150mm

380mm

Lock.

You must order a type of lock. G-N



LOCK

G - N

G - N

1742mm High Locker Storage.

8 individual lockers. Opening aperture width with the clearance between hinge knuckle and door stop.

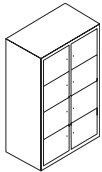

WIDTH



OPENING APERTURE



INTERNAL WIDTH



DEPTH



INTERNAL DEPTH



HEIGHT



INTERNAL HEIGHT

LKR4 *****

800mm

300mm

356mm

475mm

450mm

1742mm

380mm

LKR3 *****

1000mm

400mm

456mm

475mm

450mm

1742mm

380mm

Lock.

You must order a type of lock. G-N



LOCK

G - N

G - N

1332mm High Locker Storage.

6 individual lockers. Opening aperture width with the clearance between hinge knuckle and door stop.

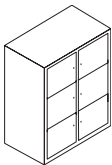

WIDTH



OPENING APERTURE



INTERNAL WIDTH



DEPTH



INTERNAL DEPTH



HEIGHT



INTERNAL HEIGHT

LKR6 *****

800mm

300mm

356mm

475mm

450mm

1332mm

380mm

LKR5 *****

1000mm

400mm

456mm

475mm

450mm

1332mm

380mm

Lock.

You must order a type of lock. G-N



LOCK

G - N

G - N

1110mm High Locker Storage.

6 individual lockers. Opening aperture width with the clearance between hinge knuckle and door stop.

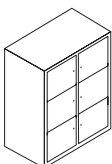

WIDTH



OPENING APERTURE



INTERNAL WIDTH



DEPTH



INTERNAL DEPTH



HEIGHT



INTERNAL HEIGHT

LKR8 *****

800mm

300mm

356mm

475mm

450mm

1110mm

302mm

LKR7 *****

825mm

312mm

368mm

475mm

450mm

1110mm

302mm

Lock.

You must order a type of lock. G-N



LOCK

G - N

G - N

/locker options

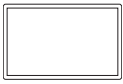

A
SMALL LABEL HOLDER
Black. In stock. Card insert.
Size: 29mm x 50mm. Self adhesive (factory fitted).

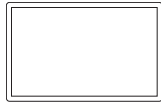

B
LARGE LABEL HOLDER
Black. In stock. Card insert.
Size: 55mm x 90mm. Self adhesive (factory fitted).

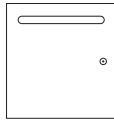

C
POST SLOT
25mm (h). 245mm or 305mm wide depending upon unit. Doors Only.

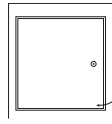

D
SOFT CLOSE HINGE
Closes softer reducing noise. Better for office environments.

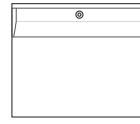

E
LOCKING BOTTOM DRAWER
Replaces bottom lockers with drawers. Key lock. Available on LKR1-6 lockers. 288 (h) x 400mm (d) x various widths.



F
COMPARTMENT No.
Order number plates separately via SPB. 30mm holes only.



G
CAM LOCK
Standard 90 degree cam lock. Supplied with 2 keys. In stock.



H
CAM LOCK + NAME PLATE
Cam lock (left) plus silver name plate. Card insert size 35mm x 50mm

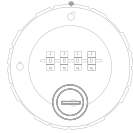

I
ECO COMBINATION
Available to existing clients only. Key + £1 each. COMBISETKEY. Override key ZHWLOCK133

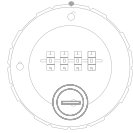

J
SUPERIOR COMBINATION
Available to existing clients only. Check availability. Master key ZHWLOCK120

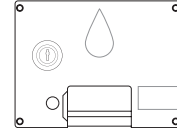

K
COIN-OP RETURN
Available right (07410-01) or left handed (07410-02). Accepts £1 or 1€. Master key inc., 700+ options. Unsuitable for wet areas.

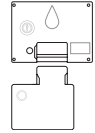

L
COIN-OP DEPOSIT
Coin op return (as left) + lockable metal cash deposit box.

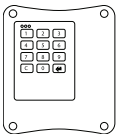

REQUEST SPT
RONIS TRONIC EVOLUTION
Access via 4-digit code. Code erased after lock opened for new user. 4x AA batteries (30,000 cycles). To supply programme keys to operate locks, each site needs to be recorded with each order placed. Battery pack. Ronis Battery packs code: ZHWMISCBAT01



REQUEST SPT
RONIS RFID MIFARE
RFID Classic Mifare 1K/4K (ISO1443A/B). Integrability with Mifare Desfire. Mod multi user/ single user. Dry or wet applications. Price per card management card, software. Training not included. Battery pack.

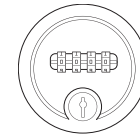

P
C4 BLACK COMBINATION LOCK
From stock. Master key ZHWLOCK142

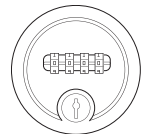

Q
C4 WHITE COMBINATION LOCK
From stock. Master key ZHWLOCK142

/accessories

Adjustable Shelves.

2 pack.

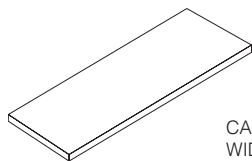

CARCASS
WIDTH

LKR800SHELF02 ***	800mm
LKR825SHELF02 ***	825mm
LKR1000SHELF02 ***	1000mm

Removable Tray.

Brackets included.

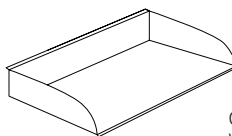

CARCASS
WIDTH

LKR800TRAY02 ***	800mm
LKR825TRAY02 ***	825mm
LKR1000TRAY02 ***	1000mm

/hotboxes

Not suitable for lockers with shelves or trays in.

Core Box with 2 Utility Pots.

Not suitable for lockers 7 & 8. White.

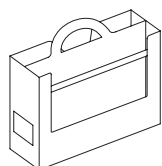

COLOUR

HB2U

White

Smart Box.

Suitable for foolscap files.

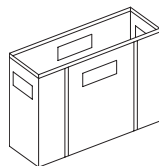

COLOUR

VC00100/OPAL

Opal

Strap (02) / Lid (04)

VC00102/BLACK

Black

VC00104/BLACK

Black

Core Box with 2 Utility Pots & Bib.

Various Colours.

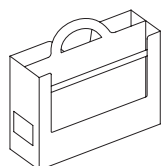

COLOUR

HB2R/B1

Winchester Grey

HB2R/B2

Newport Green

HB2R/B3

Manchester Blue

HB2R/B4

Goldsmith Red

HB2R/B5

Surrey Grey

HB2R/B6

Tangled Silverdale

Accessories.

Shoulder straps, tablet clips and straps.

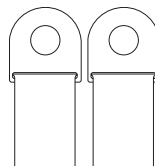

COLOUR

Shoulder Strap

HB2ST/B

Black

HB2ST/G

grey

Tablet Clip / Stand

HB2TC/W

White

HB2TC/G

Grey

Tablet Strap

HB2TS/G

Grey

FREESTOR COMPONENTS

Each Freestor hinged door has a selection of compatible components which help organise your office filing/ storage and equipment. Components can be mixed and matched to increase flexibility. Use the guides to the right to work

out which selection of components fit in your chosen storage. For advice or a full filing assessment, please call our expert survey analysts on 01274 706206.

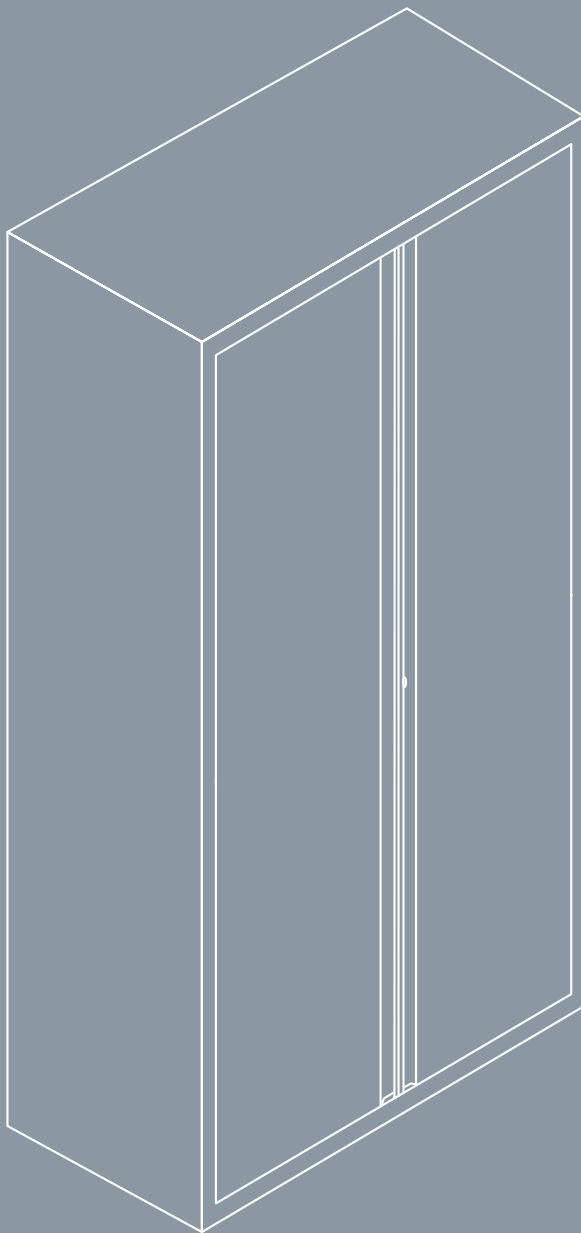

STEP BY STEP GUIDE TO WORKING OUT THE CORRECT COMPONENTS.

1. Use the internal height measurement guide to get the internal height of the chosen hinged door storage unit.
2. Using either mms or 1 inch slots as a measurement and the component guide, calculate which combination of components can fit in the storage.
3. Repeat with any additional storage unit.
4. Order the correct components and accessories if desired. Each component's width needs to match the width of the chosen hinged door unit.

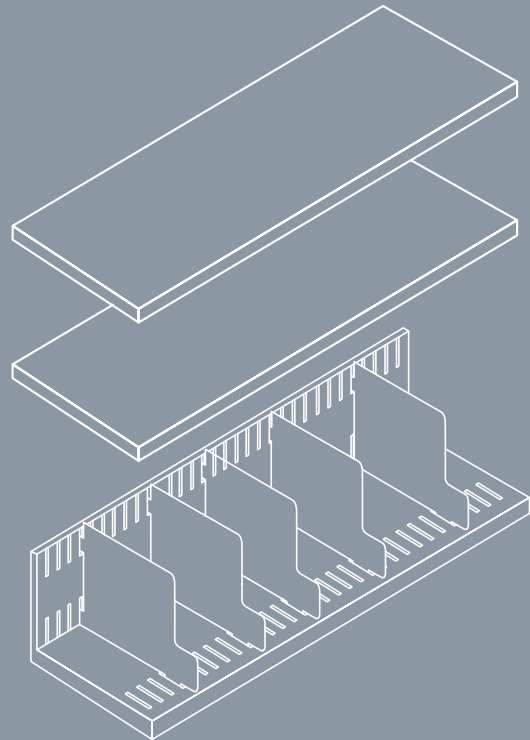

EXAMPLE

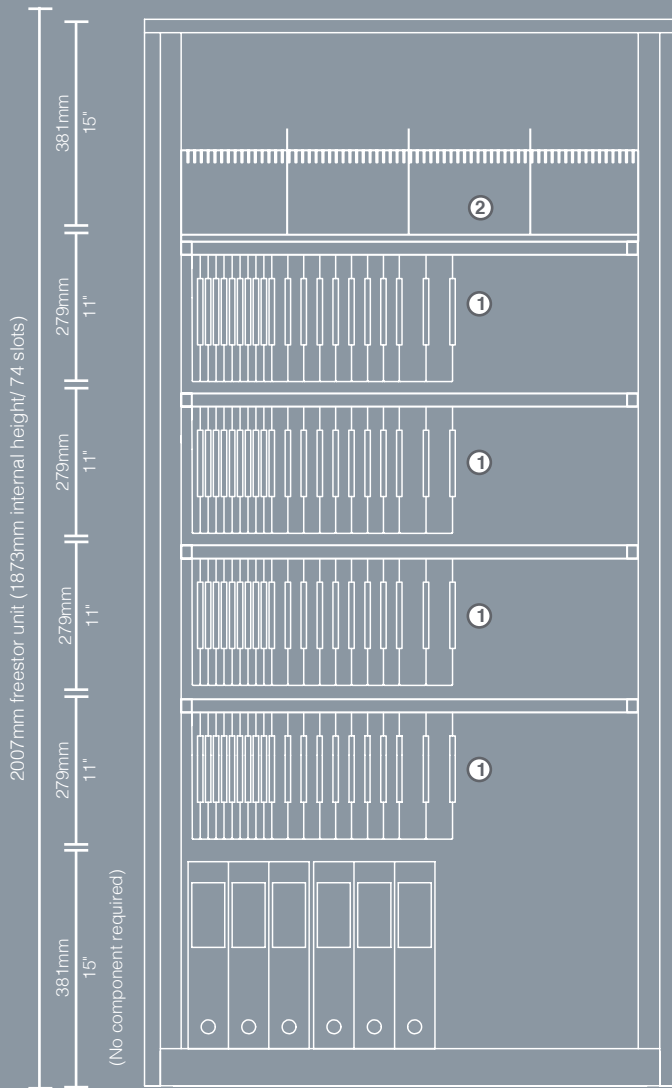

STORAGE EXAMPLE:

Storage chosen: 2007mm (h) x 1000mm (w) hinged door storage -

74" slots.

Components chosen:

1. Lateral rail for AZV mixed files - 11" slots.
2. Slotted shelf - 15" slots.

These components together fit into the 2007mm/ 74" storage.

TIPS

The bottom of the storage unit can be used as a shelf if desired. If used remember to leave adequate space before inserting the next component. Any surplus internal space can be distributed throughout the unit.

INTERNAL HEIGHTS

FREESTOR UNIT	2007mm	1720mm	1677mm	1490mm	1322mm	1200mm	1110mm	1090mm	1017mm	740mm 720mm	715mm 695mm
HINGED DOOR	1873mm or 74"	-	1543mm or 60"	-	1181mm or 46"	-	-	960mm or 37"	883mm or 35"	578mm or 22"	-
TAMBOUR STORAGE	1882mm or 74"	1595mm or 63"	1532mm or 61"	1365mm or 54"	1197mm or 47"	1075mm or 42"	975mm or 38"	955mm or 37.5"	882mm or 35"	605mm or 24"	605mm or 24"

Please note side filers and flippers are fixed height, only 1 component can fit in 1 drawer or flipper at one time.

Lateral components

(For hinged door storage, combination storage and side filers)

Plain Shelf for Lateral Units.

Available as a single (01) or pack of 6 (06).



	WIDTH	FILING WIDTH	DEPTH	HEIGHT
FSLCPLS0840BLS01	800mm	748mm	405mm	13mm
FSLCPLS082540BLS01	825mm	773mm	405mm	13mm
FSLCPLS1040BLS01	1000mm	948mm	405mm	13mm
FSLCPLS0840BLS06	800mm	748mm	405mm	13mm
FSLCPLS1040BLS06	1000mm	948mm	405mm	13mm

Slotted Filing Shelf for Lateral Units. (QTY: 01/04)

Available as a single (01) or pack of 4 (04).

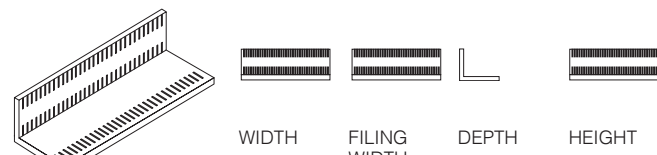

	WIDTH	FILING WIDTH	DEPTH	HEIGHT
FSLCFXS0840BLS01	800mm	748mm	405mm	172mm
FSLCFXS082540BLS01	825mm	773mm	405mm	172mm
FSLCFXS1040BLS01	1000mm	948mm	405mm	172mm
FSLCFXS0840BLS04	800mm	748mm	405mm	172mm
FSLCFXS1040BLS04	1000mm	948mm	405mm	172mm

Accessories.

You may want to order this item.

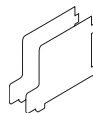

SHELF DIVIDERS

- FSCDIV1508BLS05
- FSCDIV1508BLS05
- FSCDIV1508BLS05
- FSCDIV1508BLS05
- FSCDIV1508BLS05

Lateral Plain Shelf with Integral Suspension Rail for Lateral Units.

Available as a single (01) or pack of 4 (04). Fixed position.

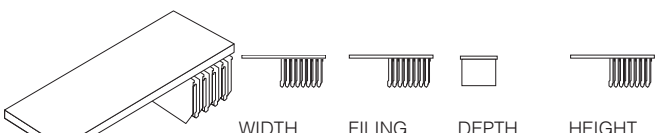

	WIDTH	FILING WIDTH	DEPTH	HEIGHT
FSLCULP0840BLS01	800mm	748mm	25mm	23mm
FSLCULP082540BLS01	825mm	773mm	25mm	23mm
FSLCULP1040BLS01	1000mm	948mm	25mm	23mm
FSLCULP0840BLS04	800mm	748mm	25mm	23mm
FSLCULP1040BLS04	1000mm	948mm	25mm	23mm

Lateral Suspended Filing Rails for Lateral Units.

Available as a single (01) or pack of 6 (06).

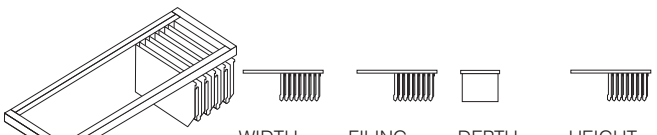

	WIDTH	FILING WIDTH	DEPTH	HEIGHT
FSLCULR08RLBLS01	800mm	748mm	25mm	23mm
FSLCULR10RLBLS01	1000mm	948mm	25mm	23mm
FSLCULR08RLBLS06	800mm	748mm	25mm	23mm
FSLCULR10RLBLS06	1000mm	948mm	25mm	23mm

Side-to-Side Filing Rails for Drawers/ Lateral Units.

Available as a single (01) and a pack of 3 (03).

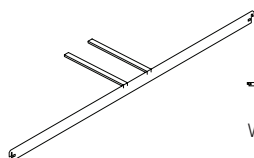

	WIDTH	FILING WIDTH / ROW	DEPTH
FSLATFFS08SSBLS01	800mm	748mm	N/a
FSLATFFS10SSBLS01	1000mm	948mm	N/a
FSLATFFS08SSBLS03	800mm	748mm	N/a
FSLATFFS10SSBLS03	1000mm	948mm	N/a

Front-to-Back Filing Rails for Drawers/ Lateral Units.

Available as a single (01) and a pack of 3 (03).

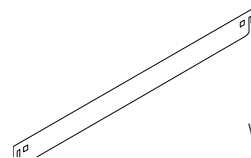

	WIDTH	FILING WIDTH / ROW	DEPTH
FSLATFFS08FBLS01	800mm	385mm x 2	N/a
FSLATFFS10FBLS01	1000mm	385mm x 2	N/a
FSLATFFS08FBLS03	800mm	385mm x 2	N/a
FSLATFFS10FBLS03	1000mm	385mm x 2	N/a

Coat Shelf for Lateral Units.

Compatible with hinged door storage.

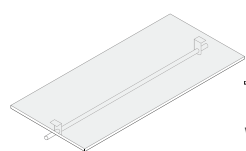

	WIDTH	DEPTH	HEIGHT
FSLCCS0840***01	800mm	25mm	23mm
FSLCCS1040***01	1000mm	25mm	23mm

MFC Tops for Lateral Units.

Included on all 720mm and 740mm storage unless specified.

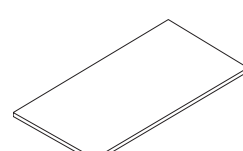

	WIDTH	DEPTH	HEIGHT
FSTOP0805***01	800mm	475mm	25mm
FSTOP1005***01	1000mm	475mm	25mm

/tambour components

Plain Shelf for Tambours.

Available as a single (01) or pack of 6 (06).

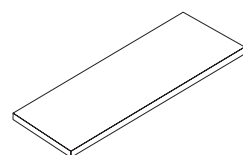

	WIDTH	FILING WIDTH	DEPTH	HEIGHT
FSCPLS0840***01	800mm	657mm	405mm	13mm
FSCPLS082540***01	825mm	773mm	405mm	13mm
FSCPLS1040***01	1000mm	857mm	405mm	13mm
FSCPLS0840***06	800mm	657mm	405mm	13mm
FSCPLS1040***06	1000mm	857mm	405mm	13mm

Slotted Filing Shelf for Tambours. (QTY: 01/04)

Available as a single (01) or pack of 4 (04). To order dividers use code FSCDIV1508BLS05

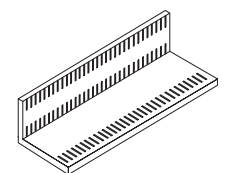

	WIDTH	FILING WIDTH	DEPTH	HEIGHT
FSCFXS0840***01	800mm	657mm	405mm	172mm
FSCFXS082540***01	825mm	773mm	405mm	172mm
FSCFXS1040BLS01	1000mm	857mm	405mm	172mm
FSCFXS0840BLS04	800mm	657mm	405mm	172mm
FSCFXS1040BLS04	1000mm	857mm	405mm	172mm

Accessories.

You may want to order this item.

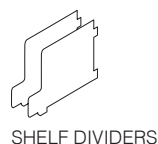

- FSCDIV1508BLS05
- FSCDIV1508BLS05
- FSCDIV1508BLS05
- FSCDIV1508BLS05
- FSCDIV1508BLS05

Pull Out File Frame with 2 AR Rails for Tambours. (QTY: 01/02)

Includes anti tilt bars at 10.5" centres. Available as a single (01) or pack of 2 (02).
For filing Front-to-Back, the filing width is 385mm per row, 2 rows. (385mm x 2).

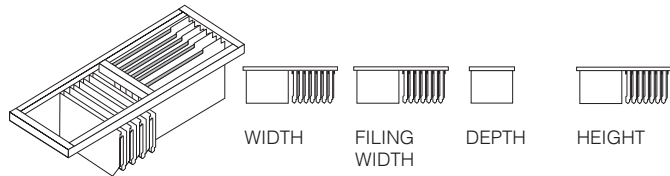

	WIDTH	FILING WIDTH	DEPTH	HEIGHT
FSCUPF08AR***01	800mm	620mm	405mm	42mm
FSCUPF10AR***01	1000mm	820mm	405mm	42mm

Lateral Plain Shelf with Integral Suspension Rail for Tambours.

Available as a single (01) or pack of 4 (04). Fixed position.
To order files use code AZV

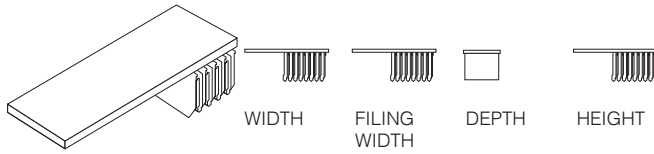

	WIDTH	FILING WIDTH	DEPTH	HEIGHT
FSCULP0840BLS01	800mm	657mm	25mm	23mm
FSCULP082540BLS01	825mm	773mm	25mm	23mm
FSCULP1040BLS01	1000mm	857mm	25mm	23mm
FSCULP0840BLS04	800mm	657mm	25mm	23mm
FSCULP1040BLS04	1000mm	857mm	25mm	23mm

Lateral Suspended Filing Rails for Tambours.

Available as a single (01) or pack of 6 (06) .

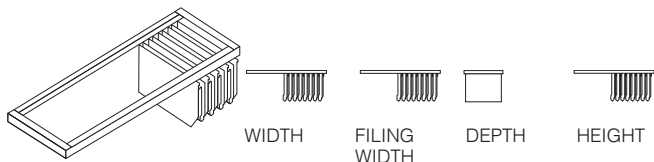

	WIDTH	FILING WIDTH	DEPTH	HEIGHT
FSCULR08RLBLS01	800mm	657mm	25mm	23mm
FSCULR10RLBLS01	1000mm	857mm	25mm	23mm
FSCULR08RLBLS06	800mm	657mm	25mm	23mm
FSCULR10RLBLS06	1000mm	857mm	25mm	23mm

System Drawer (Single) for Tambours. ONLY 1 PER UNIT

Compatible with tambour storage. Divider: FSCSDD4009***05

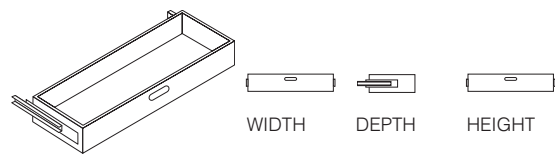

	WIDTH	DEPTH	HEIGHT
FSCSYD0840***01	800mm	410mm	100mm
FSCSYD1040***01	1000mm	410mm	100mm

System Drawer Dividers. (QTY: 5)

Divides up the drawer creating compartments.

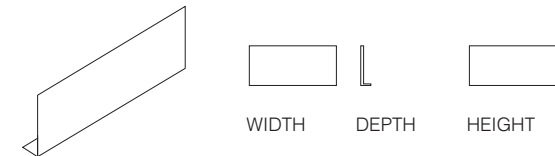

	WIDTH	DEPTH	HEIGHT
FSCSDD4009***05	95mm	5mm	408mm

System Drawer at 11" Centres with Anti-tilt for Tambours. 2+ /UNIT

Compatible with tambour storage. Includes anti tilt bars.
Suitable for dental record cards. Divider: FSCSDD4009***05

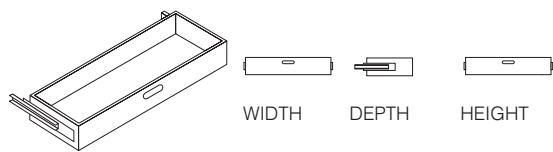

	WIDTH	DEPTH	HEIGHT
FSCSYD084011***01	800mm	410mm	100mm
FSCSYD104011***01	1000mm	410mm	100mm

System Drawer at 8" Centres with Anti-tilt for Tambours. 2+ /UNIT

Compatible with tambour storage. Includes anti tilt bars.
Suitable for medical record cards. Divider: FSCSDD4009***05

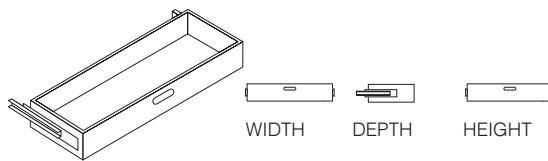

	WIDTH	DEPTH	HEIGHT
FSCSYD084008***01	800mm	410mm	100mm
FSCSYD104008***01	1000mm	410mm	100mm

Pull Out Shelf for Tambours.

Compatible with tambour storage.

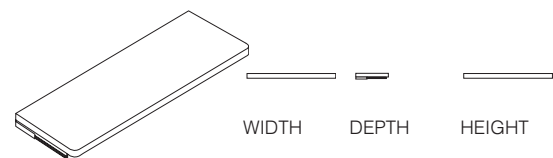

	WIDTH	DEPTH	HEIGHT
FSCPORS0840***01	800mm	405mm	16mm
FSCPORS1040***01	1000mm	405mm	16mm

Long Rail to create Side-to-Side A4 Suspended Filing on UPF for Tambours.

Filing width 620mm (800mm) and 820mm (1000mm).

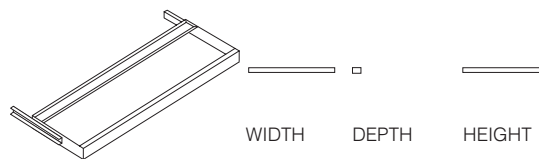

	WIDTH	DEPTH	HEIGHT
FSCFLOR08***01	800mm	70mm	12mm
FSCFLOR10***01	1000mm	70mm	12mm

MFC Tops for Tambour Units.

Included on all 720mm and 740mm storage unless specified.

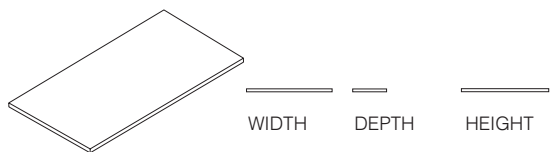

	WIDTH	DEPTH	HEIGHT
FSCTOP0805***01	800mm	475mm	25mm
FSCTOP1005***01	1000mm	475mm	25mm

Coat Shelf for Tambours.

Compatible with tambour units.



	WIDTH	DEPTH	HEIGHT
FSCCS0840***01	800mm	25mm	23mm
FSCCS1040***01	1000mm	25mm	23mm

/accessories

Counterbalance Weights.

Recommended if Freestor lateral unit contain 1 or more drawers.

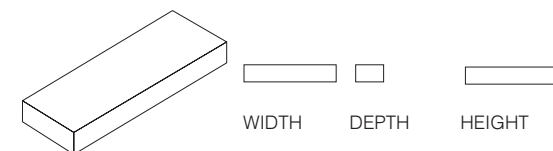

	WIDTH	DEPTH	HEIGHT
FSTORBAL08	800mm	N/a	N/a
FSTORBAL10	1000mm	N/a	N/a

Sloping Tops for all Freestor units.

Suitable to be retro-fitted on site, sits on top of existing steel top.
Factory fitted slope tops require an SPT

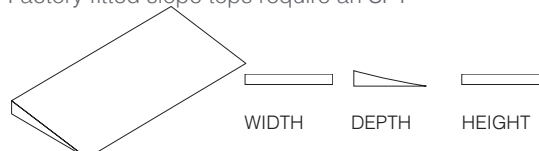

	WIDTH	DEPTH	HEIGHT
FSUNISLOPE800***	800mm	475mm	150mm
FSUNISLOPE825***	825mm	475mm	150mm
FSUNISLOPE1000***	1000mm	475mm	150mm

Shelf Dividers. (QTY: 05/15)

For use with slotted shelves.

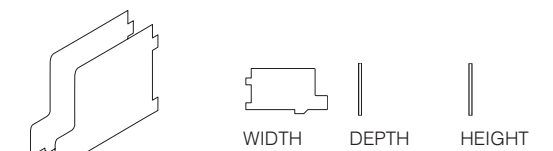

	WIDTH	DEPTH	HEIGHT
FSCDIV1508***05	5mm	380mm	200mm
FSCDIV1508***15	5mm	380mm	200mm

Pigeon Holes. (Need to order slotted shelf and FSCDIV1508BLS)

Order 3 per 800mm shelf with 4 dividers, 4 per 1000mm shelf with 5 dividers. For Tambours order 2 per 800mm shelf with 3 dividers and 3 per 1000mm with 4 dividers.

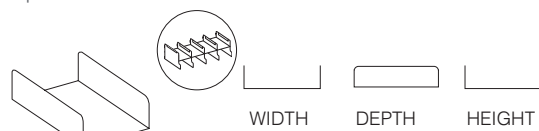

	WIDTH	DEPTH	HEIGHT
SCFPHUA4FLBLS04	226mm	330mm	100mm



CYBER
ESSENTIALS

YORKSHIRE HQ

Flexiform
1392 Leeds Road
Bradford
West Yorkshire
BD3 7AE

t: 01274 706206

LONDON

Flexiform
1st Floor
45 Gee Street
London
EC1V 3RS

t: 02033 010436

SCOTLAND

Flexiform
2B Young Square
Brucefield Industry Park
Bellsquarry, Livingston
EH54 9BX

t: 01506 416410

Find us online:



flexiform

www.flexiform.co.uk